

**FED. STD. NO. 751a**

January 25, 1965

---

**SUPERSEDING**

Fed. Std. No. 751

August 14, 1959

**FEDERAL STANDARD**

**STITCHES, SEAMS, AND STITCHINGS**

*This standard was approved by the Commissioner, Federal Supply Service, General Services Administration, for the use of all Federal agencies*

---

**Additional copies of this standard may be purchased for \$1.25 each, from General Services Administration, Business Service Center, Washington, D.C., 20407.**

**INFORMATION SHEET  
ON  
FEDERAL STANDARDS**

This Federal Standard is issued in loose leaf form to permit the insertion or removal of new or revised pages.

All users of Federal Standards should keep them up to date by inserting revised or new pages as issued and removing superseded and canceled pages.

New and revised pages will be issued under Change Notices which will be numbered consecutively and will bear the date of issuance. Change Notices should be retained and filed in front of the Standard until such time as they are superseded by a reissue of the entire Standard.

2

# FEDERAL STANDARD

## STITCHES, SEAMS, AND STITCHINGS

*Authority. This standard is issued pursuant to the Federal Property and Administrative Services Act of 1949, as amended, and its application to the commodities referred to herein is mandatory on all Federal agencies.*

### PART I. GENERAL INFORMATION

#### Section 1. Scope, Contents, and Classification

**1.1 Scope.** This standard establishes, defines, and illustrates the requirements for the types of stitches, seams, and stitching formations specified in Government specifications for the fabrication of sewn items.

#### 1.2 Contents.

##### PART I—GENERAL INFORMATION

Section 1—Scope, Contents, Classification, and Notes.

Section 2—Index of Seams, Stitches, and Stitchings.

Section 2A—Schematic Index of Seams and Stitchings in Alphabetical Order by Class.

Section 3—Characteristics of Seams and Stitchings.

Section 4—Guide for the Use of Stitches, Seams, and Stitchings.

##### PART II—REQUIREMENTS

Section 1—Stitches.

Section 2—Seams.

Section 3—Stitchings.

**1.3 Classification.** The stitches, seams, and stitchings are classified as follows:

**1.3.1 Stitch.** A stitch is one unit of conformation of thread resulting from repeatedly passing a strand or strands and/or a loop or loops of thread into or through a material at uniformly spaced intervals to form a series of stitches. Stitches are divided into six classes:

##### *Stitch classes*

100—Chain stitch.

200—Hand stitch.

300—Lock stitch.

400—Multithread chain stitch (or “double locked stitch”).

500—Overedge stitch.

600—Flat seam stitch.

700—Single thread lockstitch.

**1.3.2 Seam.** A seam is a joint consisting of a sequence of stitches uniting two or more pieces of materials and is used for assembling parts in the production of sewn items. Seams are divided into four classes:

##### *Seam classes*

SS—Superimposed.

LS—Lapped.

BS—Bound.

FS—Flat.

**1.3.3 Stitching.** Stitching consists of a sequence of stitches for finishing an edge or for ornamental purposes or both in preparing parts for assembling. Stitchings are divided into two classes:

##### *Stitching classes*

OS—Ornamental.

EF—Edge finishing.

#### 1.4 Notes.

**Changes.** When a Federal agency considers that this standard does not provide for its essential needs, written request for changing or adding to the standard, supported by adequate justification, shall be sent to the Administration. This justification shall explain wherein the standard does not provide for essential needs. The request shall be sent in duplicate to the General Services Administration, Federal Supply Service, Standardization Division, Washington, D.C., 20407. The Administration will

**FED. STD. NO. 751a**  
**January 25, 1965**

determine the appropriate action to be taken and will notify the agency.

(Activities outside the Federal Government may obtain copies of Federal Specifications, Standards, and Handbooks as outlined under General Information in the Index of Federal Specifications and Standards and at the prices indicated in the Index. The Index, which includes cumulative monthly supplements as issued, is for sale on a subscription basis by the Superintendent of Documents, U.S. Government Printing Office, Washington, D.C., 20402.

(Single copies of this specification and other products specifications required by activities outside the Federal Government for bidding purposes are available without charge at the General Services Administra-

tion Regional Offices in Boston, New York, Washington, D.C., Atlanta, Chicago, Kansas City, Mo., Dallas, Denver, San Francisco, Los Angeles, and Seattle, Wash.

(Federal Government activities may obtain copies of Federal Specifications, Standards, and Handbooks and the Index of Federal Specifications and Standards from established distribution points in their agencies.

(Copies of Military Specifications and Standards required by contractors in connection with specific procurement functions should be obtained from the procuring activity or as directed by the contracting officer.)

This Standard and Canadian Government Specifications covering stitches, seams, and stitchings are identical in technical content.

## PART I. GENERAL INFORMATION

### Section 2. Index of Stitches, Seams, and Stitchings

<i>STITCHES</i> Stitch Class 100 Stitch type	<i>STITCHES</i> Seam Class SS Seam type	<i>SEAMS</i> Seam Class SS Seam type	<i>SEAMS</i> Seam Class LS Seam type	<i>SEAMS</i> Seam Class LS Seam type
101	518	SSap	LSan	LSou
102	519	SSaq	LSap	LSov
103	520	SSar	LSaq	LSow
104	521	SSas	LSar	LSox
105	<i>Stitch Class 600</i>	SSat	LSas	LSoy
106		<i>Stitch type</i>	LSat	LSoz
<i>Stitch Class 200</i> <i>Stitch type</i>	601	SSau	LSau	LSda
	201	SSav	LSav	LSdb
202	602	SSaw	LSaw	LSdc
203	603	SSax	LSax	LSdd
204	604	SSay	LSay	<i>Seam Class BS</i> <i>Seam type</i>
<i>Stitch Class 300</i> <i>Stitch type</i>	605	SSas	LSas	
	301	606	SSba	LSba
302	607	SSbb	LSbb	BSc
303	<i>Stitch Class 700</i> <i>Stitch type</i>	SSbc	LSbc	BSd
304		701	SSbd	LSbd
305	<i>Seams</i>	SSbe	LSbe	BSf
306	<i>Seam Class SS</i>	SSbf	LSbf	BSg
307	<i>Seam type</i>	SSbg	LSbg	BSh
308	SSa	SSbh	LSbh	BSj
309	SSb	<i>Seam Class LS</i> <i>Seam type</i>	LSbj	BSk
310	SSc		LSa	LSbk
311	SSd	LSb	LSbl	BSm
312	SSe	LSc	LSbm	BSn
313	SSf	LSd	LSbn	BSo
314	SSg	LSe	LSbo	BSp
<i>Stitch Class 400</i> <i>Stitch type</i>	SSh	LSf	LSbp	BSq
	401	SSi	LSbq	LSbr
402	SSj	LSj	LSbr	BSs
403	SSk	LSk	LSbs	<i>Seam Class PS</i> <i>Seam type</i>
404	SSL	LSl	LSbt	
405	SSm	LSm	LSbu	PSb
406	SSn	LSn	LSbv	PSc
407	SSp	LSp	LSbx	PSd
<i>Stitch Class 500</i> <i>Stitch type</i>	SSq	LSq	LSby	PSe
	501	SSr	LSr	PSf
502	SSs	LSs	LSca	<i>STITCHINGS</i> <i>Stitching Class OS</i> <i>Stitching type</i>
503	SSt	LSu	LScb	
504	SSu	LSv	LScc	OSb
505	SSv	LSw	LScd	OSc
506	SSw	LSx	LSce	OSd
507	SSx	LSy	LScf	OSe
508	SSy	LSz	LScg	OSf
509	SSza	LSa	LSch	OSg
510	SSzb	LSa	LScj	OSh
511	SSzc	LSa	LSck	<i>Stitching Class EP</i> <i>Stitching type</i>
512	SSzd	LSa	LScl	
513	SSze	LSa	LScm	EPb
514	SSzf	LSa	LScn	EPc
515	SSzg	LSa	LSco	EPd
516	SSzh	LSa	LSop	EPe
517	SSzi	LSa	LSoq	
	SSzj	LSa	LSor	
	SSzk	LSa	LSos	
	SSzl	LSa	LSot	

**FED. STD. NO. 751a**  
**January 25, 1965**

**STITCHINGS**  
*Stitching Class EF*  
*Stitching type*

**EFY**  
**EFg**  
**EFh**  
**EFj**  
**EFk**  
**EFi**

**STITCHINGS**  
*Stitching Class EF*  
*Stitching type*

**EFm**  
**EFn**  
**EFp**  
**EFq**  
**EFr**  
**EFs**

**STITCHINGS**  
*Stitching Class EF*  
*Stitching type*

**EFt**  
**EFu**  
**EFv**  
**EFw**  
**EFx**

**STITCHINGS**  
*Stitching Class EF*  
*Stitching type*









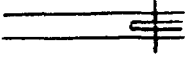
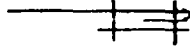
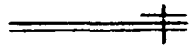
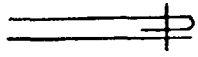
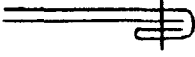
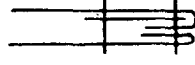
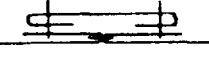
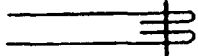
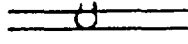

**EFy**  
**EFz**  
**EFaa**  
**EFab**  
**EFac**

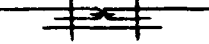
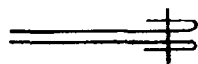
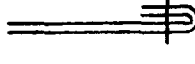
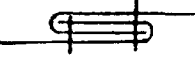
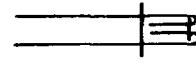
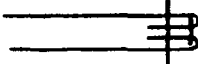
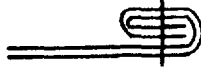
**STITCHINGS**  
*Stitching Class EF*  
*Stitching type*

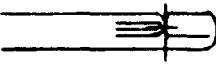
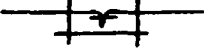
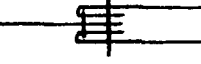
**EFad**  
**EFae**  
**EFaf**  
**EFag**  
**FEah**

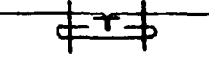

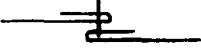
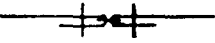
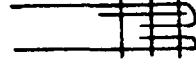
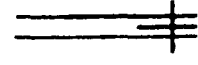

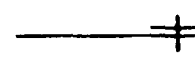
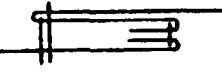





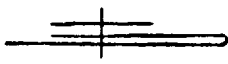
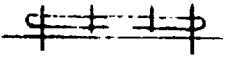
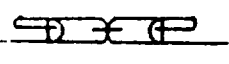
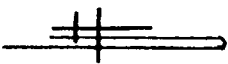
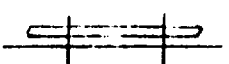
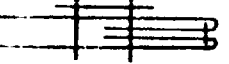

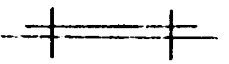
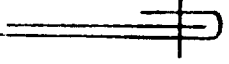
6

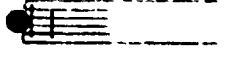
**PART I. GENERAL INFORMATION****Section 2A. Schematic Index of Seams and Stitchings in Alphabetical Order by Class****Seam Class SS (Superimposed)**

 Ssa	 Ssk	 Sst	 SSab
 SSb	 SS1	 SSu	 SSac
 SSc	 SSm	 SSv	 SSad
 SSd	 SSn	 SSw	 SSae
 SSe	 SSP	 SSx	 SSaf
 SSf	 SSq	 SSy	 SSag
 SSh	 SSR	 SSz	 SSah
 SSj	 SSe	 SSaa	 SSaj

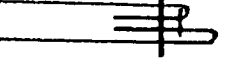

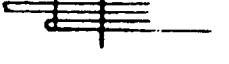
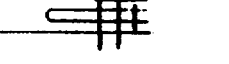
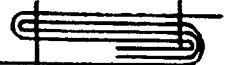
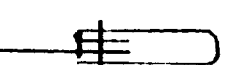
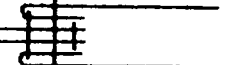
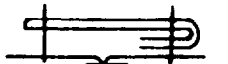
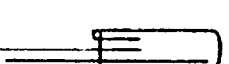







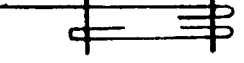
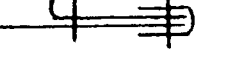
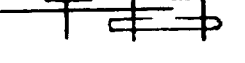

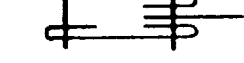
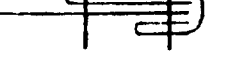
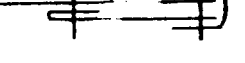

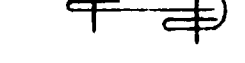

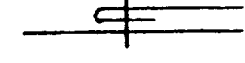
FED. STD. NO. 751a  
 January 25, 1965

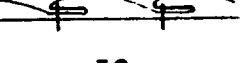
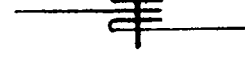
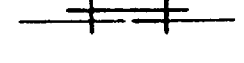
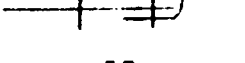
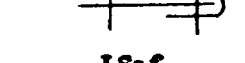
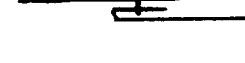
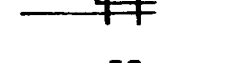
Seam Class SS (Superimposed) (Continued)

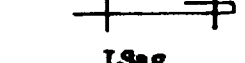
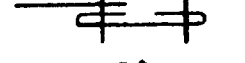
 SSak	 SSas	 SSba	
 SSal	 SSat	 SSbb	
 SSam	 SSau	 SSbc	
 SSan	 SSav	 SSbd	
 SSao	 SSaw	 SSbe	
 SSap	 SSax	 SSbf	
 SSaq	 SSay	 SSbg	
 SSar	 SSaz	 SSbh	

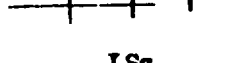

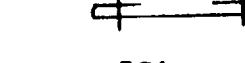
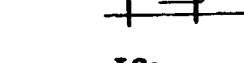







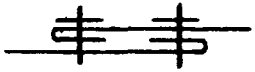
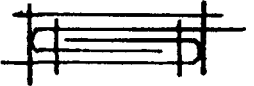

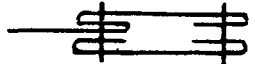
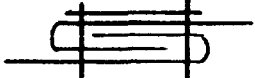
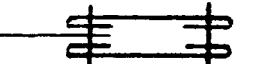
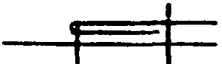
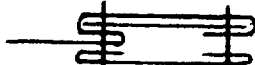
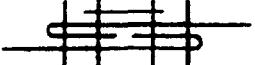
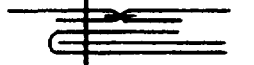

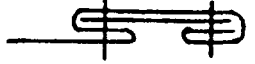
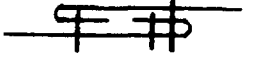
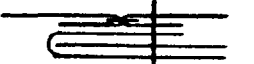
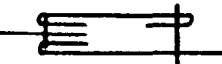

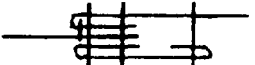
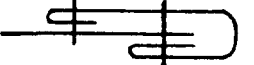
## Seam Class LS (Lapped)

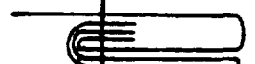
 <b>LSa</b>	 <b>LSk</b>	 <b>LSt</b>	 <b>LSab</b>
 <b>LSb</b>	 <b>LS1</b>	 <b>LSu</b>	 <b>LSac</b>
 <b>LSc</b>	 <b>LSn</b>	 <b>LSw</b>	 <b>LSad</b>
 <b>LSd</b>	 <b>LSn</b>	 <b>LSw</b>	 <b>LSae</b>
 <b>LSe</b>	 <b>LSp</b>	 <b>LSx</b>	 <b>LSaf</b>
 <b>Lsf</b>	 <b>LSq</b>	 <b>LSy</b>	 <b>LSag</b>
 <b>Lsg</b>	 <b>Lsr</b>	 <b>LSz</b>	 <b>LSah</b>
 <b>LSj</b>	 <b>LSe</b>	 <b>LSaa</b>	 <b>LSaj</b>

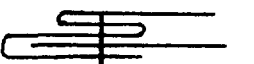
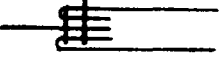
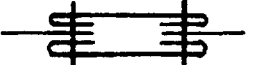
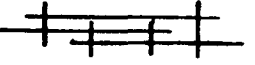

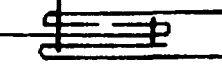

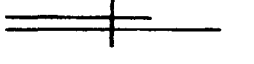
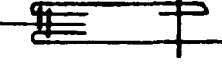







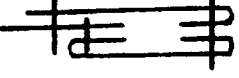
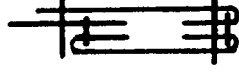

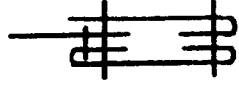
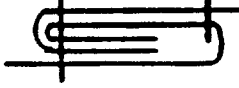
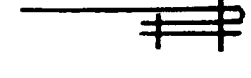

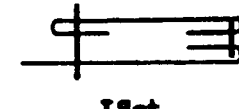
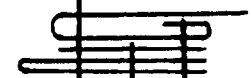
FED. STD. NO. 751a  
 January 25, 1965

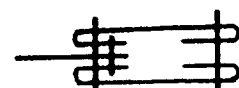
Seam Class LS (Lapped) (Continued)

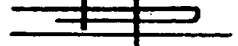
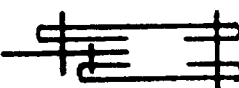
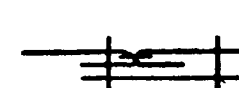
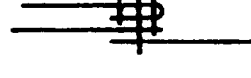
 <b>LSak</b>	 <b>LSat</b>	 <b>LSbb</b>	 <b>LSbk</b>
 <b>LSa1</b>	 <b>LSau</b>	 <b>LSbc</b>	 <b>LSbl</b>
 <b>LSan</b>	 <b>LSav</b>	 <b>LSbd</b>	 <b>LSbn</b>
 <b>LSap</b>	 <b>LSav</b>	 <b>LSbe</b>	 <b>LSbn</b>
 <b>LSap</b>	 <b>LSax</b>	 <b>LSbf</b>	 <b>LSbo</b>
 <b>LSaq</b>	 <b>LSay</b>	 <b>LSbg</b>	 <b>LSbp</b>
 <b>LSar</b>	 <b>LSas</b>	 <b>LSbh</b>	 <b>LSbq</b>
 <b>LSas</b>	 <b>LSba</b>	 <b>LSbj</b>	 <b>LSbr</b>

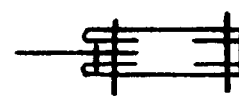

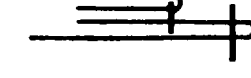
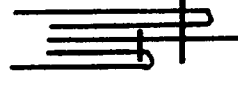
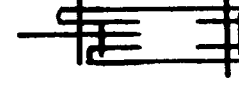
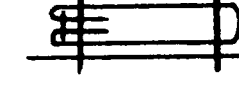
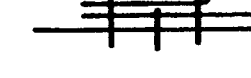
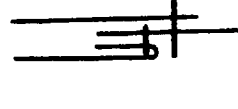
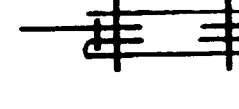

10

## Seam Class LS (Lapped) (Continued)

 LSbs	 LSca	 LScj	 LScr
 LSbt	 LScb	 LSck	 LScs
 LSbu	 LSco	 LSc1	 LSc2
 LSbv	 LScd	 LScn	 LScu
 LSbw	 LSce	 LScn	 LScv
 LSbx	 LScf	 LSco	 LScw
 LSby	 LScg	 LScp	 LScx
 LSbz	 LSch	 LScq	 LScy



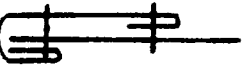

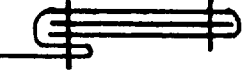





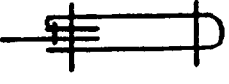

FED. STD. NO. 751a  
January 25, 1965

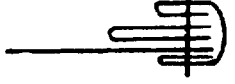
Seam Class LS (Lapped) (Continued)

 LSca			
 LSda			
 LSdb			
 LSdc			
 LSdd			

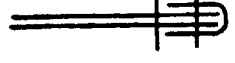
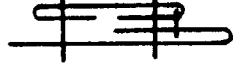
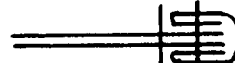

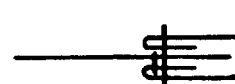
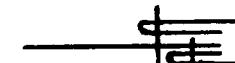

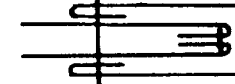

12

Seam Class BS (Bound)

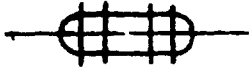
 BSa	 BSj	 BSr	
 BSb	 BSk	 BSs	
 BSc	 BSl		
 BSd	 BSm		
 BSe	 BSn		
 BSf	 BSo		
 BSg	 BSp		
 BSb	 BSq		







FED. STD. NO. 751a  
January 25, 1965

Seam Class FS (Flat)

 FSa	 FSb		
 FSc	 FSe		
 FSd			
 FSe			

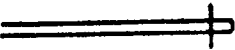

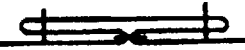







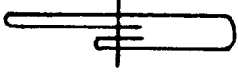

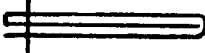

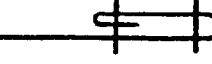
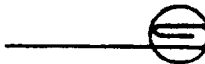
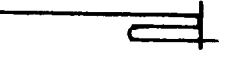
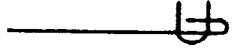

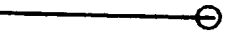
41

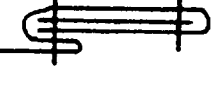
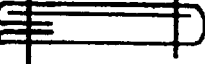
Stitching Class OS (Ornamental)

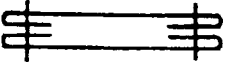
 OSa	 OSb		
 OSc	 OSd		
 OSd	 OSg		
 OSd	 OSh		

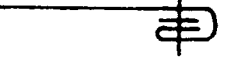
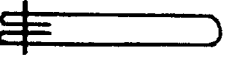
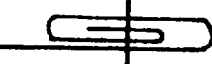
FED. STD. NO. 751a  
January 25, 1965

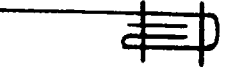
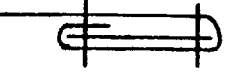
Stitching Class KF (Edge Finishing)

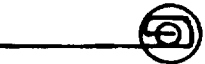
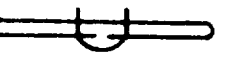
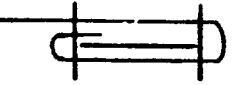
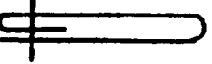
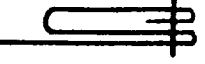
 KF a	 KF j	 KF e	 KF aa
 KF b	 KF k	 KF t	 KF ab
 KF c	 KF l	 KF u	 KF ac
 KF d	 KF n	 KF v	 KF ad
 KF o	 KF p	 KF w	 KF ae
 KF i	 KF q	 KF x	 KF af
 KF g	 KF q	 KF y	 KF ag
 KF h	 KF r	 KF z	 KF ah

16



## PART I. GENERAL INFORMATION

### Section 3. Characteristics of Seams and Stitchings

**3.1** The characteristics of a properly constructed seam or stitching are strength, elasticity, durability, security, and appearance. These characteristics must be balanced with the properties of the material to be joined to form the optimum seam. The end use of the item will govern the relative importance of these characteristics, and the selection of the seam or stitching type and stitch type should be based upon these considerations.

**3.1.1 Strength.** The strength of the seam or stitching should equal that of the material it joins in order to have balanced construction that will withstand the forces encountered in the use of the item of which the seam is a part. The elements affecting the strength of a seam or stitching are:

- (a) Stitch type.
- (b) Thread strength.
- (c) Stitches per inch.
- (d) Thread tension.
- (e) Seam or stitching type.
- (f) Seam efficiency of the material.

**3.1.2 Elasticity.** The elasticity of a seam or stitching should be slightly greater than that of the material which it joins, so that the material will support its share of the forces encountered in the end use of the sewn item. The elasticity of a seam or stitching depends upon:

- (a) Stitch type.
- (b) Thread elasticity.

**3.1.3 Durability.** The durability of a seam or stitching depends largely upon its strength and the relation between the elasticity of the seam and the elasticity of the material. However, in the less elastic, tightly woven, dense materials there is a tendency for the plies to "work" or slide on each other. To form a durable seam or stitching in such materials, the

thread size must be judiciously chosen and the stitches well set to the material (without undue tension which will unbalance the elasticity and cause puckering) to minimize abrasion and wear by contact with outside agencies.

**3.1.4 Security.** The security of a seam or stitching depends chiefly upon the stitch type and its susceptibility to become unraveled. The stitch must be well set to the material to prevent snagging which can cause rupture of the thread and unraveling of certain of the stitch types.

**3.1.5 Appearance.** The appearance of a seam or stitching generally is governed by the proper relationship between the size and type of thread, the length of stitch or number of stitches per inch, and the texture and weight of the fabric.

In addition to this relationship, the technique and skill of the sewing machine operators also govern the appearance of the seams and stitchings. Some of the factors which will adversely affect the appearance are as follows:

#### *Stitch defects*

- Loose stitches.
- Poorly formed stitches.
- Crowded stitches.
- Tight stitches.
- Crooked stitches.
- Skipped stitches.

#### *Seam and stitching defects*

- Puckers.
- Twists.
- Plaits
- Undulations.
- Run-offs (raised seams).
- Raw edges exposed (felled seams).

## PART I. GENERAL INFORMATION

## Section 4. Guide for the Use of Stitches, Seams, and Stitchings

4.1 The following table illustrates a general application of the various types of stitches, seams, and stitchings to typical operations.

Seam type	Operation	Types of standard stitches suitable
<i>Superimposed seams</i>		
SSa-1	Seaming (bag, jute, cotton)..... Basting..... Seaming (straight)..... Seaming (zigzag)..... Seaming (overedge)..... Seaming (using waxed thread).....	101, 104, 301, 401. 101. 301, 401. 304, 404. 501 to 518. 101, 201, 301.
SSa-2	Seaming and serging.....	301, 401, 501 to 507, 602, 515 to 519.
SSb-1 and SSb-2	Seaming (straight)..... Seaming (where similar stitch is essential on both surfaces).	301, 401, 302, 402. 301.
SSc-1 and SSc-2	Seaming.....	301, 401, 302, 402.
SSd-1	Seaming.....	301, 401.
SSe-2 and SSe-3	Seaming and edge finishing..... Making cuffs, collars, etc., and edge stitching on coats and shoes.	301, 401, 302, 402.
SSf-3	Taping or staying.....	301, 401.
SSh-2	Cover seaming.....	302, 402, 406.
SSj-1	Seaming.....	201, 301, 401.
SSk-1	Seaming and cording.....	201, 301, 401.
SSL-1	Seaming.....	201, 301, 401.
SSm-1	Seaming or felling, where a blind stitch is required..... Padding lapels, felling tapes, etc.....	103. 103.
SSn-1	Seaming.....	101, 301, 401.
SSp-1	Seaming.....	301, 401.
SSq-2 and SSq-3	Seaming.....	301, 401, 302, 402.
SSr-1	Seaming.....	301, 401.
SSs-1 and SSs-2	Seaming and staying.....	301, 401.
SSt-2 to SSt-4	Seaming and taping.....	301, 401.
SSu-2 to SSu-4	Attaching elastic.....	301, 401.
SSu-2	Making pocket jettings.....	301.
SSv-1 to SSv-3	Quilting.....	301, 401.
SSw-2	Seaming.....	301, 401.
SSx-2	Seaming (crotch pieces and linings to trousers).....	301, 401.
SSy-2	Seaming.....	301, 401.
SSz-3	Seaming.....	301, 401.
SSas-1	Taping (coat fronts and armholes).....	301.
SSab-1	Taping (coat fronts and armholes).....	301.
SSac-3	Taping (crotch seams on trousers).....	301.
SSad-3	Seaming and staying.....	301, 401.
SSae-2 and SSae-3	Seaming.....	301, 401.
SSaf-2	Seaming and staying.....	301, 401.
SSag-3	Seaming and staying.....	301, 401.
SSah-3 and SSah-4	Seaming.....	301, 401.
SSaj-3	Seaming.....	301, 401.
SSak-1	Attaching slide fasteners.....	301, 401.
SSal-2	Attaching slide fasteners.....	301, 401.
SSam-2	Seaming.....	301, 401.
SSan-2	Seaming.....	301, 401.
SSao-2	Seaming.....	301, 401.

**FED. STD. NO. 751a**  
**January 26, 1965**

Seam type	Operation	Types of standard stitches suitable
<i>Superimposed seams—Con.</i>		
SSap-3	Seaming	301, 401.
SSaq-3	Seaming	301, 401.
SSar-3	Attaching end of left fly lining to crotch seam	301, 401.
SSas-4	Attaching buttonhole strips	301, 401.
SSat-2	Attaching buttonhole strips	301, 401.
SSau-2	Staying	301, 401.
SSav-2	Seaming and welting	301, 401.
SSaw-2	Seaming and welting	301, 401, 504.
SSax-2	Seaming and welting	301, 401, 504.
SSay-2	Making waistbands	301, 401.
SSas-1	Seaming neckties	104.
SSba-3	Book seaming	103 and 301 or 401.
SSbb-3	Seaming and staying	301, 401.
SSbc-1	Attaching interlining to cuff	103, 306.
SSbd-1	Seaming	301, 401.
SSbe-2	Seaming and edge finishing	301, 306, 401.
SSbf-3	Seaming and welting	301, 401.
SSbg-3	Seaming and welting	301, 401.
SSbh-3	Seaming	301, 401.
<i>Lapped seams</i>		
LSa-1	Seaming knitted materials or underwear and similar garments.	602, 603, 604, 605.
LSa-1 and LSa-2	Seaming	301, 401, 402, 406, 407.
LSb-1 and LSb-2	Seaming (using waxed thread)	101, 201, 301.
LSc-1 to LSc-4	Seaming	301, 401, 402, 406.
LSd-1 to LSc-3	Seaming	301, 401.
LSd-1 to LSc-3	Attaching pieces to body of material	301, 304, 401.
LSe-1 to LSe-3	Seaming	301, 401.
LSf-1 and LSf-2	Seaming	301, 401.
LSg-2 to LSg-4	Facing (center plaits, stays, etc.)	301, 401.
LSj-2 and LSj-4	Facing (center plaits, stays, etc.)	301, 401.
LSk-2 and LSk-4	Facing (center plaits, stays, etc.)	301, 401.
LSl-2 and LSl-4	Facing and seaming (center plaits, stays, etc.)	301, 401.
LSm-2 and LSm-4	Facing (center plaits, stays, etc.)	101, 301, 401.
LSn-1	Facing (center plaits, stays, etc.)	301, 401.
LSp-2 and LSp-4	Joining with overlapping strip	301, 401.
LSq-2 and LSq-3	Seaming	201, 301, 401.
LSr-2	Seaming	301, 401.
LSs-2	Seaming	301, 401.
LSt-2	Seaming	301, 401.
LSu-2	Seaming	301, 401.
LSv-2	Facing and staying	301, 401.
LSw-4	Joining band (plain, elastic, etc.)	301, 401.
LSx-2 and LSx-3	Seaming	301, 401.
LSy-2 and LSy-3	Seaming	301, 401.
LSz-3 and LSz-4	Seaming	301, 401.
LSaa-3	Seaming	301, 401.
LSab-3 and LSab-4	Banding	301, 401.
LSac-2	Facing and binding	301, 401.
LSad-2	Facing and binding	301, 401.
LSae-1	Undersewing cushion	301, 401.
LSaf-2	Staying automobile quarters	301, 401.
LSag-2	Staying automobile quarters	301, 401.
LSah-1	Seaming	301, 401.
LSaj-1	Seaming	301, 401.
LSak-2	Seaming	301, 401.

20

Seam type	Operation	Types of standard stitches suitable
<i>Lapped seams—Continued</i>		
LSa1-2 and LSa1-4	Facing (center plaits, stays, etc.)	301, 401.
LSam-2 and LSam-4	Facing (center plaits, stays, etc.)	301, 401.
LSan-2 and LSan-4	Facing (center plaits, stays, etc.)	301, 401.
LSap-1	Finishing	301, 401.
LSaq-1	Finishing	301, 401.
LSar-2 to LSar-4	Facing and seaming	301, 401.
LSas-2	Seaming and gathering	301, 401.
LSat-2	Seaming and staying	301, 401.
LSau-2 to LSau-4	Seaming	301, 401.
LSav-4	Seaming and reinforcing	301, 401.
LSaw-3	Seaming	301, 401.
LSax-4	Seaming	301, 401.
LSay-4	Sewing-on band with elastic	301, 401.
LSas-4	Seaming and staying	301, 401.
LSba-2	Seaming	301, 401.
LSbb-4	Seaming and staying	101, 301, 401.
LSbo-2 to LSbo-4	Facing	301, 401.
LSbd-2	Seaming	301, 401.
LSbe-2	Seaming	301, 401.
LSbf-2 to LSbf-4	Binding (center plait)	301, 401.
LSbg-1	Seaming	301, 401.
LSbh-1 and LSbh-2	Binding, inserting tape between binding and body material.	301, 401.
LSbj-1	Attaching pieces to body material	301, 401.
LSbk-2	Attaching pieces to body material	301, 401.
LSbl-2	Attaching pocket flaps and belt loops	301, 401.
LSbm-3 and LSbm-4	Seaming	301, 401.
LSbn-2	Seaming	301, 401.
LSbo-3	Seaming	301, 401.
LSbp-2	Joining yoke to shirt	301, 401.
LSbq-2	Joining yokes to shirt in loosely woven material	301, 401.
LSbr-3	Seaming	301, 401.
LSbs-1	Attaching slide fasteners	301, 401.
LSbt-2	Attaching slide fasteners	301, 401.
LSbu-2	Attaching slide fasteners	301, 401.
LSbv-3	Attaching slide fasteners	301, 401.
LSbw-3	Seaming and binding	301, 401.
LSbx-2	Forming welt on set-in pockets	301, 401.
LSby-2	Forming welt on set-in pockets	301, 401.
LSbs-2	Forming pocket welts	301, 401.
LSca-2	Forming pocket welts	301, 401.
LScb-2	Top edge of hip pocket with a stay and facing	301, 401.
LScc-2	Top edge of hip pocket	301, 401.
LScd-3	Top edge of hip pocket	301, 401.
LSce-2	Forming welt on bottom edge of set-in hip pockets	301, 401.
LScf-2	Attaching cuffs, waistbands or collars	301, 401.
LScg-2	Attaching cuffs, waistbands or collars	301, 401.
LSch-2	Attaching cuffs, waistbands or collars	301, 401.
LScj-3	Attaching cuffs, waistbands or collars	301, 401.
LSck-3	Attaching cuffs, waistbands or collars	301, 401.
LScl-3	Attaching cuffs, waistbands or collars	301, 401.
LScm-3	Attaching cuffs, waistbands or collars	301, 401.
LScn-3	Attaching cuffs, waistbands or collars	301, 401.
LSco-4	Attaching cuffs, waistbands or collars	301, 401.
LSop-4	Attaching cuffs, waistbands or collars	301, 401.
LSoq-4	Attaching cuffs, waistbands or collars	301, 401.

**FED. STD. NO. 751a**  
**January 25, 1965**

Seam type	Operation	Types of standard stitches suitable
<i>Lapped seams—Continued</i>		
LSer-4.....	Attaching cuffs, waistbands or collars.....	301, 401.
LSes-3.....	Attaching left fly to trouser fronts.....	301, 401.
LSer-2.....	Attaching waistband linings.....	301, 401.
LSou-2.....	Finishing bottoms of caps.....	301, 401.
LSov-3.....	Seaming curtains on waistbands.....	301, 401.
LSow-3.....	Making sewn-on belts or bands.....	301, 401.
LSox-3.....	Making sewn-on belts or bands.....	301, 401.
LSoy-3.....	Seaming and staying.....	301, 401.
LSes-2.....	Seaming.....	301, 401.
LSds-2.....	Making flag headings.....	301, 401.
LSdb-2.....	Facing.....	301, 401.
LSdc-3.....	Trouser crotch seam.....	301, 401.
LSdd-2.....	Cut-on shirt front.....	301, 401.
<i>Bound seams</i>		
B8a-1 and B8a-2.....	Binding, bound seaming.....	301, 401, 304, 404, 406.
B8b-1 and B8b-2.....	Binding, bound seaming.....	301, 401, 304, 404.
B8c-1 and B8c-2.....	Binding, bound seaming.....	301, 401, 304, 404.
B8d-2.....	Seaming and binding.....	301, 401.
B8e-2.....	Seaming and binding.....	301, 401.
B8f-2.....	Seaming and binding.....	301, 401.
B8g-2.....	Seaming and binding.....	301, 401.
B8h-3.....	Seaming and binding.....	301, 401.
B8j-2.....	Binding, bound seaming.....	301, 304, 401, 404, 406.
B8k-1.....	Binding and welting.....	301, 401.
B8l-4.....	Binding flag headings.....	301, 401.
B8m-3.....	Facing pockets.....	301, 401.
B8n-4.....	Binding flag headings.....	301, 401.
B8o-2.....	Binding, bound seaming.....	301, 304, 401, 404, 406.
B8p-2.....	Making pocket welts.....	301, 401.
B8q-2.....	Seaming and binding.....	301, 401.
B8r-2 and B8r-4.....	Seaming and binding.....	301, 401.
B8s-2.....	Binding flag headings.....	301, 401.
<i>Flat seams</i>		
FBa-1.....	Seaming.....	304, 404, 606, 607.
	Attaching collars, cuffs, borders, etc. to knitted articles.....	602, 603, 606.
	Attaching edging, lace, etc.....	601, 602, 603.
FBb-1.....	Seaming.....	304, 602, 603, 606.
FBc-1.....	Seaming.....	304, 404.
FBd-3.....	Seaming and staying.....	304, 404.
FBe-1.....	Seaming and staying.....	304, 404.
FBf-1.....	Hosiery toe closing.....	521.
	Seaming fur pelts, or seaming with over edge stitching where a flat butted seam is desired.....	501 thru 505.
<i>Ornamental stitching</i>		
O8a-1 to O8a-3.....	Ornamental.....	101, 102, 104, 201, 203, 204, 301, 302, 303, 304, 305, 306, 307, 309, 310, 311, 312, 402, 403, 404, 405, 406.
O8b-1.....	Cording.....	102, 302, 402, 406.
O8c-1.....	Cording.....	102, 302, 402, 406.

Seam type	Operation	Types of standard stitches suitable
<i>Ornamental stitching—Con.</i>		
OSd-2 and OSd-3.....	Cording.....	101, 301, 401.
OSe-1.....	Tucking or plaiting.....	101, 301, 401.
OSf-1.....	Tucking and mock seaming.....	101, 301, 401.
OSg-3.....	Making box or inverted plait.....	301, 401.
OSh-3.....	Wetting.....	301, 401.
<i>Edge finishing</i>		
EFa-1 and EFa-2.....	Hemming (one fold).....	101, 102, 301, 302, 401, 402, 406.
EFb-1 and EFb-2.....	Hemming (two folds).....	101, 301, 401, 402, 406.
EFc-1.....	Blind hemming (woven).....	301.
	Blind hemming (knit).....	301, 401, 502, 503, 505.
EFd-1.....	Edge finishing (serging).....	502, 503, 504, 505.
	Ornamental edge finishing.....	304, 502, 503, 504, 505, 601, 603, 604, 605, 607.
EFe-1.....	Ornamental edge finishing (singsag).....	304, 404.
EFf-1.....	Hemming with elastic tape.....	101, 301, 401.
EFg-2.....	Hemming with elastic tape.....	101, 301, 401.
EFh-1.....	Making loops or straps.....	406.
EFj-1 and EFj-3.....	Making straps.....	301, 401.
	Making straps (using waxed thread).....	101, 301.
EFk-2 and EFk-4.....	Cut-on center plait (shirt fronts).....	301, 401.
EFl-1.....	Blind hemming.....	103, 301, 306, 401, 502, 503.
EFm-1.....	Blind hemming.....	103, 301, 306, 401, 502, 503.
EFn-2 and EFn-4.....	Making straps or loops.....	301, 401.
EFp-1 and EFp-2.....	Making straps or loops.....	301, 401.
EFq-2.....	Inserting elastic in hems.....	301, 401.
EFr-2.....	Inserting elastic in hems.....	301, 401.
EFs-2.....	Making straps or loops.....	301, 401.
EFt-2 and EFt-4.....	Hemming shirt fronts.....	301, 401.
EFu-1.....	Making drawstrings or loops.....	301, 401.
EFv-2 and EFv-4.....	Cut-on center plait (shirt fronts).....	301, 401.
EFw-1.....	Hemming (three folds).....	101, 301, 401, 402, 406.
EFx-1.....	Hemming.....	101, 301, 401, 402, 406.
EFy-1 and EFy-3.....	Making straps or loops.....	301, 401, 406.
EFz-1 and EFz-2.....	Making straps or loops.....	301, 401, 406.
EFaa-1 and EFaa-2.....	Making straps or loops.....	301, 401, 406.
EFab-1.....	Hemming.....	502, 503, 504, 505.
EFac-2.....	Making straps or loops.....	301, 401.
EFad-2.....	Making straps or loops.....	301, 401.
EFae-2.....	Making straps or loops.....	103.
EFaf-2.....	Edge finishing.....	501, 502, 503, 504, 505.
EFag-2.....	Edge finishing.....	501, 502, 503, 504, 505.
EFah-1.....	Hemming.....	301, 401.

## PART II. REQUIREMENTS

### Section 1. Stitches

**1.1 Stitches.** Stitches are divided into seven classes which are identified by the first digit of three digit numerals. Each class is divided into several types which are identified by the second and third digit. All stitch types shall conform to the drawings unless otherwise specified.

**1.1.1 *Stitch class 100.*** This class of stitch shall be formed with one or more needle threads and has for its general characteristic interlooping. A loop or loops of thread or threads shall be passed through the material and secured by interlooping with succeeding loop or loops, after they are passed through the material, to form a stitch.

**1.1.2 *Stitch class 200.*** This class of stitch shall be formed by hand with one or more needle threads and has for a general characteristic that each thread passes through the material as a single line of thread and the stitch is secured by the single line of thread passing in and out of the material or interlooping of the threads with themselves. When more than one thread is used, the threads pass through the same perforations in the material.

**1.1.3 *Stitch class 300.*** This class of stitch shall be formed with two or more groups of threads and has for a general characteristic, the interlacing of the two groups. Loops of the first group are passed through the material where they are secured by the thread or threads of the second group to form a stitch.

**1.1.4 *Stitch class 400.*** This class of stitch shall be formed with two or more groups of threads and has for a general characteristic the interlacing and interlooping of the loops of the two groups. Loops of the first group of threads are passed through the material and are secured by interlacing and interlooping with loops of the second group to form a stitch.

**1.1.5 *Stitch class 500.*** This class of stitch shall be formed with one or more groups of thread, and has for a general characteristic that loops from at least one group of thread shall pass around the edge of the material. Loops of one group of thread are passed through the material and are secured by interlooping with themselves before succeeding loops are passed through the material, or secured by interlooping with loops of one or more interlooped groups of threads before succeeding loops of the first group are again passed through the material.

**1.1.6 *Stitch class 600.*** This class of stitch shall be formed with two or more groups of threads, and has for a general characteristic that two of the groups cover the raw edges of both surfaces of the material. Loops of the first group of thread are passed through loops of the third group already cast on the surface of the material and then through the material where they are interlooped with loops of the second group of thread on the underside of the material. The one exception to this procedure is stitch type 601 where only two groups of thread are used and the function of the third group is performed by one of the threads in the first group.

**1.1.7 *Stitch class 700.*** This class of stitch shall be formed with a single continuous needle thread and has for a general characteristic that at the penetration of the first stitch a portion of the needle thread shall be wound onto a reel in the lower mechanism of the machine. The stitches shall be formed by interlacing the needle thread with the thread wound on the reel. The interlacing of this stitch class, except for the initial stitch, shall be identical to that of stitch class 300.

**Stitch Type 101**  
**January 25, 1965**

**DIRECTION OF SUCCESSIVE STITCH FORMATION**

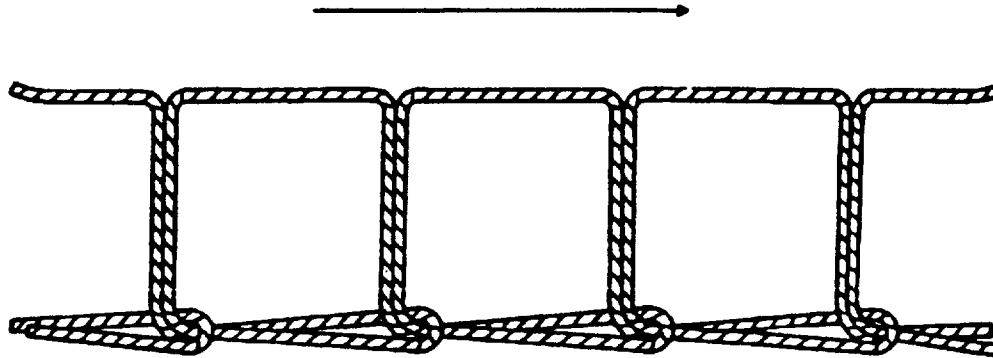

**Stitch type 101**

This type of stitch shall be formed with one needle thread which shall be passed through the material and interlooped with itself on the undersurface of the material.

**Stitch Type 102**  
**January 25, 1965**

**DIRECTION OF SUCCESSIVE STITCH FORMATION**

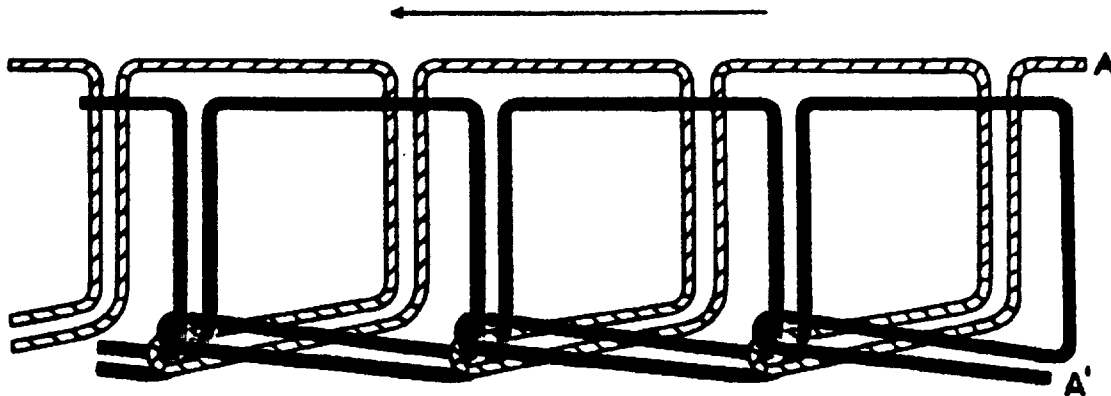

**Stitch type 102**

This type of stitch shall be formed with two needle threads A and A'. Both threads shall be passed through the material and thread A' shall be interlooped with itself and with thread A.



Stitch Type 103  
January 25, 1965

DIRECTION OF SUCCESSIVE STITCH FORMATION

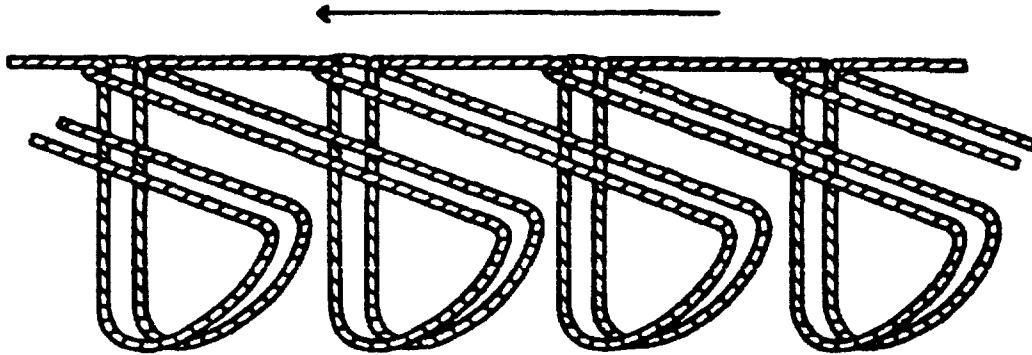

Stitch type 103

This type of stitch shall be formed with one needle thread, which shall interloop with itself on the top surface of the material. The thread

shall be passed through the top ply and horizontally through portions of the bottom ply without penetrating it the full depth.

Stitch Type 104  
January 25, 1965

DIRECTION OF SUCCESSIVE STITCH FORMATION

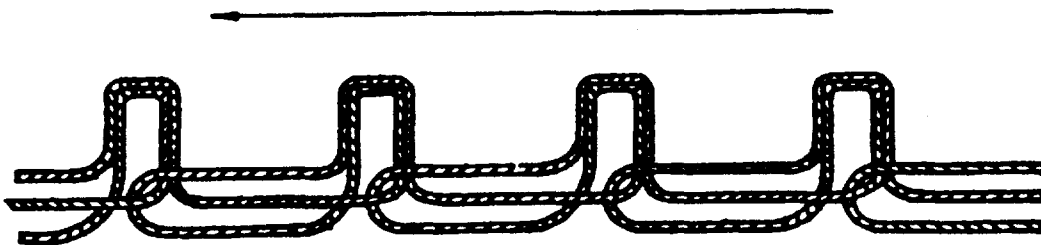

Stitch type 104

This type of stitch shall be formed with one needle thread which shall interloop with itself on the undersurface of the material.

Stitch Type 105  
January 25, 1965

DIRECTION OF SUCCESSIVE STITCH FORMATION

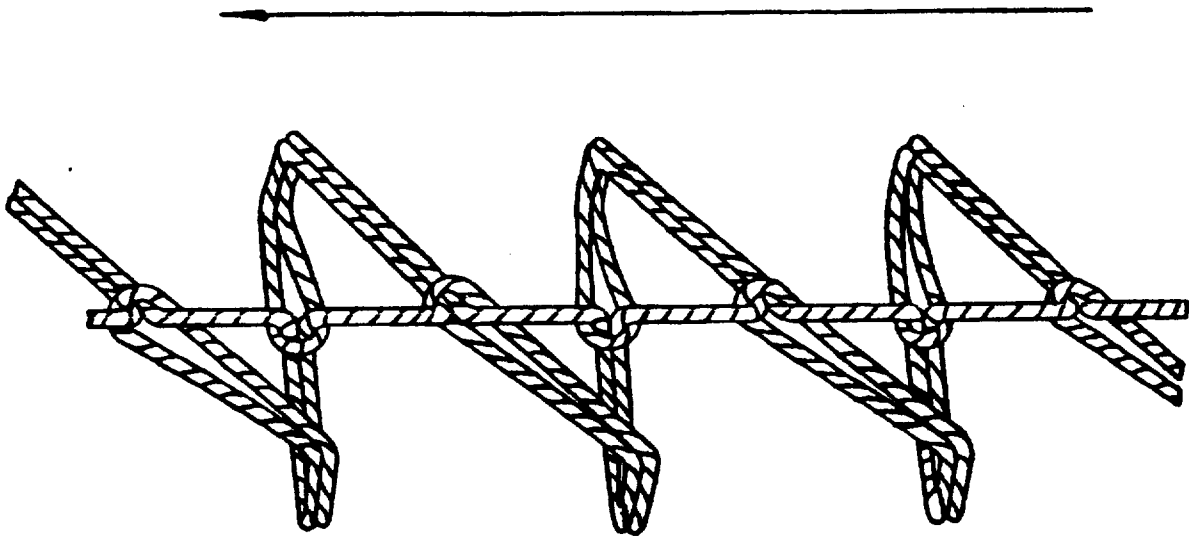

Stitch type 105

This type of stitch shall be formed with one needle thread which shall be passed through the top ply of material and through portions of the bottom ply without penetrating it the full

depth, on either side of a center line. The thread shall interloop with itself on the surface of the material at the center line.

Stitch Type 106  
January 25, 1965

DIRECTION OF SUCCESSIVE STITCH FORMATION

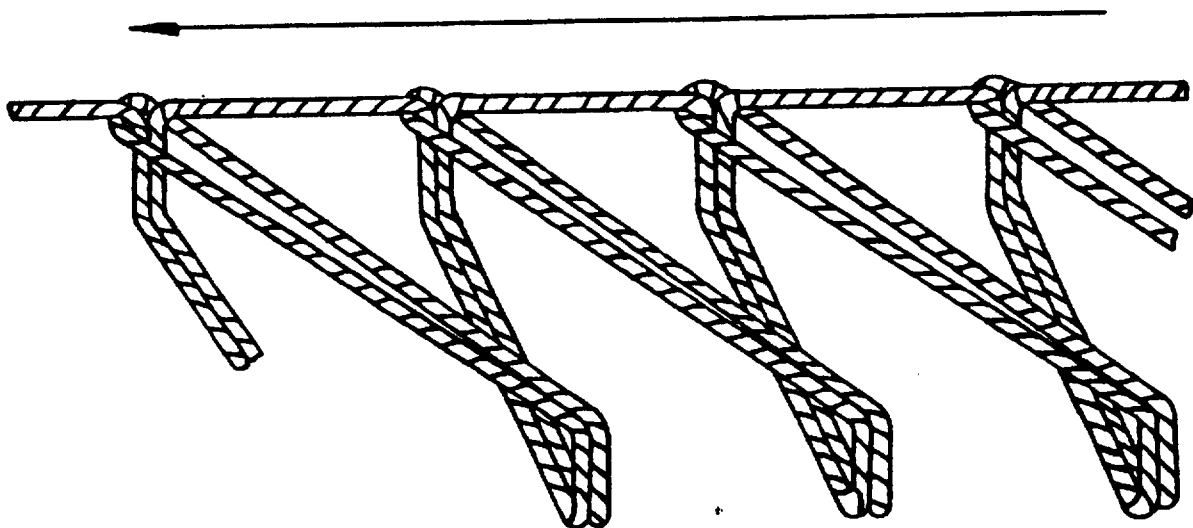

Stitch type 106

This type of stitch shall be formed with one needle thread which shall be passed through the top ply of the material and through portions

of the bottom ply without penetrating it the full depth, and interloop with itself on the surface of the material.

FED. STD. NO. 751a

**Stitch Type 201**  
**January 25, 1965**

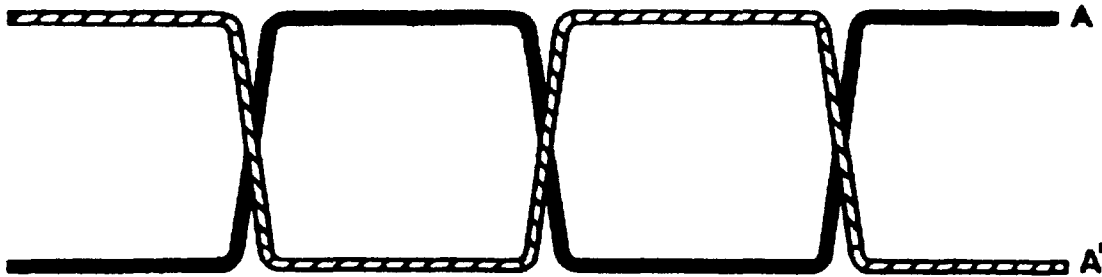

**Stitch type 201**

This type of stitch shall be formed with two needle threads, A and A', which shall be passed through the material in the same perforations

from opposite directions without interlacing or interlooping.

**Stitch Type 202**  
**January 25, 1965**

**DIRECTION OF SUCCESSIVE STITCH FORMATION**

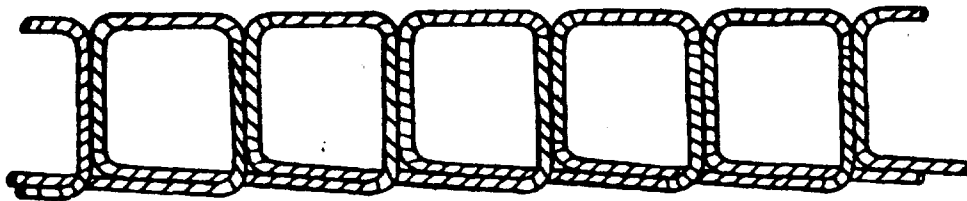

**Stitch type 202**

This type of stitch shall be formed with one needle thread, which shall be passed through the material brought forward two stitch lengths,

passed back through the material and brought back one stitch length before being passed through the material a third time.

30

Stitch Type 203  
January 25, 1965

DIRECTION OF SUCCESSIVE STITCH FORMATION

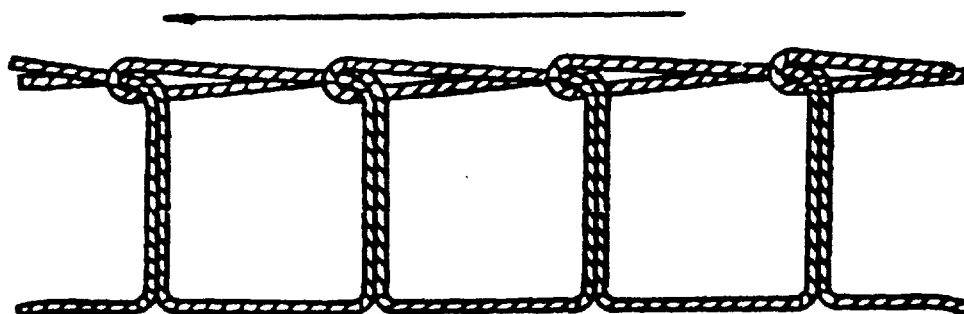

Stitch type 203

This type of stitch shall be formed with one needle thread, which shall be passed through the material from the underside and immediately passed back through the same perforation to form a loop on the surface of the material.

The needle shall be advanced one stitch length, passed through the material and the loop and immediately passed back through the loop and the same needle perforation, and a new loop shall be formed to receive the succeeding stitch.

Stitch Type 204  
January 25, 1965

DIRECTION OF SUCCESSIVE STITCH FORMATION

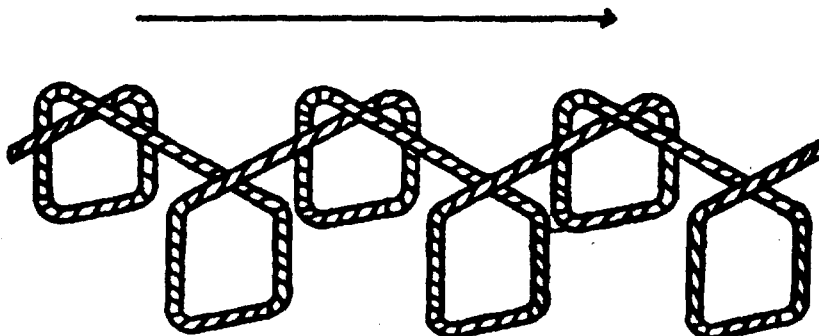

Stitch type 204

This type of stitch shall be formed with one needle thread, which shall be passed through the material and brought back one stitch length and then passed back up through the material. The needle shall be moved diagonally across the material and forward one stitch length,

passed through the material, brought back one stitch length and again passed to the surface of the material. This process shall be repeated to form a crisscross pattern of stitches on the surface and parallel rows of separated and offset stitches on the underside of the material.

FED. STD. NO. 751a

Stitch Type 301  
January 25, 1965

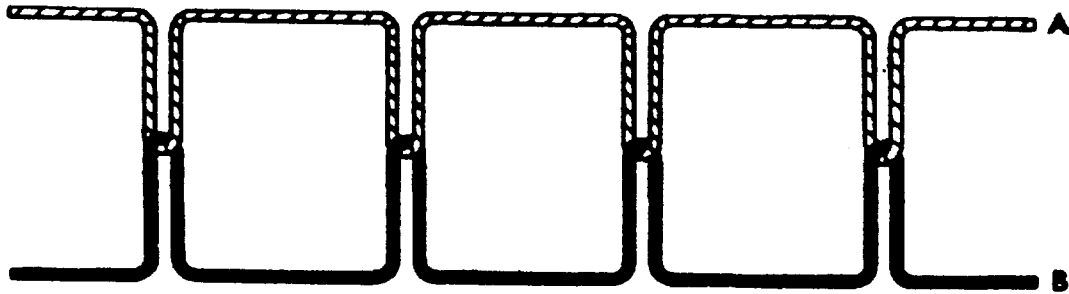

Stitch type 301

This type of stitch shall be formed with two threads: one needle thread, A, and one bobbin thread, B. A loop of thread A shall be passed through the material and interlaced with thread

B. Thread A shall be pulled back so that the interlacing shall be midway between surfaces of the material or materials being sewn.

32

Stitch Type 302  
January 25, 1965

DIRECTION OF SUCCESSIVE STITCH FORMATION

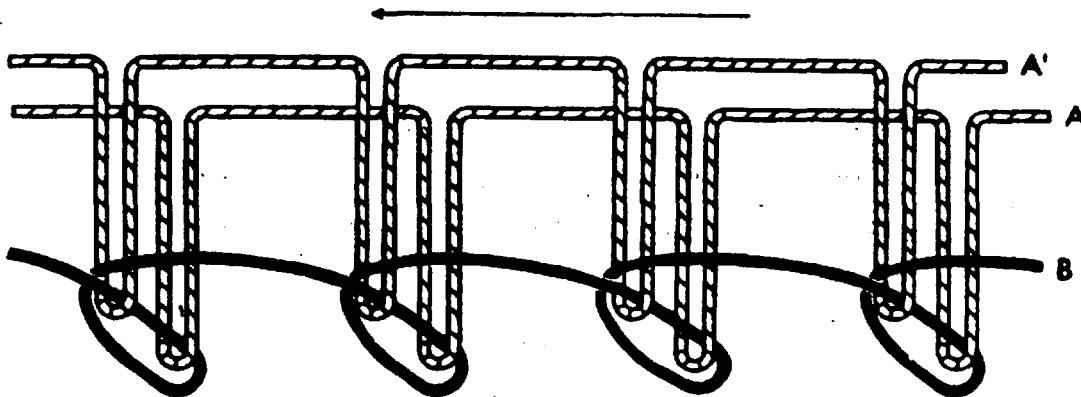

Stitch type 302

This type of stitch shall be formed with three threads: two needle threads, A and A', and one bobbin thread, B. Loops of threads A and A'

shall be passed through the material and interlaced with thread B. The interlacings shall be on the underside of the material.

Stitch Type 303  
January 25, 1965

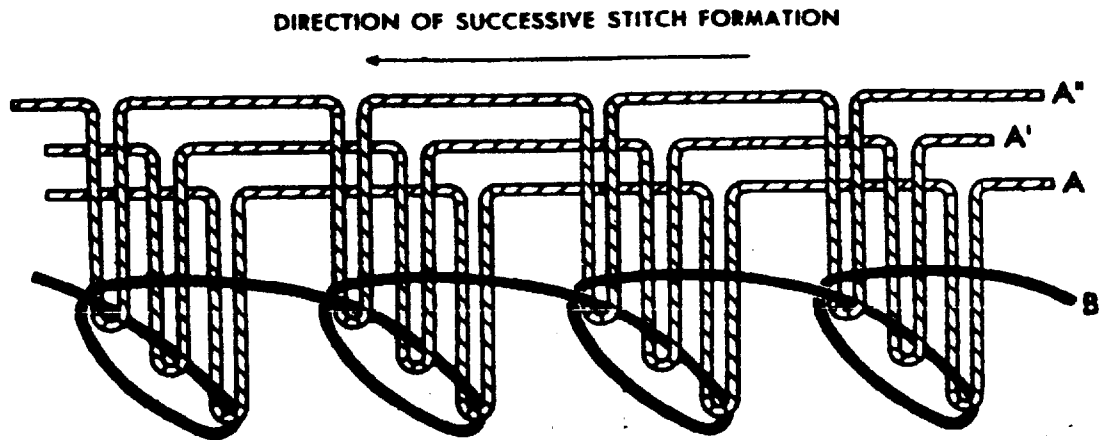

Stitch type 303

This type of stitch shall be formed with four threads: three needle threads, A and A' and A'', and one bobbin thread, B. Loops of threads A,

A' and A'' shall be passed through the material and interlaced with thread B. The interlacings shall be on the underside of the material.

7

Stitch Type 304  
January 25, 1965

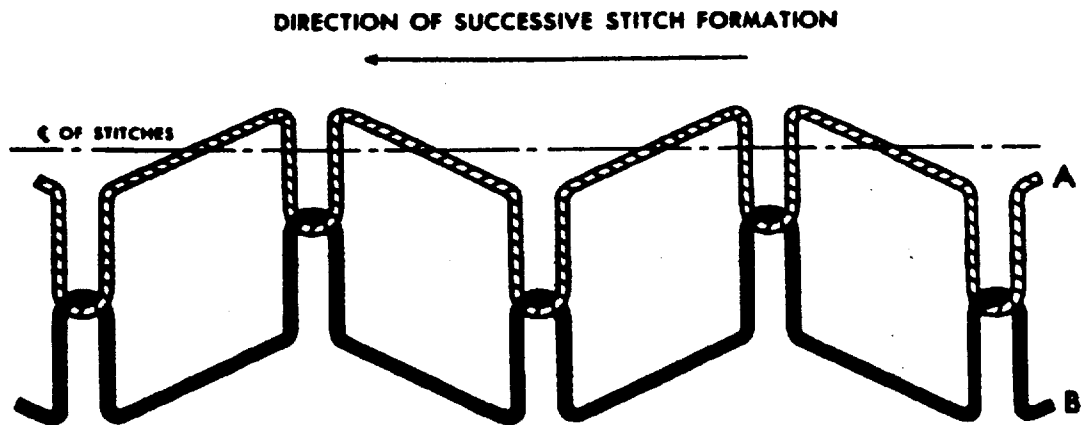

Stitch type 304

This type of stitch shall be formed with two threads: one needle thread, A, and one bobbin thread, B. This stitch type is exactly the same

as stitch type 301 except that successive single stitches form a symmetrical zigzag pattern.

FED. STD. NO. 751a

2

**Stitch Type 305**  
**January 25, 1965**

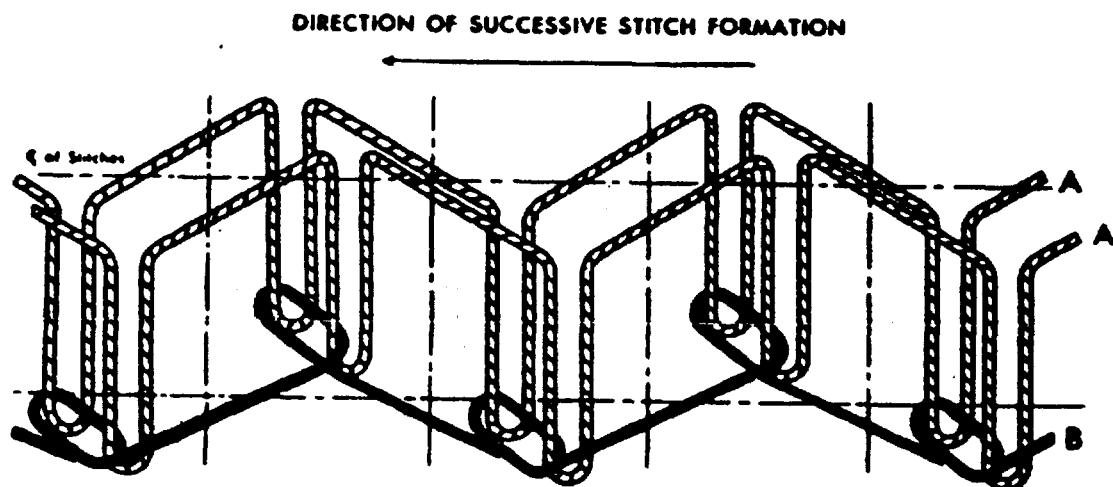

**Stitch type 305**

This type of stitch shall be formed with three threads: two needle threads, A and A', and one bobbin thread, B. Loops of threads A and A' shall be passed through the material and inter-

laced with thread B and the interlacing shall be left on the underside of the material. Successive single stitches form a symmetrical zig-zag pattern.

**Stitch Type 306**  
**January 25, 1965**

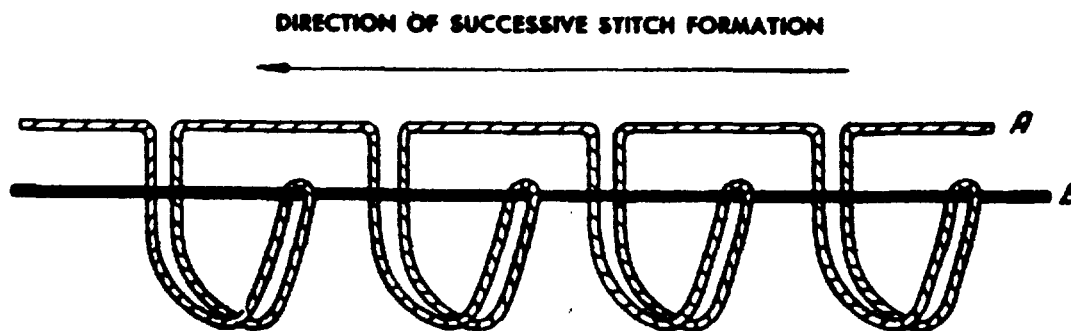

**Stitch type 306**

This type of stitch shall be formed with two threads: one needle thread, A, and one bobbin thread, B. Loops of thread A shall be passed through the top ply of material and horizon-

tally through portions of the bottom ply without penetrating it the full depth and shall be interlaced with thread B on the top surface of the bottom ply of material.

**Stitch Type 307**  
January 25, 1965

DIRECTION OF SUCCESSIVE STITCH FORMATION

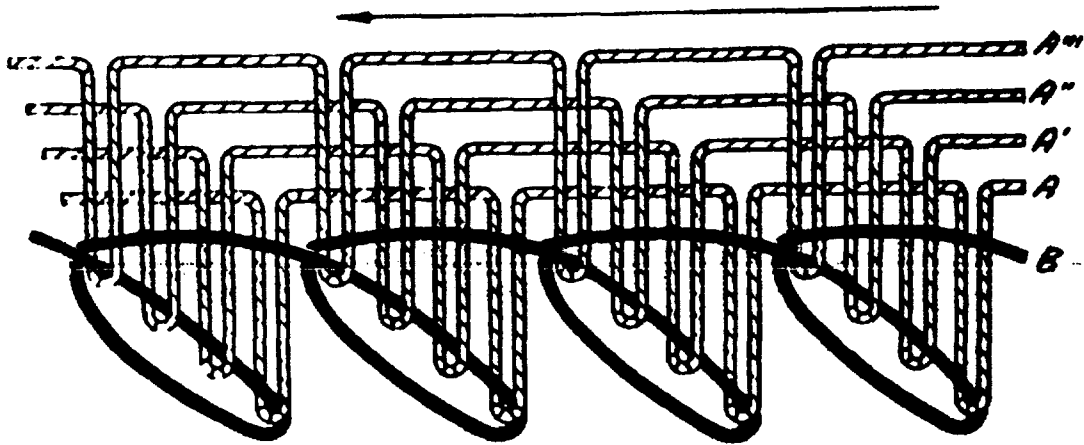

**Stitch type 307**

This type of stitch shall be formed with five threads: four needle threads, A, A', A'', A''', and one bobbin thread, B. Loops of threads A,

A', A'', A''', shall be passed through the material and interlaced with thread B. The interlacings shall be on the underside of the material.

**Stitch Type 308**  
January 25, 1965

DIRECTION OF SUCCESSIVE STITCH FORMATION

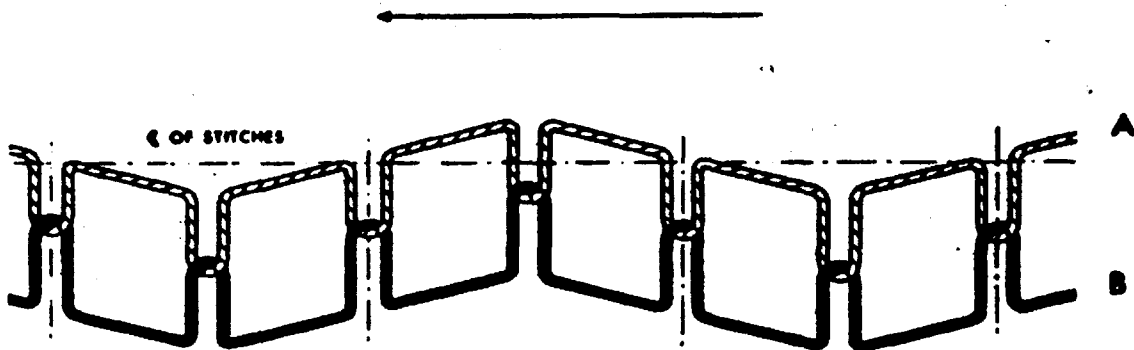

**Stitch type 308**

This type of stitch shall be formed with two threads: one needle thread, A, and one bobbin thread, B. This stitch type is the same as

stitch type 304 except that successive pairs of stitches form a symmetrical zigzag pattern.

FED. STD. NO. 751a



Stitch Type 309  
January 25, 1965

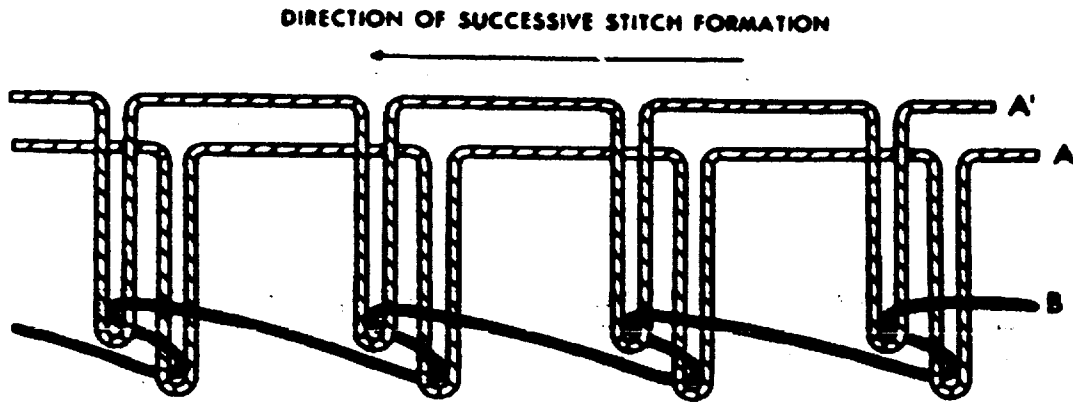

Stitch type 309

This type of stitch shall be formed with three threads; two needle threads, A and A', and one bobbin thread, B. Loops of threads

A and A' shall be passed through the material and interlaced with thread B. The interlacings shall be left on the underside of the material.

Stitch Type 310  
January 25, 1965

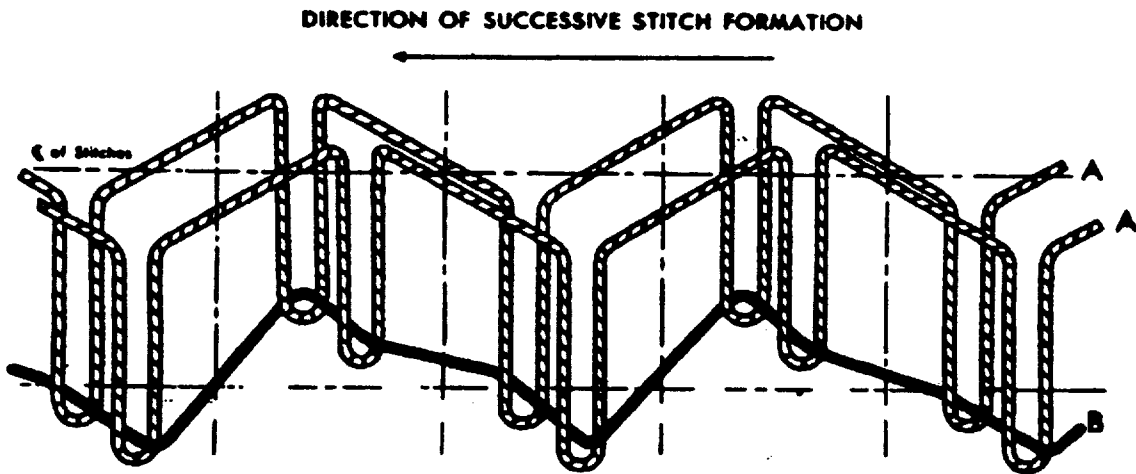

Stitch type 310

This type of stitch shall be formed with three threads: two needle threads, A and A', and one bobbin thread, B. Loops of threads A and A' shall be passed through the material and inter-

laced with thread B, and the interlacings shall be left on the underside of the material. Successive single stitches form a symmetrical zig-zag pattern.

95

Stitch Type 311  
January 25, 1945

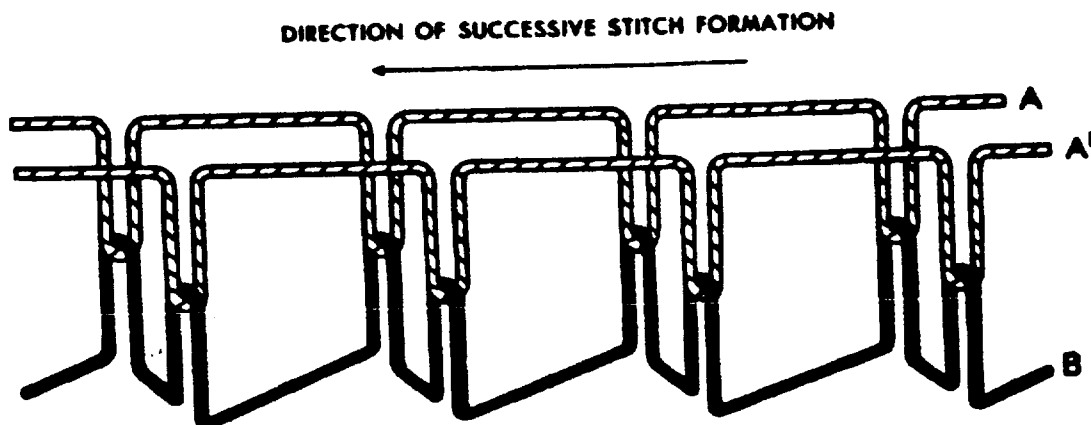

Stitch type 311

This type of stitch shall be formed with three threads: two needle threads, A and A', and one bobbin thread, B. Loops of threads A and A' shall be passed through the material and inter-

laced with thread B. Threads A and A' shall be pulled back so that the interlacings shall be midway between surfaces of the material or materials being sewn.

Stitch Type 312  
January 25, 1945

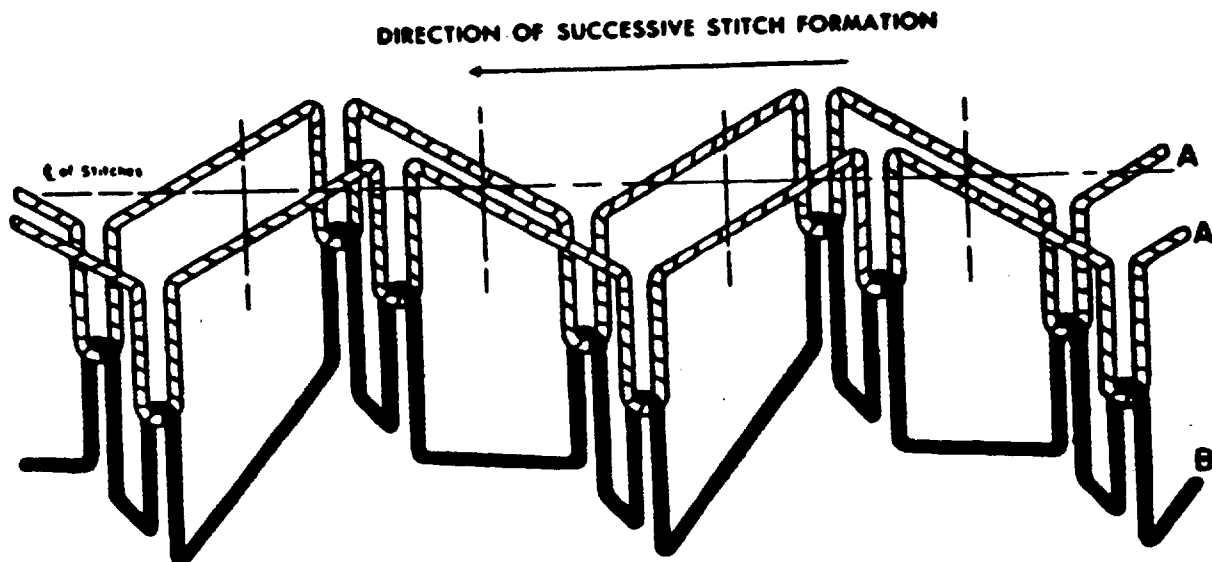

Stitch type 312

This type of stitch shall be formed with three threads: two needle threads, A and A', and one bobbin thread, B. This stitch type is exactly

the same as stitch type 311 except that successive single stitches form a symmetrical zig-zag pattern.

FED. STD. NO. 751a

Stitch Type 313  
January 25, 1965

DIRECTION OF SUCCESSIVE STITCH FORMATION

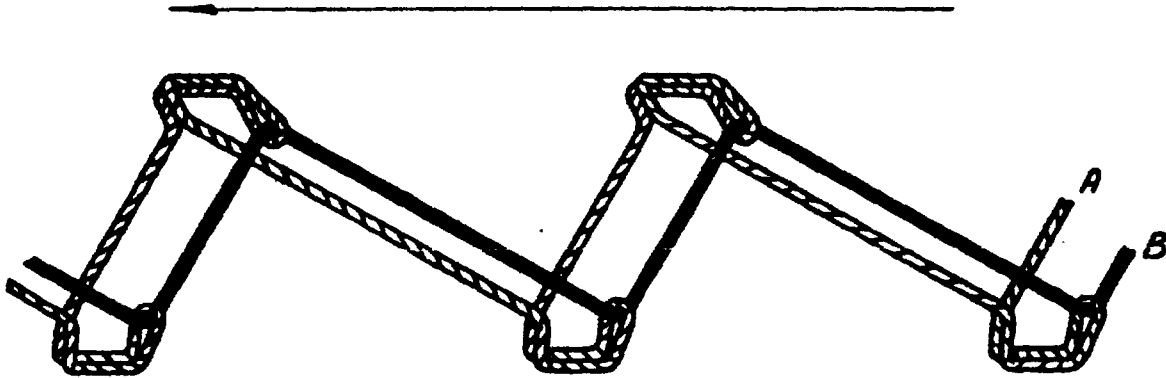

Stitch type 313

This type of stitch shall be formed with two threads: one needle thread, A, and one bobbin thread, B. Loops of thread A shall be passed horizontally through portions of both plies of

material without penetrating the full depth, and shall be interlaced with thread B on the top of the material.

38

Stitch Type 314  
January 25, 1965

DIRECTION OF SUCCESSIVE STITCH FORMATION

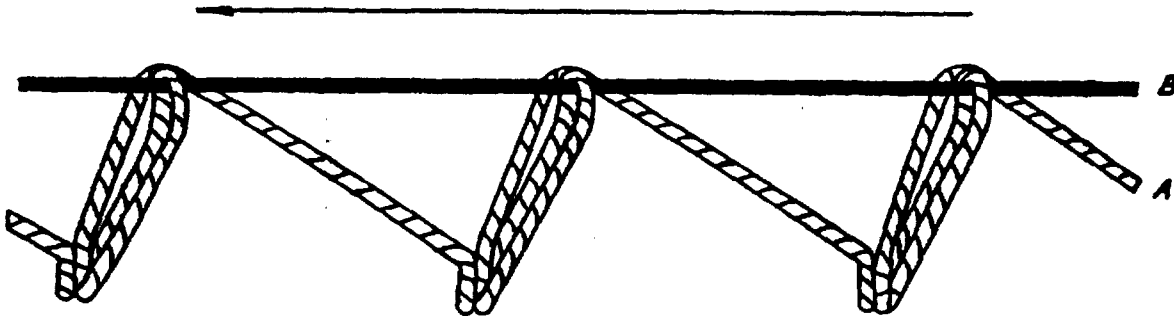

Stitch type 314

This type of stitch shall be formed with two threads: one needle thread, A, and one bobbin thread, B. Loops of thread A shall be passed through the top ply of material and horizon-

tally through portions of the bottom ply without penetrating the full depth and shall be interlaced with thread B on the top of the material.

Stitch Type 401  
January 25, 1935

DIRECTION OF SUCCESSIVE STITCH FORMATION

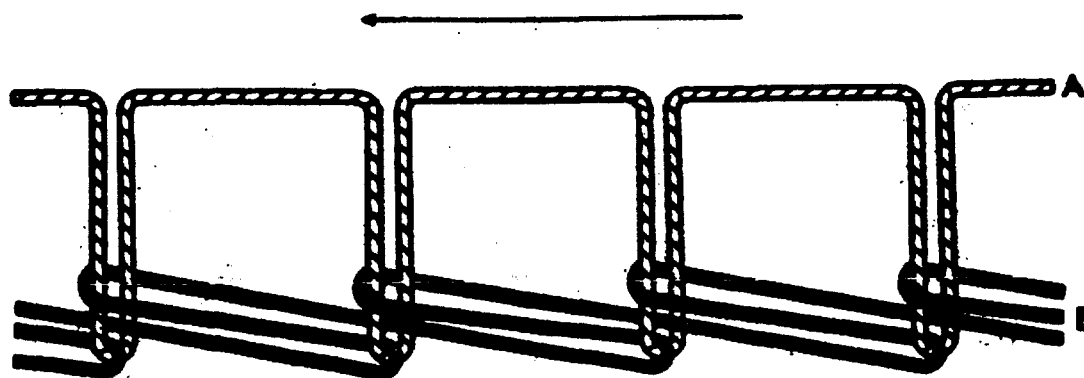

Stitch type 401

This type of stitch shall be formed with two threads: one needle thread, A, and one looper thread, B. Loops of thread A shall be passed through the material and interlaced and inter-

looped with loops of thread B. The interloopings shall be drawn against the underside of the bottom ply of material.

Stitch Type 402  
January 25, 1935

DIRECTION OF SUCCESSIVE STITCH FORMATION

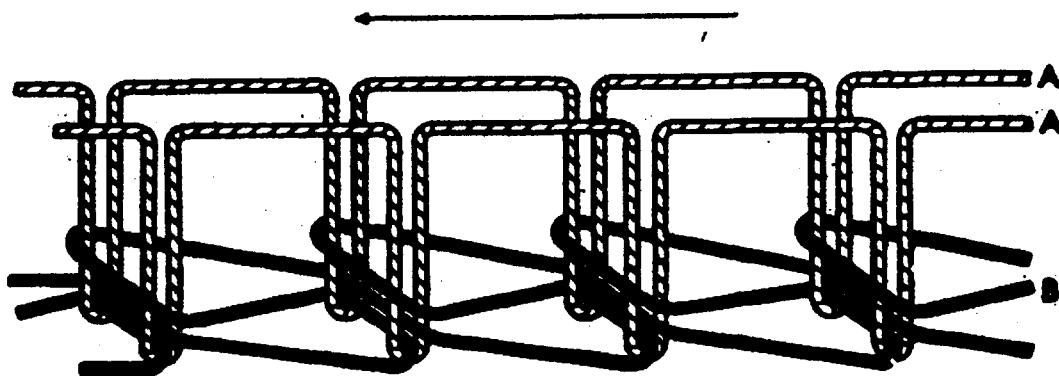

Stitch type 402

This type of stitch shall be formed with three threads: two needle threads A and A' and one looper thread, B. Loops of threads A and A' shall be passed through the material and inter-

laced and interlooped with loops of thread B. The interloopings shall be drawn against the underside of the material.

FED. STD. NO. 751a

**Stitch Type 403**  
**January 25, 1965**

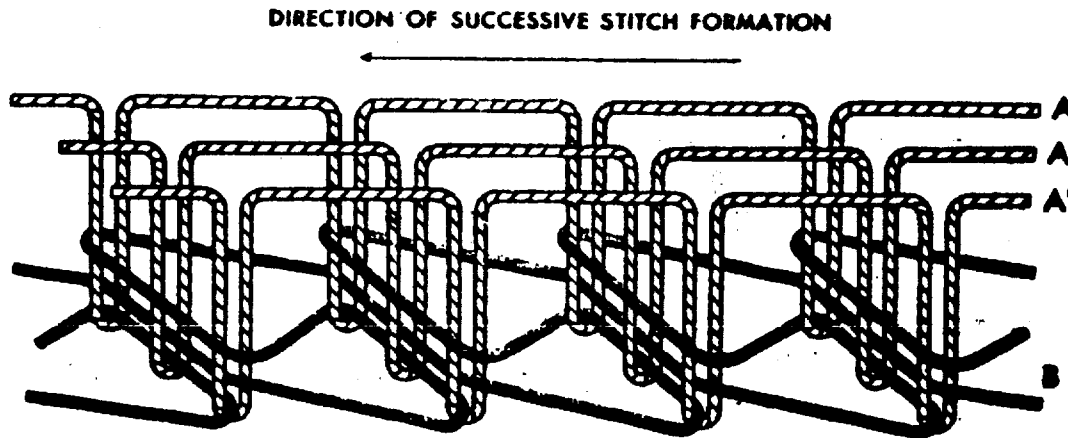

**Stitch type 403**

This type of stitch shall be formed with four threads: three needle threads, A, A' and A'' and one looper thread, B. Loops of threads A, A' and A'' shall be passed through the ma-

terial and interlaced and interlooped with loops of thread B. The interloopings shall be drawn against the underside of the material.

403

**Stitch Type 404**  
**January 25, 1965**

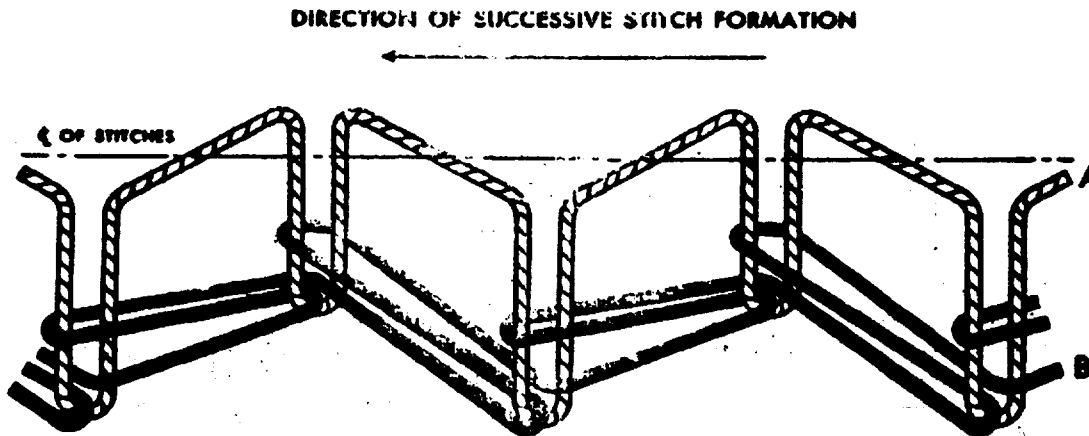

**Stitch type 404**

This type of stitch shall be formed with two threads: one needle thread, A, and one looper thread, B. This stitch is the same as stitch

type 401 except that successive single stitches form a symmetrical zigzag pattern.

Stitch Type 405  
January 25, 1965

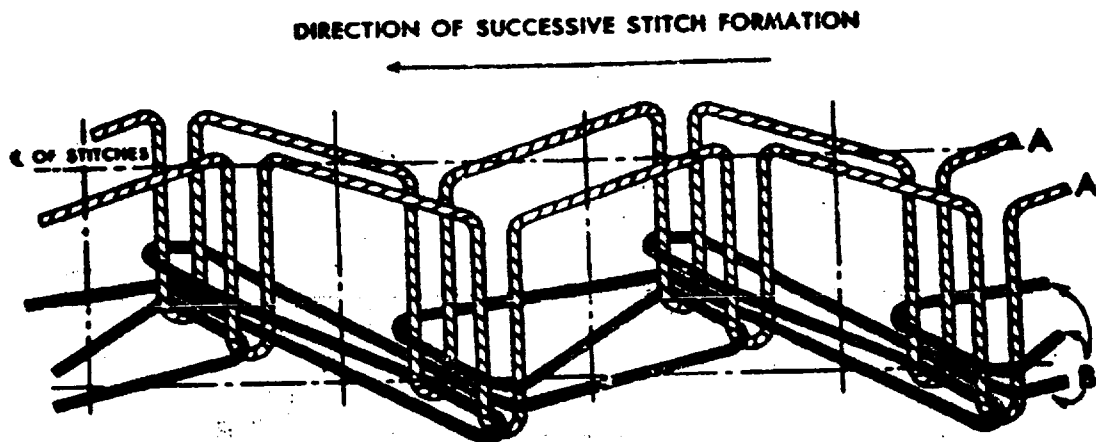

Stitch type 405

This type of stitch shall be formed with three threads: two needle threads, A and A', and one looper thread, B. This stitch is the

same as stitch type 402 except that successive stitches form a symmetrical zigzag pattern.

Stitch Type 406  
January 25, 1965

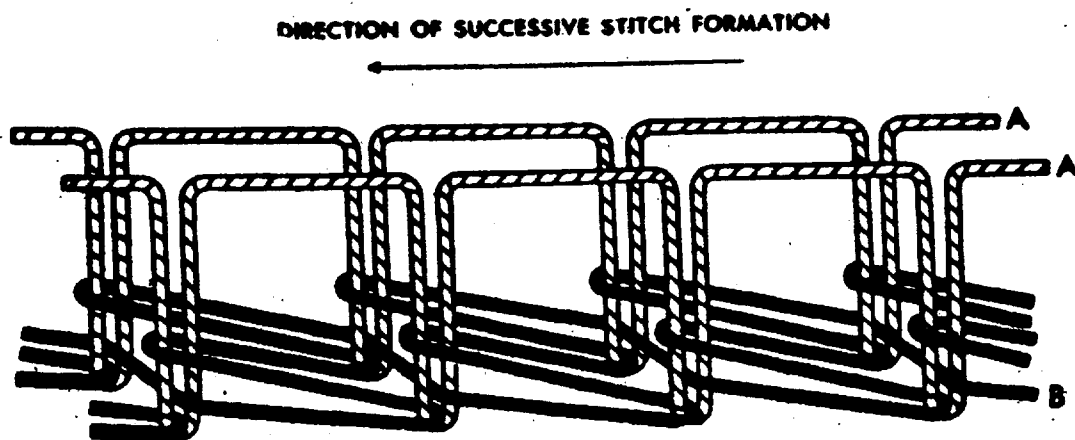

Stitch type 406

This type of stitch shall be formed with three threads: two needle threads, A and A' and one looper thread, B. Loops of threads A and A' shall be passed through the material and

interlaced and interlooped with loops of thread B. The interloopings shall be drawn against the underside of the material.

FED. STD. NO. 151a

Stitch Type 407  
January 25, 1965

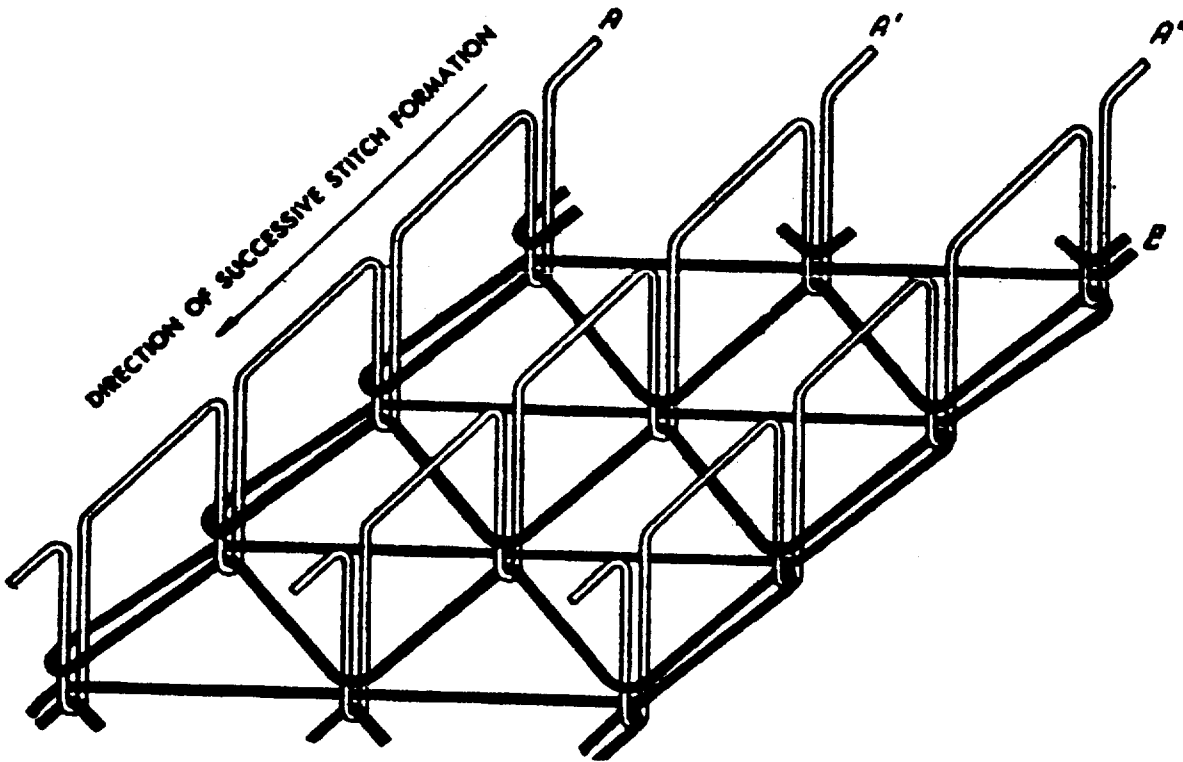

Stitch type 407

This type of stitch shall be formed with four threads: three needle threads A, A', and A'' and one looper thread, B. Loops of threads

A, A', and A'' shall be passed through the material and shall be drawn against the underside of the material.

**Stitch Type 501**  
**January 25, 1965**

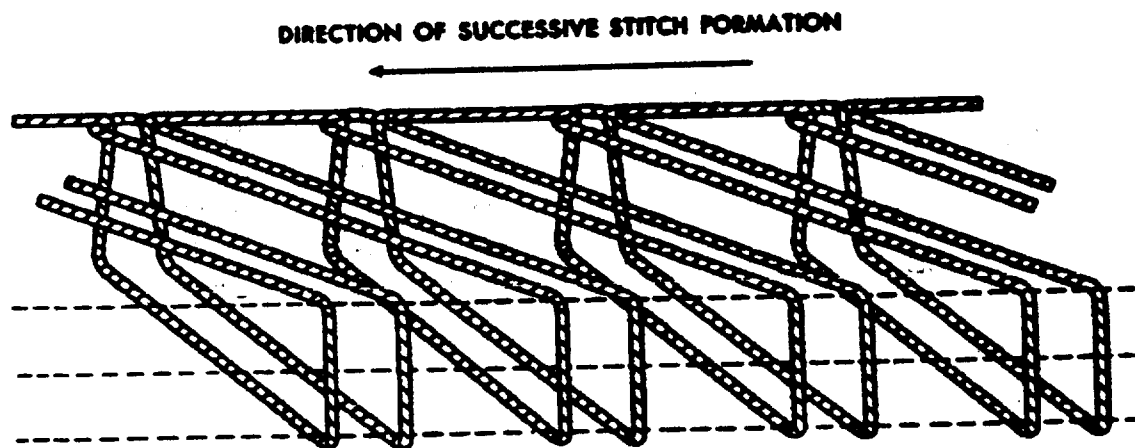

**Stitch type 501**

This type of stitch shall be formed with one needle thread which shall be passed through and around the edge of the material as a loop

and interlooped with itself at the point of needle penetration of the stitch on the surface of the material.

**Stitch Type 502**  
**January 25, 1965**

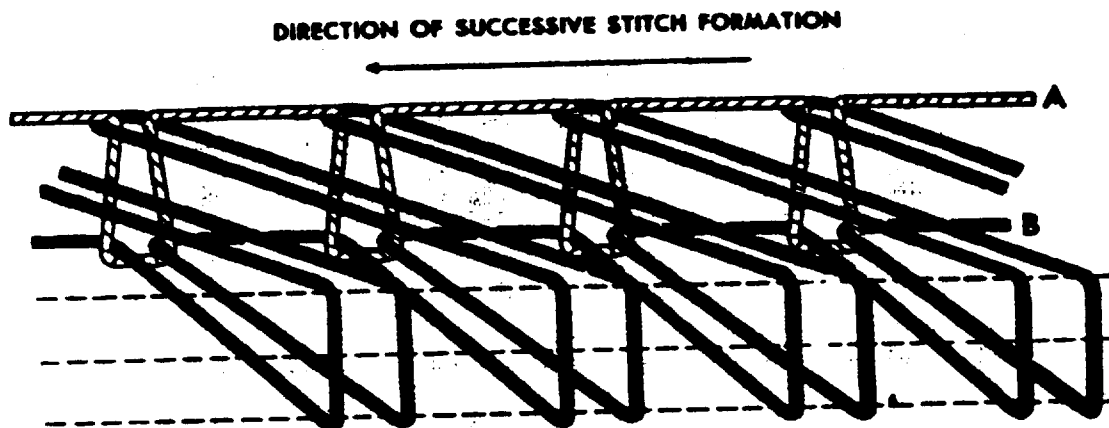

**Stitch type 502**

This type of stitch shall be formed with two threads: one needle thread, A, and one looper thread, B. Loops of thread A shall be passed through the material and interlooped with thread B at the point of penetration on the

underside of the material. Loops of thread B shall be brought around the edge of the material and interlooped with thread A at the next stitch on the surface of the material.



Stitch Type 503  
January 25, 1965

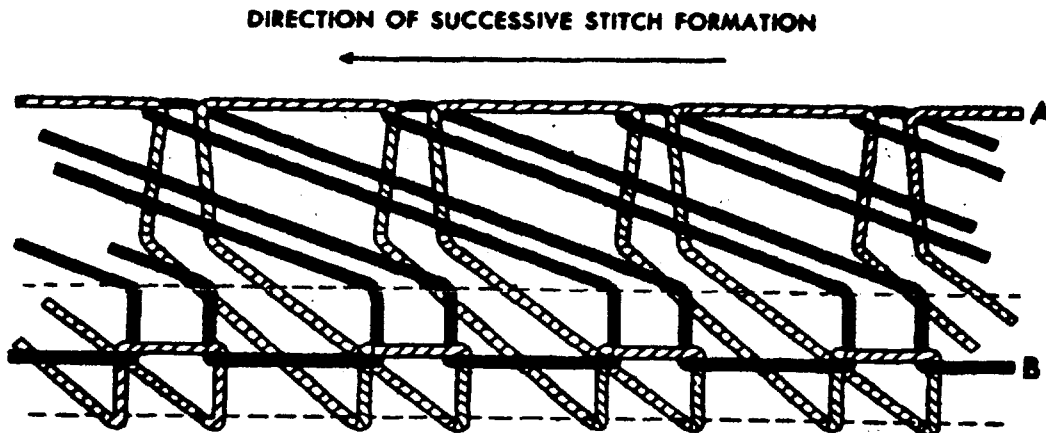

Stitch type 503

This type of stitch shall be formed with two threads: one needle thread, A, and one looper thread, B. Loops of thread A shall be passed through the material and brought to the edge where they shall be interlooped with thread B.

The loops of thread B shall be extended from this interlooping to the point of needle penetration of the next stitch and there interlooped with thread A.

Stitch Type 504  
January 25, 1965

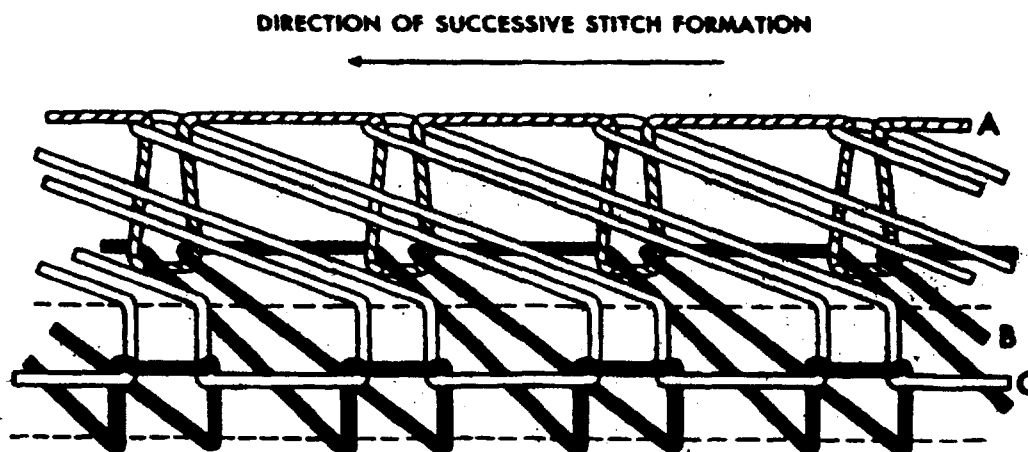

Stitch type 504

This type of stitch shall be formed with three threads: one needle thread, A; one looper thread, B; and one cover thread, C. Loops of thread A shall be passed through the material and interlooped with loops of thread B at the point of penetration on the underside of the

material. The loops of thread B shall be extended to the edge of the material and there interlooped with loops of thread C. Loops of thread C shall be extended from this interlooping to the point of needle penetration of the next stitch and there interlooped with thread A.

**Stitch Type 505**  
**January 25, 1965**

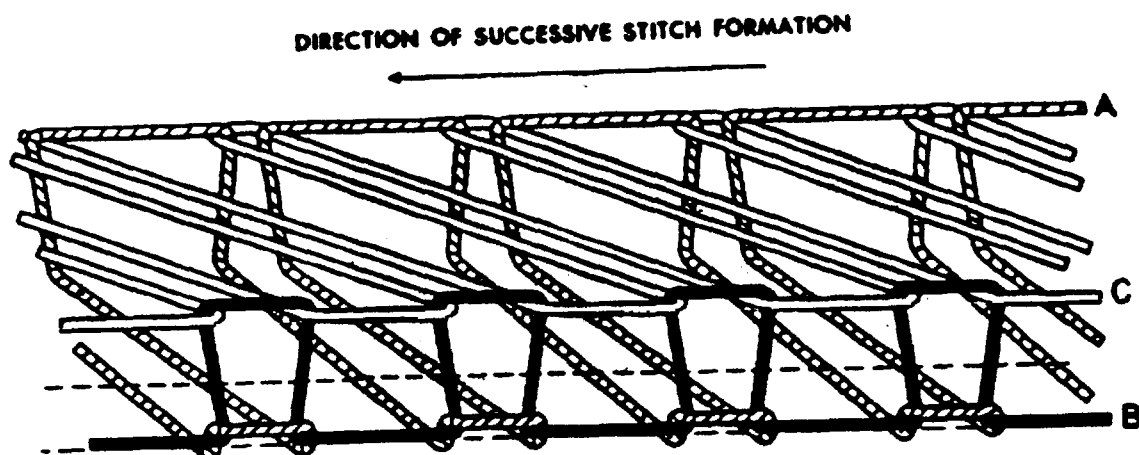

**Stitch type 505**

This type of stitch shall be formed with three threads: one needle thread, A; one looper thread, B; and one cover thread, C. Loops of thread A shall be passed through the material and extended to the edge where they shall be interlooped with loops of thread B. The loops

of thread B shall be brought up to the top edge of the material and there interlooped with loops of thread C. The loops of thread C shall be extended to the point of needle penetration of the next stitch and there interlooped with thread A.

Stitch Type 506  
January 25, 1963

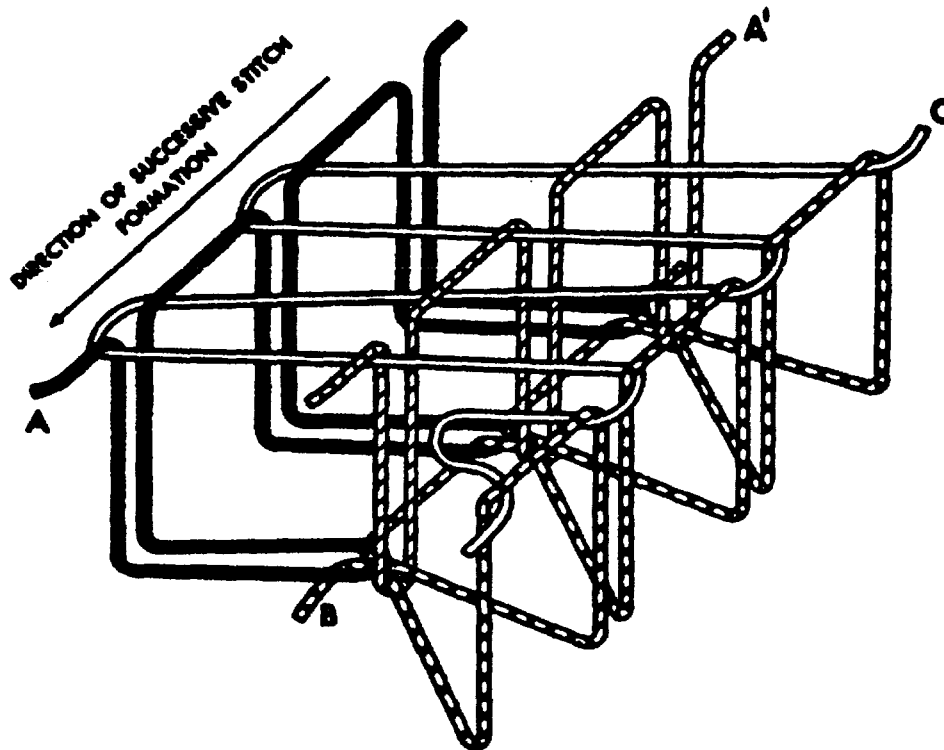

Stitch type 506

This type of stitch shall be formed with four threads: two needle threads, A and A'; one looper thread, B; and one cover thread, C. Loops of threads A and A' shall be passed through the material and the loops of thread A shall be extended to the point of needle penetration of the loops of thread A'. Loops of threads A and A' shall be interlooped with

loops of thread B at this point. The loops of thread B shall be brought around the edge of the material and interlooped with loops of thread C. The loops of thread C shall be extended to the point of needle penetration of threads A and A', where they shall be entered by the next stitch of those threads.

46

Stitch Type 507  
 January 25, 1965

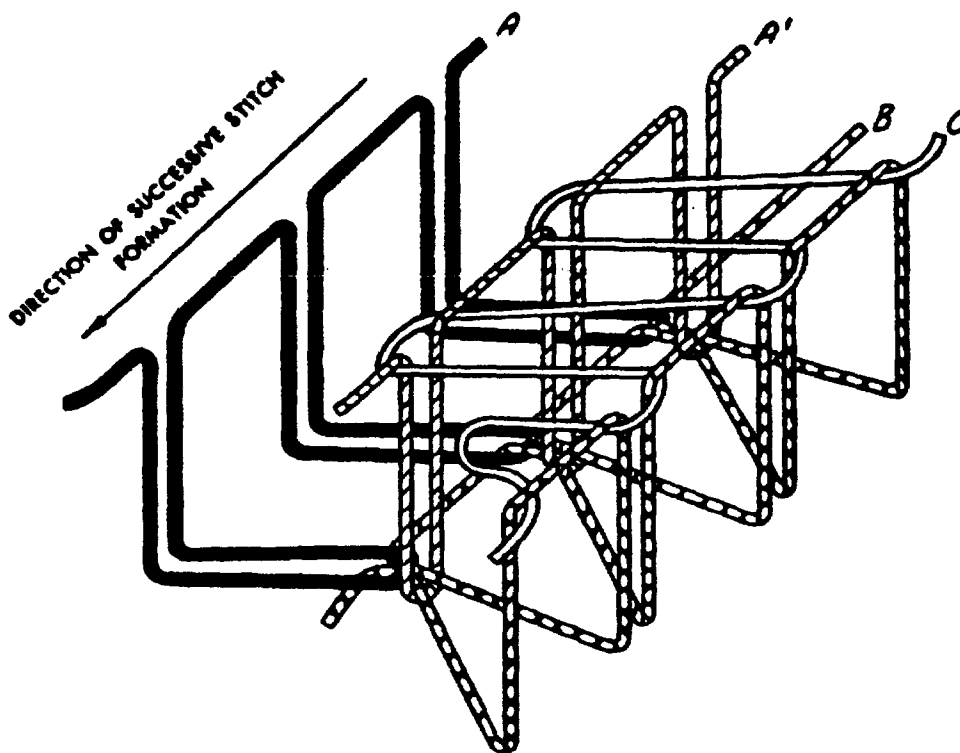

Stitch type 507

This type of stitch shall be formed with four threads: two needle threads, A and A'; one looper thread, B; and one cover thread, C. Loops of threads A and A' shall be passed through the material and the loops of thread A shall be extended to the point of needle penetration of the loops of thread A'. Loops of threads A and A' shall be interlooped with

loops of thread B at this point. The loops of thread B shall be brought around the edge and interlooped with loops of thread C. The loops of thread C shall be extended to the point of needle penetration of thread A' at the next stitch where they shall be entered by loops of that thread.

Stitch Type 508  
January 25, 1965

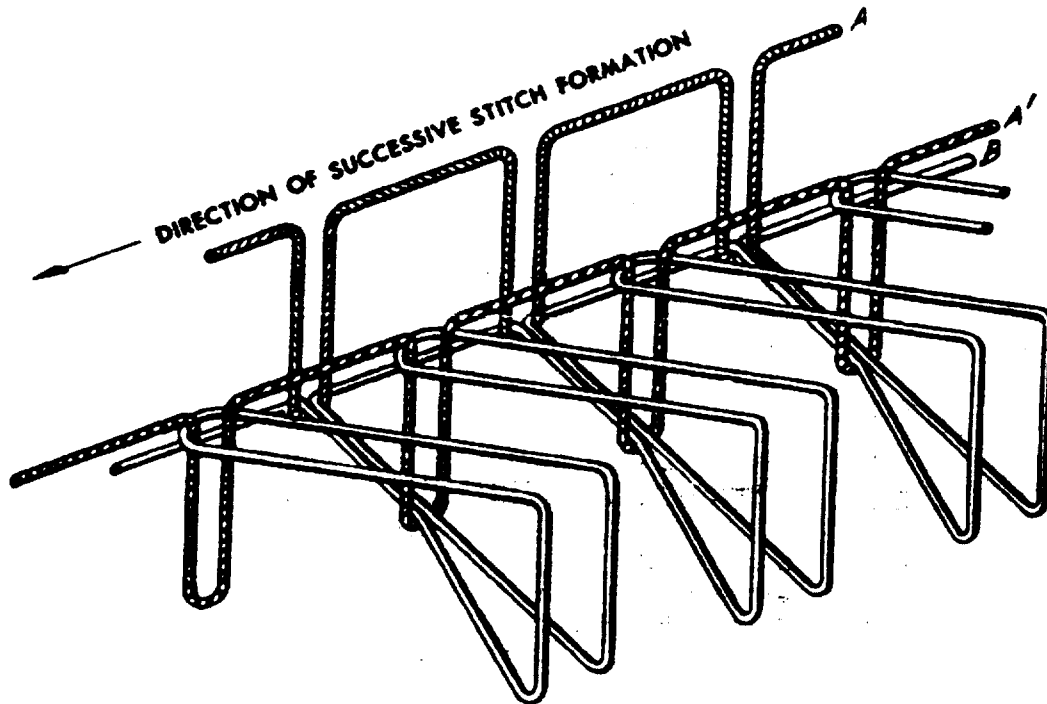

Stitch type 508

This type of stitch shall be formed with three threads: two needle threads, A and A', and one looper thread, B. Loops of threads A and A' shall be passed through the material where they shall be interlooped at the lower point

of penetration with thread B. Loops of thread B shall be brought around the edge of the material and interlooped with thread A' at the next stitch on the surface of the material.

Stitch Type 509  
January 25, 1965

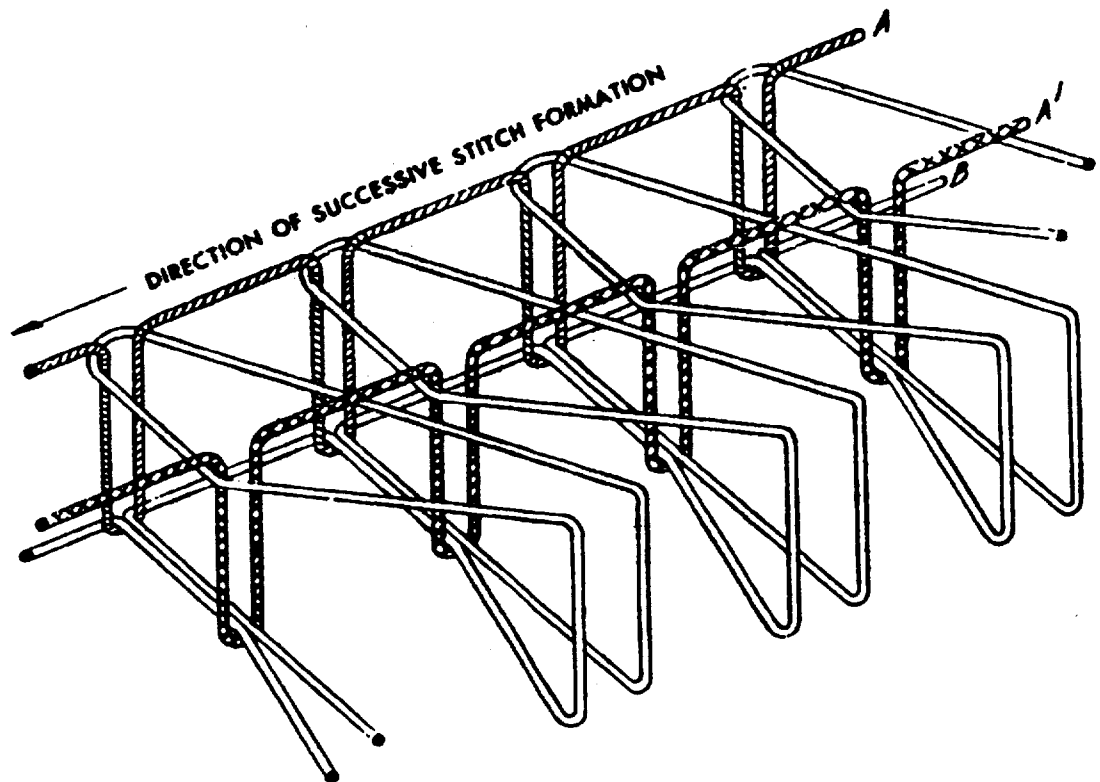

Stitch type 509

This type of stitch shall be formed with three threads: two needle threads, A and A', and one looper thread, B. Loops of threads A and A' shall be passed through the material where they shall be interlooped at the lower point of

penetration with loops of thread B. Loops of thread B shall be brought around and cast on the surface of the material where they shall be entered by loops of threads A and A'.

**Stitch Type 510**  
**January 25, 1965**

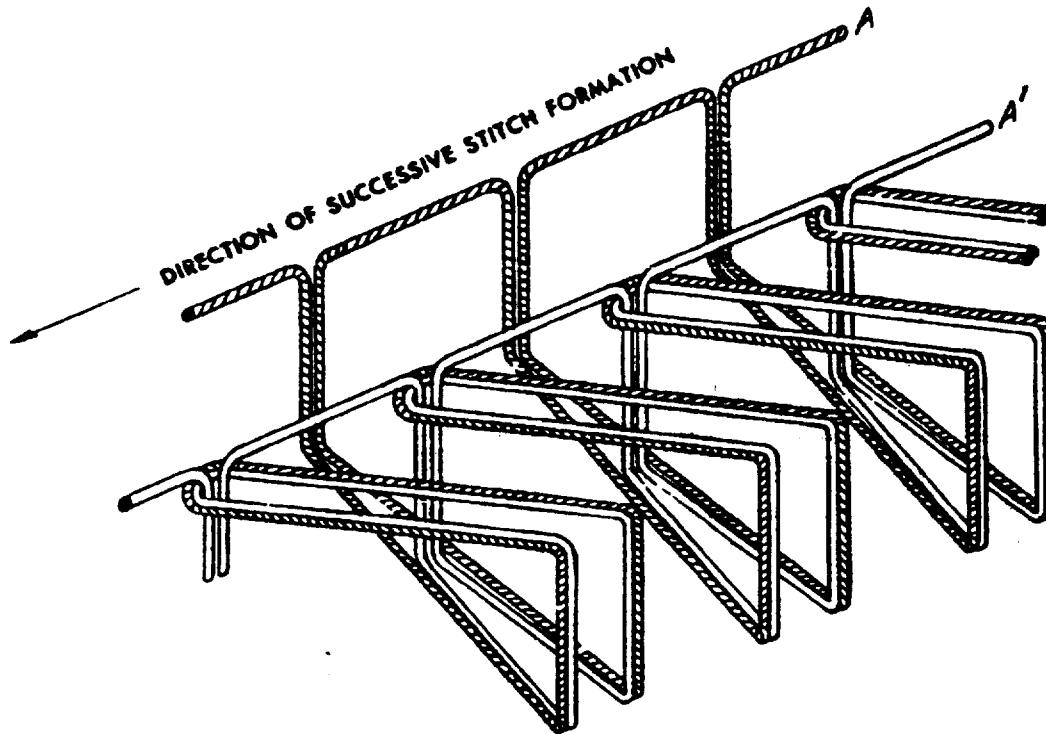

**Stitch type 510**

This type of stitch shall be formed with two needle threads, A and A', which shall be passed through and around the edge to the surface of

the material as loops and interlooped with thread A' at the point of needle penetration.

25

Stitch Type 511  
January 25, 1965

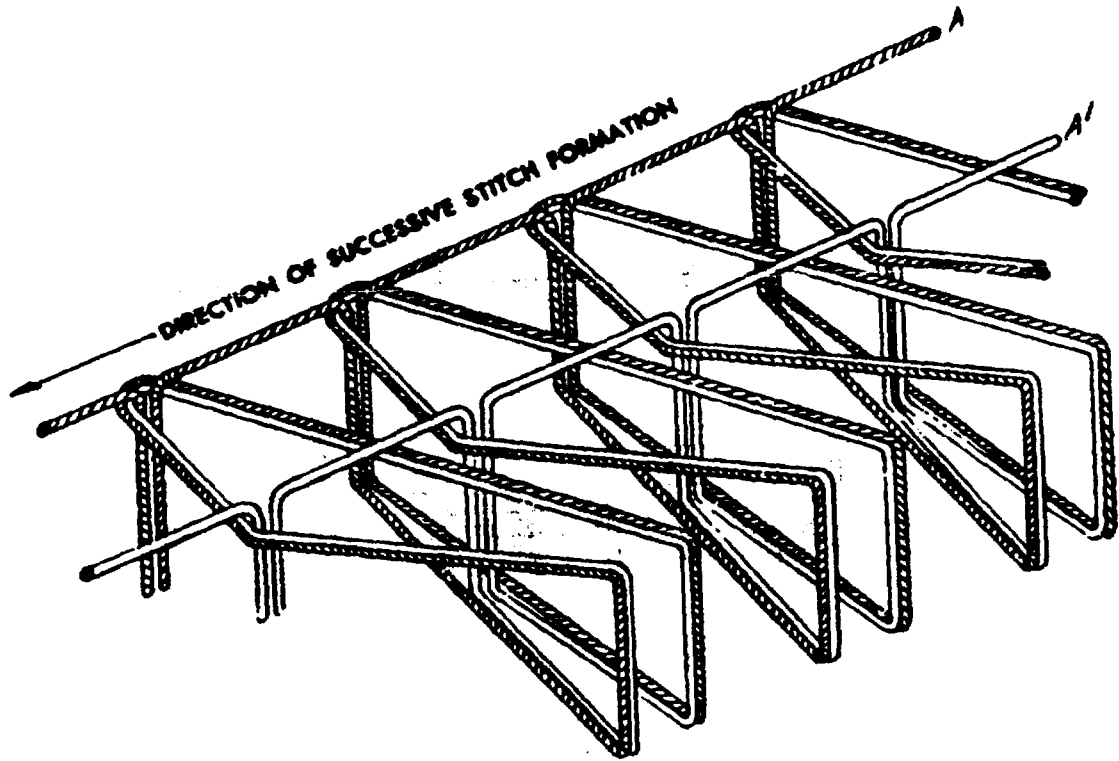

**Stitch type 511**

This type of stitch shall be formed with two needle threads, A and A'. Loops of threads A and A' shall be passed through the material, brought around the edge and cast on the upper

surface where they shall be entered by loops of themselves at the point of needle penetration of the next stitch.

FED. STD. NO. 731a



Stitch Type 512  
January 25, 1965

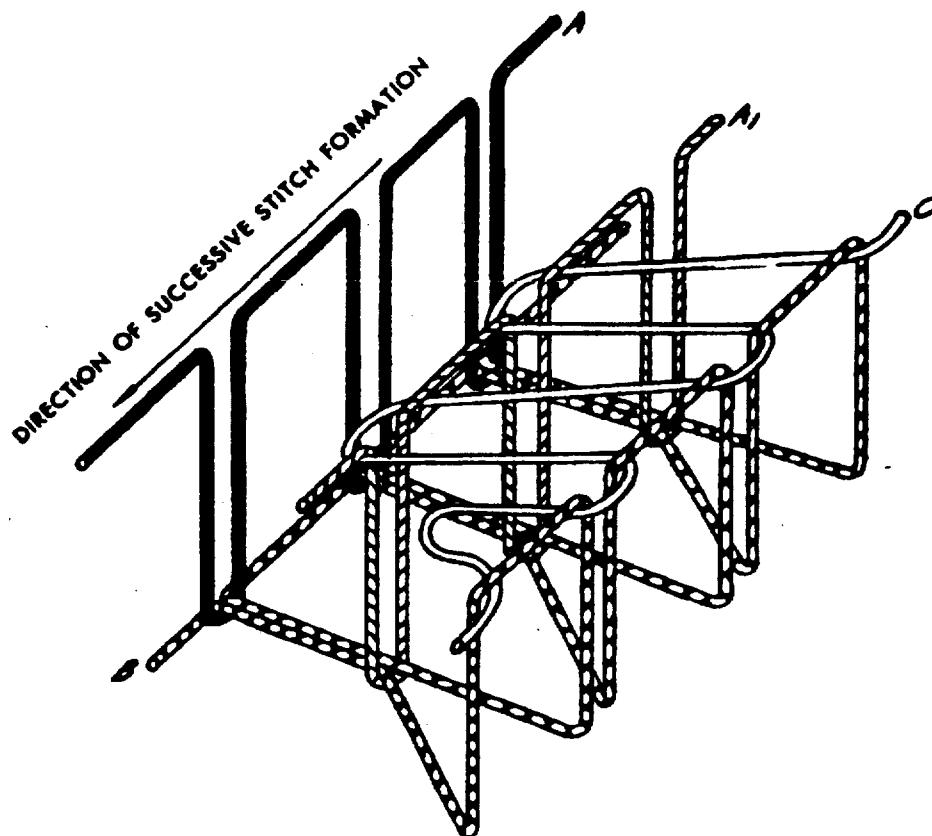

Stitch type 512

This type of stitch shall be formed with four threads: two needle threads, A and A'; one looper thread, B; and one cover thread, C. Loops of threads A and A' shall be passed through the material where they shall be inter-looped at the lower point of penetration with

thread B. The loops of thread B shall be brought around the edge and interlooped with loops of thread C. The loops of thread C shall be extended to the point of needle penetration of thread A' at the next stitch where they shall be entered by loops of that thread.

52

Stitch Type 513  
January 25, 1965

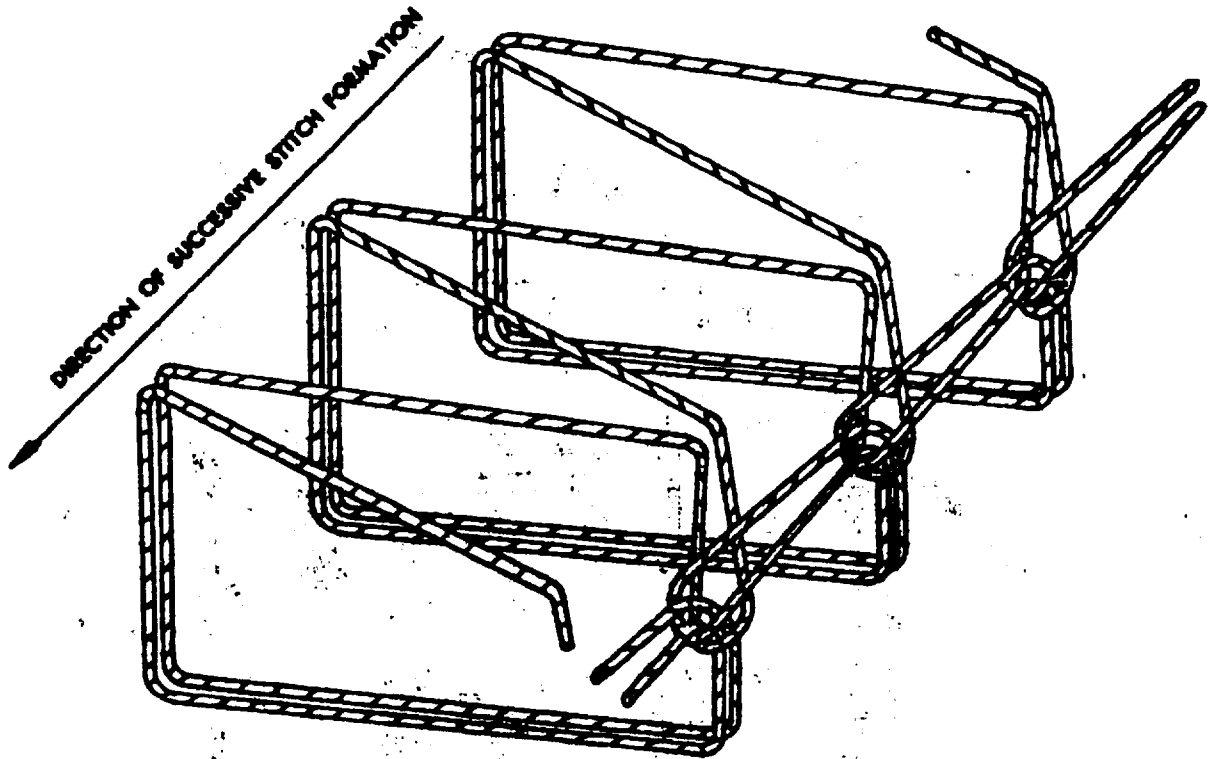

Stitch type 513

This type of stitch shall be formed with one needle thread which shall be passed through the material as a loop and brought to the edge,

where it shall be passed through a loop formed by the previous stitch and a loop which has been drawn across the upper surface of the material.

Stitch Type 514  
 January 25, 1965

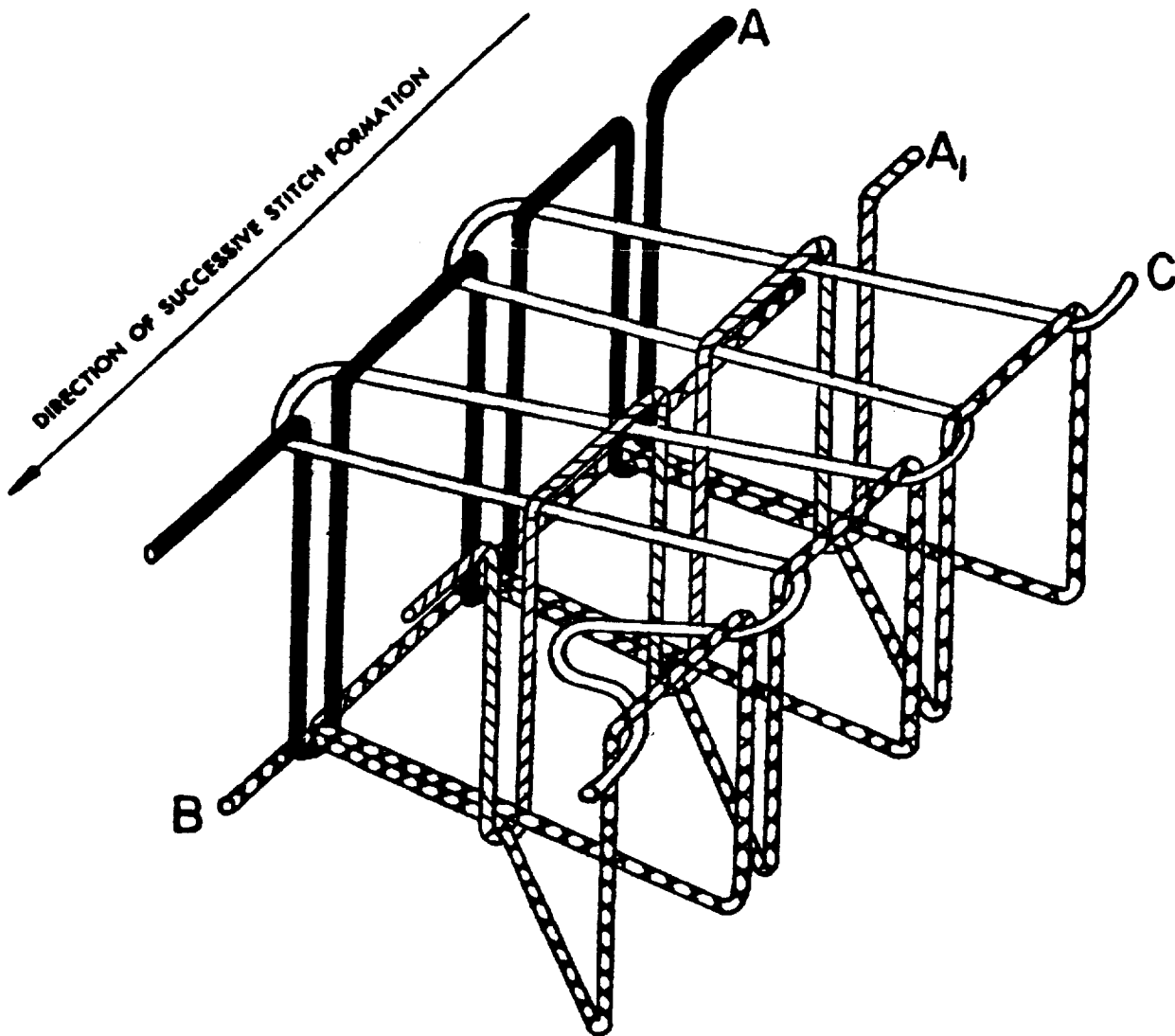

Stitch type 514

This type of stitch shall be formed with four threads: two needle threads, A and A'; one looper thread, B; and one cover thread, C. Loops of threads A and A' shall be passed through the material where they shall be interlooped at the lower point of penetration with loops of thread B. The loops of thread B shall

be brought around the edge of the material and interlooped with loops of thread C. The loops of thread C shall be extended to the point of needle penetration of threads A and A' at the next stitch where they shall be entered by loops of these threads.

**Stitch Type 515**  
**January 25, 1965**

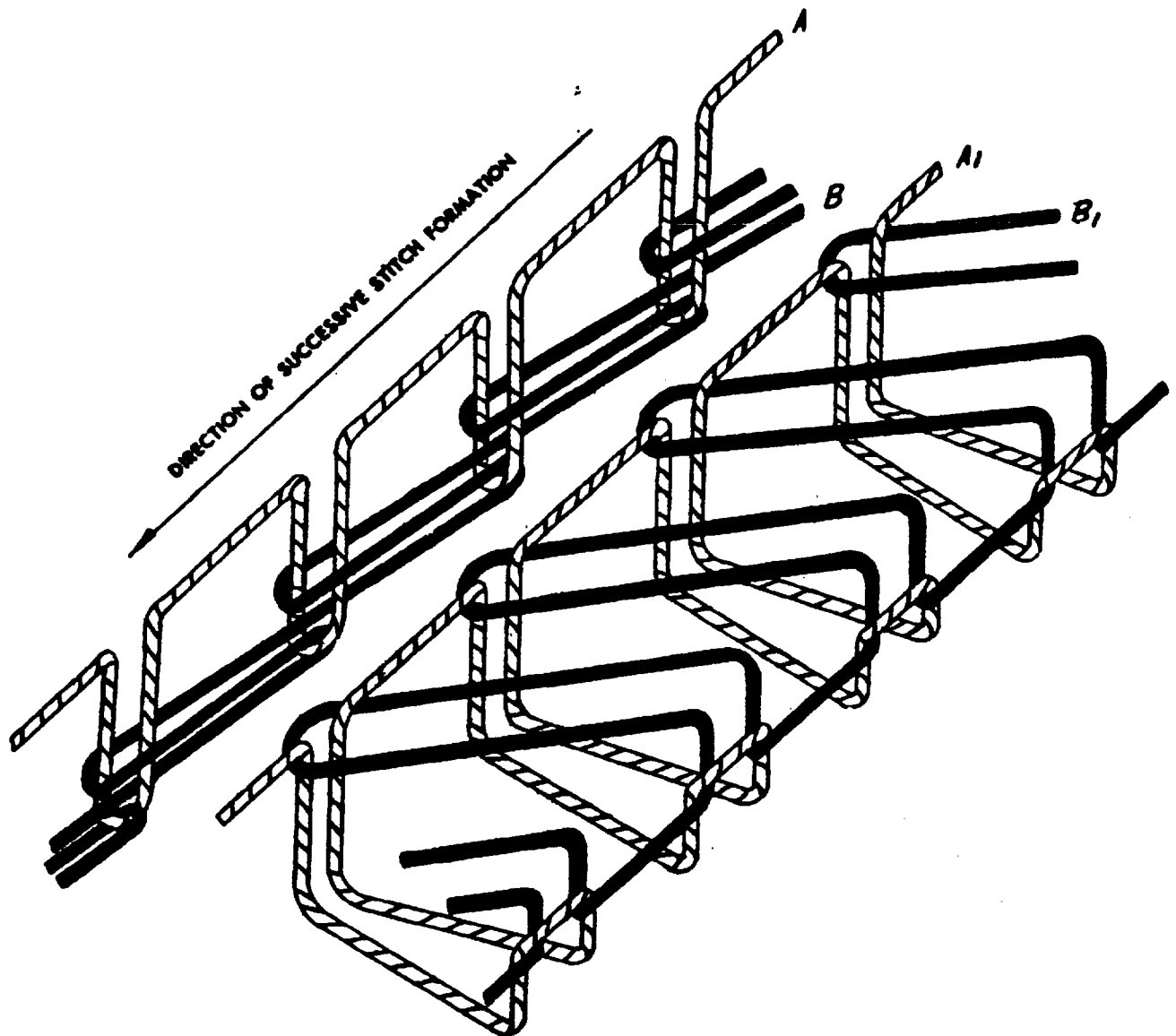

**Stitch type 515**

This type of stitch shall be formed by simultaneously sewing one row of stitch 401 a specified distance from the edge of the material, and

one row of stitch type 503 on the edge of the material.

**Stitch Type 516**  
**January 25, 1965**

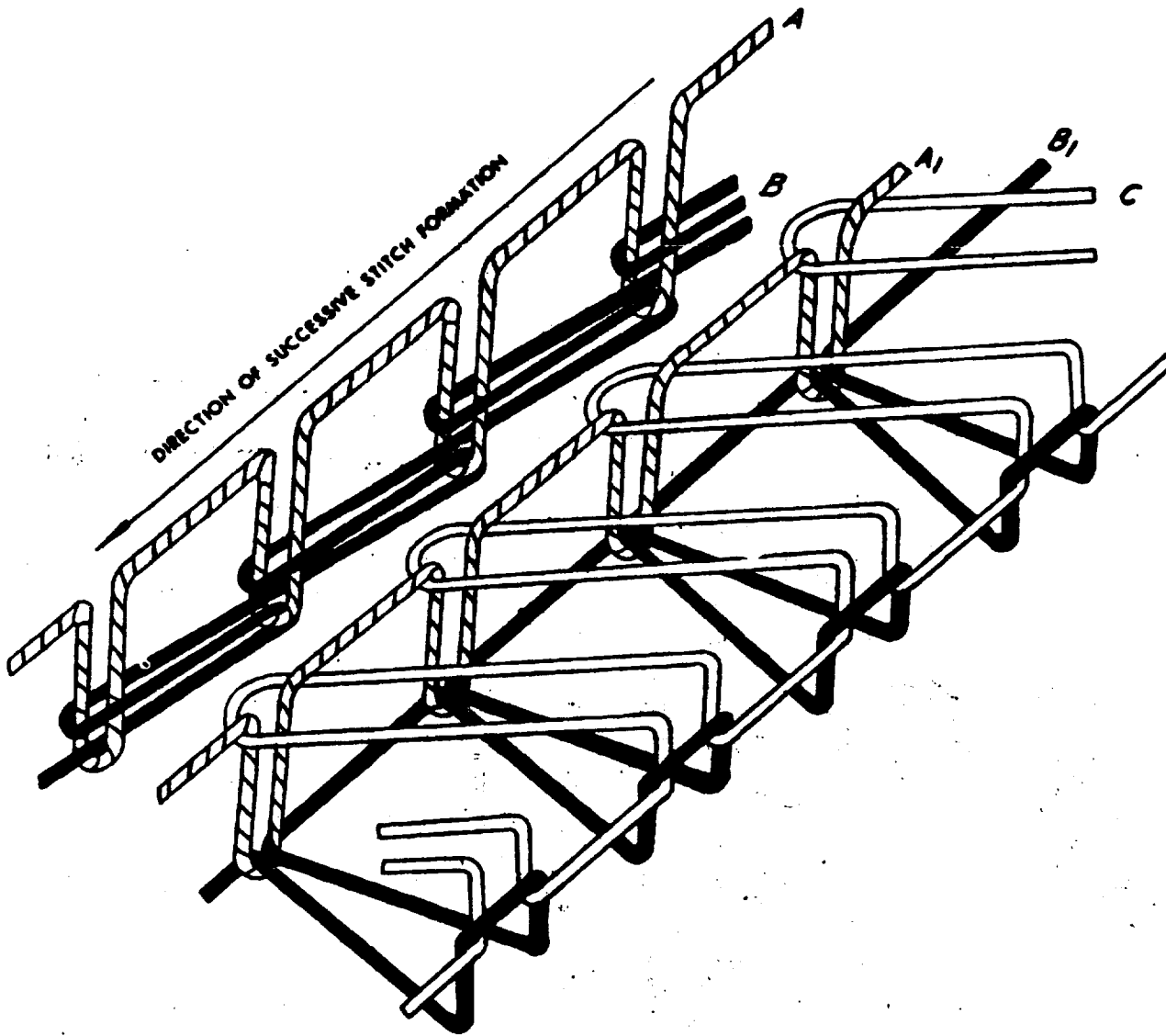

**Stitch type 516**

This type of stitch shall be formed by simultaneously sewing one row of stitch type 401 a specified distance from the edge of the material,

and one row of stitch type 504 on the edge of the material.

Stitch Type 517  
January 25, 1965

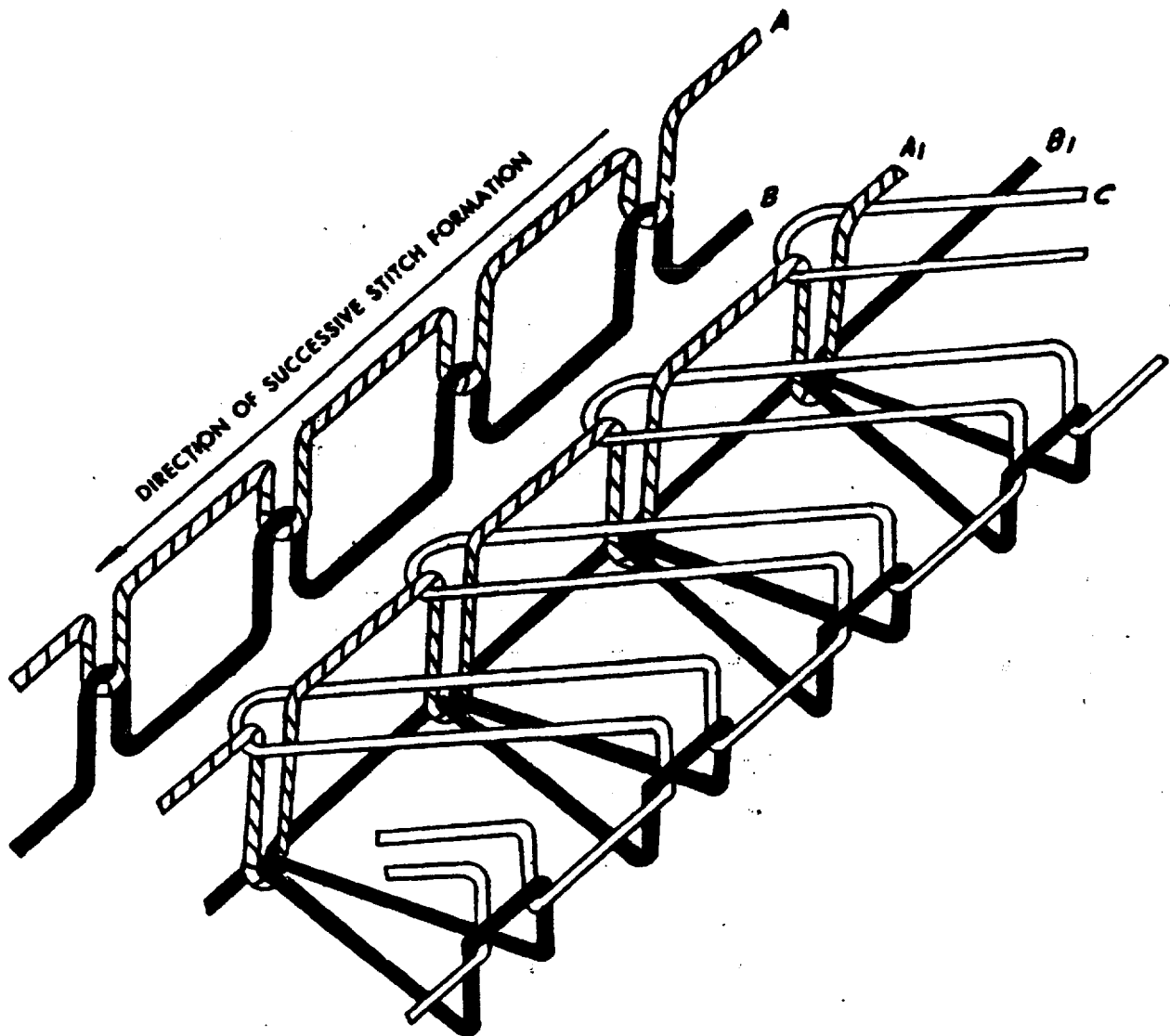

Stitch type 517

This type of stitch shall be formed by simultaneously sewing one row of stitch type 301 a specified distance from the edge of the material,

and one row of stitch type 504 on the edge of the material.

**Stitch Type 518**  
**January 25, 1966**

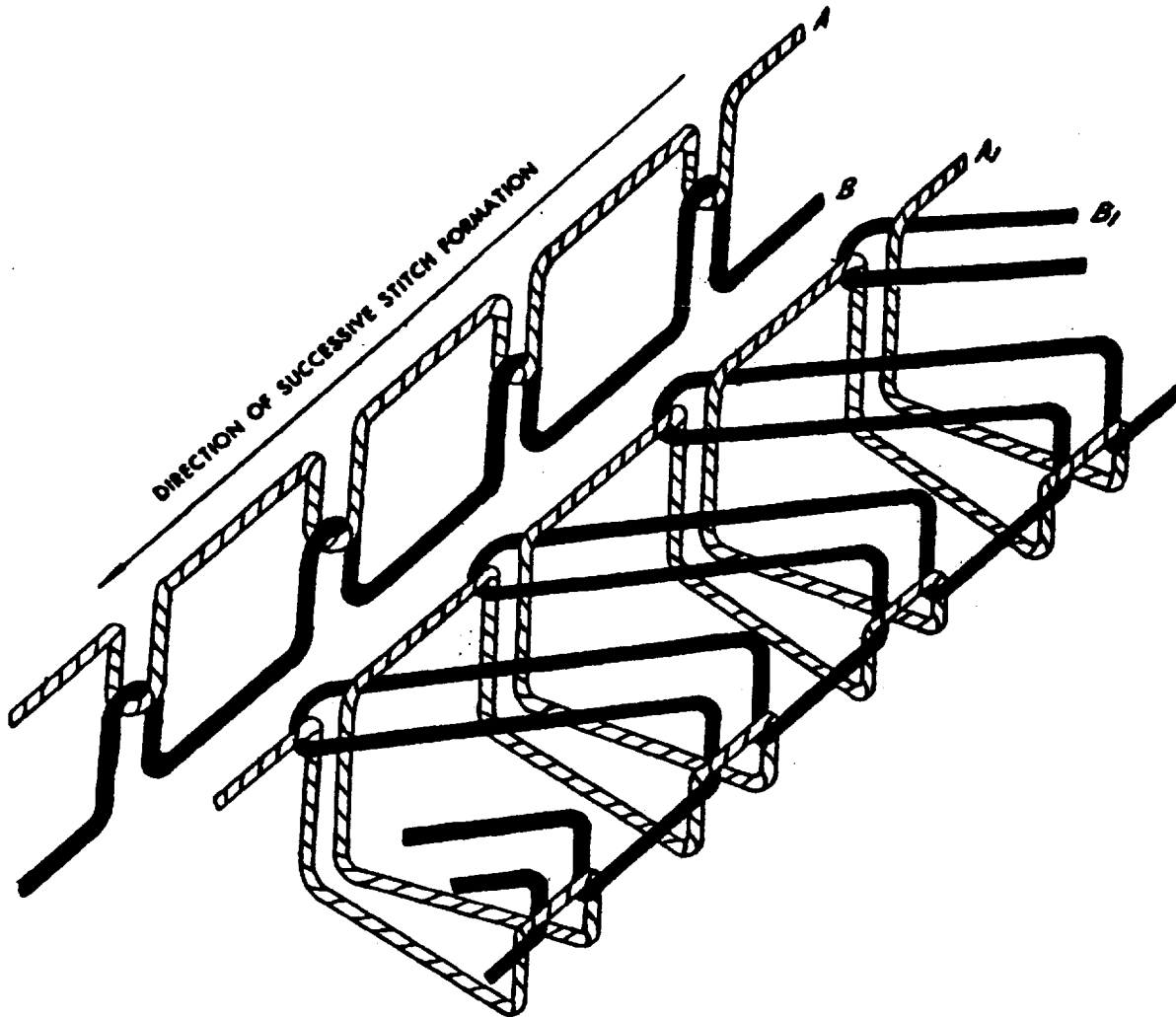

**Stitch type 518**

This type of stitch shall be formed by simultaneously sewing one row of stitch type 301 a specified distance from the edge, and one row of stitch type 508 on the edge of the material.

**Stitch Type 519**  
**January 25, 1965**

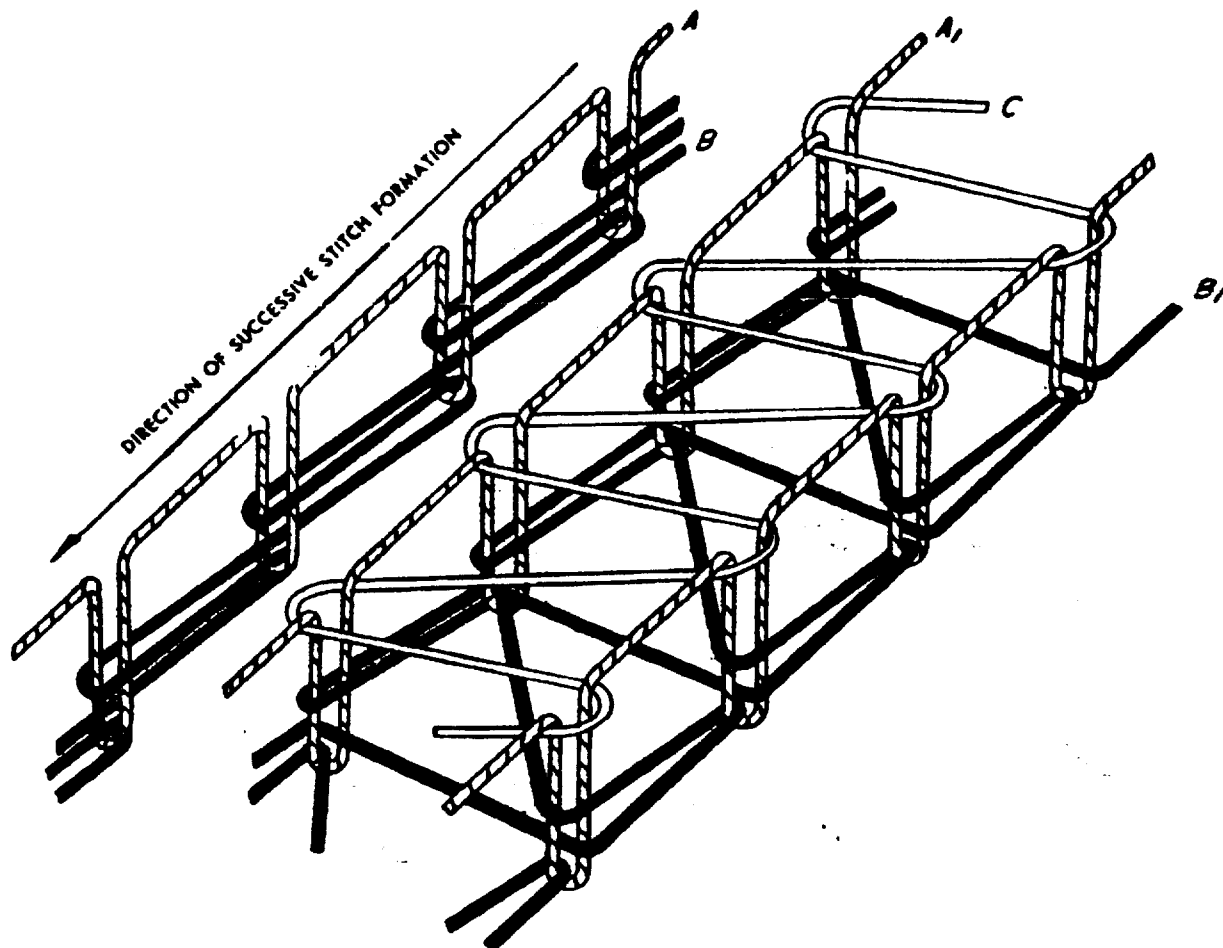

**Stitch type 519**

This type of stitch shall be formed by simultaneously sewing one row of stitch type 401 a specified distance from the edge of the material,

and one row of stitch type 602 on the edge of the material.



Stitch Type 520  
January 25, 1965

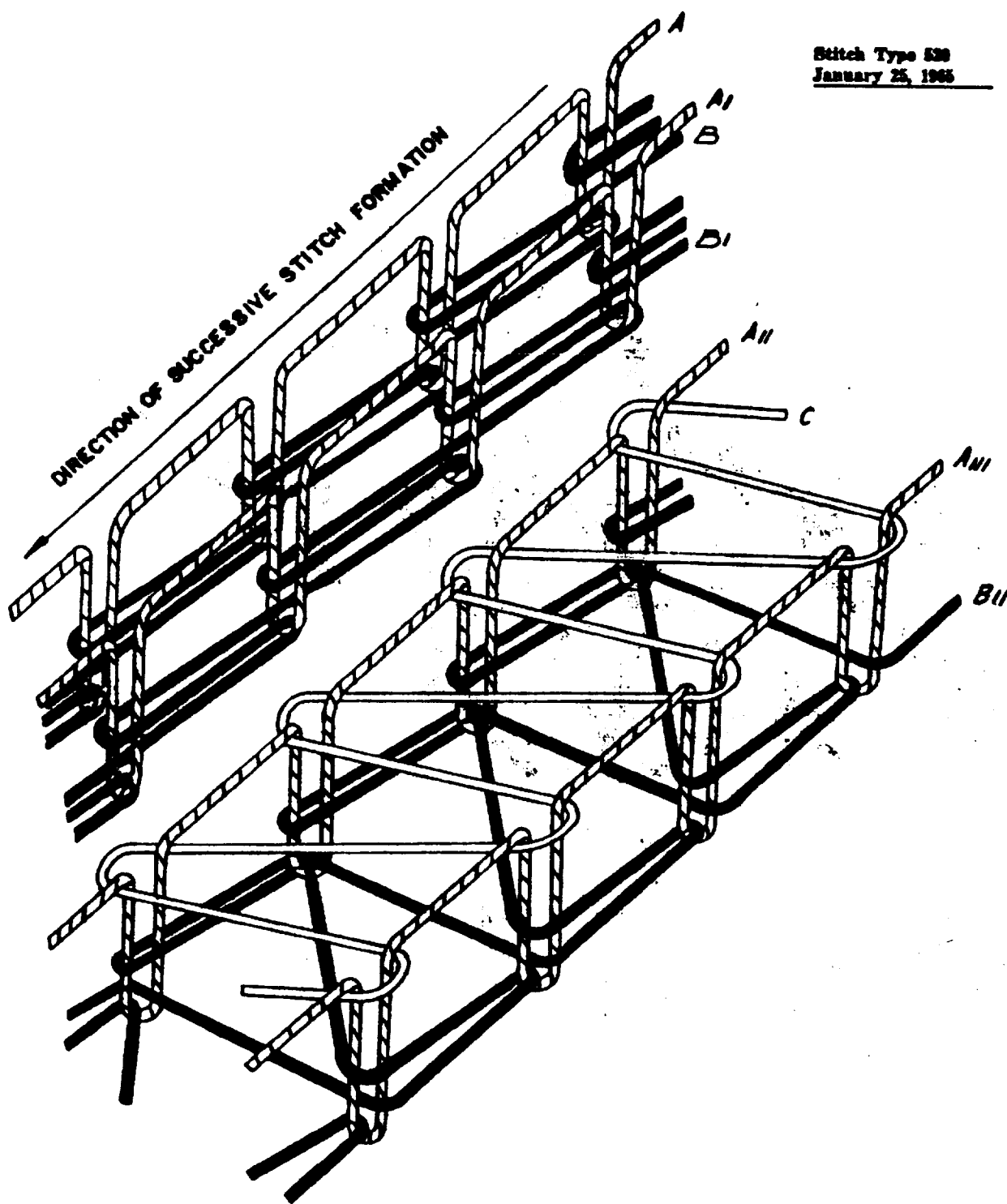

**Stitch type 520**

This type of stitch shall be formed by simultaneously sewing two rows of stitch type 401 a specified distance apart and a specified distance

from the edge of the material, and one row of stitch type 602 on the edge of the material.

60

Stitch Type 531  
 January 25, 1965

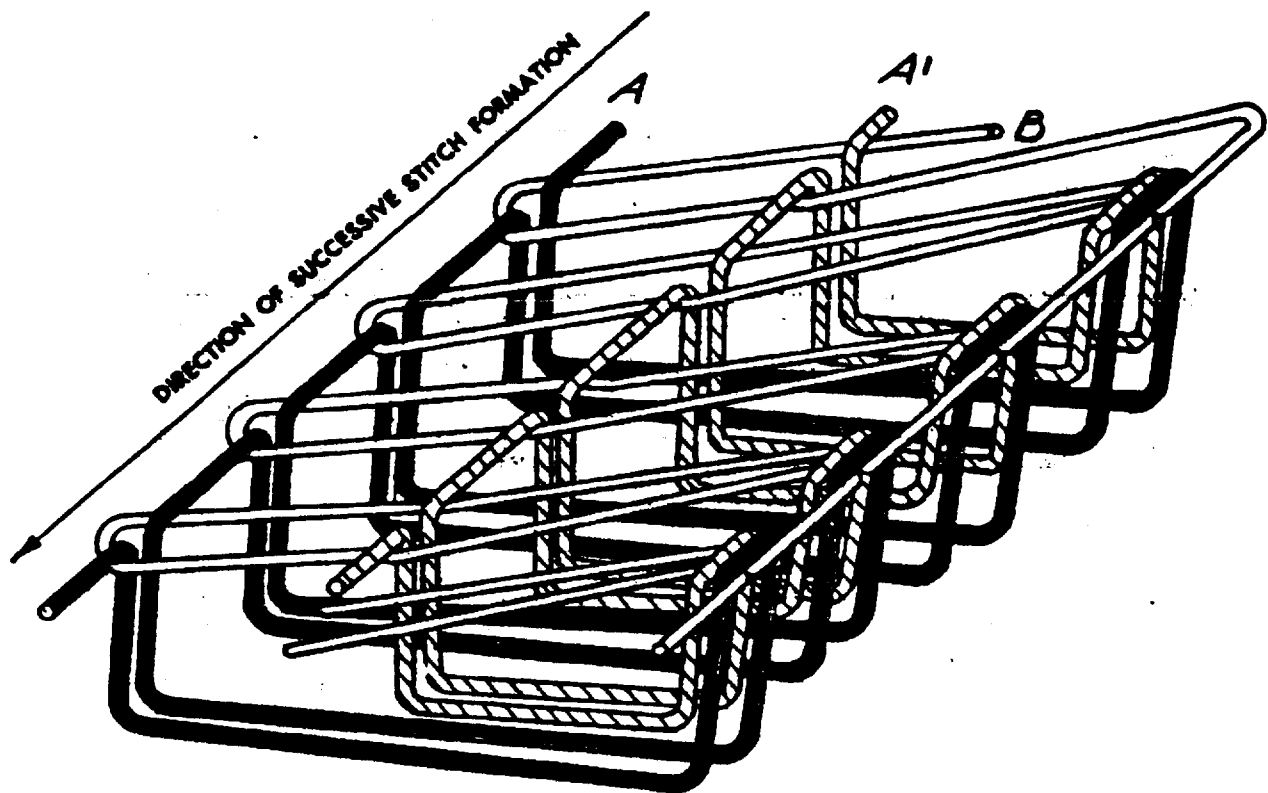

Stitch type 531

This type of stitch shall be formed with three threads: two needle threads, A and A', and one looper thread, B. Loops of threads A and A' shall be passed through the material, brought around the edge of the material and interlaced

there with thread B. The loops of thread B shall be extended from this interlacing to the points of needle penetration of threads A and A' where they shall be entered by the next stitch of those threads.

Stitch Type 601  
January 25, 1965

DIRECTION OF SUCCESSIVE STITCH FORMATION

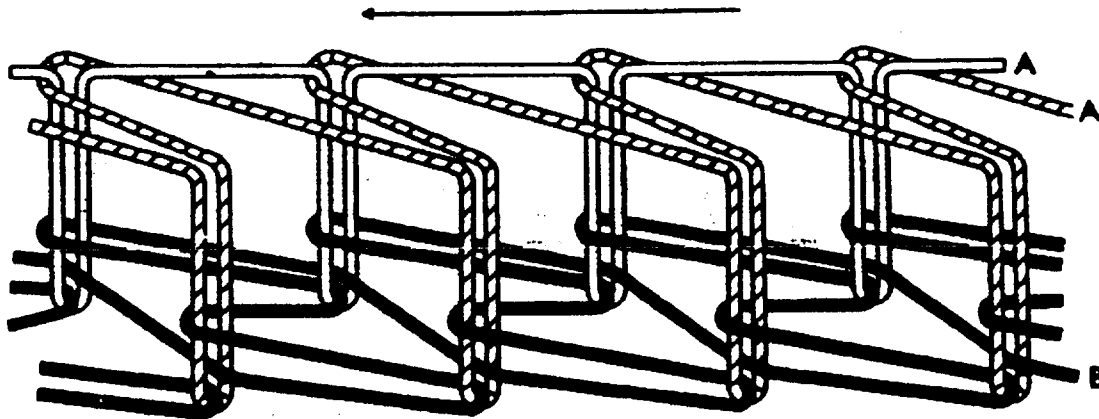

Stitch type 601

This type of stitch shall be formed with three threads; two needle threads, A and A', and one looper thread, B. Loops of threads A and A' shall be passed through the material where they shall be interlooped with thread B on the under-

side. Loops of thread A' shall be extended across the material to the point of needle penetration of the next stitch of thread A where they shall be entered by a loop of that thread as it enters the fabric to make the next stitch.

Stitch Type 602  
January 25, 1965

DIRECTION OF SUCCESSIVE STITCH FORMATION

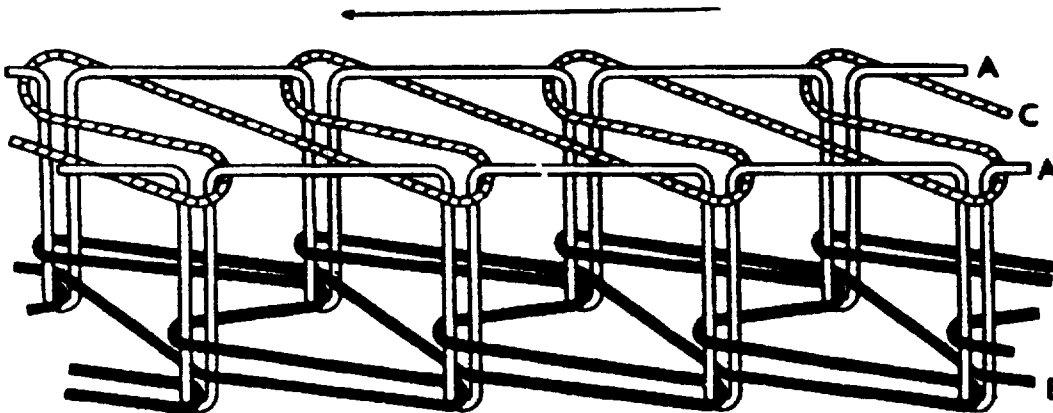

Stitch type 602

This type of stitch shall be formed with four threads: two needle threads, A and A'; one looper thread, B; and one cover thread, C. Loops of threads A and A' shall be passed

through loops of thread C already cast across the top surface of the material, and then through the material where they shall be interlooped with loops of thread B on the underside.

Stitch Type 603  
January 25, 1965

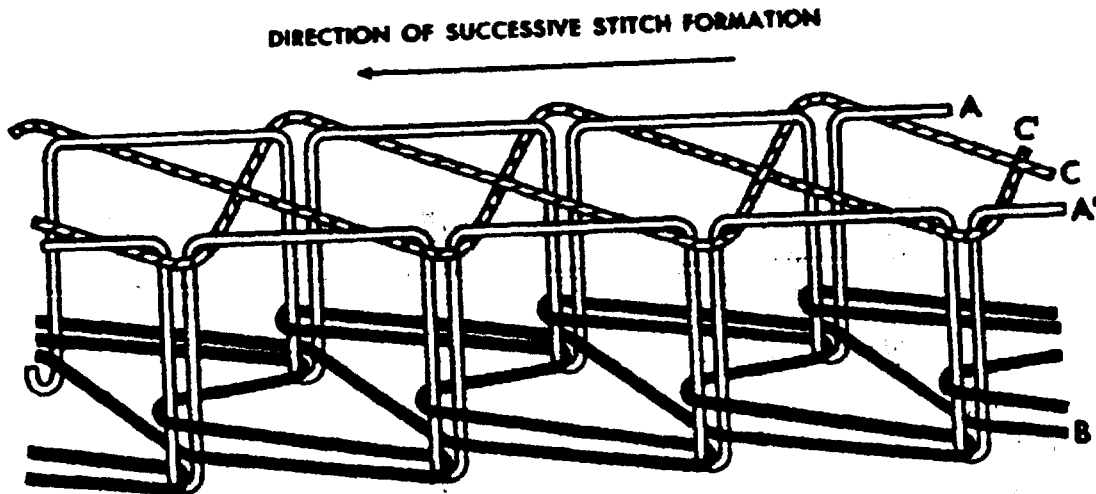

Stitch type 603

This type of stitch shall be formed with five threads: two needle threads, A and A'; one looper thread, B; and two cover threads, C and C'. Loops of threads A and A' shall be passed

through loops of threads C and C' already cast across the surface of the material and then through the material and interlooped with loops of thread B on the underside of the material.

Stitch Type 604  
January 25, 1965

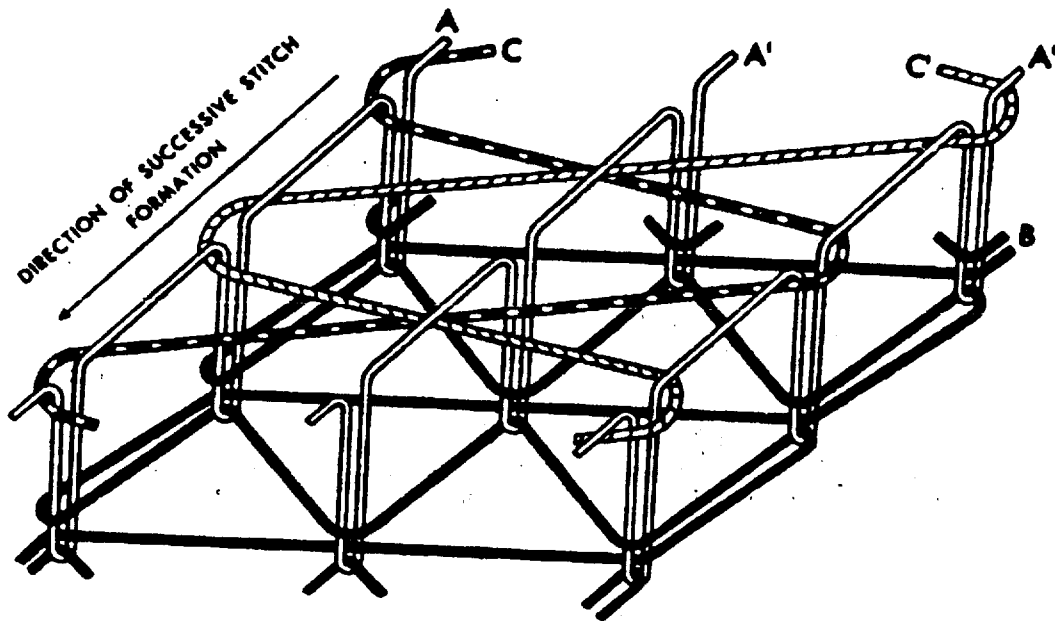

Stitch type 604

This type of stitch shall be formed with six threads: three needle threads, A, A' and A''; one looper thread, B; and two cover threads, C and C'. Loops of threads A, A' and A'' shall

be passed through loops of threads C and C' already cast across the surface of the material, and then through the material where they shall be interlooped with thread B on the underside.

Stitch Type 605  
January 25, 1965

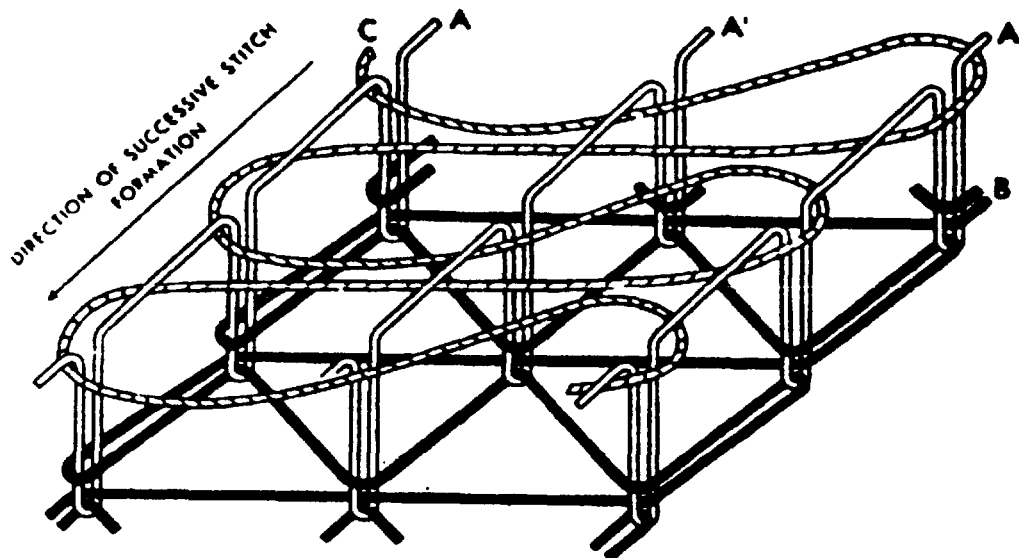

Stitch type 605

This type of stitch shall be formed with five threads: three needle threads, A, A', and A''; one looper thread, B; and one cover thread, C. Loops of threads A, A', and A'' shall be passed

through loops of thread C already cast on the top surface of the material and then through the material where they shall be interlooped with loops of thread B on the underside.

FED. STD. NO. 761a

Stitch Type 606  
January 25, 1945

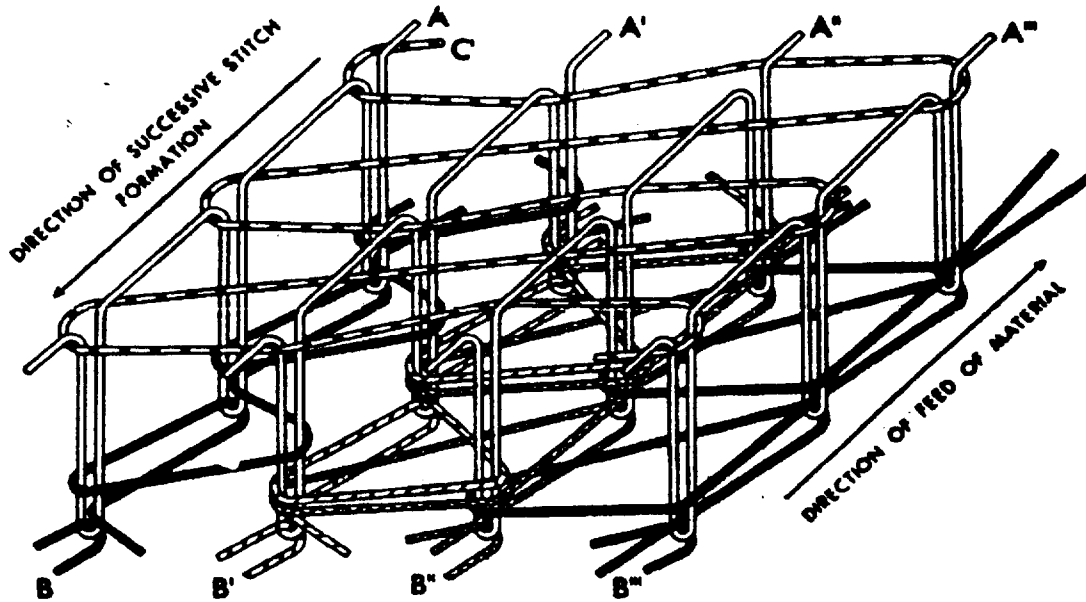

Stitch type 606

This type of stitch shall be formed with nine threads: four needle threads, A, A', A'', and A'''; four looper threads, B, B', B'', and B'''; and one cover thread, C. Loops of threads A, A', A'', and A'' shall be passed through loops of thread C already cast on the top surface of

the material, and then through the material where they shall be interlooped with loops of the B threads on the underside as follows: A and A' with B; A' and A'' with B' and B''; A'' and A''' with B'''.

Stitch Type 607  
January 25, 1963

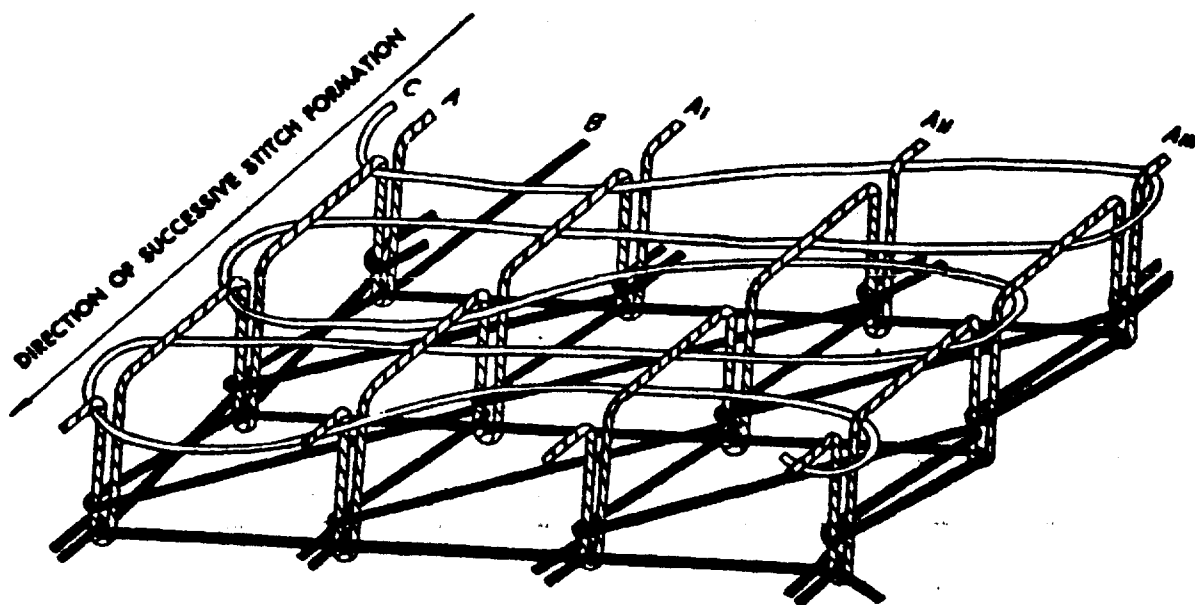

Stitch type 607

This type of stitch shall be formed with six threads: four needle threads, A, A', A'', and A'''; one looper thread, B; and one cover thread, C. Loops of threads A, A', A'', and A'''

shall be passed through loops of thread C already cast on the surface of the material, and then through the material where they shall be interlooped with loops of thread B on the underside.



Stitch Type 701  
January 28, 1965

DIRECTION OF SUCCESSIVE STITCH FORMATION

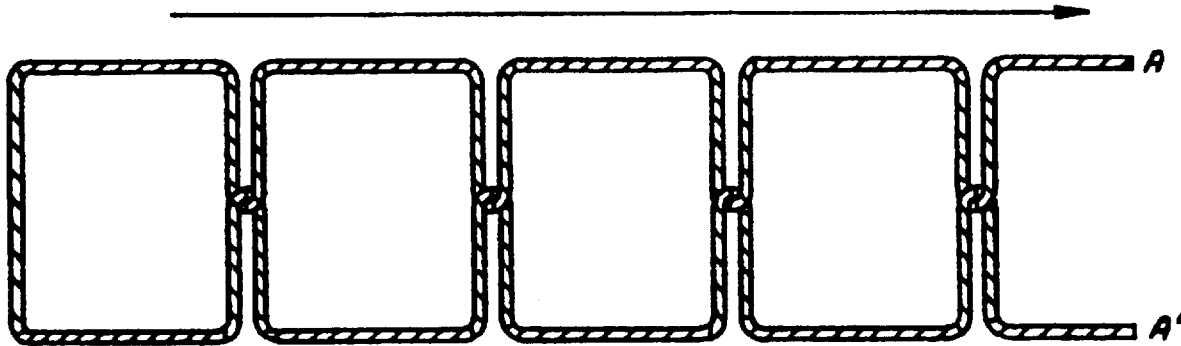

Stitch type 701

This type of stitch shall be formed with one continuous needle thread, which after the first needle penetration is divided into two parts: part one, needle thread A, and one reel thread, A'. In subsequent penetrations thread A is passed through the material and interlaced with

thread A'. Thread A shall be pulled up so that the interlacing is midway between the surfaces of the material or materials being sewn. This stitch type is identical to stitch type 301 except for the initial stitch.

68

**PART II. REQUIREMENTS****Section 2. Seams**

**2.1 Seams.** Seams are divided into four classes. The seams in each class are subdivided into types and are designated by symbols as follows:

*Class of seam*—two or more upper case letters.

*Types of the class*—one or more lower case letters.

*Number of rows of stitches*—one or more arabic numerals.

Example: The symbol for a simple superimposed seam type with one row of stitches is: SSa-1.

Generally most seam types can be produced using multiple rows of stitching. The symbol for the seam type will change with the number of rows of stitches: SSa-2, SSa-3, SSa-4, etc. All seam types shall conform to the applicable drawings unless otherwise specified.

**2.1.1 Seam class SS.** This class of seam has for a general characteristic that the plies of material are superimposed and seamed with one or more rows of stitches.

**2.1.2 Seam class LS.** This class of seam has for a general characteristic that the plies of material are lapped and seamed with one or more rows of stitches.

**2.1.3 Seam class BS.** This class of seam has for a general characteristic that it is formed by folding a binding strip over the edge of one or more plies of material and seaming the binding strip to the material with one or more rows of stitches.

**2.1.4 Seam class FS.** This class of seam has for a general characteristic that it is formed by seaming the abutted edges of material together in such a manner that the stitches extend across and cover or tend to cover the edges of the plies joined.

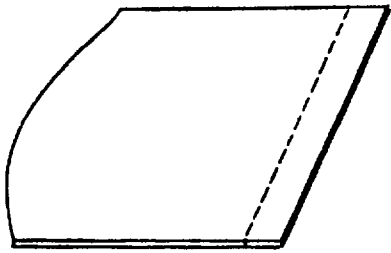

**Seam type SSa-1**  
(Produced with stitch types 301 or 401)

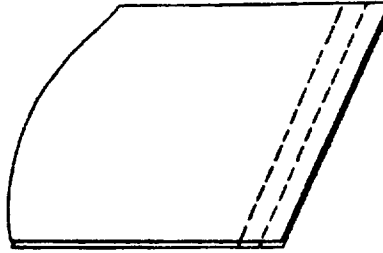

**Seam type SSa-2**  
(Produced with stitch types 301 or 401)

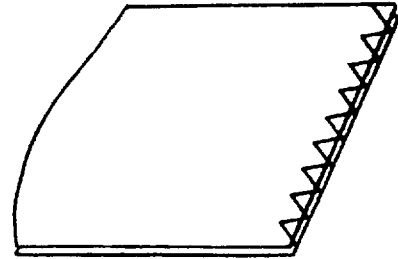

**Seam type SSa-1**  
(Produced with stitch types 304 or 404)

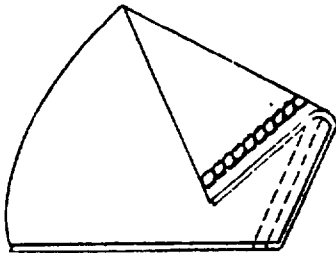

**Seam type SSa-1**  
(Produced with stitch types 302 or 402)

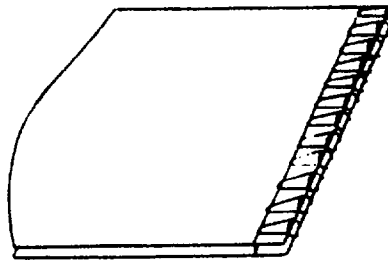

**Seam type SSa-1**  
(Produced with stitch class 500)

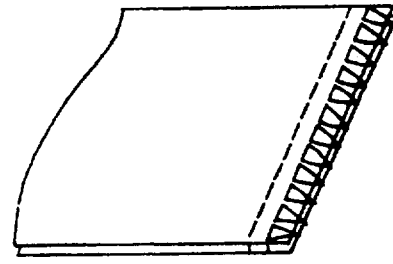

**Seam type SSa-2**  
(Produced with a combination of stitch types 101, 201, 301, 401 and any stitch type of class 500 or type 602)

This type of seam shall be formed by superimposing two or more plies of material and seam-

ing them with one or more rows of stitches a specified distance from their edges.

**Seam Type SSb**  
**January 25, 1965**

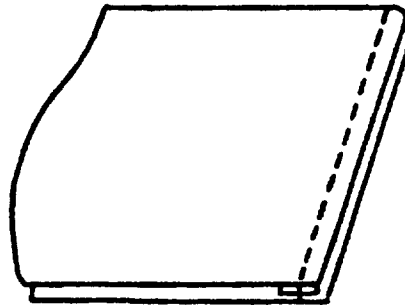

**Seam type SSb-1**

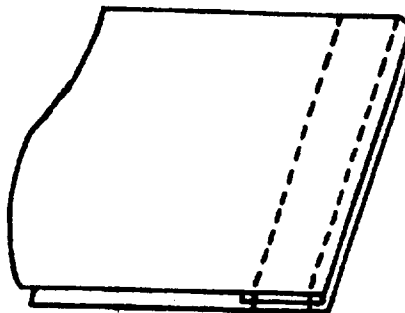

**Seam type SSb-2**

This type of seam shall be formed by superimposing two plies of material, turning in the edge of one ply a specified distance to the inside and seaming the plies with one or more rows of stitches.

**Seam Type SSc**  
**January 25, 1965**

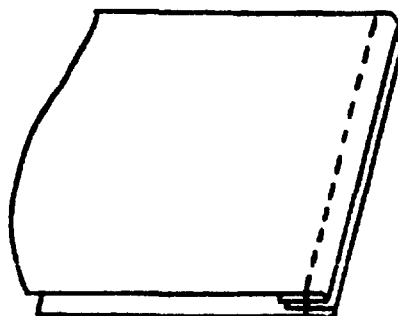

**Seam type SSc-1**

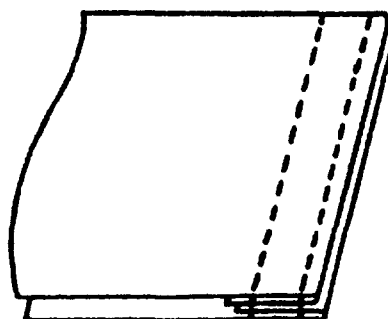

**Seam type SSc-2**

This type of seam shall be formed by superimposing two plies of material, turning the edges of both plies a specified distance to the inside and seaming through the turned edges with one or more rows of stitches a specified distance from the edges.

**Seam Type SSd**  
**January 25, 1965**

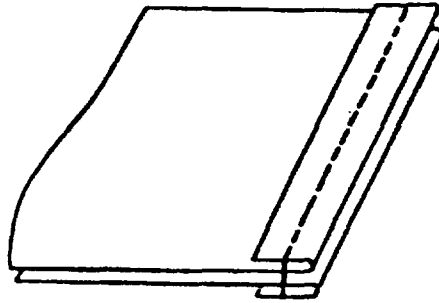

**Seam type SSd-1**

This type of seam shall be formed by superimposing two plies of material, turning the edge of both plies a specified distance outwardly and seaming with one or more rows of stitches.

Seam Type SSe  
January 25, 1963

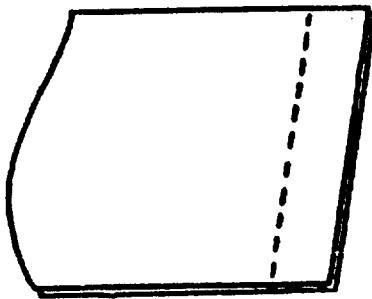

(a)

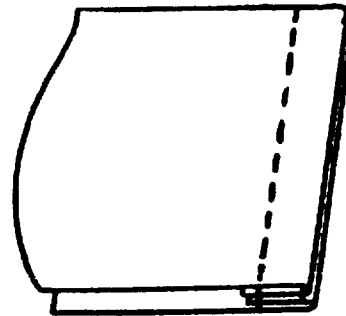

(b)

Seam type SSe-2

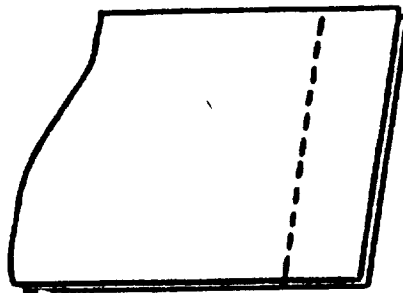

(a)

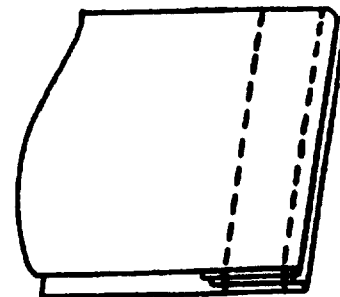

(b)

Seam type SSe-3

This type of seam shall be formed by:  
(a) superimposing two plies of material and seaming with one row of stitches a specified distance from the edge, (seam type SSe-1), and

(b) turning both plies of material at the first seaming to cover the raw edges and seaming with one or more rows of stitches through the folded edges.

**Seam Type SSf**  
**January 25, 1965**

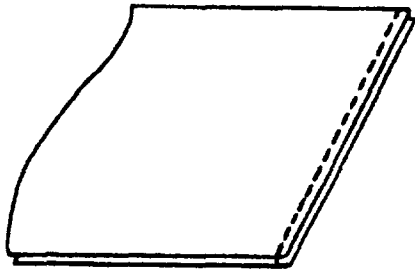

(a)

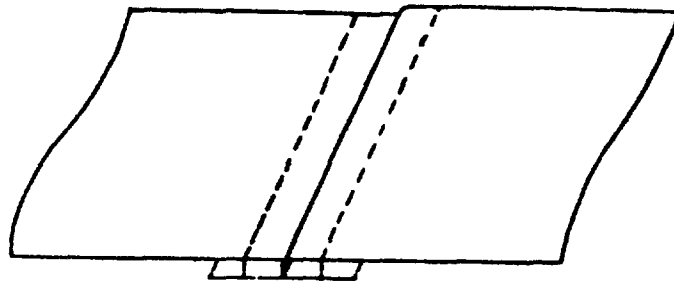

(b)

**Seam type SSf-3**

This type of seam shall be formed by:

(a) superimposing two plies of material and seaming with one row of stitches, a specified distance from the edge (Seam Type SSa-1), and

(b) opening both plies of the material and seaming a reinforcing tape over the raw edges of the material with two rows of stitches a specified distance apart.

**Seam Type SSb**  
**January 25, 1965**

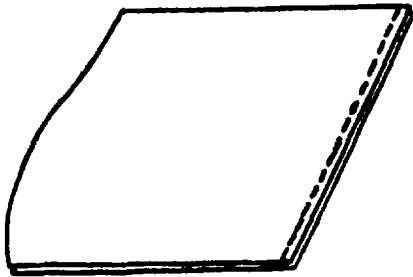

(a)

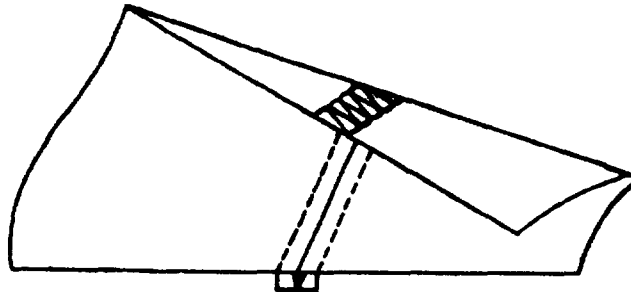

(b)

**Seam type SSb-2**

This type of seam shall be formed by:

(a) superimposing two plies of material and seaming with one row of stitches, a specified distance from the edge (Seam Type SSa-1), and

(b) opening the plies of material and sewing with a row of covering stitches over the trimmed edges.



**Seam Type SSJ**  
**January 25, 1965**

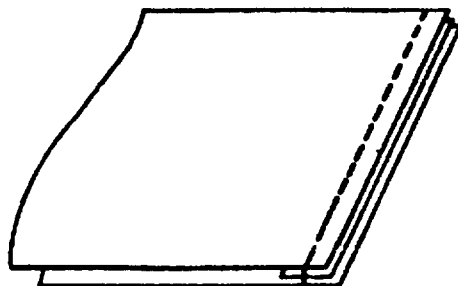

**Seam type SSj-1**

This type of seam shall be formed by superimposing two or more plies of material, inserting a plain narrow strip of material between and seaming with one or more rows of stitches a specified distance from the near edge.

Seam Type SSk  
January 25, 1965

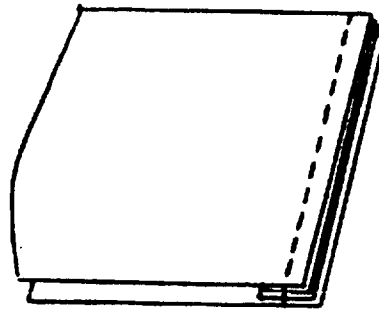

Seam type SSk-1

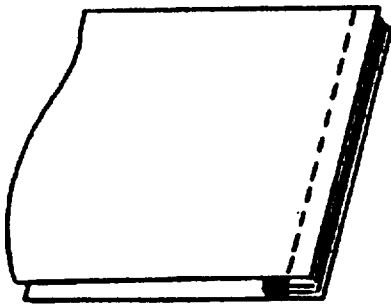

(a)

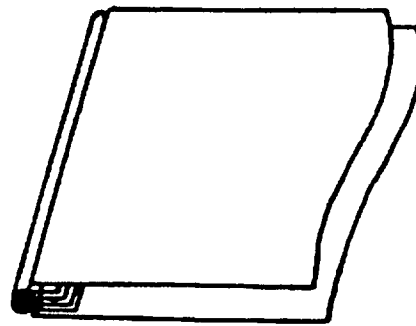

(b)

Seam type SSk-1  
(with cord)

This type of seam shall be formed by inserting a folded strip of material, with or without a cord as specified, between two superimposed

plies of material and seaming with one or more rows of stitches.

98

**Seam Type SS1**  
**January 25, 1965**

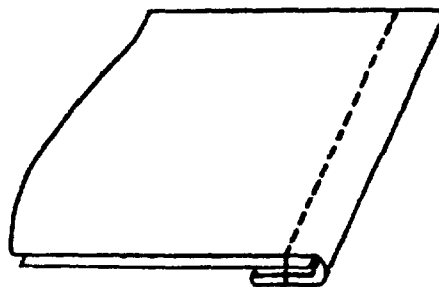

**Seam type SS1-1**

This type of seam shall be formed by superimposing one ply of material on another a sufficient distance from the edge to permit turning the edge of one ply of the material under and in, a specified distance around the edge of the other ply, and seaming with one row of stitches.

**Seam Type SSm**  
**January 25, 1965**

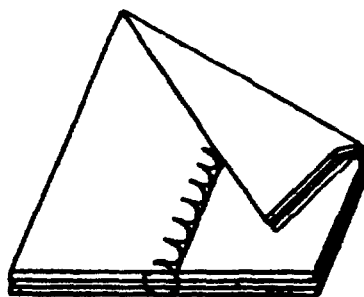

**Seam type SSm-1**

This type of seam shall be formed by superimposing two or more plies of material and seaming with one row of stitches in such a manner that the thread passes only partially through the thickness of the last or outer ply. The thread shall not show on the outer side of the last ply unless otherwise specified.

**Seam Type SSa**  
**January 25, 1965**

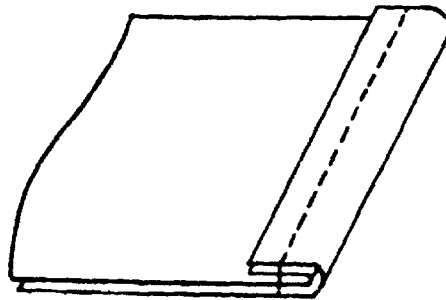

**Seam type SSn-1**

This type of seam shall be formed by superimposing two or more plies of material, folding both the edges back over the body of material a specified distance and seaming with one row of stitches.

**Seam Type SSp**  
**January 25, 1965**

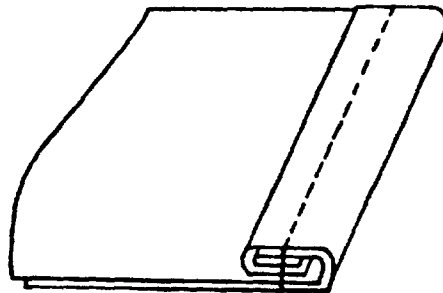

**Seam type SSp-1**

This type of seam shall be formed by superimposing two or more plies of material, turning the edges back over the body of material and in, under that fold a specified distance, and seaming with one row of stitches.

Seam Type SSq  
January 25, 1965

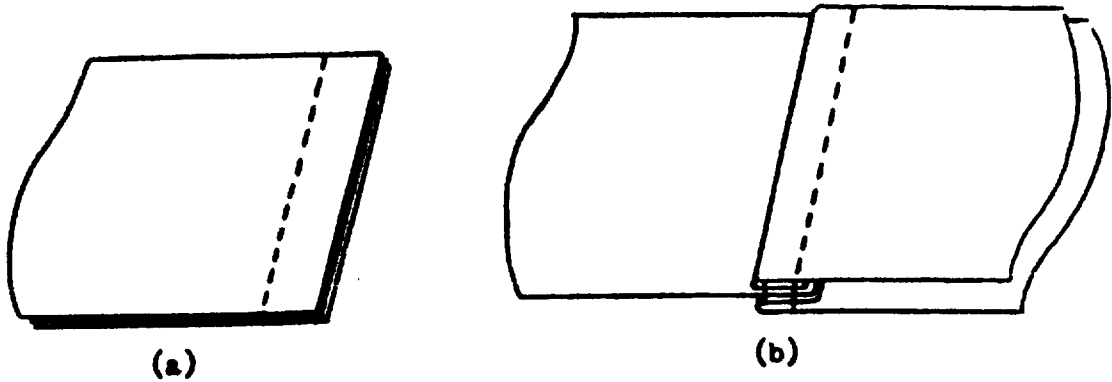

Seam type SSq-2

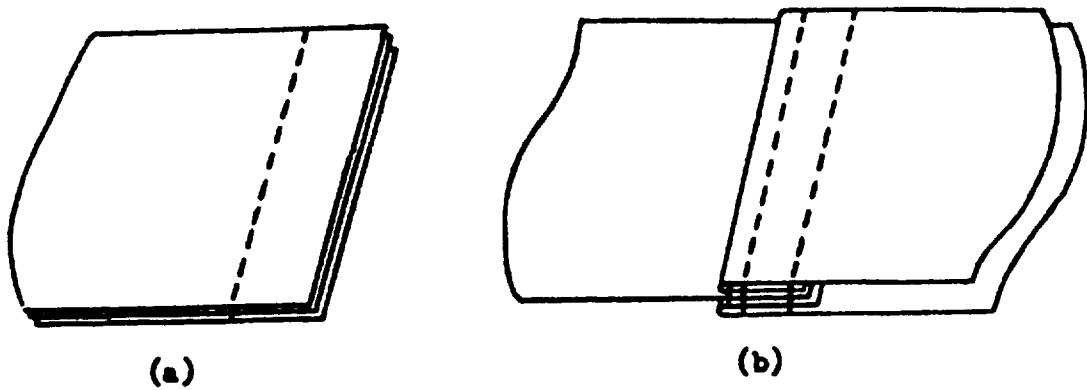

Seam type SSq-3

This type of seam shall be formed by:

(a) superimposing three or more plies of material and seaming with one row of stitches a specified distance from the edge (seam type SSe-1), and

(b) turning the two outer plies back over their edges and seaming with one or more rows of stitches.

Seam Type SSr  
January 25, 1965

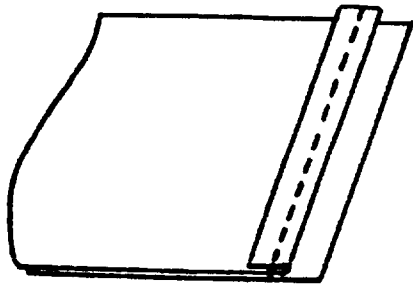

(a)

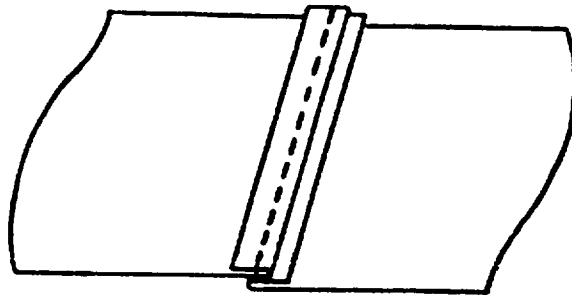

(b)

Seam type SSr-1

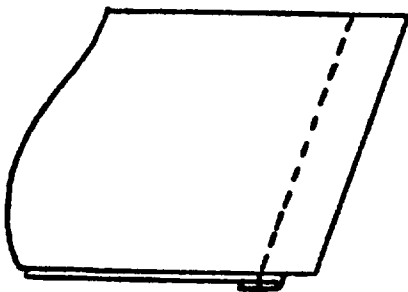

(a)

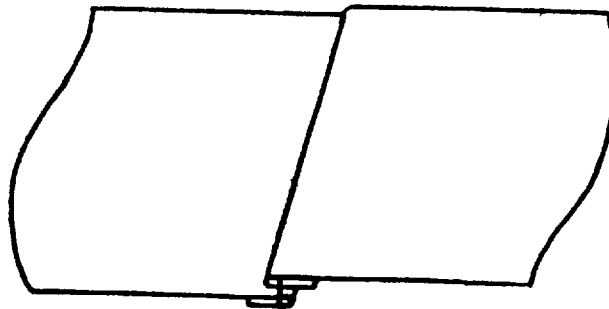

(b)

Seam type SSr-1 (Inverted)

This type of seam shall be formed by superimposing two plies of material, turning the edge of one ply of material and seaming

through the turned edge and plies of material with one row of stitches.

**Seam Type SSe**  
**January 25, 1965**

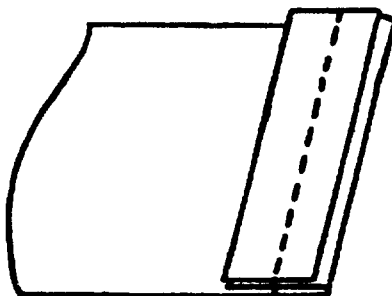

**Seam type SSe-1**

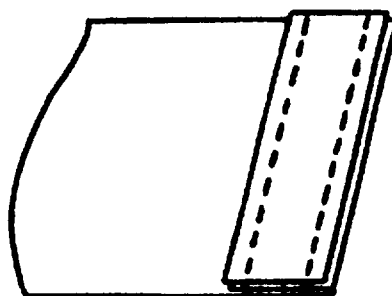

**Seam type SSe-2**

This type of seam shall be formed by superimposing a tape, webbing or narrow piece of fabric over the turned edge of a ply or plies of material and seaming with one or more rows of stitches through the turned edge.

Seam Type SSt  
January 25, 1965

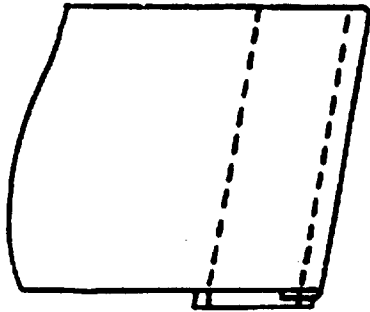

Seam type SSt-2

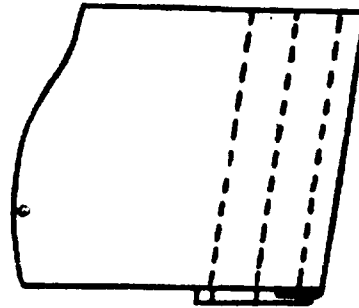

Seam type SSt-3

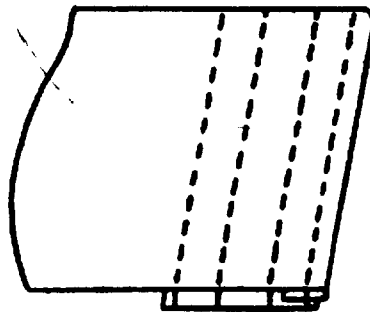

Seam type SSt-4

This type of seam shall be formed by superimposing a ply or plies of material with the outer edge turned, on a tape, webbing or nar-

row strip of fabric and seaming with two or more rows of stitches, with only the row nearest the folded edge going through the fold.



Seam Type SSu  
January 25, 1965

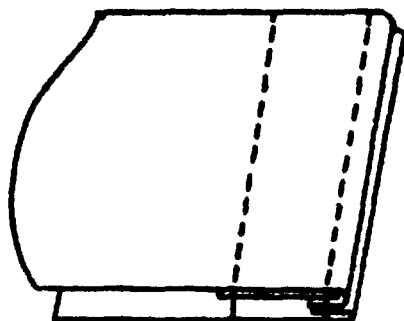

Seam type SSu-2

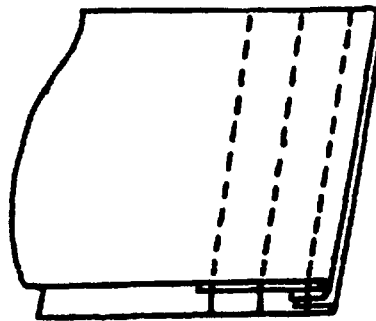

Seam type SSu-3

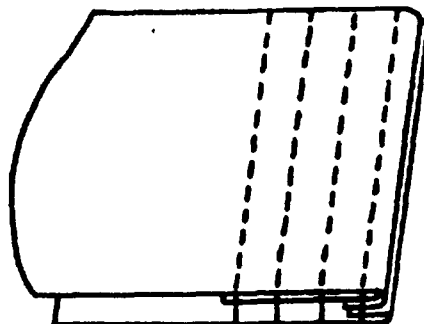

Seam type SSu-4

This type of seam shall be formed by turning the edges of two plies of material inwardly, inserting a tape or strip of material within the

inturned upper ply, and stitching with two or more rows of stitches, with only the row nearest the folded edge going through the folds.

**Seam Type SSv**  
**January 25, 1965**

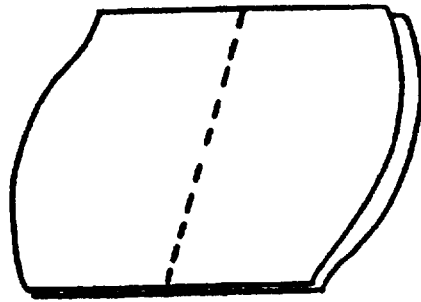

**Seam type SSv-1**

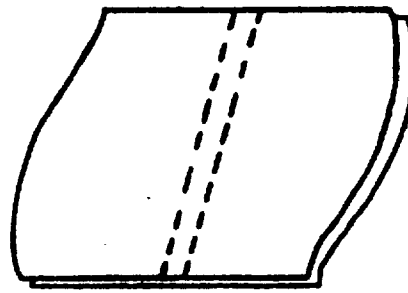

**Seam type SSv-2**

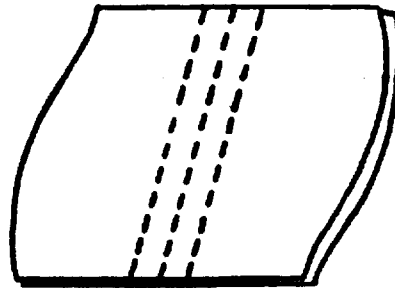

**Seam type SSv-3**

This type of seam shall be formed by superimposing and seaming two or more plies of material with one or more rows of stitches where

evenly spaced lines of stitches are required in the body of the materials, as in quilting comforters, clothing linings, etc.

**Seam Type SSw**  
**January 25, 1965**

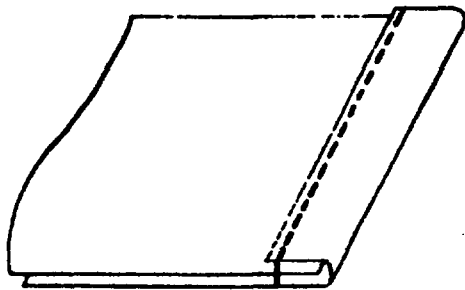

(a)

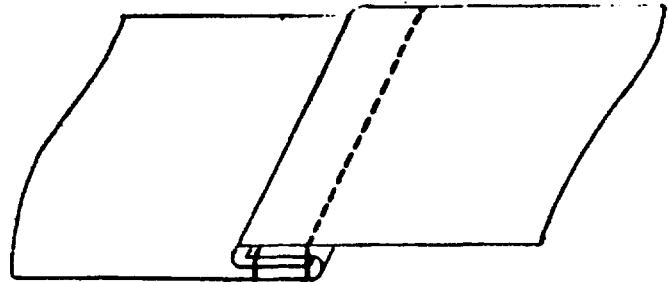

(b)

**Seam type SSw-2**

This type of seam shall be formed by:

(a) superimposing two pieces of material, turning the edge of one ply of material over the edge of the second ply, and seaming with one row of stitches, and

(b) turning back the body of the upper ply over the folded lower ply and seaming with one row of stitches.

**Seam Type SSx**  
**January 25, 1965**

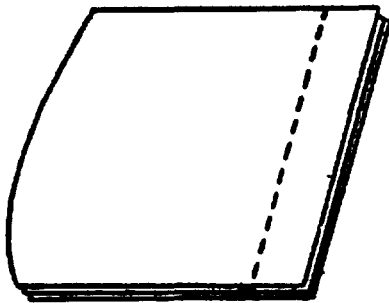

(a)

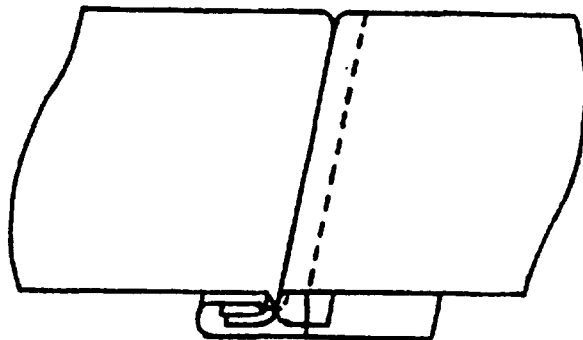

(b)

**Seam type SSx-2**

This type of seam shall be formed by:

(a) superimposing and seaming three plies of material as in seam type SSa-1 with a single row of stitches a specified distance from the edges, and

(b) turning back the edges of the middle and

bottom plies and the body of the bottom ply over these turned edges, turning back the edge of the top ply and the body of the top ply and seaming through the body and the turned edge of the top ply, and the body of the bottom ply with one row of stitches.

Seam Type SSy  
January 25, 1965

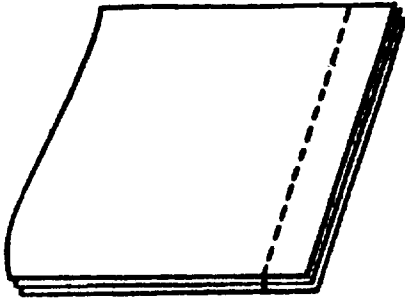

(a)

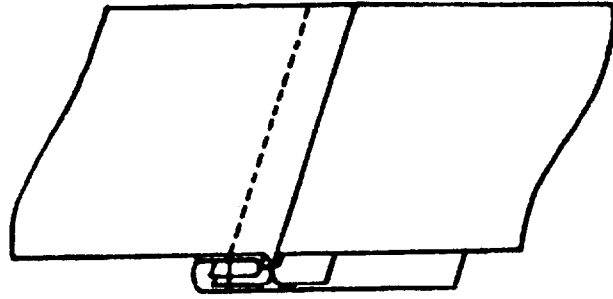

(b)

**Seam type SSy-2**

This type of seam shall be formed by:

- (a) superimposing and seaming three plies of material in seam type SSa-1 with a single row of stitches a specified distance from the edge and
- (b) turning back the edges of the middle and

bottom plies and the body of the bottom ply over these turned edges, turning back the edge of the top ply and the body of the top ply and seaming through the body of the middle ply, the turned edges of the middle and bottom ply and the body of the bottom ply.

Seam Type SSz  
January 25, 1965

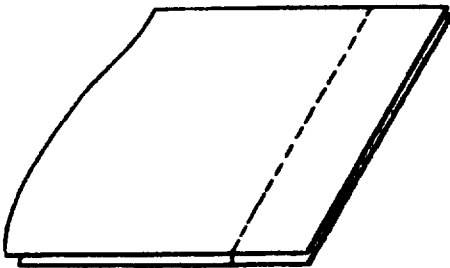

(a)

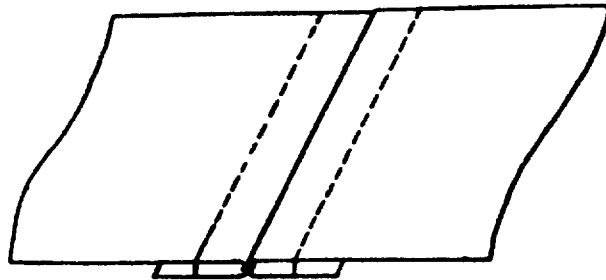

(b)

**Seam type SSz-3**

This type of seam shall be formed by:

- (a) superimposing and seaming two plies of material in seam type SSa-1 and
- (b) opening the two plies and turning the

edges of each ply back under the body of the ply and seaming through the turned edge of each ply with one row of stitches.

**Seam Type SSaa**  
**January 25, 1965**

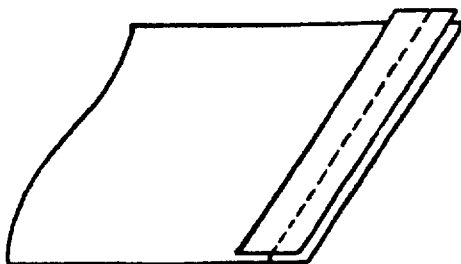

**Seam type SSaa-1**

This type of seam shall be formed by superimposing a strip on one ply of material and seaming with one or more rows of stitches.

**Seam Type SSab**  
**January 25, 1965**

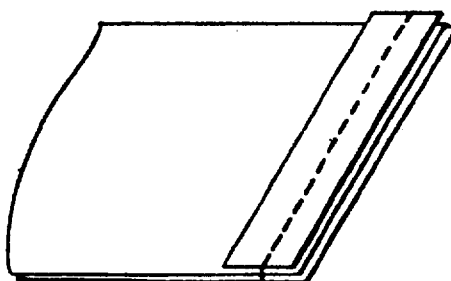

**Seam type SSab-1**

This type of seam shall be formed by superimposing a strip on two plies of material and seaming with one or more rows of stitches.

Seam Type SSac  
January 25, 1965

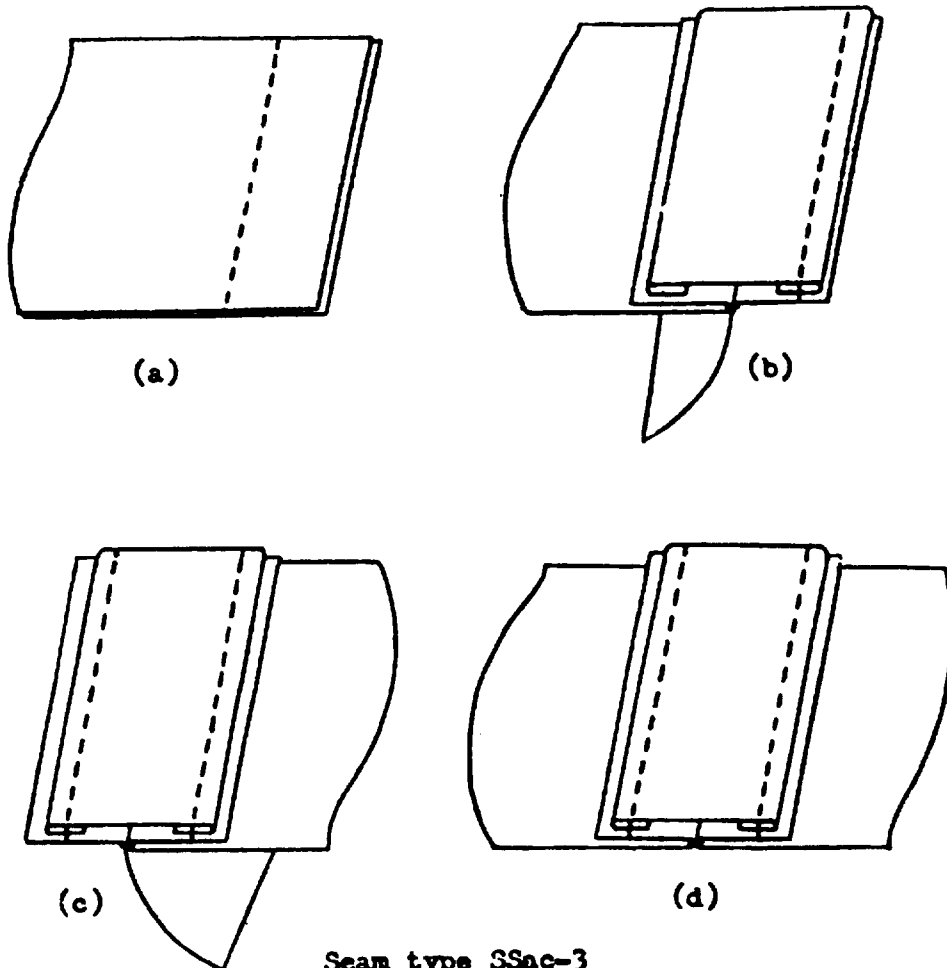

Seam type SSac-3

This type of seam shall be formed by:

- (a) superimposing two plies of material and seaming with one row of stitches a specified distance from the edges in seam type SSa-1, and
- (b) turning one ply aside and seaming its edge to a strip with its edges turned in,

- (c) turning the other ply aside and seaming its edge to the strip, and
- (d) opening both plies of material to finish as shown.

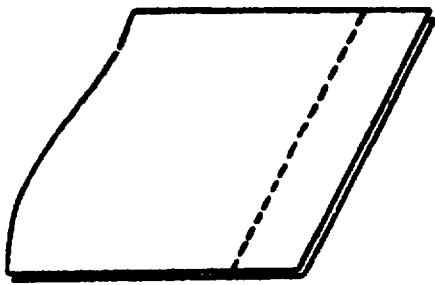

(a)

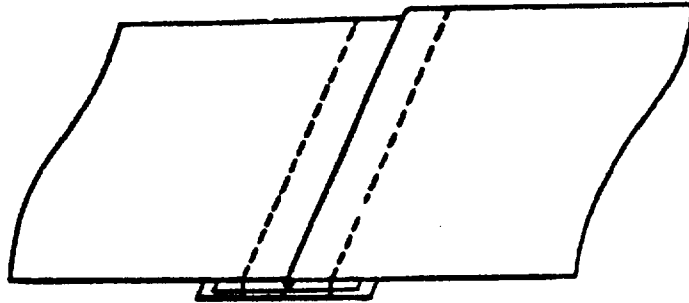

(b)

**Seam type SSad-3**

This type of seam shall be formed by:

(a) superimposing two plies of material and seaming with one row of stitches a specified distance from the edges in seam type SSa-1, and

(b) opening the two plies, turning the edge of each ply under the body, superimposing to a reinforcing strip and seaming through the body, turned edge, and reinforcement strip.

91

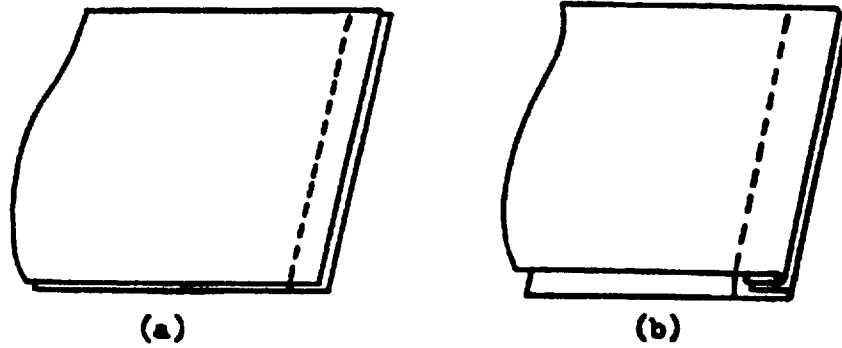

**Seam type SSae-2**

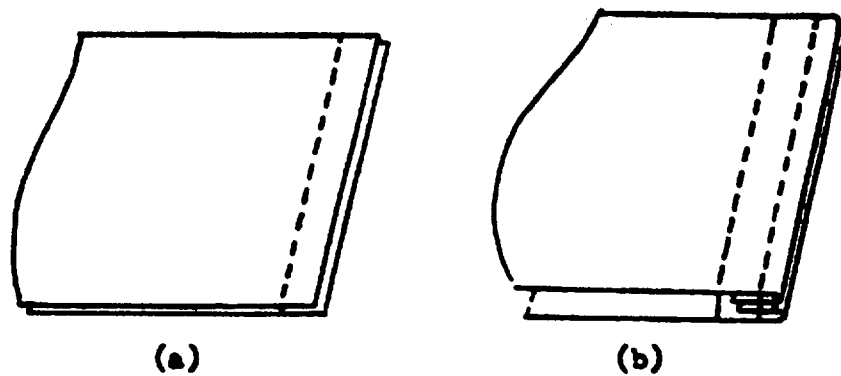

**Seam type SSae-3**

This type of seam shall be formed by:

- (a) superimposing two plies of material and seaming with a row of stitches a specified distance from the edges in seam type SSa-1, and
- (b) turning both plies of material over their

edges and seaming with one or more rows of stitches. When more than one row of stitches are used, one row shall pass through the folded edges.

72



Seam Type SSaf  
January 25, 1965

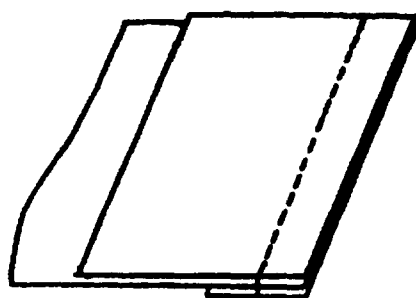

(a)

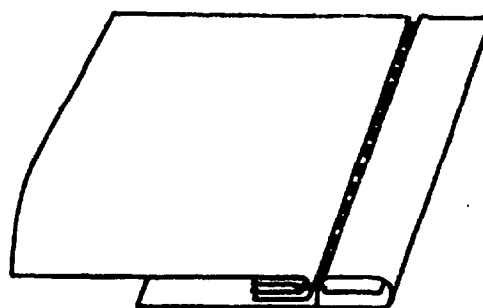

(b)

**Seam type SSaf-2**

This type of seam shall be formed by:

- (a) superimposing a welt strip on the body of a material which is superimposed on a stay piece and seaming with one row of stitches, and
- (b) opening the seam by turning the welt

strip over on itself and under the body material and stay piece, the edges of which shall have been turned, and seaming through the first seam and welt strip.

Seam Type SSag  
January 25, 1965

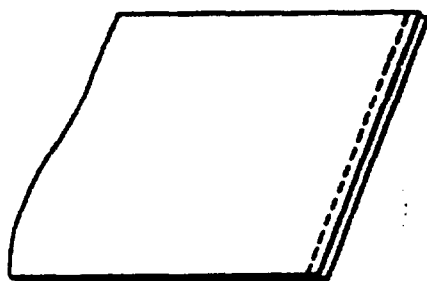

(a)

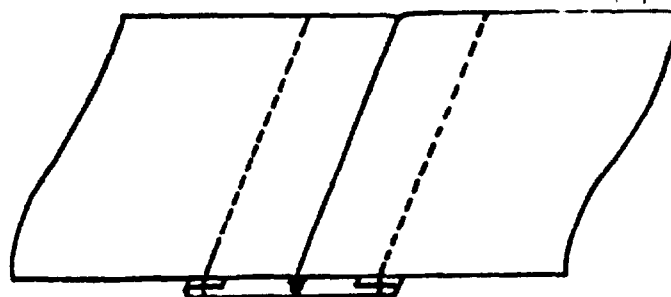

(b)

**Seam type SSag-3**

This type of seam shall be formed by:

- (a) superimposing two plies of material and seaming in seam type SSa-1, and
- (b) opening each ply and superimposing

these over a reinforcing strip whose edges are turned in a specified distance, and seaming with two rows of stitches through the reinforcing strip.

**Seam Type SSah**  
**January 25, 1965**

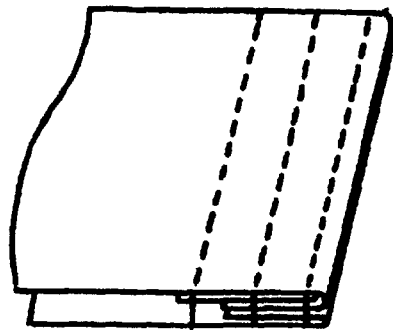

**Seam type SSah-3**

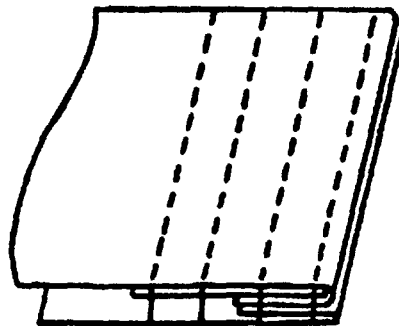

**Seam type SSah-4**

This type of seam shall be formed by turning the edge of one ply of material around a tape and superimposing this on another ply with edge turned up and stitching with three or more rows of stitches, two rows of which shall be through the turned edges.

**Seam Type SSaj**  
**January 25, 1965**

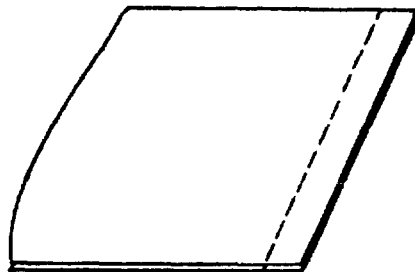

(a)

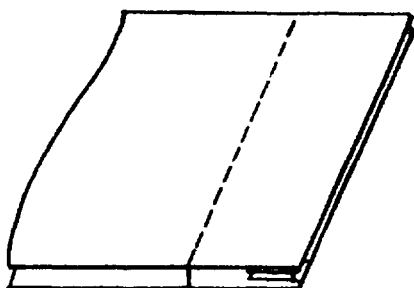

(b)

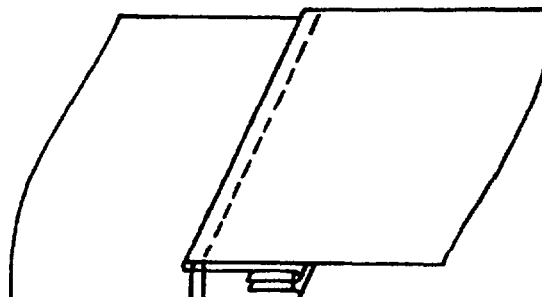

(c)

**Seam type SSaj-3**

This type of seam shall be formed by:  
(a) superimposing two plies of material and seaming with a row of stitches a specified distance from the edge in seam type SSa-1,  
(b) turning both plies of material over their

edges and seaming with one or more rows of stitches in seam type SSae-2, and  
(c) turning the top ply back over the seam and seaming with one row of stitches a specified distance from the second row of stitches.

Seam Type SSak  
January 25, 1965

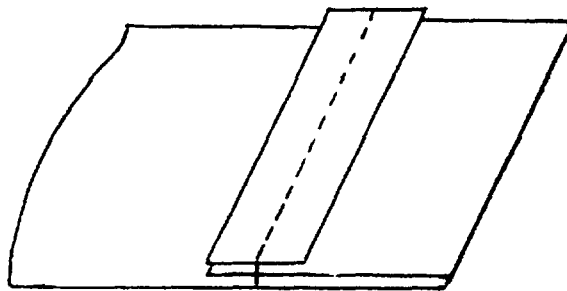

**Seam type SSak-1**

This type of seam shall be formed by super-  
imposing a strip on the fold of a body material  
a specified distance from the folded edge and  
seaming with one or more rows of stitches.

96

**Seam Type S8a:**  
**January 25, 1965**

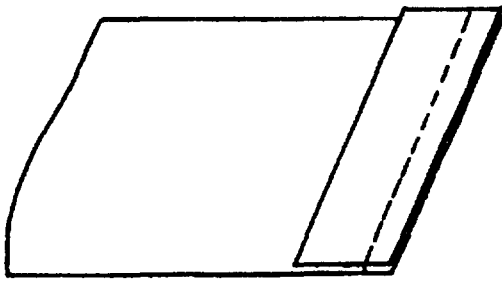

(a)

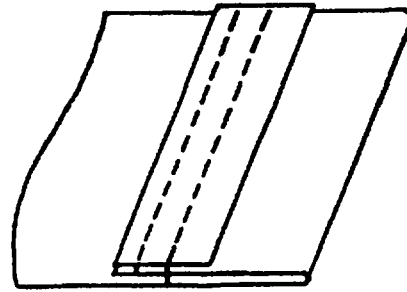

(b)

**Seam type S8a1-2**

This type of seam shall be formed by:

(a) superimposing a strip on one ply of material and seaming with one or more rows of stitches, and

(b) folding the edge of the body ply and the strip over the body material and seaming through the strip and body material with one or more rows of stitches.

**Seam Type SSam**  
**January 25, 1965**

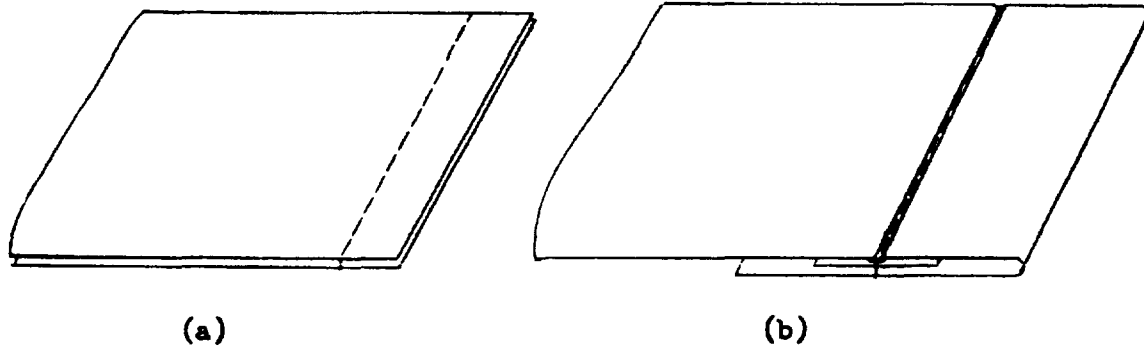

**Seam type SSam-2**

This type of seam shall be formed by:

- (a) superimposing and seaming two plies of material in seam type SSa-1, and
- (b) opening the two plies and turning the

edges of each ply back under the body of the ply; turning the body ply back under these turned edges and seaming through the first seam with one row of stitches.

98

**Seam Type SSac**  
**January 25, 1965**

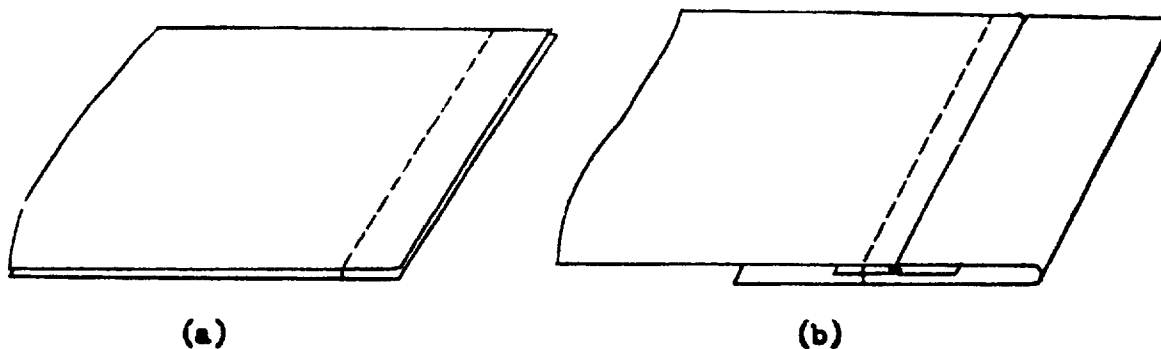

**Seam type SSao-2**

This type of seam shall be formed by:

(a) superimposing and seaming two plies of material in seam type SSa-1, and

(b) opening the two plies and turning the edges of each ply back under the body of the

ply; turning the body of one ply over these turned edges and seaming through the body and turned edge of the top ply and the body of the bottom ply with one row of stitches.

**Seam Type SSaq**  
**January 25, 1965**

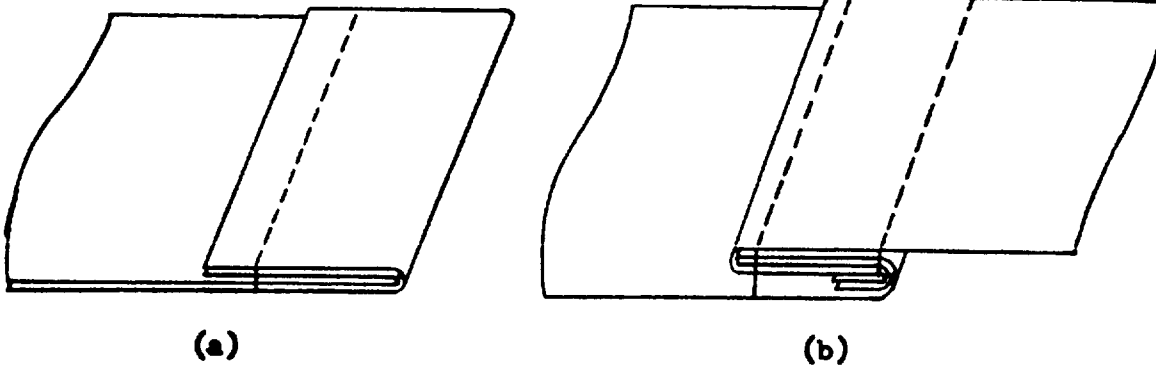

**Seam type SSaq-2**

This type of seam shall be formed by:

(a) superimposing two or more plies of material, folding both the edges back over the body of material a specified distance and seaming with one row of stitches, and

(b) opening the plies of material, turning the seam to one side and seaming with one or more rows of stitches.



Seam Type SSar  
January 25, 1965

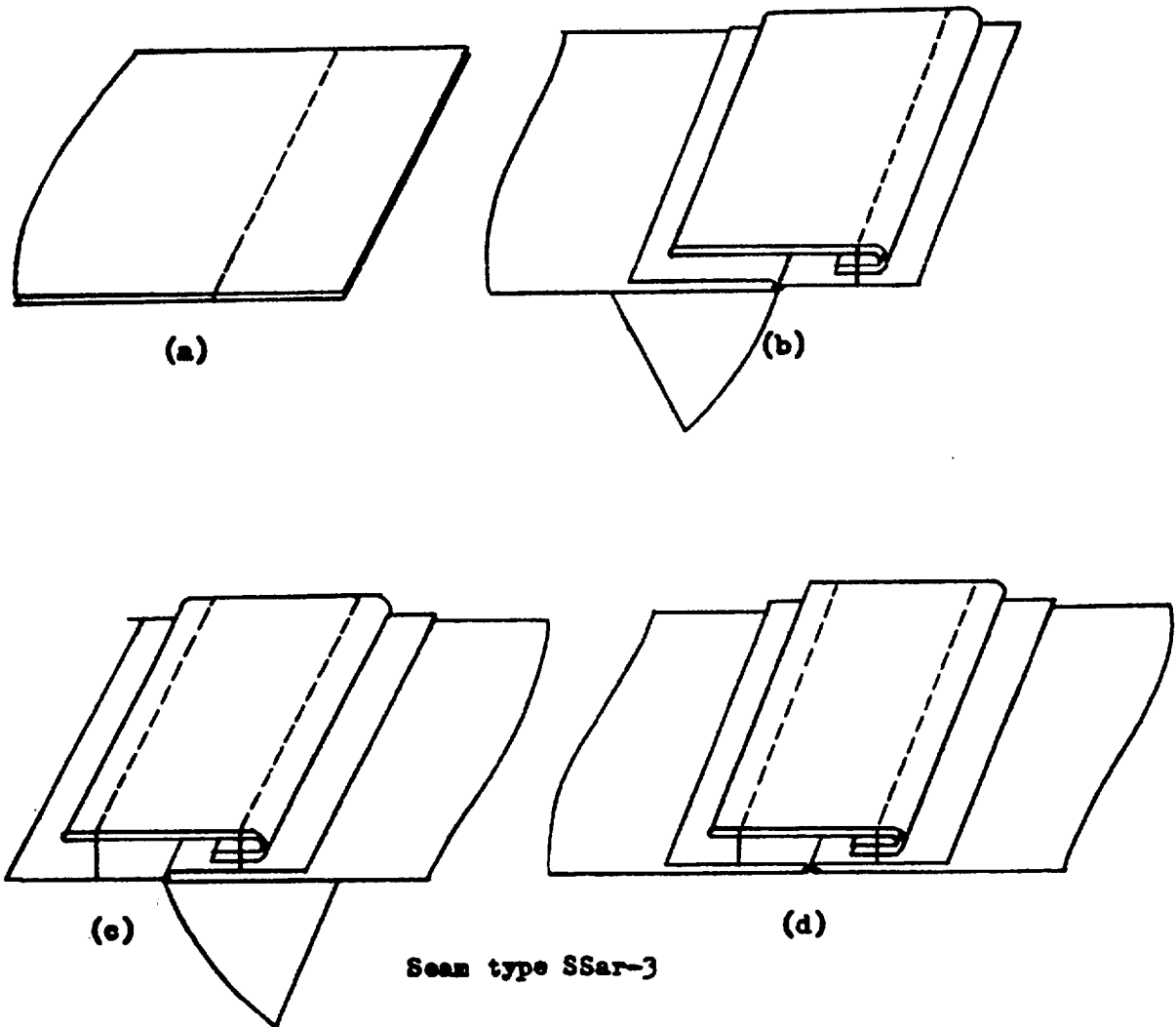

This type of seam shall be formed by:  
(a) superimposing two plies of material and seaming with one row of stitches a specified distance from their edges in seam type SSa-1,  
(b) turning one ply aside and seaming its

edge to a folded strip with its edges turned in,  
(c) turning the other ply aside and seaming its edge to the folded edge of the strip, and  
(d) opening both plies of material to finish as shown.

**Seam Type SSas**  
**January 25, 1965**

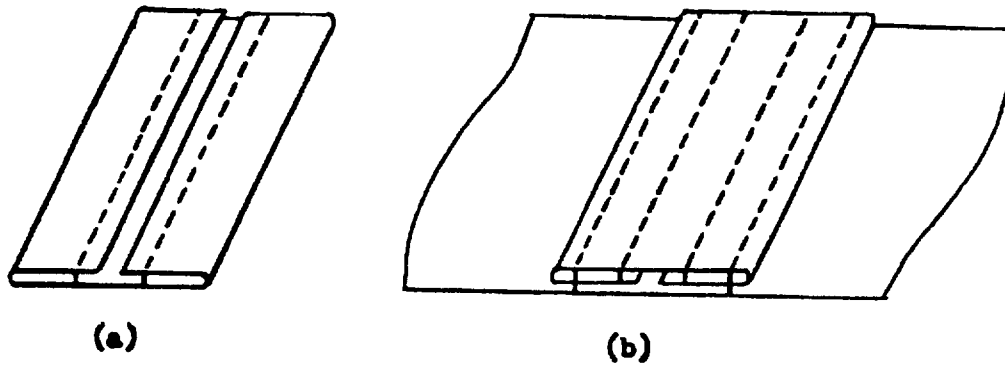

**Seam type SSas-4**

**This type of seam shall be formed by:**  
**(a) turning the edges of a strip of material and seaming with two rows of stitches, and**

**(b) superimposing the stitched strip with the turned edges downward on a body material and seaming with two rows of stitches.**

102

**Seam Type SSat**  
**January 25, 1965**

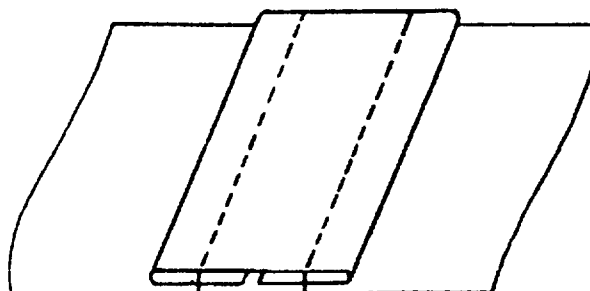

**Seam type SSat-2**

This type of seam shall be formed by superimposing a strip with its edges turned under on a body material, and seaming the strip to the body material with two or more rows of stitches.

**Seam Type 33au**  
**January 25, 1965**

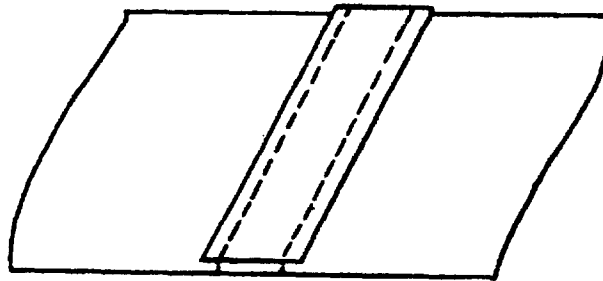

**Seam type 33au-2**

This type of seam shall be formed by super-  
imposing a strip on a body material and seaming with two or more rows of stitches.

Seam Type SSav  
January 25, 1965

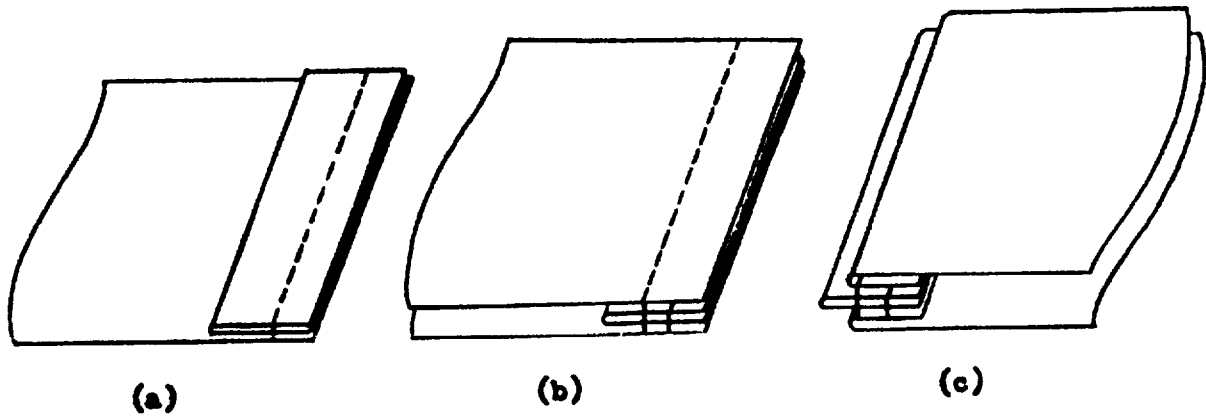

Seam type SSav-2

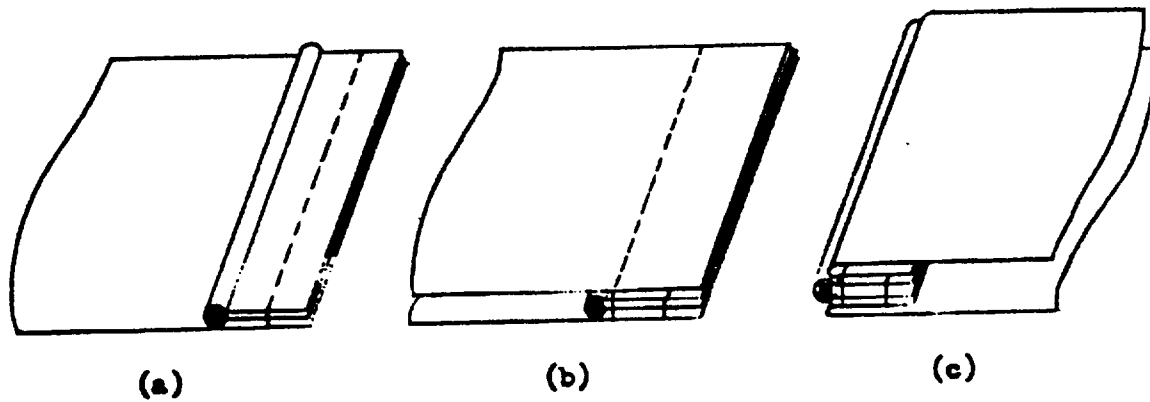

Seam type SSav-2  
(with cord)

This type of seam shall be formed by:  
(a) superimposing a folded strip of material, with or without a cord as specified, over a ply of material and seaming with one row of stitches,

and  
(b) superimposing another ply of material and seaming with one row of stitches.

**Seam Type SSaw**  
**January 25, 1965**

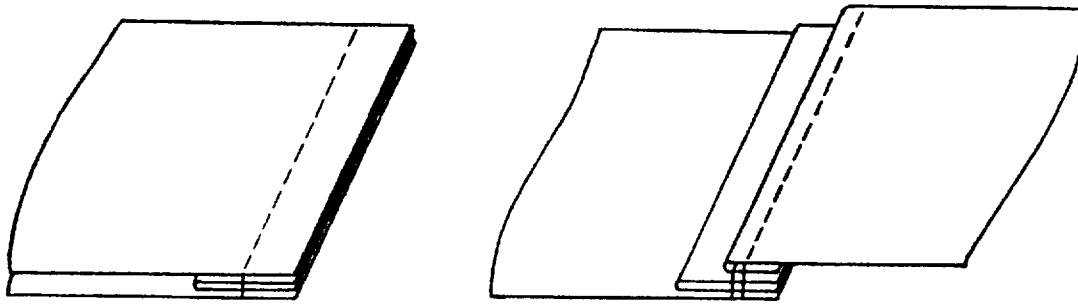

(a)

(b)

**Seam type SSaw-2**

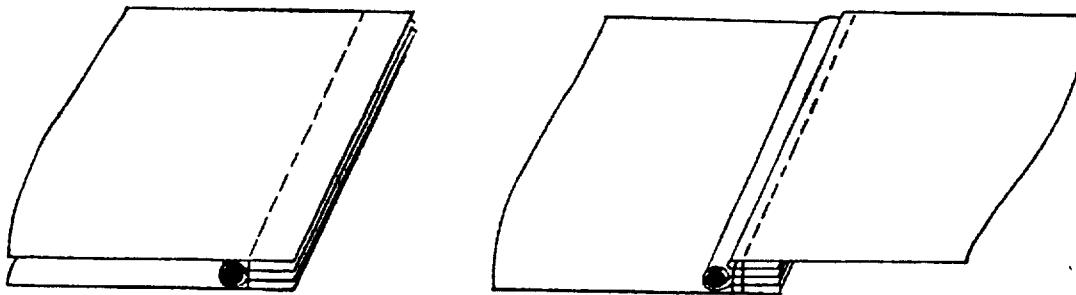

(a)

(b)

**Seam type SSaw-2**  
**(with cord)**

This type of seam shall be formed by:

(a) inserting a folded strip of material, with or without a cord as specified, between two superimposed plies of material and seaming with one row of stitches, and

(b) turning the top ply back sharply over the first row of stitches and seaming with one or more rows of stitches.

106

**Seam Type SSax**  
**January 25, 1965**

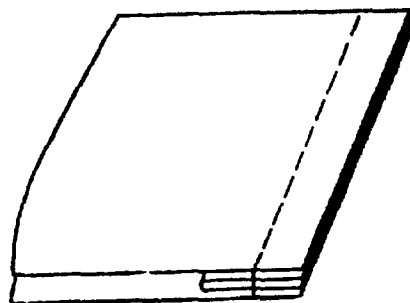

(a)

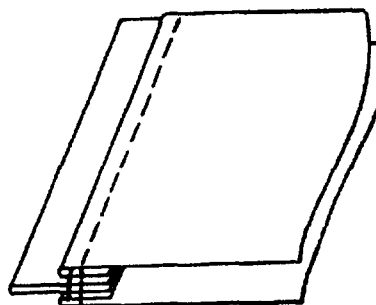

(b)

**Seam type SSax-2**

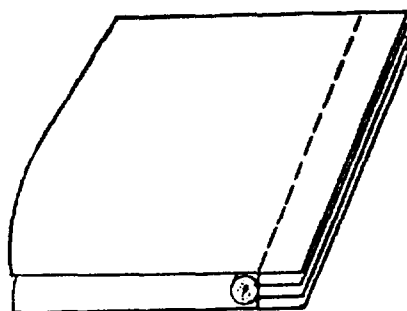

(a)

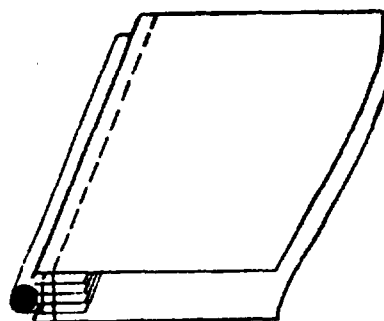

(b)

**Seam type SSax-2  
(with cord)**

This type of seam shall be formed by:

(a) inserting a folded strip of material, with or without a cord as specified, between two superimposed plies of material and seaming with one row of stitches, and

(b) turning both plies of material at the first seaming to cover the raw edges and seaming with one or more rows of stitches through the folded edges.

**Seam Type SSay**  
**January 25, 1965**

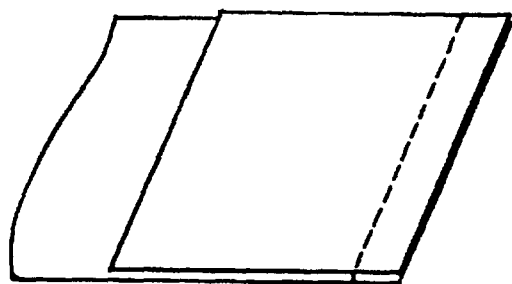

(a)

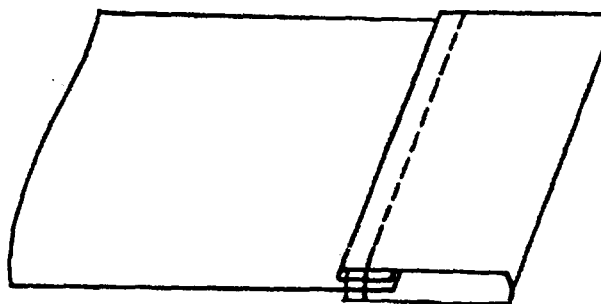

(b)

**Seam type SSay-2**

This type of seam shall be formed by:

(a) superimposing a strip on a ply of body material and seaming with one row of stitches in seam type SSa-1, and

(b) turning the strip over the row of stitches, around the edge of the body material and seaming with a second row of stitches.



**Seam Type SSas**  
**January 25, 1965**

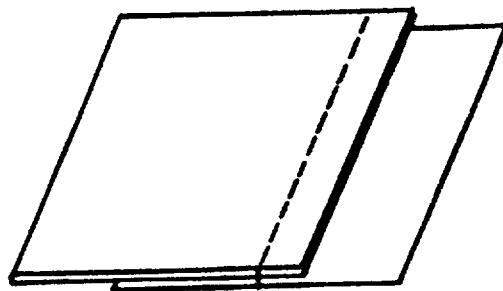

(a)

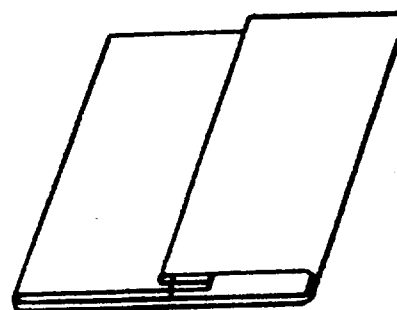

(b)

**Seam type SSas-1**

This type of seam shall be formed by:

(a) folding a piece of body material with the face inside, placing the raw edges on a second ply, and seaming with one row of stitches a

specified distance from the raw edge, and

(b) turning the body material face out to envelop the second ply.

Seam Type SSba  
January 25, 1963

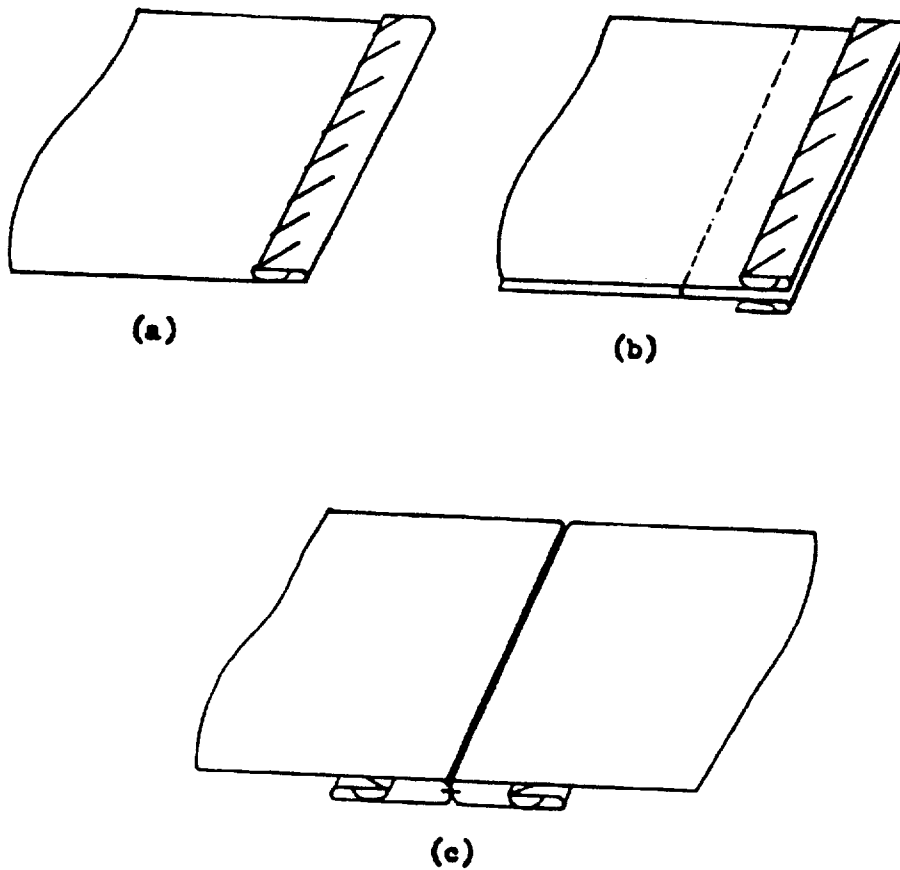

Seam type SSba-3

This type of seam shall be formed by :

- (a) turning the edges of each of two plies of material and stitching the turned portion to the body of the material with one row of stitches,
- (b) superimposing the two plies and seaming

a specified distance from the turned edges with one row of stitches, and

- (c) opening the two plies and turning the edge of each ply under the body to finish as shown.

Seam Type SSbb  
January 25, 1965

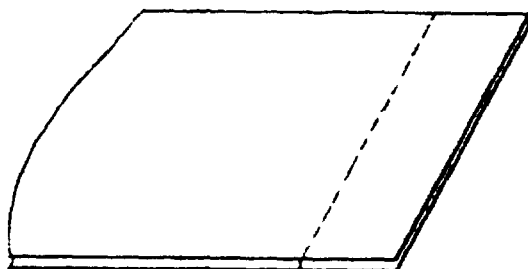

(a)

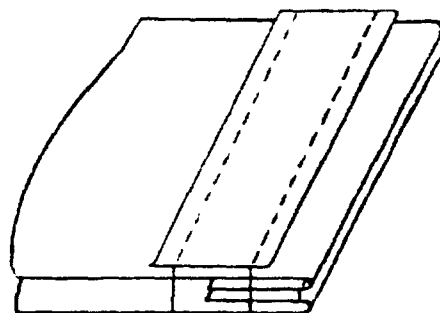

(b)

**Seam type SSbb-3**

This type of seam shall be formed by :

(a) superimposing two plies of material and seaming with a row of stitches a specified distance from the edges in seam type SSa-1, and

(b) turning both plies of material over their edges, superimposing a strip and seaming with two or more rows of stitches.

**Seam Type 330c**  
**January 25, 1965**

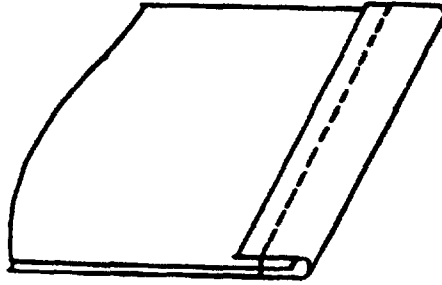

**Seam type 330c-1**

This type of seam shall be formed by superimposing two pieces of material, turning the edge of one ply of material over the edge of the

second ply, and seaming with one or more rows of stitches.

112

**Seam Type SSbd**  
**January 25, 1965**

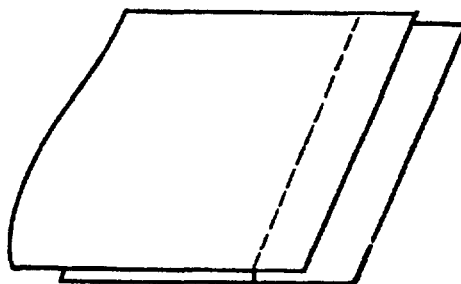

**Seam type SSbd-1**

This type of seam shall be formed by superimposing two plies of material with their edges a specified distance apart and seaming with one

or more rows of stitches a specified distance from the edge of the top ply.

Seam Type SSbe  
January 25, 1965

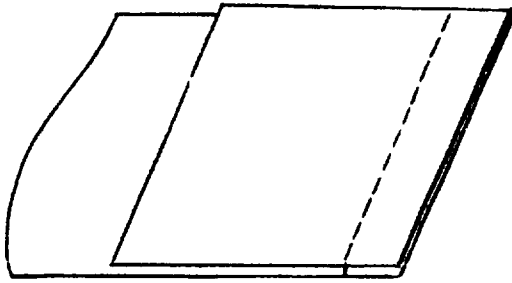

(a)

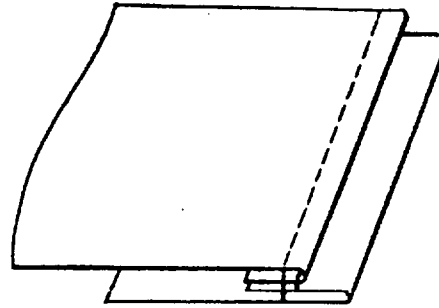

(b)

**Seam type SSbe-2**

This type of seam shall be formed by:

(a) superimposing two plies of material, or a strip on a body material, and seaming with one row of stitches a specified distance from the edges in seam type SSa-1, and

(b) turning one of the plies at the first seaming and folding the other ply a specified distance from the first seaming, and seaming with a row of stitches through all plies.

Seam Type SSbf  
January 25, 1965

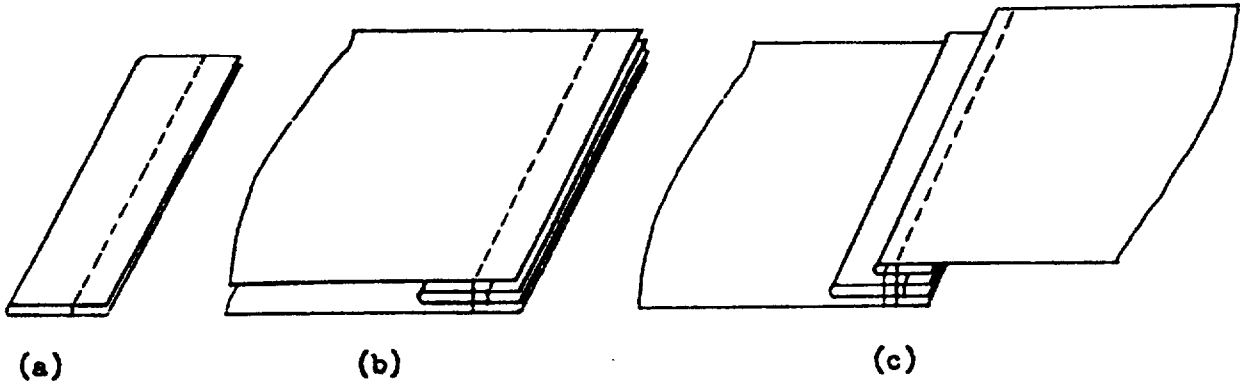

Seam type SSbf-3

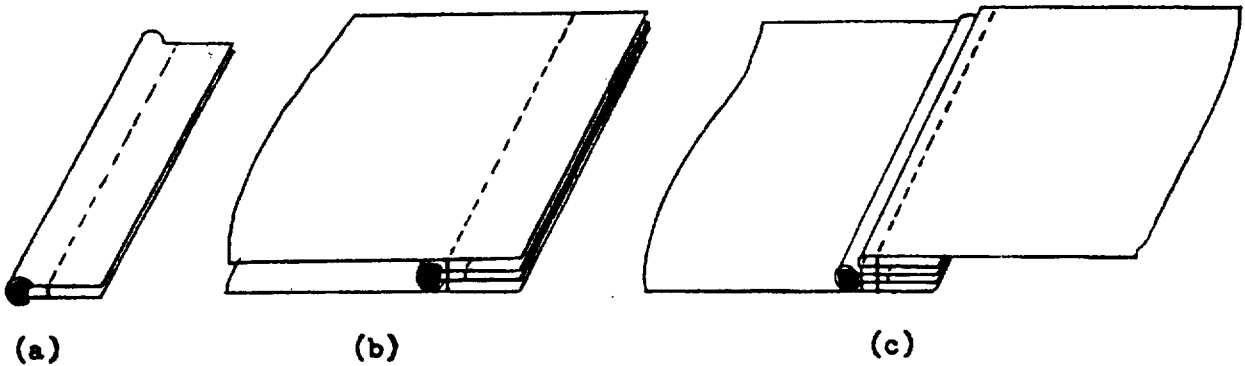

Seam type SSbf-3  
(with cord)

This type of seam shall be formed by:

- (a) folding a strip of material, with or without a cord as specified, and stitching a specified distance from the edge with one row of stitches,
- (b) inserting the folded and stitched strip of

- material between two superimposed plies of material and seaming with one row of stitches, and
- (c) turning the top ply back sharply over the first row of stitches and seaming with one or more rows of stitches.

**Seam Type S5b3**  
**January 25, 1965**

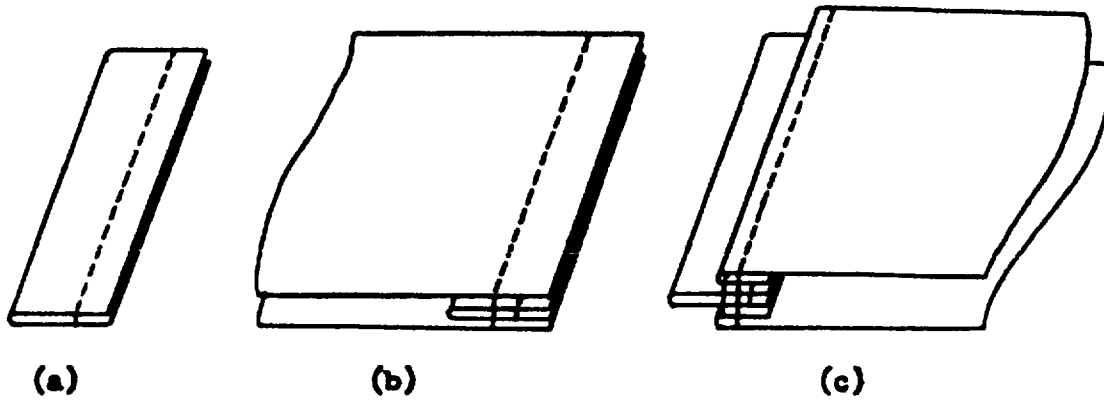

**Seam type S5b3**

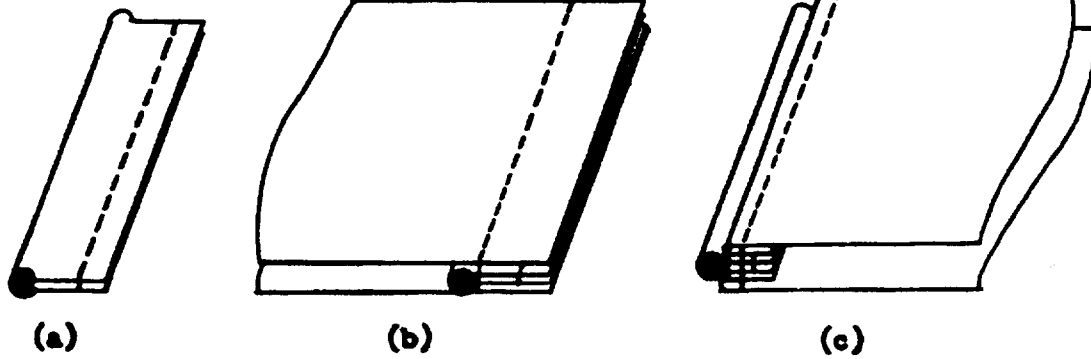

**Seam type S5b3**  
**(with cord)**

This type of seam shall be formed by:  
(a) folding a strip of material, with or without a cord as specified, and stitching a specified distance from the edge with one row of stitches,  
(b) inserting the folded and stitched strip of material between two superimposed plies of ma-

terial and seaming with one row of stitches, and  
(c) turning both plies of material at the seam to cover the raw edges and seaming with one or more rows of stitches through the folded edges.



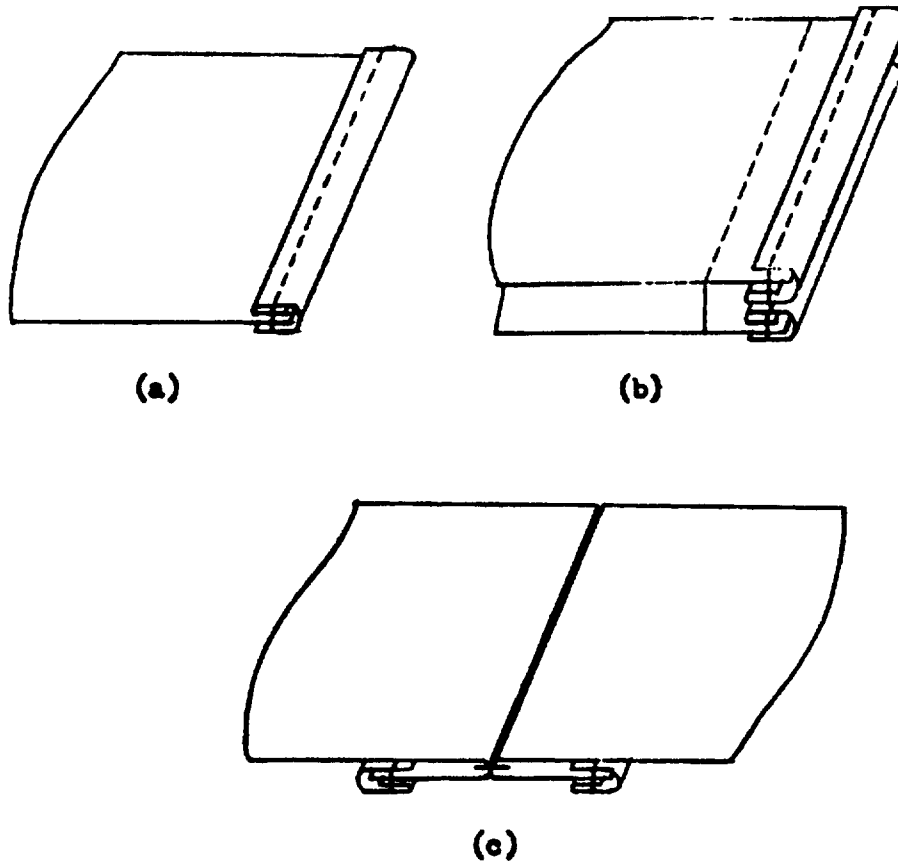

**Seam type SSbh-3**

This type of seam shall be formed by:

(a) binding the edges of two plies of body material by turning one edge of a binding strip, folding it over the edge of the body material, and seaming the binding strip and body material with one row of stitches,

(b) superimposing the two plies and seaming a specified distance from the bound edges with one row of stitches, and

(c) opening the two plies and turning the bound edge of each ply under the body to finish as shown.

**Seam Type LSa**  
**January 25, 1965**

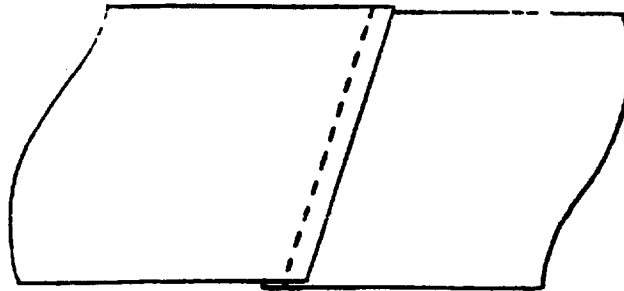

**Seam type LSa-1**

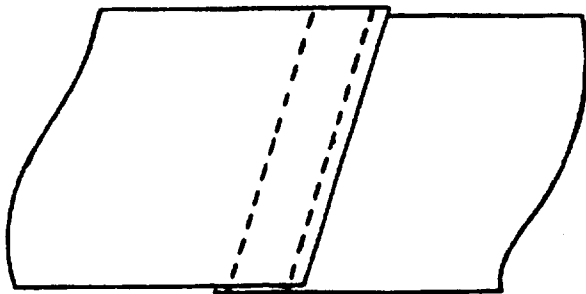

**Seam type LSa-2**

This type of seam shall be formed by overlapping two or more plies of material a speci-

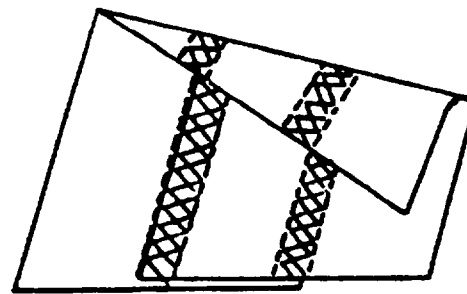

**Seam type LSa-2**

fied distance and seaming with one or more rows of stitches.

**Seam Type LSb**  
**January 25, 1965**

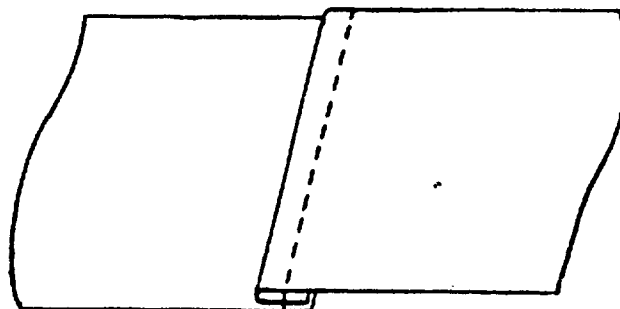

**Seam type LSb-1**

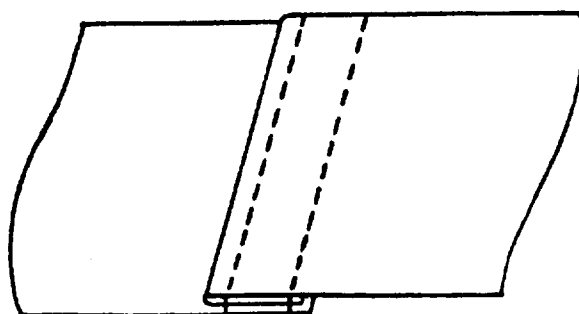

**Seam type LSb-2**

This type of seam shall be formed by folding under the edge of one ply of the material over-

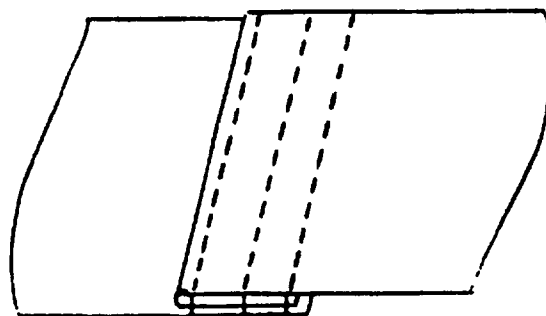

**Seam type LSb-3**

lapping it at the edge of another ply and seaming with one or more rows of stitches.

**Seam Type LSc**  
**January 25, 1965**

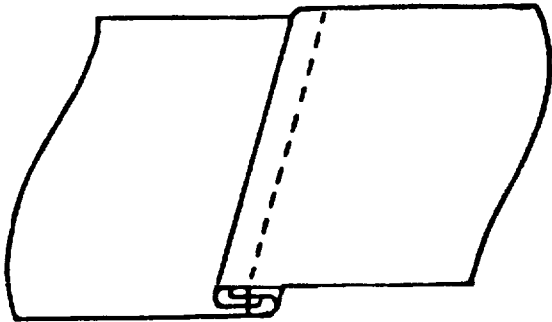

**Seam type LSc-1**

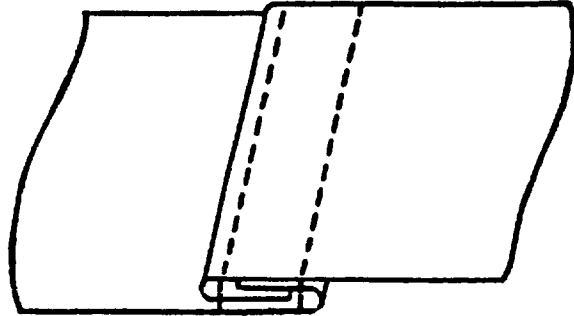

**Seam type LSc-2**

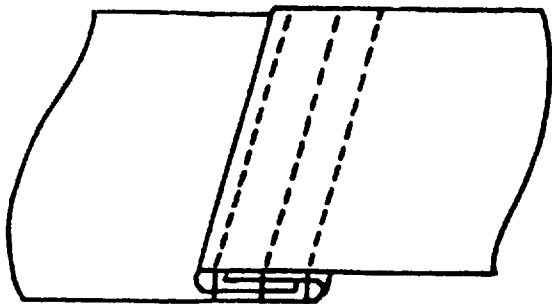

**Seam type LSc-3**

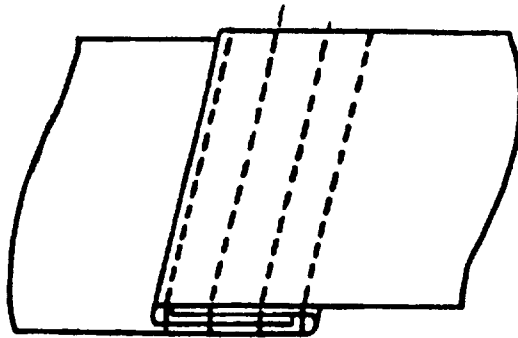

**Seam type LSc-4**

This type of seam shall be formed by folding in and interlapping the edges of two plies of material so that the edges of the material are

concealed and seaming with one or more rows of stitches.

1/20

121

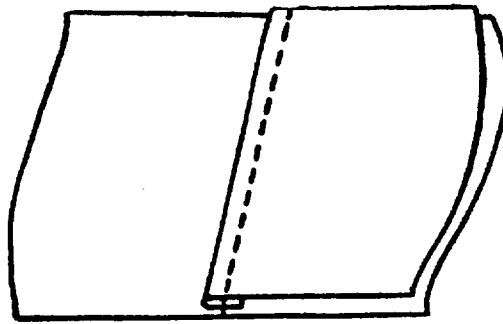

**Seam type LSd-1**

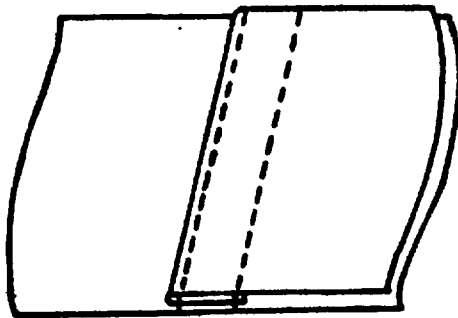

**Seam type LSd-2**

This type of seam shall be formed by folding under the edge of one ply of material, lapping it on the body of another ply of material a spec-

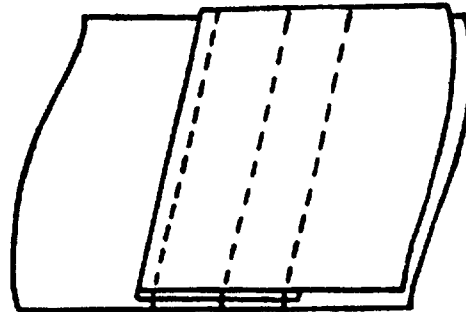

**Seam type LSd-3**

ified distance from the edge, and seaming with one or more rows of stitches.

**Seam Type LSe**  
**January 25, 1965**

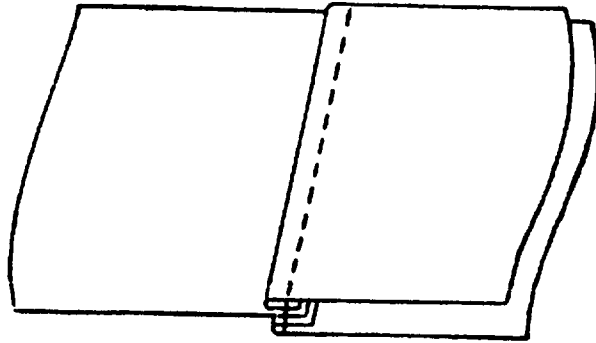

**Seam type LSe-1**

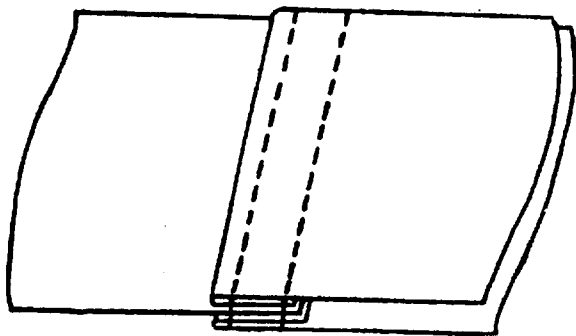

**Seam type LSe-2**

This type of seam shall be formed by folding the edges of each of two plies of material, inserting a third ply of material between the

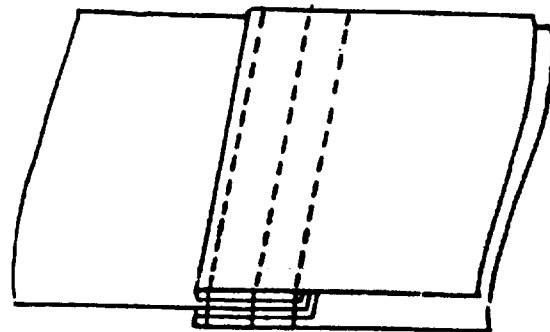

**Seam type LSe-3**

folded edges and seaming all plies with one or more rows of stitches.

**Seam Type Lsf**  
**January 25, 1965**

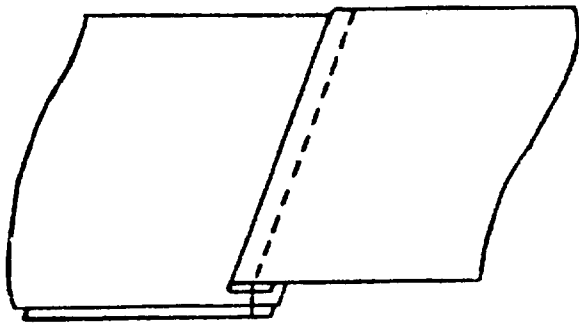

(a)

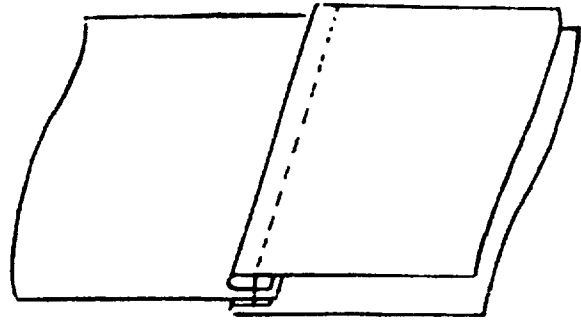

(b)

**Seam type Lsf-1**

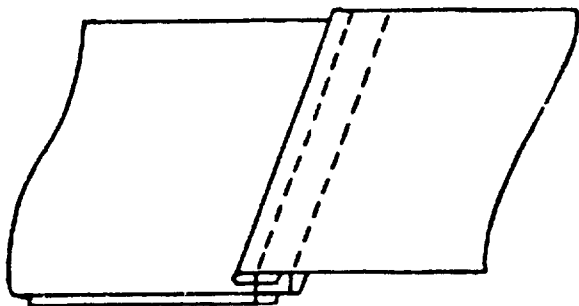

(a)

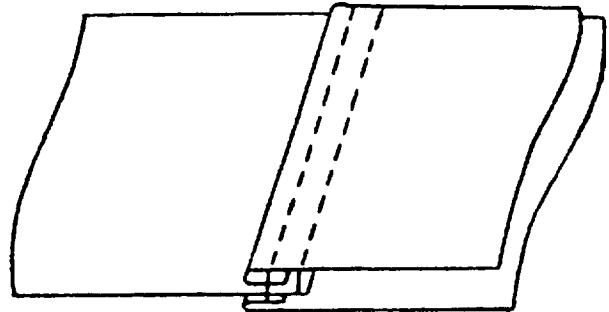

(b)

**Seam type Lsf-2**

This type of seam shall be formed by:  
(a) folding the edge of one ply of material, lapping it on two or more other plies and seaming with one or more rows of stitches. When more than one row of stitches are used, the

inner ply shall be extended so that the second row of stitches does not go through the bottom ply, and

(b) the bottom ply then shall be turned back to lie under the top ply (figure b).

**Seam Type LSg**  
**January 25, 1955**

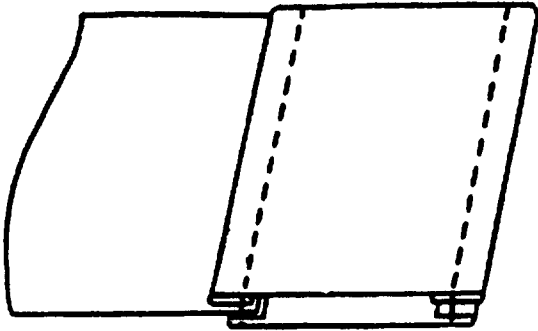

**Seam type LSg-2**

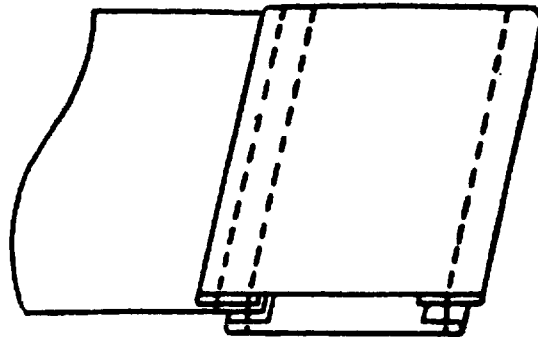

**Seam type LSg-3**

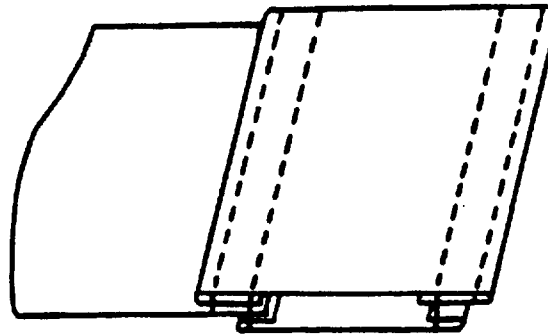

**Seam type LSg-4**

This type of seam shall be formed by folding in both edges of two plies of material, inserting a third ply of material between the folded edges

on one side and seaming each side with one or more rows of stitches.

124



**Seam Type LSj**  
**January 25, 1965**

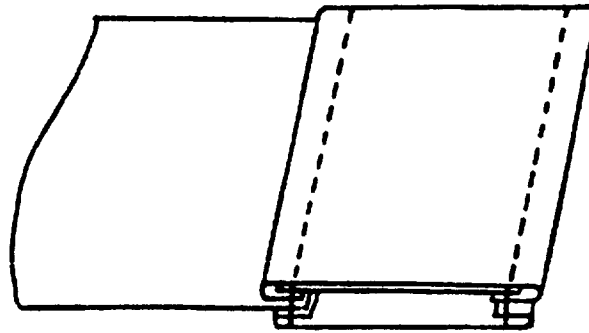

**Seam type LSj-2**

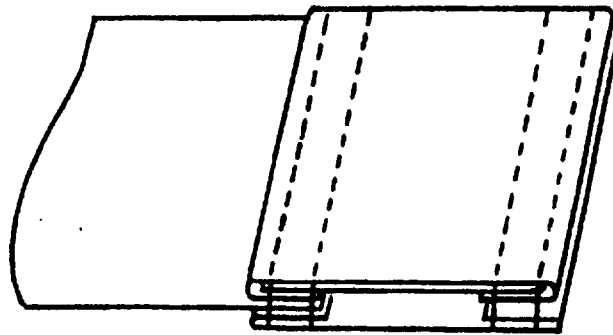

**Seam type LSj-4**

This type of seam shall be formed by folding both edges of two plies of material, inserting a strip in the fold of the top ply, inserting the

body material between the folded edges of both plies on one side and seaming with two or more rows of stitches.

Seam Type LSk  
January 25, 1965

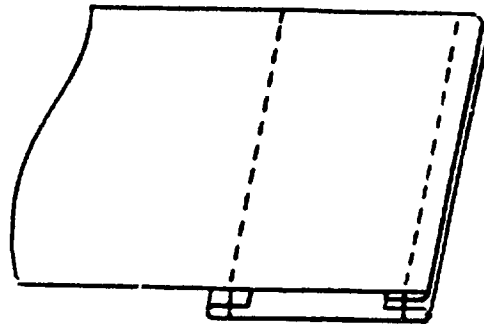
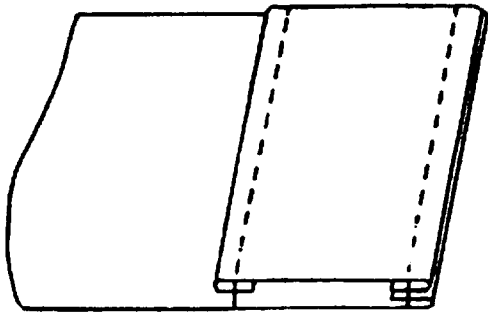

Seam type LSk-2

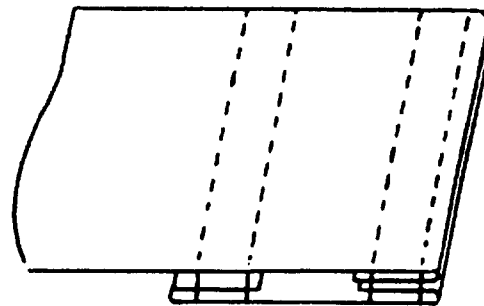
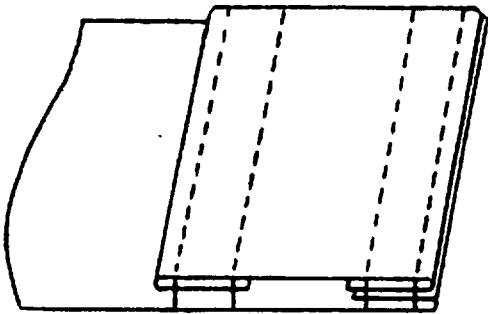

Seam type LSk-4

This type of seam shall be formed by folding both edges of a strip of material and lapping it on the body material whose edge has been

folded in, and seaming with two or more rows of stitches.

126

**Seam Type LS1**  
**January 25, 1965**

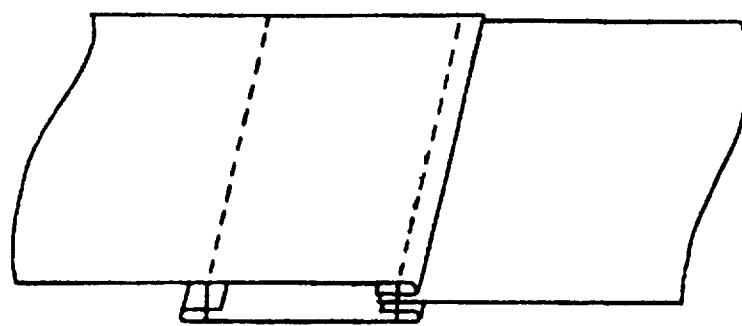

**Seam type LS1-2**

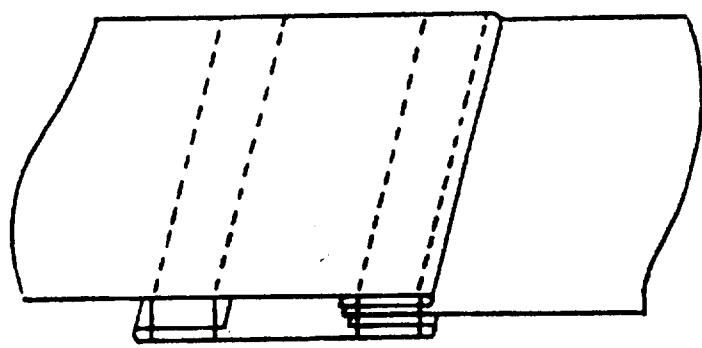

**Seam type LS1-4**

This type of seam shall be formed by folding the edge of a body material, folding both edges of a strip of material, inserting one or more

plies of material between the inturned edges of the body material and the strip, and seaming with two or more rows of stitches.

**Seam Type LSm**  
**January 25, 1955**

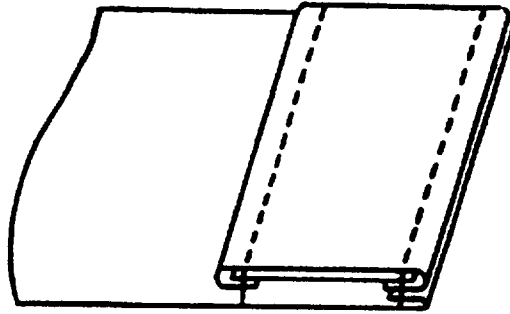

**Seam type LSm-2**

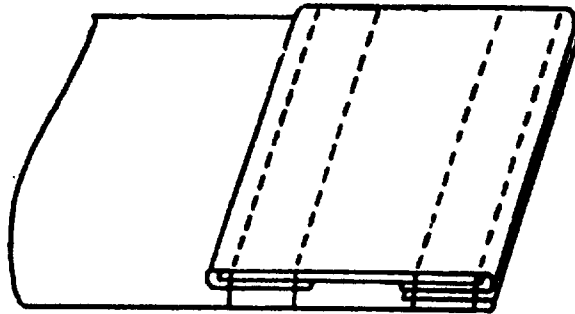

**Seam type LSm-4**

This type of seam shall be formed by folding the edges of a ply of material over a strip, and lapping these two materials over a body material, whose edge has been folded in, and seaming with two or more rows of stitches.

128

**Seam Type L5a**  
**January 25, 1965**

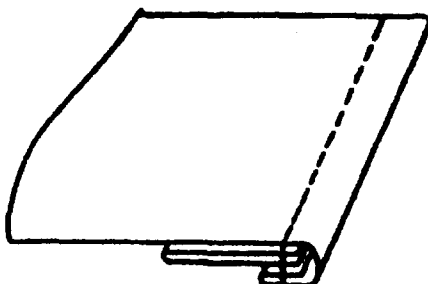

**Seam type L5a-1**

This type of seam shall be formed by double folding the edge of a body material as for a hem (EFb) inserting a folded strip of material between the folded edge and the body of the body material and seaming with one or more rows of stitches.

**FED. STD. NO. 751a**

**Seam Type LSp**  
**January 25, 1965**

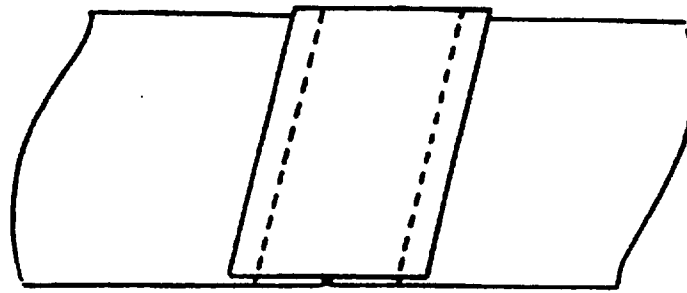

**Seam type LSp-2**

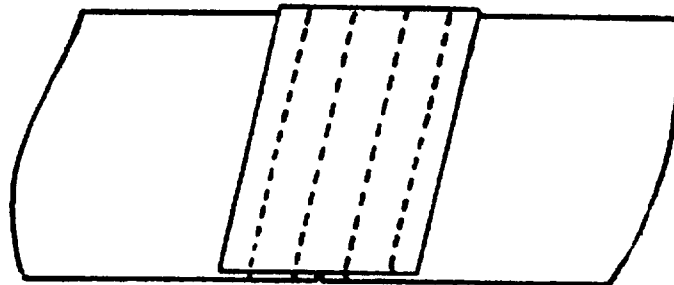

**Seam type LSp-4**

This type of seam shall be formed by overlapping a strip of material over the abutted edges of two or more pieces of material and seaming with two or four rows of stitches.

130

**Seam Type LSq**  
**January 25, 1965**

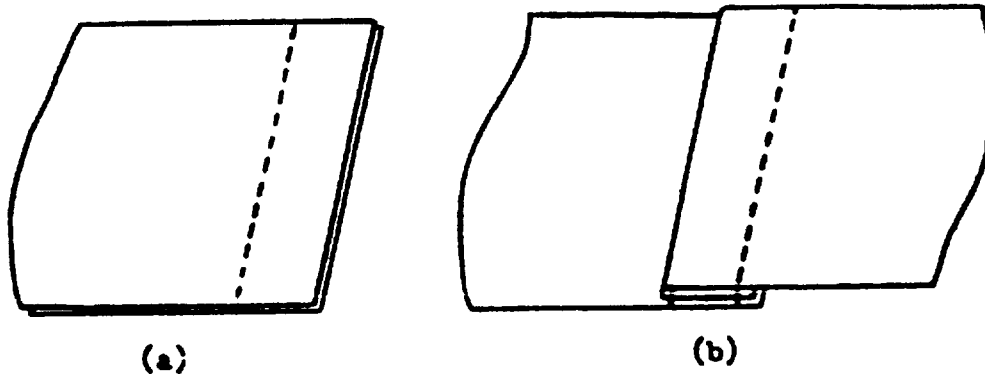

**Seam type LSq-2**

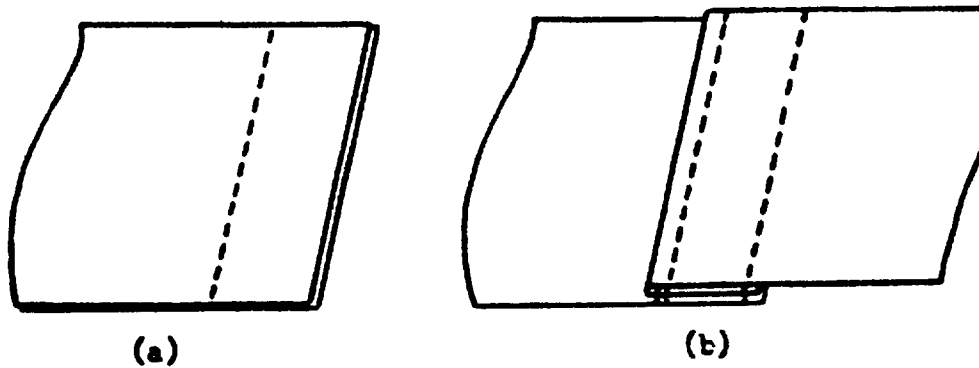

**Seam type LSq-3**

This type of seam shall be formed by:  
(a) superimposing two plies of material and seaming as in seam type SSa-1, and

(b) the top ply shall then be turned back sharply over the first row of stitching and seamed with one or more rows of stitches.

**FED. STD. NO. 751a**

Seam Type LSr  
January 25, 1965

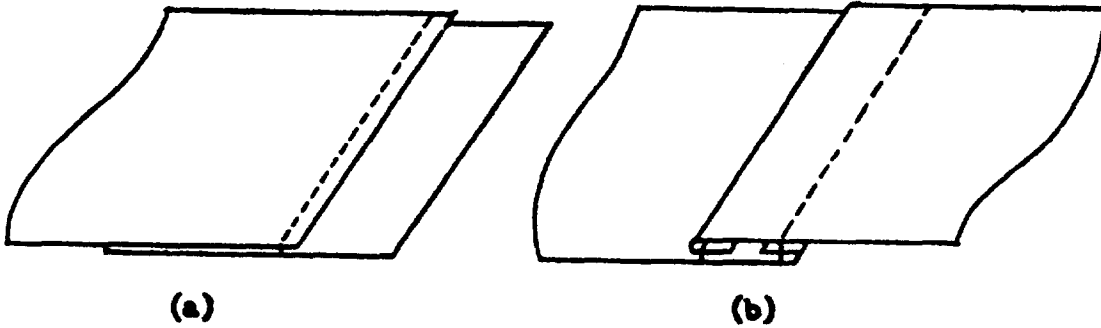

**Seam type LSr-2**

This type of seam shall be formed by:

(a) overlapping two plies of material with their edges a specified distance apart and seaming with one row of stitches a specified distance from the edge of the top ply, and

(b) turning the top ply over the first row of stitching, folding in the edge of the bottom ply and seaming with a second row of stitches through top ply and turned edge of bottom ply.

132

Seam Type LSa  
January 25, 1965

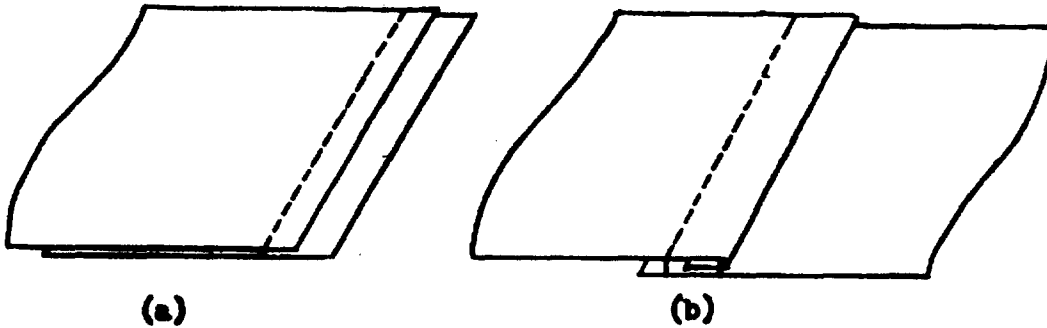

**Seam type LSa-2**

This type of seam shall be formed by:

(a) overlapping two plies of material with their edges a specified distance apart and seaming with one row of stitches a specified distance from the edge of the top ply, and

(b) turning the top ply at the first seam and seaming with a second row of stitches through the bodies of top and bottom plies.



**Seam Type LSt**  
**January 25, 1965**

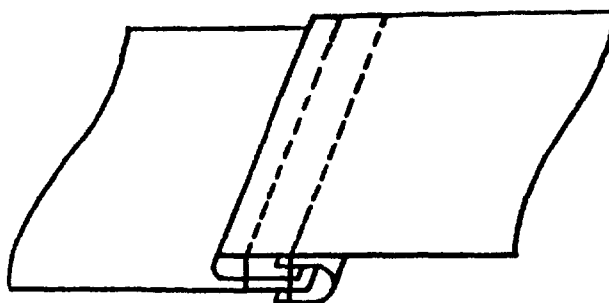

**Seam type LSt-2**

This type of seam shall be formed by folding the edge of one ply of material and lapping it over a second ply, folding a binding strip

over the edge of both plies, and seaming with two rows of stitches, only one of which shall secure the binding strip.

**Seam Type LSu**  
**January 25, 1965**

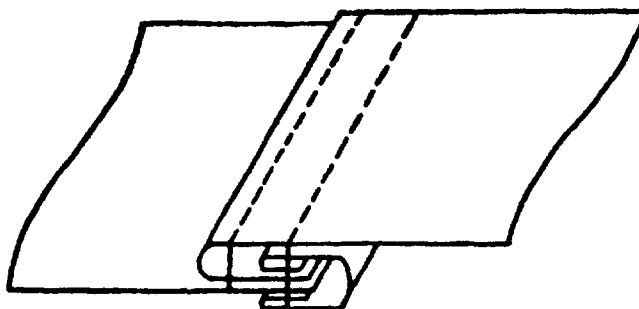

**Seam type LSu-2**

This type of seam shall be formed by turning the edges of one ply of material and lapping it over a second ply, folding a binding strip with both edges folded in over the edge of both

plies of material and seaming with two rows of stitches, only one of which shall secure the binding strip.

Seam Type LSw  
January 25, 1965

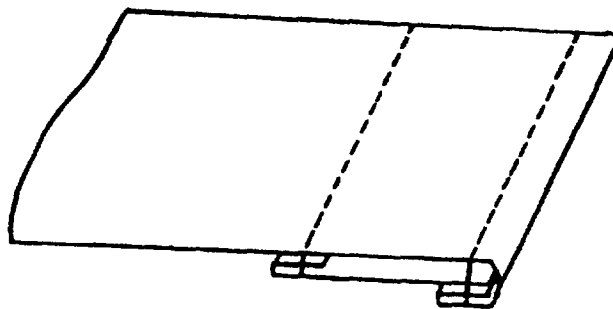

**Seam type LSw-2**

This type of seam shall be formed by double folding the edge of the body material, lapping it over a strip of material so that one edge of the strip is between the body material and its folded

edge, folding the opposite edge of the strip, and seaming the strip to the body of the material with two rows of stitches.

Seam Type LSw  
January 25, 1965

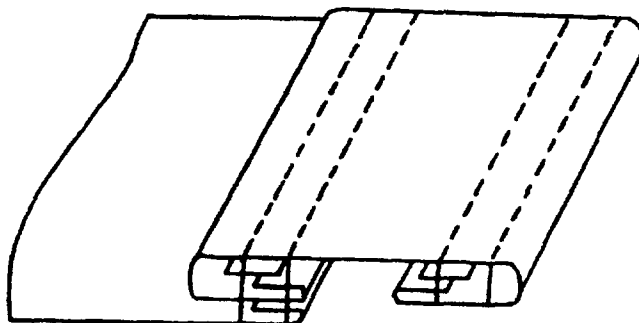

**Seam type LSw-4**

This type of seam shall be formed by double folding each edge of a wide strip of material over a narrow strip, and lapping it over the

folded edge of a body material and seaming with four rows of stitches.

**Seam Type LSx**  
**January 25, 1966**

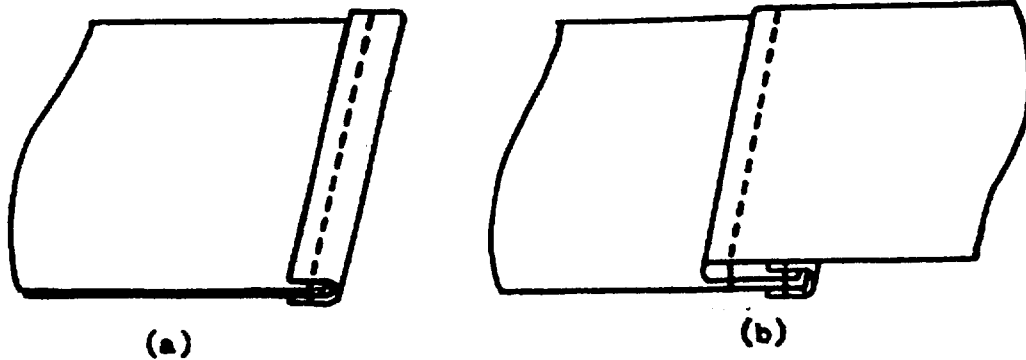

**Seam type LSx-2**

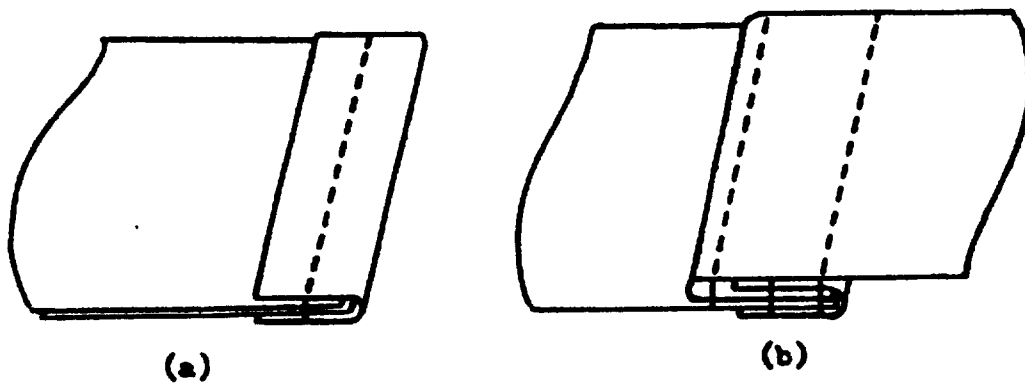

**Seam type LSx-3**

This type of seam shall be formed by:  
(a) superimposing two plies of material, folding a binding strip over the edges of the plies, and seaming the plies and binding strip with one row of stitches, and

(b) turning over the top ply a specified distance from the first row of stitches and seaming with one or more rows of stitches.

Seam Type L5y  
January 25, 1965

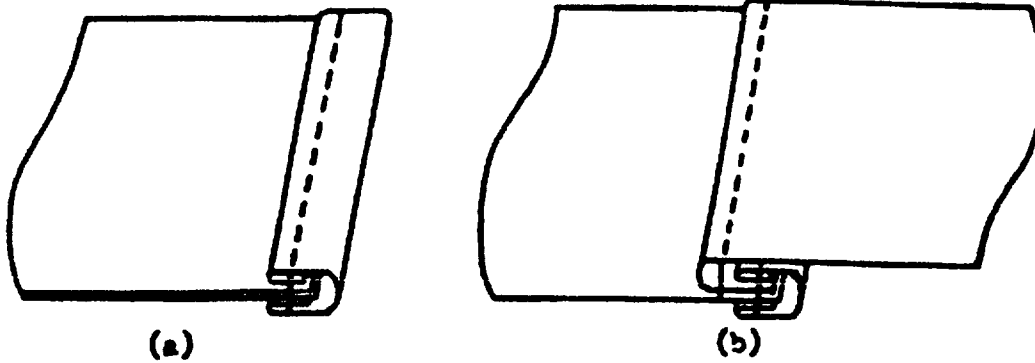

Seam type L5y-2

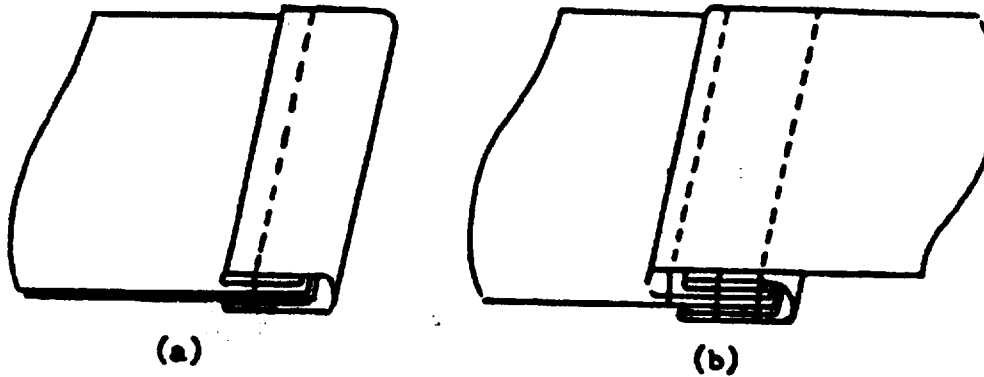

Seam type L5y-3

This type of seam shall be formed by:  
(a) superimposing two plies of material, folding the edges of a binding strip, placing it over the edges of the material and seaming

with one row of stitches, and  
(b) turning the top ply a specified distance from the first row of stitches and seaming with one or more rows of stitches.

136

**Seam Type LSz**  
**January 25, 1965**

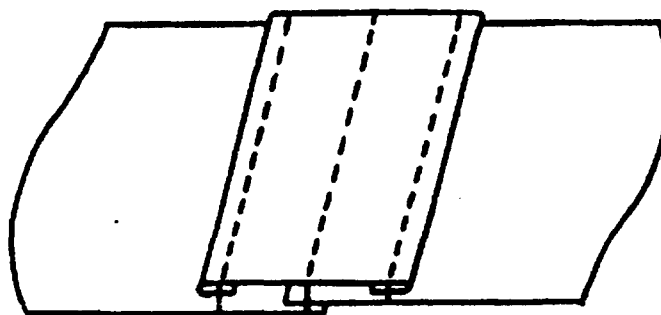

**Seam type LSz-3**

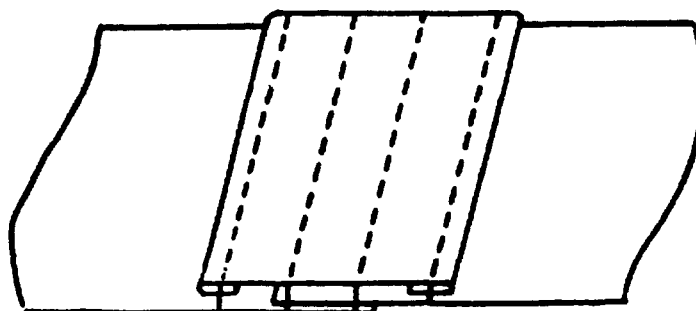

**Seam type LSz-4**

This type of seam shall be formed by overlapping the edges of two or more plies of material, lapping a strip of material with the

edges folded in over the overlapped edges and seaming with three or more rows of stitches.

**Seam Type L3ea**  
**January 25, 1965**

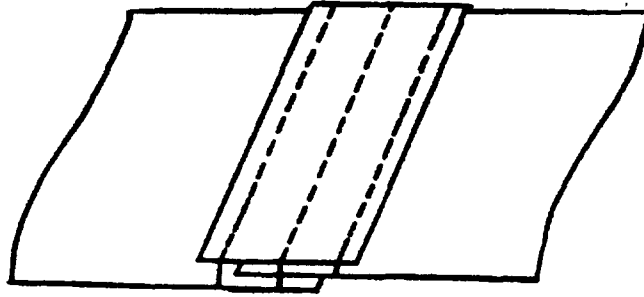

**Seam type L3ea-3**

This type of seam shall be formed by overlapping the edges of two or more plies of material, superimposing a strip of material over

the overlapping edges and seaming with rows of stitches.

138  
8E1

**Seam Type LSab**  
**January 25, 1965**

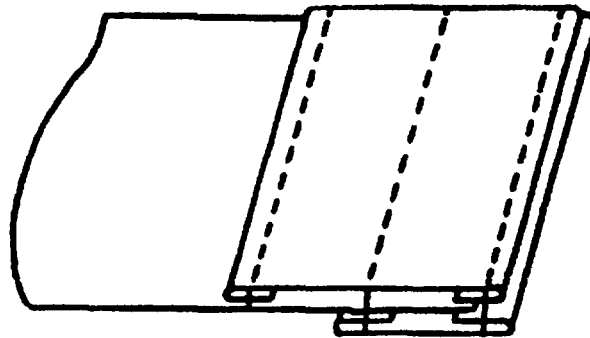

**Seam type LSab-3**

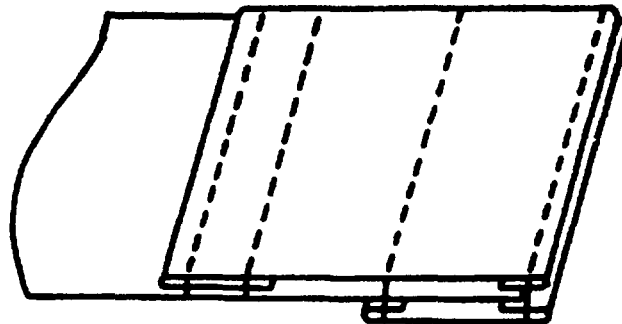

**Seam type LSab-4**

This type of seam shall be formed by folding the edges of a strip of material, lapping it on a second ply and lapping both of these over a third ply substantially different in width with its edges folded, and seaming with three or more rows of stitches as follows: One row

shall join the strips on the outer edges; a second row of stitches shall join the top strip, the middle ply and the bottom ply through the turned edge, and the remaining row or rows shall join the top strip to the middle ply.

LSab

Seam Type LSac  
January 25, 1935

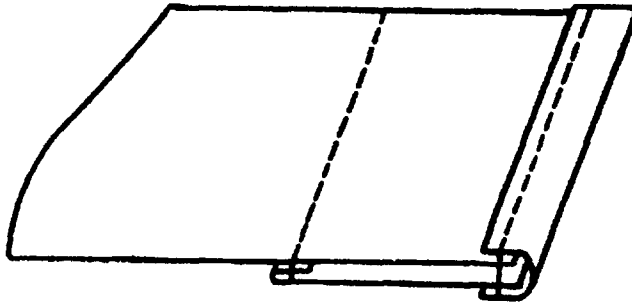

**Seam type LSac-2**

This type of seam shall be formed by lapping a ply of body material over a narrow strip, one edge of which shall be folded in under the top ply, placing a binding strip over the other edges of the strip and body material and seaming with two or more rows of stitches.

140

Seam Type LSad  
January 25, 1935

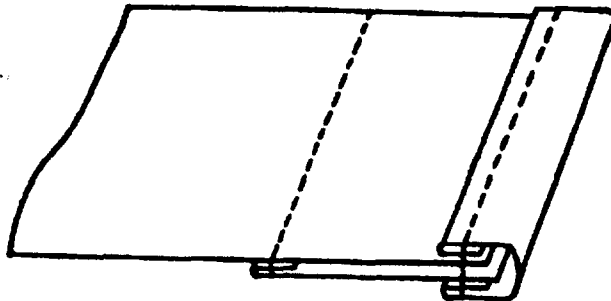

**Seam type LSad-2**

This type of seam shall be formed by lapping a ply of body material over a narrow strip, one edge of which is folded in under the body of the first ply, placing a binding strip with both edges folded in over the other edges of the strip and body material and seaming with two or more rows of stitches.



Seam Type L8ac  
January 25, 1935

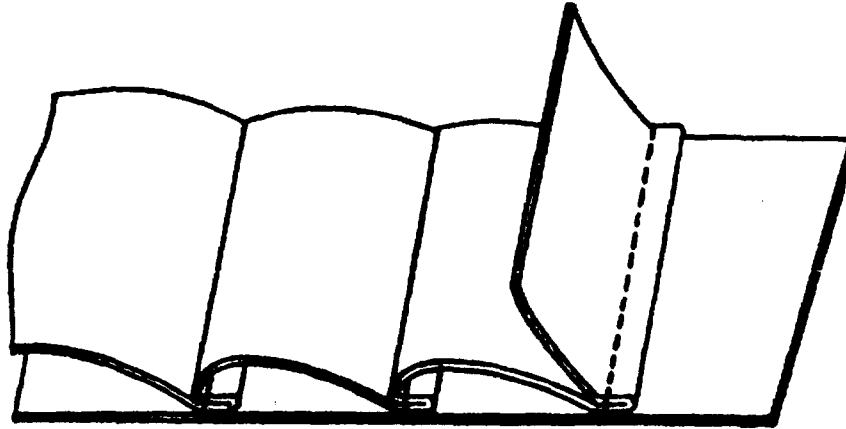

**Seam type L8ac-1**

This type of seam shall be formed by lapping one ply of material on to a second ply, folding the top ply back and seaming through

the folded portion to the second ply with one or more rows of stitches. Note: the drawing illustrates the basic seam and two repeats.

Seam Type L8af  
January 25, 1935

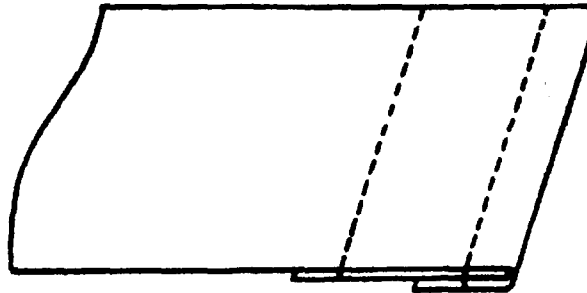

**Seam type L8af-2**

This type of seam shall be formed by lapping one ply of material over a second ply, turning the edge of the first ply around the edge of the second ply and seaming with two or more rows of stitches.

Seam Type LSag  
January 25, 1965

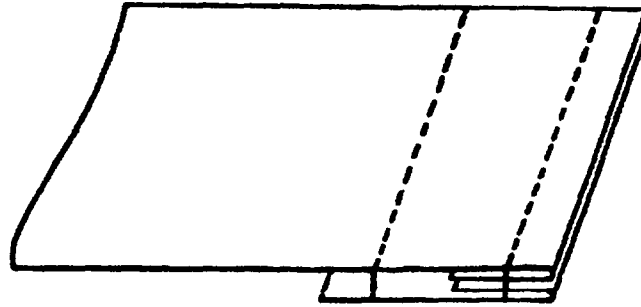

**Seam type LSag-2**

This type of seam shall be formed by lapping one ply of material over a second ply, folding one edge of each ply to the inside, and seaming with two or more rows of stitches.

Seam Type LSah  
January 25, 1965

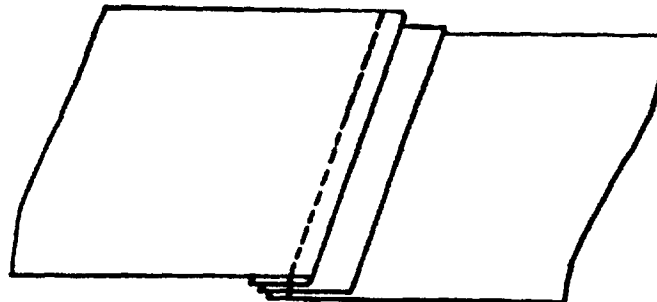

**Seam type LSah-1**

This type of seam shall be formed by lapping the folded edge of one ply of material over a second ply, inserting a strip between and seaming all plies with one or more rows of stitches.

142

**Seam Type LSaj**  
**January 25, 1965**

1193

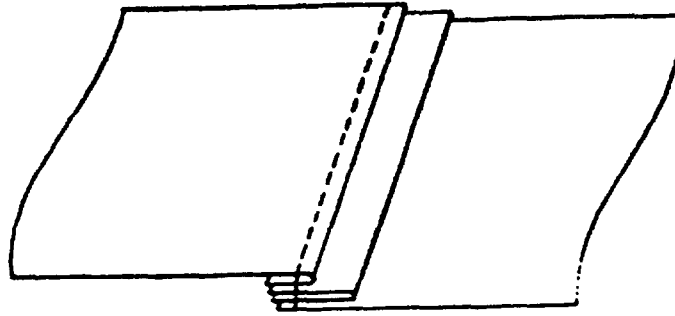

**Seam type LSaj-1**

This type of seam shall be formed by lapping the folded edge of one ply of material over a second ply, inserting a folded strip between the

two plies, and seaming all plies with one or more rows of stitches.

**Seam Type LSak**  
**January 25, 1965**

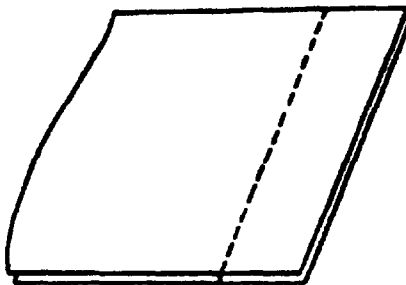

(a)

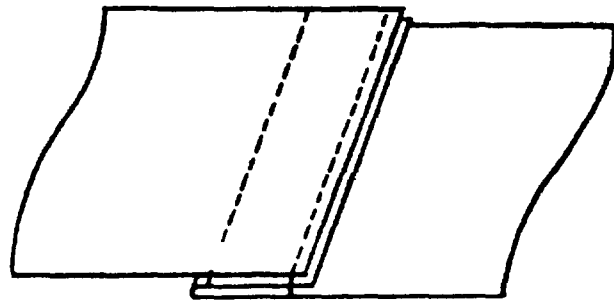

(b)

**Seam type LSak-2**

This type of seam shall be formed by:

(a) superimposing two plies of material and seaming with one row of stitches, seam type SSa-1, and

(b) turning the bottom ply over the first row of stitches and seaming with one or more rows of stitches.

**Seam Type LSa1**  
**January 25, 1965**

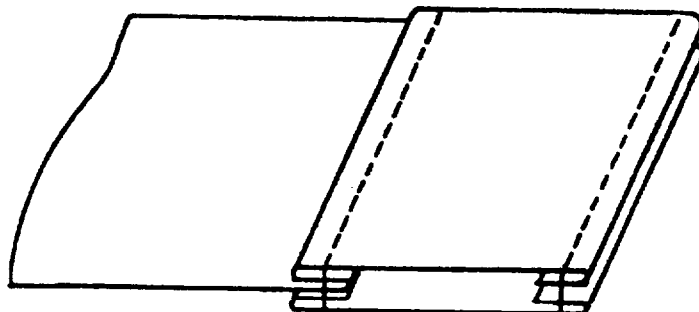

**Seam type LSa1-2**

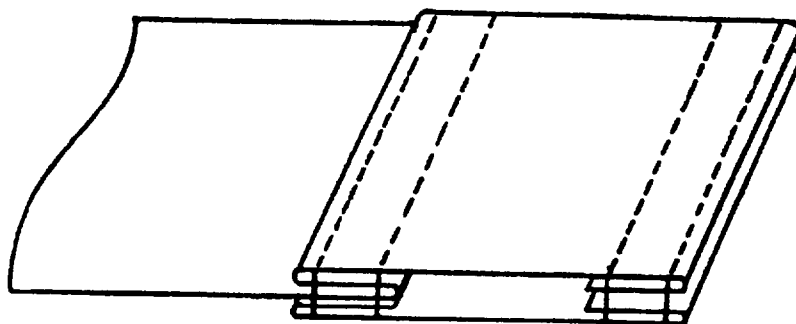

**Seam type LSa1-4**

This type of seam shall be formed by folding one ply of material into an "S" fold at a specified distance from the edge, folding in the edge

and lapping it over a strip of material with the edges folded in and seaming with two or more rows of stitches.

144

**Seam Type L3am**  
**January 25, 1985**

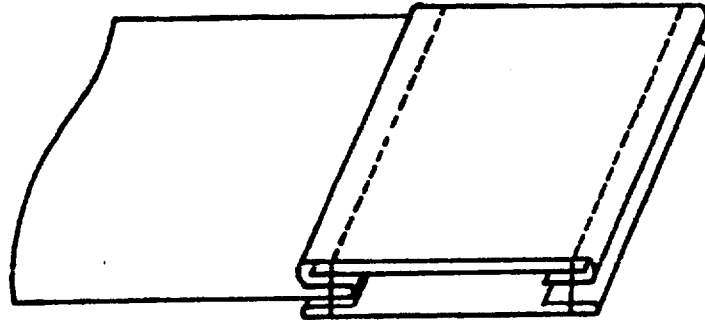

**Seam type L3am-2**

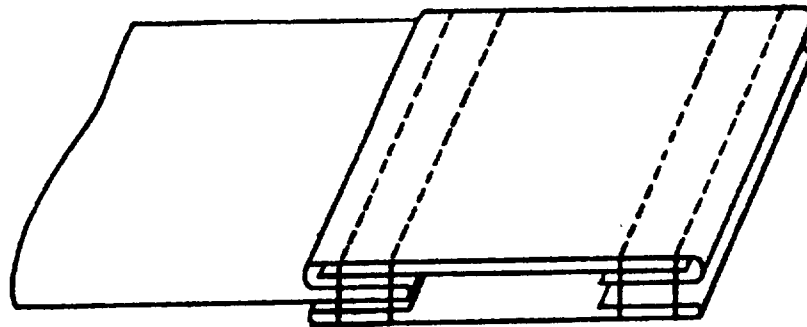

**Seam type L3am-4**

This type of seam shall be formed by folding one ply of material into an "S" fold, folding in the outer edge, inserting an interlining strip in

the folds, and lapping these over another ply whose edges shall be folded in, and seaming with two or more rows of stitches.

**Seam Type LSan**  
**January 25, 1965**

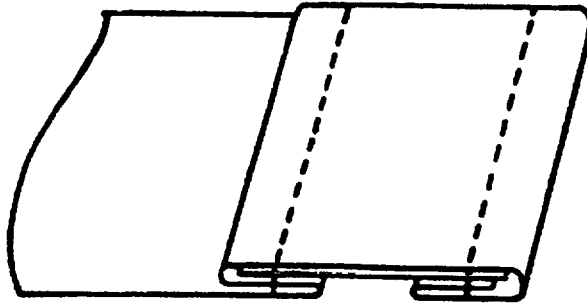

**Seam type LSan-2**

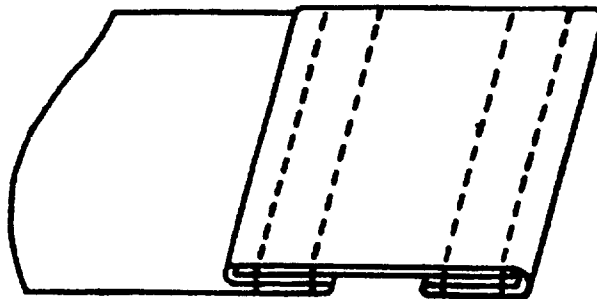

**Seam type LSan-4**

This type of seam shall be formed by folding one ply of material into an "S" fold, turning in and folding over the outer edge, inserting an

interlining strip, and seaming with two rows of stitches.

Seam Type LSap  
January 25, 1935

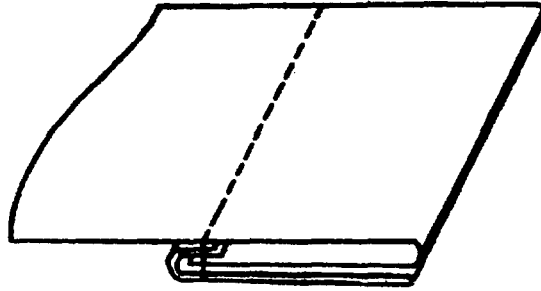

**Seam type LSap-1**

This type of seam shall be formed by folding one ply of material over on itself, lapping it on another folded ply, folding the edges of the bottom ply over the folded edge of the top ply and seaming with one or more rows of stitches through all plies of material at the folded in edges.

Seam Type LSaq  
January 25, 1935

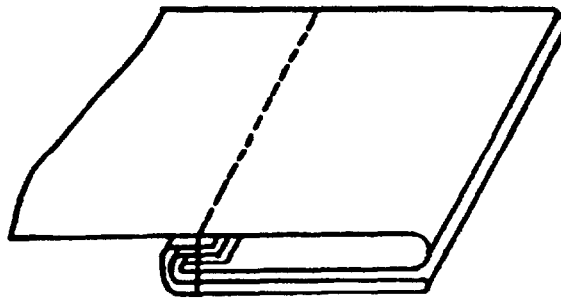

**Seam type LSaq-1**

This type of seam shall be formed by folding one ply of material over on itself, folding the edge in, lapping it on another folded ply whose edge shall be folded in between the body of the first ply and its folded edge, and seaming with one or more rows of stitches through all plies at the folded in edges.

FED. STD. NO. 51a

**Seam Type LSar**  
**January 25, 1965**

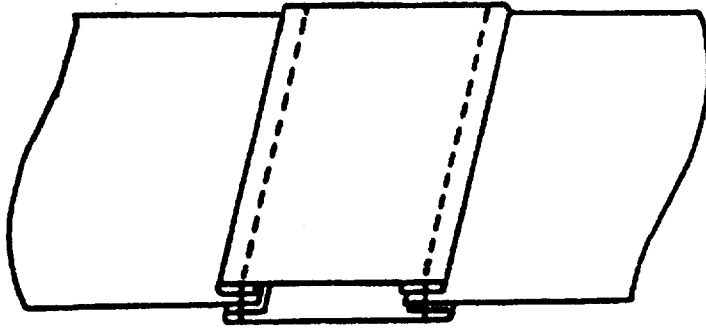

**Seam type LSar-2**

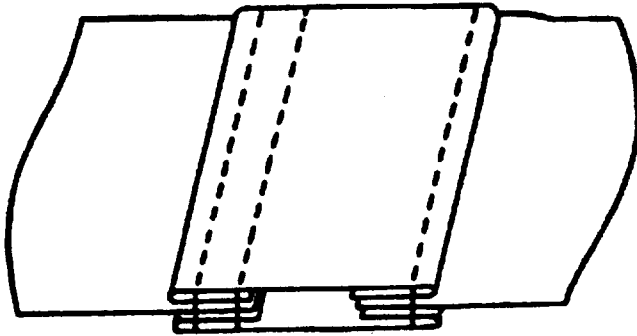

**Seam type LSar-3**

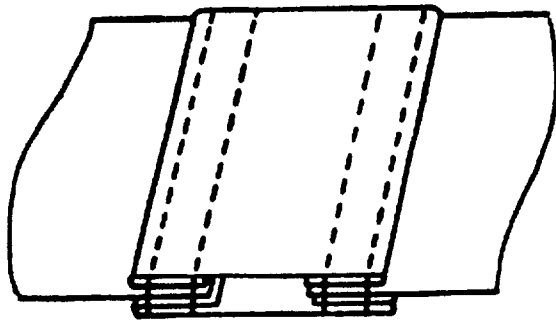

**Seam type LSar-4**

This type of seam shall be formed by folding the edges of two strips of material, lapping one on the other, inserting two or more pieces of material between them at the folded

edges, and seaming with two or more rows of stitches through the folded edges and inserted material.



**Seam Type LSas**  
**January 25, 1965**

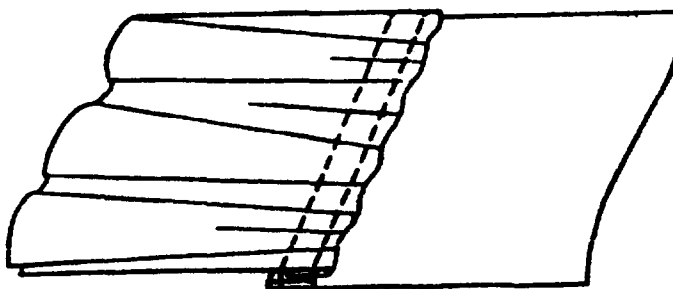

**Seam type LSas-2**

This type of seam shall be formed by folding the edges of two plies of material, lapping the

folded edges over each other, and seaming with two or more rows of stitches.

179

**Seam Type LSat**  
**January 25, 1965**

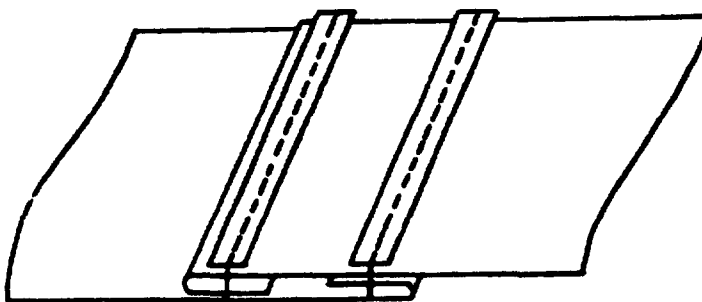

**Seam type LSat-2**

This type of seam shall be formed by lapping two plies of material with edges folded in, placing a strip of material on the top ply over each

turned edge, and seaming with one row of stitches through each strip and all three plies of material.

**Seam Type LSau**  
**January 25, 1965**

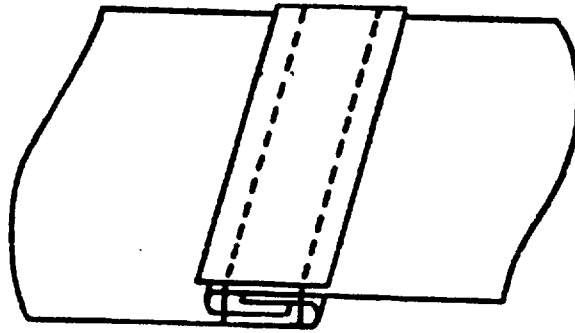

**Seam type LSau-2**

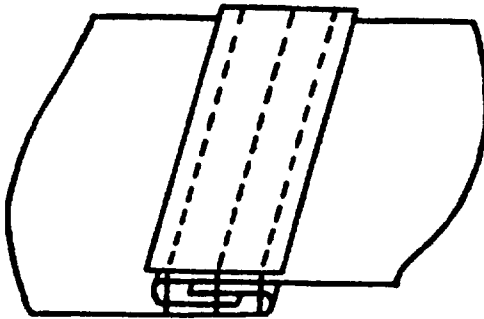

**Seam type LSau-3**

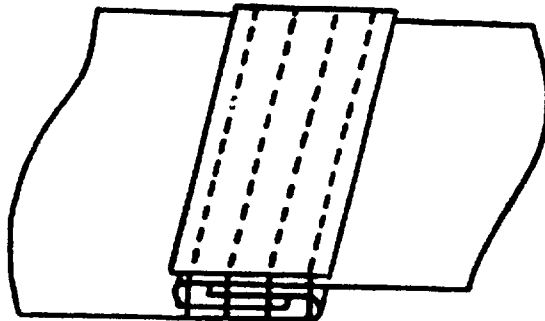

**Seam type LSau-4**

This type of seam shall be formed by folding and interlapping the edges of two plies of material so that their edges are concealed, placing

a strip of material on the top ply over the folded edges and seaming with two or more rows of stitches.

251

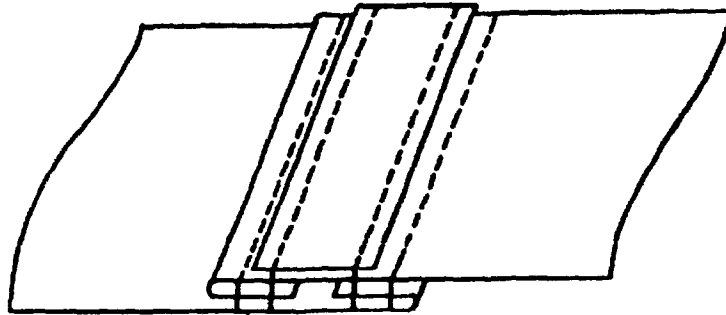
**Seam type LSav-1**

This type of seam shall be formed by lapping two plies of material, folding in the edges of both plies, placing a strip on the top ply, and

stitching with four rows of stitches, two rows through the strip and the remaining two through the folded edges of the material.

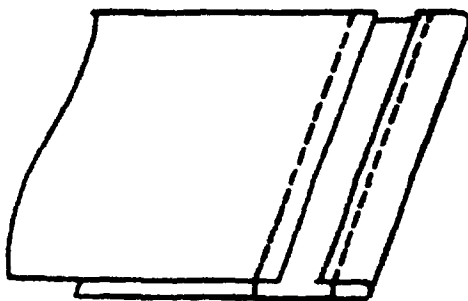

(a)

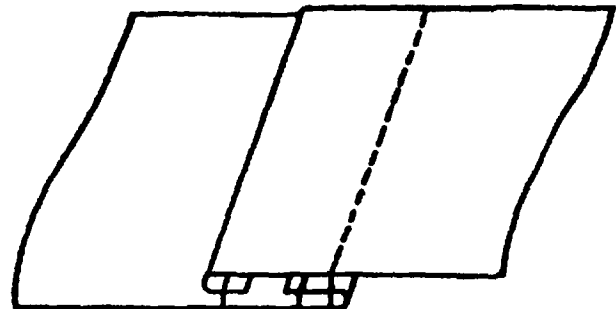

(b)

**Seam type LSav-3**

This type of seam shall be formed by:

(a) lapping one ply of material over another a specified distance from the edge, folding the edge of the bottom ply and seaming with two rows of stitches, one through the edge of the top ply and body of the second ply and one

through the folded edge of the bottom ply, and (b) turning the top ply over at the row of stitching and seaming with one row of stitches through the body of the top ply and turned edge of the bottom ply.

Seam Type LSax  
January 25, 1965

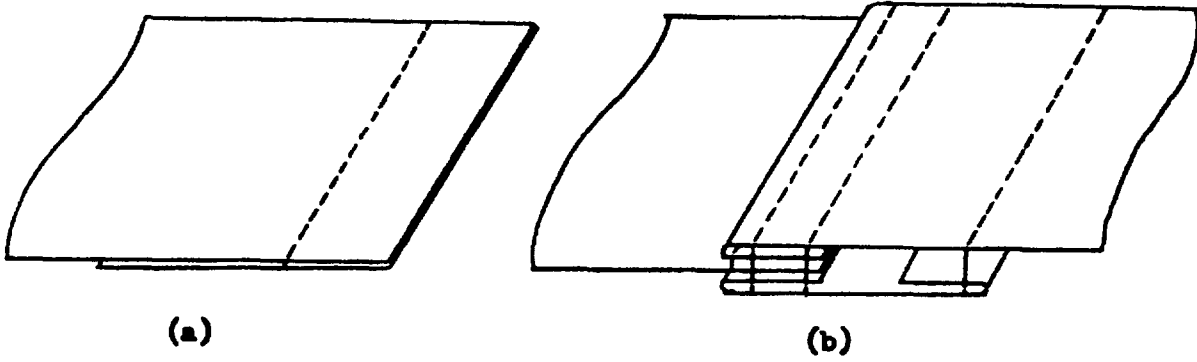

Seam type LSax-4

This type of seam shall be formed by:  
(a) superimposing two plies of material and seaming with one row of stitches a specified distance from the edge in seam type SSa-1, and

(b) turning the top ply at the first row of stitches, superimposing on a third ply with edges folded and seaming with three rows of stitches.

Seam Type LSay  
January 25, 1965

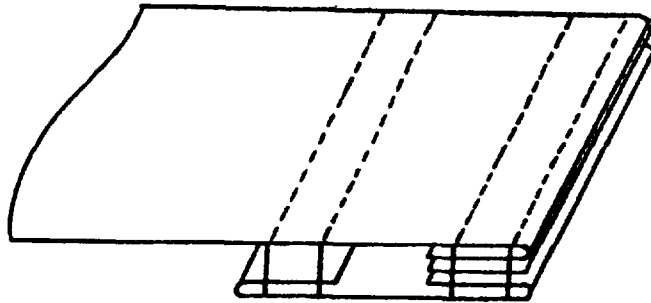

Seam type LSay-4

This type of seam shall be formed by folding the edges of a strip of material and lapping it on the body material whose edge has been folded

in, inserting a strip between the folded edges of the body material and the strip, and seaming with four rows of stitches.

152

**Seam Type LSeS**  
**January 25, 1965**

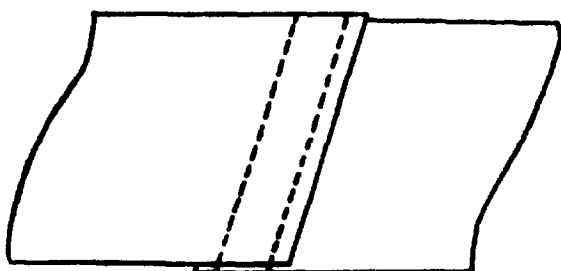

(a)

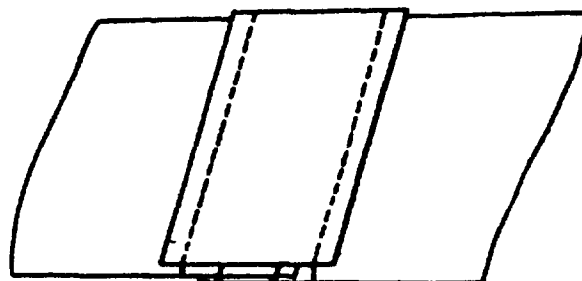

(b)

**Seam type LSeS-4**

This type of seam shall be formed by:

(a) overlapping two plies of material and seaming with two rows of stitches in seam type LSe-2, and

(b) placing a strip or tape over the first seam and seaming with two rows of stitches beyond each of the overlapped edges of the material.

**Seam Type LSeSb**  
**January 25, 1965**

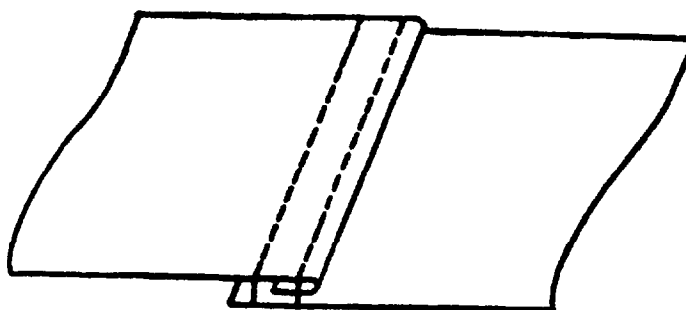

**Seam type LSeSb-2**

This type of seam shall be formed by folding the edge of a ply of material and lapping it on another ply, and seaming with two rows of

stitches. Only one row of the stitches shall pass through the turned under edge.

Seam Type LSbb  
January 25, 1965

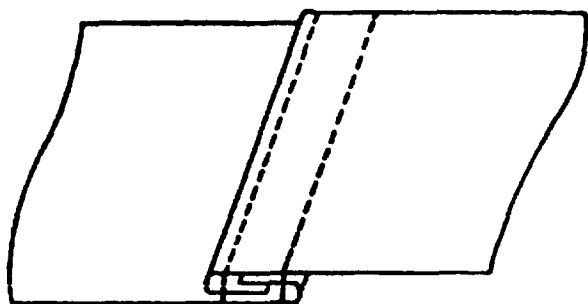

(a)

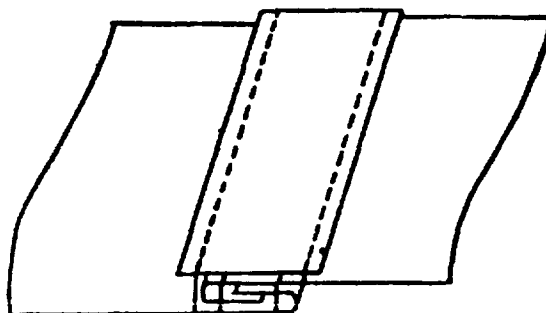

(b)

**Seam type LSbb-1**

This type of seam shall be formed by:

(a) lapping two plies of material, folding both edges in and seaming with two rows of stitches as in seam type LSc-2, and

(b) placing a strip or tape over the first seam and seaming it to the body material with a row of stitches on each side of the seam.

LSbb

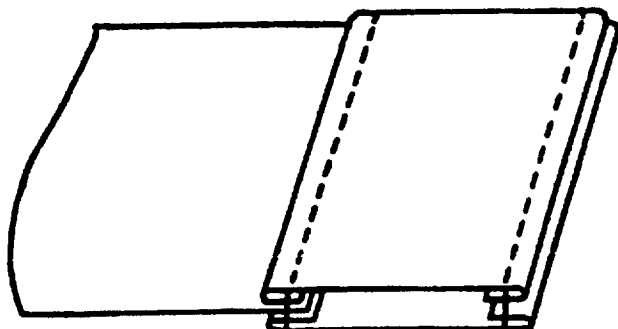

**Seam type LSbc-2**

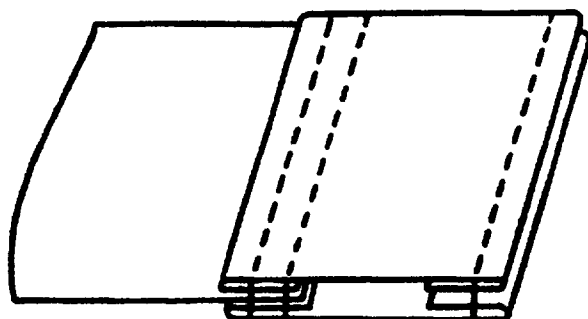

**Seam type LSbc-3**

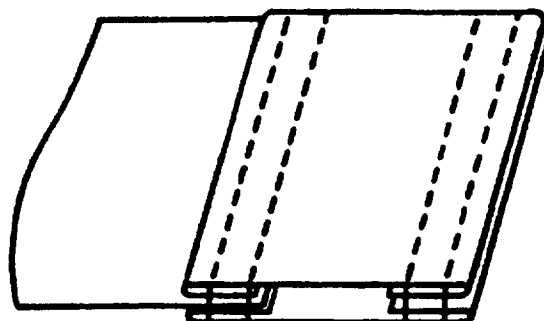

**Seam type LSbc-4**

This type of seam shall be formed by folding in both edges of two plies of material, lapping one on the other, inserting a third ply of ma-

terial between them and seaming with two or more rows of stitches.

Seam Type LSbd  
January 25, 1963

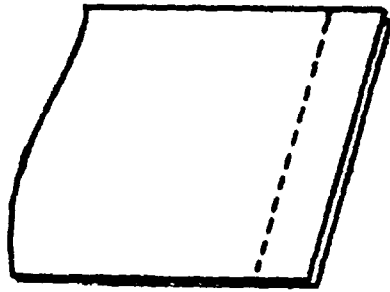

(a)

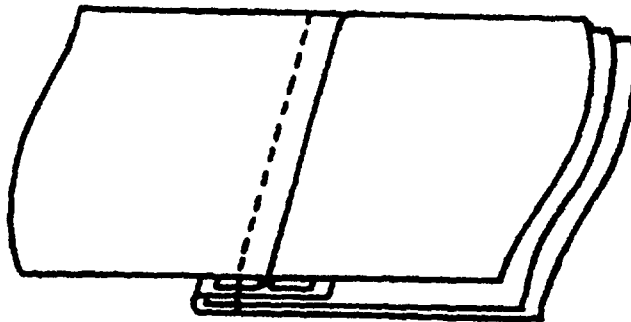

(b)

**Seam type LSbd-2**

This type of seam shall be formed by superimposing two plies of material and seaming with one row of stitches in seam type SSe-1; opening the two plies and turning the edges of each ply back under the body of the ply; overlapping the seam onto two plies of material, the

edge of one ply which has been turned up over the edge of the other ply, and seaming through all plies with one row of stitches on the side of the seam nearest the folded edge of the bottom ply.

157



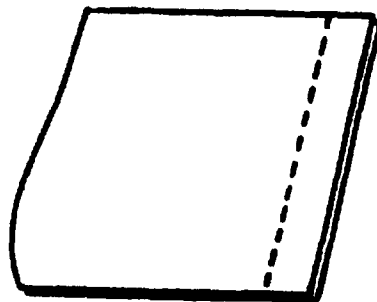

(a)

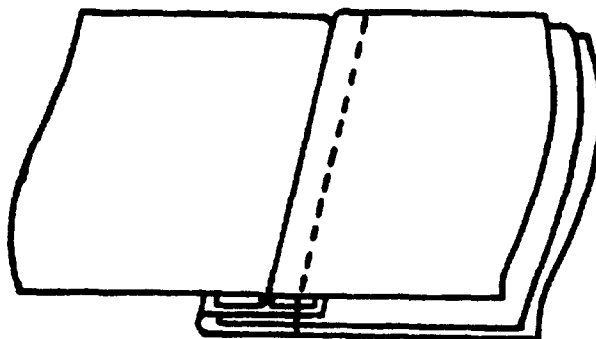

(b)

**Seam type LSbe-2**

This type of seam shall be formed by superimposing two plies of material and seaming with one row of stitches in seam type SSe-1; opening the two plies and turning the edges of each ply back under the body of the ply; overlapping the seam onto two plies of material,

the edge of one ply which has been turned up over the other ply, and seaming through all plies with one row of stitches on the side of the seam furthest from the folded edge of the bottom ply.

**Seam Type LSbf**  
**January 25, 1998**

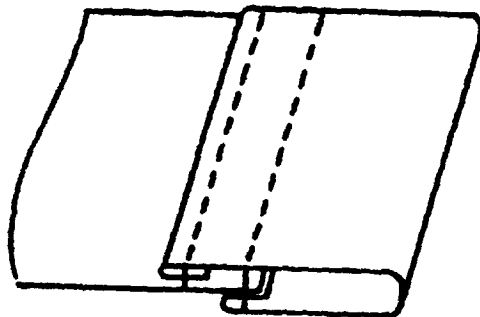

**Seam type LSbf-2**

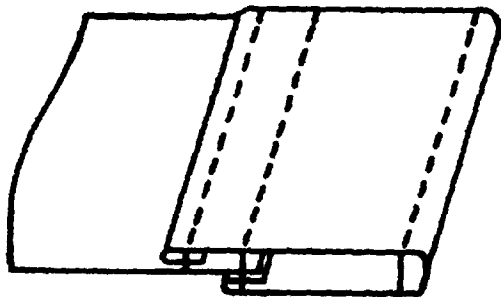

**Seam type LSbf-3**

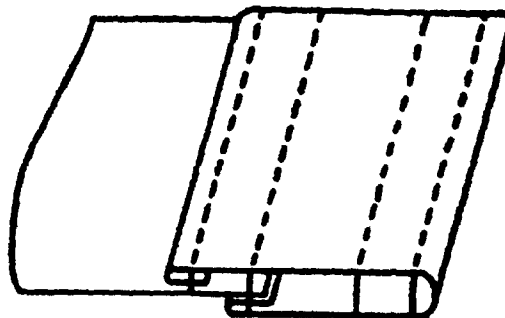

**Seam type LSbf-4**

This type of seam shall be formed by turning both edges of a strip, folding it over the edge of a ply of material, the lower ply not extending

as deep as the upper ply and seaming with two or more rows of stitches.

851

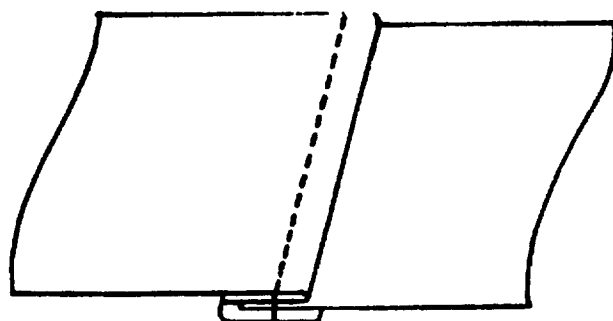

(a)

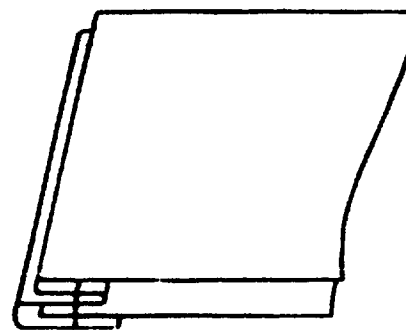

(b)

**Seam type LSbg-1**

**This type of seam shall be formed by:**

**(a) turning the edge of one ply of material in a reverse "S" fold, inserting a second ply in the fold nearer the edge, seaming with one row**

**of stitches, and**

**(b) turning the upper ply back to form the finished seam.**

**Seam Type LSbh**  
**January 25, 1965**

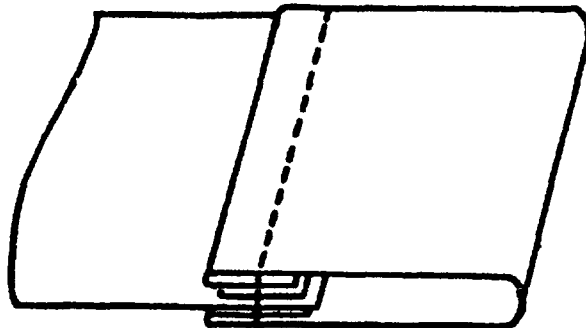

**Seam type LSbh-1**

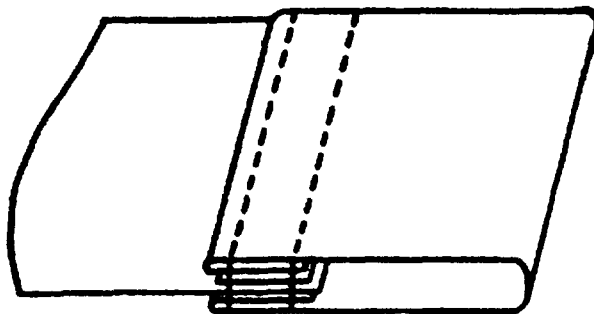

**Seam type LSbh-2**

This type of seam shall be formed by turning both edges of a strip and folding it over the ply or plies of body material. A tape shall be inserted between one folded edge of the binding strip and the body material and seamed with one or more rows of stitches.

**Seam Type LSbj**  
**January 25, 1965**

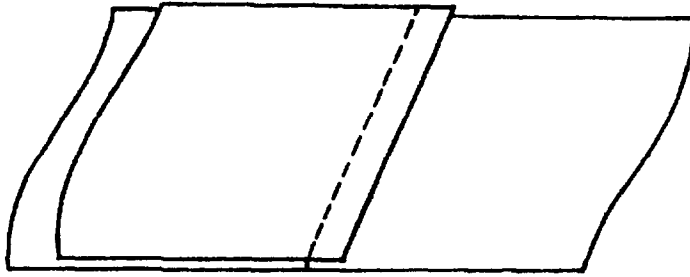

**Seam type LSbj-1**

This type of seam shall be formed by lapping a ply of material on a body material and seam- ing with one or more rows of stitches.

**Seam Type LSbk**  
**January 25, 1965**

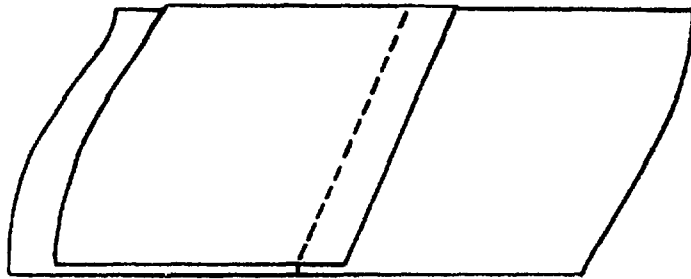

(a)

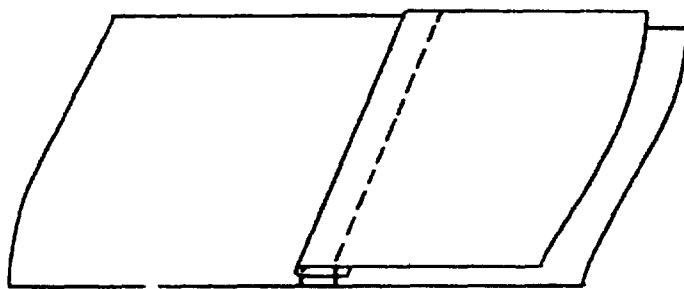

(b)

**Seam type LSbk-2**

This type of seam shall be formed by:

- (a) lapping a ply of material on a body material and seaming with one row of stitches, and
- (b) turning the top ply back sharply over the first row of stitches and seaming with one or more rows of stitches.

162

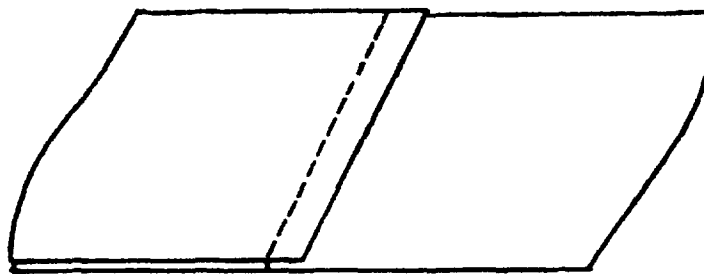

(a)

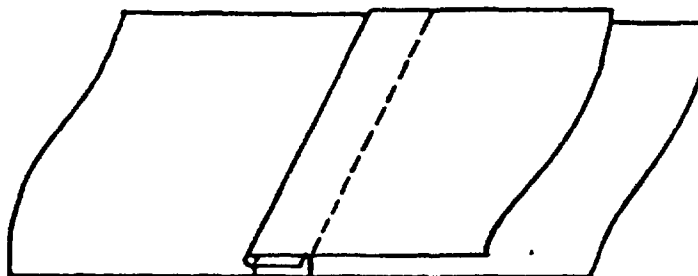

(b)

**Seam type LSb1-2**

This type of seam shall be formed by:

(a) lapping a ply of material on a body material and seaming with one or more rows of stitches, and

(b) turning the top ply back sharply over the first row of stitching and seaming with a second row of stitches through the top and bottom plies.

Seam Type LStm  
January 25, 1965

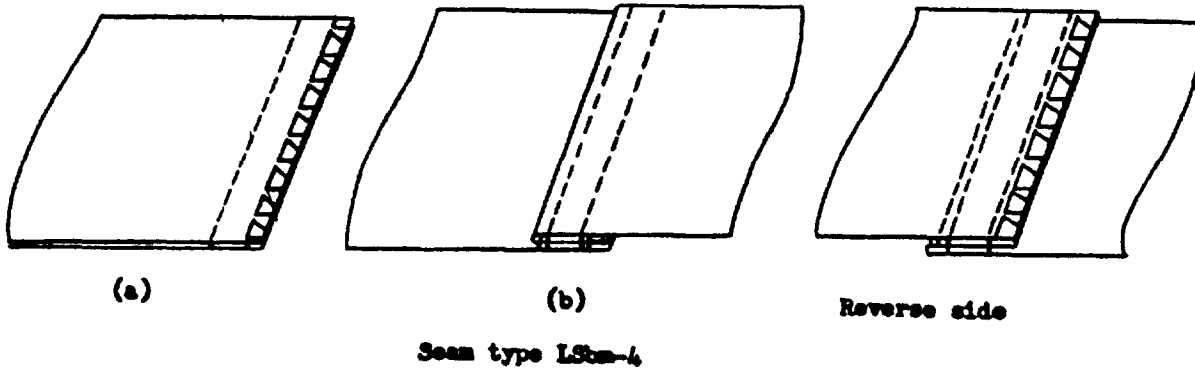
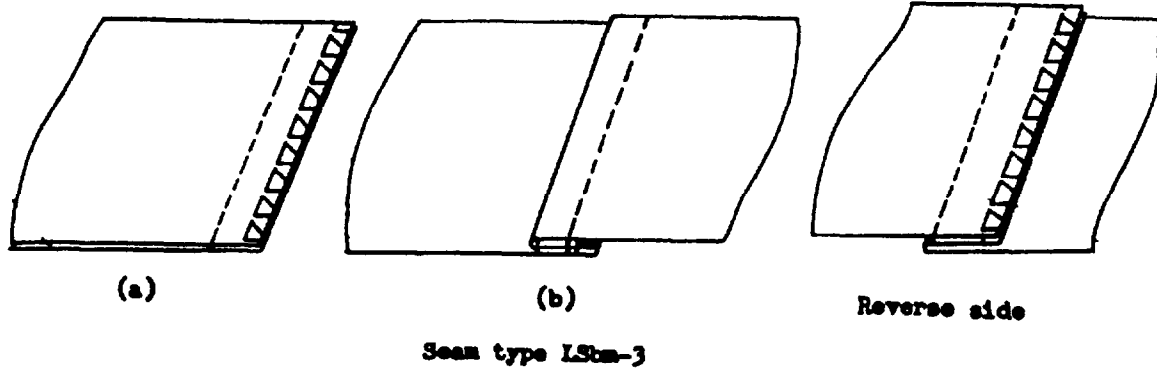

This type of seam shall be formed by:  
(a) superimposing two plies of material and seaming in seam type SSe-2, with one row of seaming stitches and one row of overedge stitches, and

(b) turning the top ply back sharply over the seaming row of stitches and seaming with one or more rows of stitches.



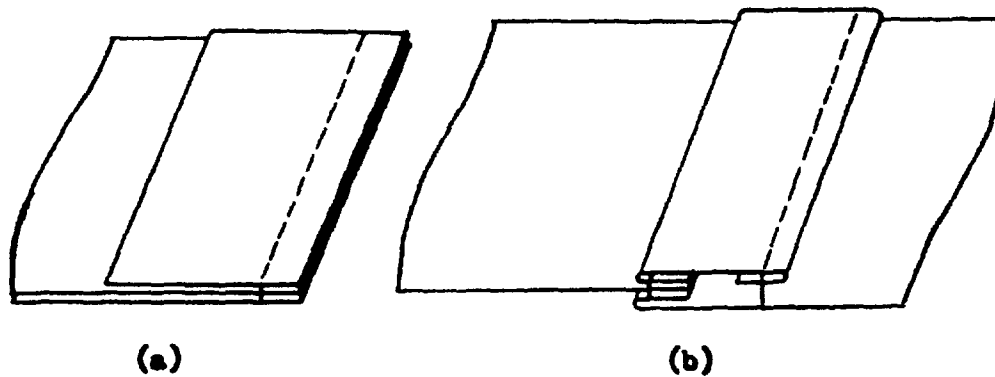

**Seam type LSbn-2**

This type of seam shall be formed by:

(a) superimposing a strip on two plies of material and seaming with a single row of stitches a specified distance from the edge in seam type SSa-1, and

(b) turning the bottom ply and the strip over the first row of stitches, turning in the edge of the strip and seaming the turned edge to the bottom ply with one row of stitches.

**Seam Type LSbc**  
**January 25, 1955**

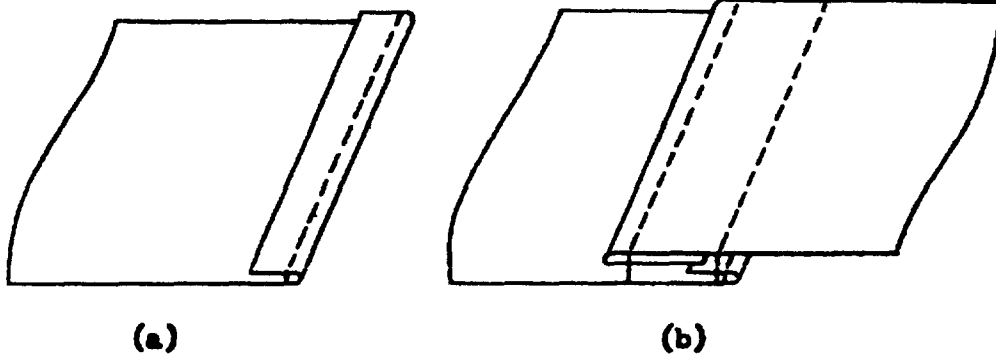

**Seam type LSbc-3**

**This type of seam shall be formed by:**

**(a) turning the edge of a ply of material and stitching the turned portion to the body of the material with one row of stitches, and**

**(b) folding the edge of another ply of material, lapping it on the first ply, and seaming with two rows of stitches.**

166

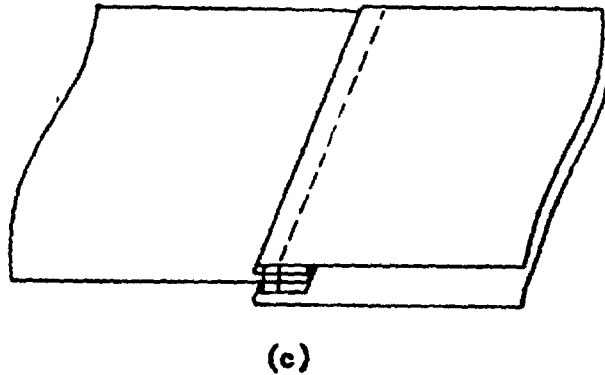
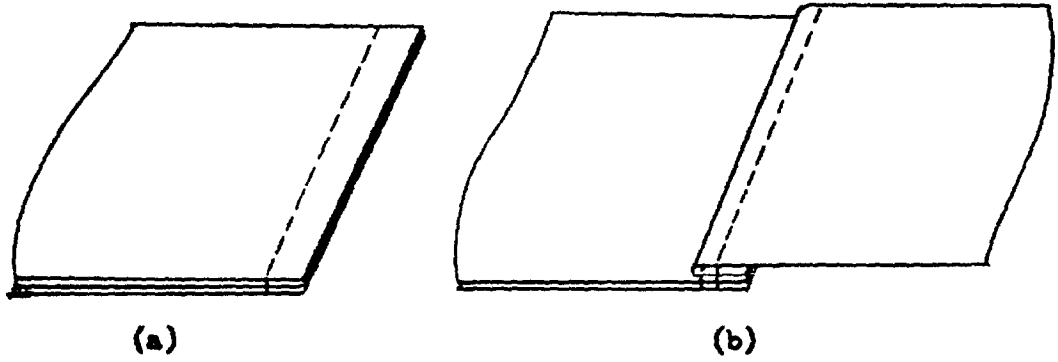

Seam type LSb-2

This type of seam shall be formed by:

(a) superimposing three or more plies of material and seaming with one row of stitches a specified distance from the edge in seam type SSa-1,

(b) turning the top ply back over the row of stitches and seaming with one or more rows of stitches, and

(c) turning the bottom ply back to show the finished seam.

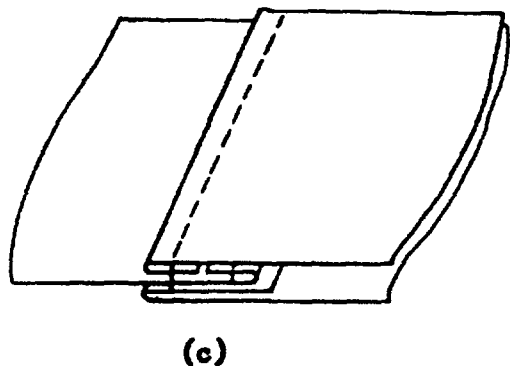
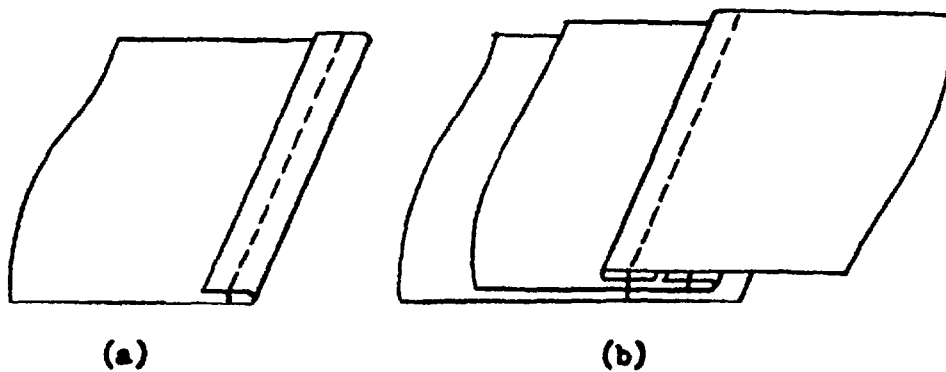

**Seam type LSBq-2**

This type of seam shall be formed by:

(a) turning the edge of a ply of material and stitching the turned portion to the body of the material with one row of stitches,

(b) superimposing this ply on a second ply of material, folding under the edge of a third ply

and lapping it over the turned and stitched edge and seaming with one row of stitches through the folded edge of the third ply and the two other plies of material, and

(c) turning the bottom ply back to lie under the top ply to show the finished seam.

168

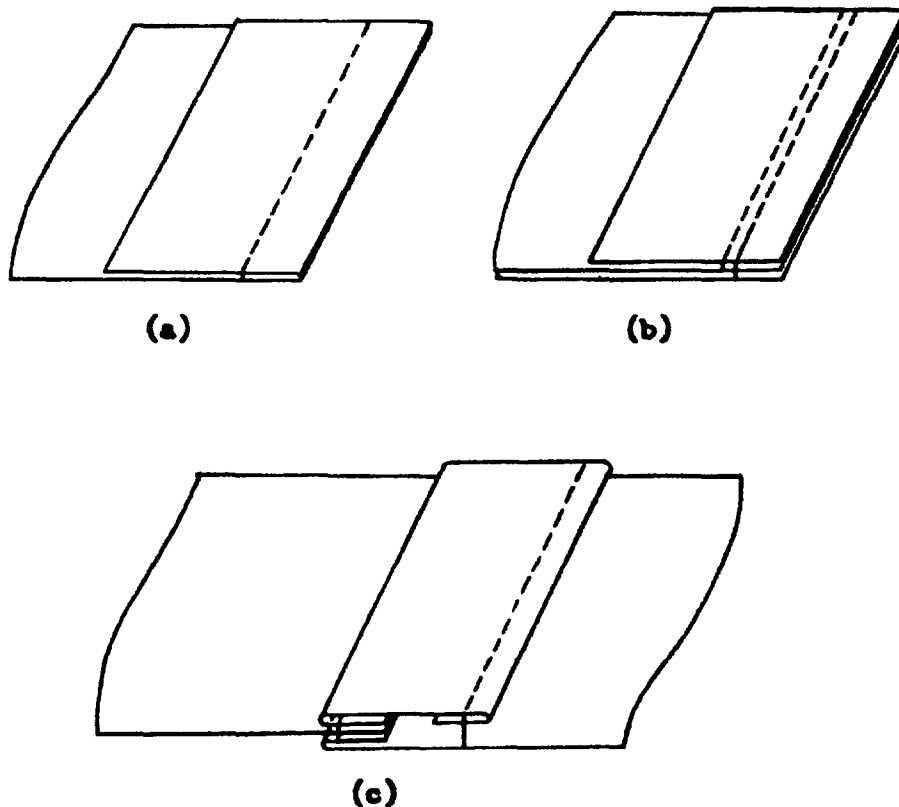

## Seam type LSbr-3

This type of seam shall be formed by:

- (a) superimposing a strip on a ply of material and seaming with a row of stitches a specified distance from the edge in seam type SSe-1,  
 (b) superimposing the seam thus formed on another ply of material and seaming with one

row of stitches between the first row of stitches and the edge of the plies, and

- (c) turning the bottom ply and the strip over the two rows of stitches, turning in the edge of the strip and seaming the turned edge to the bottom ply with one row of stitches.

**Seam Type LSbs**  
**January 25, 1965**

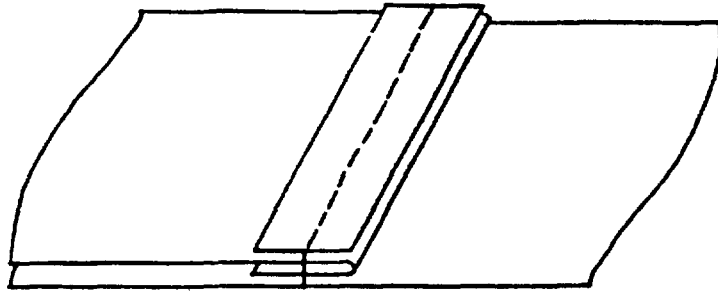

**Seam type LSbs-1**

This type of seam shall be formed by folding under the edge of one ply of material, lapping it on the body of another ply of material, super-

imposing a tape along the folded edge of the first ply, and seaming with one or more rows of stitches.

170

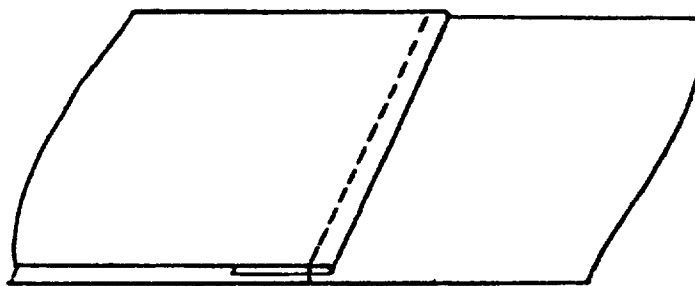

(a)

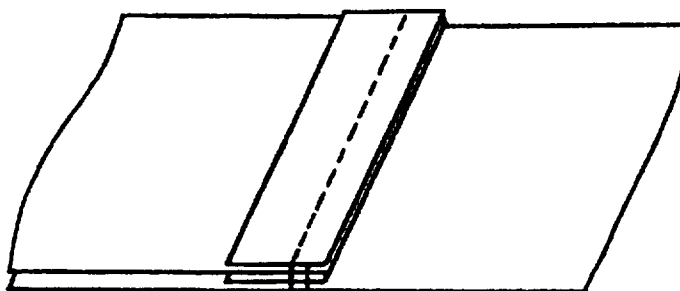

(b)

**Seam type LSbt-2**

**This type of seam shall be formed by:**

**(a) folding under the edge of one ply of material, lapping it on the body of another ply of material and seaming with one row of stitches, and**

**(b) superimposing a tape along the folded edge of the first ply and seaming with one or more rows of stitches a specified distance from the edge.**

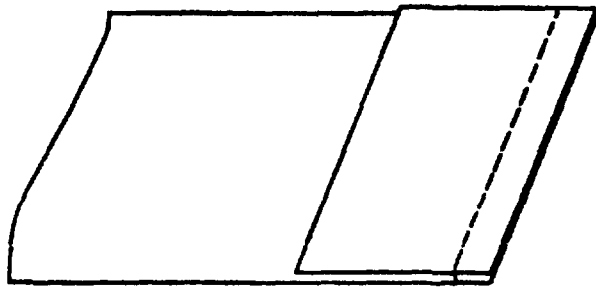

(a)

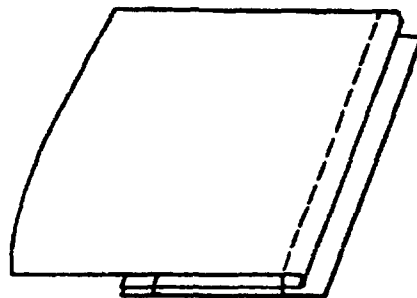

(b)

**Seam type LSbu-2**

This type of seam shall be formed by:

(a) superimposing a strip on a body material and seaming a specified distance from the edge in seam type SSe-1, and

(b) folding the body material a specified distance from the edge of the strip and seaming the folded edge through the strip with one or more rows of stitches.

172



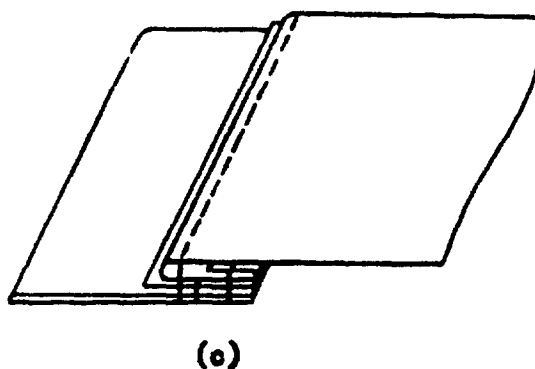
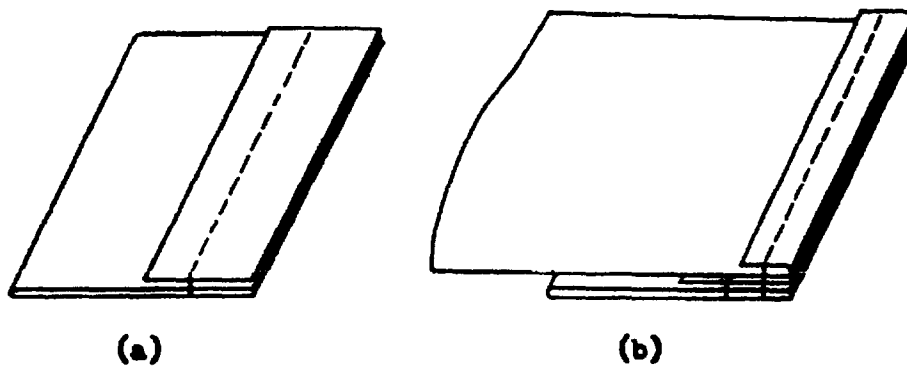

Seam type LSBv-3

This type of seam shall be formed by:

(a) superimposing a strip on a folded ply of material and seaming with one row of stitches,

(b) folding the edge of a body material and superimposing on the seam formed in (a) and seaming through the folded edge of the body

material, and

(c) turning the body material over the seamed edges with the fold a specified distance from the edge of the extending strip and seaming a specified distance from the folded edge with one row of stitches.

Seam Type LSbw  
January 25, 1955

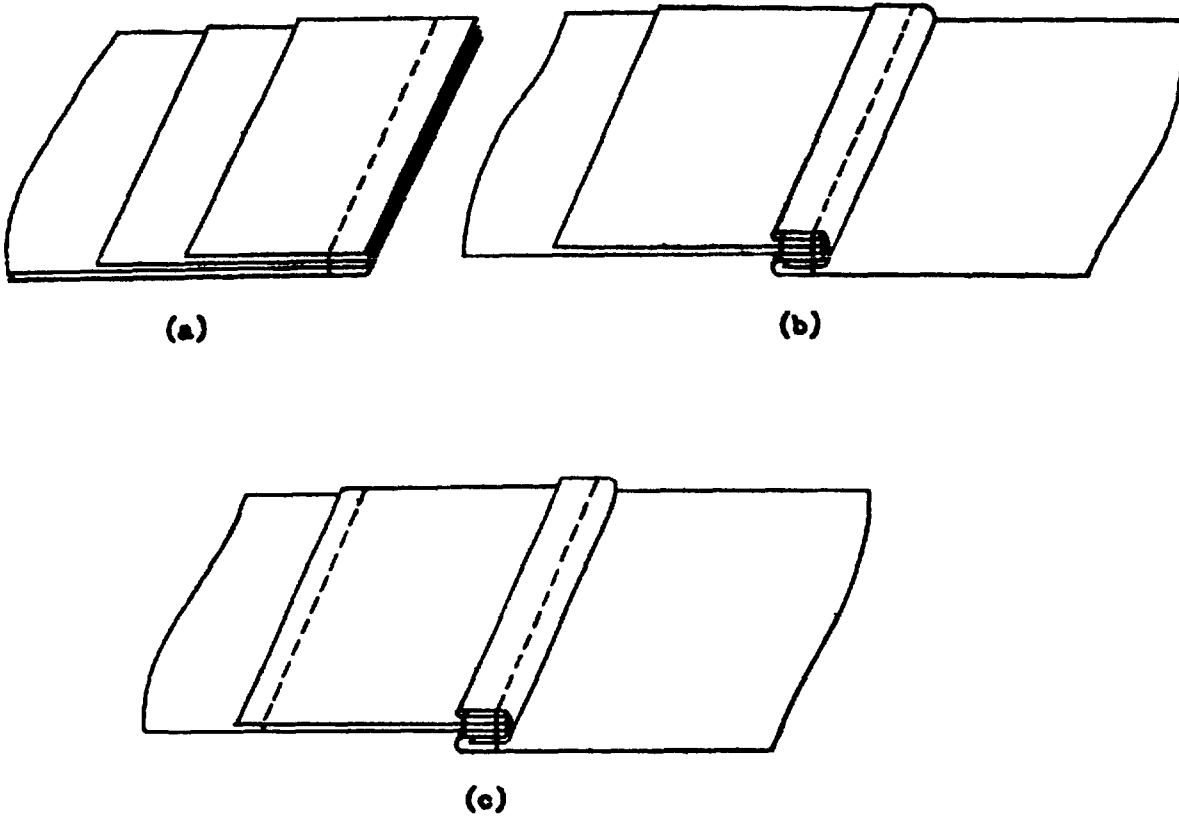

**Seam type LSbw-3**

This type of seam shall be formed by:

(a) superimposing a binding strip on a reinforcing piece and two or more plies of body material and seaming with one row of stitches,

(b) turning the binding strip over the row of stitches and around the edges of the material,

turning the bottom ply outward and stitching through all plies with one row of stitches, and

(c) seaming the opposite edge of the reinforcing strip to the body material with one row of stitches.

174

175

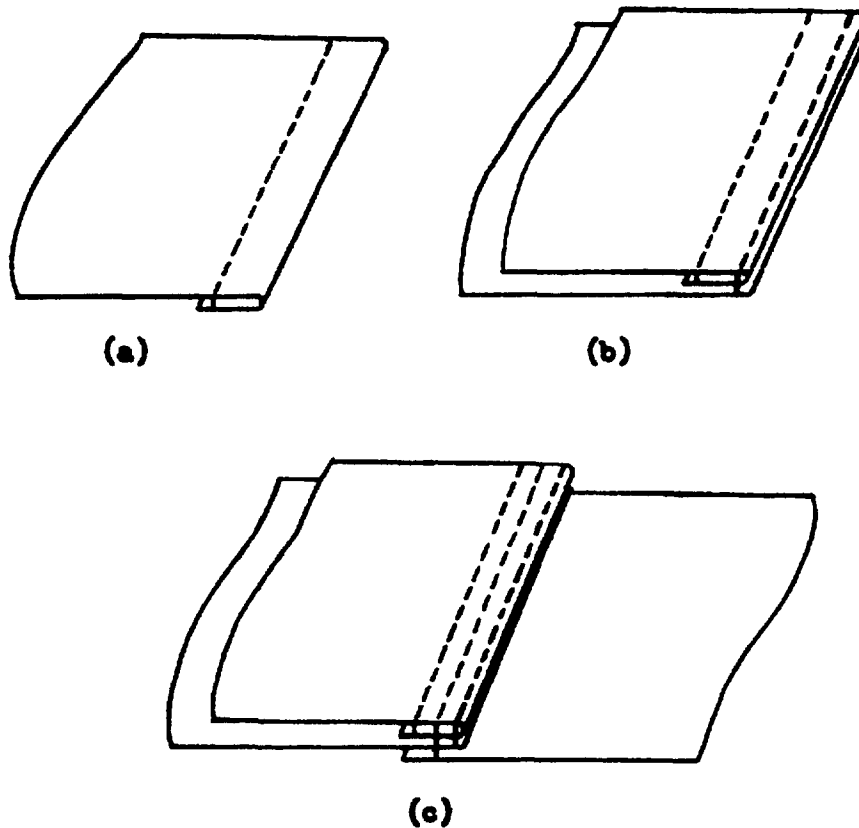

Seam type LSbx-3

This type of seam shall be formed by:

(a) turning the edge of one ply of material and stitching the turned portion to the body material a specified distance from the edge as in stitching type EFa-1,

(b) superimposing the folded edge on another ply of material and seaming through all

plies with a row of stitches a specified distance from the folded edge, and

(c) lapping the superimposed plies on one or more plies and seaming through all plies with a row of stitches a specified distance from the folded edge of top ply.

**Seam Type LSby**  
**January 25, 1965**

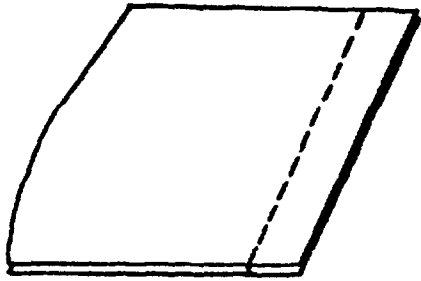

(a)

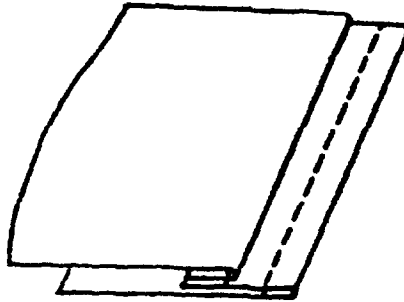

(b)

**Seam type LSby-2**

This type of seam shall be formed by:

- (a) superimposing two plies of material and seaming in seam type SSe-1, and
- (b) turning the top ply sharply back over the

first row of stitches with the bottom ply folded a specified distance, and seaming with one or more rows of stitches through the folded portion of the bottom ply.

176

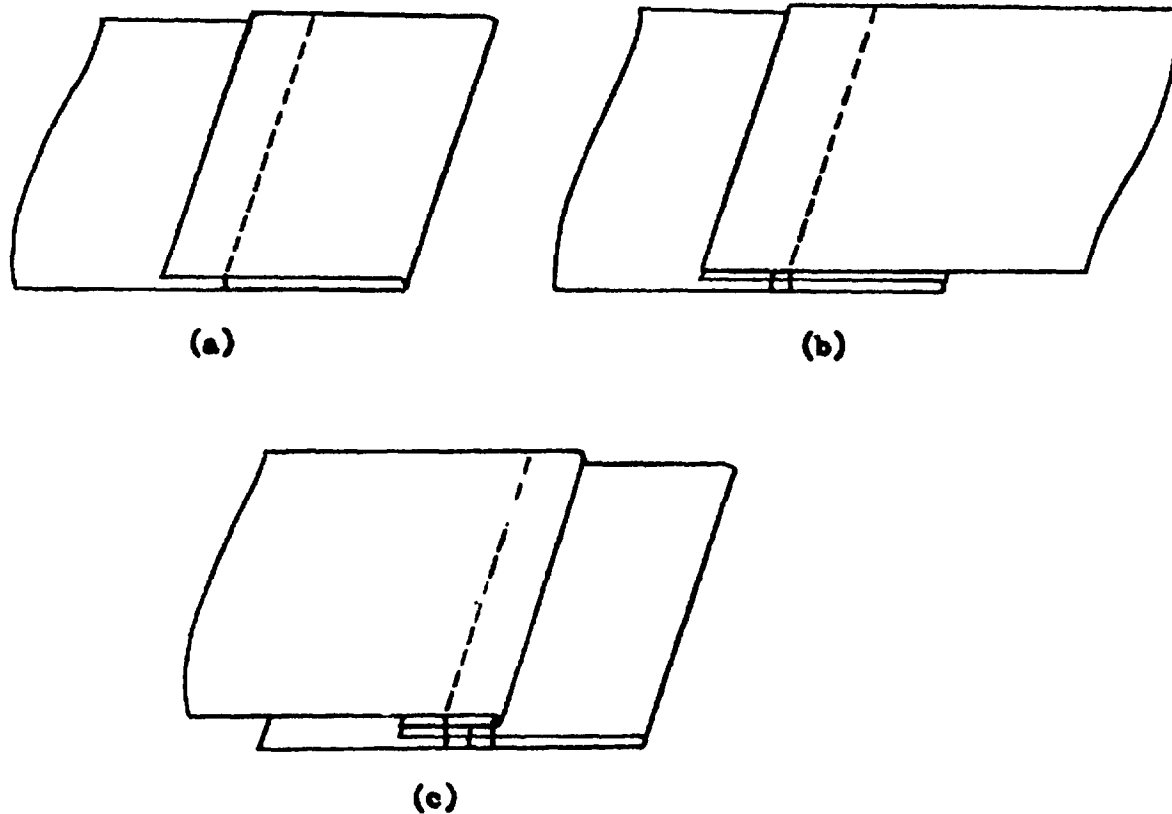

Seam type L5b3-3

This type of seam shall be formed by:

(a) folding the edge of a body material a specified distance and seaming with one row of stitches,

(b) lapping a second ply of material over the

folded and seamed ply and seaming with one row of stitches, and

(c) turning the second ply sharply at the second row of stitches and seaming with one or more rows of stitches.

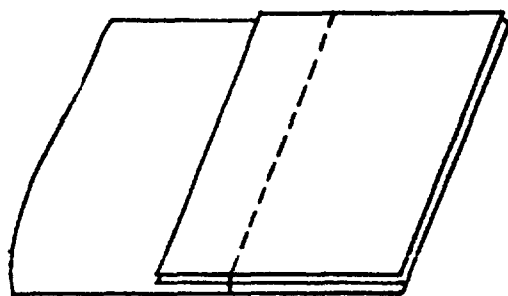

(a)

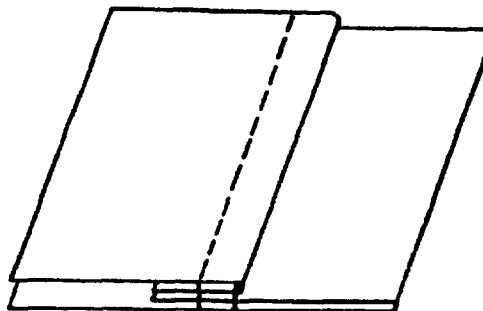

(b)

**Seam type LScn-2**

**This type of seam shall be formed by:**

(a) superimposing a strip on the folded edge of a body material and seaming with one row of stitches a specified distance from the folded edge, and

(b) turning the strip back sharply over the first row of stitches and seaming with one or more rows of stitches.

178

117

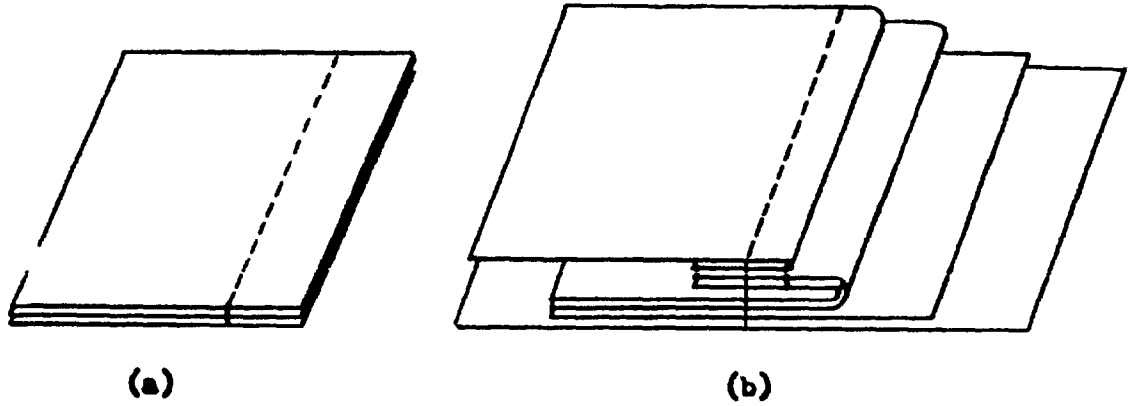

**Seam type LSch-2**

This type of seam shall be formed by:

- (a) superimposing three plies of material and seaming in seam type SSe-1, and
- (b) Turning the top ply back over the row

of stitches and folding the two bottom plies a specified distance; superimposing this on one or more plies of body material and seaming with one or more rows of stitches.

**Seam Type LSc-2**  
**January 25, 1965**

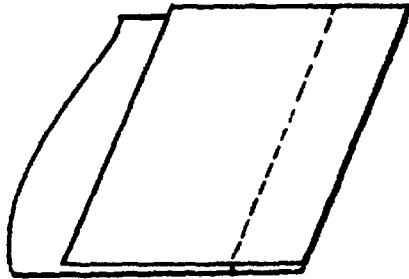

(a)

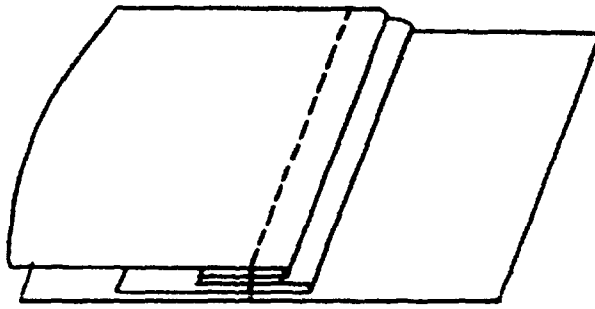

(b)

**Seam type LSc-2**

**This type of seam shall be formed by:**

- (a) superimposing two plies of material and seaming in seam type SSc-1, and**
- (b) turning both plies of material over their**

**edges, lapping the two plies over a body material and seaming with one or more rows of stitches.**

281





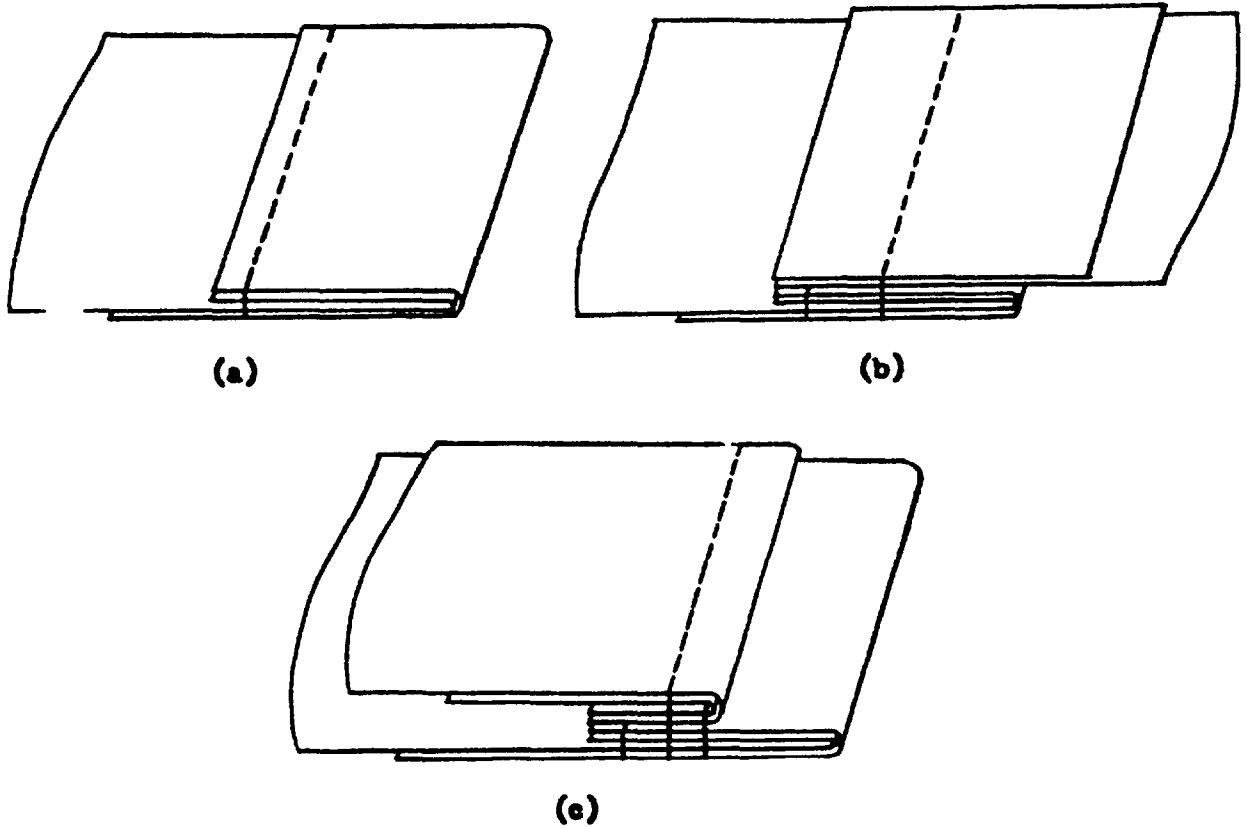

Seam type LScd-3

This type of seam shall be formed by:

(a) superimposing two or more plies of material, folding both edges back over the body material a specified distance and seaming with one or more rows of stitches,

(b) lapping two plies of material even with

the folded edges and seaming with one row of stitches, and

(c) turning the two plies back over the second row of stitches and seaming through all plies with one row of stitches.

**Seam Type LSc**  
**January 25, 1988**

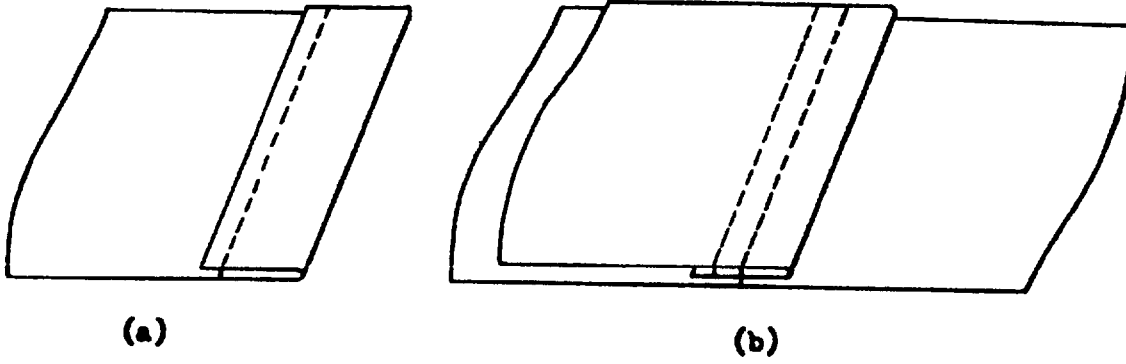

**Seam type LSc-2**

**This type of seam shall be formed by:**

**(a) folding the edge of one ply of material and seaming with one row of stitches a specified distance from the edge, and**

**(b) lapping the ply on the body of another ply of material and seaming with one or more rows of stitches.**

183

**Seam Type LScf**  
**January 25, 1965**

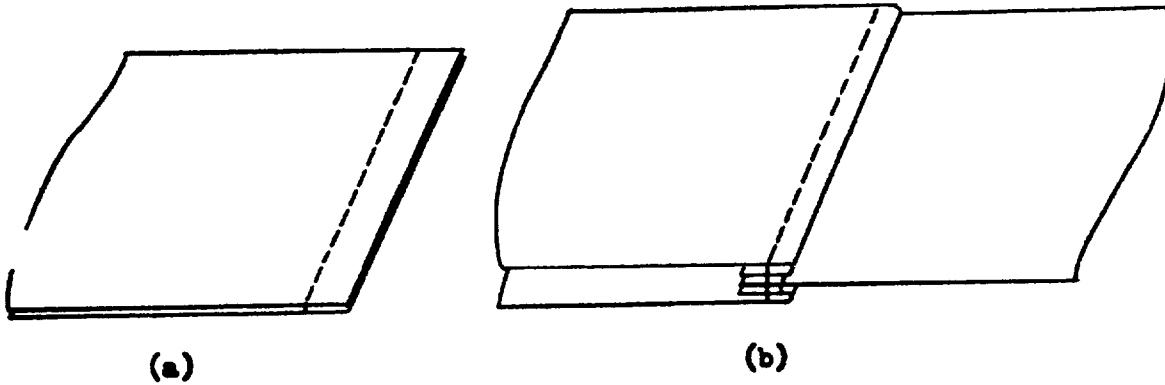

**Seam type LScf-2**

**This type of seam shall be formed by:**

- (a) superimposing and seaming two plies of material in seam type SSe-1, and**
- (b) turning the bottom ply at the row of**

**stitches, superimposing a third ply with edge folded and seaming with one or more rows of stitches.**

**Seam Type LScg**  
**January 25, 1945**

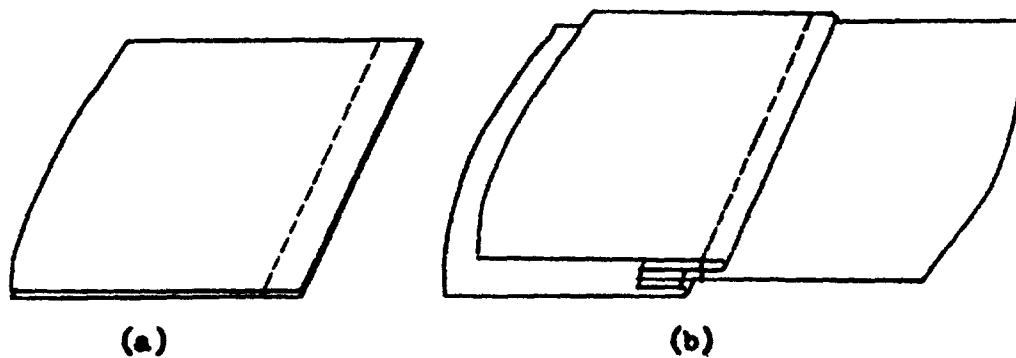

**Seam type LScg-2**

This type of seam shall be formed by:  
(a) superimposing and seaming two plies of material in seam type SSe-1, and  
(b) turning the bottom ply at the row of

stitches, superimposing a third ply with edge folded and seaming to the top ply with one row of stitches through the folded edge.

184

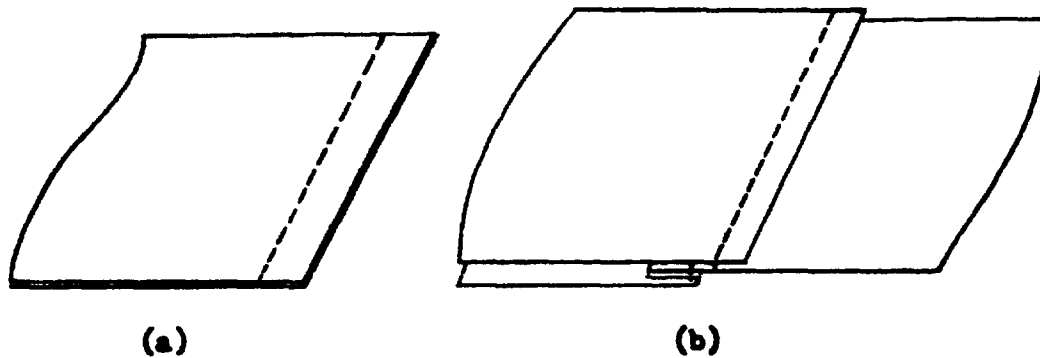

**Seam type LSch-2**

**This type of seam shall be formed by:**

- (a) superimposing and seaming two plies of material in seam type SSa-1, and**
- (b) turning the bottom ply at the row of**

**stitches, superimposing a third ply and seaming with one row of stitches through the third ply and top ply.**

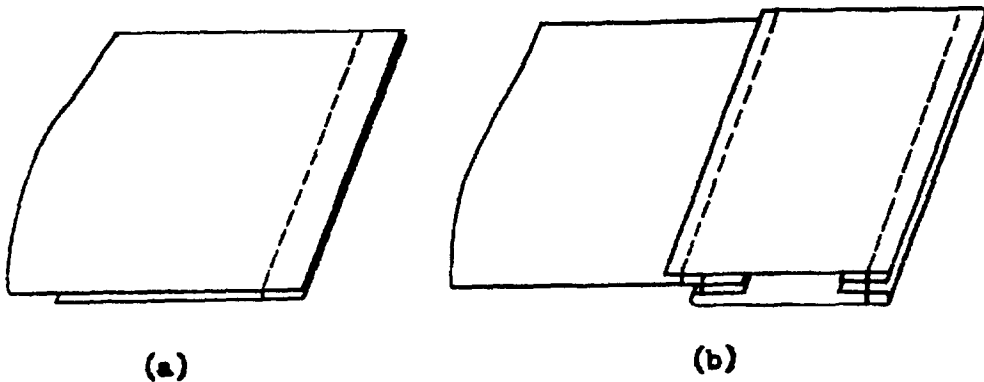

**Seam type LScj-3**

This type of seam shall be formed by:

(a) superimposing two plies of material and seaming in seam type SSa-1, and

(b) turning the bottom ply at the row of stitches and folding in the raw edge; super-

imposing a strip with one edge folded and seaming with two rows of stitches; one row through the folded edges and one row through the strip and the body material.

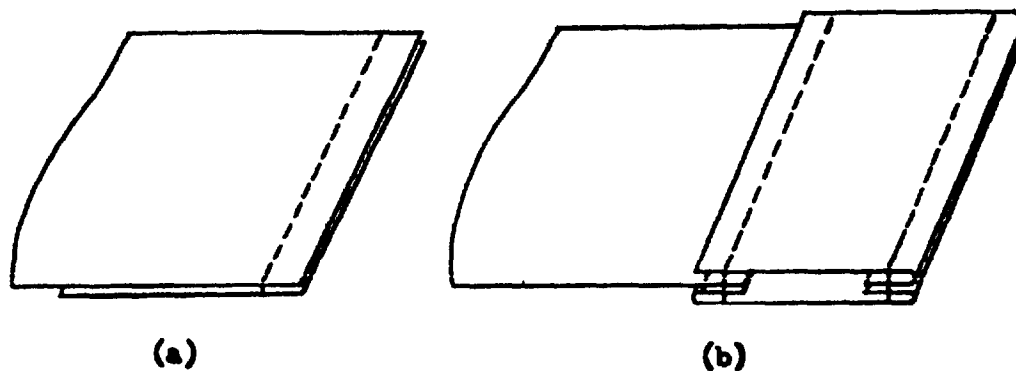

**Seam type LSck-3**

This type of seam shall be formed by:  
(a) superimposing two plies of material and seaming in seam type SSe-1, and  
(b) turning the bottom ply at the row of

stitches and folding in the raw edge; superimposing a strip with one edge folded and seaming with two or more rows of stitches.

**Seam Type LSc1**  
**January 25, 1965**

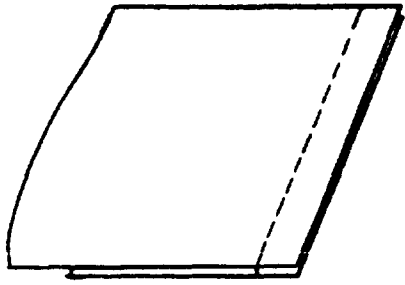

(a)

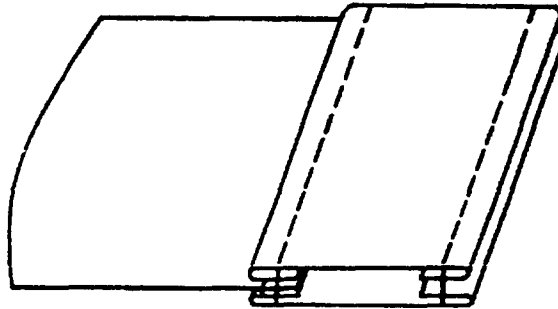

(b)

**Seam type LSc1-3**

**This type of seam shall be formed by:**

- (a) superimposing two plies of material and seaming in seam type SSc-1, and
- (b) turning the bottom ply at the row of

stitches, folding in the raw edge; folding in both edges of another ply of material, lapping it on the turned and folded ply and seaming with two or more rows of stitches.

188



107

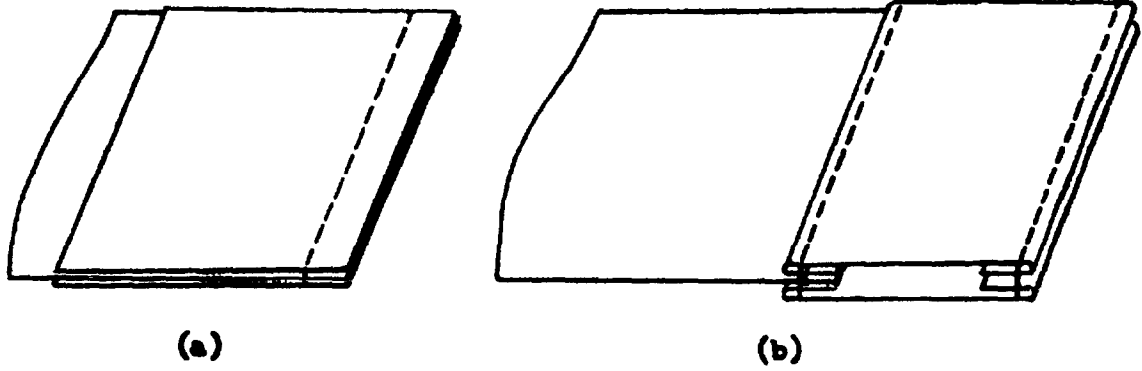

Seam type LScm-3

This type of seam shall be formed by:

(a) placing two strips on either side of a body material and seaming with one row of stitches, and

(b) turning the strips back over the sewn edges, folding in the raw edges of the strips and seaming each side with one row of stitches.

**Seam Type LScn**  
**January 25, 1995**

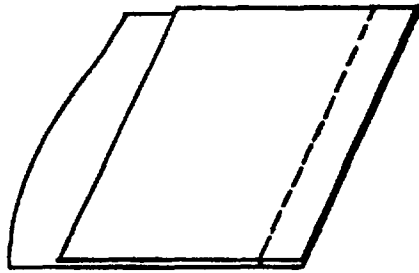

(a)

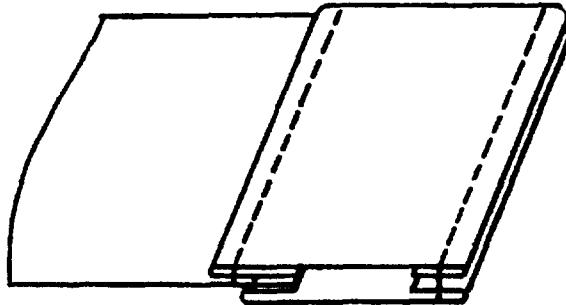

(b)

**Seam type LScn-3**

This type of seam shall be formed by:

(a) superimposing two plies of material and seaming in seam type SSe-1, and

(b) turning the bottom ply at the row of stitches, folding in the raw edge; folding in

both edges of another ply of material, lapping it on the turned and folded ply and seaming with two or more rows of stitches, one row of which shall be through the body ply.

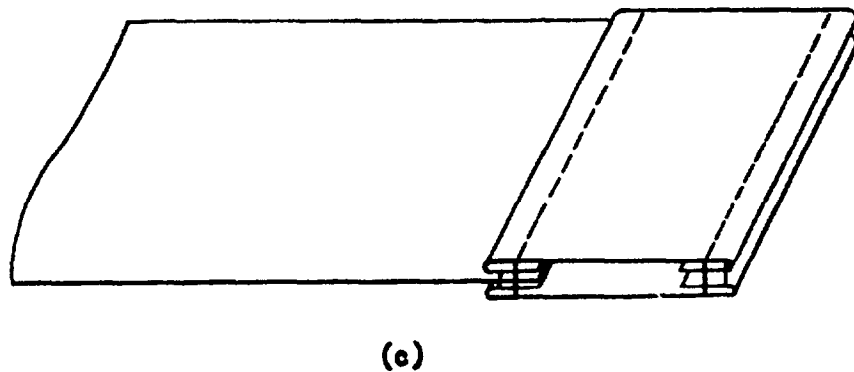
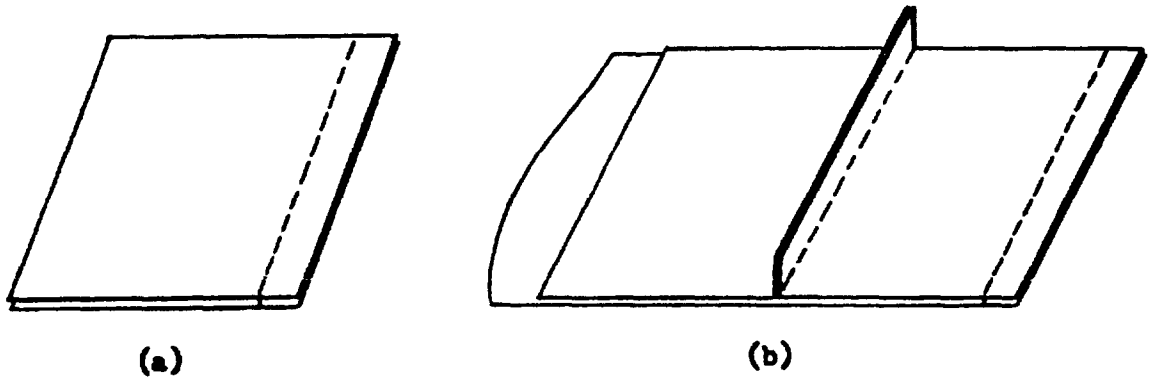

Seam type LSc-4

This type of seam shall be formed by:

- (a) superimposing two strips and seaming with one row of stitches in seam type SSe-1,
- (b) seaming the edge of one of the strips to a body material, and

- (c) turning the strips to cover the raw edges, folding in the raw edge of the top strip and seaming with two or more rows of stitches.

Seam Type LScp  
January 25, 1985

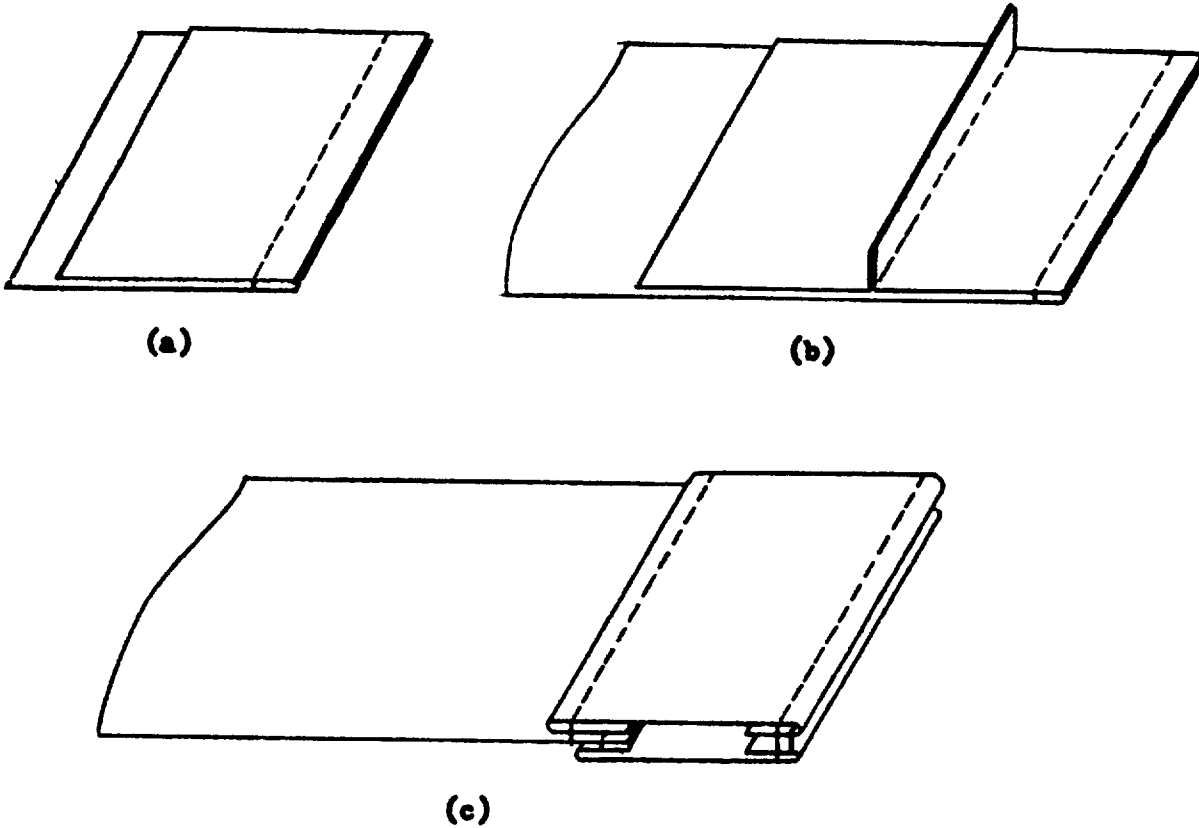

**Seam type LScp-4**

This type of seam shall be formed by:  
(a) superimposing two strips and seaming with one row of stitches in seam type SSe-1,  
(b) seaming the edge of one of the strips to a body material, and

(c) turning the strips to cover the raw edges, folding in the raw edge of the top strip and seaming through the body material. The outer edge shall be seamed with one row of stitches.

192

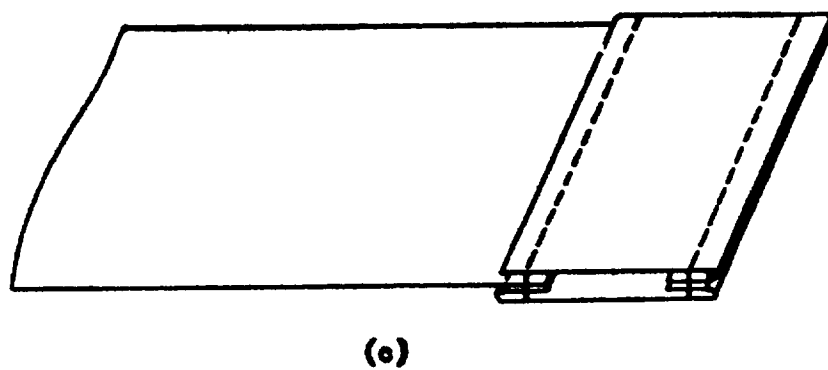
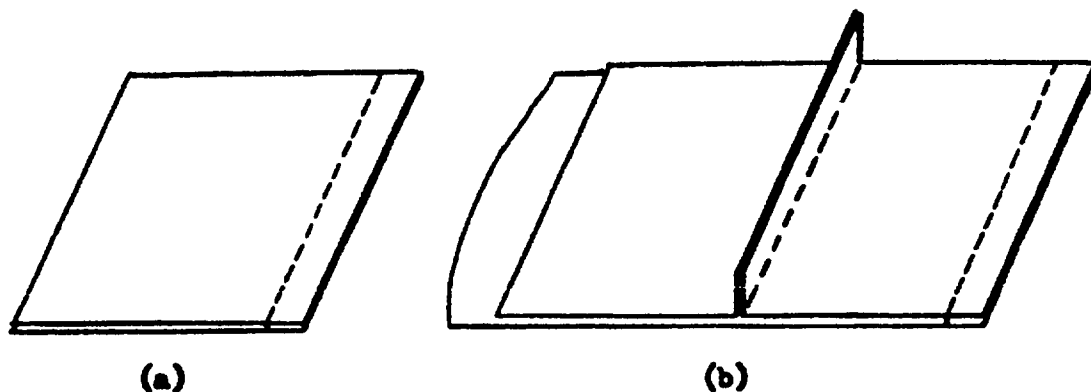

**Seam type LScq-4**

This type of seam shall be formed by:  
(a) superimposing two strips and seaming with one row of stitches in seam type SSe-1,  
(b) seaming the edge of one of the strips to

a body material, and  
(c) turning the strip to cover the raw edges and seaming with two or more rows of stitches.

7

**Seam Type LScr  
January 25, 1966**

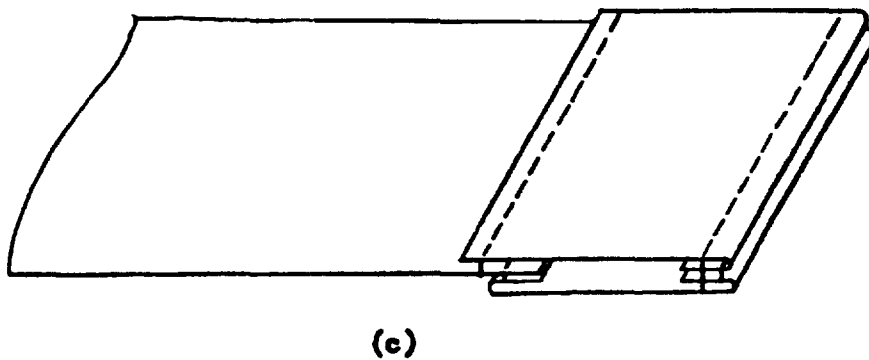
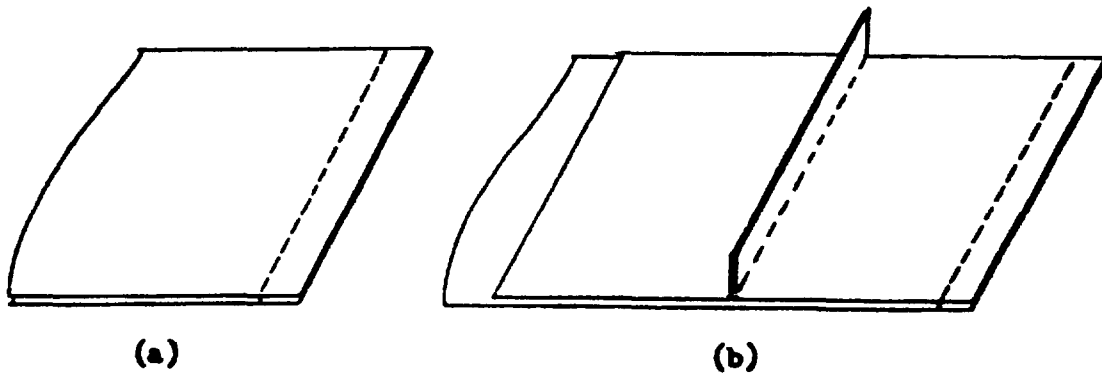

**Seam type LScr-4**

This type of seam shall be formed by:

- (a) superimposing two strips and seaming with one row of stitches in seam type SSa-1,
- (b) seaming the edge of one of the strips to a body material, and

- (c) turning the strips to cover the raw edges, and seaming the unturned edge through the body material. The outer edge shall be seamed with one row of stitches.

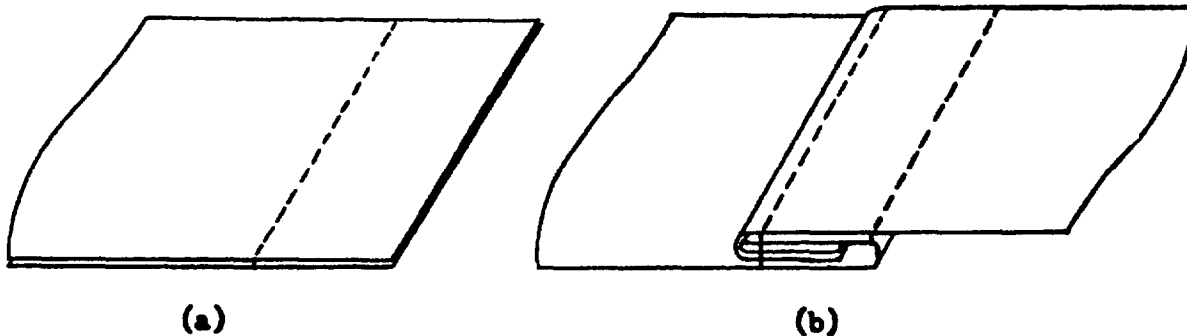

**Seam type LScs-2**

**This type of seam shall be formed by:**

- (a) superimposing two plies of material and seaming in seam type SSe-1, and**
- (b) opening the plies of fabric, turning the**

**seam allowance to one side with the raw edges turned under, and seaming with one or more rows of stitches.**

**Seam Type LSct**  
**January 25, 1965**

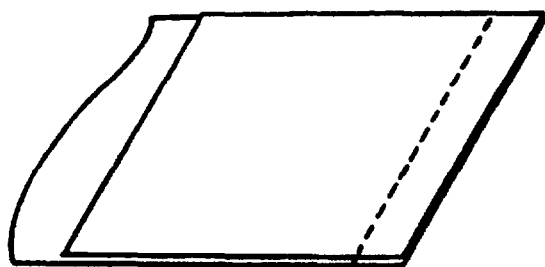

(a)

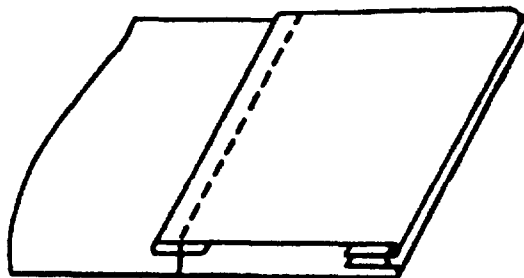

(b)

**Seam type LSct-2**

**This type of seam shall be formed by:**

**(a) superimposing a strip on a body material and seaming with one row of stitches in seam type SSe-1, and**

**(b) turning both plies over their edges, turning under the opposite edge of the strip and seaming with one or more rows of stitches.**



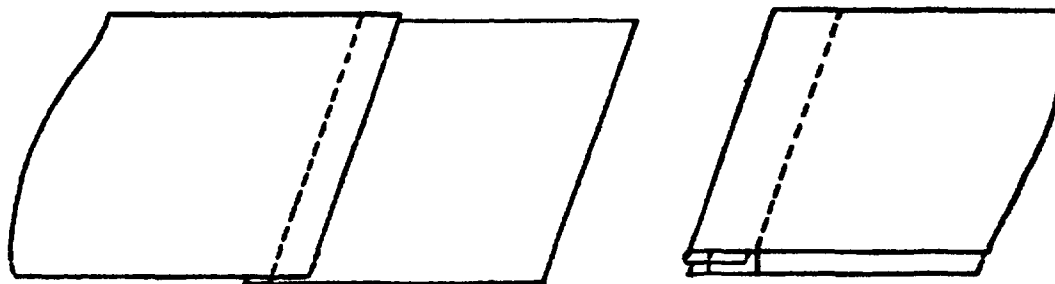

(a)

(b)

**Seam type LScu-2**

This type of seam shall be formed by:

(a) overlapping two plies of material and seaming with a row of stitches a specified distance from the edges, and

(b) turning the top ply over the first row of stitching and seaming with a row of stitches through the body material.

**Seam Type LScv**  
**January 25, 1965**

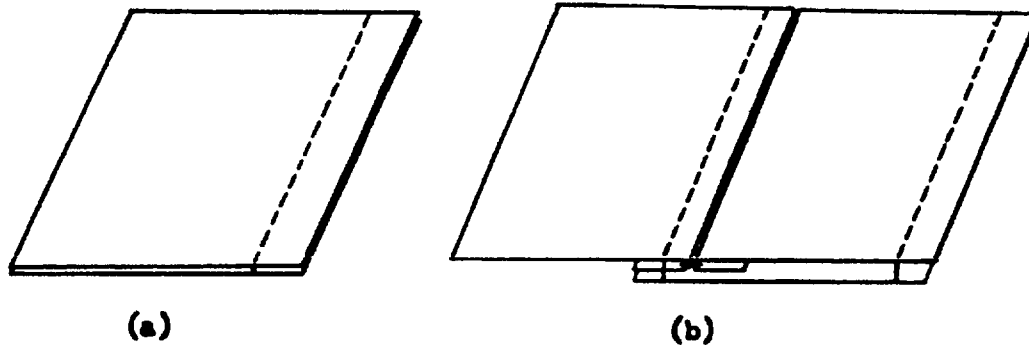

**Seam type LScv-3**

This type of seam shall be formed by:  
(a) superimposing and seaming two plies of material in seam type SSe-1, and  
(b) opening the two plies, turning the edge

of each ply under the body, superimposing on a third ply of material and seaming with two rows of stitches.

APC-2

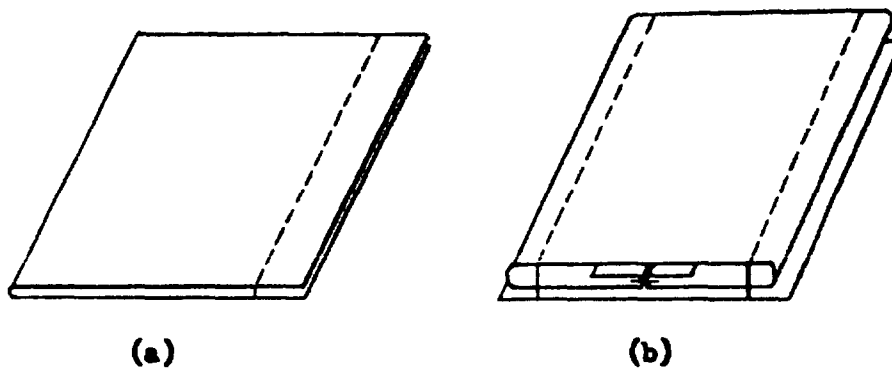

**Seam type LScw-3**

This type of seam shall be formed by:  
(a) folding a piece of material and seaming a specified distance from the edge, and

(b) turning the material inside out with the seam opened and centered, and seaming to a body material with two rows of stitches.

**Seam Type LScx**  
**January 25, 1955**

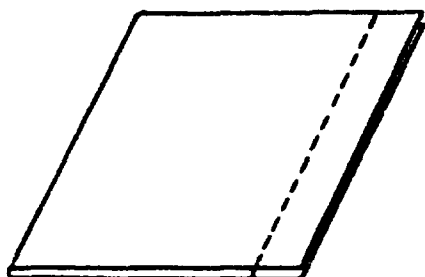

(a)

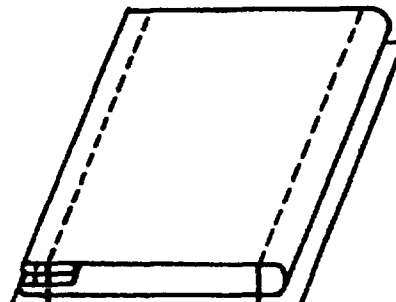

(b)

**Seam type LScx-3**

**This type of seam shall be formed by:**

**(a) folding a piece of material and seaming a specified distance from the edge, and**

**(b) turning the material inside out with the seam to one side and seaming to a body material with two rows of stitches.**

*200*

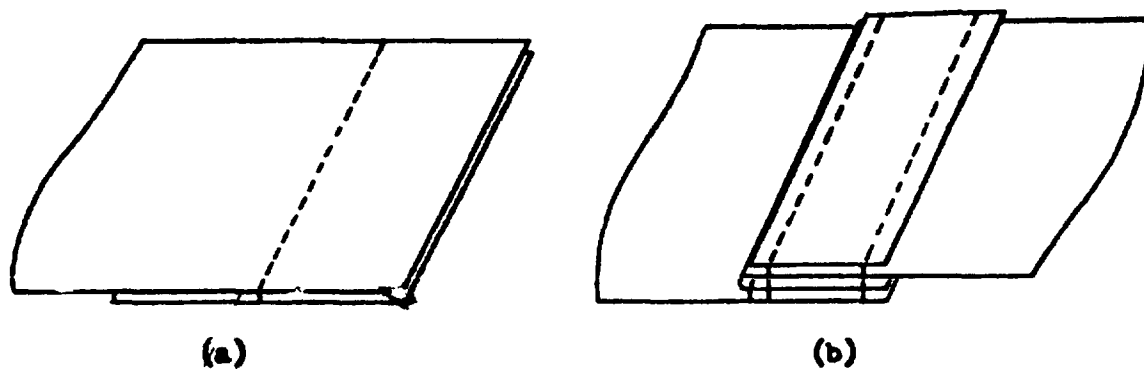

**Seam type L3c-3**

This type of seam shall be formed by:

- (a) superimposing two plies of material & seam type SSe-1, and
- (b) turning the top ply back sharply over .

the first row of stitches, superimposing a strip and seaming with two or more rows of stitches through all plies.

**Seam Type LScs**  
**January 25, 1965**

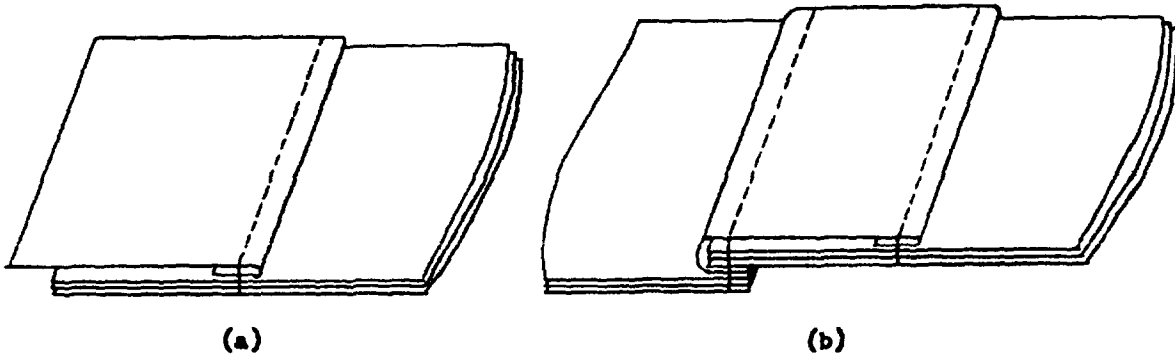

**Seam type LScs-2**

**This type of seam shall be formed by:**

- (a) folding under the edge of one ply of material; lapping it on two plies of body material and seaming with one row of stitches, and
- (b) folding the edge of the first ply around

the edges of the body plies; superimposing this on the edge of two additional plies of material, and seaming through all plies with one row of stitches.

202

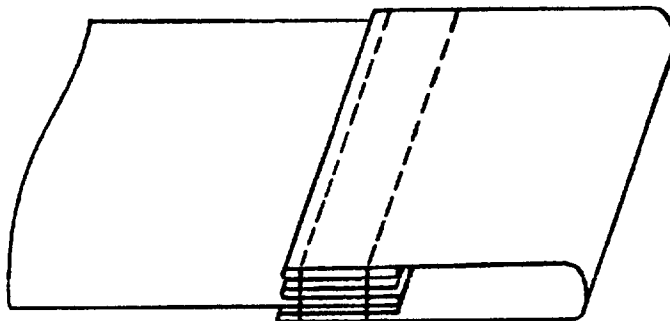

**Seam type LSda-2**

This type of seam shall be formed by turning the edge of one ply of material in an "S" fold, superimposing it on another ply with the edges

even; turning both edges of a strip and folding it over the plies of body materials, and seaming with two rows of stitches.

0203

**Seam Type L3db**  
**January 25, 1965**

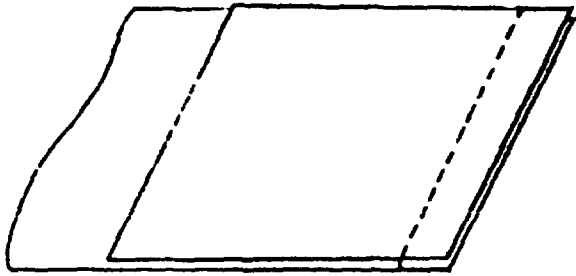

(a)

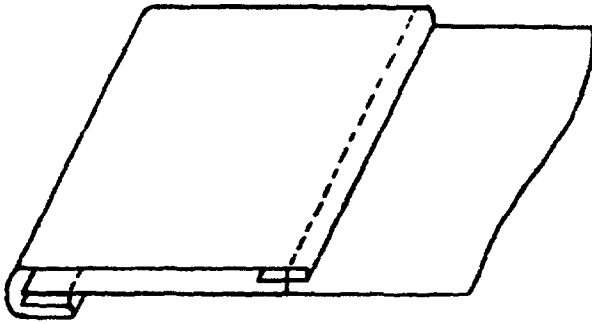

(b)

**Seam type L3db-2**

This type of seam shall be formed by:  
(a) superimposing a strip on a body material and seaming in seam type SSe-1, and  
(b) turning the strip around the edge of the

body material; turning under the raw edge of the strip and seaming to the body material with one row of stitches.

204



103

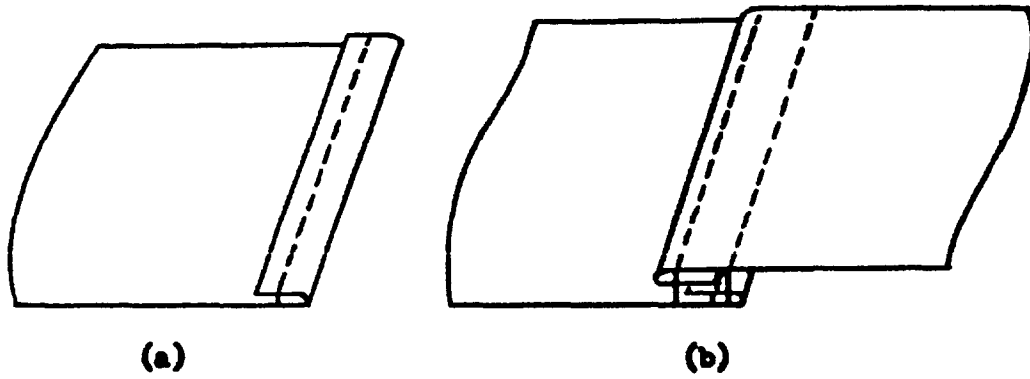

Seam type LSde-3

This type of seam shall be formed by:  
(a) turning the edge of a ply of material and stitching in stitching type EFa-1, and  
(b) turning the edge of a second ply of ma-

terial and lapping it on the turned and stitched edge of the first ply, and seaming with two rows of stitches.

Seam Type LSdd  
January 25, 1965

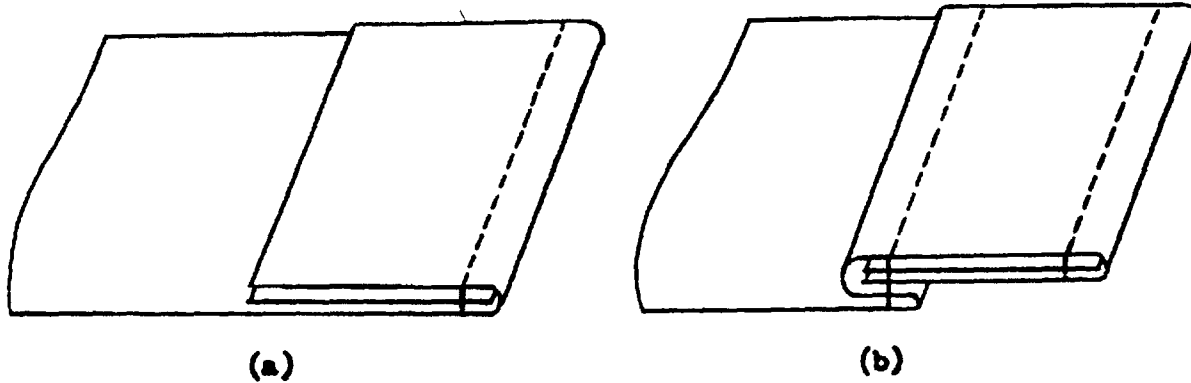

**Seam type LSdd-2**

**This type of seam shall be formed by:**

**(a) lapping an interlining strip over a ply of material, turning the edge of the material around the strip and seaming with one row of stitches, and**

**(b) folding the material in an "S" fold over the opposite edge of the strip and the edge of the body material, and seaming with one row of stitches.**

206

207

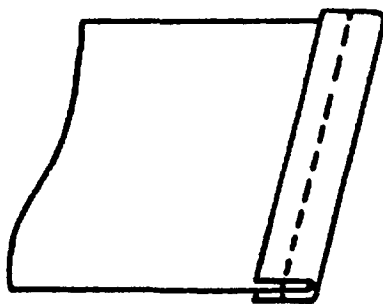

**Seam type BSa-1**

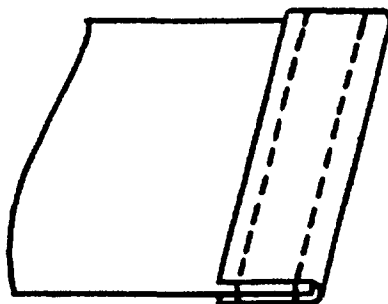

**Seam type BSa-2**

This type of seam shall be formed by folding a binding strip over the edge of the ply or plies of body material and seaming the bind-

ing strip and body material with one or more rows of stitches.

**Seam Type BSB**  
**January 25, 1966**

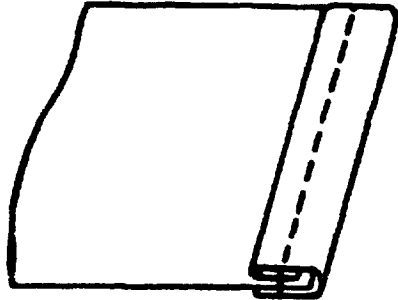

**Seam type BSB-1**

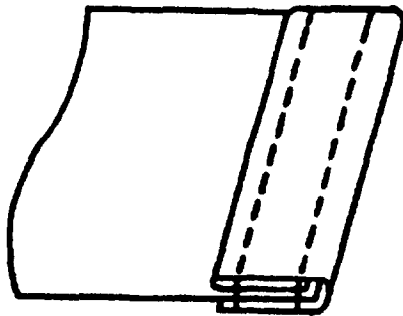

**Seam type BSB-2**

This type of seam shall be formed by turning one edge of a binding strip, folding it over the edge of the ply or plies of body material, and

seaming the binding strip and body material with one or more rows of stitches.

208

low

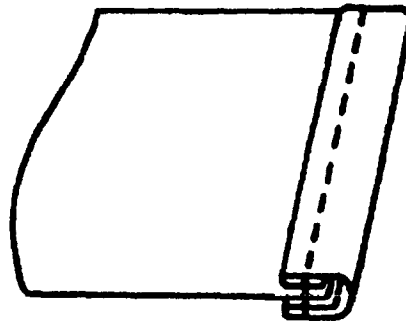

**Seam type BSc-1**

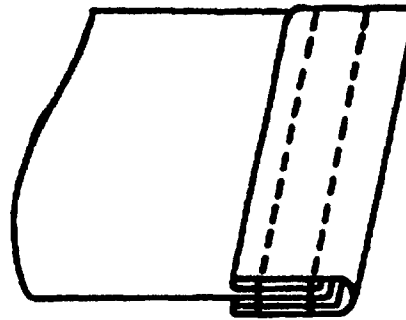

**Seam type BSc-2**

This type of seam shall be formed by turning both edges of a binding strip, folding it over the edge of the ply or plies of body material,

and seaming the binding strip and body material with one or more rows of stitches.

**Seam Type BSd**  
**January 25, 1965**

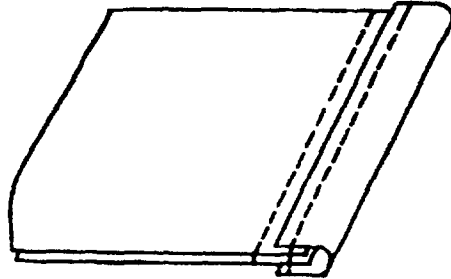

**Seam type BSd-2**

This type of seam shall be formed by folding a binding strip over the edges of the plies of body material, seaming the binding strip and body material with one row of stitches,

and the plies of body material with a second row of stitches a substantial distance from the edge.

2/10

**Seam Type BSe**  
**January 25, 1965**

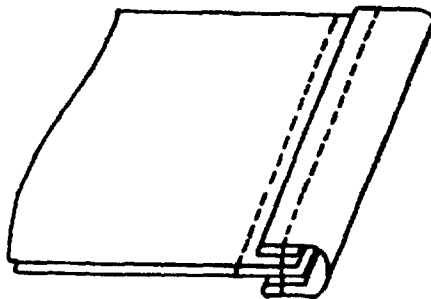

**Seam type BSe-2**

This type of seam shall be formed by turning both edges of a binding strip and folding it over the edge of the plies of body material, seaming the binding strip and body ma-

terial with one row of stitches and the two plies of body material with another row of stitches a substantial distance from the edge.

**Seam Type BSf**  
**January 25, 1965**

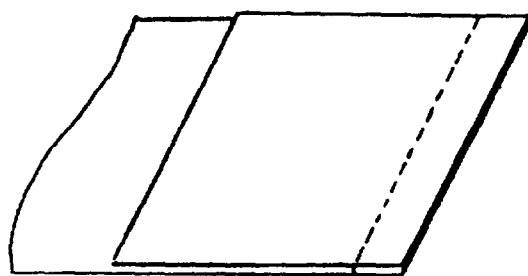

(a)

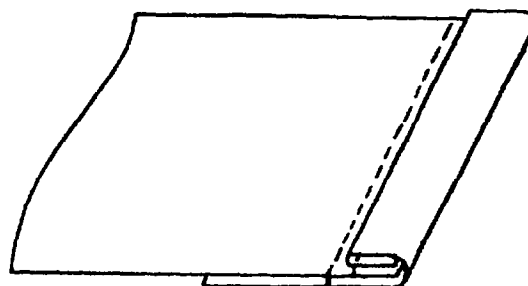

(b)

**Seam Type BSf-2**

This type of seam shall be formed by:

(a) superimposing a strip on a ply of body material and seaming with one row of stitches in seam type SSa-1, and

(b) turning the strip over the row of stitches around the edge of the body material and seaming with a second row of stitches.

**Seam Type BSg**  
**January 25, 1965**

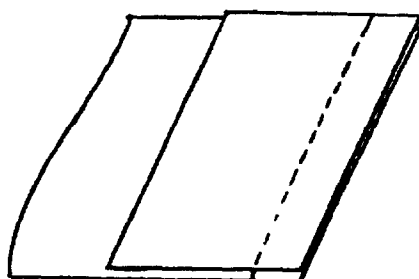

(a)

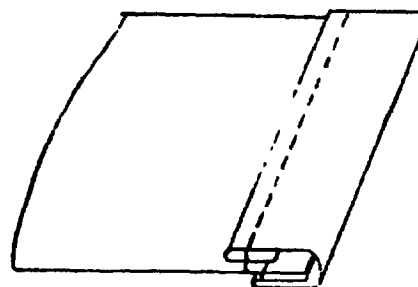

(b)

**Seam type BSg-2**

This type of seam shall be formed by:

(a) superimposing a strip on a ply of body material and seaming with one row of stitches in seam type SSa-1, and

(b) turning the strip over the row of stitches around the edge of the body material, folding the edge of the strip, and seaming with a second row of stitches.

**FED. STD. NO. 751a**

**Seam Type BSh**  
**January 25, 1965**

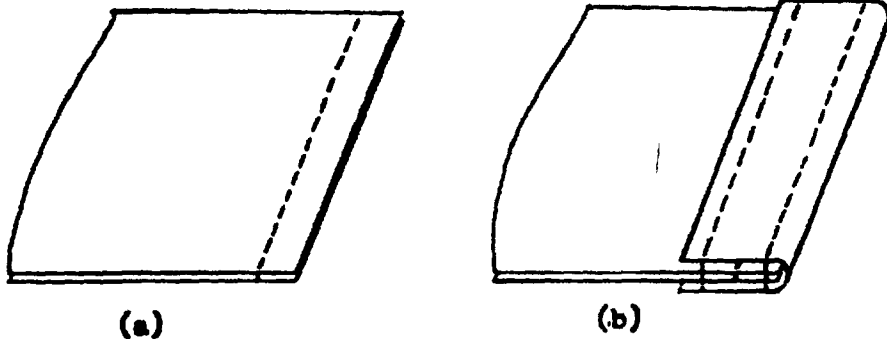

**Seam type BSh-3**

This type of seam shall be formed by:  
(a) superimposing two plies of material and seaming as in seam type SSa-1, and

(b) folding a binding strip over the edges of the plies of the body material and seaming with two rows of stitches.

2/2

**Seam Type BSj**  
**January 25, 1965**

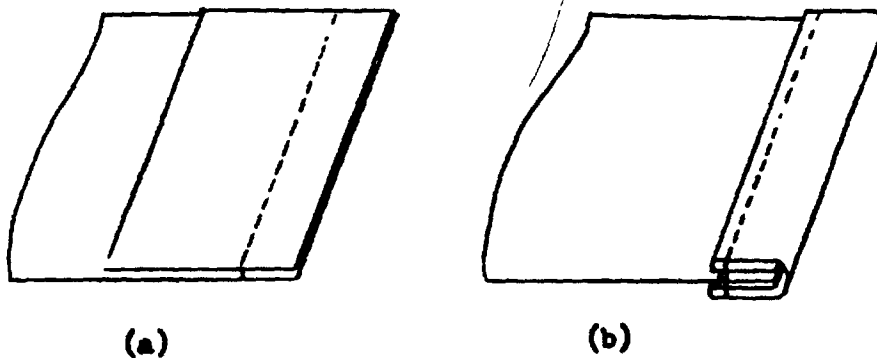

**Seam type BSj-2**

This type of seam shall be formed by:  
(a) superimposing a strip on a ply of body material and seaming with one row of stitches in seam type SSa-1, and

(b) turning the strip around the edge of the body material, folding the edge of the strip, and seaming with a second row of stitches through all plies.



2/13

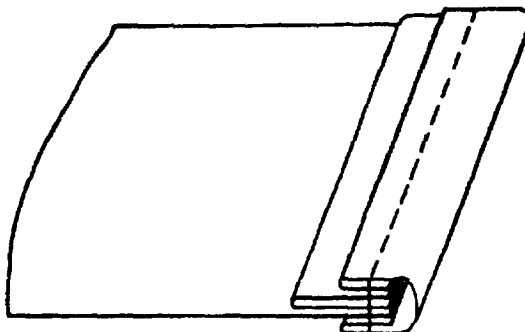

**Seam type BSk-1**

**This type of seam shall be formed by turning both edges of a binding strip, folding it over the edges of a ply or plies of body material**

**and a folded welt strip, and seaming through the binding strip, welt, and body material with one or more rows of stitches.**

Seam Type BSI  
January 25, 1965

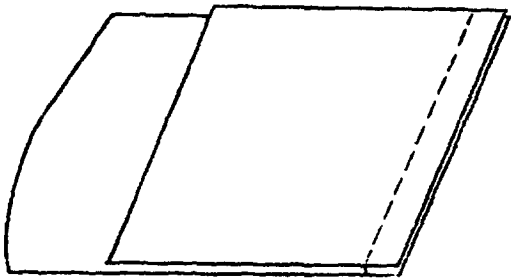

(a)

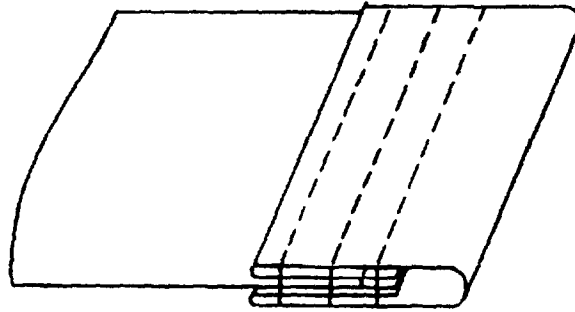

(b)

**Seam type Bsl-l**

This type of seam shall be formed by:

(a) superimposing a strip on a ply of body material and seaming with one row of stitches in seam type Ssa-1, and

(b) turning the strip around the edge of the body material, folding the edge of the strip and seaming with three or more rows of stitches.

214

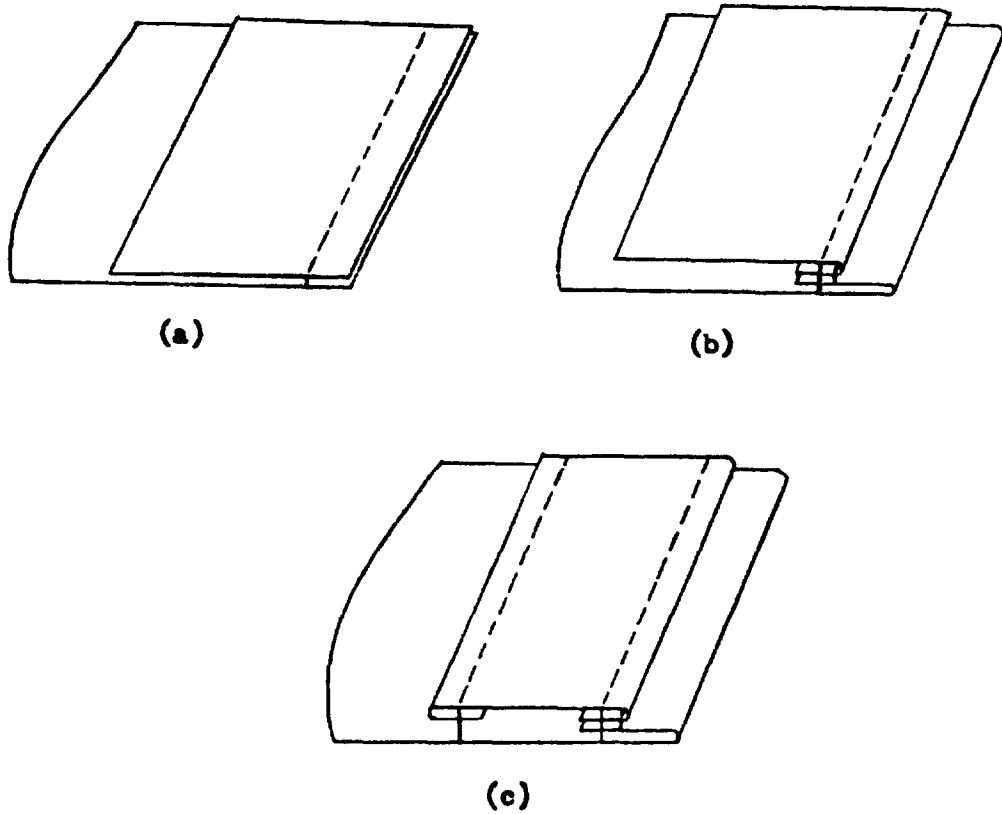

**Seam type B3m-3**

This type of seam shall be formed by:

- (a) superimposing a strip on a ply of body material and seaming with one row of stitches in seam type S3a-1,
- (b) turning the strip at the row of stitching,

folding the body material inward a specified distance, and seaming with one row of stitches, and

- (c) turning the opposite edge of the strip under and seaming through the body material.

**Seam Type ESn**  
**January 25, 1965**

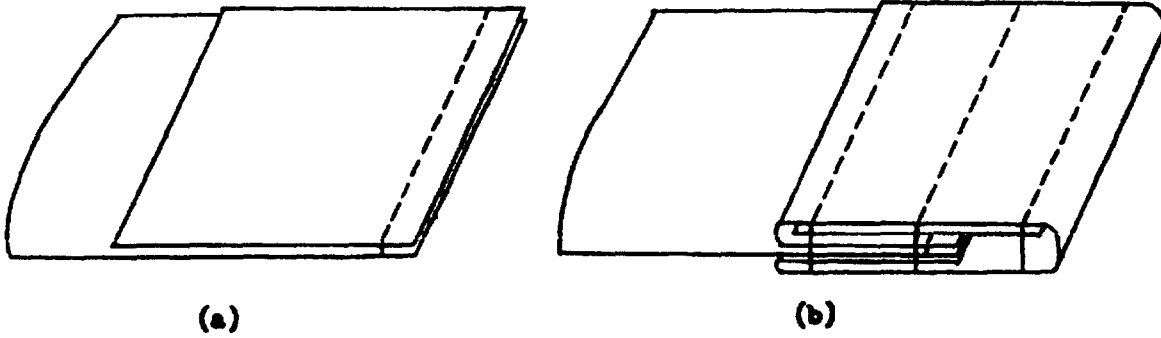

**Seam type ESn-1**

**This type of seam shall be formed by:**

**(a) superimposing a strip on a ply of body material and seaming with one row of stitches in seam type SSe-1, and**

**(b) turning the strip around the edge of the body material with a tape or webbing inserted, folding the edge of the strip and seaming with three or more rows of stitches.**

216

217

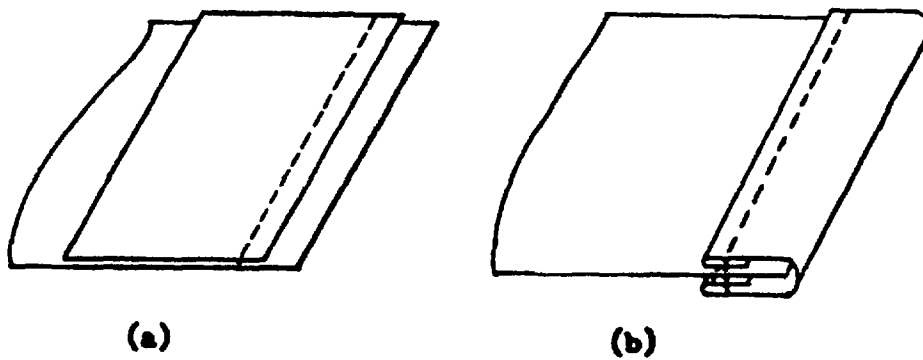

**Seam type BSc-2**

This type of seam shall be formed by:

(a) superimposing a strip on a ply of body material a specified distance from the edge and seaming with one row of stitches in seam type SSbd-1, and

(b) turning the strip over the row of stitches around the edge of the body material, folding the edge of strip, and seaming with a second row of stitches.

**Seam Type BSp**  
**January 25, 1965**

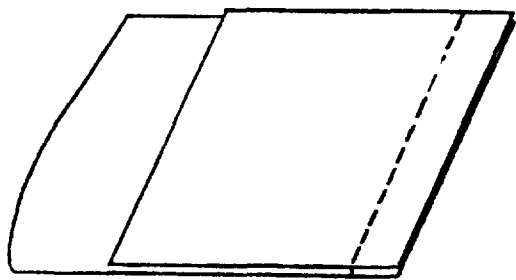

(a)

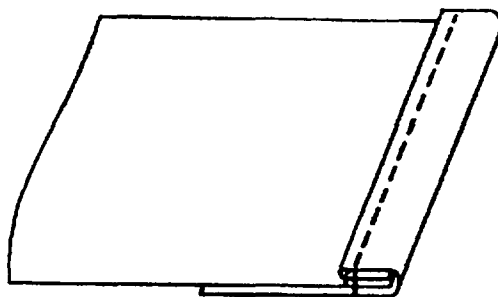

(b)

**Seam type BSp-2**

This type of seam shall be formed by:

(a) superimposing a strip on a ply of body material and seaming with one row of stitches in seam type SSa-1, and

(b) turning the strip over the row of stitches around the edge of the body material and seaming with a second row of stitches through the turned edge of the strip.

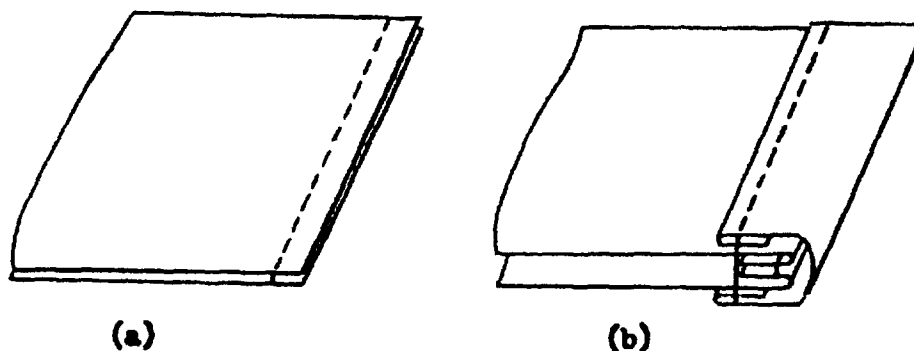

**Seam type BSq-2**

**This type of seam shall be formed by:**

**(a) superimposing two plies of material and seaming with one row of stitches in seam type SSe-1, and**

**(b) turning both edges of a binding strip and folding it over the edges of the plies of body material, and seaming the binding strip and body material with one row of stitches.**

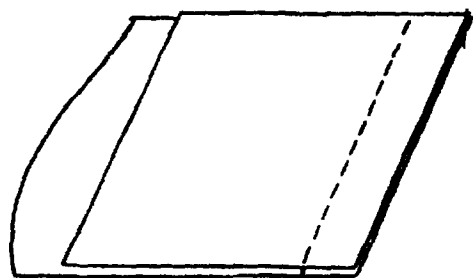

(a)

Seam type Bsr-2

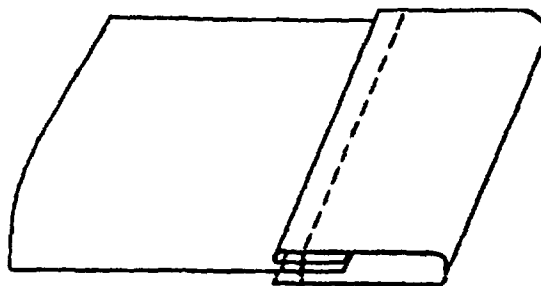

(b)

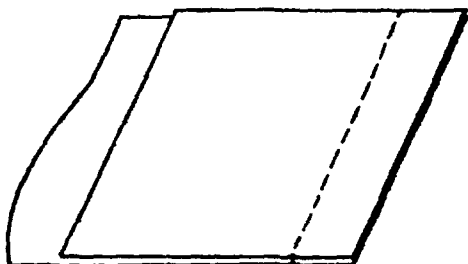

(a)

Seam type Bsr-3

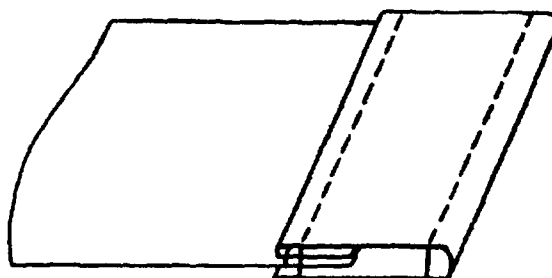

(b)

230

This type of seam shall be formed by:  
(a) superimposing a strip on a ply of body material and seaming with one row of stitches in seam type SSe-1, and

(b) turning the strip over the row of stitches around the edge of the body material and seaming with one or more rows of stitches.



**Seam Type ESs**  
**January 25, 1965**

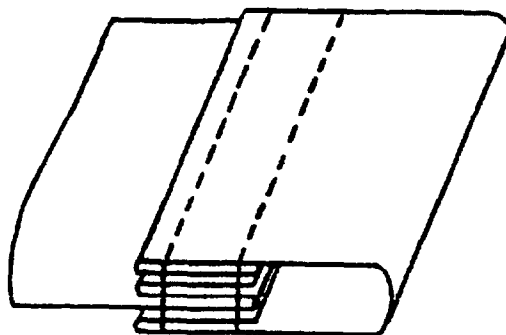

**Seam type ESs-2**

This type of seam shall be formed by folding the edge of the body material in an "S" fold, turning both edges of a binding strip and fold-

ing it over the folded edge of the body material, and seaming the binding strip and body material with two or more rows of stitches.

**Seam Type FSa**  
**January 25, 1965**

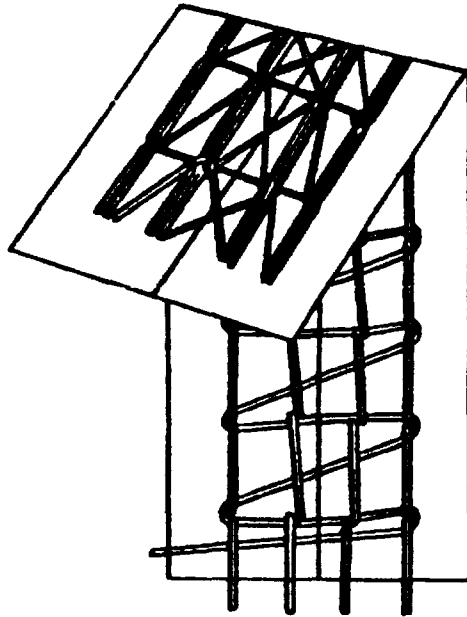

**Seam type FSa-1**

**This type of seam shall be formed by seaming the edges of two or more plies of material with a row of stitches extending across and covering the edges of the material.**

**Seam Type FSb**  
**January 25, 1965**

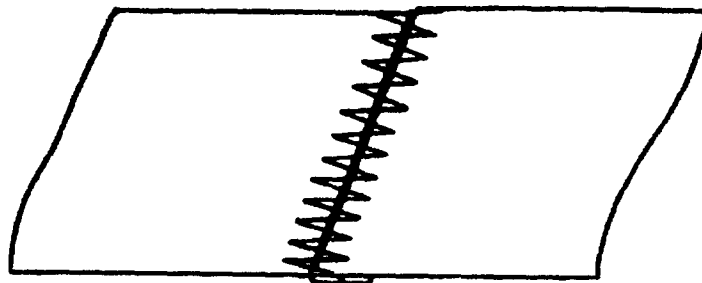

**Seam type FSb-1**

This type of seam shall be formed by turning the edge of one ply of material, abutting it against the raw edge of a second ply of material

and seaming with a row of stitches extending across and covering the turned edge of the first ply and the raw edge of the second ply.

CS

**Seam Type FSb**  
**January 25, 1965**

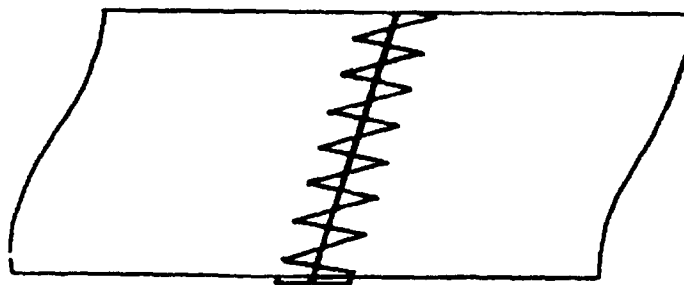

**Seam type FSb-1**

This type of seam shall be formed by turning and abutting the turned edges of two plies of material and seaming with a row of stitches

extending across and covering the turned edges of the material.

**Seam Type F34**  
**January 25, 1945**

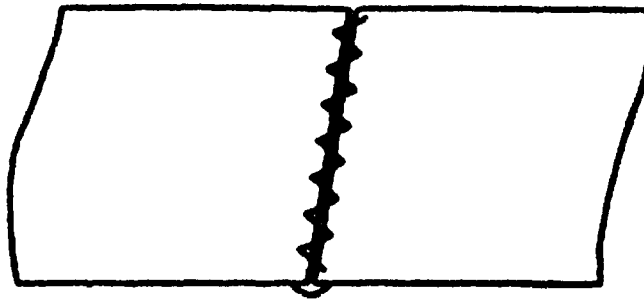

(a)

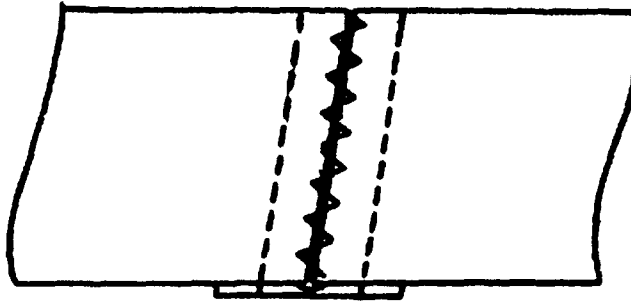

(b)

**Seam type F34-3**

This type of seam shall be formed by:

(a) seaming the edges of two plies of material in seam type F3a-1; and

(b) seaming a reinforcing tape over or under the seam with two rows of stitches a specified distance apart.

152

**Seam Type FB**  
**January 25, 195**

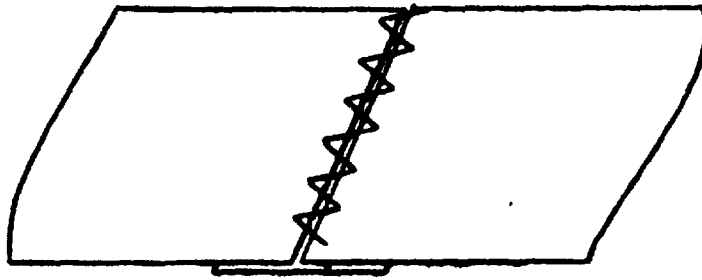

**Seam type FB-1**

**This type of seam shall be formed by abutting the edges of two pieces of material over a reinforcing strip and sewing with a row of stitches**

**extending across and covering the edges of the material.**

**FED. STD. NO. 731a**

8

**Seam Type FSf**  
**January 25, 1955**

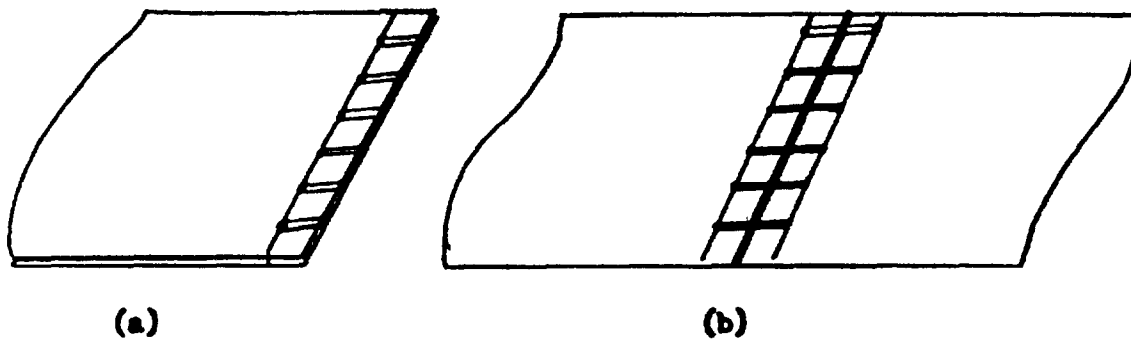

**Seam type FSf-1**

This type of seam shall be formed by:

(a) superimposing two plies of material and seaming with an overedge stitch in seam type SSe-1, and

(b) opening the two plies of material to form a flat seam with the edges of the material abutted.

226

## PART II. REQUIREMENTS

### Section 3. Stitchings

3.1 **Stitchings.** Stitchings are divided into two classes and within each class there are several types. All stitching types shall conform to the applicable drawings unless otherwise specified.

3.1.1 *Stitching class OS.* This class of stitching has for a general characteristic that a series of stitches are embodied in a material either in a straight line, a curve, or following a design, for ornamental purposes.

3.1.2 *Stitching class EF.* This class of stitching has for a general characteristic that edge finishing is accomplished by either:

(a) stitching a series of stitches at or over the edge of a material, the edge may or may not be folded as specified, or

(b) the edge of the material is folded and stitched to the body of the material with a series of stitches.

**Stitching Type O8a**  
**January 25, 1985**

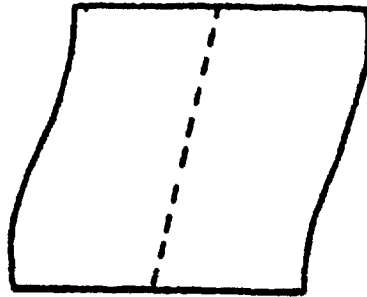

**Stitching type O8a-1**

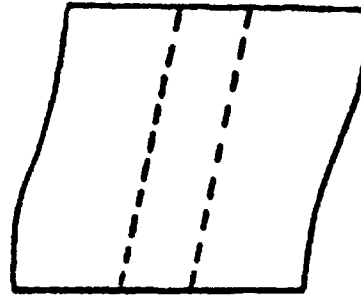

**Stitching type O8a-2**

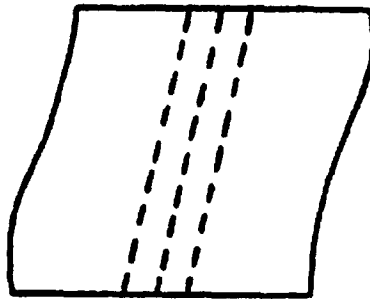

**Stitching type O8a-3**

**This type of stitching shall be produced with one or more straight rows of stitches.**

Low



**Stitching Type OSb**  
**January 25, 1965**

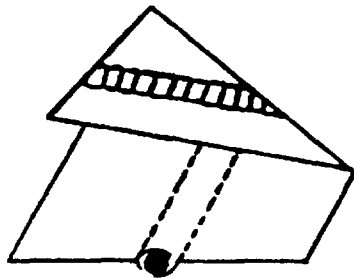

**Stitching type OSb-1**

This type of stitching shall be produced by inserting a cord between the material and the locking thread of the stitch, thus forming a ridge or corded effect.

**Stitching Type OSc**  
**January 25, 1965**

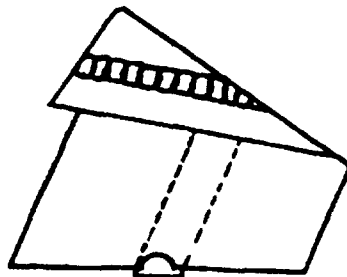

**Stitching type OSc-1**

This type of stitching shall be produced by forming the material in a ridge to give a corded effect without inserting a cord.

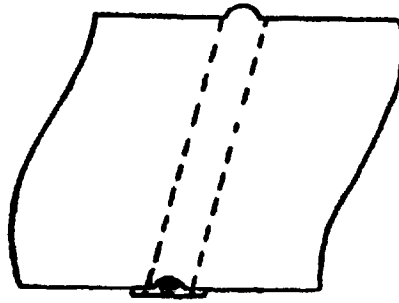

Stitching type OSd-2

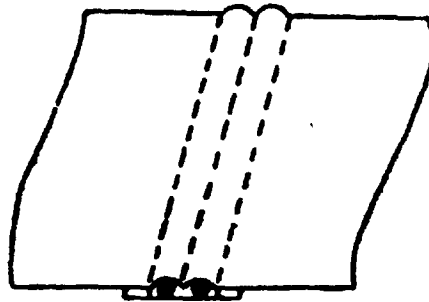

Stitching type OSd-3

This type of stitching shall be produced by inserting a cord or cords between two plies of material and stitching with a row of stitches on each side of the cord or cords.

Stitching Type CSs  
January 25, 1965

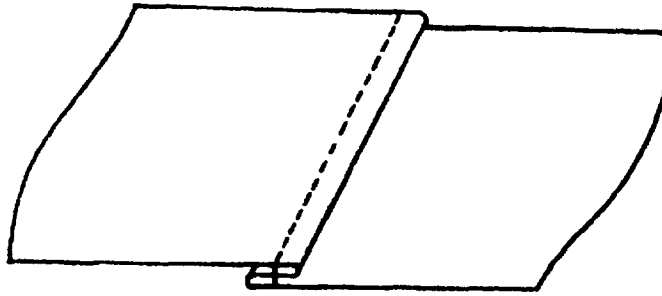

**Stitching type CSs-1**

**This type of stitching shall be produced by folding the material in an "S" or reverse "S" fold as specified, and stitching the fold to the body material with one or more rows of stitches.**

282

Stitching Type CSf  
January 25, 1965

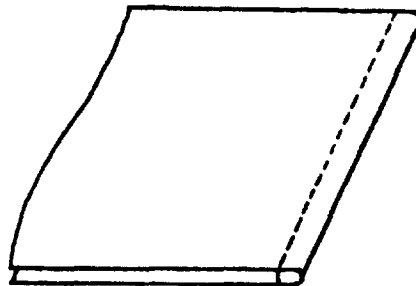

**Stitching type CSf-1**

**This type of stitching shall be produced by folding and stitching plies of the material near the fold with one or more rows of stitches.**

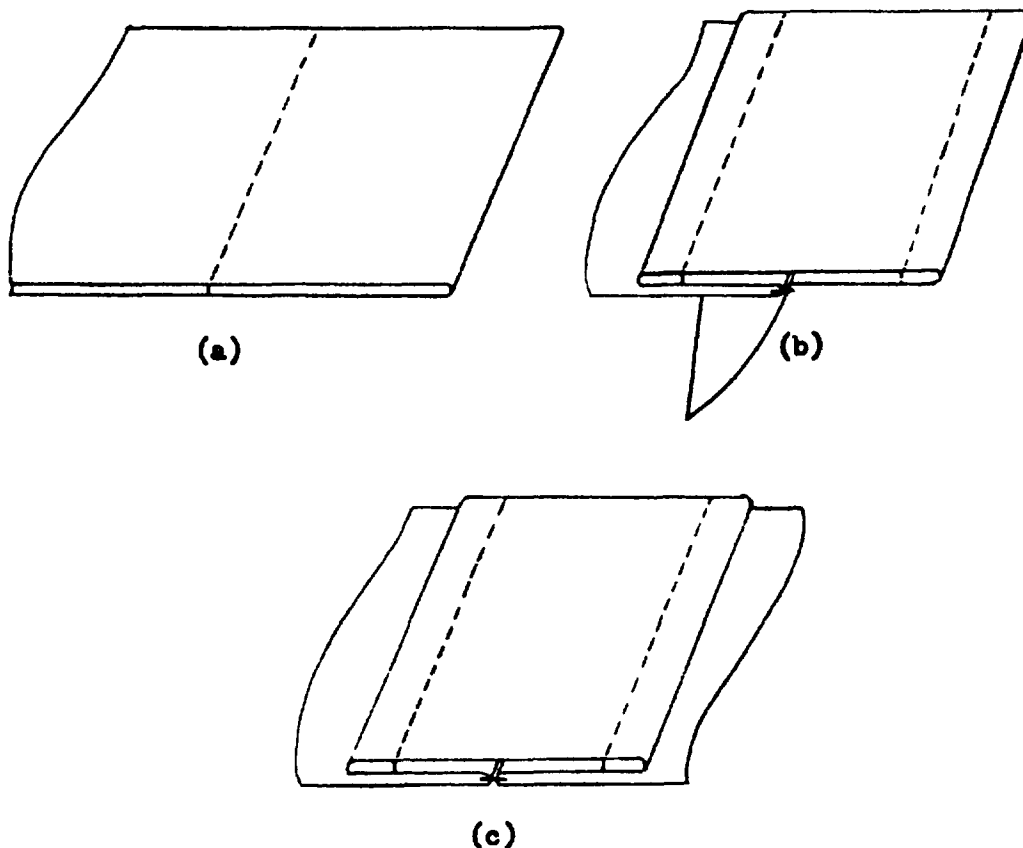

**Stitching type OSg-3**

This type of stitching shall be produced by:  
(a) folding a piece of material and stitching a specified distance from the fold with one row of stitches,  
(b) distributing an equal amount of the material in the fold to each side of the seam, turn-

ing each ply aside separately and stitching a specified distance from each folded edge with one row of stitches, and  
(c) opening both plies of material to finish as shown.

**Stitching Type OSh**  
**January 25, 1945**

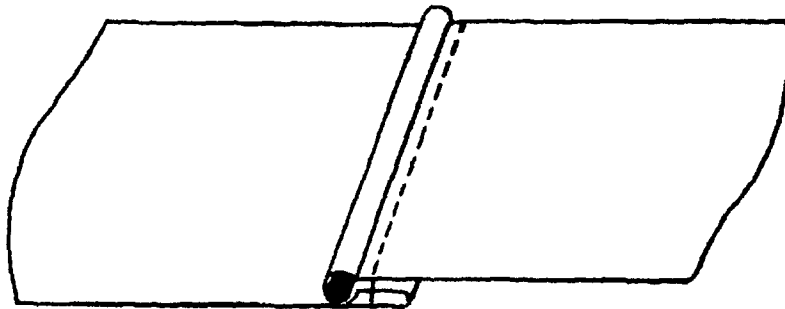

**Stitching type OSh-1**

This type of stitching shall be produced by folding the material in an "S" or reverse "S" fold as specified, inserting a cord in the fold,

and stitching the fold to the body material with one or more rows of stitches.

234

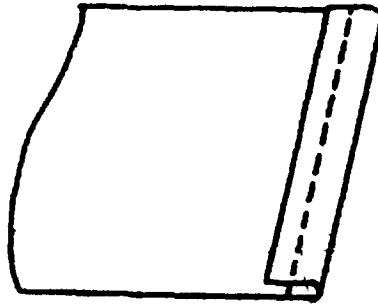

**Stitching type EFa-1**

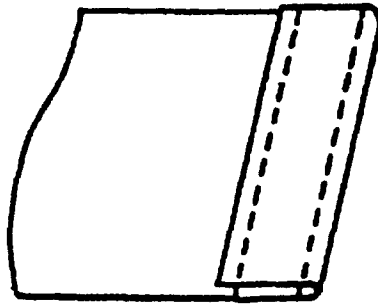

**Stitching type EFa-2**

This type of stitching shall be produced by turning the edge of the material and stitching the turned portion to the body of the material with one or more rows of stitches.

**Stitching Type EFb**  
**January 23, 1955**

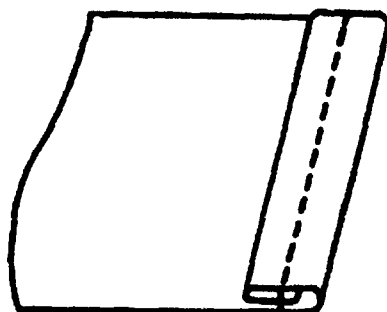

**Stitching type EFb-1**

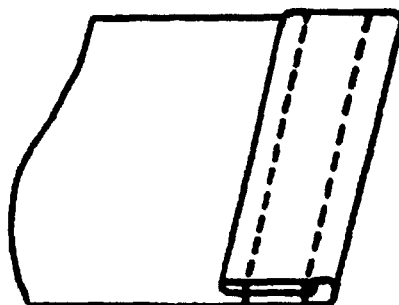

**Stitching type EFb-2**

This type of stitching shall be produced by turning the edge of the material, folding it back over the body of the material, and stitching the

turned and folded portion to the body of the material with one or more rows of stitches.

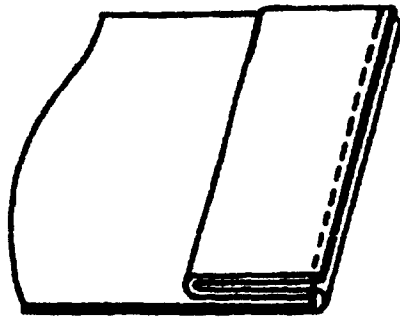

(a)

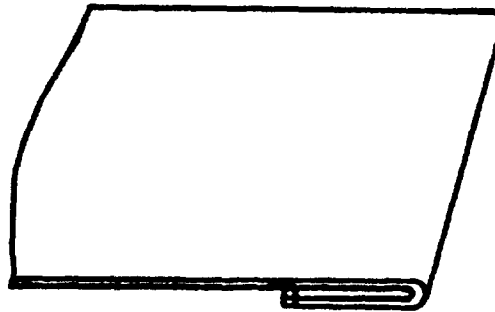

(b)

**Stitching type EFc-1**

This type of stitching shall be produced by folding the edge of the material in an "S" fold and stitching the turned portion to the body with one row of stitches. In sewing, the mate-

rial shall be so guided that the needle only partially penetrates the folded edge. When the material is laid flat, the stitches shall not show on the outer face of the material.

127



**Stitching Type EPd**  
**January 25, 1965**

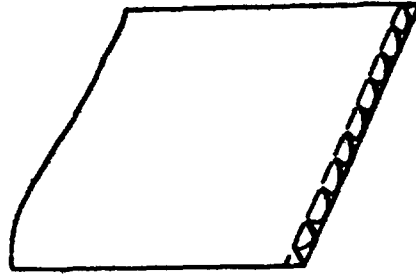

**Stitching type EPd-1**

This type of stitching shall be produced by placing a row of stitches over the edge of the material.

228

**Stitching Type EFe**  
**January 25, 1965**

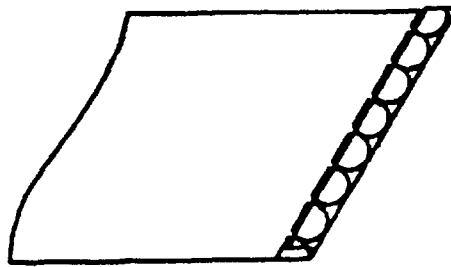

**Stitching type EFe-1**

This type of stitching shall be produced by turning the edge of the material and placing a row of stitches over the edge of the material.

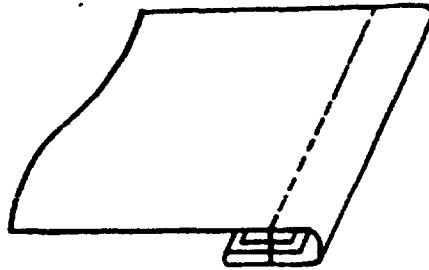

**Stitching type EFi-1**

This type of stitching shall be produced by turning and folding the edge of the material, inserting a strip between the fold and the body of

the material and stitching with one or more rows of stitches.

434

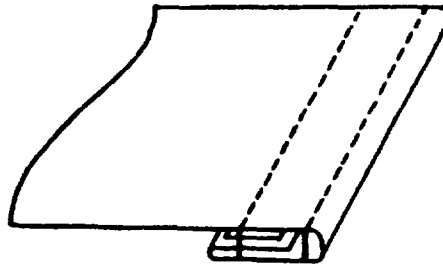

**Stitching type EFg-2**

This type of stitching shall be produced by turning and folding the edge of the material, inserting a strip between the fold and the body

of the material, and stitching with two rows of stitches. The strip shall be secured by one or more rows of stitches as specified.

**Stitching Type EPh**  
**January 25, 1965**

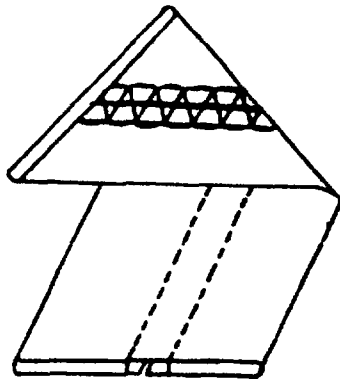

**Stitching type EPh-1**

4. This type of stitching shall be produced by turning the edges of a strip of material, bringing the edges together, and stitching the butted

edges with a row of stitches extending across and covering the edges of the material.

*gpc*

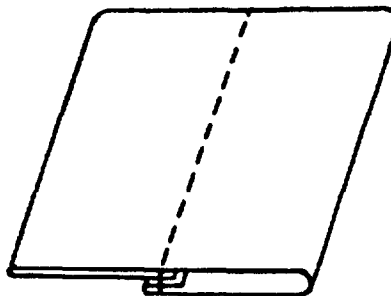

**Stitching type EFj-1**

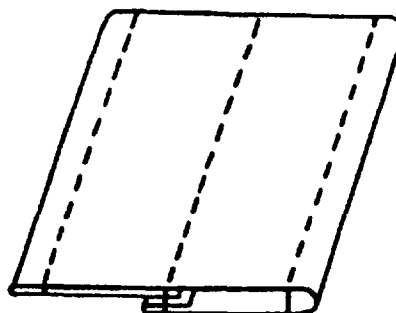

**Stitching type EFj-3**

This type of stitching shall be produced by folding a strip of material, overlapping the edges, turning the edge of the under ply, and stitching through all the plies with one row of

stitches (stitching type EFj-1). One row of stitches shall be placed at each folded edge to form stitching type EFj-3.

**Stitching Type Efk**  
**January 25, 1965**

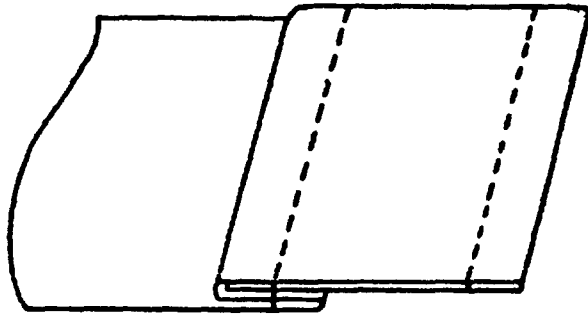

**Stitching type Efk-2**

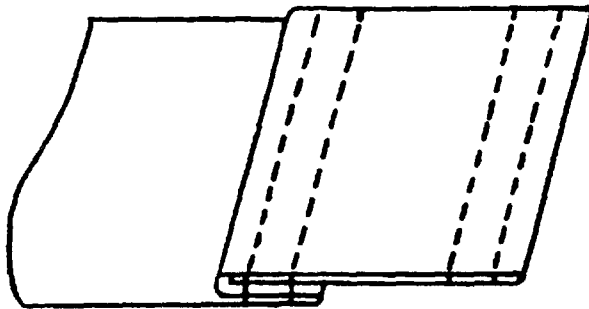

**Stitching type Efk-4**

This type of stitching shall be formed by folding the material in an "S" fold, turning the free edge back into the top of the "S" and stitch-

ing with one or more rows of stitches through each side of the fold.

242

**Stitching Type KF1**  
**January 25, 1965**

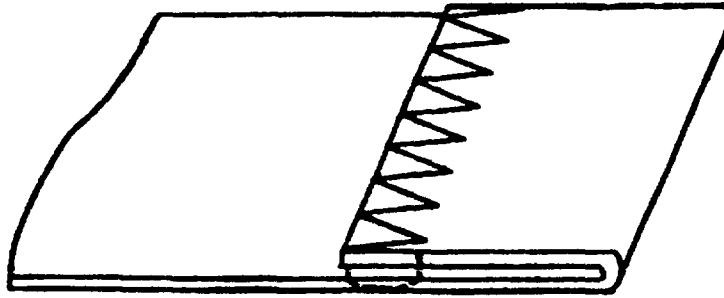

**Stitching type KF1-1**

This type of stitching shall be produced by turning the edge of the material and stitching it to the body material with one row of stitches. The stitches shall overedge the turned edge and

the needle shall only partially penetrate the body material so that the stitches do not show on the outer face of the material.

C10

**Stitching Type KFm**  
**January 25, 1965**

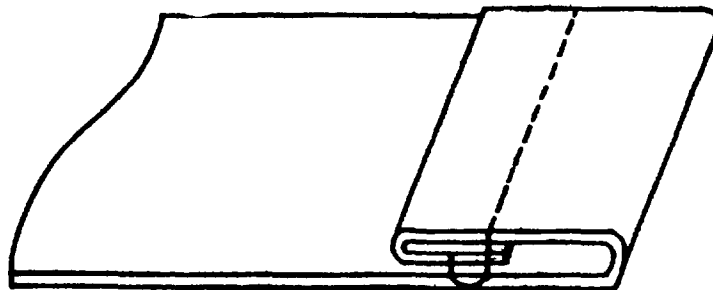

**Stitching type KFm-1**

This type of stitching shall be produced by turning the edge of the material, folding it back over the body material, and joining the turned and folded portion to the body material

with one row of stitches. The needle shall only partially penetrate the body material so that the stitches do not show on the outer face of the material.

**FED. STD. NO. 751d**

**Stitching Type EFn**  
**January 25, 1965**

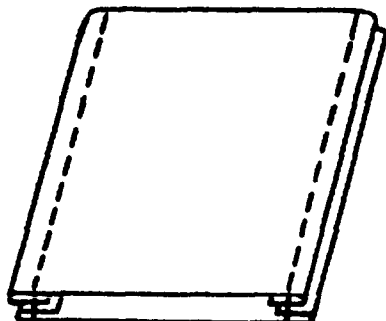

**Stitching type EFn-2**

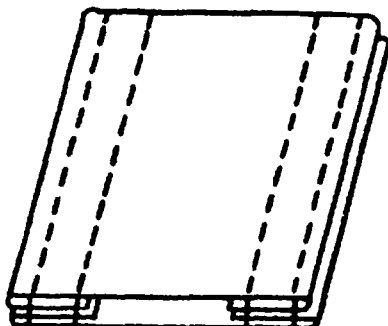

**Stitching type EFn-4**

This type of stitching shall be produced by turning the edges of two strips of material and joining the edges so turned by two or four rows of stitches.

*PH2*

**Stitching Type EPp**  
**January 25, 1965**

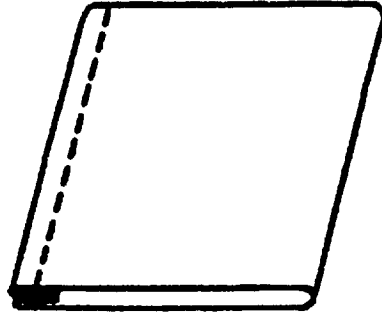

**Stitching type EPp-1**

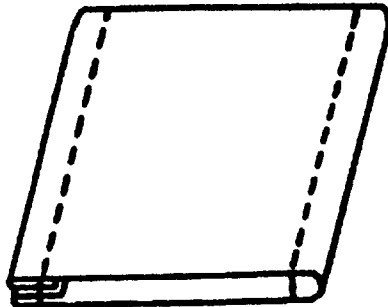

**Stitching type EPp-2**

This type of stitching shall be produced by turning a strip of material, folding the edges inwardly and joining with one or two rows of stitches.



**Stitching Type EFe**  
**January 25, 1965**

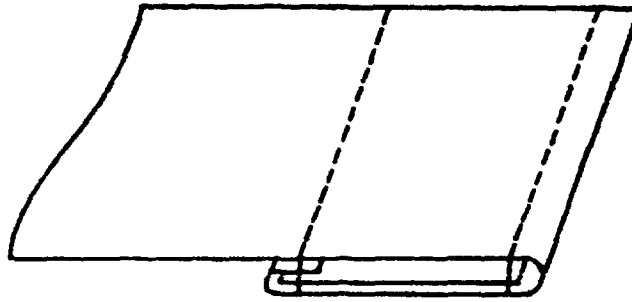

**Stitching type EFe-2**

This type of stitching shall be produced by turning and folding the edge of the material around a strip and stitching with two or four

rows of stitches. The strip shall be secured by all the rows of stitches.

246

**Stitching Type EFr**  
**January 25, 1965**

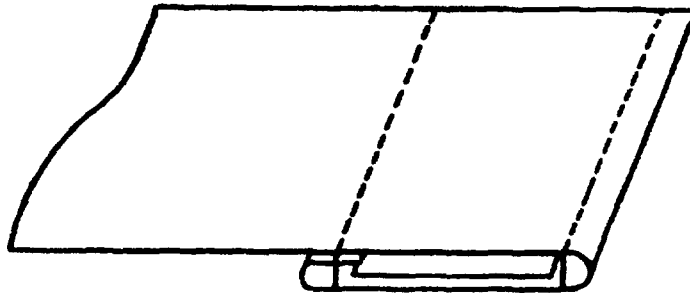

**Stitching type EFr-2**

This type of stitching shall be produced by turning and folding the edge of the material around a strip and stitching the material with

two rows of stitches. The strip shall not be caught in either of the rows of stitches.

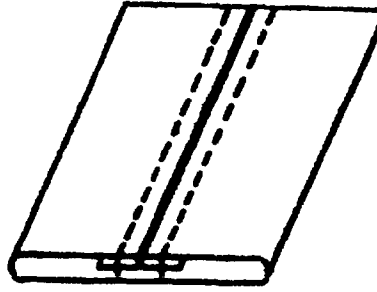

**Stitching type EPs-2**

This type of stitching shall be produced by turning both edges of a strip of material upward and then downward, shutting the folded edges, and stitching with two rows of stitches.

11

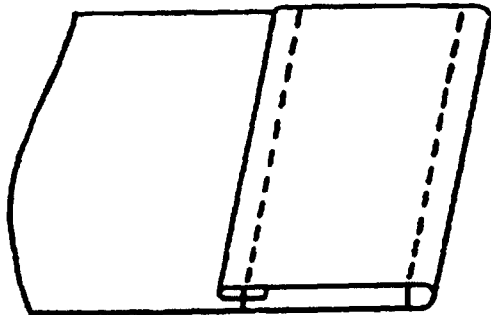

Stitching type EFT-2

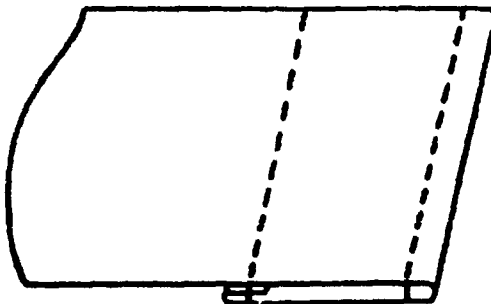

Stitching type EFT-2  
(Inverted)

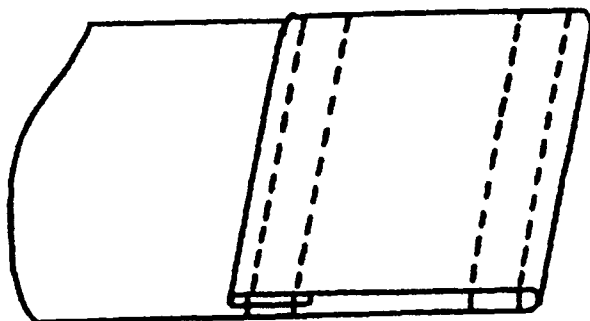

Stitching type EFT-4

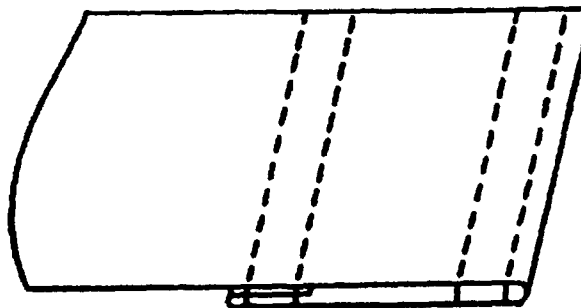

Stitching type EFT-4  
(Inverted)

This type of stitching shall be produced by turning the edge of the material, folding it back

over the body material and stitching with two or more rows of stitches.

248

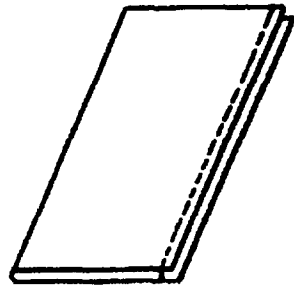

(a)



(b)

**Stitching type EFu-1**

This type of stitching shall be formed by folding a piece of material with the face inside and stitching along the edge with one row of

stitches. After stitching, the cylinder thus made is turned inside out to place the face of the material on the outside.

**Stitching Type EFv**  
**January 23, 1952**

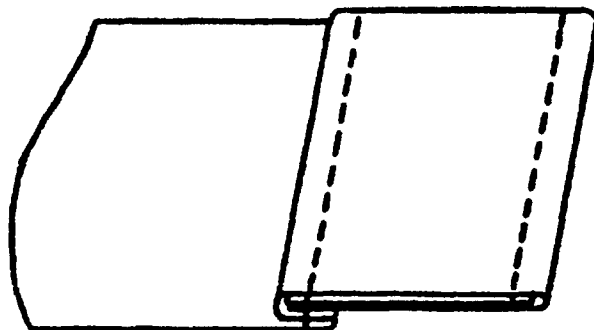

**Stitching type EFv-2**

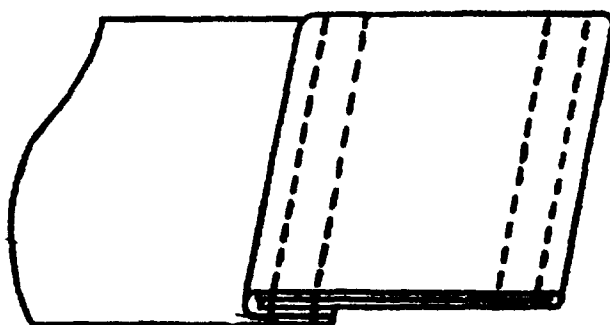

**Stitching type EFv-4**

This type of stitching shall be formed by folding the material, inserting an interlining strip, and stitching with two or four rows of stitches.

252

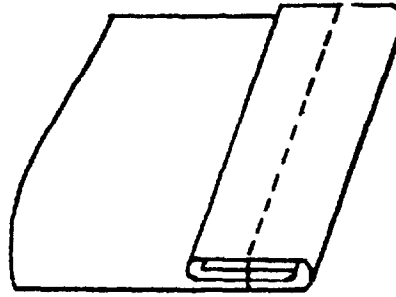

**Stitching type EPw-1**

**This type of stitching shall be produced by turning the edge back over the body material and in under that fold, and stitching the turned**

**and folded portion to the body of the material with one or more rows of stitches.**

Stitching Type EFX  
January 25, 1965

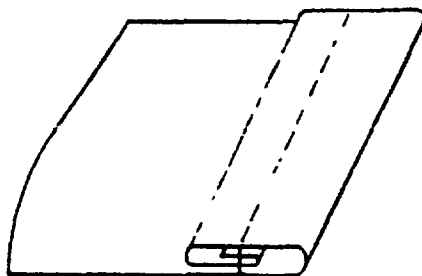

**Stitching type EFX-1**

This type of stitching shall be produced by turning the edge back over the body material and in under that fold a specified distance, and

stitching turned and folded portion to the body of the material with one or more rows of stitches.

252

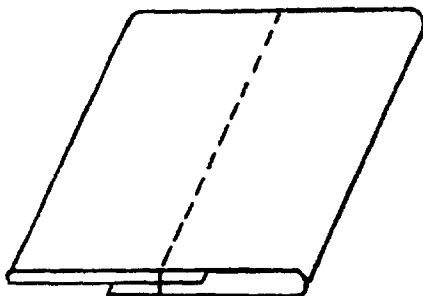

**Stitching type EFy-1**

)  
)  
)  
This type of stitching shall be produced by folding a strip of material, overlapping the edges, and stitching through all plies with one

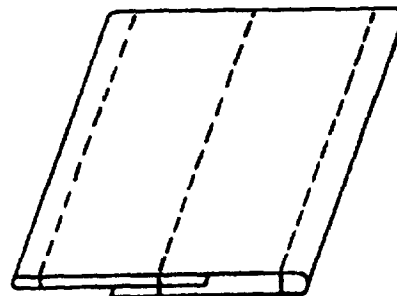

**Stitching type EFy-3**

row of stitches to form stitching type EFy-1. One row of stitches shall be placed at each folded edge to form stitching type EFy-3.



Stitching Type EFs  
January 25, 1965

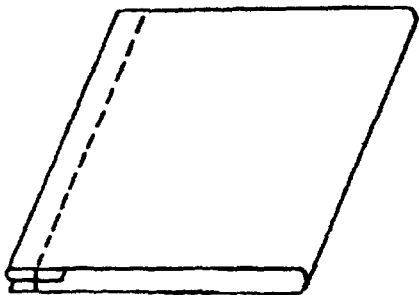

**Stitching type EFs-1**

This type of stitching shall be produced by turning a strip of material, folding one edge

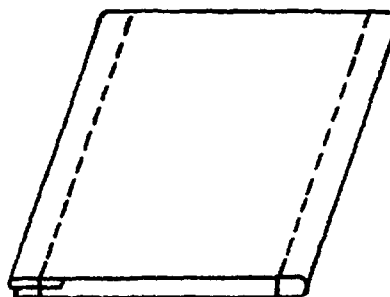

**Stitching type EFs-2**

inwardly and joining with one or two rows of stitches.

751a

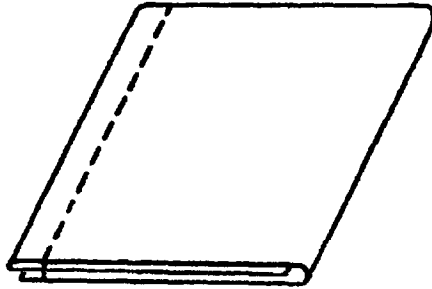

**Stitching type KFaa-1**

This type of stitching shall be produced by folding a strip of material to form three plies

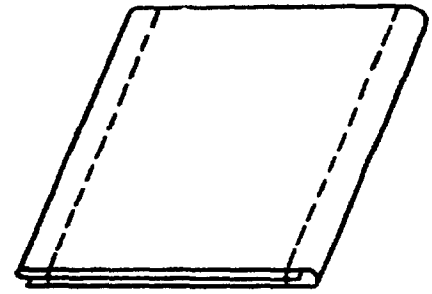

**Stitching type KFaa-2**

and joining with one or two rows of stitches.

**Stitching Type EFab**  
**January 23, 1946**

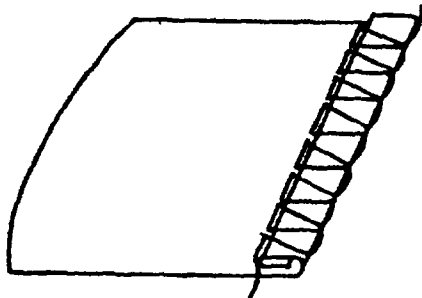

**Stitching type EFab-1**

This type of stitching shall be produced by turning the edge of the material, folding it back over the body of the material, and placing

one or more rows of stitches over the edge of the material.

257

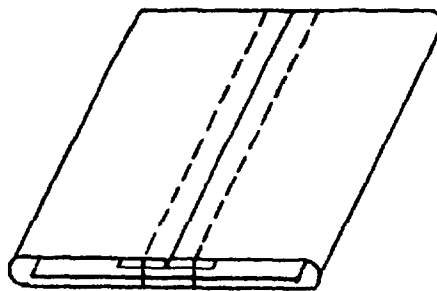

**Stitching type EFac-2**

This type of stitching shall be produced by turning both edges of a strip of material around a reinforcing strip, turning the edges inward,

abutting the folded edges and stitching with two rows of stitches.

**Stitching Type EFad**  
**January 25, 1965**

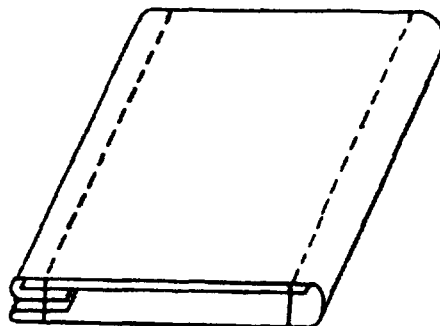

**Stitching type EFad-2**

This type of stitching shall be produced by turning a strip of material, inserting a reinforcing strip, folding the edges of the material inwardly with one edge folded around the strip,

and stitching with two or more rows of stitches. The strip shall be secured by all the rows of stitches.

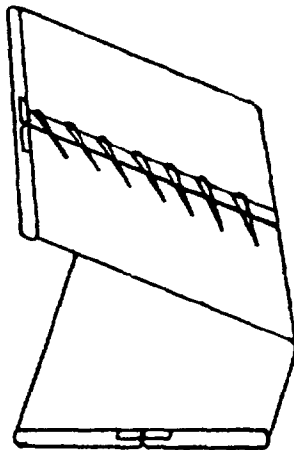

**Stitching type EFae-1**

1 m  
This type of stitching shall be produced by turning both edges of a strip of material upward and then downward, abutting the folded edges, and stitching with a row of stitches ex-

tending across and covering the abutted edges of the material. The needle shall penetrate only partially the under ply so that the stitches do not show on the outer surface of the material.

**Stitching Type EFaf**  
**January 25, 1965**

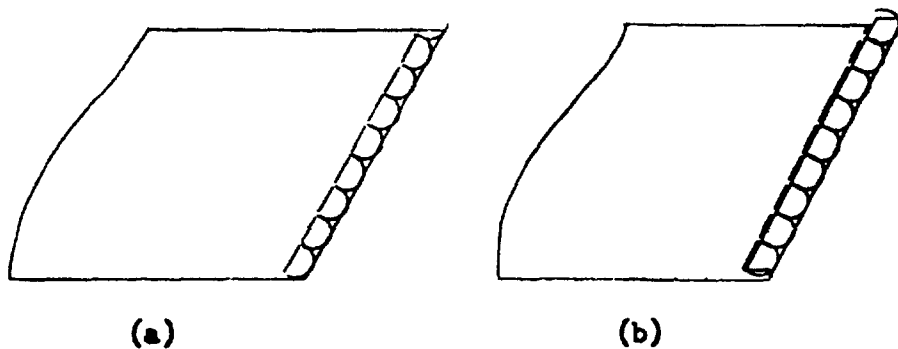

**Stitching type EFaf-2**

This type of stitching shall be produced by:  
(a) placing a row of stitches over the edge of the material, and

(b) turning the overedged edge and placing one or more rows of stitches over the turned edge of the material.

260

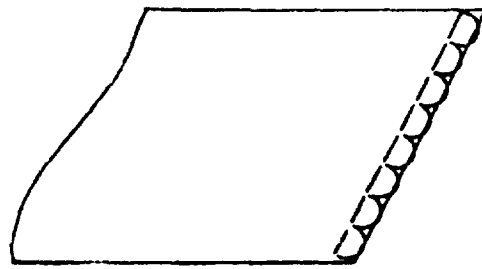

(a)

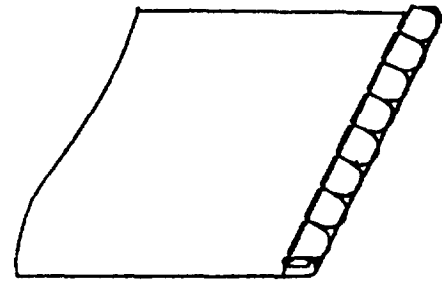

(b)

**Stitching type EFag-2**

This type of stitching shall be produced by:  
(a) placing a row of stitches over the edge of the material, and

(b) turning and folding the overedged edge and placing one or more rows of stitches over the turned edge of the material.



**Stitching Type EFah**  
**January 25, 1945**

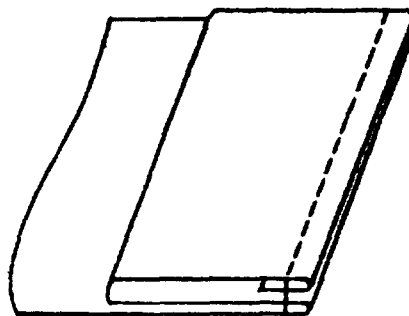

**Stitching type EFah-1**

This type of stitching shall be produced by folding the edge of the material in an "S" fold with the raw edge turned under to form a fin-

ished edge, and stitching through the two folds with one row of stitches.

262

**INSTRUCTIONS:** In a continuing effort to make our standardization documents better, the DoD provides this form for use in submitting comments and suggestions for improvements. All users of military standardization documents are invited to provide suggestions. This form may be detached, folded along the lines indicated, taped along the loose edge (*DO NOT STAPLE*), and mailed. In block 5, be as specific as possible about particular problem areas such as wording which required interpretation, was too rigid, restrictive, loose, ambiguous, or was incompatible, and give proposed wording changes which would alleviate the problems. Enter in block 6 any remarks not related to a specific paragraph of the document. If block 7 is filled out, an acknowledgement will be mailed to you within 30 days to let you know that your comments were received and are being considered

**NOTE.** This form may not be used to request copies of documents, nor to request waivers, deviations, or clarification of specification requirements on current contracts. Comments submitted on this form do not constitute or imply authorization to waive any portion of the referenced document(s) or to amend contractual requirements.

(Fold along this line)

263

(Fold along this line)

DEPARTMENT OF THE ARMY



NO POSTAGE  
NECESSARY  
IF MAILED  
IN THE  
UNITED STATES

OFFICIAL BUSINESS  
PENALTY FOR PRIVATE USE \$300

**BUSINESS REPLY MAIL**  
FIRST CLASS PERMIT NO 12062 WASHINGTON D C  
POSTAGE WILL BE PAID BY THE DEPARTMENT OF THE ARMY

Commander  
US Army Natick Research and Development  
Laboratories  
ATTN: DRDNA-ES (Mr. D. Juppino)

