



Space engineering

Adhesive bonding handbook

Foreword

This Handbook is one document of the series of ECSS Documents intended to be used as supporting material for ECSS Standards in space projects and applications. ECSS is a cooperative effort of the European Space Agency, national space agencies and European industry associations for the purpose of developing and maintaining common standards.

This handbook has been prepared by the ECSS-E-HB-32-21A Working Group, reviewed by the ECSS Executive Secretariat and approved by the ECSS Technical Authority.

Disclaimer

ECSS does not provide any warranty whatsoever, whether expressed, implied, or statutory, including, but not limited to, any warranty of merchantability or fitness for a particular purpose or any warranty that the contents of the item are error-free. In no respect shall ECSS incur any liability for any damages, including, but not limited to, direct, indirect, special, or consequential damages arising out of, resulting from, or in any way connected to the use of this document, whether or not based upon warranty, business agreement, tort, or otherwise; whether or not injury was sustained by persons or property or otherwise; and whether or not loss was sustained from, or arose out of, the results of, the item, or any services that may be provided by ECSS.

Published by: ESA Requirements and Standards Division
ESTEC, P.O. Box 299,
2200 AG Noordwijk
The Netherlands

Copyright: 2011© by the European Space Agency for the members of ECSS

Change log

ECSS-E-HB-32-21A 20 March 2011	First issue
-----------------------------------	-------------

Table of contents

Change log	3
1 Scope	29
2 References	30
3 Terms, definitions and abbreviated terms	31
3.1 Terms from other documents	31
3.2 Terms specific to the present document'	31
3.3 References	49
4 Joining	50
4.1 Joining methods for space structures.....	50
4.1.1 General.....	50
4.1.2 Adhesive bonding	50
4.1.3 Mechanical fastening disadvantages.....	51
4.2 References	52
4.2.1 General.....	52
4.2.2 ECSS documents	53
5 Adherends	54
5.1 Introduction.....	54
5.1.1 General.....	54
5.1.2 Polymer composites	55
5.1.3 Metals	55
5.1.4 Ceramics	56
5.2 Advanced composites	57
5.2.1 Polymer-based composites	57
5.2.2 FML - Fibre metal laminates.....	61
5.2.3 MMC - Metal matrix composites	61
5.3 Metals.....	62
5.3.1 Structural materials.....	62
5.3.2 New materials.....	62

5.4	Higher-temperature applications	63
5.4.1	Adherends	63
5.4.2	Adhesives	63
5.4.3	General guidelines.....	65
5.5	Low-temperature and cryogenic applications	65
5.5.1	Adherends	65
5.5.2	Adhesives	65
5.5.3	General guidelines.....	66
5.6	Bonds between adherends.....	66
5.6.1	General.....	66
5.6.2	Composite-to-composite.....	66
5.6.3	Composite-to-metal	67
5.6.4	Metal-to-metal.....	67
5.6.5	Dissimilar materials	67
5.7	References	68
5.7.1	General.....	68
5.7.2	ECSS documents	69
6	Adhesive characteristics and properties.....	70
6.1	Introduction.....	70
6.1.1	General.....	70
6.1.2	Guidelines.....	70
6.2	Types of adhesives	71
6.2.1	Formulation.....	71
6.2.2	Characteristics.....	71
6.2.3	Mechanical properties	74
6.2.4	Environmental durability	74
6.2.5	Aerospace structural adhesives	75
6.3	Epoxy-based adhesives	75
6.3.1	General.....	75
6.3.2	Properties	76
6.3.3	Environmental durability	81
6.4	Polyimide-based adhesives.....	85
6.4.1	General.....	85
6.4.2	Properties	86
6.5	Bismaleimide-based adhesives.....	88
6.5.1	General.....	88
6.5.2	Properties	88

6.6	Silicone-based adhesives.....	90
6.6.1	General.....	90
6.6.2	Properties	90
6.6.3	Environmental durability	92
6.7	Elastomeric adhesives	93
6.7.1	General.....	93
6.8	Adhesives used in space.....	93
6.8.1	Adhesive systems.....	93
6.9	References	97
6.9.1	General.....	97
6.9.2	Data sheets	98
6.9.3	Sources	99
6.9.4	ECSS documents	99
6.9.5	Other standards.....	99
7	Adhesive selection	100
7.1	Introduction.....	100
7.2	Adhesive selection factors.....	100
7.2.1	Guidelines.....	100
7.2.2	Evaluation exercise	100
7.2.3	Trade-off.....	101
7.3	Post application selection factors	102
7.3.1	Earth environment	102
7.3.2	Space environment.....	104
7.4	Pre-application selection factors	107
7.4.1	Joint design	107
7.4.2	Adhesive systems.....	107
7.4.3	Environmental factors.....	109
7.4.4	Cost factors	109
7.5	Application.....	110
7.5.1	Method.....	110
7.5.2	Cure factors.....	111
7.5.3	Health and safety.....	112
7.6	Adhesive screening criteria for space	113
7.7	References	114
7.7.1	General.....	114
7.7.2	ECSS documents	115
7.7.3	Other standards.....	116

8 Basic joint types	117
8.1 Introduction.....	117
8.2 Bond or mechanically fasten	117
8.2.1 General.....	117
8.2.2 Adhesive bonding in the space industry	119
8.3 Loading modes.....	119
8.4 Tensile shear loading	120
8.4.1 General.....	120
8.4.2 Joint geometry	121
8.4.3 Composite adherends	123
8.5 References	125
8.5.1 General.....	125
8.5.2 Sources	125
8.5.3 ECSS documents	126
9 Joint selection	127
9.1 Introduction.....	127
9.2 Joint strength.....	127
9.2.1 Failure modes.....	127
9.2.2 Guidelines.....	131
9.2.3 Joint design	132
9.3 Fatigue resistance	133
9.3.1 General.....	133
9.3.2 Joint evaluation.....	133
9.3.3 Factors influencing fatigue resistance	134
9.4 Acoustic fatigue resistance.....	136
9.4.1 Bonded carbon/epoxy composite joints.....	136
9.5 References	138
9.5.1 General.....	138
10 Theory and design practices	139
10.1 Introduction.....	139
10.1.1 Analysis	139
10.1.2 Factors of safety	139
10.2 Basic theories of bonded joints	139
10.2.1 Shear lag analysis	139
10.2.2 Linear-elastic stress-strain response.....	140
10.2.3 Non-linear stress-strain response.....	140

10.3	Environmental factors for bonded joints	145
10.3.1	Effect of temperature and moisture	145
10.4	Effect of bonding defects	149
10.4.1	General.....	149
10.4.2	Description of bonding defects	149
10.4.3	NDT non-destructive techniques	157
10.5	Double lap and double strap joints	159
10.5.1	Stress distribution	159
10.6	Single lap joints	163
10.6.1	General.....	163
10.6.2	Load path eccentricity.....	163
10.6.3	Joint efficiencies	163
10.6.4	Adhesive characteristics.....	166
10.7	Double-sided stepped lap joints	166
10.7.1	Joint strength	166
10.7.2	Adherend stiffness balance	166
10.8	Single-sided stepped lap joints.....	169
10.8.1	Joint strength	169
10.9	Scarf joints.....	169
10.9.1	Joint strength	169
10.10	Calculation of bonded joint strength	170
10.11	Analysis of joint configurations	170
10.11.1	Analytical notation	170
10.11.2	Single lap shear joint	171
10.11.3	Double lap shear joint.....	174
10.11.4	Double-lap shear joint under mechanical and temperature loads	176
10.11.5	Single taper scarf joint	184
10.11.6	Double taper scarf joint.....	185
10.11.7	Stepped lap joint.....	186
10.11.8	Analysis of environmental factors.....	187
10.12	Analytical design tools.....	188
10.12.1	General.....	188
10.12.2	Commercial software.....	188
10.12.3	In-house software	188
10.13	ESAComp®	188
10.13.1	Background	188
10.13.2	Usage and scope.....	189

10.13.3 Analysis and data	189
10.14 Astrium: Example spreadsheet	192
10.14.1 General.....	192
10.14.2 Usage and scope.....	192
10.14.3 Analysis and data	192
10.15 ESDU data and software.....	195
10.15.1 General.....	195
10.15.2 ESDU 78042: Bonded joints - 1.....	195
10.15.3 ESDU 79016: Bonded joints – 2.....	196
10.15.4 ESDU 80011: Bonded joints – 3.....	197
10.15.5 ESDU 80039: Bonded joints – 4.....	197
10.15.6 ESDU 81022: Bonded joints – 5.....	198
10.16 Design chart	199
10.16.1 Aide memoire	199
10.16.2 Joint category	199
10.17 References	202
10.17.1 General.....	202
10.17.2 ECSS documents	204
10.17.3 Other standards.....	204
11 Design allowables	205
11.1 Introduction.....	205
11.2 Single lap joint	206
11.2.1 Static loading	206
11.2.2 Dynamic loading.....	210
11.3 Double lap joint.....	212
11.3.1 Static loading	212
11.4 Symmetrical double scarf joint	213
11.4.1 Static loading	213
11.4.2 Dynamic loading.....	215
11.5 References	217
11.5.1 General.....	217
11.5.2 ECSS documents	217
12 Surface preparation.....	218
12.1 Introduction.....	218
12.1.1 General.....	218
12.1.2 Standard processes.....	219
12.1.3 Development processes	220

12.1.4	Process steps	220
12.1.5	Legislation	220
12.2	Composites: Thermosetting matrix.....	220
12.2.1	General.....	220
12.2.2	Techniques	221
12.2.3	Abrasion	221
12.2.4	Peel ply	223
12.3	Composites: Thermoplastic matrix	224
12.3.1	General.....	224
12.3.2	Proposed methods	224
12.4	Aluminium alloys	225
12.4.1	Aerospace aluminium alloys.....	225
12.4.2	MMC and Al-Lithium alloys.....	226
12.4.3	Optimised Forest Products Laboratory (FPL) etch	227
12.4.4	Phosphoric acid anodising (PAA)	229
12.4.5	Chromic acid anodising (CAA)	229
12.4.6	Boric sulphuric acid anodising (BSAA)	230
12.4.7	Thin film sulphuric acid anodising (TFSAA).....	233
12.4.8	Solvent vapour cleaning	233
12.4.9	Development processes	234
12.5	Titanium alloys	235
12.5.1	General.....	235
12.5.2	Acid or alkali etch	236
12.5.3	Non-chromium proprietary process	237
12.6	References	237
12.6.1	General.....	237
12.6.2	ECSS documents	239
13	Bonding methods	240
13.1	Introduction.....	240
13.1.1	Basic methods	240
13.1.2	Adhesives	240
13.1.3	Composite structures.....	241
13.2	Co-curing.....	242
13.2.1	Applications	242
13.2.2	Loading.....	244
13.2.3	Adhesives	245
13.2.4	Tooling.....	245

13.3	Secondary bonding	246
13.3.1	General.....	246
13.3.2	Adhesives	246
13.3.3	Tooling.....	246
13.4	Applying adhesives	247
13.4.1	Film adhesives.....	247
13.4.2	Paste adhesives	247
13.4.3	Manufacturing processes	250
13.5	Manufacturing factors for adhesives	251
13.5.1	General.....	251
13.5.2	Product-specific factors	251
13.6	Bondline integrity	253
13.6.1	General.....	253
13.6.2	Manufacturing-related factors.....	253
13.7	Thermal bonding thermoplastic composites.....	253
13.7.1	General.....	253
13.7.2	Direct bonding	254
13.7.3	Thermabond process.....	254
13.7.4	Welding techniques	255
13.8	Rapid adhesive bonding (RAB)	255
13.8.1	General.....	255
13.8.2	Applications	255
13.8.3	Materials.....	255
13.8.4	Process.....	257
13.8.5	Equipment	257
13.8.6	Carbon fibre reinforced composites.....	258
13.8.7	Joint strength	259
13.9	References	259
13.9.1	General.....	259
13.9.2	ECSS documents	259
14	Quality assurance.....	260
14.1	Introduction.....	260
14.1.1	Documentation	260
14.1.2	Standards	260
14.1.3	Aerospace applications	260
14.2	Quality system.....	261
14.2.1	General.....	261

14.3	Specifications	261
14.3.1	Procurement.....	261
14.3.2	Incoming inspection.....	262
14.3.3	Design	262
14.3.4	Processes.....	262
14.3.5	Materials.....	263
14.3.6	Training personnel.....	264
14.4	Check lists	264
14.4.1	Material procurement.....	264
14.4.2	Bonded joints.....	268
14.5	References	270
14.5.1	General.....	270
14.5.2	ECSS documents	270
15	Test methods	271
15.1	Introduction.....	271
15.1.1	Use of test methods.....	271
15.1.2	Adhesives for space use	271
15.1.3	Characterisation of adhesives	273
15.1.4	Assessment of adhesive bonding process	274
15.1.5	Test methods and standards	275
15.2	Tensile tests for adhesives.....	276
15.2.1	General.....	276
15.2.2	Adhesive evaluation	276
15.2.3	Sandwich panels: Flatwise tensile strength.....	277
15.3	Shear tests for adhesives.....	277
15.3.1	General.....	277
15.3.2	Napkin ring	277
15.3.3	Thick adherend single lap.....	278
15.3.4	Single lap.....	278
15.3.5	Double lap	280
15.3.6	Cracked lap shear (CLS)	282
15.4	Cleavage of adhesives	283
15.4.1	General.....	283
15.4.2	Specimen geometry.....	283
15.4.3	Typical test results.....	286
15.4.4	Calculation of fracture strength.....	287
15.4.5	Loading.....	289

15.5	Bond durability by wedge test	289
15.5.1	General.....	289
15.5.2	Test specimen and configuration.....	289
15.5.3	Results and analysis.....	291
15.6	Peel tests.....	291
15.6.1	General.....	291
15.6.2	Climbing drum peel test for adhesives	292
15.6.3	T-peel test.....	293
15.6.4	Floating roller peel.....	293
15.7	Fatigue resistance	294
15.7.1	Fatigue properties of adhesives	294
15.7.2	Fatigue resistance of bonded joints.....	295
15.7.3	Acoustic fatigue	297
15.8	Creep resistance	297
15.8.1	Adhesive properties.....	297
15.8.2	Test methods.....	298
15.9	Environmental resistance	298
15.9.1	Earth	298
15.9.2	Space	298
15.10	References	299
15.10.1	General.....	299
15.10.2	ECSS documents	301
15.10.3	Other standards.....	301
16	Inspection.....	302
16.1	Introduction.....	302
16.2	Role of inspection	302
16.2.1	General.....	302
16.2.2	Quality control and inspection	302
16.2.3	Non-destructive testing.....	303
16.3	Defects	303
16.3.1	Bonded joints.....	303
16.3.2	Adhesion.....	303
16.3.3	Cohesive properties of adhesives	304
16.3.4	Significance of defects.....	304
16.4	Inspection techniques.....	306
16.4.1	Commonly-used techniques	306
16.4.2	Developments.....	307

16.5	Ultrasonic	308
16.5.1	Applications	308
16.5.2	Limitations	308
16.5.3	C-scan	308
16.5.4	Leaky Lamb waves (LLW)	309
16.5.5	Acousto-ultrasonic	310
16.6	Radiography	310
16.6.1	Application	310
16.6.2	Limitations	310
16.6.3	X-radiography	311
16.7	Mechanical impedance: Bond testers	311
16.7.1	Application	311
16.7.2	Limitations	311
16.7.3	Principle	311
16.7.4	Fokker bond tester	312
16.7.5	Acoustic flaw detector	312
16.8	Holography	313
16.8.1	Application	313
16.8.2	Limitations	313
16.8.3	Principle	313
16.9	Thermography	313
16.9.1	Application	313
16.9.2	Limitations	313
16.9.3	Principle	314
16.10	Acoustic emission	314
16.10.1	Application	314
16.10.2	Limitations	314
16.10.3	Principle	315
16.11	References	315
16.11.1	General	315
16.11.2	ECSS documents	317
17	Materials for repairs	318
17.1	Introduction	318
17.1.1	General	318
17.1.2	Repair procedures	318
17.1.3	Repair levels	318
17.1.4	Basic features of bonded repairs	319

17.1.5	Objective of repair	319
17.1.6	Materials	319
17.1.7	Design	320
17.1.8	Quality assurance.....	320
17.2	Parent adherends.....	322
17.2.1	Materials	322
17.2.2	Sandwich structures	322
17.3	Repair patches	322
17.3.1	Materials	322
17.4	Adhesives.....	323
17.4.1	General.....	323
17.4.2	Structural	323
17.4.3	Splice.....	323
17.4.4	Fillers and mastics.....	324
17.4.5	Potting compounds.....	324
17.4.6	Properties	324
17.4.7	Repair adhesive selection factors.....	325
17.5	References	326
17.5.1	General.....	326
17.5.2	ECSS documents	327
18	Design of repairs	328
18.1	Introduction.....	328
18.1.1	Basic categories of repair	328
18.1.2	General design concepts.....	329
18.1.3	Composite repair design concepts	331
18.1.4	Sandwich panels, laminates and sheet metal	332
18.1.5	Cracked metal components.....	332
18.2	Concepts for laminates.....	332
18.2.1	General.....	332
18.2.2	Flush repairs.....	332
18.2.3	External repairs	333
18.3	Concepts for sandwich panels	333
18.3.1	Repair objectives	333
18.3.2	Field level repairs	334
18.4	Design parameters: Thin skin constructions	336
18.4.1	Design principles	336
18.5	Design parameters: Crack patching metals	338

18.5.1	Principles	338
18.6	References	339
18.6.1	General	339
18.6.2	ECSS documents	339
19	Repair techniques	340
19.1	Introduction	340
19.2	Surface preparation	340
19.2.1	General	340
19.2.2	Guidelines	341
19.2.3	Paint removal	342
19.2.4	Composite adherends	342
19.2.5	Metal adherends: Tank processes	343
19.2.6	Metal adherends: Non-tank processes	343
19.2.7	Use of chemical processes	345
19.3	Repair procedures	345
19.3.1	Basic methods	345
19.3.2	Standard procedures	346
19.3.3	Example: Sandwich panel repair	346
19.4	Equipment	349
19.4.1	Tools	349
19.4.2	Process equipment	349
19.4.3	Hot bonding equipment	349
19.4.4	Facilities	349
19.4.5	Selection of equipment	349
19.5	References	350
19.5.1	General	350
20	Test and inspection of repairs	352
20.1	Introduction	352
20.1.1	Testing	352
20.1.2	Inspection	352
20.2	Testing	352
20.2.1	Adhesive acceptance tests	352
20.2.2	Durability of bonded repairs	353
20.3	Inspection	353
20.3.1	General	353
20.3.2	In-service damage	353
20.3.3	Calibration	355

20.3.4	Standards	355
20.3.5	Guidelines on NDT sensitivity.....	355
20.4	Pre-repair inspection	356
20.4.1	Damage assessment.....	356
20.4.2	Guidelines.....	357
20.4.3	Selection of NDT technique.....	357
20.5	Post-repair inspection.....	358
20.5.1	Repair verification.....	358
20.5.2	Guidelines.....	359
20.5.3	Selection of NDT technique.....	359
20.6	References	360
20.6.1	General.....	360
20.6.2	ECSS documents	361
21	Case studies on bonded connections	362
21.1	Introduction.....	362
21.1.1	General.....	362
21.1.2	Assembly processes.....	362
21.1.3	Manufacturing processes	362
21.1.4	Case studies.....	362
21.2	Aluminium alloy end fittings for CFRP tubes	363
21.2.1	Source	363
21.2.2	Application	363
21.2.3	Objective of study	363
21.2.4	Parameters for design	365
21.2.5	Manufacture.....	368
21.2.6	Inspection	369
21.2.7	Conclusions.....	369
21.2.8	Comments on case study	369
21.3	LVA launch vehicle attachment ring and CFRP thrust cone.....	370
21.3.1	Source	370
21.3.2	Application	370
21.3.3	Objective of study	370
21.3.4	Concept	370
21.3.5	Joint design and analysis	370
21.3.6	Manufacture.....	373
21.3.7	Assembly	373
21.3.8	Inspection	373

21.3.9	Test.....	374
21.3.10	Conclusions	374
21.3.11	Comments on case study	374
21.4	Shuttle pallet satellite (SPAS) primary framework structure	374
21.4.1	Source	374
21.4.2	Application	375
21.4.3	Objective of study	375
21.4.4	Concept	375
21.4.5	Materials	375
21.4.6	General requirements and overall design description	376
21.4.7	Joint design analysis	376
21.4.8	Manufacturing.....	379
21.4.9	Bonding process.....	379
21.4.10	Test.....	379
21.4.11	Inspection	380
21.4.12	Conclusions	380
21.4.13	Comments	380
21.5	MD 11 outboard flap vane	380
21.5.1	Source	380
21.5.2	Application	381
21.5.3	Objective of the study	381
21.5.4	Parameters for design	381
21.5.5	Concept	381
21.5.6	Materials	382
21.5.7	Joint design	383
21.5.8	Manufacturing.....	385
21.5.9	Test.....	385
21.5.10	Inspection	386
21.5.11	Conclusions	386
21.5.12	Comments on case study	386
21.6	CFRP-titanium tubular bonded joint	386
21.6.1	Source	386
21.6.2	Application	387
21.6.3	Objective of study	387
21.6.4	Parameters for design	387
21.6.5	Concept	387
21.6.6	Materials	388

21.6.7	Joint design	389
21.6.8	Analysis	389
21.6.9	Manufacture.....	392
21.6.10	Test.....	393
21.6.11	Inspection	395
21.6.12	Conclusions	395
21.6.13	Comments on case study	395
21.7	Ariane 5 ACY 5400 upper payload extension ring.....	396
21.7.1	Source	396
21.7.2	Application	396
21.7.3	Objective.....	396
21.7.4	Concept	397
21.7.5	Joint design and analysis	398
21.7.6	Manufacture.....	401
21.7.7	Assembly	403
21.7.8	Inspection	403
21.7.9	Test.....	404
21.7.10	Conclusions	406
21.7.11	Comments on case study	408
21.8	SRM - solid rocket motors: Flexible joints	408
21.8.1	Source	408
21.8.2	Application	408
21.8.3	Objective of study	409
21.8.4	Parameters for design	409
21.8.5	Concept	411
21.8.6	Materials	411
21.8.7	Joint design	412
21.8.8	Analysis	412
21.8.9	Manufacture.....	413
21.8.10	Test.....	414
21.8.11	Inspection	415
21.8.12	Comments on case study	415
21.9	References	416
21.9.1	General.....	416
22	Case studies on bonded structural materials	417
22.1	Introduction.....	417
22.1.1	General.....	417

22.1.2	Sandwich structures	417
22.1.3	Metal laminates	418
22.2	CFRP central cylinder for satellites	418
22.2.1	Source	418
22.2.2	Application	418
22.2.3	Objective of study	418
22.2.4	Parameters for design	418
22.2.5	Concept	419
22.2.6	Materials	422
22.2.7	Joint design	423
22.2.8	Manufacture.....	426
22.2.9	Test.....	427
22.2.10	Inspection	428
22.2.11	Analysis	428
22.2.12	Conclusions	429
22.2.13	Comments on case study	429
22.3	Filament wound thrust cylinder.....	430
22.3.1	Source	430
22.3.2	Application	430
22.3.3	Objective of study	430
22.3.4	Parameters for design	430
22.3.5	Concept	430
22.3.6	Materials	431
22.3.7	Design	432
22.3.8	Joint design	432
22.3.9	Analysis	433
22.3.10	Manufacture.....	433
22.3.11	Test.....	435
22.3.12	Inspection	435
22.3.13	Conclusions	435
22.3.14	Comments on case study	435
22.4	Ariane 4 payload adapter 937B.....	436
22.4.1	Source	436
22.4.2	Application	436
22.4.3	Objective of study	436
22.4.4	Parameters for design	436
22.4.5	Concept	437

22.4.6	Materials	437
22.4.7	Design	438
22.4.8	Joint design	438
22.4.9	Analysis	439
22.4.10	Manufacturing.....	441
22.4.11	Test.....	442
22.4.12	Inspection	442
22.4.13	Conclusions	442
22.4.14	Comments on case study	443
22.5	Galileo radiation shielding	443
22.5.1	Source	443
22.5.2	Application	443
22.5.3	Objective of the study.....	443
22.5.4	Parameters for design	443
22.5.5	Concept	444
22.5.6	Materials	444
22.5.7	Design	446
22.5.8	Analysis	447
22.5.9	Manufacturing.....	447
22.5.10	Test.....	448
22.5.11	Inspection	448
22.5.12	Conclusions	448
22.5.13	Comments on case study	448
22.6	References	449
22.6.1	General.....	449

Figures

Figure 6.3-1 - Epoxy-based Araldite AV 138M adhesive system: Environmental resistance (DCB tests).....	83
Figure 6.3-2 - Epoxy-based Araldite AV 138M adhesive system: Environmental resistance (lap shear tests).....	84
Figure 6.6-1 - Silicone-based adhesives: Temperature performance	92
Figure 7.2-1 - Adhesive selection factors	101
Figure 7.3-1 – Environment: Elevated temperature response of adhesive lap joints	103
Figure 8.4-1 - Tensile shear: Single lap joint.....	121
Figure 8.4-2 – Composite adherends: Orientation of surface fibre	124
Figure 9.2-1 – Joint strength: Relationship between peel and shear stresses and their effect on bond strength with increasing adherend thickness	129

Figure 9.2-2 - Joint strength: Use of different bonded joint types.....	130
Figure 9.3-1 - Fatigue resistance study: Bonded joint configurations	134
Figure 9.4-1 - Random vibration resistance study: Bonded joint configurations	137
Figure 10.2-1 - Adhesive in non-linear shear: Stress-strain response	141
Figure 10.2-2 - Adhesive in non-linear shear: Models and characteristics.....	142
Figure 10.2-3 – Bonded joints: Non-uniform stress and strain distribution.....	143
Figure 10.2-4 – PABST programme: Design overlaps used in skin splices	144
Figure 10.3-1 – Bonded joints: Effect of moisture on stress distributions	146
Figure 10.3-2 – Bonded joints: Influence of moisture absorption and desorption on peak adhesive shear strains.....	147
Figure 10.3-3 – Bonded joints: Effect of progressive moisture absorption on bond strain ...	148
Figure 10.4-1 - Bonded joints: Examples of acceptable bond flaw sizes	150
Figure 10.4-2 - Bonded joints: Typical quality zoning.....	151
Figure 10.4-3 – Double overlap bonded joint: Adhesive shear stresses (defect-free)	152
Figure 10.4-4 - Double overlap bonded joint: Adhesive stresses with edge disbond.....	153
Figure 10.4-5 - Double overlap bonded joint: Adhesive stresses with away from edge disbond	153
Figure 10.4-6 - Double overlap bonded joint: Adhesive stresses with central disbond	154
Figure 10.4-7 - Adhesive bonded joints: Effect of disbond flaws on flexibility	155
Figure 10.4-8 – Adhesive thickness: Variation of peak induced adhesive stress at ends of bonded joint overlap	156
Figure 10.5-1 - Double lap and strap joints: Reducing peel stresses	160
Figure 10.5-2 - Double lap and strap joints: Effect of overlap on maximum adhesive shear strains	161
Figure 10.5-3 - Double lap joints: Design factors	162
Figure 10.6-1 - Joint efficiency for single lap composite joints: Ductile adhesive.....	164
Figure 10.6-2 - Joint efficiency for single lap composite joints: Brittle adhesive	165
Figure 10.7-1 - Double-sided stepped lap joints: Adherend stiffness balance	167
Figure 10.7-2 - Double-sided stepped lap joints: Design optimisation	168
Figure 10.11-1 - Analysis: Notation for symmetrical single-lap shear joint.....	171
Figure 10.11-2 - Analysis: Notation for single-lap joint R-degree peeling	172
Figure 10.11-3 - θ degree peeling strength	173
Figure 10.11-4 - Analysis: Notation for double-lap shear joint	174
Figure 10.11-5 - Analysis: Notation for double lap joint (standard overlap length).....	176
Figure 10.11-6 - Shear stress distribution versus the adhesive length for single lap joint without eccentricity	176
Figure 10.11-7 - Stress concentration factor as a function of correlation factor with stiffness ratio parameter	178
Figure 10.11-8 - Shear stress distribution for large overlap lengths.....	180

Figure 10.11-9 - Stress concentration factor for large overlap lengths	181
Figure 10.11-10 – UD CFRP-HT: Shear stress distribution versus the normalised bond length	182
Figure 10.11-11 – Quasi-isotropic CFRP-HT: Shear stress distribution versus the normalised bond length	183
Figure 10.11-12 - Analysis: Notation for single taper scarf joint.....	184
Figure 10.11-13 - Analysis: Notation for symmetrical double tapered scarf joint	185
Figure 10.11-14 - Analysis: Notation for stepped lap joint (recessed and simple)	186
Figure 10.11-15 - Analysis: Notation for recessed and simple scarf joints (four or more steps)	187
Figure 10.13-1 – ESAComp: Double lap joint - example of stresses in the adhesive layer (non-linear adhesive model)	190
Figure 10.13-2 – ESAComp: Double lap joint - example of stresses in the adhesive layer (linear adhesive model).....	191
Figure 10.14-1 – Astrium example spread-sheet: Fatigue data, determined by analysis	193
Figure 10.14-2 – Astrium example spread-sheet: Joint design (new)	194
Figure 10.16-1 – Design chart: Aide memoire ‘factors to consider’	200
Figure 10.16-2 – Design chart: Example of joint category procedure	201
Figure 11.2-1 - Design curve: Static loaded single lap joint with CFRP/epoxy adherends ..	206
Figure 11.2-2 - Design curve: Static loaded single lap joint with CFRP/epoxy-to-steel adherends.....	207
Figure 11.2-3 - Design curve: Static loaded single lap joint with CFRP/epoxy-to-steel adherends.....	208
Figure 11.2-4 - Design curve: Static loaded single lap joint - joint strength versus overlap length for CFRP/epoxy and CFRP/epoxy-to-steel adherends	208
Figure 11.2-5 - Design curve: Static loaded single lap joint - joint strength versus overlap length for CFRP/epoxy adherends.....	209
Figure 11.2-6 - Design curve: Static compression loaded single lap joint (stabilised sandwich, lower bond) - joint strength versus overlap length for CFRP/epoxy adherends	209
Figure 11.2-7 - Design curve: Single lap joint - tension fatigue S-N curve at RT for CFRP/epoxy adherends	210
Figure 11.2-8 - Design curve: Single lap joint - tension fatigue S-N curve at 180 °C for CFRP/epoxy adherends	211
Figure 11.3-1 - Design curve: Static loaded double lap joint for CFRP/epoxy to titanium adherends.....	212
Figure 11.4-1 - Design curve: Static loaded double scarf joint for CFRP/epoxy to titanium adherends	213
Figure 11.4-2 - Design curve: Static loaded double scarf joint for CFRP/epoxy to titanium adherends	214
Figure 11.4-3 - Design curve: Double scarf joint tension fatigue S-N curve for CFRP/epoxy to titanium adherends.....	215

Figure 11.4-4 - Design curve: Double scarf joint tension fatigue S-N curve for CFRP/epoxy to titanium adherends.....	216
Figure 11.4-5 - Design curve: Double scarf joint tension fatigue S-N curve for CFRP/epoxy to titanium adherends.....	216
Figure 12.2-1 - Thermosetting matrix composites: An abrasion surface preparation method.....	222
Figure 12.2-2 - Thermosetting matrix composites: A simple abrasion surface preparation method.....	223
Figure 12.4-1 - Aluminium alloy surface preparation: FPL etch process.....	228
Figure 12.4-2 - Aluminium alloy surface preparation: Phosphoric acid anodise (PAA) process	229
Figure 12.4-3 - Aluminium alloy surface preparation: Chromic acid anodise (CAA) process	230
Figure 12.4-4 - Aluminium alloy surface preparation: Boric/sulphuric acid anodise (BSAA) process	232
Figure 12.4-5 - Aluminium honeycomb preparation: Solvent vapour cleaning.....	233
Figure 12.4-6 – Surface preparation: Processes applied to aluminium alloys within the aerospace sector	234
Figure 12.5-1 - Titanium alloy surface preparation: Etching.....	236
Figure 12.5-2 - Titanium alloy surface preparation: Pasa Jell 107C®.....	237
Figure 13.2-1 - Diagram of co-curing joints for composites: With and without an adhesive layer.....	243
Figure 13.2-2 - Reticulating film adhesive during cure	245
Figure 13.4-1 - Hand operated applicator for one-part paste adhesives.....	248
Figure 13.4-2 - Hand operated proportioning machine for two-part paste adhesives	249
Figure 13.4-3 - Typical application route for film and paste adhesives	250
Figure 13.8-1 - Rapid adhesive bonding (RAB) equipment.....	258
Figure 15.2-1 - ASTM D-897: Metal test specimen	277
Figure 15.3-1 - ASTM D-0229: Napkin ring shear test	278
Figure 15.3-2 - ASTM D-1002: Single lap test specimen	279
Figure 15.3-3 - ASTM D-3165: Single lap test specimen	280
Figure 15.3-4 - ASTM D-3528: Double lap test specimen.....	281
Figure 15.3-5 - Cracked lap shear (CLS) test specimen.....	282
Figure 15.4-1 - ASTM D-3433: Cleavage - flat adherend specimen	284
Figure 15.4-2 - ASTM D-3433: Cleavage – CDCB contoured double cantilever beam specimen	285
Figure 15.4-3 - ASTM D-3433: Flat adherend test result chart	286
Figure 15.4-4 - ASTM D-3433: Contoured double cantilever beam test result chart	287
Figure 15.5-1 - ASTM D-3762: Wedge test specimen	290
Figure 15.6-1 - ASTM D1781 climbing drum peel test	292

Figure 15.6-2 - ASTM D-1876 T-peel test specimen.....	293
Figure 15.6-3 - ASTM D-3167 floating roller peel test.....	294
Figure 15.7-1 - Examples of fatigue test specimens	296
Figure 16.3-1 - Maximum permissible local defect.....	305
Figure 18.3-1 - Sandwich panel repair concepts	334
Figure 18.3-2 - Field level sandwich panel repair concepts	335
Figure 18.4-1 - Design parameters: Thin skin constructions.....	337
Figure 19.2-1 - Surface preparation for repairs to aluminium alloys: PANTA process.....	343
Figure 19.2-2 - Surface preparation for repairs to aluminium alloys: PACS process equipment set-up	344
Figure 19.3-1 – Example: Sandwich panel repair procedure	347
Figure 20.3-1 - Example of NDT Instrument sensitivity: Bonded metal constructions	356
Figure 21.2-1 - Case study: CFRP tube/Al alloy - Joint design for tubular specimens and end fittings	366
Figure 21.2-2 - Case study: CFRP tube/Al alloy - Bonding procedure for end fittings	368
Figure 21.3-1 - Case study: LVA ring/CFRP thrust cone - Basic construction of thrust cone assembly	371
Figure 21.3-2 - Case study: LVA ring/CFRP thrust cone - Joint configurations for LVA ring to thrust cone connection.....	372
Figure 21.4-1 - Case study: SPAS-01 primary structure	376
Figure 21.4-2 - Case study: SPAS - details of joint dimensions.....	378
Figure 21.5-1 - Case study: MD 11 outboard flap vane - basic structure.....	382
Figure 21.5-2 - Case study: MD 11 outboard flap vane - skin lay-up and jointsc.....	383
Figure 21.5-3 - Case study: MD 11 outboard flap vane - ribs	384
Figure 21.5-4 - Case study: MD 11 outboard flap vane - splice joint analysis	384
Figure 21.6-1 - Case study: CFRP Tube/titanium fitting - bonded joint section	387
Figure 21.6-2 - Case study: CFRP tube/titanium fitting - tensile stress distribution in adhesive layer.....	390
Figure 21.6-3 - Case study: CFRP tube/titanium fitting - tensile stress distribution in composite	391
Figure 21.6-4 - Case study: CFRP tube/titanium fitting - peel stress distribution in adhesive layer and composite external ply.....	391
Figure 21.6-5 - Case study: CFRP/titanium end-fitting - analytical notation.....	392
Figure 21.6-6 - Case study: CFRP/titanium end-fitting - manufacturing procedure	393
Figure 21.6-7 - Case study: CFRP/titanium end fitting - bonded joint failure mechanism....	395
Figure 21.7-1 – Case study: Ariane 5 ACY 5400 - location.....	397
Figure 21.7-2 – Case study: Ariane 5 ACY 5400 - concept	397
Figure 21.7-3 – Case study: Ariane 5 ACY 5400 - sectional view of bonded joint.....	399
Figure 21.7-4 – Case study: Ariane 5 ACY 5400 - effect of bondline thickness.....	400
Figure 21.7-5 – Case study: Ariane 5 ACY 5400 - example of (half) FE model for joint	401

Figure 21.7-6 – Case study: Ariane 5 ACY 5400 - witness sample under test	405
Figure 21.8-1 – Case study: SRM – position of flexible joints	409
Figure 21.8-2 – Case study: SRM flexible joints – example design approach	410
Figure 21.8-3 – Case study: SRM – example of flexible joint concept	411
Figure 21.8-4 – Case study: SRM – example of flexible joint design	412
Figure 22.2-1 - Case study: CFRP central cylinder - structural elements	421
Figure 22.2-2 - Case study: CFRP Central cylinder - lower ring joint.....	423
Figure 22.2-3 - Case study: CFRP central cylinder - edge inserts	424
Figure 22.2-4 - Case study: CFRP central cylinder - tank interface inserts	425
Figure 22.2-5 - Case study: CFRP central cylinder - shear panel interface cleats.....	426
Figure 22.3-1 - Case study: Filament wound thrust cylinder - joint design: Tank interface and end ring	433
Figure 22.3-2 - Case study: Filament wound thrust cylinder - manufacturing sequence.....	434
Figure 22.4-1 - Case study: Ariane 4 payload adapter - overall view of adapter 937B	437
Figure 22.4-2 - Case study: Ariane 4 payload adapter - end ring joint.....	439
Figure 22.5-1 - Case study: Galileo radiation shielding - laminate design	447

Tables

Table 4.1-1 - Adhesively bonded aerospace structures: Examples	51
Table 5.2-1 - Polymer-based composite adherends	59
Table 5.2-2 - Metal matrix composite adherends under evaluation	61
Table 5.3-1 - Metal adherends: Currently used or undergoing evaluation	62
Table 5.4-1 - Adhesive bonding of materials: High temperature performance.....	64
Table 6.2-1 - Classification of adhesives: General characteristics and properties.....	72
Table 6.2-2 - Classification of adhesives: Typical shear and peel strength characteristics.....	74
Table 6.3-1 - Epoxy-based film adhesives: Properties.....	77
Table 6.3-2 - Epoxy-based paste and liquid adhesives: Properties	80
Table 6.3-3 - Epoxy-based adhesives: Environmental durability assessment	81
Table 6.3-4 - Epoxy-based film adhesives: Cytec FM 300-2M and FM 96-U: CTE and shear modulus, determined by TGA and DMA	85
Table 6.4-1 - Polyimide-based film adhesives: Properties	87
Table 6.5-1 - Bismaleimide-based film adhesives: Properties	89
Table 6.6-1 - Silicone-based paste and liquid adhesives: Properties.....	91
Table 6.8-1 – Adhesive systems used in space: Examples	94
Table 7.3-1 - Adhesives: Typical maximum use temperatures	105
Table 7.5-1 - Typical cure schedules for aerospace structural adhesives	111
Table 7.6-1 - Adhesive selection criteria: Based on bulk property testing	114

Table 8.2-1 - Comparison of joining methods: Fastening and bonding	118
Table 8.3-1 - Basic loading modes in adhesive bonds	120
Table 8.4-1 - Types and geometry for adhesive bonded joints	122
Table 8.4-2 – Composite adherends: Typical transverse (90°) tensile strengths for some aerospace carbon-reinforced UD products	125
Table 9.3-1 - Fatigue resistance study: Factors relating to resistance of adhesively bonded joints	135
Table 10.4-1 - Bonded joints: Description of NDT methods	158
Table 10.4-2 - Bonded joints: Detection methods for various defects	159
Table 10.15-1 - ESDU data items for bonded joints	195
Table 11.1-1 – Design curves: Summary of bonded joint configurations	205
Table 12.3-1 - Surface Preparation: Proposed methods for thermoplastic composites	225
Table 12.4-1 - Al-Li alloys and SiC particle MMC: Evaluation of surface preparation methods	227
Table 12.4-2 – Surface preparation: Development processes	235
Table 13.1-1 - Comparison between co-curing and secondary bonding as an assembly technique for composite structures	241
Table 13.2-1 - Co-curing methods for composites: With and without an adhesive layer	244
Table 13.5-1 - Manufacturing factors for adhesives	252
Table 13.7-1 - Thermoplastic matrix composites: Welding techniques	254
Table 13.8-1 - Rapid adhesive bonding (RAB): Adherends	256
Table 13.8-2 - Rapid adhesive bonding (RAB): Adhesives	256
Table 14.4-1– Procurement check-list: Paste adhesives – summary	266
Table 14.4-2 – Procurement check-list: Film adhesives – summary	267
Table 14.4-3 – Check list: Adhesive bonding	269
Table 15.1-1 - Adhesive screening: Example of US federal specifications	273
Table 15.1-2 – Test methods and standards: Summary	275
Table 15.9-1- Environmental durability in space: Standard test methods	299
Table 16.4-1 - NDT Techniques: Summary of defect detection capability	307
Table 17.1-1 - Bonded repairs: Examples of applications and materials	321
Table 17.4-1 - Repair adhesives types: Grouped by cure and service temperatures	325
Table 18.1-1 - Basic design concepts for repairs	330
Table 18.3-1 - Field level sandwich panel repairs: Comparison of design concepts	336
Table 18.5-1 - Design parameters: Crack patching metal components	338
Table 19.2-1 - Bonded repairs: Surface preparation	341
Table 19.3-1 - Basic methods for bonded repairs	346
Table 19.4-1 - Use of equipment for bonded repairs	350
Table 20.4-1 - Pre-repair defect inspection methods	358
Table 20.5-1 - Post-repair defect inspection methods	360

Table 21.2-1 - Case study: CFRP tube/Al alloy - Material selection concept design study	364
Table 21.2-2 - Case study: CFRP tube/Al alloy - Material selection detail design study	367
Table 21.4-1 - Case study: SPAS - Material selection/design study for SPAS-01 framework	375
Table 21.5-1 - Case study: MD 11 outboard flap vane - materials	382
Table 21.6-1 - Case study: CFRP tube/titanium fitting - material properties	388
Table 21.6-2 - Case study: CFRP/titanium end-fitting - stiffness analysis results	392
Table 21.7-1 – Case study: Ariane 5 ACY 5400 - potential adhesives	402
Table 21.7-2 – Case study: Ariane 5 - typical static load case.....	405
Table 21.7-3 - Case study: Ariane 5 ACY 5400 - comparison between bonded and riveted assembly	407
Table 22.2-1 - Case study: CFRP central cylinder - trade-off between design concepts	420
Table 22.2-2 - Case study: CFRP central cylinder - structural analysis stiffness results	428
Table 22.2-3 - Case study: CFRP central cylinder - mass analysis	429
Table 22.3-1 - Case study: Filament wound thrust cylinder - design parameters	430
Table 22.3-2 - Case study: Filament wound thrust cylinder - materials	431
Table 22.4-1 - Case study: Ariane 4 payload adapter - materials	438
Table 22.4-2 - Case study: Ariane 4 payload adapter - margin of safety for failure mode analysis	440
Table 22.4-3 - Case study: Ariane 4 payload adapter - manufacturing development summary	441
Table 22.5-1 - Case study: Galileo radiation shielding - estimated radiation levels	443
Table 22.5-2 - Case study: Galileo radiation shielding - design criteria	444
Table 22.5-3 - Case study: Galileo radiation shielding - concepts	444
Table 22.5-4 - Case study: Galileo radiation shielding - materials	445
Table 22.5-5 - Case study: Galileo radiation shielding - properties for Al-Ta-Al bonded joints	446

1 Scope

This handbook is an acceptable way of meeting the requirements of adhesive materials in bonded joints of ECSS-E-ST-32.

2 References

Due to the structure of the document, each clause includes at its end the references called in it.

Terms, definitions and abbreviated terms

3.1 Terms from other documents

For the purpose of this document, the terms and definitions from ECSS-S-ST-00-01 apply.

3.2 Terms specific to the present document'

The terms specifically used in this document are highlighted as **bold** in the text.

A

A-stage

An early stage in the polymerisation reaction of certain thermo-setting resins (especially phenolic) in which the material, after application to the reinforcement, is still soluble in some liquids and is fusible; sometimes called resole. [See also: B STAGE, C STAGE]

'A' value

An 'A' value is one above which at least 99% of the population of values is expected to fall with a confidence of 95%.

Accelerated ageing test

Short-term test designed to simulate the effects of longer-term service conditions.

Accelerator

A material mixed with a catalysed resin to increase the rate of chemical reaction between the catalyst and resin, used in polymerising resins, also known as promoter or curing agent

Acoustic emission (AE)

An inspection technique where the sound generated by damage formation and propagation (under test stressing or in-service) is monitored using sensitive, high-frequency microphones.

Triangulation techniques can be used to locate the damage events within a three dimensional structure. Frequently used to measure the integrity of composite laminates

Activators

Chemicals which can be applied directly to a surface or substrate, or mixed with an adhesive to speed up the reaction

Adherend

A component held to another component by an adhesive

Adherend failure

Failure of a joint in the body of the adherend

Adhesion

The state in which two surfaces are held together by interfacial forces which may consist of both valence forces and interlocking action

Adhesive

A substance with the capability of holding two surfaces together by either chemical or mechanical interfacial forces or a combination of both

Adhesive failure

Failure of an adhesive bond, such that separation occurs at the adhesive/adherend interface

Adhesive strength

The strength with which two surfaces are held together by an adhesive, also known as the bond strength. Quantitative tests are available for measuring the adhesive strength under various environmental and loading conditions

Adsorption

The action of a body in condensing and holding gases and other materials at its surface

AE

See: Acoustic emission

AECMA

Association Européen des Constructeurs Matériel Aérospatiale; European Association of Aerospace Industries

Ageing

A progressive change in the chemical and physical properties of a material

Allowables

Material values that are determined from test data at the laminate or lamina level on a probability basis (e.g. 'A' or 'B' values), following ASTM or other test standards accepted by the final customer. [See also: A-basis design allowable; B-basis design allowable; 'A' value, 'B' value]

Ambient

- 1 The surrounding environmental conditions, e.g. pressure, temperature or relative humidity
- 2 usual work place temperature and humidity environmental conditions, e.g. room temperature

Amorphous

Non-crystalline. Most plastics are amorphous at processing and service temperatures

Anaerobic adhesive

An adhesive which only cures when oxygen (air) is excluded

Anisotropic

Having mechanical or physical properties which vary in direction relative to natural reference axes in the material

Araldite™

A range of epoxy-based structural adhesives; developed by Ciba Geigy, now [Vantico](#)

ARALL™

Aramid fibre-reinforced aluminium laminate. [See: Fibre metal laminate]

Aramid

A type of highly oriented aromatic polymer material. Used primarily as a high-strength reinforcing fibre, of which Kevlar™ 49 and Twaron™ HM are most commonly used in aerospace applications

Autoclave

A closed vessel for conducting a chemical reaction or other operation under pressure and heat

B**B-stage**

(1) An intermediate stage in the reaction of certain thermosetting resins in which the material swells when in contact with certain liquids and softens when heated, but cannot dissolve or fuse entirely; sometimes referred to as 'resistol'. The resin in an uncured prepreg or premix is usually in this stage. [See also: A-stage, C-stage]

(2) An intermediate stage in the reaction of certain thermosetting polymers wherein the material can still be softened when heated or swelled in contact with certain liquids but cannot be completely fused or dissolved; B-staged resins generally permit some degree of formability or shaping into certain specific configurations

'B' value

A 'B' value is that above which at least 90% of the population of values is expected to fall with a confidence of 95%. [See also: Allowables]

Backing sheet

A thin polymer sheet used to protect prepreg and film adhesive surfaces from contamination and damage prior to use. These are completely removed during lay-up and are usually coloured to aid this.

Balanced laminate

Lay-up where the ply sequence is symmetrical about the mid-plane

Base monomer

Organic compounds used as the basis for resin formulations

Bismaleimide (BMI)

A type of polyimide that cures by an addition rather than a condensation reaction, thus avoiding problems with volatiles, and which is produced by a vinyl-type polymerisation of a polymer terminated with two maleimide groups. It has intermediate temperature capability between epoxy and polyimide (about 200 °C)

BMI

Bismaleimide

Bonded joint

The general area of contact for a bonded structure. This includes composite to composite and composite to metal adherends and all forms of adhesives including co- and post-cured joints.

Bond strength

The degree of adhesion between bonded surfaces; a measure of the stress required to separate a layer of material from the base to which it is bonded.

Bonding

The joining of adherends using an adhesive

Bond line

The area between two materials that have been adhesively bonded; includes the layer of adhesive between the adherends

Bondline thickness

The thickness of the adhesive layer between adherends

Butt joint

Joint in which the plane of the bond is at right angles to a major axis of the adherends

C**C-stage**

(1) The final stage in the reaction of certain thermosetting resins in which the material is relatively insoluble and infusible; sometimes referred to as resite. The resin in a fully cured thermoset moulding is in this stage.

(2) The final stage in the cure reaction of certain thermosetting polymers wherein the material becomes largely insoluble and infusible. Attainment of the C-stage completes the cure of these products and generally provides their optimum strength and performance characteristics

Calorie

The quantity of heat required to raise 1 gram of water by 1 °C

Carbon fibre

Fibre produced by the pyrolysis of organic precursor fibres, such as rayon, polyacrylonitrile (PAN) and pitch, in an inert environment. The term is often used interchangeably with the term graphite; carbon fibres and graphite fibres do, however, differ. The basic differences lie in the temperature at which the fibres are made and heat-treated, and in the amount of elemental carbon produced.

Carbon fibres typically are carbonised in the region of 1315 °C and assay at 93 to 95% carbon, while graphite fibres are graphitised at 1900 °C to 2480 °C and assay at more than 99% elemental carbon

CARE

Carbon fibre-reinforced aluminium laminate. [See: Fibre metal laminate]

CAS number

Chemical Abstracts Service. An assigned registry number to identify a material

Catalyst

A substance that changes the rate of a chemical reaction without itself undergoing permanent change in its composition; a substance that markedly speeds up the cure of a compound when added in a quantity small compared with the amounts of primary reactants

CDCB

Contoured double-cantilever beam

Centipoise (CPS)

A measure of viscosity

CFRP

Carbon fibre-reinforced plastic. G in this handbook (i.e. GFRP) stands for Glass, whereas in American publications it is used for graphite.

Clamping force

The total force exerted by a clamping device on a glue line

Cleavage (of a joint)

The separation of adherends by tensile stresses concentrated at one edge of the bond, such as that caused by a wedge being driven between them

Closed cell foam

Where the porosity cells are not connected to other adjacent cells

CMC

Ceramic matrix composite

Co-cure

Simultaneous curing and bonding of a composite laminate to another material or parts, such as honeycomb core or stiffeners, either by using the adhesive properties of the composite resin or by incorporating an adhesive into the composite lay-up

Coefficient of moisture expansion (CME)

The change in length per unit length produced by the absorption of water (usually by resin matrices or adhesives)

Coefficient of thermal expansion (CTE)

The change in length per unit length produced by a unit rise or decrease in temperature. May differ for different temperature ranges and be highly anisotropic in composite materials

Cohesion

The molecular attraction which holds the body of an adhesive together. The internal strength of an adhesive

Cohesive failure

Failure within the body of the adhesive (i.e. not at the interface)

Compressive strength

A measure of the material's resistance to compressive loading

Condensation reaction

The combination of two or more molecules resulting in the production of water (or other small, volatile) molecules

Contact adhesive

One which is applied to both substrates, that dries to the touch but will instantly bond when the two surfaces are brought into contact

Core

Sandwich panel: a lightweight material in between the face skins, e.g. honeycomb core, foam. Metallic or composite sheet materials are bonded to the core to form a sandwich panel

Core splice

A joint or the process of joining one type of core to another; usually achieved by adhesive bonding using an adhesive with gap-filling properties

Creep

The time-dependent increase in strain resulting from a sustained load

Crevice corrosion

A form of galvanic corrosion occurring within a single phase where a gradient environment exists. [See also: Galvanic corrosion]

Crosslinking

The formation of chemical bonds between adjacent molecular chains resulting in a three dimensional polymer network

Cryogenic

Very low temperature conditions, usually referring to temperatures below 100°K

Crystallinity

A state of molecular structure in some polymers denoting uniformity, compactness and possible alignment of molecular chains

Cure temperature

The temperature to which an adhesively bonded assembly is exposed in order to produce curing of the adhesive

Cure time

The time required to attain full curing of an adhesive

Cure

Changing the physical properties of a material by chemical reaction through condensation or addition polymerization or by crosslinking (e.g. vulcanization). Usually accomplished by the action of heat and catalysts, alone or in combination, with or without pressure. Also referred to as hardening or setting

Cyanate ester

A family of polymer resins, which can contain bisphenol, phenol or novalac within their formulations, that provide a low moisture absorption capability

Cyanoacrylate adhesive

A group of acrylic adhesives which cure rapidly through a reaction with trace moisture in the atmosphere or on the surface to be bonded

D**DCB**

Double cantilever beam; a test method used for fracture toughness Mode I (G_{Ic})

Debond

Area of separation within or between plies in a laminate, or within a bonded joint, caused by contamination, improper adhesion during processing, or damaging interlaminar stresses [See also: Delamination]:

- (1) Adhesive bond: a delamination between the adherends
- (2) Sandwich panel: a delamination that occurs between the core and the face skin; caused by contamination or damage to either the film adhesive used to join the face skin laminate to the core, face laminate itself, bond area of the core or mechanical damage to core cell walls, by crushing or more local damage

Delamination

The separation of the layers within a laminate

Design allowable

Material values that are determined from test data at the laminate or lamina level on a probability basis (e.g. 'A' or 'B' values), following ASTM or other test standards accepted by the final customer. [See also: A-basis design allowable; B-basis design allowable; 'A' value, 'B' value]

DMA

Dynamic mechanical analysis

Double lap joint

Joint made by placing one or two adherends partly over one or two other adherends and bonding together the overlapped portions

DSC - Differential scanning calorimetry

Measurement of the energy absorbed (endothermic) or produced (exothermic) as a resin system is cured. Also permits detection of loss of solvents and other volatiles. DSC provides a means of assessing the cure characteristics of the supplied prepreg batch. Like HPLC, it is an analytical technique providing data on which to base comparisons. It can provide reaction start temperature, heats of polymerisation, temperature at peak maximum heat of polymerisation and glass transition temperature (T_g) of cure prepreg

Durability

The endurance of the adhesive joint performance relative to the required service conditions

Durometer hardness

A measure of the hardness of a material as measured by a durometer. The resultant numerical rating of hardness gives lower numbers for softer materials and higher numbers for harder ones

E**Edge closure**

Sandwich panels: Protects the core from accidental damage, serves as a moisture seal and provides edge reinforcement to enable transfer and distribution of edge attachment loads; also known as 'edge close-out' and 'edge member'

Elasticity

The ability of a material to return to its original shape after removal of a load

Elastomer

A rubbery material which returns to approximately its original dimensions in a short time after a relatively large amount of deformation

Elongation

The fractional change in length of a stressed material

Encapsulate

The process to surround and enclose an object in adhesive. Often used in the electronic industry to protect sensitive components [See also: Potting]

Environment

External, non-accidental conditions (excluding mechanical loading), separately or in combination, that can be expected in service life and that can affect the structure, e.g. temperature, moisture, UV radiation and fuel

Epoxy

A versatile group of thermosetting polymers for adhesive, sealant, coating, potting, encapsulation, impregnation and coating uses. Can be one or two component, room- or elevated-temperature curing. Feature high physical strengths, superior resistance to chemical and/or environmental damage and excellent dimensional stability. Widely employed in structural applications and as electrical insulation materials. Special formulations are available which feature high electrical and/or thermal conductivity. Very wide service temperature ranges are available

ESA

European space agency

ESACOMP

A software package for the analysis and design of composite laminates and laminated structural elements; developed for ESA/ESTEC by Helsinki University and distributed by [Componeeering Inc](#)

Exotherm

Exothermic reactions produce heat during cure. When large quantities cure at one time, the heat given off (the exotherm) can be enough to melt plastic containers or produce ignition

Extenders

Ingredients, possibly having some adhesive properties, added to an adhesive composition in order to reduce the amount of the primary adhesive component required per unit of bond area

F**Face sheet**

A composite laminate or metal sheet that forms the external surfaces of a sandwich panel

Fatigue failure

Failure of a material due to rapid cyclic stressing

Fatigue life

Number of cycles necessary to bring an adhesive bond to the point of failure when the bond is subjected to repeated cyclic stressing under specified conditions

Fatigue strength

Highest cyclic stress level that will not produce fatigue failure

Fibre metal laminate (FML)

Sheet or laminated material consisting of thin sheets of metal adhesively bonded with layers of fibre-reinforced polymer plies; often with various fibre directions. [See also: ARALL, GLARE and CARE]

Filament winding

Automated process of placing filaments or fibres onto a mandrel in prescribed patterns. The resin impregnation can be before or during the winding, known as prepreg or wet winding, respectively. The mandrel can subsequently be removed after curing of the composite material. Filament winding is most advantageous in building pressure vessels, pipes, drive shafts, or any device that is axisymmetrical

Fillers

Non-adhesive substances added to an adhesive composition to improve ease of application and/or specific properties such as strength, durability, hardness, dimensional stability

Fillet

Adhesive outside the bondline which fills the angle formed where two adherends meet

Film adhesive

A synthetic resin adhesive, usually of the thermosetting type in the form of a thin film of resin with or without a fibrous carrier or support. Note: Film adhesives usually have some tack to enable their placement during assembly

FE

Finite element

FEA

Finite element analysis

Flash point

The lowest temperature at which the vapours given off by a substance can be ignited

Flow

Movement of an adhesive compound during the application and bonding processes, prior to the onset of cure

Foamed adhesive

An adhesive, the apparent density of which has been decreased substantially by the presence of numerous dispersed gaseous pores. Also known as a cellular adhesive

FPF

First ply failure

FRP

Fibre reinforced plastics

G**Galvanic corrosion**

Corrosion that occurs in aqueous or humid conditions that is driven by electrochemical potential differences between two phases, usually metallic, in electrical contact. It can also occur for a single phase where a gradient environment exists; called crevice corrosion. [See: Crevice corrosion]

Gap filling

Ability of an adhesive to effectively fill a wide or variable bondline

Gel time

The time (in minutes) required for a specific quantity of mixed resin and hardener to become unworkable (gelled)

Gel

A semi-solid system consisting of a network of solid aggregates in which liquid is held

GFRP

Glass-fibre reinforced plastic

Note: In this handbook G = glass, but in US publications G = graphite. [See also: CFRP]

GLARE

Glass fibre-reinforced aluminium laminate. [See: Fibre metal laminate]

Glass transition

A reversible change in an amorphous polymer or in amorphous regions of a partially crystalline polymer from (or to) a viscous or rubbery condition to (or from) a hard and relatively brittle one. Glass transition temperature: T_g

H

Hardener

A substance or mixture of substances added to an adhesive composition to promote the curing reaction; hardeners become part of the cured adhesive compound [See also: Catalyst]

Honeycomb

Manufactured product of resin-impregnated sheet material (paper, glass or aramid-based fabric) or sheet metal formed into hexagonal-shaped cells; used as a core material in sandwich construction

Hot Press

A press designed for laminating in which the lay-up is placed between heated platens

Hot Strength

Strength measured at elevated temperature

Hygroscopic

Tending to absorb moisture from the air

Hygrotherma

The combination of moisture and temperature

I

Impact resistance

A measure of the ability of a material to withstand very rapid loading

Impact strength

The ability of a material to withstand a shock load

Inhibitor

A substance which is added to slow down the rate of a chemical reaction. Can be useful in prolonging the storage or working life of certain types of adhesive

Insert

A fixation device or type of fastener system, commonly used in sandwich panels

IR

Infra red

IR pyrometer

A device designed to measure surface temperature using Infrared emissions

J

Joint

(1) General: Any element that connects other structural elements and transfers loads from one to the other across a connection, Ref. [[3-1]].

(2) Bonded: The location at which two adherends are held together with a layer of adhesive; the general area of contact for a bonded structure. Common bonded types are:

- Butt Joint: The edge faces of the two adherends are at right angles to the other faces of the adherends.
- Scarf Joint: A joint made by cutting away similar angular segments of two adherends and bonding them with the cut areas fitted together.
- Lap Joint: A joint made by placing one adherend partly over another and bonding together the overlapped portions

Joint area

The region where two or more adherends are held together with layers of adhesive

K

Kpsi

Thousands of pounds per square inch

L

Laminate

Plate consisting of layers of uni- or multidirectional plies of one or more composite materials

Lap joint

Joining or fusing of two overlapping surfaces

Lap shear

Shear stress acting on an overlapping joint

M

Mechanical adhesion

Adhesion between surfaces in which the adhesive holds the parts together by interlocking action

MMC

Metal matrix composite

Modifier

Any chemically inert ingredient added to an adhesive formulation that changes its properties

Modulus of elasticity

The ratio of stress to related strain as determined in tension (Young's Modulus), compression, shear or flexure

Molecular weight

The sum of the atomic weights of all atoms in a molecule

MSDS

Material Safety Data Sheet

N

Non volatile content

The portion of material remaining once the volatile material has been driven off, e.g. solvent content of some adhesives

O

Offgassing

(1) General: Depending on the application, there are restrictions on the gaseous products released from materials or finished articles in operational vacuum conditions that can:

- contaminate other equipment, [See also: OUTGASSING]
- contaminate the air during preparatory or operational conditions for manned spacecraft.

(2) The evolution of gaseous products for an assembled article subjected to slight radiant heat in the specified test atmosphere, [Ref. [3-2]]. Note: It applies to materials and assembled articles to be used in a manned space vehicle crew compartment

Open time (Open assembly time)

Period during which the adhesive remains active without curing after being applied to the substrate

Outgassing

(1) General: Depending on the application, there are restrictions on the gaseous products released from materials or finished articles in operational vacuum conditions that can:

- contaminate other equipment (outgassing)
- contaminate the air during preparatory or operational conditions for manned spacecraft, [See: OFFGASSING]

(2) Release of gaseous species from a specimen under high vacuum conditions, Ref. [[3-3]]

P

Paste

An adhesive composition having a thickened consistency to avoid slumping

PEEK

Polyether ether ketone

Peel

Mode of application of force to a joint where one or both of the adherends is flexible and in which the stress is concentrated at a joint boundary

Peel ply

A layer of resin free material used to protect a laminate and be subsequently removed for secondary bonding

Peel strength

(1) An adhesive's resistance to be stripped from a bonded joint, usually with the stripping force applied at a predetermined angle and rate.

(2) The average load per unit width of a joint tested under peel loading

Peel test

A test of an adhesive using one rigid and one flexible substrate. The flexible material is usually folded back (usually 180°) and the substrates are peeled apart. Strength is usually stated in units of N/cm.

PEI

Polyether imide

Phenolic resin

Thermosetting resin for elevated temperature use produced by the condensation of an aromatic alcohol with an -aldehyde, particularly of phenol with formaldehyde

PI

Polyimide

Plasticity

A property whereby material can be deformed continuously and permanently, without rupture, upon the application of a stress that exceeds the yield stress

Plasticizer

Ingredients incorporated into an adhesive composition that enhance flow, deformation and flexibility; the addition of plasticizers also tends to reduce tensile strength properties and elastic moduli while increasing toughness and impact strength

Polyamide

A polymer in which the structural units are linked by amide or thio-amide grouping; many polyamides are fibre-forming

Polyester

Thermosetting resins produced by dissolving unsaturated, generally linear alkyd resins in a vinyl active monomer, e.g. styrene, methyl styrene, or diallyl phthalate

Polyimide

A polymer produced by reacting an aromatic dianhydride with an aromatic diamine; used for the matrix phase of composites; highly heat-resistant resin above 315°C typically

Polymer

A complex, high molecular weight, compound made up by the reactive linking of simple molecules. The growing polymer chains have functional groups that can be linked by addition or condensation reactions

Polymerization

Chemical reaction in which one or more small molecules combine to form larger molecules

Porosity

A condition of trapped pockets of air, gas or vacuum within a solid material.

Post cure

A treatment usually involving the application of heat to an adhesive assembly following initial cure. Its purpose is to modify certain properties, such as heat resistance, chemical inertness

Pot life

The length of time a liquid or paste adhesive remains usable after it has been mixed with a catalyst and hardener

Potting

The process of filling a cavity or space with an adhesive compound. Often used for the fixing of insert into sandwich panels and for the protection of electronic assemblies

Pre treatment

Mechanical and/or chemical processes to make an adherend more suitable for bonding

Press time

The period required for a joint to be held under pressure during cure

Primer

A coating applied to an adherend surface prior to the application of the adhesive in order to enhance the adhesion and therefore the strength of the bond

Proportional limit

The maximum stress a material can withstand without significantly deviating from a linear stress to strain relationship

Psi

Pounds per square inch

Pyrometer

A non-contact device to measure surface temperature

Q**R****REL**

Recommended exposure limit

Release sheet

A sheet, serving as protection for an adhesive film, that is easily removed from the film or prior to use

Resin

A class of solid or semi-solid organic products of natural and synthetic origin, generally of high molecular weights with no definite melting point. Resins are generally water-insoluble and have little or no tendency to crystallize. However, certain resins, such as some polyvinyl alcohols and polyacrylates, are readily dispersible in water. Others, such as polyamides and polyvinylidene chloride, are readily crystallized.

RH

Relative humidity

Rheology

The study of the flow properties of materials, especially of non-newtonian liquids and plastics. Non-newtonian materials are substances where the flow is not proportional to the stress applied

RT

Room temperature

RTV

Room temperature vulcanizing

S**Sandwich**

(1) Construction: An assembly composed of a lightweight core material, such as honeycomb, foamed plastic, and so forth, to which two relatively thin, dense, high-strength or high-stiffness faces or skins are adhered.

(2) Panel: A sandwich construction of a specified dimensions.

Note: The honeycomb and face skins can be made of composite material or metal alloy.

Scarf joint

A joint made by cutting away similar angular segments, usually at an angle of less than 45°, of two substrates and bonding the substrates with the cut areas fitted together

Sealant

A material which adheres to two adjoining parts of an assembly and prevents the passage of gases, dust, liquids, etc. into or out of the assembly at that point

Shear modulus

The ratio of shear stress to shear strain (below the proportional limit)

Shear strength

In an adhesively bonded joint, this is the maximum average stress parallel to the joint before failure

Shear

The effect of forces acting in opposite but parallel directions

Shelf life

The length of time that a limited-life material (e.g. an adhesive) in its packaging, can be stored before use, under the conditions specified by the manufacturer, without degradation

Silicone

A family of polymeric products whose molecular backbone is made up of alternating silicon and oxygen atoms and which has pendant hydrocarbon groups attached to the silicon atoms. Used primarily as elastomeric adhesives and sealants, silicone is known for its ability to withstand large variations in temperature. Both one- and two-part silicone systems are available.

Solids content

The percentage by weight of non-volatile material in an adhesive or sealant

Specific gravity

The ratio between the density of a material and that of water

Specific heat

The ratio between the quantity of heat needed to raise the temperature of a material to that of water

Starved joint

A joint with insufficient adhesive to produce a satisfactory bond

Strain

The unit change in shape or size due to stress

Stress-cycles (SN) curve

Diagram showing the relationship between cyclic stress level and number of cycles to failure

Stress-strain diagram

A plot of corresponding values of stress and strain for a material

Structural adhesive

One capable of transferring sustained loads between bonded components

Substrate failure

Failure of a joint through the substrate material. The cohesive strength of the adhesive and the adhesive forces between the adhesive and substrate exceed the internal strength of the material being bonded

Substrate

Material to be adhesively bonded

Surface preparation

Physical and/or chemical pretreatment of a substrate to enhance the adhesive bond strength

T**Tack**

The property of an adhesive that enables it to form a bond of measurable strength immediately after adhesive and adherend are brought into contact under low pressure

Tear strength

The load required to propagate a tear in, for example, a sealant test specimen

Tensile strength (of an adhesive joint)

The maximum tensile stress that a material is capable of sustaining calculated from the maximum load applied perpendicular to the joint divided by the cross sectional area of the joint

T_g

See: Glass transition temperature

TGA

Thermo-gravimetric analysis

Thermoplastic

Polymeric materials which will repeatedly soften and flow as the temperature is increased and harden as the temperature falls

Thermoset

Polymeric materials which only cure when exposed to heat are described as thermoset resins. Subsequent heat exposure has little or no effect on the properties of the cured resin

Thixotropy

The viscosity of some materials reduces under isothermal agitation and subsequently increases again at rest

TLV

Threshold limit value

U**Ultimate elongation**

Elongation at failure

Undercuring

An incorrect process in which there is insufficient time or temperature to enable full and proper curing of an adhesive or resin

UV

Ultra violet

V**Vapour pressure**

The pressure exerted by a saturated vapour above its own liquid in a closed container

Viscosity

Measure of fluid thickness or resistance to flow

Voids

Gas or air pockets trapped within a material

Volatile organic compound (VOC)

Any compound of carbon, excluding carbon monoxide, carbon dioxide, carbonic acid, metallic carbides or carbonates, ammonium carbonate, and excluding any 'exempt compound' that participates in atmospheric photochemical reactions. The VOC is a measured or calculated number which reflects the amount of volatile organic material that is released from a product as it dries.

W**Working life**

The period of time during which an film adhesive remains suitable for use. [See also: Pot life for liquid and paste adhesives].

3.3 References

- [3-1] ECSS-E-ST-32-01 – Space engineering – Fracture control
- [3-2] ECSS-Q-ST-70-29 – Space product assurance – Determination of offgassing products from materials and assembled articles to be used in a manned space vehicle crew compartment
- [3-3] ECSS-Q-ST-70-02 – Space product assurance – Thermal vacuum outgassing test for the screening of space materials

4 Joining

4.1 Joining methods for space structures

4.1.1 General

Joining methods used for aerospace structural materials are:

- welding (alloys or thermoplastics),
- mechanical fastening,
- adhesive bonding, or
- a combination of both bonding and mechanical fastening.

The method selected depends on numerous factors including whether or not the structure is designed to be disassembled. Structural adhesive bonds are considered to be permanent; i.e. not easily disassembled.

4.1.2 Adhesive bonding

4.1.2.1 General

Successful joining by adhesive bonding needs consideration of a large number of factors which influence the:

- design of the whole structure,
- design of the component parts of the structure,
- design of the joints between components of the structure,
- material selection,
- manufacturing, and
- inspection and maintenance.

It is therefore necessary to adopt a fully-integrated design and materials selection process. This point is emphasised throughout this handbook. Nonetheless, adhesive bonding is a tried and proven technique within aerospace industries, resulting from many years of research, development and analytical activities leading to practical implementation. An example of on-going activities within the aircraft industry is the assessment of industry practices for bonded joints and structures, Ref. [4-11].

4.1.2.2 Bonded examples

Table 4.1-1 gives some examples of adhesively bonded aerospace structures, Ref. [4-3], [4-4], [4-5], [4-6], [4-7], [4-8], [4-9], [4-10].

[See also: Chapter 21 - case studies for bonded connections; Chapter 22 - case studies for bonded structural materials]

Table 4.1-1 - Adhesively bonded aerospace structures: Examples

Aircraft	Laminates and sandwich panels Bonded repairs to composite and metal structures
Civil aircraft	Airbus family - numerous applications Boeing family- numerous applications MD11 - flap vane
Helicopter	Fuselage Rotor blades
Transport aircraft	Control surfaces Fairings
Fighter aircraft	Control surfaces Empennages Wing-to-fuselage joints F-111A: Al alloys and honeycomb panels B-1B: Weapon bay doors (entirely bonded) C-15: Floor beams, fairings, skins and ribs in ailerons and elevators. F-15: horizontal stabilisers/fuselage joints, speed brake (entirely bonded)
Spacecraft	Sandwich panels and laminates
Launchers	Ariane 4: CFRP Thrust cone LVA ring; Adapter 937B, Sylta Ariane 5: Speltra
Space Shuttle	Payload doors - bonded honeycomb
Satellites and payloads	Antenna dishes Galileo radiation shielding Central cylinder sandwich panels Shuttle Pallet Satellite (SPAS) Framework - bonded couplings

4.1.3 Mechanical fastening disadvantages

Adhesive bonding is the preferred method of joining thin-section composite materials used in space structures because:

- precautions are needed to avoid mechanical damage by the machining of composites prior to the installation of fasteners,
- removal of material from the joint region weakens the composite,
- fasteners impose a weight penalty in the joint region and can disrupt aerodynamic surfaces.

Fatigue damage in metal aerospace structures is often associated with fastener holes. In aircraft structures most of the damage seen in service can be attributed to fatigue initiation at fastener holes and corrosion sites.

Adhesive bonding can reduce the need for large numbers of fasteners, hence limiting potential sites for damage initiation. As adhesives also seal joints, the possibility of corrosion (crevice, galvanic and stress-corrosion) is reduced.

Adhesively-bonded repairs to damaged aircraft structures are now commonplace.

4.2 References

4.2.1 General

- [4-1] MIL-HDBK-337: 'Adhesive Bonded Aerospace Structure Repair'. 1982
- [4-2] ECSS-E-HB-32-20: Structural materials handbook
NOTE ECSS-E-HB-32-20 is based on ESA PSS-03-203 Vol. 1 and 2 (1994); ECSS-HB-304
- [4-3] D. J. Wardrop and R.M. Allanson: Westland Aerospace, UK
'Total Capability Contracting for a Flight Control Structure'
Proceedings of 34th International SAMPE Symposium
8-11 May, 1992, p1019-1031
- [4-4] A. Jimenez et al : CASA, E
'Design and Development of CFRP Central Cylinder for Satellites'
ESA SP-336 (October 1992), p33-38
- [4-5] C.A.L. Kemper : Stork BV, NL
'Design and Manufacture of Filament Wound Thrust Cylinder'
ESA SP-336 (October 1992), p51-56
- [4-6] M.J. Curran and N.C. Eaton: Westlands Aerospace, UK
'Application of Advanced Materials to Aircraft Nacelle Structures'
ESA SP-336 (October 1992), p57-62
- [4-7] A. Jimenez et al: CASA, E
'Development of Ariane 4 Adapter 937B'
ESA SP-303 (June 1990), p79-84
- [4-8] F. Hribar et al : JPL, USA
'Development and Qualification of Materials and Processes for Radiation Shielding of Galileo Spacecraft Electronic Components'
Proceedings of 4th International SAMPE Electronics Conference Vol.4 -
Electronic Materials, Albuquerque, 12-14 June 1990, p67-80. ISBN 0 93 89 94 53 0
- [4-9] T.J. Reinhart: Wright-Patterson AFB, USA
'Structural Bonding Needs for Aerospace Vehicles'
Adhesives Age, Vol. 32, No. 1, Jan 1989, p26-28
- [4-10] M. Vignollet: Aerospatiale Aquitaine, F
'Les Composites Dans Assemblage Complexe'
Report REPT-882-430-110, 1989

- [4-11] 'Assessment of Industry Practices for Aircraft Bonded Joints and Structures'
DOT/FAA/AR-05/13 (Final Report), July 2005
Available as PDF from: www.actlibrary.tc.faa.gov

4.2.2 ECSS documents

None.

5 Adherends

5.1 Introduction

5.1.1 General

5.1.1.1 Materials

The components to be joined by adhesive bonding are usually called **adherends**. To produce a variety of very mass-efficient structures, the space industry uses advanced composite materials and metals with high specific stiffness and strength. The use of thin-section materials means that joining by adhesive bonding is feasible. The limiting factors are:

- operating temperatures, and
- stringent demands for reliable performance of both materials and joints in the space environment.

[See: ECSS-E-HB-32-20 Structural materials handbook, which describes all aspects of structural materials either in use or considered for a wide variety of space applications and therefore likely to be encountered as **adherends** for adhesively-bonded joints].

5.1.1.2 Characteristics

The basic characteristics of adherends necessary for the design of bonded joints include, [See: Section II – Design – Clause 7, 8, 9, 10]:

- ultimate strengths (Polymer composites),
- yield strength (Metals),
- **elastic moduli**,
- **coefficients of thermal expansion**,
- maximum elongation,
- chemical composition.

All possible loading modes that the bonded joint is to withstand during its service life need to be known, [See: 8.3], along with knowledge of the effects of environmental exposure are also necessary, e.g. thermal and moisture conditions and exposure duration, plus combinations thereof, [See: 10.3].

[See also: Case studies in Chapter 21; Chapter 22]

5.1.2 Polymer composites

5.1.2.1 Types and forms of polymer composite materials

The majority of composite materials used to manufacture space structures are **epoxy resin** matrices combined with reinforcement fibres of carbon, **aramid** or, to some extent, glass. Structural materials made of polymer composite tend to be either:

- laminated, which are often very thin (two or three plies) for space structures, but can be several tens of plies for aircraft, or
- **sandwich panels**, which usually consist of outer laminated skins (a few plies) and a **honeycomb** or foam core. The skins and cores can be metal, composite or combined composite and metal.

5.1.2.2 High temperature

Applications for composites able to operate at temperatures higher than that possible with epoxy-based formulations meant the development of fibre-reinforced composites with different polymer matrix phases, such as:

- **thermoplastic**, with high-temperature performance,
- **polyimide** (thermosetting resins and thermoplastics),
- **bismaleimide** (thermosetting resins).

5.1.2.3 Low temperature

Fibre-reinforced composites with thermoplastic or thermosetting resin matrices have been considered for low and **cryogenic** temperatures, e.g. cryo-tanks. Evaluation of structural bonded joints within cryo-tank concepts indicate that only a few commercial adhesives perform adequately at low temperatures.

5.1.3 Metals

5.1.3.1 Types and forms of conventional alloys

Metals used for spacecraft structures are usually the same grades used in aircraft manufacture, such as:

- aluminium alloys,
- titanium alloys, which are generally used for:
 - hotter regions, where aluminium alloys are unsuitable,
 - heavily loaded areas,
 - co-bonded inserts in **CFRP**.

Metal alloys are usually:

- sheets,
- **honeycombs**,
- machined couplings for attaching composites (often tubes) to other components.
- fastening devices, such as **inserts** in **honeycomb** panels, [See: ECSS documents: ECSS-E-HB-32-22 Insert design handbook].

5.1.3.2 High temperature

Metals with improved high-temperature and dimensionally stable properties under consideration for aerospace applications include:

- advanced metal alloys, e.g. aluminium-lithium alloys and new titanium alloys,
- MMC metal matrix composites, usually with aluminium alloy matrix phases. The reinforcement phase can be continuous fibres, short fibre, whisker or particulate. Reinforcements are commonly silicon carbide.

MMCs and new metal alloys can be in the form of stock materials, similar to conventional metals. Some are produced as near-net components, depending on the machinability.

5.1.3.3 Low temperature

Conventional aerospace metal alloys along with aluminium-lithium alloys have been considered for low temperatures and cryo-tank concepts. Only a few commercial adhesives perform adequately at low temperatures.

5.1.4 Ceramics

5.1.4.1 Types and forms of ceramic materials

Ceramic-based materials considered for some space applications tend to be grouped as either:

- high temperature, which exceed the temperature capability of conventional metals, e.g. thermal protection systems, control surfaces, re-entry vehicles; or
- dimensionally stable structures, in which the low coefficient of thermal expansion of some ceramic-based materials can be exploited, e.g. antenna dishes and optical support structures.

Owing to the brittle nature and extreme hardness of ceramic-based materials, they are usually produced as near-net shaped components for a particular application rather than as stock shapes, e.g. sheet, tubes and rods that need to be machined to shape and assembled.

5.1.4.2 High temperature

Adhesive bonding with conventional adhesives is not feasible for extremely high-temperature use. Ceramic-based cements tend to be brittle but, depending on the loads experienced, can be considered. In highly-loaded structures, metal and ceramic fasteners are used.

5.1.4.3 Low temperature

Bonding of dimensionally-stable structures has been considered along with a variety of other joining techniques, e.g. brazing ceramic green parts.

5.2 Advanced composites

5.2.1 Polymer-based composites

5.2.1.1 General

The composite materials often used in the manufacture of space structures are:

- carbon-fibre-reinforced **epoxy**,
- **aramid**-fibre-reinforced epoxy,
- glass-fibre-reinforced epoxy.

Applications with higher-temperature performance make use of these fibres in composites with matrix phases of:

- **bismaleimide**,
- **polyimide**, and
- **thermoplastics**.

These materials are used in aircraft structures and are also being considered in concepts for advanced transport vehicles, Ref. [[5-1], [5-2], [5-3]]. [See also: 5.4].

Composites used in aerospace structures tend to be:

- **laminates**,
- outer skins of **sandwich panels**, and
- **filament wound** shapes, e.g. tubes.

[See: ECSS documents: ECSS-E-HB-32-20: Structural materials handbook]

5.2.1.2 Thermoset composite manufacturing

Continuous-fibre reinforcements are usually obtained as sheets of either unidirectional or bidirectional (fabric) fibres combined with a semi-cured resin matrix, known as **B-stage** prepregs.

The usual aerospace methods for producing thermosetting composite materials are:

- laying-up plies of prepreg in specified fibre orientations followed by a consolidation process which fully cures the matrix,
- **filament winding** using either thin strips of prepreg (tapes) or wet resin-impregnated fibres.

Varying the orientation of the plies or windings enables tailoring of the stiffness and strength characteristics of a laminar material to support the loads encountered in a given application. Consequently, it is possible to produce a variety of component properties for any given fibre-matrix combination.

Both lay-up and filament processes are followed by curing of the resin.

5.2.1.3 Thermoplastic composite manufacturing

Thermoplastic plies are obtained in a similar form to thermoset plies, but the matrix phase is fully processed and is softened during manufacture and not cured (as for thermosets).

For thermoplastic-based composites, the plies are assembled in a similar manner to thermosets. Thermal forming processes are then used to soften the matrix and mould the laminate to the finished shape.

5.2.1.4 Adherend types

Table 5.2-1 gives examples of the polymer-based composite materials which have found use in space applications. The list is not exhaustive, but illustrates those materials likely to be encountered when adhesive bonding is used.

Table 5.2-1 - Polymer-based composite adherends

PROPERTIES	MATERIALS	TYPICAL LAY-UPS	USES
Carbon Fibre/Epoxy			
Ultra High Modulus	GY70/Code 69	0°/90°, 0°/60°/120°. Thickness < 1 mm nominal	Antenna dish skins and satellite constructions, where stiffness and dimensional stability properties dominate.
High Modulus	HMS/Code 69	0°/+60°/90°/-60°/0° and 0°/±60°/90°/ ±60°/0°.	SPELDA construction. Stiffness/strength property compromise.
High Strength	T300/5208 XAS/914C T300/976	0°/±45°/0° sandwich skins. ±45°/0°/±45°/0°/±45° Wing sections of 0°, ±45°, and 90° up to 38 mm thickness.	Space Shuttle Payload doors. Ariane 4 Interstage 2/3. Aircraft Assemblies. Strength dominated properties.
Aramid fibre/Epoxy			
High specific tensile strength. Poor compressive properties. Toughness. Impact Resistance.	Kevlar 49/phenolic or epoxy. Twaron HM/epoxy.	0°/90° antenna dish skins either UD of fabric. 0°, 90° and 45° lay-up for aircraft fairings, mixture of UD and fabric. Multiple angles for filament winding.	Pressure vessels, RF Transparency. Aircraft fairings and Radomes. Honeycomb core. Electrically and thermally insulative.
Glass fibre/Epoxy			
Low stiffness Thermally and Electrically insulative. Low dielectric constant.	E-glass, S2-glass/epoxy, phenolic. D-glass	Thin sections (<2mm) combining 0°, ±45° and 90°.	Casings on launch vehicles. Localised areas near joint. Honeycomb core. Gemini and Apollo sacrificial ablative shields. RF Transparency. Radomes (USA).

PROPERTIES	MATERIALS	TYPICAL LAY-UPS	USES
Nomex fibre/matrix combinations			
Nomex fibre has modest mechanical properties. Thermally and electrically insulative.	Nomex/Phenolic Nomex/Epoxy		Honeycomb cores. Low expansion characteristics. Electrically and thermally insulative. Shuttle payload doors. Antenna dishes. Honeycomb cores. SPELDA/SYLDA construction/antenna dishes.
Carbon fibre/Polyimide			
Better thermal stability, hydrolytic stability, oxidation resistance than epoxy.	PMR-15 and Avimid N and LARC resin systems.	Laminate, skins/honeycomb.	Space Shuttle orbiter aft body flap. Laminates and sandwich panels for aircraft thrust reversers and nacelle structures (Airbus 320 and 340), Ref. [5-5]
Carbon fibre/Bismaleimide			
Better thermal stability (less than polyimide) and hydrolytic stability than epoxy.	T800/Narmco 5250-2	Laminate, skins/honeycomb.	ESA LTPP Programme. Co-curing (no adhesive) + secondary bonding. Dornier 328 nacelle (co-cured), Ref. [5-1], [5-5], [5-6]
Carbon fibre/Thermoplastic			
Better thermal and moisture stability, impact resistance than epoxy. Thermoforming manufacturing.	APC-2, APC (HTX); Ryton PPS, PAS-2; Avimid K (Polyimide), CYPAC7005	Laminate.	Bonding development study for thermoplastic composites possibly used in aircraft components, Ref. [5-7] Thermal bonding study (thermoplastic interlayer used as 'adhesive'), Ref. [5-10]

5.2.2 FML - Fibre metal laminates

FML are a family of structural materials developed for fatigue critical applications needing light-gauge sheet. These consist of thin metal sheets, bonded with plies of strong fibres (**aramid**, glass or carbon) impregnated with a thermosetting (**epoxy**) adhesive. The basic types of FML are:

- **ARALL™** - Aramid fibre reinforced. Evaluated for aircraft lower wing and fuselage floor sections and cargo doors,
- **GLARE™** - Glass fibre reinforced. Intended for biaxially-loaded structures, e.g. fuselage panels and beam shear panels,
- **CARE™** - Carbon fibre reinforced. Development materials.

Materials are supplied in sheet form, and components made of FML can be adhesively bonded.

5.2.3 MMC - Metal matrix composites

5.2.3.1 General

The reinforcement phases in MMC can be:

- continuous fibres,
- short fibres,
- whiskers, or
- particulates.

Although a very large number of MMC combinations are theoretically possible, those materials offered commercially all tend to be silicon-carbide-reinforced aluminium alloys. The matrix alloy grade varies considerably.

5.2.3.2 SiCp - SiC particulate reinforced MMC

Table 5.2-2 summarises silicon carbide particulate-reinforced MMCs undergoing evaluation for aerospace structures joined by adhesive bonding, Ref. [5-2]. These were selected for their high stiffness and, in the case of 8009, high-temperature capability.

Table 5.2-2 - Metal matrix composite adherends under evaluation

MMC Type and Form [Supplier]	Composition
SiCp/8009 Sheet thickness: ~2mm [Allied Signal, USA]	Al-8Fe-1.3V-1.7Si+11%SiCp
SiCp/8090 Sheet thickness: ~2mm [AMC Ltd., UK] Note: Al-Li matrix alloy	Al-2.5Li-1.1Cu-0.9Mg-0.13Zr-0.15Fe-0.05Si + 20% SiCp

5.3 Metals

5.3.1 Structural materials

To achieve mass efficiency, metals used in spacecraft construction are those with high specific properties. In practice this tends to limit the metals used to either:

- aluminium alloys, or
- titanium alloys.

The space industries are often guided by the expertise and confidence accumulated by aircraft manufacturers. This serves to limit further the grade and condition of aluminium and titanium alloys used.

5.3.2 New materials

To obtain higher temperature stability than that of conventional alloys, new alloys and reinforced metals are being considered for certain aerospace applications. These materials include:

- advanced metal alloys, such as aluminium-lithium alloys and new titanium alloys,
- **fibre metal laminates** (FML), [See: 5.2].
- Metal matrix composites (MMC), often with an aluminium alloy matrix phase, [See: 5.2].

Adhesive bonding of these materials is under evaluation.

Table 5.3-1 lists metals used, or under evaluation, for adhesively bonded structures, Ref. [5-2], [5-11].

Table 5.3-1 - Metal adherends: Currently used or undergoing evaluation

Material	Properties	Materials	Uses
Aluminium alloy	Specific strength	5052-H39 5056-H39 2024-T3 2024-T81 6061 -T6	Bonded coupling (enabling mechanical fastening). Al-Ta-Al radiation shield, Ref. [5-11]
	High temperature	8009	Advanced aerospace vehicle structures, Ref. [5-2]
Al-Li alloy †	Strength and weldability	RX818-T8	Advanced aerospace vehicle structures, Ref. [5-2]
		8090	Aircraft structures: weight critical.
Titanium alloy	Specific strength	Ti-6Al-4V (Corona 5) (Beta 111)	Bonded couplings (enabling mechanical fastening).
		-	Honeycombs.

†: See also: Table 5.2-2 for Al-Li MMC

5.4 Higher-temperature applications

5.4.1 Adherends

Adhesive bonding is only appropriate for materials which have service temperatures within the service range of the adhesive. Their suitability for adhesive bonding is judged with respect to exposure times as well as temperature, i.e.:

- maximum upper temperature is that which a structural material can tolerate without detrimental loss of performance, e.g. resist thermal excursions,
- perceived service temperature is that which a structural material can tolerate continuously and at which high performance is maintained.

Table 5.4-1 gives a summary of structural materials with possible high-temperature capability and indicates whether or not adhesive bonding is appropriate, Ref. [5-4], [5-12], [5-13]. The temperature values stated are indicative only.

5.4.2 Adhesives

Depending on the temperatures defined by the application, commercial **epoxy**-based adhesives can be suitable for assembling components, and **polyimide** or **bismaleimide** adhesives are usually used for **PI** and **BMI** matrix composites. These can also be used for metals, given adequate surface preparation.

[See also: Chapter 6 for adhesive characteristics and properties]

Table 5.4-1 - Adhesive bonding of materials: High temperature performance

Material	Nominal temperature, °C		Adhesive bonding feasible
	Maximum	Perceived	
'Warm' advanced composites Carbon fibre reinforced:			YES
bismaleimide	250	140	Some existing adhesive systems plus new adhesives
polyimide	300	250	
thermoplastic	250	200	
Advanced metals Aluminium-lithium Alloys ⁽¹⁾	?	110	YES Possible with epoxy adhesives.
MMCs metal matrix composites Silicon carbide, carbon and boron fibre-reinforced:			POSSIBLE
aluminium ⁽¹⁾	450	110	Epoxy adhesives -imide adhesives >110 °C <300 °C Not at upper maximum limit.
titanium	650	400	
High temperature composites C, SiC and alumina reinforced:			NO ⁽⁴⁾
carbon	> 1000	?	Possible with refractory cements ⁽⁵⁾
Glass matrix	1000	?	
Glass/ceramic	> 1000	?	
ceramic matrix	> 1000	?	
High temperature metals ⁽³⁾			NO
Superalloy	1100 ⁽²⁾	1000	
Fibre-reinforced superalloy	1100	1000	
Refractory metals	1200	1000	
Key: (1) Aluminium alloys for structural applications are usually limited to <110 °C service temperature owing to metallurgical changes within the alloy. (2) Dependent upon alloy composition. (3) High density (giving low specific properties) limits their use to propulsion-related items. (4) Not for high-temperature use but possible for dimensional stability, Ref. [5-12] (5) Interlock designs, Ref. [5-13] ? Unknown			

5.4.3 General guidelines

For higher-temperature applications, general guidelines include:

- Adhesive bonding is appropriate for new materials whose long-term thermal exposure (service temperature) lies within the adhesive's service temperature, as dictated by chemical formulation and curing. In general, the **-imide** based adhesive formulations are appropriate for -imide based composites, but can also be used for metals.
- Adhesive bonding is not appropriate for new materials experiencing high loads whose long-term service temperature exceeds that of the adhesive. Mechanical fastening can be the preferred option.
- At service temperatures above 300 °C organic-based adhesives are not appropriate. Some silicone or phenolic-formulations can be considered for very short-term use at or above 300°C. Alternative joining methods for materials are necessary, e.g.:
 - Metals and MMCs: Mechanical fastening, welding and diffusion bonding.
 - Thermoplastic-based composites: Mechanical fastening. Localised melting and welding, with or without a thermoplastic interlayer in the joint region.
 - High-temperature composites: Refractory cements can be considered to be adhesives. Methods of joining carbon and SiC composites by co-pyrolysing pitch or other substances are being evaluated. Mechanical fastening and interlock designs are also being investigated.
 - High-temperature metals: Refractory cements are not appropriate owing to differences in thermal-expansion characteristics. Other joining methods are used in aero engine and related industries, e.g. welding and diffusion bonding.

5.5 Low-temperature and cryogenic applications

5.5.1 Adherends

Adhesive bonding is only appropriate for materials which have service temperatures within the service range of the adhesive.

The suitability of adhesive bonding is judged with respect to exposure times as well as temperature, i.e.:

- Minimum temperature is that which a structural material can tolerate without detrimental loss of performance, e.g. resist thermal excursions and thermal shock.
- Perceived service temperature is that a structural material can tolerate continuously and at which high performance is maintained.

5.5.2 Adhesives

Data on adhesive characteristics at low temperatures and especially in the **cryogenic** range is somewhat scarce, e.g. temperatures less than 100 K.

A few commercial adhesives have been evaluated for low temperature use.

Depending on the temperatures defined by the application:

- some commercial **epoxy**-based adhesives can be used at service temperatures of approximately -50 °C,
- some silicone-based adhesives can be used at service temperatures of -180 °C.

[See also: Chapter 6 for adhesive characteristics and properties]

5.5.3 General guidelines

For low-temperature applications, some general guidelines include:

- adhesive bonding is appropriate for materials whose long-term exposure (service temperature) is within the service temperature of the adhesive, as dictated by chemical formulation and curing,
- adhesive bonding is not appropriate for materials experiencing high loads whose long-term service temperature is beyond that of the adhesive,
- adhesive characteristics at low temperatures need to be evaluated for the intended service temperature, e.g.
 - thermal cycling experienced by orbiting spacecraft;
 - thermal excursions, e.g. thermal shock when filling containers with cryogenics;
 - prolonged low temperatures of deep space or **cryogenics**.

5.6 Bonds between adherends

5.6.1 General

Bonds between adherends can be grouped as:

- composite-to-composite,
- composite-to-metal,
- metal-to-metal,
- dissimilar materials.

5.6.2 Composite-to-composite

Composite-to-composite bonded joints are usually made between thin laminates or skins, e.g. typically a few plies up to a few mm in space structures. Bonding is the preferred means of joining such components.

5.6.3 Composite-to-metal

Composite-to-metal bonded joints are common where:

- a **sandwich panel** composite skin is bonded to an aluminium alloy honeycomb core;
- a sandwich panel is fixed to an edge member;
- composite struts are terminated in metal fittings to enable mechanical fastening, e.g. lattice structures.

5.6.4 Metal-to-metal

Metal-to-metal bonded joints can be grouped as either:

- thin sheet materials, e.g. up to a few mm thick, which can be bonded effectively; or
- thicker sections, which tend to imply a higher load-bearing capacity, can use mechanical fastening or a combination of bonding and fastening. The benefits and disadvantages of combined bonding and mechanical fastening need full consideration.

5.6.5 Dissimilar materials

When designing bonded joints between dissimilar materials, some other factors to be considered fully include:

- Thermal stresses arising from:
 - elevated temperature curing;
 - thermal cycling, e.g. under service conditions;
 - thermal shock, e.g. filling of cryotanks.
- Moisture effects, e.g.
 - during manufacture and storage, Ref. [5-14],
 - possible **galvanic corrosion**.

In addition to composite-to-metal bonded joints, some more examples of adhesive bonding of dissimilar materials include:

- Deployable structures (polymer materials-to-metal or to composites);
- Solar array assembly (glass-to-substrate materials);
- Optical system assembly (glass-to-metal, ceramic-to-metal);
- Vacuum system assembly (glass-to-metal)

5.7 References

5.7.1 General

- [5-1] M.J. Curran and N.C. Eaton: Westlands Aerospace, UK
'Application of Advanced Materials to Aircraft Nacelle Structures'
ESA SP-336 (October 1992), p57-62
- [5-2] Anon.: Boeing Defense and Space Group/NASA
'System Integration and Demonstration of Adhesive Bonded High-temperature Aluminium Alloys for Aerospace Structure. Phase 2/Final report'. NASA-CR-191459
- [5-3] A.M. Brown et al: Boeing Defense and Space Group, USA
'Advanced Thermoplastic Resins- Phase II'
Report NAS 1 26:187548, Contract NAS1-17432, Sept. 1991
- [5-4] ECSS-E-HB-32-20: Structural materials handbook; previously ESA PSS-03-203: 'Structural Materials Handbook'. Vol. 1 and 2 (1994)
- [5-5] S. Cler: Hispano-Suiza, F
'High Temperature Adhesives Commercially Available to be used for Extended Time with PMR-15 Laminates'
Proceedings of 35th International SAMPE Symposium, 2-5 April 1990, p893-906
- [5-6] U. Glaser and H. Krings: MAN, G
'Joining of BMI'
ESA SP-303 (June 1990), p.127-130
- [5-7] J.W. Powers: American Cyanamid Co., USA
'Recent Developments in Adhesives for Bonding Advanced Thermoplastic Composites'
Proceedings of 34th International SAMPE Symposium, 8-11 May 1989, p1987-1998
- [5-8] J. Wilson and D.P. Bashford: Fulmer Research Ltd., UK
'Guidelines on the Significance of Defects in Laminated Composite Materials for Space Structures and Launch Vehicles'; FRL Report No. R878/21/July 1986
- [5-9] 'Handbook of Composites'
1st Edition: G. Lubin (Editor), Van Nostrand Reinhold Co., 1982, ISBN 0-442-24897-0
2nd Edition: S.T. Peters (Editor), Chapman & Hall, 1998, ISBN 0-412-54020-7
- [5-10] B. Goffaux and I. Verpoest: Katholieke Univ. Leuven, B
'Thermal Bonding of Thermoplastic Composites'
ESA SP-303 (June 1990), p.345-350
- [5-11] F. Hribar et al : JPL, USA
'Development and Qualification of materials and Processes for Radiation Shielding of Galileo Spacecraft Electronic Components'

Proceedings of 4th International SAMPE Electronics Conference Vol.4 -
Electronic Materials, Albuquerque, 12-14 June 1990; p. 67-80. ISBN 0 93 89
94 53 0

- [5-12] E. Estrada: Matra-Marconi Espace, Toulouse, F
'Silicon carbide for highly stable structures. Thermo-mechanical and
adhesive bonding characteristics'
ESA WPP-070 (Abstracts). 1994
- [5-13] Dipl.Ing. H. Weihs: DLR-Stuttgart, G
'A New High Temperature Joining Method'
Final Report July 1993. Work Order No. 26
ESA/ESTEC Contract No. 7090/87/NL/PP
- [5-14] JR Williamson et al: ESTEC TEC-QMC, NL
'An Overview of Recent Adhesive Bonding Programmes Conducted
Within ESA's Materials Physics and Chemistry Section (TEC-QMC)
Proceedings of European Conference on Spacecraft Structures, Materials
& Mechanical Testing 2005 Noordwijk, NL, 10 – 12 May 2005, ESA SP-581
(August 2005) CDROM
- [5-15] I. Skeist
'Handbook of Adhesives'
Kluwer, 1996, ISBN 0412096811
- [5-16] P. Cognard
'Handbook of Adhesives and Sealants: Basic Concepts and High Tech
Bonding'
Elsevier, 2005, ISBN 0080445543

5.7.2 ECSS documents

[See: [ECSS](#) website]

ECSS-E-HB-32-20	Structural materials handbook; previously ESA PSS-03-203
ECSS-E-HB-32-22	Insert design handbook; previously ESA PSS- 03-1202

6

Adhesive characteristics and properties

6.1 Introduction

6.1.1 General

A large number and variety of adhesives have been developed to provide solutions for joining an equally wide variety of materials.

Adhesive manufacturers have consistently rejected the concept of a 'universal' adhesive. Consequently there are many different types of commercially-available adhesives, but only a few have proven experience in space applications, [See also: 6.8].

6.1.2 Guidelines

The first rule to remember is that:

'Anything can be bonded by adhesives, but no adhesive exists that can effectively bond everything'

The use of adhesives demands detailed technical specifications. Joint design should be carefully studied, taking into account temperature and area, [See: Chapter 9].

Adhesives should exhibit several properties, including:

- Strain capability; to accommodate joints between dissimilar materials,
- **Cure** at as low a temperature as practical,
- Coefficients of thermal expansion of adhesives are in the **CTE** range of the joint parts,
- Moisture effects should be minimised,
- Thickness cannot be too large,
- Compatibility with **adherends**,
- Conform to **outgassing** requirements, [See: ECSS documents: ECSS-Q-ST-70-02].

[See: Chapter 7]

6.2 Types of adhesives

6.2.1 Formulation

To tailor the adhesive properties, some products have a base of one polymer combined, or modified, with different generic polymers. The **epoxy** group is a prime example of this modification process.

Many adhesive products have evolved to meet 'industrial' engineering needs, and as such, exhibit characteristics unsuitable for the specific demands of aerospace, [See: ECSS documents: ECSS-Q-ST-70; ECSS-Q-70-71 "Space product assurance - Data for selection of space materials and processes", previously ESA PSS-01-701].

6.2.2 Characteristics

6.2.2.1 General

Adhesives can generally be classed as:

- Structural, where load-bearing properties are needed,
- Non-structural, used for low load-bearing applications or where good thermal contact or a sealing capability is necessary.

There are many generic types of adhesives covering both structural and non-structural classes. In each there are many proprietary products with different chemical formulations.

Table 6.2-1 summarises the various generic polymer-based adhesives and gives a broad overview of their characteristics.

6.2.2.2 Structural adhesives

Structural adhesives are often described as those achieving in excess of 7 MPa shear stress in lap-shear tests, Ref. [6-5].

6.2.2.3 Non structural adhesives

Non-structural adhesives are often used to join dissimilar materials where other joining methods are impossible, e.g. involving glasses or ceramics. Also included in this class are potting materials, sealants and coating materials.

Table 6.2-1 - Classification of adhesives: General characteristics and properties

Family	Characteristics		Limitations	Aerospace Use
	Advantages	Disadvantages		
Epoxy (modified with)				
<ul style="list-style-type: none"> • nylon • nitrile • novolac • phenolic 	<ul style="list-style-type: none"> • High shear strength • Low shrinkage • Cure 120 °C or 170 °C (depends on formulation) 	<ul style="list-style-type: none"> • Brittle • Low hot strength 	<ul style="list-style-type: none"> • High temperature <170°C • Hot/wet environments 	<ul style="list-style-type: none"> • Most widely used for metal and composite bonds
Polyurethane				
	<ul style="list-style-type: none"> • Moderate shear strength • Tough • Flexible at low temperatures 	<ul style="list-style-type: none"> • Moisture sensitive 	<ul style="list-style-type: none"> • Not used for hot/wet environments with metals 	<ul style="list-style-type: none"> • Limited • Some use at cryogenic temperatures
Acrylic				
Modified with 'rubbery phase'	<ul style="list-style-type: none"> • Moderate shear strength • Tough • Flexible bonds • Resistant to contaminants 	<ul style="list-style-type: none"> • Difficulty in reproducing good mass-produced bonds • Can craze thermoplastics 	<ul style="list-style-type: none"> • Limited formulations available 	<ul style="list-style-type: none"> • Limited
Polyester				
	<ul style="list-style-type: none"> • Moderate shear strength • Good electrically 	<ul style="list-style-type: none"> • Brittle • High shrinkage • Low hot strength 	<ul style="list-style-type: none"> • Limited 	<ul style="list-style-type: none"> • Limited on aircraft and for electrical applications (radomes)
Phenolic				
Modified with 'rubbery phase'. Note: Phenolic used to modify epoxy	<ul style="list-style-type: none"> • Good hot strength 	<ul style="list-style-type: none"> • Possibly corrosive • Poor electrically • Low/moderate strength 	<ul style="list-style-type: none"> • Limited to higher temperature applications (>170°C, <300°C) 	<ul style="list-style-type: none"> • Limited to higher temperature applications (>170°C, <300°C)

Family	Characteristics		Limitations	Aerospace Use
	Advantages	Disadvantages		
Silicone				
	<ul style="list-style-type: none"> • High heat resistance 	<ul style="list-style-type: none"> • Low strength 	<ul style="list-style-type: none"> • Higher temperature applications (>170°C, <300°C) • Low temperature applications (<100°C) 	<ul style="list-style-type: none"> • Higher temperature applications (>170°C, <300°C) • Low temperature applications (<100°C)
Polyimide				
	<ul style="list-style-type: none"> • Very high heat resistance • Good electrically 	<ul style="list-style-type: none"> • Rigid • High temperature cure • Possibly corrosive 	<ul style="list-style-type: none"> • Limited to higher temperature applications (up to 300°C) 	<ul style="list-style-type: none"> • Limited to higher temperature applications (up to 300°C)
Cyano-acrylate				
'Superglue' type	<ul style="list-style-type: none"> • Good tensile strengths 	<ul style="list-style-type: none"> • Brittle • Low viscosity • Sensitivity to moisture and solvents • Difficult to handle 	<ul style="list-style-type: none"> • Small bond areas • Very expensive 	<ul style="list-style-type: none"> • Limited to non-structural (fastener locking)
Anaerobic				
Cure in the absence of oxygen	<ul style="list-style-type: none"> • High cohesive strength 	<ul style="list-style-type: none"> • Low adhesive strength 	<ul style="list-style-type: none"> • Specialist use dictated by curing mechanism 	<ul style="list-style-type: none"> • Limited to non-structural (fastener locking)
Thermoplastic 'Hot melt'				
Wide range of materials with a wide range of properties	<ul style="list-style-type: none"> • Low/moderate tensile properties (depending on material) • Insensitive to moisture 	<ul style="list-style-type: none"> • Soften as temperature raised 	<ul style="list-style-type: none"> • Limited to low temperature applications (below softening point) 	<ul style="list-style-type: none"> • Possible future use with thermoplastic matrix composites

6.2.3 Mechanical properties

A combination of **shear strength** and **peel strength**, determined by standard coupon tests, is often used as an indicator of adhesive mechanical performance. Table 6.2-2 gives some typical properties for various generic groups of adhesives, Ref. [6-5].

Table 6.2-2 - Classification of adhesives: Typical shear and peel strength characteristics

Adhesive type	Shear strength (MPa)	Peel strength (N/mm) ¹
Cyanoacrylate	7 to 14	0.2 to 3.5
Anaerobic acrylic	7 to 14	0.2 to 2.0
Polyurethane	7 to 17	2.0 to 9.0
Modified acrylic	14 to 24	2.0 to 9.0
Modified phenolic	14 to 28	3.5 to 7.0
Epoxy	10 to 28	0.4 to 2.0
Bismaleimide	14 to 28	0.2 to 3.5
Polyimide	14 to 28	0.2 to 1.0
Modified epoxy	20 to 40	4.5 to 14.0

Key: 1 Peel strength data from metal adherends

6.2.4 Environmental durability

The mechanical properties of adhesives are affected by exposure to temperature, moisture and combinations thereof. Depending on the precise adhesive formulation and processing, the long-term loss of properties under 'hot/wet' conditions can be significant compared with those attained under ambient dry conditions.

Aircraft manufacturers and controlling bodies, e.g. FAA and CAA, have addressed the 'hot/wet' degradation problem over the years in numerous studies and industry-based workshops, Ref. [6-8], [6-9]. The overall aim is to provide guidance and, eventually, standards on all aspects of aircraft structural bonds and bonded repairs.

The space industry is also assessing the long-term **durability** of bonded structures because some assembled structures can be stored for extended periods prior to launch and entering service. Depending on the mission, structures can be exposed to more extreme environmental conditions than those usually encountered by space structures, Ref. [6-7].

6.2.5 Aerospace structural adhesives

Structural adhesives applicable to aerospace applications are usually limited to:

- **epoxy-based**, [See: 6.3], which are established and widely used often in the form of modified epoxies that can contain:
 - **phenolic**,
 - **polyamide**,
 - **nitrile**.
- **polyimide**, [See: 6.4];
- **bismaleimide**, [See: 6.5];
- **silicone**, [See: 6.6].

Adhesives that retain some flexibility at low temperatures are often called ‘elastomeric’, [See: 6.7], and are used for particular ‘cold’ applications and not for structural bonds.

This handbook considers primarily those adhesives that are appropriate for space structural use. These are suitable for composite adherends and, to some extent, for composite-to-metal bonds, [See also: 6.8].

6.3 Epoxy-based adhesives

6.3.1 General

6.3.1.1 Features

The first generation of **epoxy** adhesives was introduced in the 1950’s. Since then their acceptance and use has grown steadily. Epoxy-based adhesives are used extensively for metal and composite bonding.

The main features of epoxy-based adhesives are:

- a range of mechanical properties depending on formulation and curing,
- evolvment during cure no by-products (except for phenolic-modified types),
- low shrinkage,
- good adhesion to many different substrates.

In addition to the various curing agents used, elastomeric modifiers are added to improve peel strength and moisture resistance. Newer varieties were formulated to be ‘tougher’, i.e. having improved impact resistance and higher fracture surface energies, whilst retaining stiffness and hot strength, Ref. [6-1].

[See also: 6.8 for a review of adhesives used in some European manufacturers of space structures]

6.3.1.2 Cure

Epoxy adhesives are available as one - or two-part **pastes** or as **films** of various thicknesses.

One-part pastes and films are cured at elevated temperatures, whereas two-part systems can be cured at **RT** or elevated temperature to reduce the cure time. Depending on the particular adhesive system, cure temperatures range from RT up to 175 °C.

6.3.2 Properties

6.3.2.1 Epoxy film adhesives

Table 6.3-1 summarises the mechanical and physical properties of some of the commercially-available **epoxy-based film adhesives**, including those evaluated by **ESA**, [See also: ECSS document: ECSS-Q-70-71 "Space product assurance - Data for selection of space materials and processes", previously ESA PSS-01-701].

The adhesives listed are those which have been evaluated for space use (with **outgassing** data) for aerospace structures and includes information from manufacturers. Property values are indicative only.

Table 6.3-1 - Epoxy-based film adhesives: Properties

Adhesive	Type	TS MPa	TM GPa	El %	LSS MPa	Peel Ncm ⁻¹	ρ gcm ⁻³	Moist. Abs.%	Tg °C	TML %	RML %	CVCM %	CTE 10 ⁻⁶ °C ⁻¹	Cure‡ °C	Service Temp. °C	Notes
Hexcel Composites , formerly Ciba Polymers																
Redux 312*	U	-	-	-	45.0	4.9	-	-	-	1.1	0.4	0.05	-	120	-55 +120	Metal and composites. Flammability: Fail (21%O ₂) NASA-STD-6001; Outgassing: ECSS-Q-ST-70-02. Areal wts (g/m ²): 300, 150 (Redux 312L) or 100 (Redux 312UL). Redux 212N (foaming), Redux 206-NA (high foam ratio).
Redux 312/5	S	-	-	-	13.6	-	-	-	-	-	-	-	-	120	+100	Metal/honeycomb bonding. Knitted carrier for bondline thickness control. Areal wt. 300 g/m ²
Redux 319	U	-	-	-	42.1	-	-	-	-	-	-	-	-	175	+150	Metal/honeycomb and composites. Areal wts (g/m ²): 380. Redux 219/s-NA (foaming).
Redux 319L	U	-	-	-	40.9	-	-	-	-	-	-	-	-	175	+150	Areal wt. (g/m ²): 180. Light-weight version of 319.
Redux 319A	S	-	-	-	36.4	-	-	-	-	-	-	-	-	175	+150	Woven nylon carrier. Areal wt. (g/m ²): 400
Redux 322	U+S	-	-	-	19.9	-	-	-	-	-	-	-	-	175	+200	Woven nylon carrier. Areal wts (g/m ²): 300 (supported or unsupported), 380.
Cytec , formerly Cyanamid (including ex-BASF products)																
Metlbond 329-7	S	-	-	-	-	-	-	-	-	-	-	-	-	180	-55 +216	Metal/core, metal/metal and composite bonding. (216 °C short-term).
Metlbond 329	S	61.3	6.86	1.5	11	-	1.60	0.09	192	0.85	-	0.002	43.2	180	-55 +177	Metal. MMM-A-132; MIL-A-25463. Outgassing data from manufacturer.
FM 73	U+S	52.4	2.14	3	45	-	1.16	0.18	95	1.47	-	0	41.1	<120	+82	Selected for PABST programme (metal). Composite secondary and cocure. Knit and mat support. Radar transparent.

Adhesive	Type	TS MPa	TM GPa	El %	LSS MPa	Peel Ncm ⁻¹	ρ gcm ⁻³	Moist. Abs. %	Tg °C	TML %	RML %	CVCM %	CTE 10 ⁻⁶ °C ⁻¹	Cure‡ °C	Service Temp. °C	Notes
FM 96U	U	-	-	-	-	-	-	-	-	0.15	-	0.02	-	175	+175	Outgassing data from manufacturer.
FM 300M	S	-	-	-	-	-	-	-	-	0.37	-	0.004	-	175	-55 +150	Mat support. Surfacing ply for composites. Outgassing data from manufacturer.
FM 300-2	U+S	-	-	-	38.6	-	-	-	144	-	-	-	-	120	-	Composite secondary bonding/cocuring. 120 °C cure version of FM300. Knit or mat support. Radar transparent, X-ray opaque.
FM 300K	S	-	-	-	-	-	-	-	147	-	-	-	-	175	+150	Metal, honeycomb and composite secondary and cocure. Knit or mat support. Radar transparent, X-ray opaque.
FM 410-1	U	-	-	-	-	-	0.32 0.64	-	-	0.84 0.33	-	0 0	-	125 175	-55 +175	Foaming (expansion ratio 1.7 to 3.5). Outgassing data from manufacturer. Radar transparent.
3M																
AF 126-2	S†	-	-	-	35.8	3.5 ⁽¹⁾	-	-	-	2.62	-	1.34	-	<177	-55 +121	Outgassing: NASA SP-R-0022. MMM-A-132; MIL-A-25463
AF 143-2	S	-	-	-	22.4	3.2	1.27	-	-	-	-	-	-	177	-55/+177	-
AF 163-2M	S†	48.2	1.1	-	39.4	3.8 ⁽¹⁾	1.16	-	-	-	-	-	-	<149	-55/+121	Mat carrier. 0.24 mm thick.
AF 163-2K	S†	48.2	1.1	-	40.0	3.9 ⁽¹⁾	1.28	-	-	-	-	-	-	<149	-55/+121	Knit carrier. 0.24 mm thick.
ACG Advanced Composites Group Ltd.																
MTA™ 240	U+S	-	-	-	27- 40 ⁽³⁾	50-105 (2)	-	-	-	-	-	-	-	80 to 177	<+130 (dry)	Metals, composites and honeycomb
<p>Notes: (1) - T-peel (3) – Lap shear (ASTM D3165-00) (2) – Honeycomb climbing drum (ASTM D1781-76) † 0.06 wt. version. Others available See also: ECSS-Q-HB-70-71 data sheets for those denoted * ‡ - Refer to manufacturers data</p> <p>Key: U – unsupported; S – supported; ρ - density; CTE - coefficient of thermal expansion; CVCM - collected volatile condensed matter; El – elongation; LSS - lap shear strength; Moist. Abs. - moisture absorption; RML - recovered mass loss; Tg - glass transition temperature; TM - tensile modulus; TML - total mass loss; TS - tensile strength</p>																

6.3.2.2 Epoxy paste and liquid adhesives

Mechanical and physical properties of some of the commercially available **epoxy**-based paste and liquid adhesives are summarised in Table 6.3-2. Those adhesives listed have been evaluated for space use (with **outgassing** data) for aerospace structures and includes information from manufacturers. Property values are indicative only.

[See also: 6.8 for a review of adhesives used in some European manufacturers of space structures]

Table 6.3-2 - Epoxy-based paste and liquid adhesives: Properties

Adhesive	Type	TS MPa	TM GPa	El. %	LSS MPa	Peel Ncm ⁻¹	ρ g cm ⁻³	Moisture Abs. %	Tg °C	TML %	RML %	CVCM %	CTE 10 ⁻⁶ °C ⁻¹	Cure ‡ °C	Service Temp°C	Notes
Vantico , formerly Ciba Polymers																
Araldite AV100	2-part	15	2.7	-	15.0	-	-	-	50-60	1.1	0.5	0.07	60	RT 60	-	Obsolete. Previously evaluated by ESA
Araldite AV138* {Araldite 2004}	2-part	43 ⁽²⁾	-	-	18.4	(30) ⁽¹⁾	(1.6)	⁽⁴⁾	66	0.84	0.57	0.02	67 ⁽³⁾	RT	<120 †	Toxicity/offgassing: Pass NASA-STD-6001; Flammability: Pass (24.5%O ₂); Odour test: Pass with 65 °C cure, fail RT cure. Outgassing: ECSS-Q-ST-70-02 AV138M is a newer version.
Emerson & Cumming , formerly W.R. Grace																
Eccobond 'solder' 56C*	2-part	-	-	-	5.65	Low	~3.5	-	-	0.30	0.20	0.02	36	50 65	-60 +175	Electrically conductive, silver-loaded. Toxicity/offgassing: Pass NASA-STD-6001; Flammability: Pass (24.5%O ₂); Outgassing: ECSS-Q-ST-70-02. Space experience with Catalysts 9 and 11.
3M																
Scotchweld EC 2216*	2-part	-	-	-	17.2	28 ⁽¹⁾	-	-	11.8	1.42	0.75	0.01	45 ⁽⁵⁾ 182 ⁽⁶⁾	<93	-50 +80	Modified epoxy. Toxicity/offgassing: Pass NASA-STD-6001; Flammability: Pass (24.5%O ₂); Outgassing: ECSS-Q-ST-70-02.
Loctite , formerly Dexter Hysol																
EA934NA	2-part	40	3.8	1.2	21.4	-	1.36	-	71 129	-	-	-	-	RT 93	+149	Tg cure temp. dependent. MMM-A-132
EA9321	2-part	49	2.9	6	27.6	10.5	-	-	212	-	-	-	-	RT/<95	+120	[See also: 18.06 Case Study]
EA9394	2-part	46	4.2	1.7	29.0	-	1.3	-	78	-	-	-	56	RT/<95	+177	Aluminium-filled. Repair adhesive. MMM-A-132
Notes: (1) Roller peel test: ISO 4578, cure 16 hrs @ 40°C (4) catalyst sensitive to moisture before use; degrades outgassing and mechanical properties; (2) tested at 40°C (5) between -100 °C and 0°C (3) between 18 °C and 93 °C (6) between 40 °C and 100 °C † long-term ‡ Refer to manufacturers' data for specific cure schedule See also: ECSS-Q-HB-70-71 data sheets for those denoted *																
Key: ρ - density; CTE - coefficient of thermal expansion; CVCM - collected volatile condensed matter; El - elongation; LSS - lap shear strength; Moist. Abs. - moisture absorption; RML - recovered mass loss; Tg - glass transition temperature; TM - tensile modulus; TML - total mass loss; TS - tensile strength																

6.3.3 Environmental durability

6.3.3.1 Aircraft epoxy paste and film adhesives

The **durability** of adhesives under 'hot/wet' conditions is a prime concern of the aircraft industry, Ref. [6-8], [6-9].

A DOT-FAA study determined the shear characteristics of several adhesives either in use or intended for structural aircraft bonding. They were tested to ASTM 5656, thick-adherend lap-shear, under dry, elevated temperature and 'hot/wet' conditions, Ref. [6-8]. Of the 18 adhesives evaluated, some were **epoxy-based** materials used in Europe for space applications; listed in Table 6.3-3, Ref. [6-8].

The test programme compared the environmental performance of the adhesives, rather than that of bonded joints. The durability of bonded joints is often established using DCB-type test specimens and fracture mechanics, [See: Chapter 15].

Table 6.3-3 - Epoxy-based adhesives: Environmental durability assessment

Adhesive product code	European space use [See: Table 6.8-1]	Adhesive product code	European space use [See: Table 6.8-1]
Film adhesives		Paste adhesives	
AF 126 [3]	-	EA 9309.3 NA	YES
FM 73 [1]	YES	EA 9346.5	-
FM 300	YES	EA 9359.3	YES
EA 9628	-	EA 9360	-
EA 9695	-	EA 9392	-
EA 9696	Used in ISS	EA 9394	YES
		EA 9396	-
		3M DP-460 EG (epoxy)	[3]
		3M DP-460 NS (epoxy)	-
		3M DP-820 (acrylic)	-
Key: [1] Used in PABST - Primary Adhesively Bonded Structures Technology (US Air Force programme, in 1970s); [2] 1 st generation adhesive, used in aerospace industry for over 30 years; [3] Non-typical in aerospace structural bonding; [4] International Space Station			

6.3.3.2 Araldite AV 138M/HV 998

The tests were part of an ESA/ESTEC study on the performance of adhesives. AV138M is an RT-curing epoxy adhesive system and an established material for space use. The high strength (15 MPa to 17 MPa lap shear), toughness and low outgassing characteristics are usually attained after a 60 °C post-cure. The work investigated the effect of long-term storage on assembled joints under ambient or high humidity conditions prior to entering an operational phase, Ref. [6-7].

Accelerated testing, to ISO 9142, in high-humidity and thermal environments was used, i.e.

- 95% relative humidity and 70 °C (lap shear specimen, to ISO 4587 and ASTM D1002),
- 100 °C in air (DCB test specimen, to BS 7991),
- 60 °C water immersion (DCB test specimen, to BS 7991).

DSC and TGA analysis techniques were used to investigate cure state, **glass transition** and moisture-related effects, Ref. [6-7].

Figure 6.3-1 shows the effect of environmental exposure on the adhesive toughness (adhesive fracture energy); determined by **DCB** tests, Ref. [6-7].

Thermal pre-cycling, which is used as part of the qualification process, produced no adverse effects. Exposure to all of the environments generally resulted in an increase in the adhesive fracture energy, when compared with the control set. This indicates that environmental exposure produced a slightly tougher material. Towards the end of exposure, the adhesive appeared tougher when subjected to water combined with temperature, Ref. [6-7].

Although lap shear strengths after environmental ageing at 95% **RH** and 70 °C showed a similar trend in strength increase as the **DCB** results up to 4500 hours, after 9500 hours exposure some samples exhibited either a 'weak' (< 1 MPa) or 'strong' (about 15 MPa) failure, irrespective of post-curing or not; as shown in Figure 6.3-2, Ref. [6-7].

Analysis of tested samples showed that 'weak' bonds failed at the adhered-to-adhesive interface, whereas 'strong' bonds exhibited cohesive failure in the adhesive layer. The weak bonds were attributed to the surface preparation method used; a solvent/ ultrasonic clean. Using a durable pre-treatment, e.g. acid etching or anodising, is expected to reduce interfacial failures and therefore improve the strength of joints after environmental exposure, Ref. [6-7].

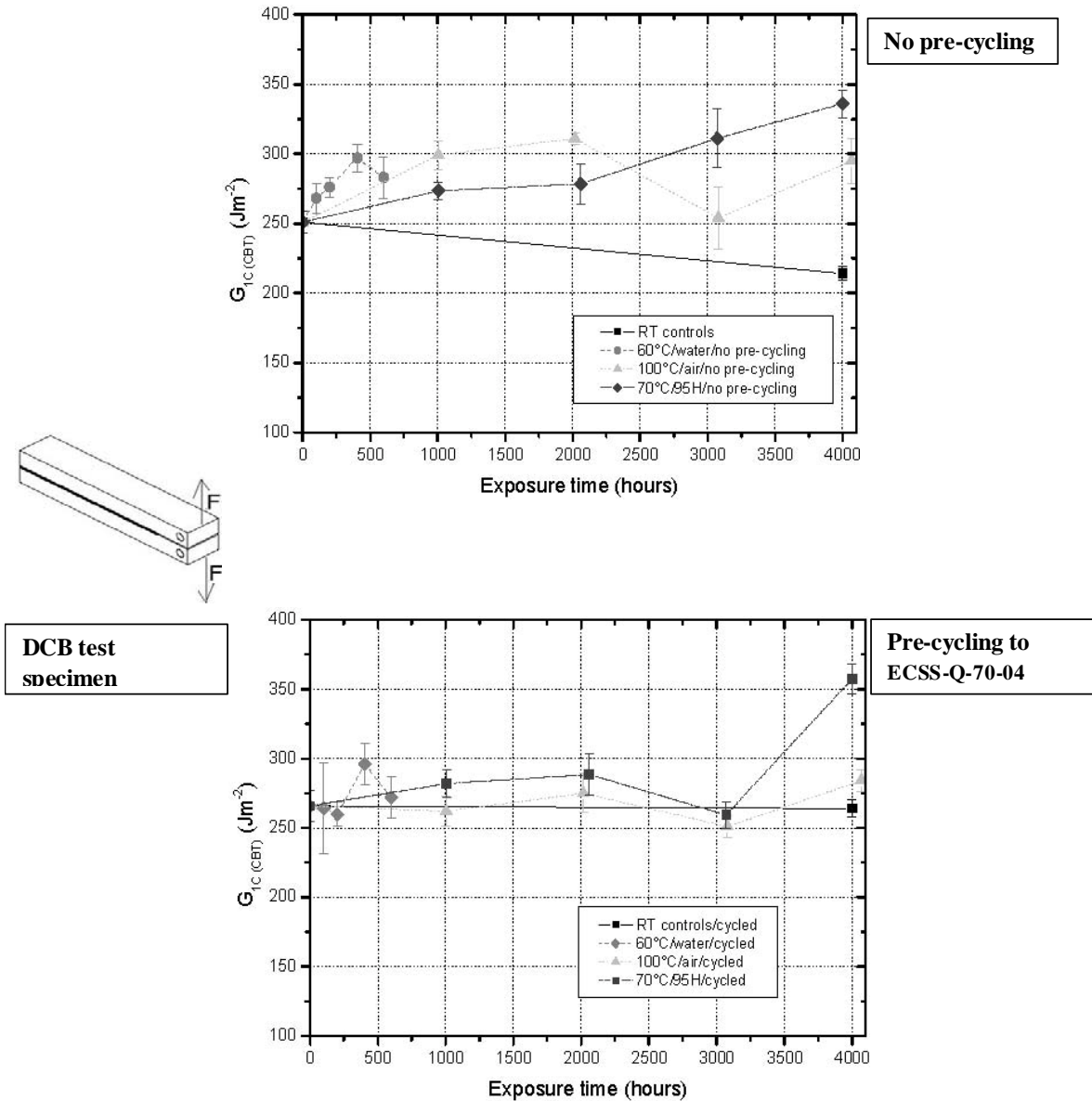

Figure 6.3-1 - Epoxy-based Araldite AV 138M adhesive system: Environmental resistance (DCB tests)

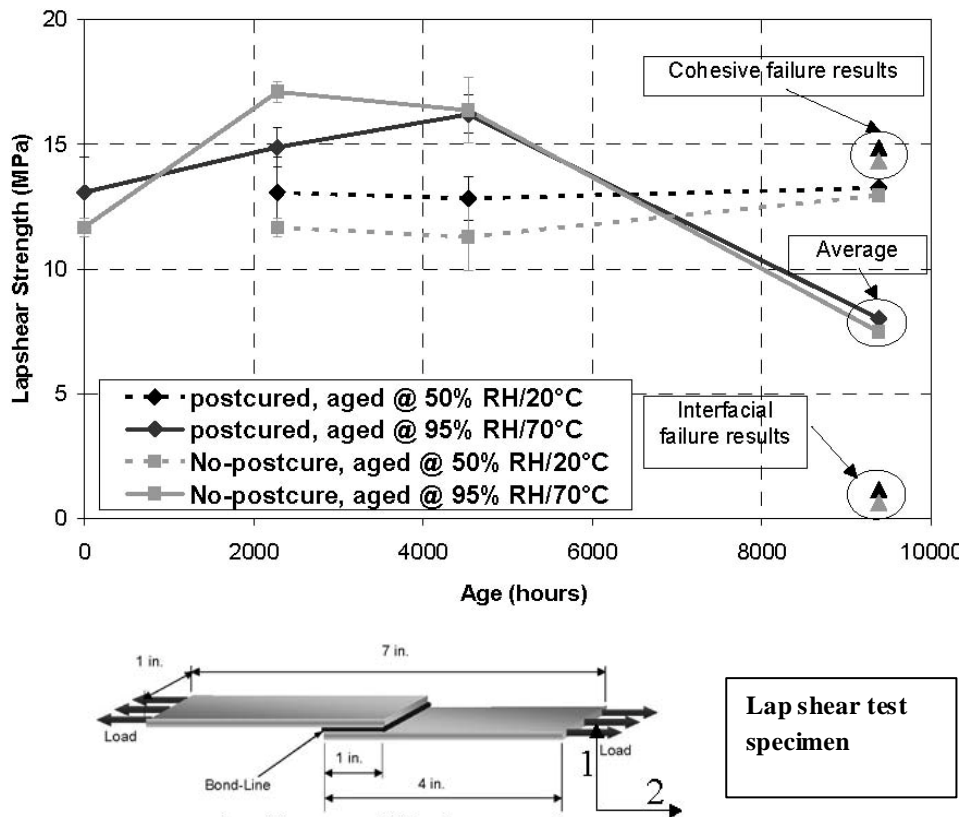

Figure 6.3-2 - Epoxy-based Araldite AV 138M adhesive system: Environmental resistance (lap shear tests)

The results of DSC and TGA tests showed that, Ref. [6-7]:

- post curing is necessary to achieve complete cure of an RT-cured adhesive,
- T_g (**glass transition temperature**) of a fully cured adhesive is in the range 65 °C to 73 °C. A phase change or melting, which occurred at about 160°C, was associated with an unknown ingredient,
- moisture suppresses the T_g to about 43 °C to 48 °C (first heating cycle of environmentally exposed sample),
- dried samples (second heating cycle of environmentally exposed sample) show a restored T_g of about 65 °C,
- post curing occurs in elevated temperature environments to produce a stronger material,
- plasticisation by absorbed water (suppressed T_g), produces a tougher material.

The beneficial effects were ultimately offset by detrimental effects of moisture at the interface; seen in the 9500 hour lap shear results.

It was concluded that both the lap shear and DCB results showed that AV 138M to be relatively durable to environmental exposure when stored without the application of load. However, **durability** is likely to reduce if load is applied during the exposure cycle, Ref. [6-7].

6.3.3.3 Cytec FM 300-2M and FM 96-U film adhesives

An ESA/ESTEC study determined the temperature-related CTE and shear modulus properties of the Cytec adhesives using TGA and DMA analysis techniques. The work was part of an investigation of failed thermally-cycled GOCE solar substrate array qualification samples, Ref. [6-10].

The T_g results, which range from 130 °C to 160 °C for both materials, are indicative only because the values depend on the analysis criterion applied and measurement method. DSC analysis is used to obtain more accurate data. The tests showed that the CTE is reasonably constant below about 50°C. Above this temperature the adhesives approach their glass transition region and the CTE starts to increase exponentially. Failure due to CTE mismatch is a possibility with repeated crossing of the T_g transition region; as seen in thermal cycling experiments, Ref. [6-10].

Table 6.3-4 summarises the test results obtained, Ref. [6-10].

Table 6.3-4 - Epoxy-based film adhesives: Cytec FM 300-2M and FM 96-U: CTE and shear modulus, determined by TGA and DMA

Property	Adhesive		Analysis technique
	FM 300-2M	FM 96-U	
CTE, 20 °C [$\mu\text{m}/(\text{m } ^\circ\text{C})$]	72 ± 1	47 ± 1	TGA
Shear modulus, 20 °C [MPa]	750 ± 20	860 ± 20	DMA
Elastic modulus, 20 °C [MPa]	≈ 2.0	≈ 2.3	Calculated, using $E = 2G(1 + \mu)$, assuming $\mu = 0.35$
CTE, -100 °C to +100 °C [$\mu\text{m}/(\text{m } ^\circ\text{C})$]	71 ± 1	48 ± 1	TGA
Secondary relaxation, by max $\tan\delta$, [°C]	-76 ± 1	-66 ± 1	DMA
T_g , onset, [°C]	135 ± 1	139 ± 1	TGA, indicative only
T_g , by onset of G' , [°C]	135 ± 1	129 ± 1	DMA, indicative only
T_g , by onset of max $\tan\delta$, [°C]	152 ± 1	156 ± 1	DMA, indicative only
Key: CTE: coefficient of thermal expansion; T_g : glass transition temperature; TGA: Thermal gravimetric analysis; DMA: Dynamic mechanical analysis			

6.4 Polyimide-based adhesives

6.4.1 General

6.4.1.1 Features

The main features of **polyimide** adhesives are:

- high-temperature capability (to 300°C),
- excellent electrical properties, e.g. radome applications,
- evolution of volatiles during cure, so extraction or high processing pressures are needed.

Polyimide adhesives are primarily available as **films**, although some **pastes** are available, Ref. [6-2].

[See also: 6.8 for a review of adhesives used in some European manufacturers of space structures]

6.4.1.2 Polymerisation reactions

There are two main types of polymerisation reaction, or cure, for the available **polyimide** adhesives and their processing characteristics are different:

- Condensation cure, where linking of the monomers liberates simple volatile molecules (often water molecules - hence the general term 'condensation');
- Addition cure, where monomer linking is achieved by the reorganisation of chemical bonds - with no evolution of volatiles.

6.4.1.3 Condensation cure

Condensation cure polyimides were the first type to be introduced and can withstand temperatures of 260 °C to 315 °C, approximately. Volatiles are evolved during cure, so processing is normally carried out under vacuum to remove these from the curing polymer. The cure temperature is usually 177 °C followed by a post-cure at 290 °C.

6.4.1.4 Addition cure

The first stage of curing, carried out at approximately 200 °C, is a 'condensation' type. At the end of this the adhesive is a **thermoplastic**. This is followed by a higher pressure and temperature stage (approximately 290 °C) to consolidate the bondline and finalise the cure. These adhesives have a slightly lower oxidation resistance than the 'condensation' types, limiting their service temperature to about 260 °C.

6.4.2 Properties

Table 6.3-2 summarises the mechanical and physical properties of some of the commercially available **polyimide**-based adhesives.

The adhesives listed are those which have been evaluated for aerospace structures, with information from technical papers describing bonded joint developments and from manufacturers. Property data are indicative values only.

Table 6.4-1 - Polyimide-based film adhesives: Properties

Adhesive	Type	TS MPa	TM GPa	El. %	LSS MPa	Peel Ncm ⁻¹	ρ g cm ⁻³	Moist. Abs. %	Tg °C	TML %	RML %	CVCM %	CTE 10 ⁻⁶ °C ⁻¹	Cure‡ hr/°C	Service Temp. °C	Notes
Cytec , formerly Cyanamid																
FM30	-	-	-	-	-	-	0.32 0.64	-	-	-	-	-	-	1h/175 + 1.5h/290	+288	Foaming (expansion ratio 1.5 to 2.5). For core splice of polyimide structures. Radar transparent; not X-ray opaque.
FM35	S	-	-	-	24.5	-	-	-	300	-	-	-	-	.5h/205; 2h/290 + 2h/290	+290	Glass carrier. Addition type polyimide, PMR-15 based. For secondary bonding and co-curing of PMR-15 composites. Al filled. X-ray opaque; not radar transparent. FM35-1 non-aluminium filled version of FM35.
FM36	U+S	-	-	-	18.2	-	-	-	175	-	-	-	-	1.5h/175 + 2h/290	+290	Glass carrier or unsupported. Modified condensation polyimide. For metal, sandwich and composite secondary bonding and co-cure. Radar transparent; not X-ray opaque.
FM680	S	-	-	-	17.7	-	-	-	-	-	-	-	-	2h/175 + 2h/371	+316	Glass carrier. Condensation polyimide. For composite secondary bonding and co-cure.
FMX55	-	-	-	-	-	-	-	-	-	-	-	-	-	-	-	Non-MDA, condensation type.
FMX56	-	-	-	-	-	-	-	-	-	-	-	-	-	-	-	MDA free, PMR-15 based.
Notes:	† - long-term ‡ - refer to manufacturers' data for specific cure schedule U - unsupported S - adhesive supported on a carrier layer															
Key:	ρ - density; CTE - coefficient of thermal expansion; CVCM - collected volatile condensed matter; El - elongation; LSS - lap shear strength; Moist. Abs. - moisture absorption; RML - recovered mass loss; Tg - glass transition temperature; TM - tensile modulus; TML - total mass loss; TS - tensile strength															

6.5 Bismaleimide-based adhesives

6.5.1 General

Bismaleimide-based adhesives evolved from the development of **BMI** resins for fibre-reinforced composites.

The main features of bismaleimide adhesives are, Ref. [6-1]:

- high-temperature capabilities, e.g. 200 °C to 230 °C,
- excellent electrical properties, e.g. high-energy radome applications,
- no volatiles evolved during cure (pure addition reaction), which simplifies processing and reduces bondline porosity,
- poor peel resistance, owing to their stiffness, but modified-**BMI** adhesives can provide improved peel resistance, Ref. [6-3].

[See also: 6.8 for a review of adhesives used in some European manufacturers of space structures]

6.5.2 Properties

Table 6.5-1 summarises the mechanical and physical properties of some of the commercially available bismaleimide-based adhesives.

The adhesives listed are those which have been evaluated for aerospace structures, with information from technical papers describing bonded joint developments and from manufacturers. Property data are indicative values only.

Table 6.5-1 - Bismaleimide-based film adhesives: Properties

Adhesive	Type	TS MPa	TM GPa	El. %	LSS MPa	Peel Ncm ⁻¹	ρ g cm ⁻³	Moist. Abs. %	Tg °C	TML %	RML %	CVCM %	CTE 10 ⁻⁶ °C ⁻¹	Cure‡ hr/°C	Service Temp. °C	Notes
Hexcel Composites , formerly Ciba Polymers																
Redux 326	S	-	-	-	18 metal 23 comp	-	-	-	~200	-	-	-	-	2h/175	+200	Metal and composite bonding. Areal weights (g/m ²): 250, 500.
Cytec , formerly Cyanamid																
Metlbond 2545	-	-	-	-	-	-	-	-	-	-	-	-	-	-	-55 /+177	Co-cure sandwich structures. Metal and composite. Compatible with 5245C resin.
Loctite , formerly Dexter Hysol																
EA9673	-	-	-	-	13.8 metal 12.4 comp	-	-	5.6 †	298	-	-	-	-	1h/175 + 2h/245	+290	For metals, honeycomb and composite. No cure volatiles. Low toughness reported at low temperatures. Service +200 (dry), +175 (wet).
LF8707-2	S	-	-	-	31.7	-	-	3.6 †	227	-	-	-	-	175	-	-
XEA9833	-	-	-	-	-	-	-	-	-	-	-	-	-	1h/175 + 2h/245	+230	Intumescent core splice. Foaming, expansion ratio 2 - 3:1 at 175°C. Thickness: 1.25, 2.5 mm
Notes: † - long-term S - adhesive supported on a carrier layer ‡ - refer to manufacturers' data for specific cure schedule Key: ρ - density; CTE - coefficient of thermal expansion; CVCM - collected volatile condensed matter; El - elongation; LSS - lap shear strength; Moist. Abs. - moisture absorption; RML - recovered mass loss; Tg - glass transition temperature; TM - tensile modulus; TML - total mass loss; TS - tensile strength																

6.6 Silicone-based adhesives

6.6.1 General

6.6.1.1 Features

Silicones are synthetic polymeric materials which can be formulated to have a very wide range of properties. They all have a basic polysiloxane structure, which is responsible for their unusual combination of organic and inorganic chemical properties.

The main features of silicone-based materials are:

- a wide range of possible viscosities,
- very good temperature resistance, e.g. -120 °C to +300 °C,
- high temperatures withstand for long periods; up to 200 °C typically, Ref. [6-7].
- resistance to **UV** and **IR** radiation,
- resistance to oxidation.

The different chemistries in commercial products can affect the processing conditions and, in some cases, the chemical by-products released, [See also: Cure].

Silicone adhesives are widely used in so called 'soft-structural applications', where, Ref. [6-7]:

- adhesive strength is needed to maintain component integrity,
- flexibility is necessary to accommodate strains or vibrations,
- secondary demands meeting, e.g. optical transmission, where appropriate; thermal or electrical conductivity; sealing or gap filling.

An example of a 'soft-structural' application is assembly of solar cells.

[See also: 6.8 for a review of adhesives used in some European manufacturers of space structures]

6.6.1.2 Cure

Cure categories for **silicone**-based adhesives can be broadly grouped as, Ref. [6-7]:

- condensation (one-part systems), which involve moisture and the release of acetic acid. A 'surface downwards' type cure (due to moisture) causes a skin to form, along with the undesirable release of a potentially corrosive substance are avoided in two-part systems.
- condensation (two-part systems), known as 'oxime' cure, e.g. CV2568 and RTV 566 commercial products.
- addition, e.g. platinum catalysed cure process used in **RTV-S 691**, have the advantages of no release of by-products, so no associated shrinkage. The complex **catalyst** used can be affected by other chemical substances which in turn can affect cure.

Most are cured at **RT** for several days, although higher temperatures can be used to reduce cure times.

6.6.2 Properties

Data on the properties of **silicone**-based adhesives is given in Table 6.6-1. The list is limited to some of those evaluated for space use, Ref. [6-4].

Table 6.6-1 - Silicone-based paste and liquid adhesives: Properties

Adhesive	Type	TS MPa	TM GPa	El. %	LSS MPa	Peel Ncm ⁻¹	ρ g cm ⁻³	Moist. Abs. %	Tg °C	TML %	RML %	CVCM %	CTE x10 ⁻⁶ .C ⁻¹	Cure‡ °C	Service Temp °C	Notes
GE Silicones																
RTV 566* (filled)	2-part	6.6	-	-	-	-	1.51	-	-	0.27	0.23	0.03	200	RT	-115 / +315	Offgassing/Toxicity: Pass NASA-STD-6001; Thermal cycling: Pass ECSS-Q-ST-70-04; Oxygen index: 23.6 ECSS-Q-ST-70-21; Outgassing: ECSS-Q-ST-70-07. RTV 567 (non-filled)difficult to procure in Europe.
Dow Corning																
DC 6-1104	1-part	3.4	-	-	-	-	1.12	-	-117	0.18	0.14	0.03	387	RT	-65 / +150	Previously evaluated by ESA.
DC 93500* (1)	2-part	7.0	-	-	-	-	1.08	-	-84	0.30	0.28	0.03	300	RT	-65 / +200	Adhesive, potting and coating. Primers available for high adhesion. Can be filled with silica (thixotropic), silver powder (electrical conductivity) with 24h/80°C cure.Sensitive to contamination (thin layers). Flammability (as coating): Pass (24.5%O ₂); NASA-STD-6001; Thermal cycling: Pass ECSS-Q-ST-70-04; Oxygen index: 49.5 ECSS-Q-ST-70-21; Outgassing: ECSS-Q-ST-70-07
Wacker Chemie																
RTV S 691*	2-part	4 - 6	-	-	-	-	1.41 1.43	-	-111	0.35	0.35	0.07	200 400	RT	-180 / +200	Flammability: Burnt NASA-STD-6001; Toxicity/offgassing: Fails NASA-STD-6001 (improved with 65°C cure); Thermal cycling: Pass ECSS-Q-ST-70-04; Outgassing: ECSS-Q-ST-70-02.
RTV S 695*	2-part	-	-	-	0.7	-	-	-	-110	0.05	0.04	0.01	320	RT	-180 / +200	Low mechanical resistance. Optical uses, e.g. solar-cell/cover-glass. Flammability: Self-extinguishing (21%O ₂), burnt (24.5%O ₂) NASA-STD-6001; Thermal cycling: Pass ECSS-Q-ST-70-04; Outgassing: ECSS-Q-ST-70-02.
NuSil																
CV range*	2-part	-	-	-	-	-	~1.01	-	-	-	-	-	-	RT	-115 / +260	Range of controlled volatility RTV silicones for coatings. Can be carbon loaded for electrical conductivity, [See ECSS-Q-HB-70-71].
Notes: (1) – Commercial versions available: thixotropic, high viscosity, low viscosity.																
See also: ECSS-Q-HB-70-71 data sheets ‡ - Refer to manufacturers' data for specific cure schedule. Those listed require 7 days at RT.																
Key: ρ - density; CTE - coefficient of thermal expansion; CVCM - collected volatile condensed matter; El – elongation; LSS - lap shear strength; Moist. Abs. - moisture absorption; RML - recovered mass loss; Tg - glass transition temperature; TM - tensile modulus; TML - total mass loss; TS - tensile strength.																

6.6.3 Environmental durability

6.6.3.1 Temperature

Figure 6.3-1 summarises the temperature performance of some commercially-available silicone adhesives, Ref. [6-7]. The tests were conducted as part of an ESTEC internal study on the performance of adhesives under harsh, long-term environmental conditions expected in space missions.

All the lap shear strengths fall to about 20% of the RT value at 300 °C prior to any thermal ageing. Although the relative changes are approximately the same for all the adhesives, their absolute strengths were appreciably different, Ref. [6-7].

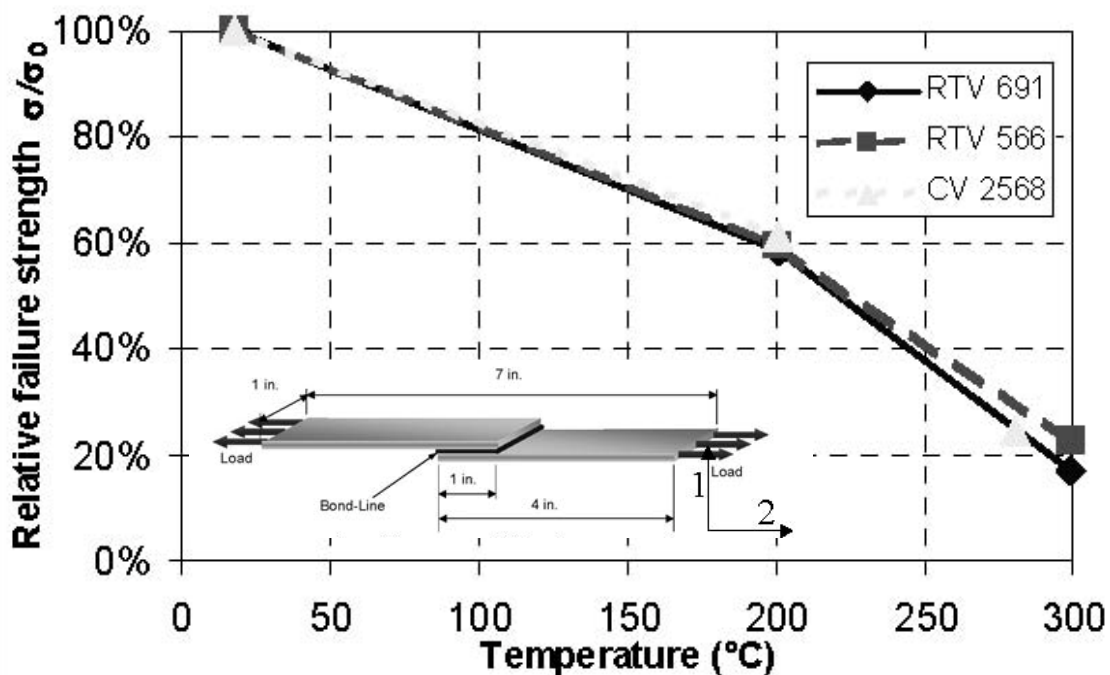

Figure 6.6-1 - Silicone-based adhesives: Temperature performance

Thermal ageing at 200 °C and 280 °C, and subsequent testing at the exposure temperature, showed differences in the lap shear adhesive strengths that did not correspond with mass-loss data.

It was concluded that whilst the changes in lap shear strength are probably associated with changes in modulus, due to various degradation mechanisms (both chemical and mass-loss related), the strength attained does not follow the trends shown in mass loss data. This has implications when using model free-kinetic techniques to predict survivability. It is therefore important to link mass-loss lifetime predictions to relevant properties, e.g. modulus, bond strength, optical properties, Ref. [6-7].

6.7 Elastomeric adhesives

6.7.1 General

Adhesives that do not become excessively brittle at low temperatures are sometimes called elastomeric, e.g.

- **silicone**-based adhesives, [See: 6.6];
- some polyurethanes, e.g. Solithane™ 113.

Elastomeric adhesives have particular applications in low temperature environments, e.g. 0 °C to -120 °C, such as within cryotank constructions, rather than the usual structural bonding applications.

[See also: 6.8 for a review of adhesives used in some European manufacturers of space structures]

6.8 Adhesives used in space

6.8.1 Adhesive systems

An adhesive system describes:

- base,
- hardener,
- catalyst (accelerators),
- fillers or additives,
- primer.

The characteristics of adhesive bonds are dependant upon the relative proportions of each component of the adhesive system, e.g. the mix ratio of base and hardener, or whether a filler is added or a primer used on the adherends, [See: 7.1]. Depending on the application, adhesive systems do not always use all the component parts, e.g. catalysts, fillers or primers are not always necessary.

Processes and cure schedules also have a strong influence on bond performance, [See: 7.1; 12.1 and 13.1].

A comprehensive evaluation process is necessary for materials and processes used in space projects, [See: ECSS documents: ECSS-Q-ST-70].

Of the enormous range of adhesive systems that are commercially available, only some are appropriate for application in space.

Table 6.8-1 summarises, by source, the types of adhesives in use from a survey of some European contractors to the space industry (carried out in 2004). This list is not exhaustive.

Manufacturers, suppliers and products listed are for information only. A comprehensive evaluation process is necessary for materials and processes used in space projects, [See: ECSS documents: ECSS-Q-ST-70].

Table 6.8-1 – Adhesive systems used in space: Examples

Manufacturer / Supplier Product Name	Type	Comments	Source
<u>3M</u>			
966	Acrylic	Project: MSG-4 SA	[6]
AF3109			[4]
EC2216 A/B	Epoxy (RT)	Structural	[2] [4] [1] [5]
Scotchweld 2216	Epoxy (RT)		[2] [4] [1]
Scotchweld AF163-2U-015			[1]
Scotchweld DP490			[1]
Structure Adhesive 9323 B/A		Structural; Primary structure	[1] [5]
<u>A.I. Technology Inc.</u>			
ME 8452			[1]
TP8090			[1]
<u>Ablestik</u>			
Ablebond 8385			[1]
Ablebond 84-1LMI/T			[1]
Ablebond 958-7			[1]
Ablebond 958-11			[1]
Ablebond 968-4			[1]
Ablefilm 566			[1]
Ablefilm 566K			[1]
Ablefilm ECF 561E			[1]
Ablefilm 5020K			[1]
Ablefilm 5025E			[1]
Abletherm 8-2			[1]
<u>Alpha Industries Inc.</u>			
Trans-Bond TB-199-020			[1]
<u>Altropol Kunststoff</u>			
Neukadur EP270 + T3		Structural (for insert potting)	[1] [5]
<u>Norland (Centronic)</u>			
Optical Adhesive NOA 61			[1]
<u>Chomerics</u>			
Chobond 1029			[1]
<u>Cotronics</u>			
Resbond 919			[1]
<u>Cytec Fiberite</u>			
FM 73	Epoxy	Film	[5] [6]
FM 96	Epoxy	Film; Project GOCE [6]	[5] [6]
FM 300	Epoxy (177 °C)	Film; Project MSG-4 SA	[2] [5] [6]
FM 300-2	Epoxy	Project MSG-4 SA	[6]
FM 410	Epoxy	Foaming adhesive; sandwich panels	[1] [5]
FM 410-1	Epoxy (177 °C)	Foam (substituted by FM 490A); Project SARLupe SA [6]	[2] [5] [6]
FM 490A	Epoxy (177 °C)	Foam (replaced FM 410-1)	[2]
<u>Dow Corning</u>			
DC 1200		Primer	[1]
DC 1204		Primer	[1]
DC 6-1104 + CV1143			[1]
DC 93-500	Silicone	DC1200 Primer	[1] [6]

Manufacturer / Supplier Product Name	Type	Comments	Source
<u>Emerson & Cuming</u>			
Eccobond 285 + Catalyst 9			[1] [3]
Eccobond 56/C + Catalyst 9	Epoxy (RT)	Electrocoally conductive adhesive; Project MSG-4 SA, SARLupe SA [6]	[2] [1] [5] [6]
Eccobond 57C	Epoxy		[6]
Eccobond 59C	Silicone		[6]
Eccosil 4952 + Catalyst 50		Primer S11	[1]
S11		Primer	[1]
SS 4155		Primer	[1]
Stycast 1090	Epoxy	Project: SARLupe SA	[6]
Stycast 1090SI + Catalyst 9	Epoxy (RT)	Insert potting	[2]
EY1030A		Project MSG-4 SA	[6]
<u>Epotek (Epoxy Technology; Gentec Benelux)</u>			
Epotek 301-2			[1]
Epotek H20E			[1]
Epotek H21D			[1]
Epotek H40			[1]
Epotek H81			[1]
<u>General Electric</u>			
RTV 142	Silicone		[1]
RTV 566 A/B	Silicone (RT)	with Chobond or carbon fibre	[2] [1]
RTV 566 A/B	Silicone (RT)	Base; mirror bonding	[1]
RTV-S 691	Silicone		[6]
<u>Herbets</u>			
7146			[4]
<u>Hexcel Composites</u>			
Redux 112		Primer	[1] [3]
Redux 119		Primer	[1] [3]
Redux 203		now Vantico Araldite 2011	[1] [4]
Redux 206 NA	Epoxy	Project: MSG-4 SA	[6]
Redux 252		now Vantico Araldite 252	[1]
Redux 312	Epoxy (120 °C)	Film; sandwich panel skins; Project: MSG-4 SA [6]	[1] [3] [6]
Redux 312-5	Epoxy (120 °C)	Film	[4] [3]
Redux 312L	Epoxy (120 °C)	Film	[2] [3]
Redux 312UL	Epoxy (120 °C)	Film	[3]
Redux 319		Film; sandwich panel skins	[1] [6]
Redux 319L		Film	[3]
Redux 322	Epoxy		[6]
Redux 340U	Epoxy	Project: SARLupe SA, TerraSAR SA	[6]
Redux 403		now Vantico Araldite 403	[1]
Redux 420		now Vantico Araldite 420	[1]
<u>Keene (Phase Components)</u>			
6700			[1]
CuClad 6700			[1]
<u>Litton Solder</u>			
Lefkoweld109 + LM 52			[1]

Manufacturer / Supplier Product Name	Type	Comments	Source
<u>Loctite</u>			
Henkel Chemosil 211			[4]
Henkel Chemosil 360			[4]
Henkel Chemosil 411			[4]
Henkel Chemosil 411			[4]
Henkel Chemosil 6025			[4]
Henkel Chemosil 6025			[4]
Henkel Chemosil 6070			[4]
Hysol EA9309		Paste	[1] [3]
Hysol EA 9313	Epoxy	Project: GOMOS, SILEX	[6]
Hysol EA9321 A/B	Epoxy (RT)	Paste; Project: SYLDA 5 [6]	[3] [1] [2] [4] [6]
Hysol EA9323	Epoxy		[6]
Hysol EA934 NA	Epoxy (RT)	Paste	[2] [1] [6]
Hysol EA9361	Epoxy	Project: MHI-rods; MSG-4 SA	[6]
Hysol EA9394	Epoxy (RT)	Paste; Project: EXPRESS, SARLupe SA, TECSAR [6]	[2] [3] [4] [6]
Hysol EA9395			[1] [4]
Hysol EA9396	Epoxy	Project: SARLupe SA, TerraSAR SA	[6]
Loctite 480			[1]
<u>McGhan Nusil</u>			
CV-1142	Silicone		[1]
CV-2566	Silicone		[1]
CV-2566 + Chobond	Silicone	additions of carbon fibre or microspheres	[1]
CV-2946			[1]
SP 120		Primer	[1]
<u>Permabond Adhesives</u>			
Self Indicating Primer (SIP)		Primer	[1]
<u>Shell (Resolution Europe; Cray Valley; Stag Polymers; Hopkins and Williams)</u>			
Epikote 828 + Ancamine Z	Epoxy	Alumina additions	[1]
Epikote 828 + Crayamid 140	Epoxy	Paste with Silica filler. Crayamid 140 was Versamid 140; panel repairs	[1]
Epon 828 + Crayamid 140	Epoxy	Paste. Crayamid 140 was Versamid 140; panel repairs	[1]
<u>Structil</u>			
EA 9685-1			[4]
Hysol 9321			[4]
Hysol 9394			[4]
Hysol 9395			[4]
Redux 312-5			[4]
ST1060			[4]
<u>Uniroyal Chemical Co. (Crompton Corp.; Morton International)</u>			
Solithane S 113 + Cat. C113-300	Polyurethane	with and without silica additions; thread locking	[1] [3]

Manufacturer / Supplier Product Name	Type	Comments	Source
Vantico (Huntsman Advanced Materials)			
Araldite 2004		was AV138M +/- HV998; primary structure	[1]
Araldite 2011		was Redux 203	[1] [4]
Araldite 203			[1]
Araldite 252		was Redux 252 Tooling aid	[1]
Araldite 403		was Redux 403	[1]
Araldite 420		was Redux 420	[1]
Araldite AV 138	Epoxy (RT)	Paste	[3] [2]
Araldite AY105 + HY951			[1]
AV100 + HV100		Obsolete	[1]
AV138M + HV998		now Araldite 2004	[1] [3]
CW1304GB + HY1300GB			[1]
Epikote 828 + Crayamid 140		Paste with silica filler. Crayamid 140 was Versamid 140; panel repairs	[1]
Epon 828 + Crayamid 140		Paste with silica filler. Crayamid 140 was Versamid 140; panel repairs	[1]
MY750(AY105) + HY956			[1]
MY750(AY105) + HY956 / DT075			[1]
MY750(AY105) + HY956 / EUC24			[1]
MY753(AY103) + HY956			[1]
Uralane 5750		with fillers	[1]
Sources: [1] ASTRIUM (UK); [2] ALENIA SPAZIO (I); [3] EADS-CASA (E); [4] EADS LV (F); [5] Patria (Finland); [6] EADS-Astrium (D)			

6.9 References

6.9.1 General

- [6-1] I. Skeist (Editor)
 'Handbook of Adhesives' 3rd Edition: Van Nostrand Reinhold, 1990,
 ISBN 0-442-28013-0
 Kluwer Academic Publishers, February 1996, ISBN 10-0412096811
- [6-2] D.K. Kohli: American Cyanamid Co., USA
 'Development of Polyimide Adhesives for 371 °C (700 °F) Structural
 Performance for Aerospace Bonding Applications: FM680 System';
 Proceedings of 37th International SAMPE Symposium, 9-12 March,
 1992, p430-439

- [6-3] M. M. Gebhardt: Dexter Corp., USA
'A Toughened Bismaleimide Film Adhesive for Aerospace Applications'; Proceedings of 34th International SAMPE Symposium, 8-11 May 1992, p643-655
- [6-4] ECSS-Q-70-71 "Space product assurance - Data for selection of space materials and processes", previously ESA PSS-01-701
- [6-5] D. Fontanet et al: SNECMA Moteurs, F
'Design of bonding joints in solid rocket motors'; Proceedings of 3rd European Conference on Launcher Technology, Strasbourg 11-14th December, 2001, p573-590
- [6-6] P. Cognard
'Handbook of Adhesives and Sealants: Basic Concepts and High Tech Bonding'
Elsevier, 2005, ISBN 0080445543
- [6-7] JR Williamson et al: ESTEC TEC-QMC, NL
'An Overview of Recent Adhesive Bonding Programmes Conducted Within ESA's Materials Physics and Chemistry Section (TEC-QMC) Proceedings of European Conference on Spacecraft Structures, Materials & Mechanical Testing 2005 Noordwijk, NL, 10 – 12 May 2005, ESA SP-581 (August 2005) CDROM
- [6-8] 'Shear Stress-Strain Data for Structural Adhesives'
DOT/FAA/AR-02/97 (Final Report), November 2002
Available as PDF from: www.actlibrary.tc.faa.gov
- [6-9] 'Assessment of Industry Practices for Aircraft Bonded Joints and Structures'
DOT/FAA/AR-05/13 (Final Report), July 2005
Available as PDF from: www.actlibrary.tc.faa.gov
- [6-10] S. Heltzel: ESA/ESTEC Materials and Processes Division
'Thermomechanical and dynamic mechanical analysis of three epoxy adhesives for Dutch Space'
ESA/ESTEC Materials Report Number: 4253, issue 1 (25th April, 2005)

6.9.2 Data sheets

[See also: Manufacturers' websites]

[3M](#)

[ACG](#) – Advanced Composites Group Ltd.

[Cytec](#), formerly Cyanamid (including ex-BASF products)

[Dow Corning](#)

[Emerson & Cuming](#), formerly W.R. Grace products

[GE Silicones](#)

[Hexcel Composites](#), formerly Ciba Polymers (Redux® products)

[Loctite](#), formerly Dexter Hysol

[Vantico](#), formerly Ciba Polymers (Araldite® products)

[Wacker Chemie](#)

6.9.3 Sources

Examples of adhesive systems in use space, [See: 3.08] provided by:

- [1] ASTRIUM (UK);
- [2] ALENIA SPAZIO (I);
- [3] EADS-CASA (E);
- [4] EADS LV (F)
- [5] Patria (Finland);
- [6] EADS-Astrium (D).

6.9.4 ECSS documents

[See: [ECSS](#) website]

ECSS-Q-ST-70	Materials, mechanical parts and processes
ECSS-Q-70-71	Data for the selection of space materials and processes
ECSS-Q-ST-70-02	Thermal vacuum outgassing test for the screening of space materials; previously ESA PSS-01-702
ECSS-Q-ST-70-04	Thermal testing for the evaluation of space materials, processes, mechanical parts and assemblies; previously ESA PSS-01-704
ECSS-Q-ST-70-21	Flammability testing for the screening of space materials; previously ESA PSS-01-721

6.9.5 Other standards

NASA-STD-6001	Flammability, odor, offgassing and compatibility requirements and test procedures for materials in environments that support combustion; previously NASA NHB 8060.1 (parts A and B).
---------------	--

7

Adhesive selection

7.1 Introduction

A considerable number of factors are involved in the selection of adhesives for structural joints, [See: 7.2]. These are related to the joint design, and a combined design and material selection approach is crucial. Those factors applicable to space structures are described:

- Post-application, [See: 7.3].
- Pre-application, [See: 7.4].
- Application, [See: 7.5].
- Adhesive screening (bulk properties), [See: 7.6].

[See also: ECSS documents: ECSS-Q-ST-70; ECSS-Q-70-71: Data for the selection of space materials and processes; previously ESA PSS-01-701]

7.2 Adhesive selection factors

7.2.1 Guidelines

Figure 7.2-1 summarises the various factors involved in adhesive selection, Ref. [7-5]. For each factor, a full evaluation of the application and the capabilities of a particular adhesive is crucial. Guidelines for each of the factors are provided:

- post-application, [See: 7.3].
- pre-application, [See: 7.4].
- application, [See: 7.5].

7.2.2 Evaluation exercise

The starting point of an evaluation exercise is usually dictated by the intended use. For space-destined structures, environmental tolerance, including loads to be endured throughout the life of the assembly, is probably the most convenient starting point.

7.2.3 Trade-off

Ultimately the adhesive selection is a trade-off between:

- adequate performance,
- manufacturing ease and cost,
- acceptability status, i.e. known experience or previous qualification of a similar space structure.

[See also: 7.6].

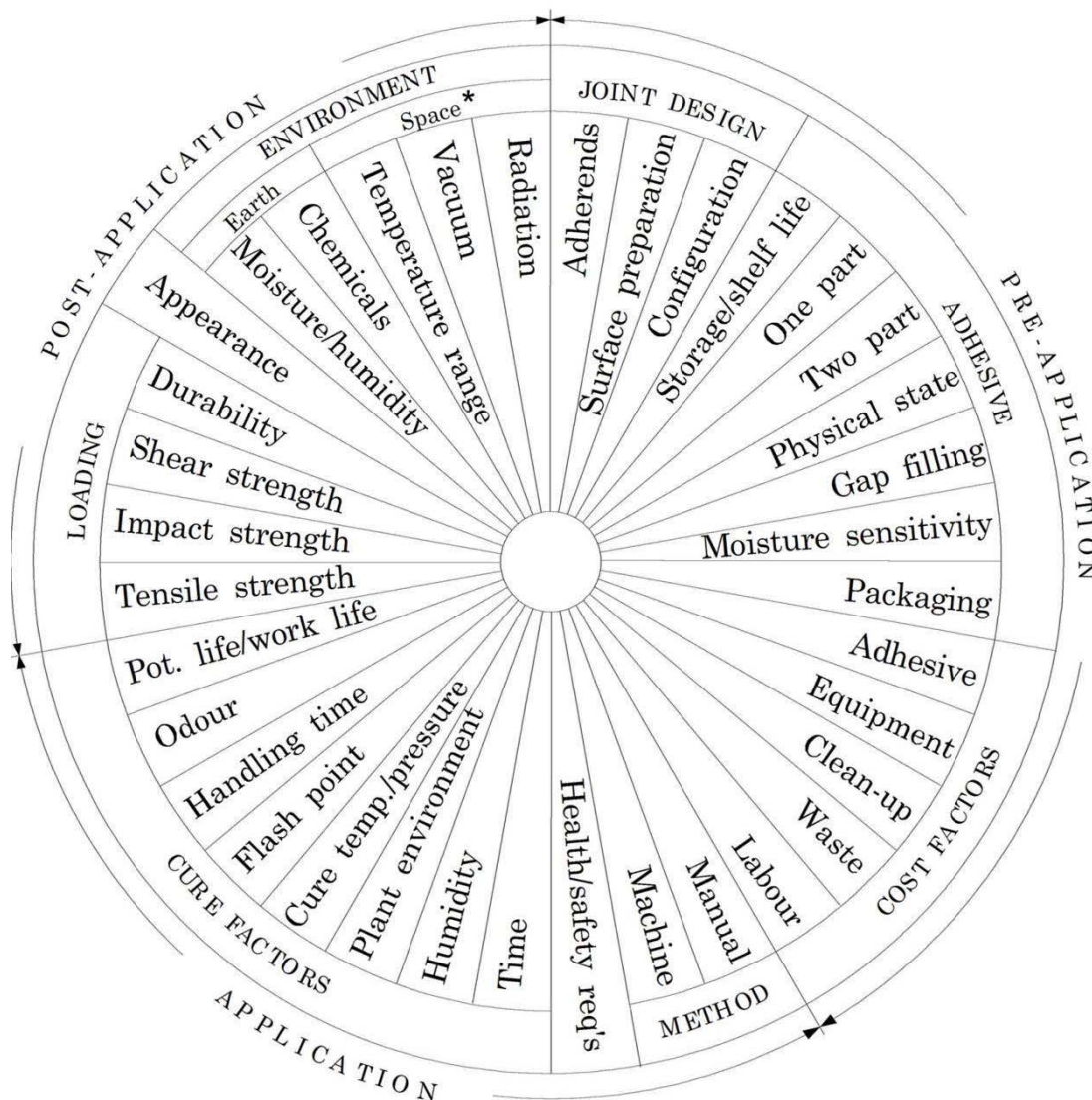

*: Attention to;
Toxicity, Flammability, Outgassing, Offgassing

Figure 7.2-1 - Adhesive selection factors

7.3 Post application selection factors

7.3.1 Earth environment

7.3.1.1 General

The manufacture and assembly of space structures on Earth means that temperature, humidity and the effects of contact with chemicals need consideration. Although such factors are usually controlled within the manufacturing facilities, [See: ECSS documents: ECSS-Q-ST-70-01], storage of assembled joints for extended periods under ambient or high humidity conditions prior to entering an operational phase are also of interest, Ref. [7-10]. For bonds made in less than ideal conditions, e.g. bonded repairs, the effects of temperature and humidity need full evaluation, [See: 17].

7.3.1.2 Temperature

Temperature affects the cured adhesive properties, e.g.:

- **Creep** occurs at elevated temperatures under loading,
- Combined hot-wet conditions cause loss of performance.

7.3.1.3 Elevated temperature response of adhesive lap joints

All adhesives are formulated to have differing levels of thermal performance. The limiting operational temperature for the adhesive can be defined in a number of ways.

Figure 7.3-1 illustrates the lap shear strength of a simple adhesive joint for a lap joint made between metal plates, usually an etched aluminium alloy. When tested, cohesive failure occurs in the adhesive. The performance of the adhesive can be described in different ways, i.e.:

- Initial room temperature shear strength (X MPa, 100%). Typically 30 MPa to 45 MPa,
- The temperature at which the room initial shear strength is halved (X/2 MPa, 50%),
- A minimum retained value (Y MPa), eg 15 MPa or 6.89 MPa (1000 psi),
- The **glass transition** temperature, T_g, of the cured adhesive.

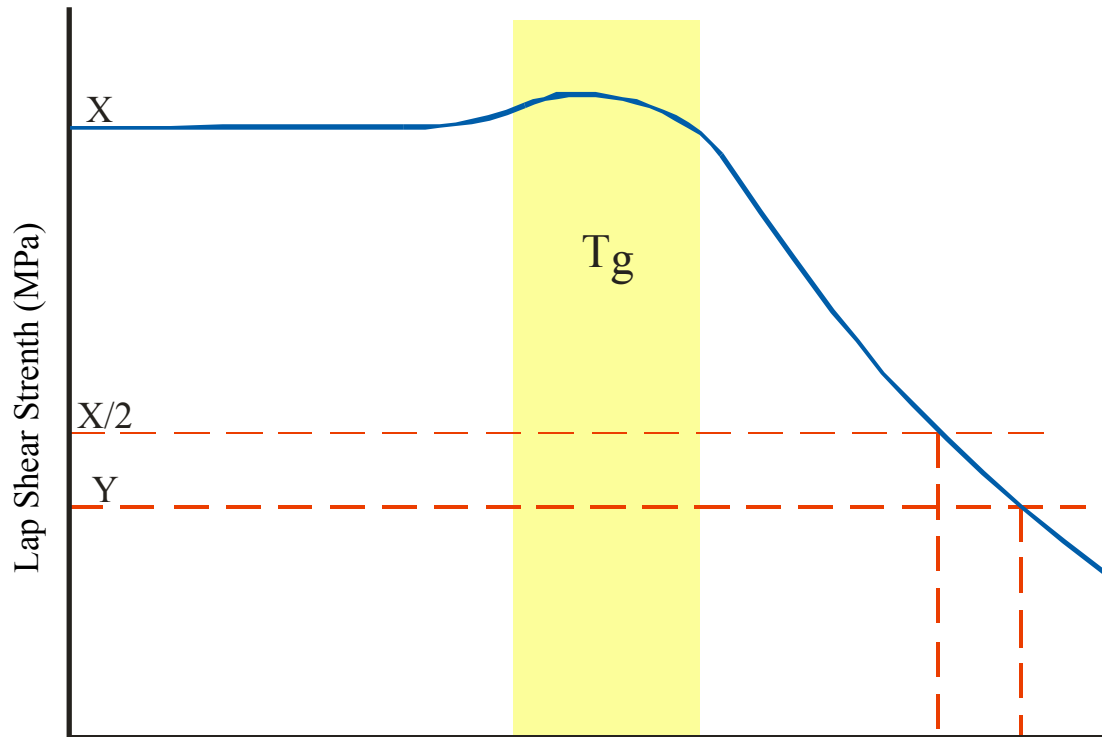

Figure 7.3-1 – Environment: Elevated temperature response of adhesive lap joints

7.3.1.4 Adhesive glass transition temperature

Adhesive manufacturers rarely state the **glass transition** temperature, T_g , of an adhesive because an adhesive can have a range of possible curing temperatures that influence the T_g value obtained. At the T_g , the adhesive still offers a high level performance; possibly offering its highest strength because of relief of residual thermal stresses from the initial cure.

As the T_g is exceeded, there is a gradual softening of the adhesive and the lap shear strength begins to decrease. This is followed by a region where the adhesive continues to offer useful shear strengths. The retention of 50% of initial strength is one way of presenting the performance. An alternative way is stating the temperature at which 15 MPa is retained.

The retained level of shear strength at elevated temperature is important. A lower level of shear strength, compared with **RT**, provided by the adhesive at elevated temperature can be sufficient for a particular joint design.

When bonding composites, the shear strength of the adhesive exceeds the **shear strength** of the laminating resin. As the temperature increases, the balance of shear strengths between adhesive and resin still favours the adhesive for a while.

7.3.1.5 Moisture

Adhesives, and their hardeners and catalysts, can absorb moisture before and after cure, although the rate of absorption varies between formulations, [See: Chapter 6]. The effects include:

- Moisture reducing the **glass transition** temperature, T_g , of the adhesive,
- Combined hot-wet conditions causing loss of performance,

- **Durability** of joints, where moisture affects the adhesive or the adherend-to-adhesive interface,
- In space, moisture affects the **outgassing** characteristics.

7.3.1.6 Chemicals

Different adhesives have different tolerances to chemicals. Contaminated adherend surfaces affect the resulting bond strength. Pre-bonding surface preparation methods are crucial, [See: 12], especially for in-service bonded repairs, [See: 19].

7.3.2 Space environment

7.3.2.1 General

Resistance to the space environment is particularly demanding and involves factors not usually found in earth-bound applications.

The particular aspects to consider are:

- Vacuum,
- Particle radiation,
- UV radiation,
- Elevated temperature,
- Low temperature,
- Thermal cycling,
- Joint loading modes.

[See: ECSS documents: ECSS-Q-ST-70; ECSS-Q-70-71 ; [22-8] for ECSS standards]

7.3.2.2 Vacuum outgassing

Exposure to vacuum promotes the **outgassing** of any low-vapour-pressure components in the cured adhesive, such as:

- Unreacted compounds,
- Volatile contaminants,
- Low-molecular-weight constituents,
- Light reaction products of adhesives.

In general, adhesives are exposed to the atmosphere only at the edge of the **bondline**, so **outgassing** rates through this small surface are normally low.

Outgassing can affect bondline integrity by a number of deleterious effects:

- In extreme cases, if liberated products do not vent, the build-up of pressure can separate the adherends,
- The evolved gases can condense to contaminate other surfaces of the spacecraft, e.g. electrical components, optical devices.

7.3.2.3 Offgassing

In manned structures, any substances liberated (**offgassed**) that are harmful to the crew should be avoided.

Some general points can be made for the selection of adhesives for space with respect to a vacuum are:

- Consider adhesive formulation. Adhesives with low service temperatures tend to evolve contaminants at low temperatures under vacuum,
- Avoid adhesive products which are emulsions or solutions. Use products quoted as 100% solid,
- Confirm that outgassing properties derived from evaluation tests are appropriate to space,
- Confirm for a manned spacecraft, that no harmful effects can arise from **offgassing** of the adhesive.

7.3.2.4 Particle radiation

The adhesive is usually protected by the adherends, so particle radiation is not usually considered harmful. The combined effects of particle and UV radiation should be considered for surfaces that directly exposed to space.

7.3.2.5 UV radiation

UV is usually relevant to optical adhesives, which can darken on exposure. For structural applications, the adhesive is usually protected by the adherends. Combined particle radiation and UV exposure can increase outgassing rates of adhesives.

7.3.2.6 Elevated temperature

The upper service temperature depends largely on the basic type of the adhesive and its formulation. Typical maximum service temperatures are given in Table 7.3-1 for the various groups.

Table 7.3-1 - Adhesives: Typical maximum use temperatures

Adhesive type	Typical maximum temperature, °C (Short-term, dry)
Epoxy	93
Epoxy-polyamide	149
Epoxy-nitrite	121
Epoxy-novolac	176
Epoxy-phenolic	204
Polyimide	300
Bismaleimide	260
Silicone	300

Moisture reduces the **T_g** of adhesives, and service temperatures under hot-wet conditions are much reduced from the short-term, dry values stated. More precise data for a particular product

can be derived from tests conducted by either independent bodies or the manufacturer, [See also: 6.3 for **epoxy**-based adhesives].

Service temperature is often quoted in manufacturer's literature as that temperature at which the retained shear strength is 6.89 MPa (1000 psi) as determined by testing to the ASTM D1002, [See: 15]. This criteria depends on the particular design case under consideration.

7.3.2.7 Low temperature

At low temperatures most adhesives stiffen and bonds become brittle. Those having greater ductility at low temperatures normally have poorer properties at temperatures above ambient.

For specialist **cryogenic** applications some polyurethane- and **silicone**-based products are appropriate, [See: 6.6, 6.7]. Specific products usually have guidance notes produced by manufacturers. Data can be confirmed by means of testing. Silicone-based products are preferred if flammability is a concern.

7.3.2.8 Thermal cycling

Orbiting space structures experience thermal cycling, under vacuum, as they move in and out of the Earth's shadow, [See: ECSS-Q-ST-70-04: Thermal testing for the evaluation of space materials, processes, mechanical parts and assemblies].

Mismatch in thermal expansion characteristics between the adherends, or at the adhesive-to-adherend interface, causes loading within the joint assembly. In good design practice these are minimised, but the ability of the adhesive to flex to accommodate dimensional changes is important.

For dimensionally-stable structures, such as satellite dishes, careful design and adhesive selection is of paramount importance.

[See also: 6.3 for environmental durability evaluations of epoxy-based adhesives]

7.3.2.9 Joint loading modes

The actual loads experienced in an adhesive joint come from the combined effects of:

- Externally-active static loads, e.g.:
 - tension,
 - compression,
 - bending,
 - shear.
- Externally-active cyclic loads:
 - vibration,
 - fatigue,
 - acoustic.
- Cyclic or static thermal loads - variations in service temperature,
- Properties of the adhesive and adherends,
- Joint design details.

For the selection of an adhesive, the basic mechanical properties needed are:

- Tensile strength,
- Tensile modulus,
- Shear strength,
- Shear modulus,
- Peel strength.

The effects of the environment, especially long-term exposure, on each of these properties is also necessary. Often a supplier is not able to state the full range of properties and a complete evaluation programme is needed.

[See also: 15 for test methods]

7.4 Pre-application selection factors

7.4.1 Joint design

Knowledge of several factors is necessary for a successful design of:

- Type of materials to be joined (adherends), including details of their properties and manufacturing route,
- Surface preparation, applicable for the adherends, [See: 12],
- Use of **primers**, [See: 12],
- Joint configuration, [See: 8],
- Adhesive properties, [See: 6].

7.4.2 Adhesive systems

7.4.2.1 General

Structural adhesives are classified physically into either two major groups:

- Pastes and liquids, or
- Film adhesives

7.4.2.2 Primers

Some adhesives have primers recommended by the manufacturer. These are applied to the adherends after the surface preparation and before the adhesive. The role of a **primer** is to protect the prepared surface from contamination before bonding and to promote adhesion.

Primers can be:

- Dilute solutions of the base adhesive, often containing corrosion inhibitors,
- Organo-functional silanes.

Recent environmental legislation has promoted further developments in primers, including:

- water-based primers, to reduce use of solvents, Ref. [7-3], [7-4], [7-5].
- non-heavy-metal-containing primers, e.g. Cr and Cd, Ref. [7-9].

7.4.2.3 Pastes and liquids

These can be either:

- One-part, or
- Two-part (resin and hardener).

Two-part adhesives need accurate metering and thorough mixing before application. They differ in their viscosity and some exhibit thixotropic behaviour. The consistency of the adhesive determines its ability to fill gaps or accommodate minor mismatch of components. Some adhesives contain filler phases, which are often added to base adhesive resins during the mixing stage. Examples of fillers include:

- Bulking agents and viscosity modifiers; usually inorganic fibrous or particulate materials. Asbestos fillers are not acceptable,
- Glass spheres (microballoons) are common; to assist in controlling the bondline thickness,
- An electrically- or thermally conductive phase, often aluminium or silver powder, making the cured adhesive conductive.

7.4.2.4 Film adhesives

Film adhesives are 'one-part' and can be:

- Unsupported, i.e. a thin sheet of adhesive only,
- Supported, i.e. applied to a thin fibrous carrier to improve handling and bondline control, and also to reduce galvanic effects (for mixed metal and carbon fibre bonded assemblies).

The type of carriers varies between woven, mat and knitted textiles. The thickness of carrier affects the final bondline thickness.

High-temperature adhesives tend to use glass as the carrier material, whereas epoxy-based films usually use nylon.

Film adhesives are supplied with a protective liner on one or both sides which is removed completely prior to assembly.

7.4.2.5 Foaming adhesives

Some adhesives are formulated to have foaming properties. Their volume increases greatly during the cure cycle. Typical expansions are in the range 1.3 to 5 times. Such adhesives are used as honeycomb core splicing materials because of their ability to fill gaps and voids.

7.4.3 Environmental factors

7.4.3.1 Moisture

In the uncured state some constituents of adhesives, particularly hardeners, are sensitive to moisture. This can affect the cure and influence the final properties of the bond. Therefore the stipulated storage conditions are crucial.

7.4.3.2 Storage

Manufacturers state shelf-lives as a time at a given storage temperature. For a given product, the shelf-life can vary depending on the packaging method or the quantity contained. Adhesive systems, classed as limited **shelf-life** materials, need control in accordance with ECSS-Q-ST-70-22 [See: ECSS documents]. Adhesives removed from cold storage need to warm slowly to room temperature before use. When cold, paste adhesives can be too viscous to mix properly and film adhesives can lack sufficient tackiness. Moisture condensation and contamination during the warming up period should be prevented.

7.4.4 Cost factors

7.4.4.1 Materials

The cost of adhesives is normally low compared with the overall cost of the bonded assembly. However, some adhesives with specialised properties can be expensive. Adhesive costs are quoted by weight for liquid and **pastes** and by area for **film** types.

7.4.4.2 'In-place' cost

The overall cost of adhesive can be determined on the 'in-place' cost per unit area of cured **bondline**, which includes:

- Material cost,
- Waste,
- Bondline thickness,
- Processing cost, including process control,
- Tooling.

7.4.4.3 Equipment

Depending on the complexity of the assembly, tooling and processing can be expensive. Non-destructive evaluation of finished assemblies can also add a large cost element, Ref. [7-6].

7.5 Application

7.5.1 Method

7.5.1.1 General

There are many practical methods for applying adhesives to adherends, but they all fall into one of two broad classifications, [See: 13].

7.5.1.2 Secondary bonding

Curing of the adhesive between fully-cured adherends (composites) or between metal adherends.

7.5.1.3 Co-curing

The adhesive cure is concurrent with that of the composite structure. A derivative process, known as 'co-bonding', involves lay-up of prepreg material, with or without an adhesive film, upon an already cured laminate or metallic part. This is then cured to form a bond.

7.5.1.4 Selection of process method

The selection of the processing method for a particular bonding case depends on many factors, including:

- The number of components to be produced,
- Joint complexity,
- Relationship between the joint and other parts of the structure,
- **Adherend** and adhesive properties,
- Details of the adhesive **cure schedule**,
- Environmental demands.

7.5.1.5 Automation

Space structures tend to have their own unique characteristics and are only produced in small numbers, therefore opportunities for automation are limited. Consequently most secondary adhesive bonding for space structures tends to be labour intensive. The greater the number of components being produced, the greater the likelihood of reducing cost by automation.

[See also: 21.7 for the design-development of adhesive bonding for serial production of an Ariane 5 large structure]

7.5.1.6 Manual

Equipment exists to aid the manual application of adhesives, e.g. 'gun-type' systems for placement of both one- and two-part paste adhesives.

Film adhesives need careful handling procedures, similar to those for prepregs, e.g. stringent control of temperature, relative humidity, removal of air-borne debris, removal of backing sheets.

7.5.2 Cure factors

7.5.2.1 General

Precise details of adhesive **cure schedules** are stated by the adhesive manufacturers.

7.5.2.2 Secondary bonding

Some typical cure schedules for secondary bonding are given in Table 7.5-1. In the case of sandwich constructions, the consolidation pressure is less than the core strength.

Curing of secondary bonded items can be done in ovens, or in situ with heating pads and blankets.

[See also: 19 for uses of secondary bonding for repairs]

Table 7.5-1 - Typical cure schedules for aerospace structural adhesives

Adhesive Group [Form]	Cure Schedule ⁽¹⁾		
	Temperature, °C	Time	Pressure ⁽²⁾⁽³⁾
Epoxy [Paste]	RT	1 to 7 days	Low
	50 to 120	1 hour	Low/Moderate
Modified Epoxy [Film]	125 to 175	Several hours	Moderate/High
Phenolic	~150	Several hours	Moderate/High
Polyimide	250 to 350	Several hours	Moderate/High
Bismaleimide	175	Several hours	Moderate/High
Silicone	RT	Several days	Moderate/High
Key: (1) For comparative purposes only. For specific adhesives, the manufacturer's stipulate cure schedules. (2) Low: 2 kg cm ⁻² ; Low/Moderate: 2 to 5 kg cm ⁻² ; Moderate/High: 5 to 20 kg cm ⁻² (3) Sandwich constructions: The consolidation pressure is less than the core strength.			

7.5.2.3 Co-curing

Different thermosetting materials are cured simultaneously to form a laminate or assembly. For co-cured joints, the adhesive is selected to have a cure schedule which matches as closely as possible that of the matrix resin of the composite.

Co-curing of assemblies using **film** adhesives is usually conducted in an autoclave.

7.5.2.4 Cure temperature

Depending on the generic type and formulation, structural adhesives cure at, [See also: Table 7.5-1]:

- room temperature (RT), or
- elevated temperature.

7.5.2.5 Cure pressure

Pressure is usually applied during cure. For **paste** adhesives, the loading can just be sufficient to keep the adherends in contact. Higher cure pressures are needed for film adhesives, especially for the **-imide**-based adhesives, [See also: Table 7.5-1].

7.5.2.6 Cure time

The cure time for some **RT** adhesives can be greatly reduced by increasing the cure temperature.

7.5.2.7 Post-curing

Some adhesives are post-cured. In this, the temperature is normally higher than the initial cure temperature, but no external load or pressure is applied. The bonded components are normally free-standing in ovens. A post-curing treatment can greatly reduce any subsequent offgassing of the adhesive.

The post-cure of **-imide**-based adhesives is crucial to their final properties.

7.5.2.8 Cure environment

Cleanliness and contamination control is needed for adhesive bonding operations, [See: ECSS documents: ECSS-Q-ST-70-01]:

- Uncured adhesives are sensitive to moisture.
- Extraction is needed to remove dust, odours and vapours.

7.5.2.9 Pot life

Pot life applies to liquid and paste adhesives which, once mixed, or applied, begin to cure. Pot life is the time before the adhesive gels and becomes unworkable. This then gives the maximum time available to make an assembly. Values quoted by manufacturers for two-part adhesives are usually for a stated mixed quantity.

When mixing adhesives with short pot-lives, small mix volumes or shallow open dishes are often necessary to prevent rapid build-up of heat from the exothermic cure reaction.

7.5.2.10 Working life or out-time

Out-time applies to film adhesives which, after warming to **RT**, begin a slow cure reaction, reducing handling properties such as tack. It is the time available to apply the adhesive and assemble the component parts of the assembly; the equivalent of 'pot life' for paste adhesives.

7.5.3 Health and safety

7.5.3.1 General

National or European legislation is incorporated into the working practices of all organisations; including the handling of chemicals and materials with possible toxic effects on workers and the provision and use of appropriate safety equipment.

7.5.3.2 Surface preparation

Suppliers provide safety sheets on their products. Handling of chemicals and the safe extraction of fumes and vapours is extremely important. Some general guidelines on the handling of materials include:

- chemicals used to prepare metal adherends are often mixtures of strong oxidising agents, are very corrosive and are likely to contain toxic or carcinogenic materials.
- solvents are used to clean composites and metals and these are usually volatile, dangerous to breathe and often inflammable.
- **primers** tend to be solvent-based with a large volatile content which need extraction.

7.5.3.3 Adhesives

Suppliers provide safety sheets on their products. Some general guidelines on the handling of materials include:

- some of the organic compounds used in adhesives and hardeners or catalysts can cause severe skin and eye irritation.
- vapours and odours released need extraction.

7.6 Adhesive screening criteria for space

A number of adhesives have undergone full evaluation to assess their acceptability for use in space, Ref. [7-7].

An adhesive evaluation programme by Lockheed Missiles and Space Co. determined a set of adhesive selection criteria based upon the properties needed for space materials, Ref. [7-8]. Points are awarded against the adhesive properties determined by standard test methods. The structure of the points system is shown in Table 7.6-1, Ref. [7-8]. The approach enables a direct comparison of a large number of potential adhesive materials. Testing defines some basic properties for design purposes.

The approach described is not a full evaluation process. The testing of bonded assemblies and whole structures is needed to assess structural integrity, [See also: 15].

Table 7.6-1 - Adhesive selection criteria: Based on bulk property testing

Property	Criteria	
	Value	Points
Tensile strength (MPa)	>62.0	4 max.
	51.7 to 62.0	3
	41.4 to 51.7	2
	34.5 to 41.4	1
Tensile elongation (%)	>10	4 max.
	5 to 10	3
	3 to 5	2
	1 to 3	1
Vacuum outgassing (%) ⁽³⁾	<1 TML ⁽¹⁾	1
	<0.1 VCM ⁽²⁾	3
		4 max.
Glass transition temperature, T _g (°C)	>121	3 max.
	102 to 121	2
	82 to 102	1
Coefficient of thermal expansion, CTE (10 ⁻⁶ °C ⁻¹)	22 to 28	1
	<22	2 max.
Water absorption (%)	0.3	1 max.
Density (g cm ⁻³)	<1.30	1 max.
Key: (1) TML: Total mass loss (2) VCM: Volatile condensable matter; now CVCM (3) NASA/SRI requirements 125 °C and 10 ⁻⁵ torr vacuum for 24 hours. ECSS-Q-ST-70-02 ASTM E595		

7.7 References

7.7.1 General

- [7-1] 'What to Look for when Selecting Structural Adhesives'
Machine Digest, 7th August 1986, p59-62
- [7-2] ECSS-Q-ST-70-04: Thermal testing for the evaluation of space materials, processes, mechanical parts and assemblies
- [7-3] J. J. Mazza & R.J. Kuhbender: Wright-Patterson AFB/Uni. of Dayton, USA
'Evaluation of a Low VOC Corrosion Inhibiting Adhesive Primer'
Proceedings of 37th International SAMPE Symposium
9-12 March, 1992, p409-420

- [7-4] R.J. Kuhbander & J. Mazza: Uni. of Dayton Wright-Patterson AFB
USA
'Understanding the Australian Silane Surface Treatment'
Proceedings of 38th International SAMPE Symposium
10-13 May 1993, p1225-1234
- [7-5] D.E. Sweet: BASF Structural Materials, USA
'Metlbond X6747 100% water-based Primer for Aerospace Bonding
Applications'
Proceedings of 38th International SAMPE Symposium
10-13 May 1993, p1241-1253
- [7-6] Dr. L.J. Hart-Smith: McDonnell Douglas Aerospace, USA
'How to get the Best Value for each Dollar spent Inspecting
Composite & Bonded Aircraft Structures'
Proceedings of 38th International SAMPE Symposium
10-13 May 1993, p226-238
- [7-7] ECSS-Q-70-71: Data for the selection of space materials and processes;
previously ESA PSS-01-701
- [7-8] B.J. Mulroy Jnr & D.M. Mazenko: Lockheed Missiles and Space Co.
'Structural Adhesives for Space Systems'
Proceedings of Conference on 'Structural Adhesives and Bonding'
California, March 15-17, 1979, p340-359
- [7-9] EADS – Space Transportation
Presentation: 'The problem of Cr6 and Cd interdiction of use'
Supplied 2005.
- [7-10] JR Williamson et al: ESTEC TEC-QMC, NL
'An Overview of Recent Adhesive Bonding Programmes Conducted
Within ESA's Materials Physics and Chemistry Section (TEC-QMC)
Proceedings of European Conference on Spacecraft Structures,
Materials & Mechanical Testing 2005 Noordwijk, NL, 10 – 12 May
2005, ESA SP-581 (August 2005) CDROM

7.7.2 ECSS documents

[See: [ECSS website](#)]

ECSS-Q-ST-70	Materials, mechanical parts and processes
ECSS-Q-70-71	Data for the selection of space materials and processes
ECSS-Q-ST-70-01	Cleanliness and contamination control
ECSS-Q-ST-70-02	Thermal vacuum outgassing test for the screening of space materials
ECSS-Q-ST-70-04	Thermal testing for the evaluation of space materials, processes, mechanical parts and assemblies
ECSS-Q-ST-70-21	Flammability testing for the screening of space materials
ECSS-Q-ST-70-22	Control of limited shelf-life materials

7.7.3 Other standards

NASA-STD-6001

Flammability, odor, offgassing and compatibility requirements and test procedures for materials in environments that support combustion; previously NASA NHB 8060.1 (parts A and B).

8

Basic joint types

8.1 Introduction

When designing a joint, the first decision is whether to adhesively bond or to mechanically fasten, or use a combination of both, [See: 8.2]. The decision is made with regard to the:

- whole structure (global basis), and
- specific needs of joining the components (local basis).

There are preferred design practices associated with the lay-up of composite adherends to be bonded, again this emphasises the need to evaluate globally, [See: 8.4].

The basic factors and decisions associated with the design of adhesively bonded joints are described in paragraphs below [See: 8.2; 8.3].

8.2 Bond or mechanically fasten

8.2.1 General

The decision between bonding and fastening depends upon a number of factors arising from the overall design of the structure.

Table 8.2-1 summarises some of the benefits and drawbacks associated with bonding, fastening and mixed methods.

Table 8.2-1 - Comparison of joining methods: Fastening and bonding

Advantages	Disadvantages
Mechanical Fastening	
<ul style="list-style-type: none"> * No special surface preparation needed or ultra-clean handling operations. * Strength not adversely or irreversibly affected by thermal cycling or high humidity. * Presents no unusual inspection problems for joint quality. * Can be disassembled easily, without destruction of the adherends. 	<ul style="list-style-type: none"> * Machining of holes in the composite, so weakening the part. * Concentrates stress on the bearing surfaces, causing 'stress-raisers' that can initiate failure. * Not generally as strong as bonded joints - unless joining thick laminates. * Increases the weight of the assembled structure, reducing joint efficiency. * Honeycomb selection is often dictated by fastener sizes. * Protruding fasteners can disrupt aerodynamic surfaces.
Adhesive Bonding	
<ul style="list-style-type: none"> * Distributes load over a larger area than mechanical joints, reducing average stress and stress concentration. * Machining in joint area can be avoided, so the adherends are not weakened. * Minimises added weight to structure. * After first loading, bonded joints show less permanent set than equivalent mechanical joints. * Good elevated temperature creep resistance with correct adhesive selection. * Enables design of smooth external (aerodynamic) surfaces. * Creates integrally sealed joints with low sensitivity to crack propagation. * Large areas of bonded joints are often less costly than mechanical joints. * Enables assembly of dissimilar materials prone to galvanic corrosion, given consideration of any differences in thermal expansion (thermal stresses). 	<ul style="list-style-type: none"> * More difficult to inspect completely by non-destructive testing (NDT). * Careful design needed to eliminate peel loadings. * Accurate mating of adherends needed to give efficient structural bonds. * Permanent - not easily disassembled. * Thermal cycling and high humidity can affect the strength. * Special surface preparation needed and clean handling prior to bonding.
Bonded and Fastened	
A combination of joining methods can be beneficial in that the disadvantages of one method can be offset by advantages of the other. In addition:-	
<ul style="list-style-type: none"> * Useful if peel loads cannot be reduced to levels acceptable for solely bonded joints. * Improved thermal cycling and humidity resistance over solely bonded joints. * Integrally sealed. 	<ul style="list-style-type: none"> * Cannot be easily disassembled. * Increased weight. * Bonding and fastening operations can increase the production costs.

8.2.2 Adhesive bonding in the space industry

For the types of materials generally encountered within the space industry, Ref. [7-1], adhesive bonding is often the most appropriate method of joining because of:

- a high proportion of the materials consist of advanced composites,
- metals tend to be light alloys with high specific strength properties, e.g. aluminium or titanium,
- structural materials tend to be thin for weight-efficiency reasons,
- joints between adherends tend to be composite-to-composite, or composite-to-metal in **honeycomb** structures,
- space structural designs usually cannot tolerate the weight penalties associated with fasteners,
- smooth surfaces are necessary for aerodynamic or signal transmission purposes, e.g. antenna dishes,
- some components cannot be satisfactorily joined by any other means, e.g. composite face skins to honeycomb cores,
- the bearing strength of composites is lower than that of metals, demanding large footprint fasteners.

In order to achieve a joint that can satisfy the loading and environmental demands, a combined design and material selection process is rigorously applied.

8.3 Loading modes

Table 8.3-1 summarises the basic loading modes for adhesives in bonded joints and comments on the resulting types of stresses. The configurations shown represent idealised conditions.

In practice, it is difficult to achieve a single stress mode, i.e. tensile shear. The geometry of the joint and the directions of applied loads can cause one or more other stress modes to occur. These can be reduced by design of joint details, [See: 8.4].

The construction of composite adherends, i.e. number and orientation of plies, is also reflected in the stress modes and levels experienced by the joint, [See also: 8.4].

Table 8.3-1 - Basic loading modes in adhesive bonds

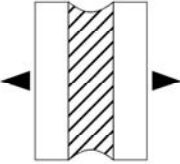
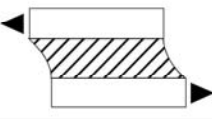
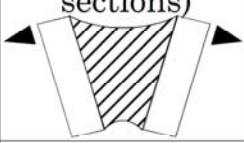
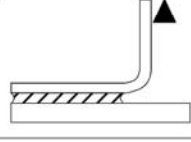
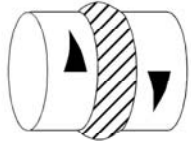
LOADING MODE	COMMENTS
Tensile 	BAD - Strength of joint relies on through-plane tensile strength of composite adherend. This is a resin dominated property, hence low strength. Can be tolerated in some situations.
Tensile-Shear 	GOOD - Whole of the bond area can be used to distribute applied load. Providing the shear stress within the joint is less than the failure shear stress of the composite adherend resin, the joint will be stronger than the composite members.
Cleavage (Thick sections) 	BAD - Strength of joint relies on through-plane tensile strength of composite adherend. This is a resin dominated property, hence low strength. Peel loadings cause large stress concentrations in the bond. Bond area not fully utilised for load distribution.
Peel (Thin sections) 	BAD - Strength of joint relies on through-plane tensile strength of composite adherend. This is a resin dominated property, hence low strength. Peel loadings cause large stress concentrations in the bond. Bond area not fully utilised for load distribution.
Torsion 	BAD - Relies on the shear properties of the adhesive. The shear stress distribution is high on external surface and lower in centre. Adhesive bond is the weak link between two materials (composites) with higher intrinsic properties (discontinuous fibre reinforcement across bond). Butt joints should be avoided in design of joints especially with composites.

8.4 Tensile shear loading

8.4.1 General

Transfer of load by tensile-shear is known to be the most beneficial method in terms of maximising the strength of the joint region. There are many ways of creating a joint with this capability, with various levels of geometric complexity.

8.4.2 Joint geometry

8.4.2.1 General

The simplest form is an overlap joint, as shown in Figure 8.4-1. A major problem with this simple design is that under tensile loading a rotational effect is experienced by the adherends as they move to provide the longest possible load path. This creates **peel** loading at the free edges of the adherends. There are, however, ways of altering the geometry to reduce any peel stress concentrations.

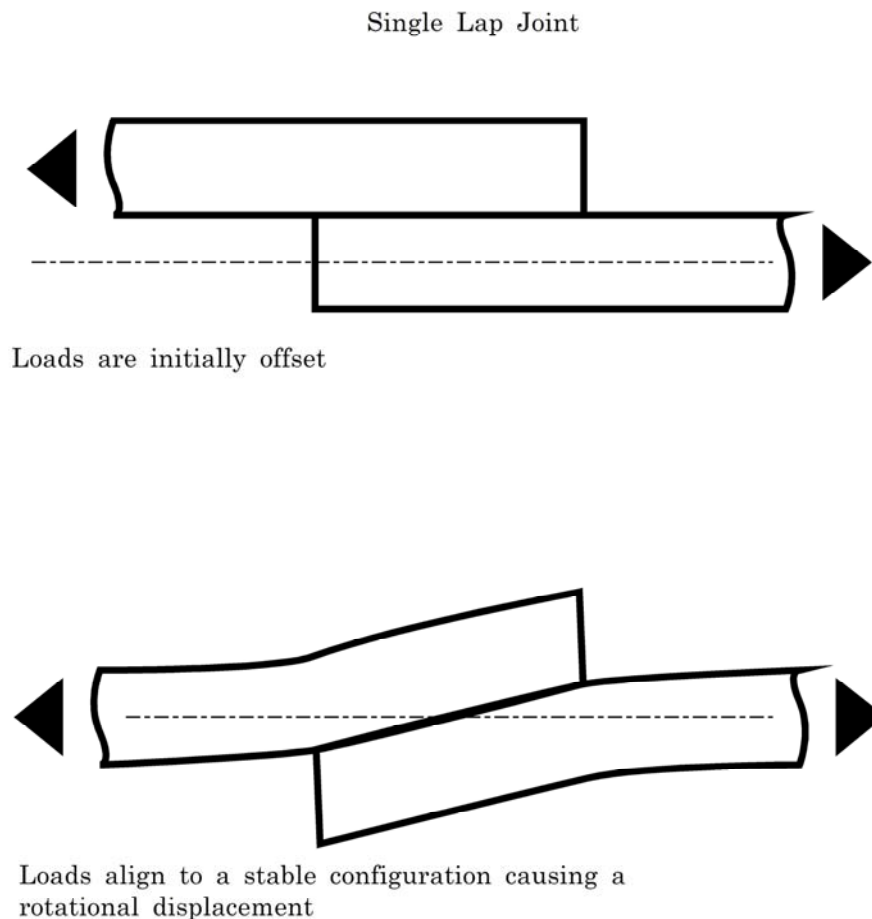

Figure 8.4-1 - Tensile shear: Single lap joint











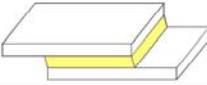
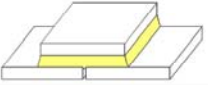
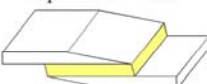
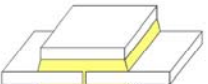
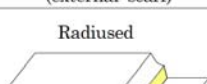
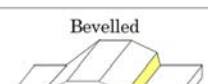
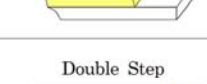
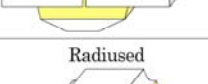
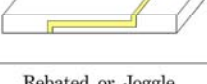

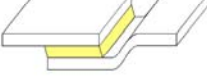
8.4.2.2 Peel

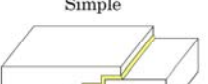
Methods of reducing peel loads are illustrated in Table 8.4-1 which introduces and describes other conceptual joint geometries and aspects of their advantages and disadvantages.

Some of these joint configurations are theoretical and are not viable in real applications.

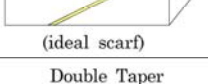
[See also: 9 for joint selection; 10 for theory and design practices]

Table 8.4-1 - Types and geometry for adhesive bonded joints

	JOINT TYPE	COMMENTS		JOINT TYPE	COMMENTS
Single Lap Joints	Simple 	Simplest bonded joint, but suffers from offset load path with associated stress concentration and peel.	Strapped Joints	Single 	Similar principle to single lap joint. Bending and peel experienced due to stiffness mismatch and central discontinuity in adherends.
	Taper or Bevelled (external scarf) 	Tapers reduce stress concentration.		Double 	Similar principle to double lap joint. Reduces bending and peel seen with single strap. Central discontinuity in adherends.
	Radiused 	Radii reduce stress concentration.		Bevelled 	Bevels reduce stress concentration.
	Double Step 	Minimises joint weight but lowers joint strength due to discontinuity in laminate.		Radiused 	Radii reduce stress concentration.
	Rebated or Joggle 	Alignment of adherends to avoid offset load path, but 'kink' may compromise strength.		Recessed Double 	Discontinuity between strap and adherends, plus central discontinuity between adherends. Thinning of adherends to accept recessed straps reduces strength
	Stepped 	Discontinuity in laminate (see Double Step).			
Double Lap Joints	Simple 	Eliminates majority of bending and peel stresses found with single simple overlap.	Stepped Lap	Simple 	Increased bond area. Discontinuity at external edges plus at ends of internal steps.
	Bevelled 	Bevels reduce stress concentration.		Recessed 	As above, but recessing creates smooth external surface.
	Radiused 	Radii reduce stress concentration.			
Bonded Doublers	Single Sided 	Provides localised thickening and stiffening. Similar transfer in bond to simple single lap.	Scarf	Single Taper (ideal scarf) 	Increased bond area. Avoids discontinuities in stepped lap geometry.
	Double Sided 	Provides localised thickening and stiffening. Similar transfer in bond to simple double lap.		Double Taper 	Increased bond area compared to single taper.
				Increased Thickness Scarf 	Increased bond area. Thicker adherends in bond area increase strength of joint zone.
			Landed Scarf 	Increased bond area, but discontinuity at lands.	

8.4.3 Composite adherends

8.4.3.1 Effect of fibre orientation

When designing a bonded joint with a composite adherend, the shear load transfer in the main load direction is usually engineered to coincide with that of the fibre orientation on the outer surface of a UD unidirectional laminate; UD is the most likely construction in space structures. If a fabric is present, the properties are similar in both directions.

Figure 8.4-2 shows the orientation of fibres for some joint configurations, Ref. [8-2].

In dimensionally stable structures, the fibres cannot always be aligned in the optimum direction at the bond interface. Consequently, the bond strength in a transverse laminate (90°) is limited by the transverse strength and strain to failure of the resin-to-fibre interface within the composite. This can be significantly lower than that of the adhesive.

Table 8.4-2 gives some typical transverse (90°) tensile strengths for some aerospace carbon-reinforced UD products.

The resin-dominated laminate properties in the 90° direction are avoided, wherever possible, in order to obtain a bonded joint with a predictable, reproducible strength which preferably fails cohesively within the adhesive layer.

8.4.3.2 Composite shear strength limitations

The **shear strengths** of resins in laminates are lower than adhesives. If the shear stresses in the bonded joint are too high, failure occurs in the composite. For fabric and unidirectional fibre laminates, a thin layer of resin with fibres is sheared from the surface.

Lap shear strengths of laminate resins can be in the order of 15 MPa to 25 MPa, whereas adhesives are typically 30 MPa to 45 MPa. It is appropriate to design joints between composites to the weaker phase by applying a limiting shear stress level. A correct joint design minimises local peak shear stress to take account of this.

The shear strength of composites reduces as the modulus of the carbon fibre increases. Consequently ultra-high modulus M55J fibres have lower shear strength values compared with high strength (HS) carbon fibres, e.g. T300 or Tenax HTS. It is usual to establish the actual lap-shear strengths of each adhesive-composite combination used in a construction and use these values in the design.

	ORIENTATION OF SURFACE FIBRE	
	CORRECT (Fibres in bonded layers are parallel to the load)	INCORRECT (Fibres in bonded layers are perpendicular to the load)
TRANSVERSE SHEAR		
TENSILE SHEAR		
TENSILE SHEAR		
TENSILE SHEAR		
TENSILE SHEAR		

Figure 8.4-2 – Composite adherends: Orientation of surface fibre

Table 8.4-2 – Composite adherends: Typical transverse (90°) tensile strengths for some aerospace carbon-reinforced UD products

Product: Resin system Applications	Cure, (°C)	Prepreg system (resin/fibre)	Cure schedule (Autoclave)	90° typical transverse tensile strength, (MPa)
<u>ACG - Advanced Composites Group</u>				
ACG HTM45: Epoxy High performance structural system	180	HTM45/HTS563 1	2 hours @ 180°C	53.9
ACG HTM552: Bismaleimide High performance structural system	190	HTM552/M46J	6 hours @ 190°C	27.1
		HTM552/T1000G B		53.7
ACG LTM123: Cyanate ester Low moisture absorbency	(1)	LTM123/M46J	16 hours @ 80°C +	21.4
		LTM123/M55J		19.7
		LTM123/T1000G B	2 hours @ 125°C	30.3
ACG MTM49: Epoxy General purpose aerospace	120	MTM49/M46J	1 hour @ 120°C	27.6
		MTM49/T800		34.9
<u>Hexcel Composites</u>				
Hexcel 8552: Epoxy High performance structural system	180	8552/AS4	2 hours @ 177°C	80.6
		8552/IM7		111.0
<u>Cytec</u>				
Cytec 977-6: Epoxy High performance structural system	180	977-6/M46J	2 hours @ 177°C	58.0
		977-6/M55J		36.0
		977-6/K139		25.0
(1) 'Versatile cure'				

8.5 References

8.5.1 General

- [8-1] ECSS-E-HB-32-20: Structural materials handbook; previously ESA PSS-03-203
- [8-2] M.M. Schwartz
'Composite Materials Handbook'
McGraw Hill, 1983.

8.5.2 Sources

[ACG](#) – Advanced Composites Group Ltd., UK

8.5.3 ECSS documents

[See: [ECSS](#) website]

ECSS-E-HB-32-20: Structural materials handbook; previously
ESA PSS-03-203

9 Joint selection

9.1 Introduction

The strength and **durability** of the bonded joint designs commonly used in aerospace structures are discussed:

- Strength, [See: 9.2].
- Fatigue resistance, [See: 9.3].
- Acoustic fatigue resistance, [See: 9.4].

Material limitations for the configurations are also shown, aiding the initial selection of joint type, [See: 9.2].

[See also: 10 for detailed design considerations]

9.2 Joint strength

9.2.1 Failure modes

9.2.1.1 Joint configuration

The predominant failure mode depends upon:

- Overlap length,
- Adhesive thickness,
- Fibre orientation in the layer of composite adjacent to the adhesive, [See also: 8.4].

9.2.1.2 Length-to-thickness ratio

Long overlaps with a thin adhesive film, giving a length-to-thickness ratio of 50, tend to produce tension or compression failures in the adhesive.

A length-to-thickness ratio of 25 tends to produce shear failures in the adhesives or interlaminar areas, depending on the joint configuration.

9.2.1.3 Failure load

The failure mode of a bonded joint has a profound effect on its failure load. The strongest joint designs tend to produce failures in the **adherend** adjacent to the bond. However, failure in an

adherend can sometimes be associated with a weakness or unfavourable local loading there, rather than the strength of the adhesive bond.

A pure shear failure in the adhesive, where the load is limited by the shear strength of the adhesive, is to some extent easier to recognise and a simpler criterion for design purposes.

The weakest failure modes are associated with:

- failure of the adhesive under **peel** loads,
- **adhesive failure** at the adherend-to-adhesive interface, often due to poor surface preparation,
- **delamination** of composite adherends (premature failure),
- fibre-to-resin interface failure (transverse UD plies), [See: 8.4].

9.2.1.4 Strength and adherend thickness

The relationships between strength and adherend thickness for different failure modes are:

$$P \propto t \quad \text{failure outside the joint}$$

$$P \propto t \quad \text{failure outside the joint}$$

$$P \propto t^{1/2} \quad \text{adhesive shear failures}$$

$$P \propto t^{1/4} \quad \text{peel failures}$$

$$P \propto t^{1/2} \quad \text{adhesive shear failures}$$

$$P \propto t^{1/4} \quad \text{peel failures}$$

where:

$$P \quad = \text{strength,}$$

$$t \quad = \text{adherend thickness.}$$

These relationships are illustrated in Figure 9.2-1, which also indicates the limitation of single lap joints where peel is prevalent, Ref. [9-1].

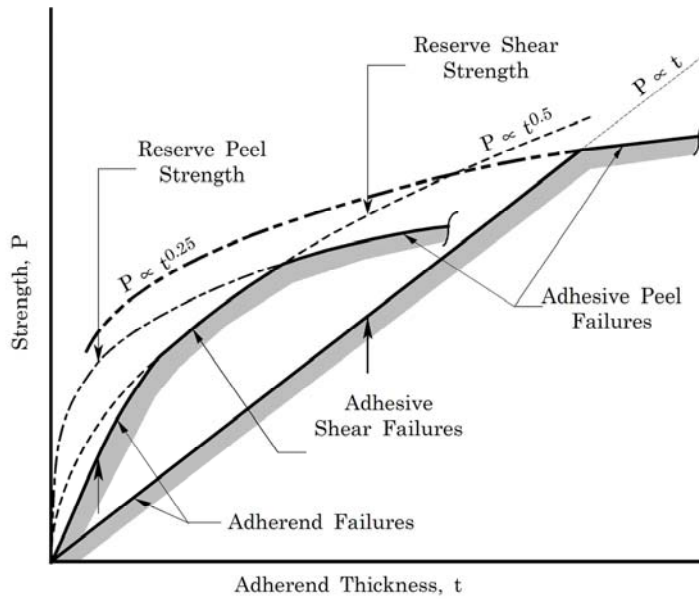

Relative Severity of Adhesive Shear & Peel Stresses

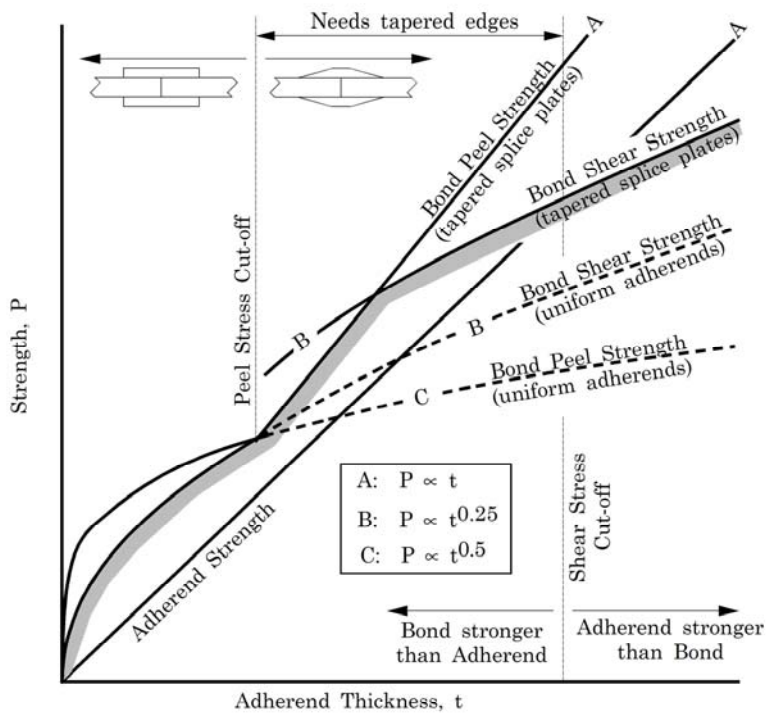

Effect of Adherend Thickness on Bond Strength

Figure 9.2-1 – Joint strength: Relationship between peel and shear stresses and their effect on bond strength with increasing adherend thickness

With increasing **adherend** thickness, different bonded joint designs become more favourable in obtaining maximum joint strength; as shown in Figure 9.2-2, Ref. [9-1].

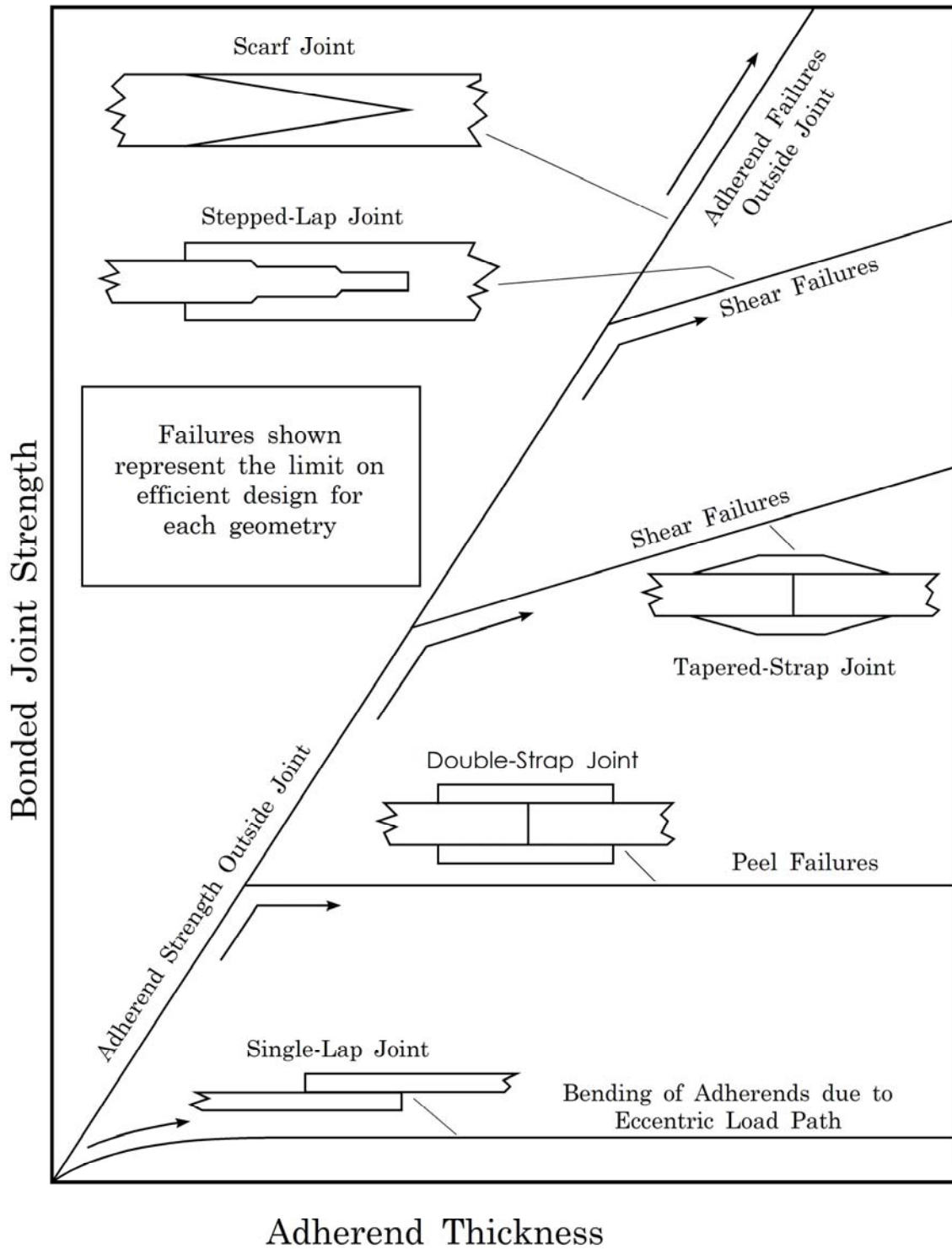

Figure 9.2-2 - Joint strength: Use of different bonded joint types

9.2.2 Guidelines

9.2.2.1 All bonded joints

Some general guidelines include:

- The shear strength of the adhesive is at least 50% greater than that of the **adherend**.
- At bond interfaces, the composite fibres are aligned in the primary load direction, [See also: 8.4].
- The adhesive **bond-line** thickness is:
 - 0.05 mm to 0.25 mm for adhesive **films**,
 - 0.05 mm to 0.5 mm for **paste** adhesives.

[See also: Tube fitting]

9.2.2.2 Single lap joints

Some general guidelines include:

- Appropriate for adherend thicknesses up to 1.75 mm for aluminium alloy or quasi-isotropic CFRP.
- Overlap-to-thickness ratio is between 50:1 and 100:1.
- An unsupported single **lap joint** can never be as strong as the adherend members.

9.2.2.3 Double lap and double strap joints

Some general guidelines include:

- adherend thickness limited to 4.5 mm for uniform double strap joint,
- thickness limit raised to 6.35 mm when using tapered splice straps,
- optimum overlap-to-thickness ratio of about 30:1.

9.2.2.4 Stepped or scarf joints

Some general guidelines include:

- the only appropriate joints for adherends thicker than 6.35 mm,
- for scarf joints, adherend tip thickness limits the strength,
- strength of stepped joints is dependent on the number of steps.

9.2.2.5 Bonded doublers

The load transfer through the adhesive in load-sharing bonded doublers is just as intense as in the case of a full-transfer bonded joint. The simplest and one of the most common joints for producing thickened sections, Ref. [9-1], its uses include:

- localised thickening for fastener seating,
- providing resistance to acoustic fatigue in thin metal structures,
- increasing the structural efficiency of stiffened structures subject to shear or compressive loads.

9.2.2.6 Tube fitting

Some basic design guidelines for a standard tube fitting design include:

- The fittings are made of machined metals; usually alloys of aluminium or titanium.
- The tubes are made of composite materials; usually CFRP or GFRP.
- The temperature range specified for the fitting largely determines the adhesive used for the fitting-to-composite bond, e.g. Hysol EA-9321 for cold temperatures, Hysol EA-9394 for elevated temperatures.
- The thermal environment and the relative thermal expansion coefficients of the composite tube and the metal fitting determine whether to attach to the inside or outside of the tube, in order to prevent an adhesive thickness increase due to thermal effects.
- Different tube-fitting configurations are commonly used, e.g.:
 - External single lap, where the fitting is bonded to the outside of the tube;
 - Internal single lap, where the fitting is bonded to the inside of the tube;
 - Double lap, where the fitting is bonded to the inside and outside of the tube.
- Stress concentration at the fitting and the tube edges is decreased with a bevelled design.
- An adhesive thickness of 0.2 mm is advisable.
- Testing of the tube-to-fitting joint design after thermal cycling is necessary.
- For preliminary dimensioning, the bond length is determined using a simple equation:
-

$$\tau \times l_{adh} = \sigma \times t_{tube} \quad [9.2-1]$$

where:

- τ *average adhesive shear stress;*
- l_{adh} *length of the bonded joint;*
- σ *tube maximum axial stress at the fitting location;*
- t_{tube} *tube wall thickness.*

9.2.3 Joint design

9.2.3.1 General guidelines

The primary points to consider include:

- The whole joint area withstands the the loads acting on the joint.
- The loads applied result mainly in shear stresses. Cleavage, peel and stress concentrations at free ends are either avoided or minimised.
- Optimise the thickness of the adhesive layer, [See: All bonded joints].
- Inspection of the joint during its life is crucial.

9.2.3.2 Joint strength

The maximising of joint strength needs to be balanced with the practicalities and cost of implementing a joint design within a component or structure. Attention to detail is necessary to fully maximise joint strength, Ref. [9-2], including:

- **Adherend** tapering,
- Adhesive fillets,
- Flared adhesive bond lines,
- Very low **scarf** angles,
- Fine adherend steps.

9.3 Fatigue resistance

9.3.1 General

The tolerance of adhesive bonds to cyclic loading is usually part of the design evaluation exercise for a particular application. During this evaluation, materials, manufacturing procedures, test samples (types and dimensions) and test conditions can vary considerably.

9.3.2 Joint evaluation

The ATR-72 aircraft development programme provided a more consistent picture of the fatigue resistance of certain bonded joint configurations, Ref. [9-3].

Details and dimensions of the configurations studied are shown in Figure 9.3-1, Ref. [9-3]. The bonded joints were identified as fatigue critical areas within the aircraft design specification.

Test Article	Specimen Configuration	Dimensions (mm)			
		Code	t_a	t_b	L/t_a
Single Lap		S22	0.81	0.81	10, 30, 50
		S44	1.02	1.02	10, 20, 30, 50
		S66	1.60	1.60	10, 30, 50
		S46	1.02	1.60	10, 30, 50
Double Butt-strap		Code	t	t_c	L/t
		D64 D62	1.60 1.60	1.02 0.81	10, 25, 40 25, 40
Hard Point		Code	t_a	t_b	
		H44	1.02	1.02	
		H45	1.02	1.27	
		H46	1.02	1.60	
H48	1.02	2.54			
Doubler		Code	t_a	t_b	A
		L78H	2.03	2.54	0
		L78L	2.03	2.54	10
		L78M	2.03	2.54	20
		L78N	2.03	2.54	40
		L41	1.02	0.63	0
		L42	1.02	0.81	0
		L44	1.02	1.02	0
		L45	1.02	1.27	0
L46	1.02	1.60	0		
Stringer Runout		Code	t	L	
		R3A	0.91	250	
		R4A	1.02	250	
		R4B	1.02	125	
R4C	1.02	0			
Stringer to Frame Attachment (pull up)		Not Stated			

Figure 9.3-1 - Fatigue resistance study: Bonded joint configurations

9.3.3 Factors influencing fatigue resistance

For the bonded joint types studied, Table 9.3-1 summarises the factors observed to influence their fatigue resistance, Ref. [9-3]. The number of cycles (105) is representative of the number of fuselage pressurisation cycles.

Table 9.3-1 - Fatigue resistance study: Factors relating to resistance of adhesively bonded joints

Joint Type	FATIGUE RESULTS	COMMENTS ON RESULTS
SINGLE LAP		<p>Alternating stress decreased approx. linearly with adherend thickness for $L/t = 10$. At $L/t = 30$ and 50 alt. stress is independent of joint thickness and overlap length.</p> <p>Lower fatigue strengths noted for adherends of different thicknesses with low L/t ratio.</p> <p>The optimum overlap length is approx. 30 times the joint thickness. Longer overlaps do not produce significant increases in strength but are likely to be required as a safety margin for bondline defects and corrosion effects.</p> <p>Shorter overlaps should be avoided.</p> <p>Mean stress (although having little effect on fatigue strength) influences the failure mode. High mean stress tends to promote adhesive failures.</p>
HARD POINT		<p>Halving the mean stress improved the fatigue strength by a nominal 10%.</p> <p>At 10^5 cycles fatigue strength was virtually independent of strap thickness but at 10^6 cycles progressive decrease in strengths was noted for greater strap thicknesses.</p>
DOUBLE BUTT STRAP		<p>No significant difference in fatigue strengths noted for joints at 10^6 cycles except for L/t ratio 10. This latter group also showed adhesive failure mode.</p> <p>Thinner strap materials allow flexibility (only minor effect for joints tested) and lowering of stress concentrations.</p>
DOUBLER		<p>The bevel reduces stress concentrations (20 mm length for this design). Thinning of doubler in bevel zone would assist but difficult in practise, likewise local adhesive thickening to create inner bevel is difficult to achieve practically.</p> <p>Secondary bevelling increases at one rate until the doubler and panel thickness are equal and increases at a reduced rate.</p> <p>Failures originated systematically ~10 mm from doubler corner.</p>
STRINGER RUN OUT		<p>Bevels used to decrease notch factor. BUT no significant advantage (15% only) noted for reducing secondary bending at ends of stringers by bevel design investigated.</p> <p>Initial tests show secondary bending significantly reduced (50% nom.) by increasing the height of the stringer to that of the stringer flange</p>

9.4 Acoustic fatigue resistance

9.4.1 Bonded carbon/epoxy composite joints

9.4.1.1 General

Several joint configurations were evaluated for random vibration resistance by Sonaca. A summary of the conditions and findings of the work are given, Ref. [9-4].

9.4.1.2 Joint configurations

The various joint configurations evaluated, as shown in Figure 9.4-1, are, Ref. [9-4]:

- Riser-to-skin:
 - co-cured,
 - integral.
- Rib-to-skin:
 - bonded,
 - bonded and riveted,
- Beaded skin (expensive construction).

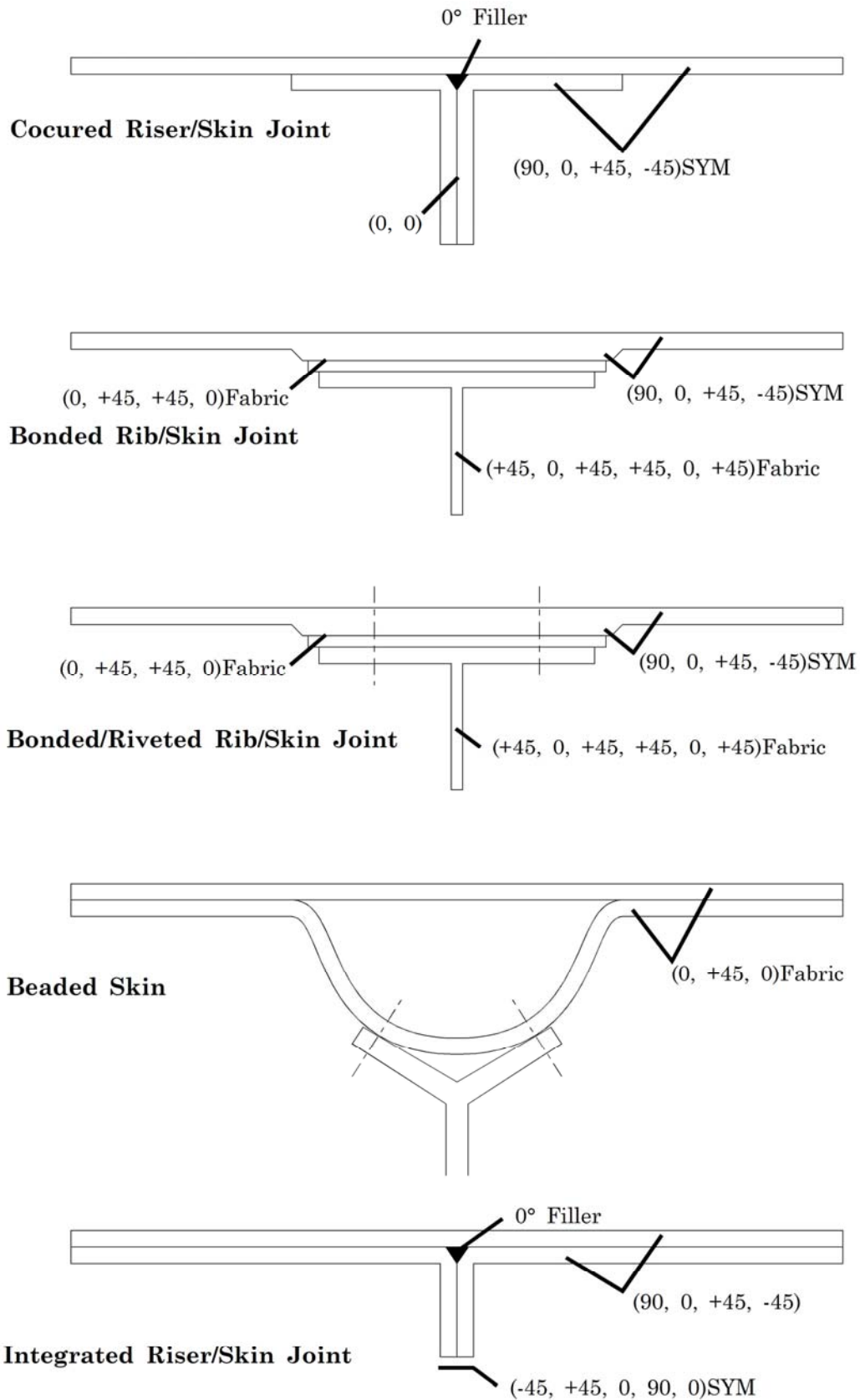

Figure 9.4-1 - Random vibration resistance study: Bonded joint configurations

9.4.1.3 Adherends

Hercules AS4/3501-6 material with a balanced multidirectional lay-up ($0^{\circ}/90^{\circ}/\pm 45^{\circ}$).

9.4.1.4 Adhesive

Hysol epoxy-based paste EA9346.2.

9.4.1.5 Test method

Vibration was induced in each specimen at its natural resonance frequency of 300Hz. The RMS deformation was determined for each configuration. The resonant frequency was monitored throughout the testing, and failure was judged to have occurred if diminishing stiffness caused the frequency to decrease by 5%.

9.4.1.6 Comments

The conclusions of the study included, Ref. [9-4]:

- Integrated skin, showed little sign of damage after 106 cycles,
- Beaded skin, showed a loss of stiffness after 105 cycles, although little damage was visible,
- Co-cured riser-to-skin and skin-to-rib (bonded and riveted), showed peeling before 106 cycles.

Riser-to-skin joints with a **BMI** bismaleimide matrix composite were more prone to cracking than the equivalent epoxy-matrix composite joints.

9.5 References

9.5.1 General

- [9-1] L.J. Hart-Smith
'Design of Adhesively Bonded Joints'
'Joining Fibre-reinforced Plastics', p271-311; Edited by F.L. Matthews.
Elsevier Applied Science, 1987
ISBN 1-85166-0194
- [9-2] A.A. Baker
'Joining Advanced Fibre Composites'. Chapter 8, p115-139
'Composite Materials for Aircraft Structures'
AIAA Publication, 1986
- [9-3] A. Galasso et al
'Aspects of the Fatigue Behaviour of Typical Adhesively Bonded
Aircraft Structures'
D.L. Simpson (Editor), 'New Materials & Fatigue Resistant Designs',
p227-262. Publisher Engineering Materials Advisory Service, UK
- [9-4] SONACA S.A, Belgium
'Shaker Test Results on Typical Structural CFRP Joints under Narrow
Band Random Fatigue'
Sonaca Report No. ESTEC/TP01/BE/R/M1, July 1992
Work Order No.21; ESA/ESTEC Contract No. 7090/87/NL/PP

10

Theory and design practices

10.1 Introduction

10.1.1 Analysis

Several widely-accepted analytical techniques have evolved for describing the response of various bonded joints to different stress modes, [See: 10.2].

An overview of the methods used for common bonded joint configurations and details of some available analytical design tools are provided, [See: 10.11, 10.12].

10.1.2 Factors of safety

Factors of safety are included in the design process. The value is chosen such that it is commensurate with the level of demonstrated experience relating to the different aspects of the envisaged bonded joint design, [See also: ECSS documents: ECSS-E-ST-32-10C].

A Factor of Safety of 1.2 is usually applied unless there is a thorough experimental demonstration of the performances of the joint, Ref. [[10-14], [10-15]].

10.2 Basic theories of bonded joints

10.2.1 Shear lag analysis

10.2.1.1 Assumptions

A commonly used method of estimating the load transfer capacity of bonded, thin-composite laminates is shear lag analysis. The basic assumptions, which are valid in most cases, are that:

- The **adherends** are considered to be very stiff in shear.
- The tension and compression stiffness of the adhesive is negligibly small.
- The adhesive can transmit shear loads, but not tension or compression.

Since the adherends are usually very much stiffer than the adhesive, the complexity of the strength and strain calculation is much reduced, Ref. [10-1].

10.2.2 Linear-elastic stress-strain response

10.2.2.1 General

The method assumes that the behaviour of both the adherends and adhesive are elastic. Features of the stress distribution in bonded joints based on this method are:

- Pure tension or shear loading:
 - the stress distribution is symmetrical if both adherends have the same stiffness,
 - otherwise, the higher stress occurs at the end of the stiffer adherend.
- The load is transferred mainly at the ends of the overlap.
- Shear stress is lower near the middle of the overlap; approaching zero, depending on the overlap length and stiffness ratios,
- Larger overlaps do not improve load-bearing capacity. The shear stress distribution near the ends of the overlap remain largely unchanged, although the average shear stress decreases as a result of the increasing size of the low shear stress central region.

10.2.2.2 Preliminary design calculation methods

Calculation methods for the preliminary design of bonded joints are given in Ref. [10-1], [10-2], [See also: 10.11].

The most serious drawback with this method is the assumption of a linear-elastic stress-strain response in the adhesive. The behaviour of most adhesives is definitely not linear, especially at higher temperatures; as shown in Figure 10.2-1.

10.2.3 Non-linear stress-strain response

10.2.3.1 General

An important feature of the actual properties of the adhesive layer is the non-linear stress-strain response in shear. This can be measured using napkin-ring or thick-adherend types of test specimens, [See also: 15.3]. The non-linear characteristics are illustrated in Figure 10.2-1 for both:

- Ductile adhesives (for specified toughness),
- Brittle adhesives (for high service temperatures).

The **shear strength** of adhesively-bonded structural joints can be better expressed by the strain energy to failure per unit bond area, than by any of the individual properties such as peak shear stress.

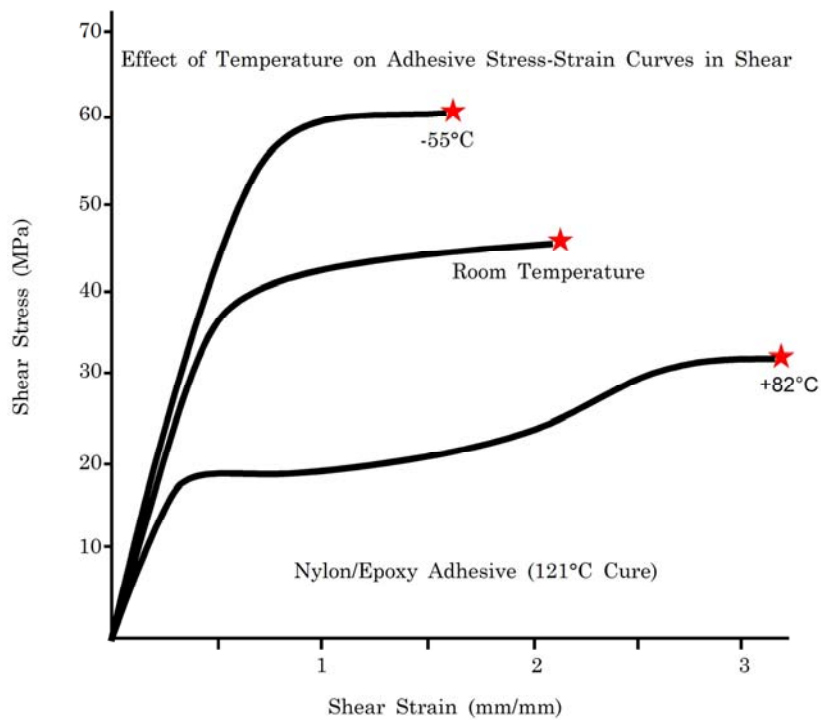
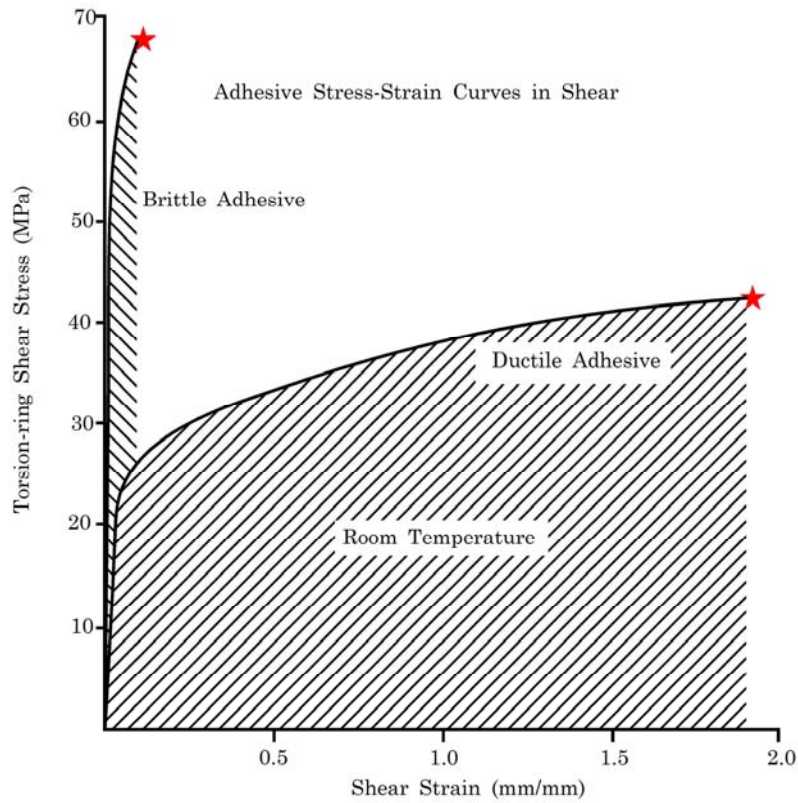

Figure 10.2-1 - Adhesive in non-linear shear: Stress-strain response

10.2.3.2 Ultimate strength

Various analytical models can be used in predicting the ultimate strengths of adhesively-bonded joints, e.g.:

- Elastic-plastic model.
- Elastic-plastic model for intermediate loads.
- Elastic model.
- Bilinear model.

The characteristics of these are shown in Figure 10.2-2. Each of the models can be justified for certain loading cases. However, any two models using the same failure stress (τ_p) and strain ($\gamma_e + \gamma_p$) with the same strain energy to failure predict the same ultimate joint strength.

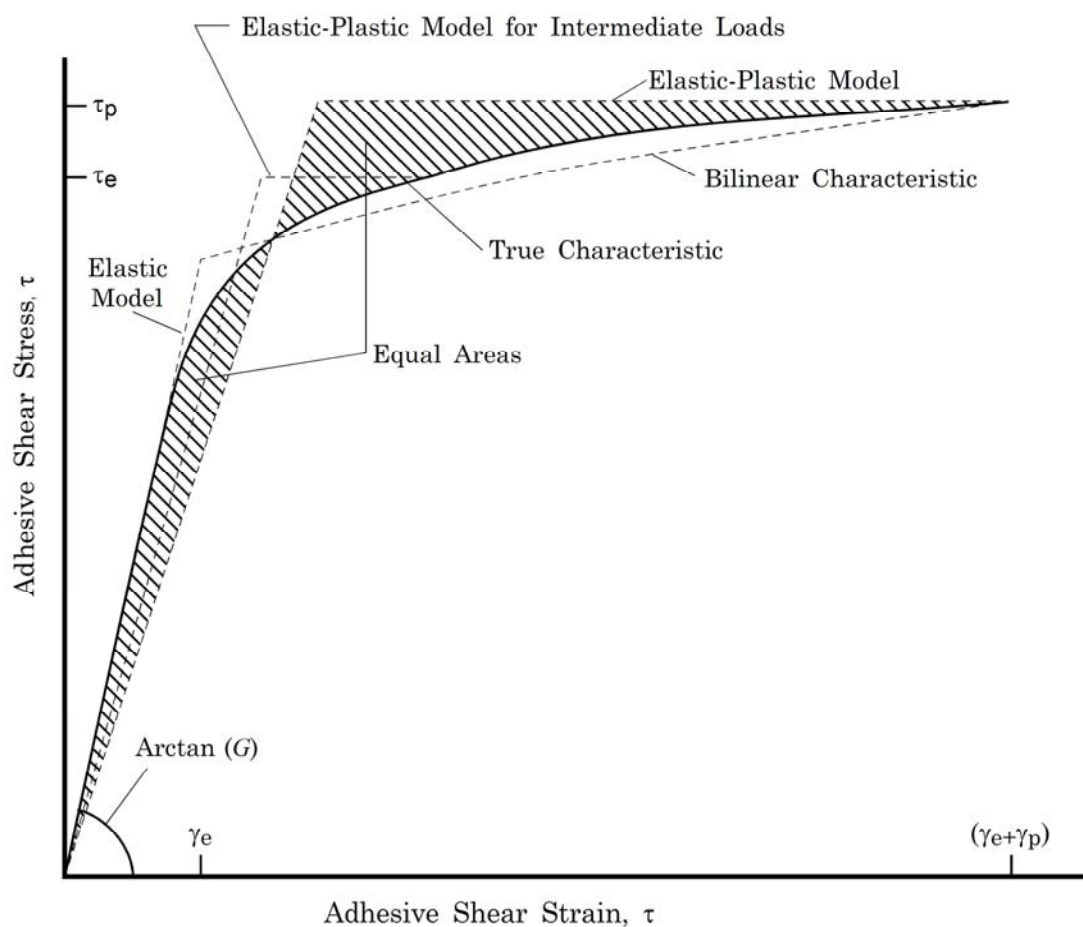

Figure 10.2-2 - Adhesive in non-linear shear: Models and characteristics

10.2.3.3 Design limit load

Good design practice restricts the design limit load in such a way that stresses in the adhesive do not exceed the knee of the stress-strain curve; as shown in Figure 10.2-2. This ensures that, where manufacturing imperfections or defects occur, the joint is able to redistribute local loads by plastic deformation.

10.2.3.4 Load transfer

In the design of adhesively-bonded structural joints, the load transfer is not, and cannot be, uniform. In Figure 10.2-3 the desired form of shear stress and shear strain distribution in an optimised structural overlap joint is shown. This illustrates that:

- There is a minimum adhesive shear strain at point A, which is sufficiently low to prevent creep rupture in the joint under sustained load or low cycle fatigue loadings. A short overlap cannot resist creep.
- Creep is inevitable at point B, where the shear stresses are high, but creep cannot accumulate throughout the rest of the joint.
- The deep elastic trough between the plastic load transfer zones C is not an inefficiency to be eliminated by improved design.

For comparison only, Figure 10.2-3 also shows the uniform shear stress distribution in a short overlap joint. The object of such a specimen is to measure the basic shear properties of the adhesive.

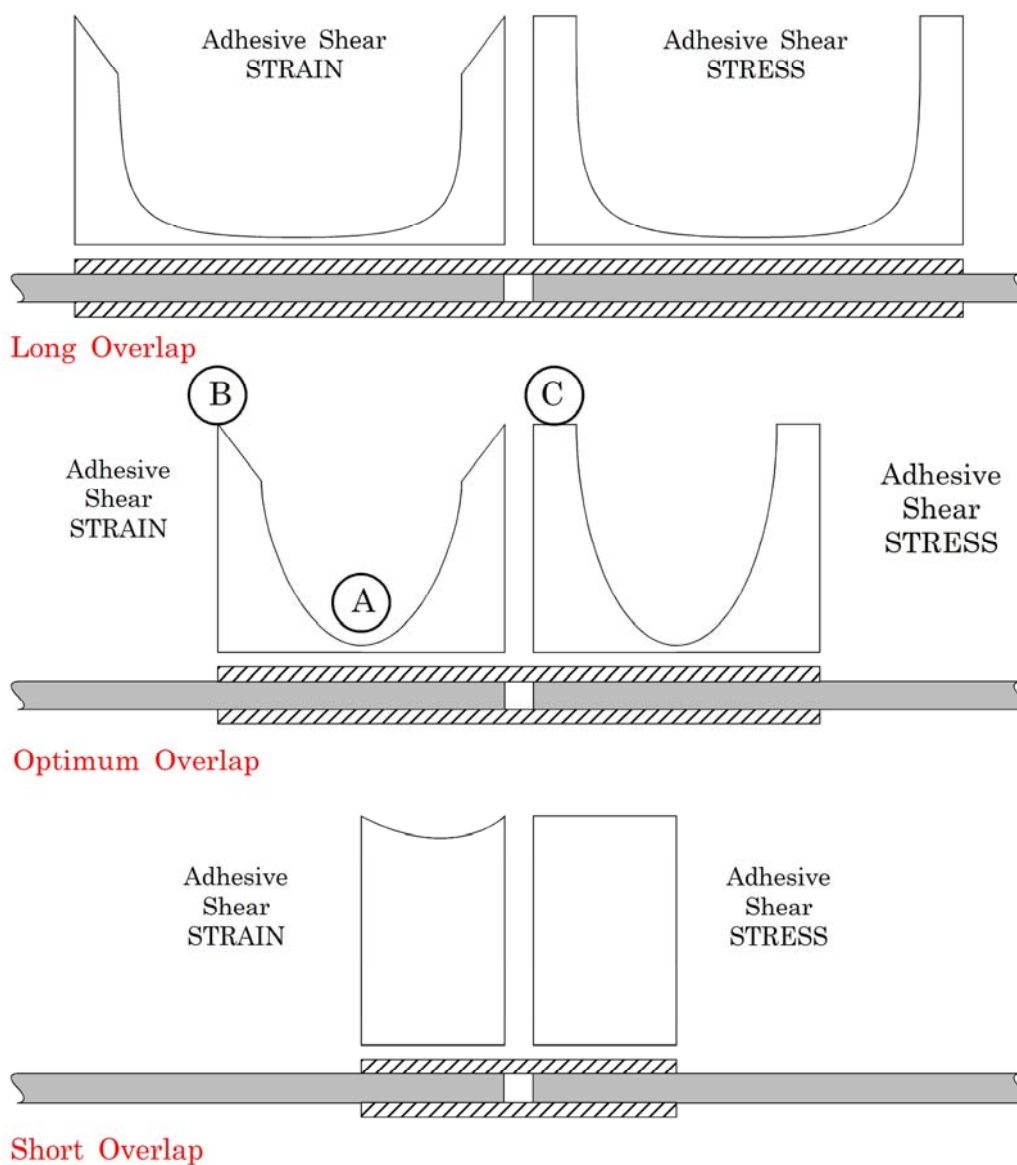

Figure 10.2-3 – Bonded joints: Non-uniform stress and strain distribution

10.2.3.5 Design overlaps

The PABST ‘Primary Adhesively Bonded Structure Technology’ programme design procedures restricted the minimum shear stress to no more than 10% of the maximum at the ultimate load level.

Figure 10.2-4 shows the design overlaps, calculated on the PABST principle, for aluminium alloy sheet. These double strap joints performed without failure both under full-scale testing and in artificially severe coupon testing for four years in a hot-wet environment under slow-cycle testing.

Nominal Adhesive Thickness = 127 μ m

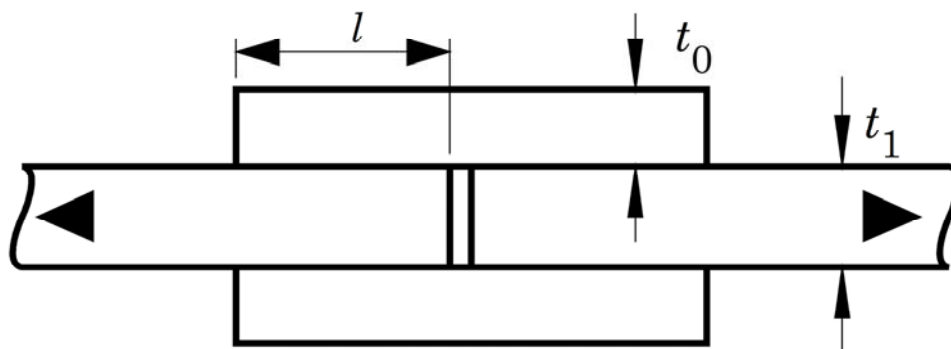

Central Sheet Thickness t_1 (mm)	1.02	1.27	1.60	1.80	2.03	2.29	2.54	3.18
Splice Sheet Thickness t_0 (mm)	0.64	0.81	1.02	1.02	1.27	1.27	1.60	1.80
Recommended Overlap l (mm)	30.7	36.1	42.7	46.7	51.1	55.9	60.7	72.1
Strength of 2024-T3 Aluminium Alloy (N/mm)	456	570	719	810	913	1027	1141	1426
Potential Ultimate Bond Strength (N/mm)	1352	1503	1690	1844	1911	2083	2133	2442

Figure 10.2-4 – PABST programme: Design overlaps used in skin splices

Similar joint dimensions are appropriate for typical multi-directional **carbon fibre**-reinforced **epoxy** laminates, but attention is necessary regarding the fibre orientation at the bond interfaces, [See also: 8.4], and to balancing stiffness and strength between inner **adherend** and straps.

10.2.3.6 Preliminary design calculation methods

DLR developed an analytical model for, Ref. [10-1]:

- Symmetric or near-symmetric joints,
- Asymmetric joints (skew shear-stress distribution), and
- Maximum shear strain.

The model includes the non-linear adhesive stress-strain response, but does not take account of changes in this response arising from:

- Viscoelastic, time-dependent effects,
- Temperature, or
- Ageing and degradation.

With the exception of viscosity, changes to the adhesive affect the input data, but not the model itself. In an extensive series of tests on a variety of **adherend** combinations, the model agreed well with the experimental observations of Hart-Smith, Ref. [10-1].

10.3 Environmental factors for bonded joints

10.3.1 Effect of temperature and moisture

10.3.1.1 General

The influence of temperature and moisture on polymer-based materials and structures are considered together during the design of composites and bonded joints in composite and metal structures.

[See also: Chapter 6 and Chapter 7]

10.3.1.2 Moisture

Absorbed moisture moves through the adhesive resin by capillary action producing a gradual, softening, plasticisation, causing:

- Swelling,
- lowering of the glass transition temperature, T_g .

Experimental results indicate that moisture absorption levels of less than 0.6% do not result in any decrease of adhesive strength.

Figure 10.3-1 compares the variation of adhesive shear stress along the joint, due to a constant end load, Ref. [10-7].

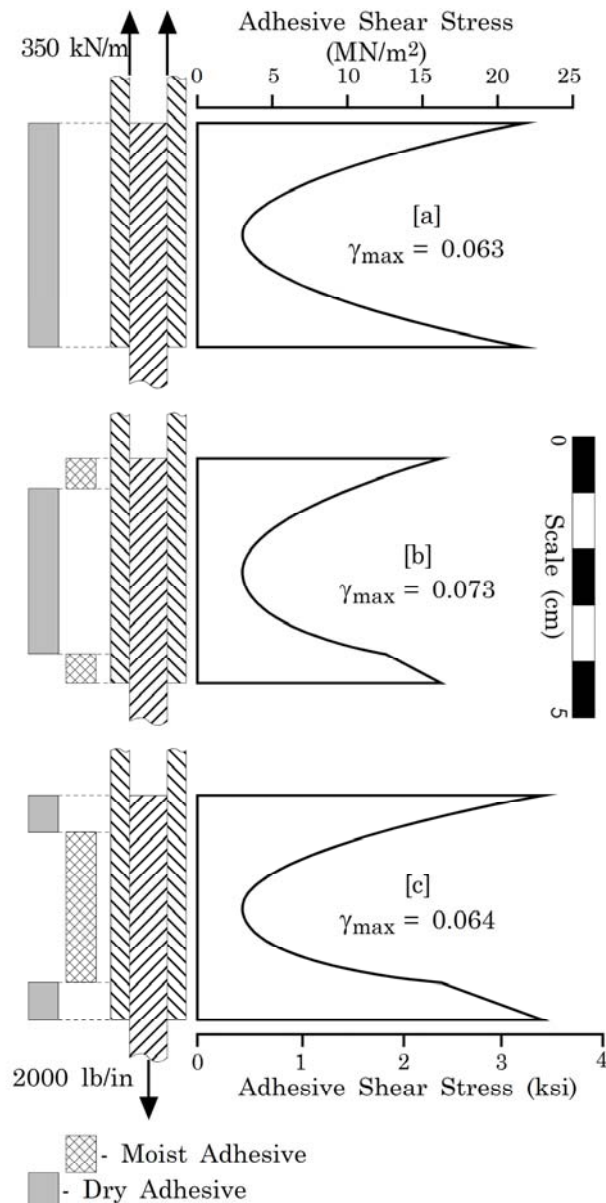

Key: [a] Adhesive uniformly dry
 [b] Adhesive softened by moisture absorption at edge
 [c] Adhesive partially dried due to change in external environment
 γ_{\max} : Adhesive maximum shear strain

Figure 10.3-1 – Bonded joints: Effect of moisture on stress distributions

Figure 10.3-2 (A) shows a simple transition which has a dry adhesive on the outside part, whereas in Figure 10.3-2 (B) there are two staggered transitions with a moist adhesive on the outside. Both illustrations are drawn to the same scale. In the second case, there are three rather than two adhesive states responsible for defining the outermost adhesive shear strain, Ref. [10-7]. These phenomena have been observed for uniform double lap joints.

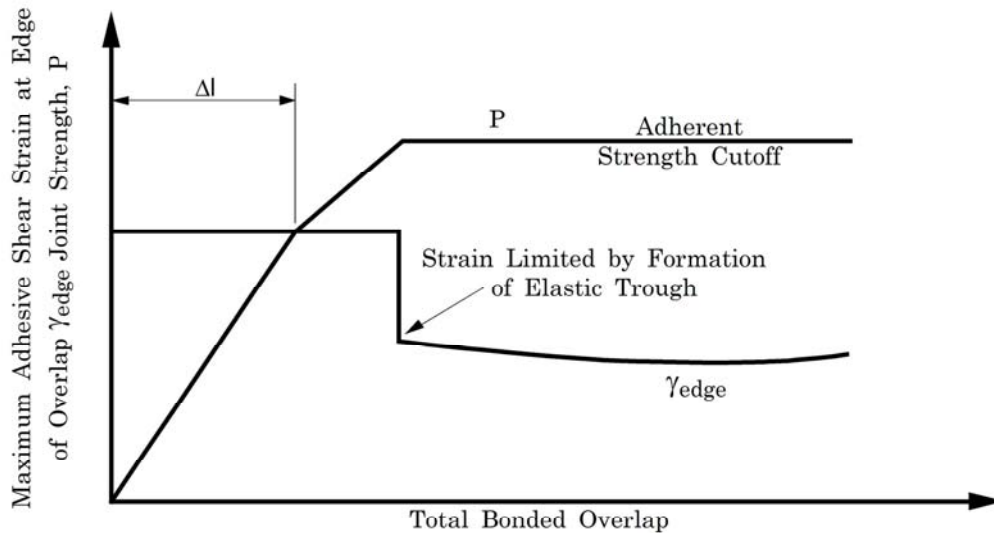

(A) Adhesive with Dry Exterior $DI/2$ from each end, Interior Moist.

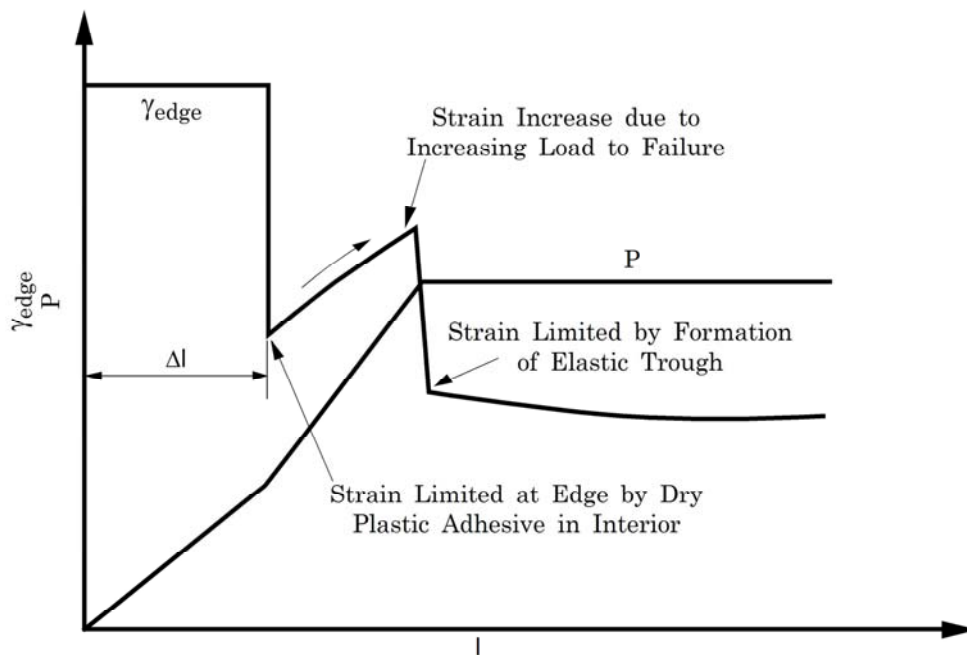

(B) Adhesive with Moist Exterior $DI/2$ from each end, Interior Dry.

Figure 10.3-2 – Bonded joints: Influence of moisture absorption and desorption on peak adhesive shear strains

Figure 10.3-3 shows that, for a bonded doubler or wide overlap joint, continuing penetration of the joint by moisture has little effect on the most critically loaded adhesive near the end of the overlap once the moisture has penetrated past that edge area, Ref. [10-7].

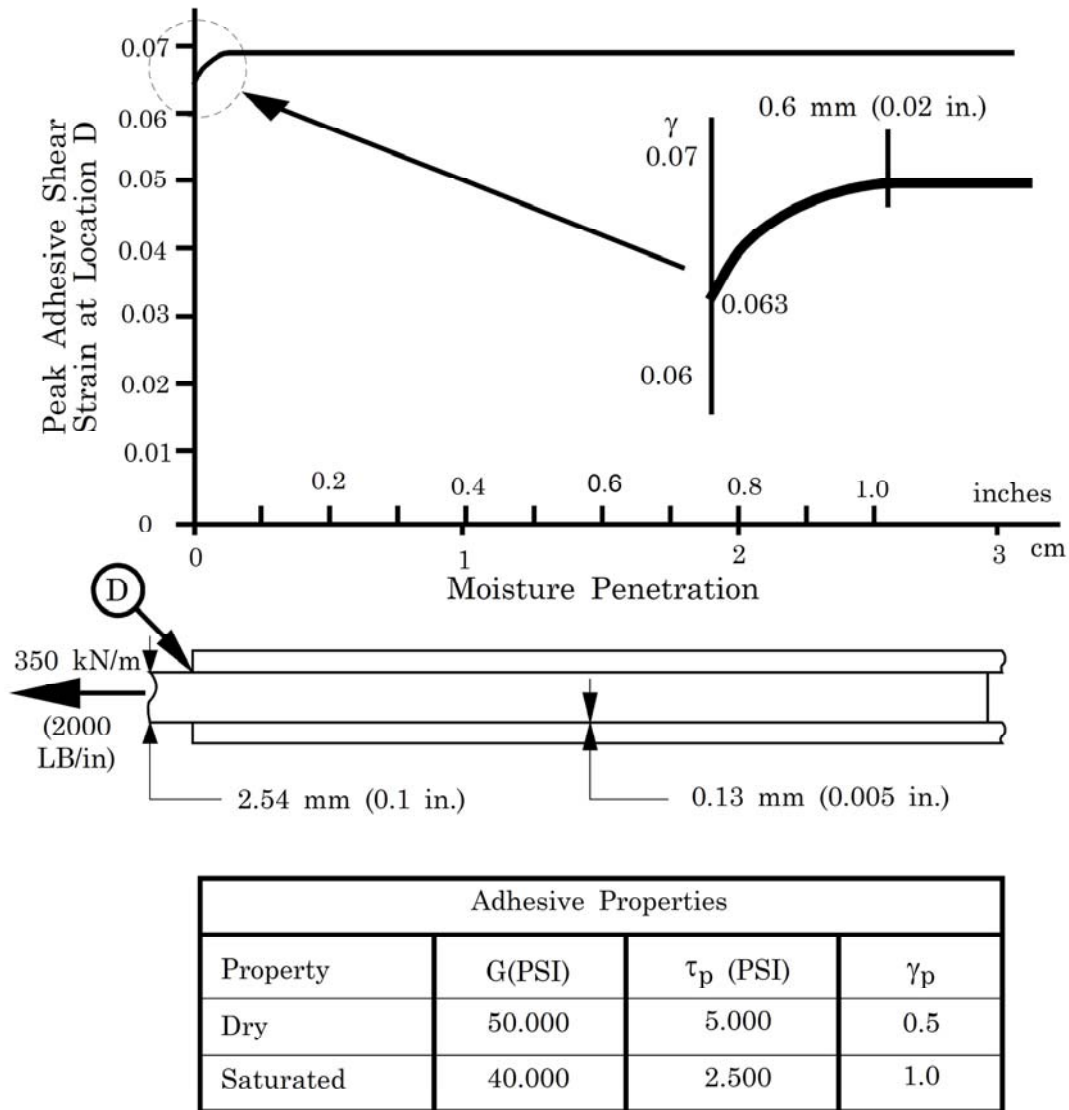

Figure 10.3-3 – Bonded joints: Effect of progressive moisture absorption on bond strain

10.3.1.3 Temperature

Temperature effects by themselves are not important if the adhesive is used within its stipulated service temperature range, [See: 6].

10.3.1.4 Combined moisture and temperature

The worst case occurs under the influence of both temperature and moisture, because a high temperature increases the absorption and diffusion of moisture.

Guidelines on how to avoid the detrimental effects of moisture and temperature include:

- Define accurately the worst case of environmental conditions, which the bonded joint is to withstand.
- Define the service temperature range precisely.

- Select the most adequate type of adhesive resin, e.g. **epoxy**-based, **polyimide**, **silicone**, taking into account the worst case environmental conditions and the precise service temperature range.

10.4 Effect of bonding defects

10.4.1 General

10.4.1.1 Types of defects

The main classes of defect that occur in adhesive joints are, Ref. [10-16]:

- Complete disbonds, flaws, voids or porosity in the adhesive layer.
- Poor **adhesion**, i.e. a weak interface between the adhesive layer and one or both adherends.
- Poor **cohesion**, i.e. a weak adhesive layer.

Also important are:

- Variation in thickness,
- Undercuring,
- Variation in resin fraction, and
- Variation in density.

10.4.1.2 Importance of defects

The importance of the defects depends on such factors as:

- The extent to which defects are present.
- Their consequences (critical or not).
- Whether defects are random or locally concentrated.
- Whether defects are indicative of degradation process or not.
- Whether defects are indicative of material deficiencies or not.

10.4.2 Description of bonding defects

10.4.2.1 Disbonds, flaws, voids and porosity

Some disbonds are essentially large, flat voids that can be caused by a complete lack of adhesive or by the adhesive being applied unevenly to one **adherend** only. Disbonds can also be caused by the presence of grease or other contaminants on an adherend, e.g. release agent. In these cases the surfaces of the defect are generally in close proximity or touching, which makes their detection difficult. Disbonds can also occur as a result of impact or environmental degradation after manufacture.

Porosity is caused by volatiles or air trapped in the adhesive. Inadequate drying of composites can cause absorbed moisture to vaporise during the adhesive cure cycle and produce bubbles in the adhesive.

Any bonding defects result in redistribution of load through the adhesive layer. Although this idea suggests an increase in peak stresses at discontinuity points in the adhesive layer, the actual effect is weaker than expected and only an imperceptible increase in stress occurs in most cases. This assessment is valid only when the flaw size is proportionally small with respect to joint size.

Figure 10.4-1 shows the possibly-acceptable flaw sizes according to a Zone 1 (critical zone) and a Zone 2 (less-critical zone), as classified in Ref. [10-7]. It indicates flaw sizes that are acceptable in primary structures, depending on the zone in which the flaw appears. The limits for secondary structures in use throughout the aerospace industry are currently more stringent than those shown in Figure 10.4-1, Ref. [10-7].

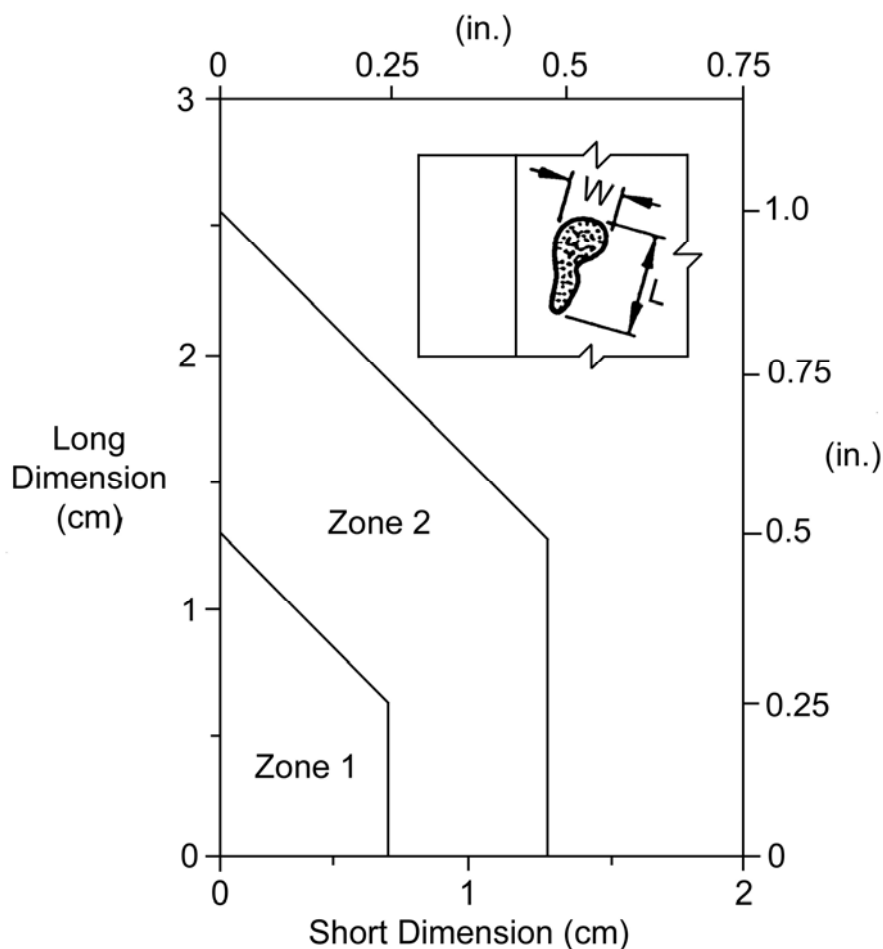
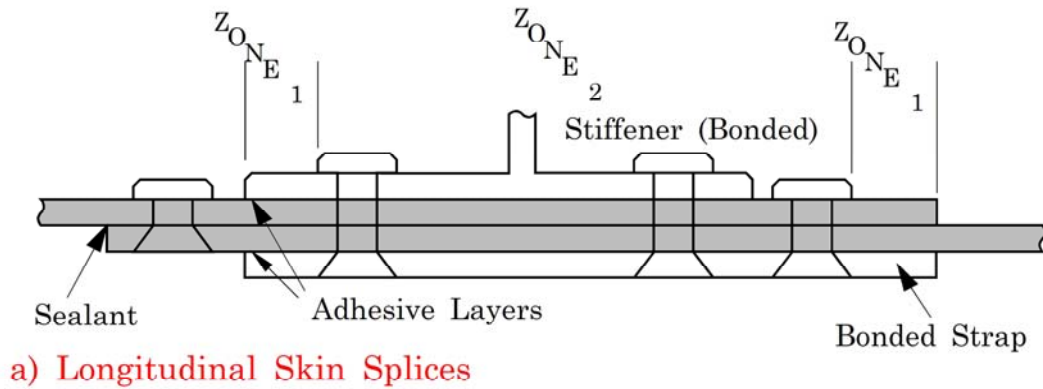
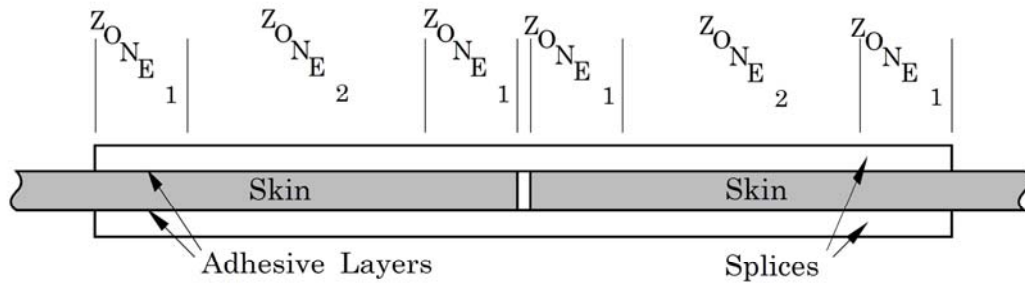
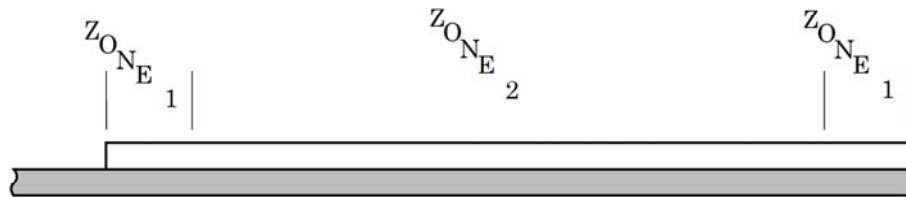

Figure 10.4-1 - Bonded joints: Examples of acceptable bond flaw sizes

Figure 10.4-2 depicts examples of common structural joints, i.e. longitudinal skin splices, bonded doublers and bonded stiffeners, and their critical zones, Ref. [10-7], where Zone 1 is 'Critical' and Zone 2 'Less Critical'.



a) Longitudinal Skin Splices



b) Large Area Bonded Doublers

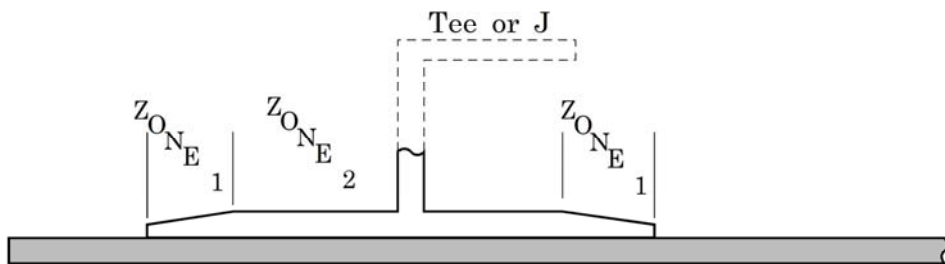

c) Bonded Stiffeners

Zone 1: Critical. Zone 2: Less Critical.

Figure 10.4-2 - Bonded joints: Typical quality zoning

10.4.2.2 Stress distribution in defect-free bonded joint

The normal adhesive stress distributions in a defect-free double-overlap bonded joint is shown in Figure 10.4-3.

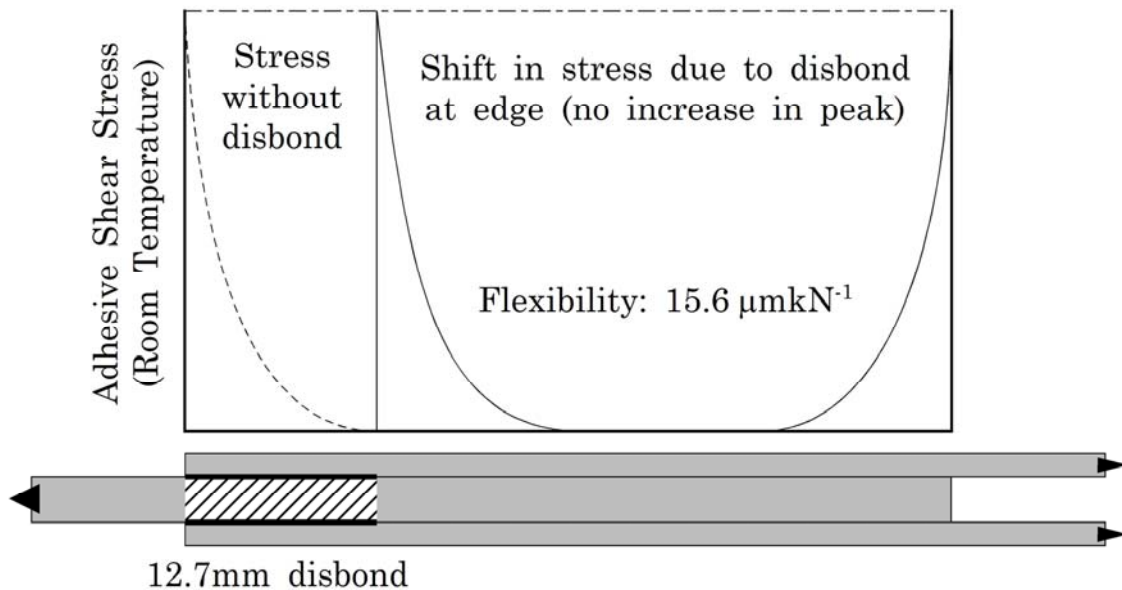

The general conditions were: Inner thickness: 1.27 mm; Outer thickness: 0.64 mm; Overlap length: 50.8 mm; Adhesive thickness: 0.13 mm; Tension: 175 kNm⁻¹.

Figure 10.4-3 – Double overlap bonded joint: Adhesive shear stresses (defect-free)

10.4.2.3 Stress distribution in bonded joints with defects

The ways in which the stress distributions are modified by different types of defects are shown in:

- Figure 10.4-4 for a 12.7 mm disbond (edge).
- Figure 10.4-5 for a 12.7 mm disbond (away from edge).
- Figure 10.4-6 for a 25.4 mm disbond (central).

For each graph, the general conditions were: Inner thickness: 1.27 mm; Outer thickness: 0.64 mm; Overlap length: 50.8 mm; Adhesive thickness: 0.13 mm; Tension: 175 kNm⁻¹.

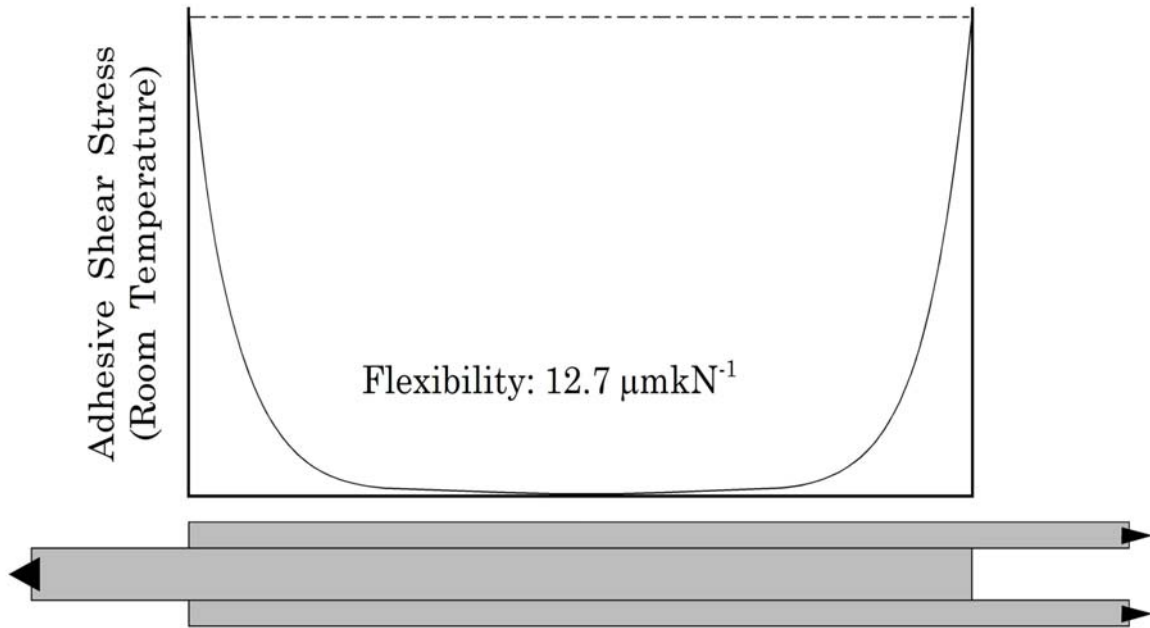

The general conditions were: Inner thickness: 1.27 mm; Outer thickness: 0.64 mm; Overlap length: 50.8 mm; Adhesive thickness: 0.13 mm; Tension: 175 kNm^{-1} .

Figure 10.4-4 - Double overlap bonded joint: Adhesive stresses with edge disbond

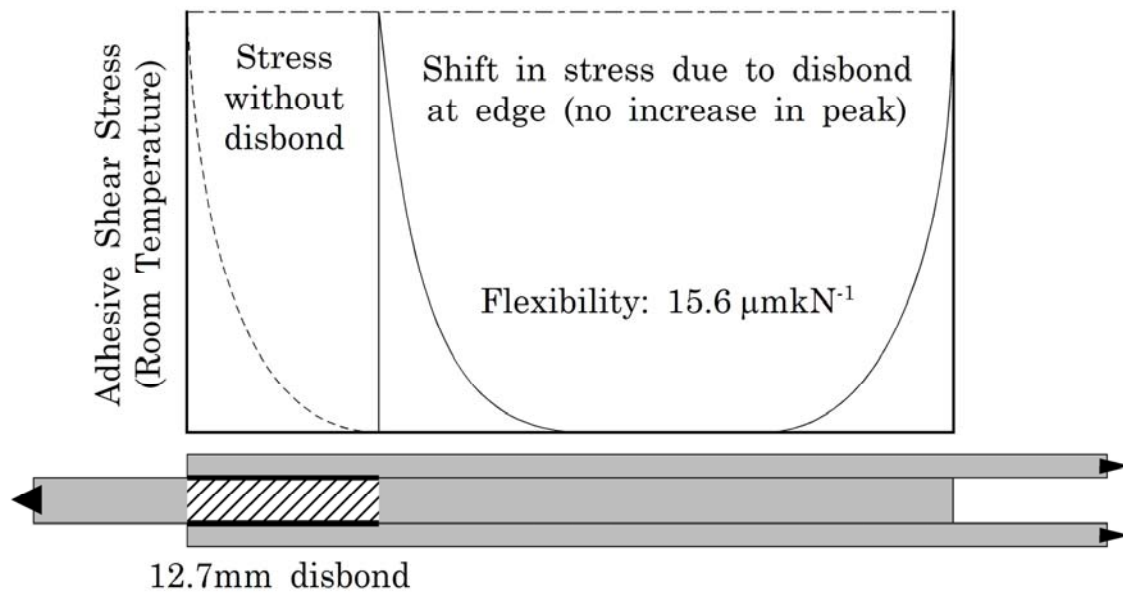

The general conditions were: Inner thickness: 1.27 mm; Outer thickness: 0.64 mm; Overlap length: 50.8 mm; Adhesive thickness: 0.13 mm; Tension: 175 kNm^{-1} .

Figure 10.4-5 - Double overlap bonded joint: Adhesive stresses with away from edge disbond

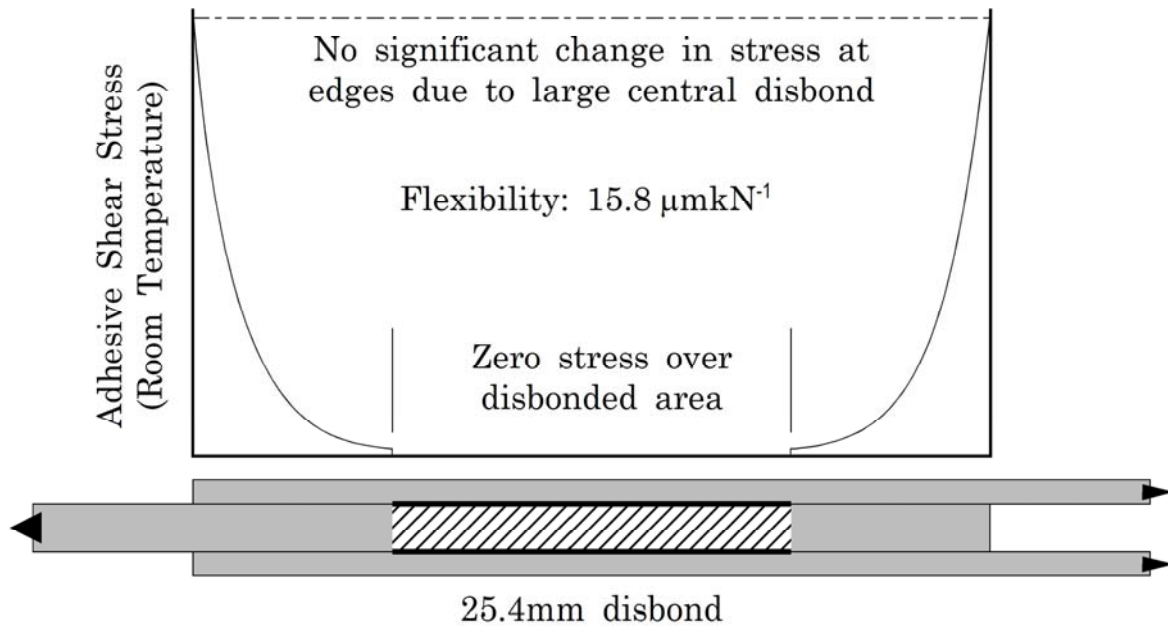

The general conditions were: Inner thickness: 1.27 mm; Outer thickness: 0.64 mm; Overlap length: 50.8 mm; Adhesive thickness: 0.13 mm; Tension: 175 kNm^{-1} .

Figure 10.4-6 - Double overlap bonded joint: Adhesive stresses with central disbond

10.4.2.4 Defects in short and long overlap joints

In Figure 10.4-7 the effects of flaws in short and long overlap bonds under the same applied load are compared.

Of particular interest is the vertical gradient over which the induced maximum adhesive shear stress is reduced from its failure value to a much lower value, i.e. independent of overlap length. The effect of flaws is inconsequential, except when the total effective overlap is barely sufficient to carry the entire load plastically.

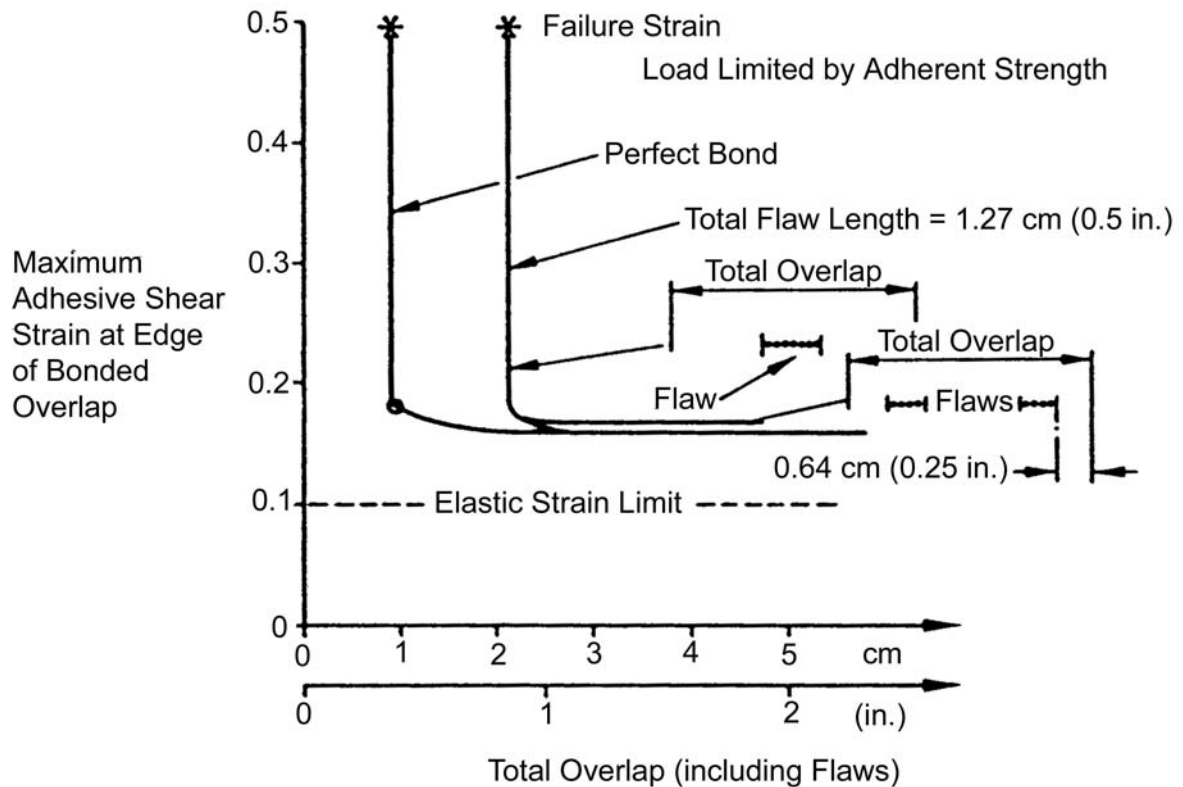

The effect of flaws is inconsequential, except when the total effective overlap is barely sufficient to carry the entire load plastically

Figure 10.4-7 - Adhesive bonded joints: Effect of disbond flaws on flexibility

More detailed analyses are needed to cover the cases in which bond flaws are so large that there is a possibility of complete tearing of the adhesive layer. Such analyses need to account for two-dimensional load re-distribution around flaws as well as the one-dimensional re-distribution considered here.

10.4.2.5 Variation in thickness

Experience shows that the best results in bonding composites are obtained when the thickness of adhesive layers range from 0.12 mm to 0.25 mm, Ref. [10-7].

In practice, the optimum thickness often cannot be achieved. Figure 10.4-7 shows the variation in peak induced adhesive stress with adhesive thickness at the ends of the bond, Ref. [10-7].

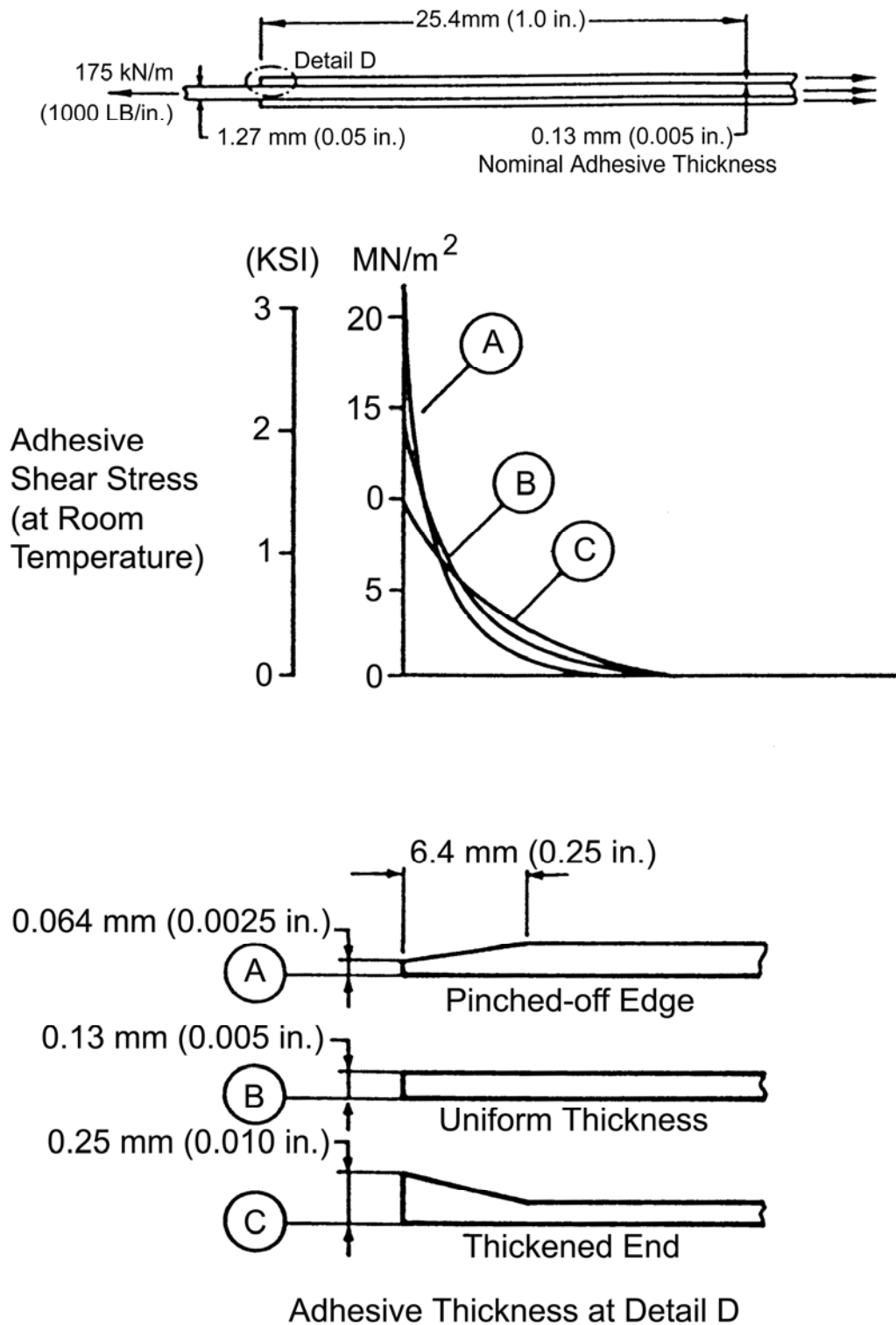

Figure 10.4-8 – Adhesive thickness: Variation of peak induced adhesive stress at ends of bonded joint overlap

10.4.2.6 Undercuring

Under cure occurs when there is insufficient time or temperature for adequate hardening (curing) of the adhesive.

10.4.2.7 Variation in resin fraction

When bond surfaces have an excessive, or insufficient, quantity of resin, it is known as a variation of resin fraction. The resulting defect is often considered as a 'variation in thickness'.

10.4.2.8 Variation in density

The presence of flaws and porosity or a variation in resin fraction can produce a variation in density.

10.4.3 NDT non-destructive techniques

10.4.3.1 General

Some non-destructive testing techniques used to detect defects in bonded joints are given in Table 10.4-1. Some of these methods are difficult to apply in practice.

10.4.3.2 Flaws, voids and porosity

Although such defects can seriously impair bond performance, they can be detected by:

- Conventional water-coupled ultrasonics: Sensitive to disbonds, delaminations and porosity.
- Ultrasonic bond testers: For disbonds and delaminations, but not porosity:
 - 100 kHz to 1 MHz.
 - Bondascope, which measures magnitude and phase of the ultrasonic impedance.
 - Fokker bond tester II, using a spectroscopic approach monitoring frequency and amplitude changes in the first two modes of through-thickness vibration.
- Sonic vibration and mechanical impedance: For large defects.
- Thermography, Ref. [[10-17], [10-18], [10-19]], holography and shearography: For the larger near-surface, air-gap defects.
- Eddy currents: Possible for disbonds between composite and metal, Ref. [10-20]

Table 10.4-1 - Bonded joints: Description of NDT methods

Method	Description
Radiography (X-ray)	Very effective for examining the uniformity of adhesive joints and intimacy of contact in bonded areas when the adhesives used are not radiation transparent.
Radiography (Neutron)	Used to determine adhesive build up or variation in resin fraction.
Radiation (Gamma)	Used to detect changes in thickness or density of adhesive.
Thermography	Thermochromic or photochromic compounds are added to the adhesive system. Used to determine the degree of adhesive curing.
Ultrasonic	Sound waves ranging in frequency from 1 to 10 MHz are used to find: <ul style="list-style-type: none"> • changes in thickness • detect porosity • delaminations or unbonded areas. There are three basic ultrasonic systems: <ul style="list-style-type: none"> • Pulse-echo reflector, to detect flaws and delaminations. • Transmission, to detect flaws. • Resonant frequency, to detect unbonded areas.
Acoustic Emission (AE)	Applicable to determine flaws or (through sonic microflows), porosity, undercured or unbonded areas and variation in density.
Infrared (IR)	Used to find delaminations, unbonded areas and porosity.
Dye Penetrant	Used to detect flaws, porosity and delaminations.
Induced Current	Used to detect porosity, undercured areas, delamination and variations in thickness.

•

10.4.3.3 Cohesion and adhesion

A weak adhesive layer, giving poor **cohesive** properties, can result from incorrect mixing or formulation of two-part adhesives, or inadequate curing. Since one-part film adhesives also suffer from these problems, miscuring seems the most likely cause. There is some evidence to suggest that the Fokker bond tester Mk II can detect poor cohesion under some circumstances.

Poor **adhesion** is likely to be caused by surface contamination or incorrect surface preparation prior to bonding. A further possibility is contamination by release agent on peel plies. High resolution is needed within a thin layer of about 1 µm thick, which implies the use of ultrasonics at high frequencies (20 MHz to 200 MHz). This leads to severe signal attenuation problems.

The inspection of adhesive bonds for poor **cohesion** or **adhesion** remains an area of weakness within NDT techniques, and no reliable method exists currently. As the desire to detect these anomalies continues, it remains a motivation for new developments, Ref. [10-21], [10-22]. Until a technique is proven, adhesion and cohesion problems are best eliminated by precise process monitoring, with control test samples made alongside production items; ‘witness samples’.

10.4.3.4 Defect detection by NDT

Table 10.4-2 summarises the possibility of defect detection in bonded joints by various techniques.

[See also: 16 for inspection during manufacture and assembly; 20 for in-service]

Table 10.4-2 - Bonded joints: Detection methods for various defects

Defect	Radiography			Thermography	Ultrasonic	Acoustic Emission	IR	Dye Penetrant	Induced Current
	X-ray	Neutron	Gamma						
Unbond	✓			✓	✓	✓	✓		
Under Cure				✓	✓	✓			✓
Variation in resin fraction		✓							
Density	✓		✓		✓	✓			
Thickness	✓		✓		✓	✓			✓
Porosity	✓		✓		✓	✓	✓	✓	✓
Flaws	✓		✓		✓	✓		✓	
Delamination	✓ ⁽¹⁾		✓	✓	✓	✓	✓	✓	✓

Key: (1) If delamination is in the same orientation as X-ray beam.

10.5 Double lap and double strap joints

10.5.1 Stress distribution

10.5.1.1 General

Using continuum mechanics analyses, Hart-Smith Ref. [10-3], [10-4], provides a thorough understanding of the stress state within bonded double-lap and double-strap joints. The analyses cover:

- nonuniformity in load transfer;
- strength losses associated with **adherend** stiffness imbalances or thermal mismatches;
- the significant shear-lag effect within double strap joints where the adherends butt together.

The key characteristics relating to these phenomena are:

- peak adhesive shear strain,
- minimum adhesive shear strain,
- peak induced adhesive **peel** stress.

10.5.1.2 Peel stress

To avoid composite delamination, peel stresses can be minimised by tapering the edges of splice plates and by ensuring that an adhesive fillet is present at the ends of the overlap.

A local thickening of the adhesive layer also helps; as shown in Figure 10.5-1. The tip thickness of the splice plate is limited to less than 0.5 mm for composites. Splice plate tapering does not modify the overall joint strength because load-transfer is unaffected where the adherends butt together.

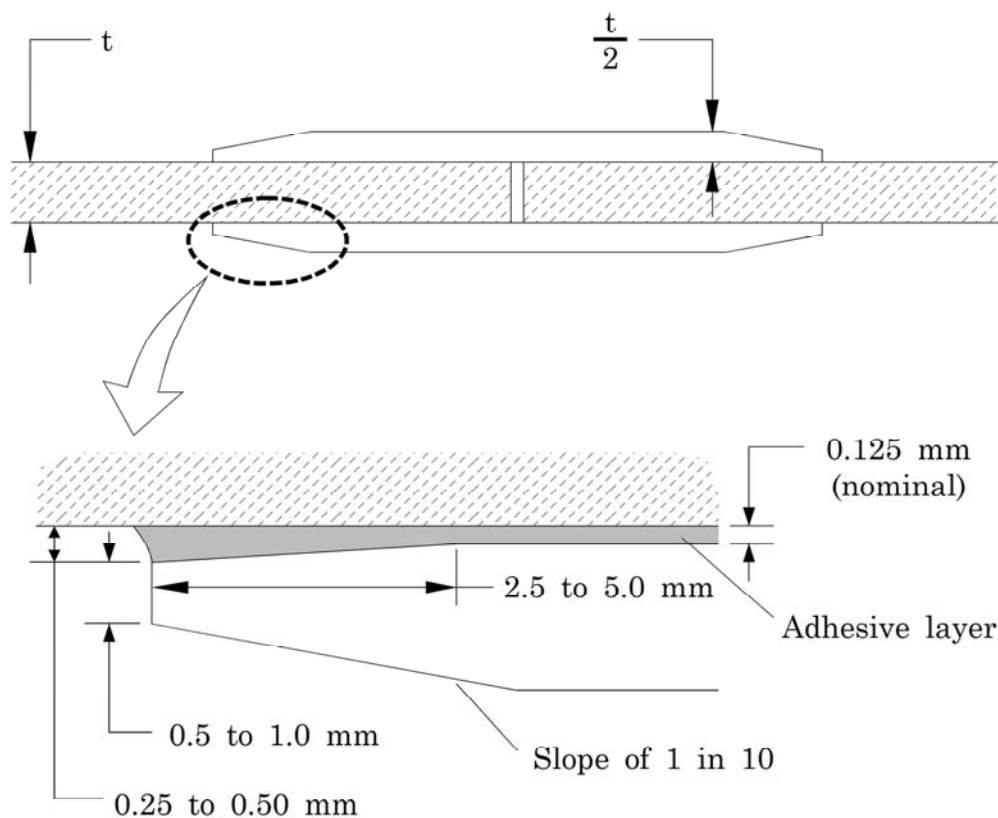

Figure 10.5-1 - Double lap and strap joints: Reducing peel stresses

10.5.1.3 Shear stress

Figure 10.5-2 shows the effect of overlap on maximum adhesive shear strains. Together with Figure 10.5-3, these illustrate means of achieving the necessary maximum and minimum shear stresses

with respect to bond overlap. Ensure that the strength is adequate and that the elastic trough is wide enough to prevent **creep** in the middle.

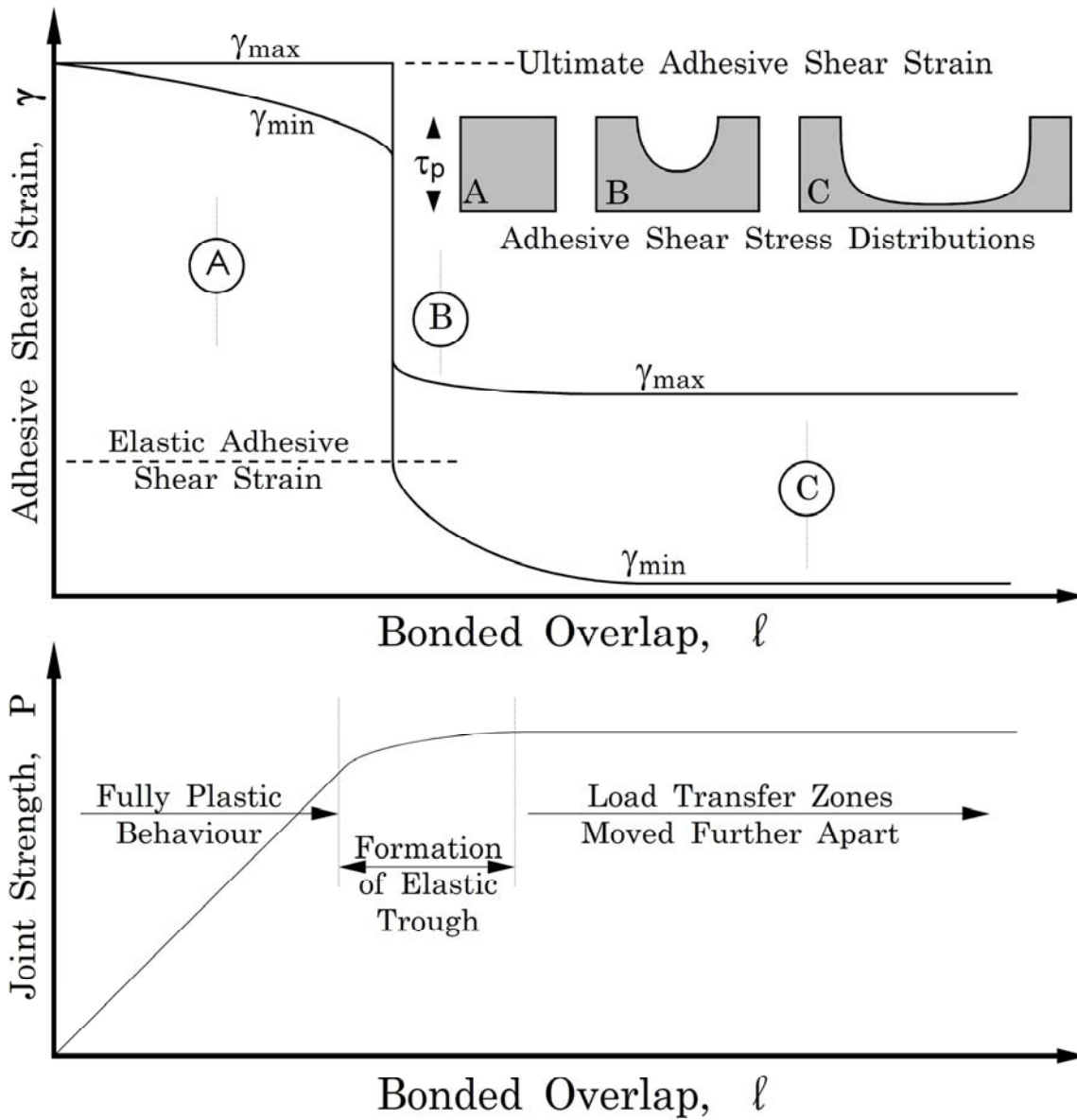

Figure 10.5-2 - Double lap and strap joints: Effect of overlap on maximum adhesive shear strains

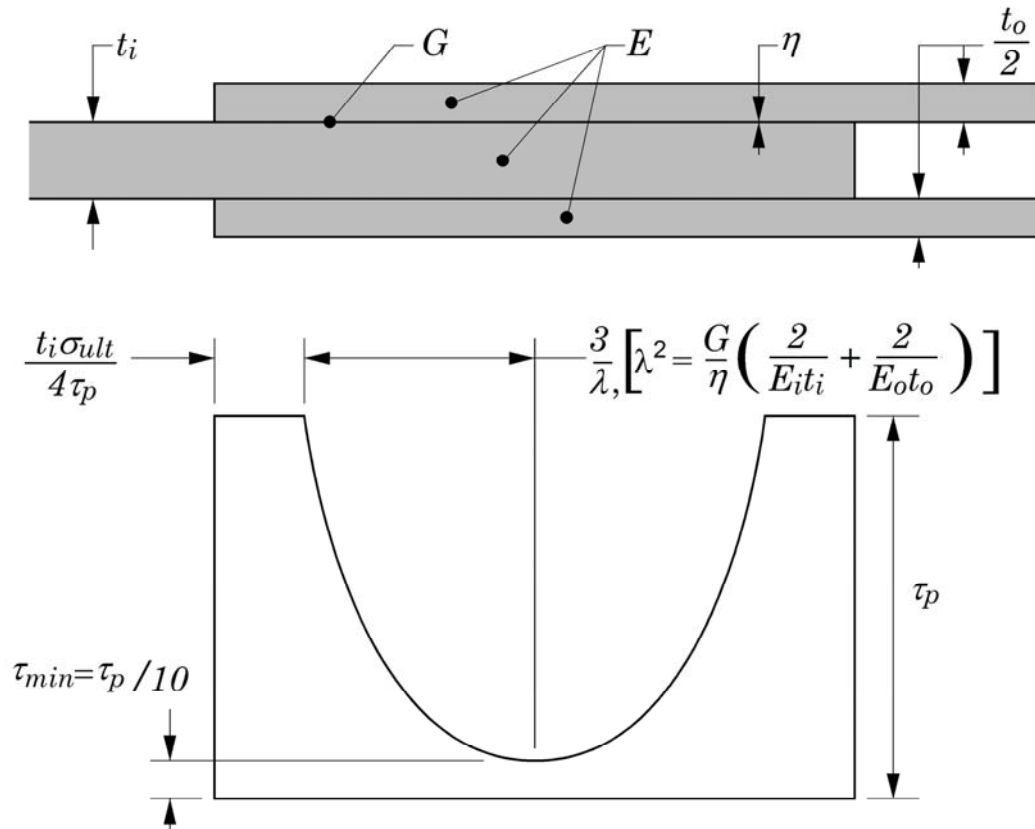

Figure 10.5-3 - Double lap joints: Design factors

It demonstrates how full joint strength is obtained from an overlap consisting of elements for:

- stress transfer $\left(\frac{t_i \sigma_{ult}}{4 \tau_p} \right)$
- elastic trough $\left(\frac{3}{\lambda} \right)$

For a double strap joint:

$$\left(\lambda^2 = \frac{G}{\eta} \left(\frac{2}{E_i t_i} + \frac{2}{E_o t_o} \right) \right) \quad [10.5-1]$$

where:

- E_i, E_o adherend stiffnesses
- σ_{ult} ultimate adherend stiffness
- G adhesive shear modulus
- η adhesive bondline thickness
- τ_p maximum shear stress

10.6 Single lap joints

10.6.1 General

The design of single **lap joints** in fibrous composite structures is easier than that of double lap joints.

10.6.2 Load path eccentricity

Mathematical analysis of single lap joints take into account the out-of-plane bending associated with eccentricity of the load path, [See: Figure 10.4-1]. As **peel** stresses are the main problem, the limitations on potential joint strengths imposed by the **adherend** thickness should be considered.

10.6.3 Joint efficiencies

10.6.3.1 General

The joint efficiencies which can be expected for a range of laminate thicknesses for a ductile and brittle adhesive are provided.

10.6.3.2 Ductile adhesive

Ductile adhesives have a greater capability for handling peel stresses, hence the preference for using them to bond thin sheet; as shown in Figure 10.6-1.

10.6.3.3 Brittle adhesive

Figure 10.6-2 shows the joint efficiencies for a range of laminate thicknesses.

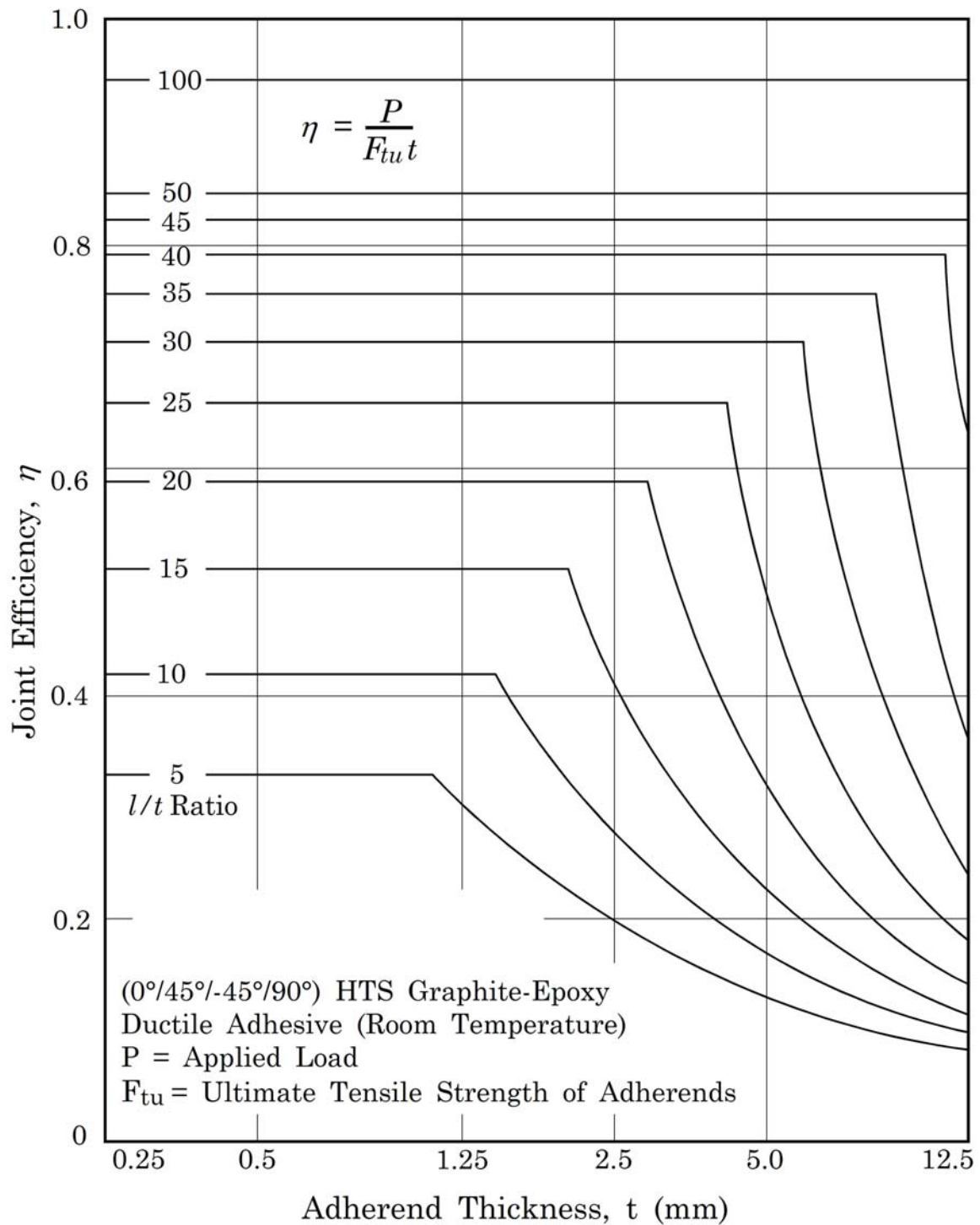

Figure 10.6-1 - Joint efficiency for single lap composite joints: Ductile adhesive

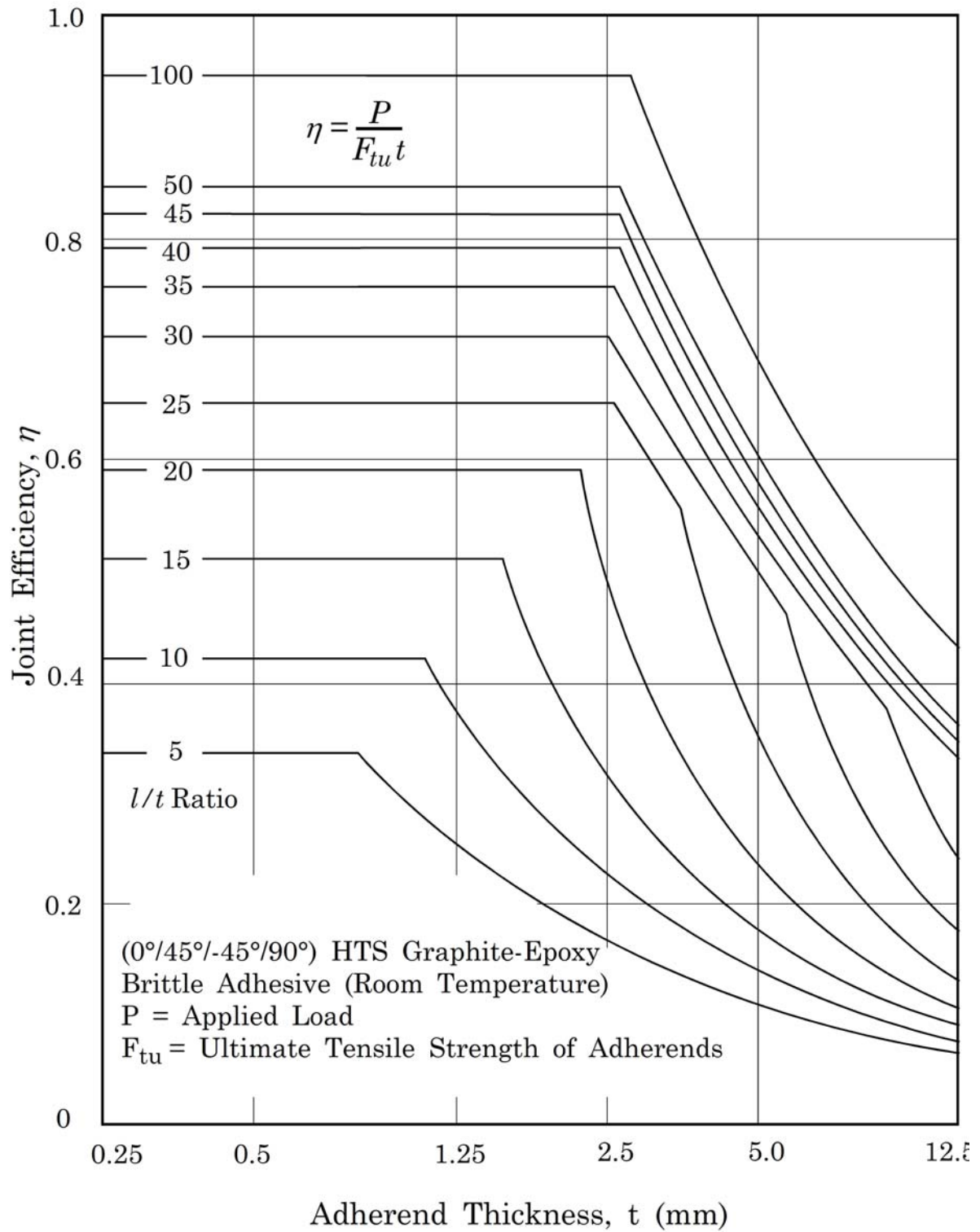

Figure 10.6-2 - Joint efficiency for single lap composite joints: Brittle adhesive

10.6.4 Adhesive characteristics

10.6.4.1 Use of short, single overlap joints

Short single overlap joints can be misleading for determining the shear strength of adhesives, although this method is popular. The apparent shear strength obtained is highly dependent on adherend material, thickness and properties, and failure is by **peel** rather than by **shear**, Ref. [10-6].

[See also: 15 for test methods]

10.7 Double-sided stepped lap joints

10.7.1 Joint strength

Double-sided stepped lap joints are particularly appropriate for metal to composite joints.

In aircraft construction, where the overall laminate thickness is typically several tens of millimetres, bonding technology can produce joints with load transfers of about 5250 N/mm for 25 mm thick laminates. The design of high load-capacity joints needs very close attention to details.

Joint strength is particularly sensitive to:

- **adherend** stiffness balance,
- the number of steps within the joint.

The overall joint length (the sum of the lengths of the steps) is less important than the number of steps. Each of the steps is described mathematically by the same differential equation as that used for double lap joints.

10.7.2 Adherend stiffness balance

10.7.2.1 General

Each step interval is considered separately in the analysis. Figure 10.7-1 shows the adhesive shear stress distribution for two stepped lap joint designs.

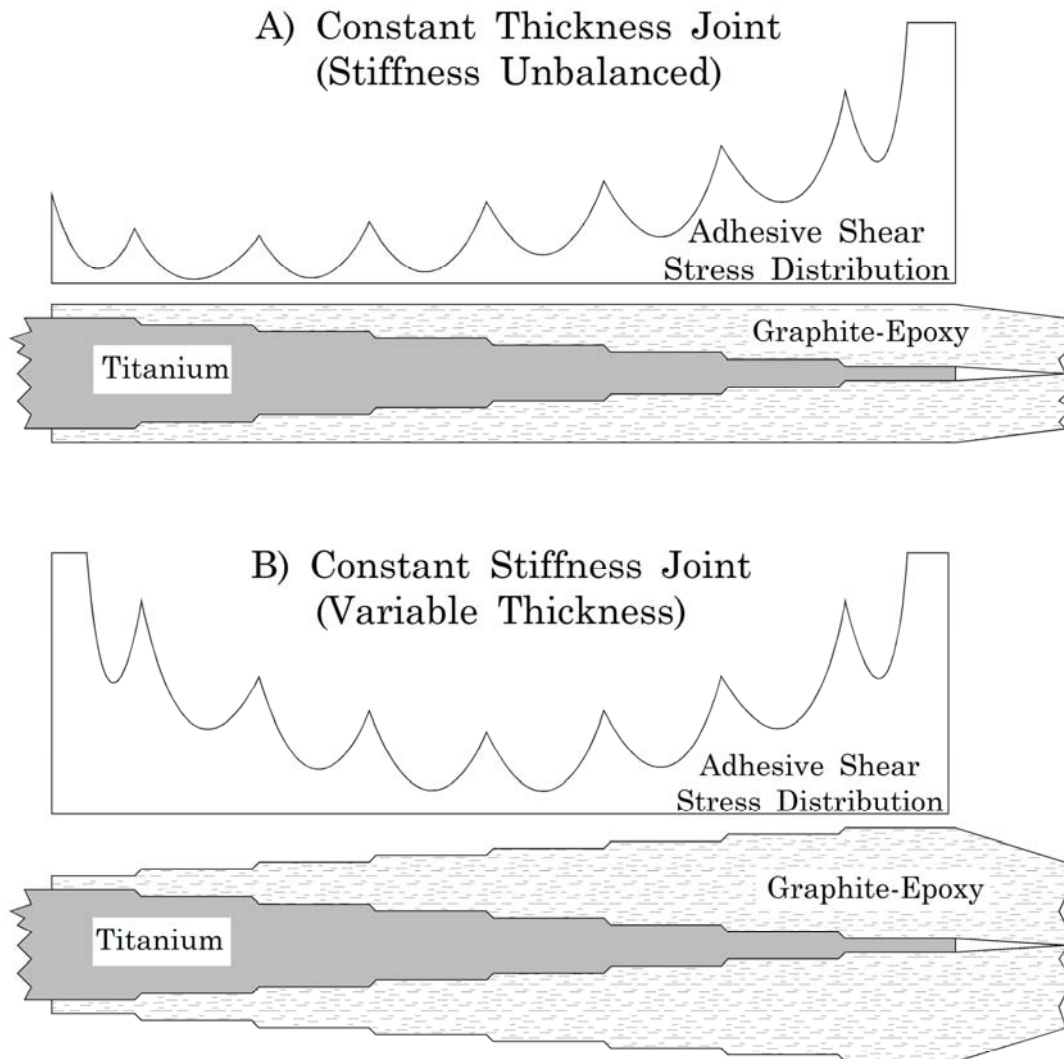

Design B has twice the load-bearing capacity of Design A.

Figure 10.7-1 - Double-sided stepped lap joints: Adherend stiffness balance

An imbalance in **adherend** stiffness is often the cause of adherend tip failure, as shown in Figure 10.7-2. Where laminate construction precludes the termination of prepreg (core) plies at the adherend tip, a low-modulus triangular wedge can be used to divert the core plies, thus providing fibre continuity, [See also: Figure 10.7-1].

A) Preliminary Design

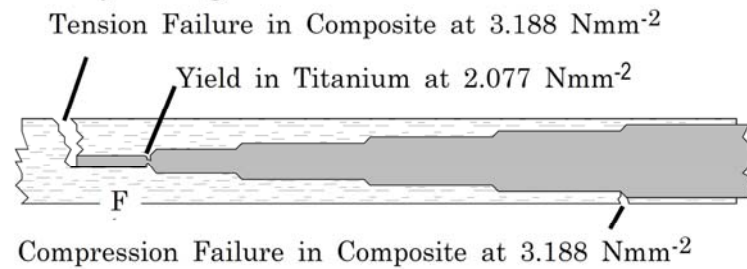

Note: The titanium end caps were already shortened during preliminary design with uniform steps 19 mm long throughout. Premature fatigue failure would occur at 'F' followed by failure of the composite at the same (reduced) section.

B) Optimised Design

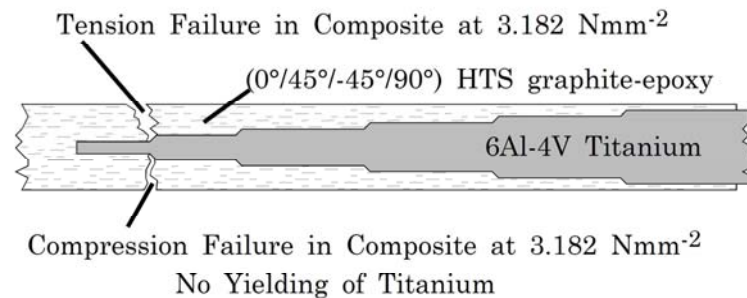

Ductile adhesive, cured at 177°C.
Strengths calculated at room temperature.
Strength of composite outside joint: 3.188 Nmm⁻².
Potential shear bond strength would exceed 4.070 Nmm⁻² in every case shown if adherends were sufficiently strong.

Figure 10.7-2 - Double-sided stepped lap joints: Design optimisation

10.7.2.2 Example: CFRP laminate

For a joint between CFRP and a titanium stepped plate, an example of a design for CFRP laminates (either quasi-isotropic or slightly orthotropic) is:

- step length: each step approximately 12.7 mm long;
- thickness increment: between 0.5 mm to 0.75 mm, i.e. about 4 layers of unidirectional prepreg;
- middle: to produce a total bonded overlap with a very lightly stressed, deep elastic trough to prevent **creep** (as for double lap joints), a longer step length, e.g. 19 mm to 25 mm, is needed for one or more of the steps near the middle.

The comments are appropriate for stepped lap joints laid up on each side of a central step plate with the assembly **co-cured** and bonded together to ensure a good fit and the absence of warpage.

10.8 Single-sided stepped lap joints

10.8.1 Joint strength

Single-sided joints are only feasible for:

- thermally compatible (identical) **adherends**,
- room-temperature cure adhesives.

Single-sided stepped lap joints between dissimilar materials are impracticable with elevated temperature cure adhesives (up to 170 °C). Severe warpage destroys the joint during cool-down.

10.9 Scarf joints

10.9.1 Joint strength

10.9.1.1 General

An ideal **scarf joint** is one where load is transferred between two identical members, both of which have perfect feather edges at their tips. The principal effects causing real bonded scarf joints to deviate from the ideal are:

- stiffness imbalance between the **adherends**,
- finite thicknesses at their ends.

10.9.1.2 Stiffness imbalance

In joints with adherends of unequal stiffness, there is a tendency for the thin tip of the stiffer member to fail by fatigue resulting from uneven load transfer. This type of failure applies to both scarf and stepped joints

10.9.1.3 End thickness

The practical difficulties of manufacturing an ideal feathered edge over a long length (bond width) results in localised weaknesses, such as adherend bending and wrinkling. This is particularly so for metal adherends. Such anomalies along the edge give rise to stress concentrations which reduce the strength of the joint.

When a finite tip thickness, e.g. 0.50 mm to 0.75 mm, is used in the design, its effect in the joint can be analysed by making an approximation to a stepped lap configuration.

10.9.1.4 Creep

Creep rupture is avoided in overlap joints by ensuring the presence in the central region of an elastic trough, [See: Figure 10.2-3].

In a scarf joint of mathematically idealised form, the adhesive is uniformly strained along the entire bond length. This excludes an elastic trough, so prevention of creep producing strains can only be achieved by restricting the maximum strain within the adhesive. This gives a very long **scarf joint** with extremely small scarf angles.

A two-step scarf of graduated thickness build-up is an appropriate solution to this problem.

10.10 Calculation of bonded joint strength

The methods given for calculating joint strength, [See: 10.11], are not closed-form mathematical solutions. Nevertheless, the introduction of various simplifications makes it possible to produce solutions which can readily be used for the various joint configurations, if it is assumed that the behaviour of the **adherend** and the adhesive is elastic. The calculation methods are based on the work of Volkersen, Ref. [10-8] and Goland-Reissner Ref. [10-9].

Two basic approaches to the study of joints, including plasticity effects, can be found in Hart-Smith, Ref. [10-10] or ESDU, Ref. [10-11].

[See also: 10.12 for analytical design tools]

10.11 Analysis of joint configurations

10.11.1 Analytical notation

N	Tensile load	
N_{cr}	Critical load	
E	Young's modulus of adherends	
G	Adhesive shear modulus	
K, α, W, f	Factors	
dS	Variation of surface energy	
dE	Variation of elastic strain energy	
dP	Variation of potential energy of peeling load	
l	Length of peeling	
L	Length of overlap	
b	Width	
T	Temperature	
t	Thickness of lap sheet	
t_a	Thickness of adhesive	
V	Poisson's ratio	
τ_m	Average shear stress	
τ_{max}	Maximum shear stress	
τ	Theoretical shear stress	
ω	Stiffness ratio	

[See 10.10 description of the methods used] also:
for a

10.11.2 Single lap shear joint

10.11.2.1 Symmetrical

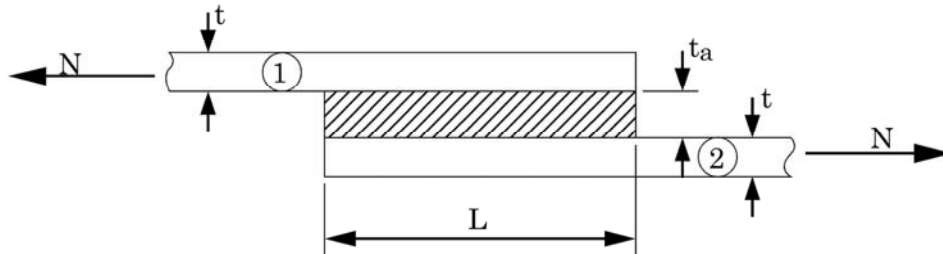

Figure 10.11-1 - Analysis: Notation for symmetrical single-lap shear joint

The tensile load N produces a shear stress τ_m in the adhesive layer, according to:

$$\tau_m = \frac{N}{L} \quad [10.11-1]$$

$$\tau_{\max} = K \tau_m \quad [10.11-2]$$

where:

$$K = \frac{1}{4} [WL(1 + 3\alpha) \coth WL + 3(1 - \alpha)] \quad [10.11-3]$$

$$W = \left[\frac{2(1 - \lambda_{xy})G}{E t t_a} \right]^{1/2} \quad [10.11-4]$$

$$\alpha = \frac{1}{1 + 2\sqrt{2} \tanh \left[\frac{L}{t} \left[\frac{3(1 - \lambda_{xy})N}{2Et} \right]^{1/2} \right]} \quad [10.11-5]$$

$$\lambda_{xy} = \nu_{xy} \nu_{yx} \quad [10.11-6]$$

The relationship between the theoretical and average shear stress is given as:

$$\frac{\tau}{\tau_m} = \frac{1}{4} \left[\left(\frac{2(1 - \lambda_{xy})G}{E t t_a} \right)^{1/2} L(1 + 3\alpha) \frac{\cosh 2WX}{\sinh WL} + 3(1 - \alpha) \right] \quad [10.11-7]$$

The assumptions made are:

- The adhesive flexural rigidity is negligible.
- The behaviour of the laminate and adhesive due to the tensile load N is elastic and isotropic.
- Bending effects can be disregarded.
- The normal and shear strains in the transverse direction of the laminate are negligible with respect to those in the adhesive.

10.11.2.2 Analysis of R-degree peeling

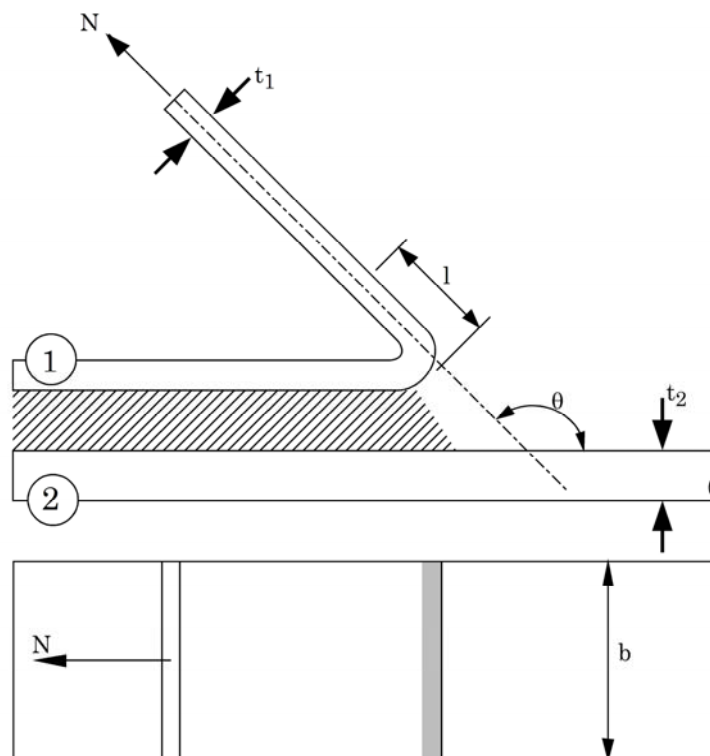

Figure 10.11-2 - Analysis: Notation for single-lap joint R-degree peeling

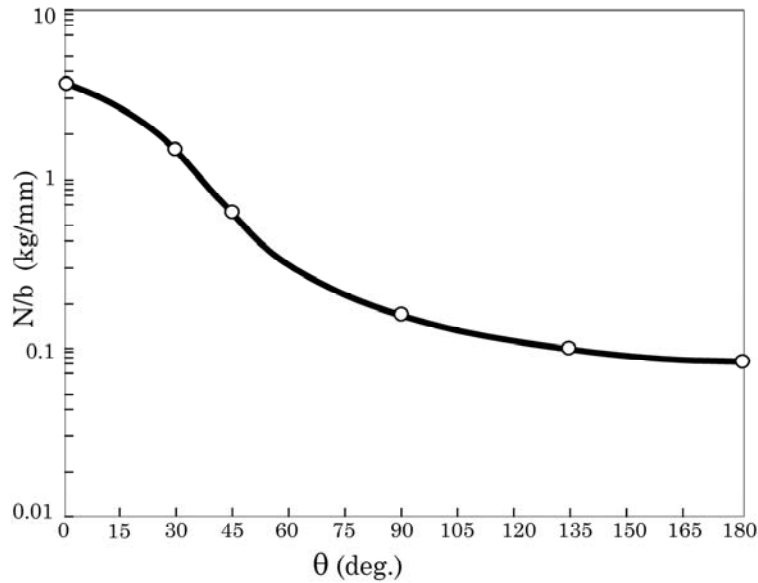

Figure 10.11-3 - θ degree peeling strength

The critical condition for peeling is:

$$dS + dE + dP = 0 \quad [10.11-8]$$

With γ being the surface energy to cause adhesive fracture, Eq. [10.11-9] is obtained from Eq. [10.11-1]:

$$N_{cr}^2 \left(\frac{1}{E_1 t_1} + \frac{\cos^2 \theta}{E_2 t_2} \right) + 2bt_1(1 - \cos \theta)N_{cr} - 4\gamma b^2 = 0 \quad [10.11-9]$$

Solving Eq. [10.11-9] for N_{cr} gives:

$$N_{cr} = \frac{-2bt_1(1 - \cos \theta) \pm \sqrt{4b^2 t_1^2 (1 - \cos \theta)^2 + 16 \left(\frac{1}{E_1 t_1} + \frac{\cos^2 \theta}{E_2 t_2} \right) \gamma b^2}}{2 \left(\frac{1}{E_1 t_1} + \frac{\cos^2 \theta}{E_2 t_2} \right)} \quad [10.11-10]$$

10.11.3 Double lap shear joint

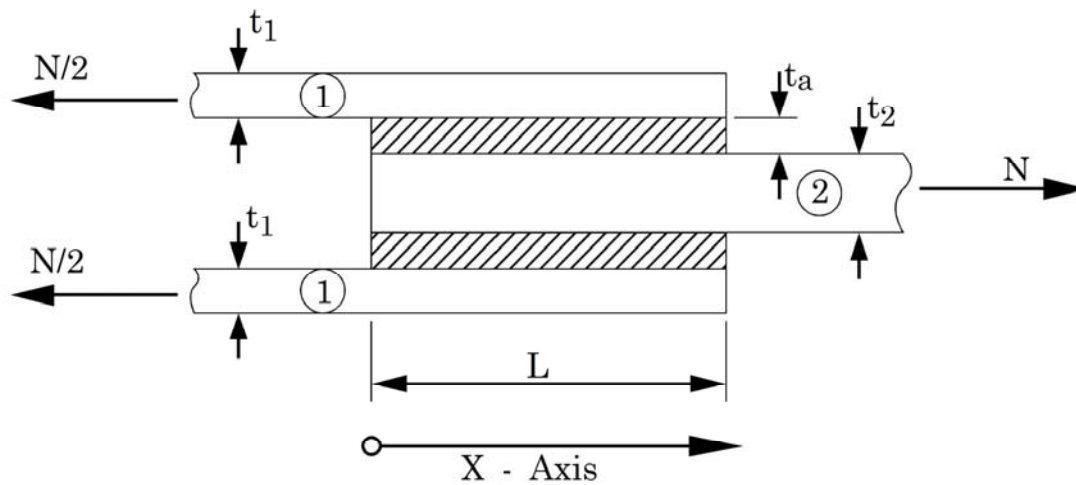

Figure 10.11-4 - Analysis: Notation for double-lap shear joint

The tensile load N produces a shear stress τ_m in each adhesive layer, according to:

$$\tau_m = \frac{N}{2L} \quad [10.11-11]$$

$$\tau_{\max} = K t_m \quad [10.11-12]$$

where:

$$K = \frac{(1-\beta^*) + \beta^* \cosh WL}{\sinh WL} WL \quad [10.11-13]$$

$$W = \left[\frac{2G}{t_a t_2 E_2 \beta} \right]^{1/2} \quad [10.11-14]$$

$$\beta = \frac{1}{1 + \frac{t_2 E_2}{2 t_1 E_1}} \quad [10.11-15]$$

and: β^* the greater of β or $(1-\beta)$

The relationship between the theoretical and average shear stress is given by:

$$\frac{\tau}{\tau_m} = WL \left[\frac{(1 - \beta) \cosh WL + \beta}{\sinh WL} \cosh WX - (1 - \beta) \sinh WX \right] \quad [10.11-16]$$

In general, t (thickness) and L (length) values result in $WL < 4$, hence:

$$\tau_{\max} = \beta^* WL \tau_m \quad [10.11-17]$$

When $\frac{L}{t_2} \geq 8$ can be applied, Equation [10.11-18] is obtained:

$$\left(\frac{N}{t_2} \right)_{crit} = K \frac{\sqrt{\beta}}{\beta^*} \quad [10.11-18]$$

where: $K = K_1 K_2$ and K_1 and K_2 are defined as:

$$K_1 = \frac{2\gamma\tau_a}{\sqrt{2G}} \sqrt{t_a} \quad [10.11-19]$$

$$K_2 = \sqrt{\frac{E_2}{t_2}} \quad [10.11-20]$$

10.11.4 Double-lap shear joint under mechanical and temperature loads

10.11.4.1 Joint with standard overlap length

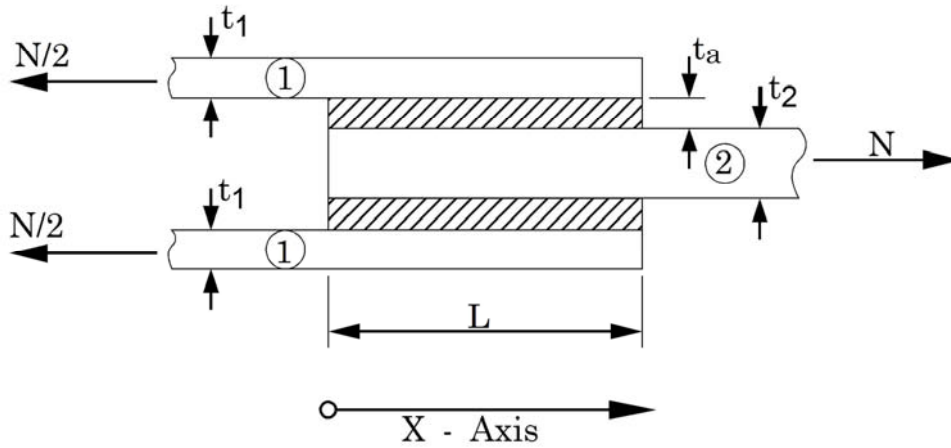

Figure 10.11-5 - Analysis: Notation for double lap joint (standard overlap length)

The distribution of shear stress in the adhesive due to load can be described by the distribution shown in Figure 10.11-6; where $E_1 t_1 = E_2 t_2$.

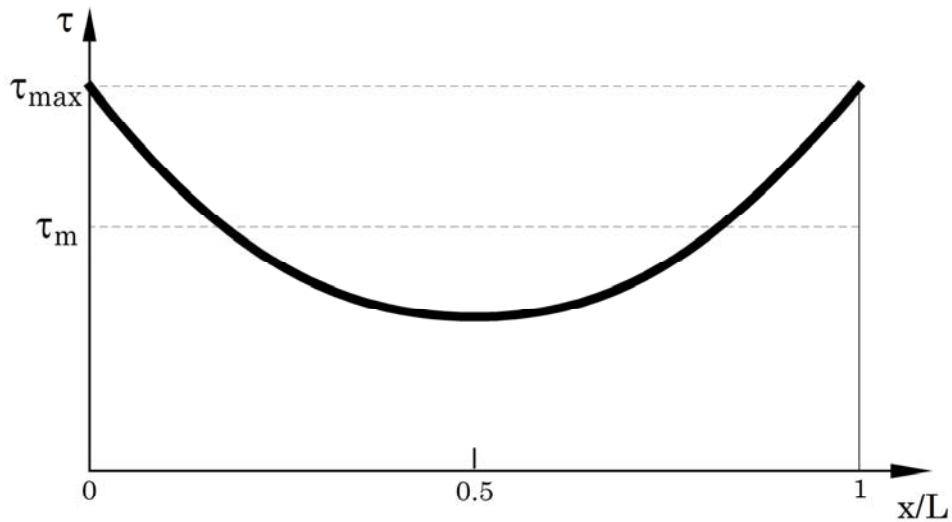

Figure 10.11-6 - Shear stress distribution versus the adhesive length for single lap joint without eccentricity

The transfer of force from one flange to the other is concentrated at both edges of the lap joint. This theory leads to peak shear stresses at $x/L = 0$ and $x/L = 1$.

The shear stress concentration factor, using the maximum shear stress, is defined as:

$$f = \frac{\tau_{\max}}{\tau_m} \quad [10.11-21]$$

where τ_m is given by:

$$\tau_m = \frac{N/2}{bL} \quad [10.11-22]$$

As given in Ref. [10-12], the factor f is constant for different joints when the correlation factor K is constant.

$$K = \frac{GLb}{Etb} \frac{L}{t_a} = \frac{GL^2}{Ett_a} \quad [10.11-23]$$

The stress peaks at both edges of the bonding are obtained by means of f_1 and f_2 .

f_2 is calculated as a function of correlation factor K and the stiffness ratio by:

$$f_2 = \sqrt{\frac{K_2}{\omega_2} \frac{\omega_2 - 1 + \cosh \sqrt{\omega_2 K_2}}{\sinh \sqrt{\omega_2 K_2}}} \quad [10.11-24]$$

with:

$$\omega_2 = \frac{E_1 t_1 + E_2 t_2}{E_1 t_1} \quad [10.11-25]$$

The function $f_2 = f(K_2)$ is shown in Figure 10.11-7 for different stiffness ratios, ω_2 .

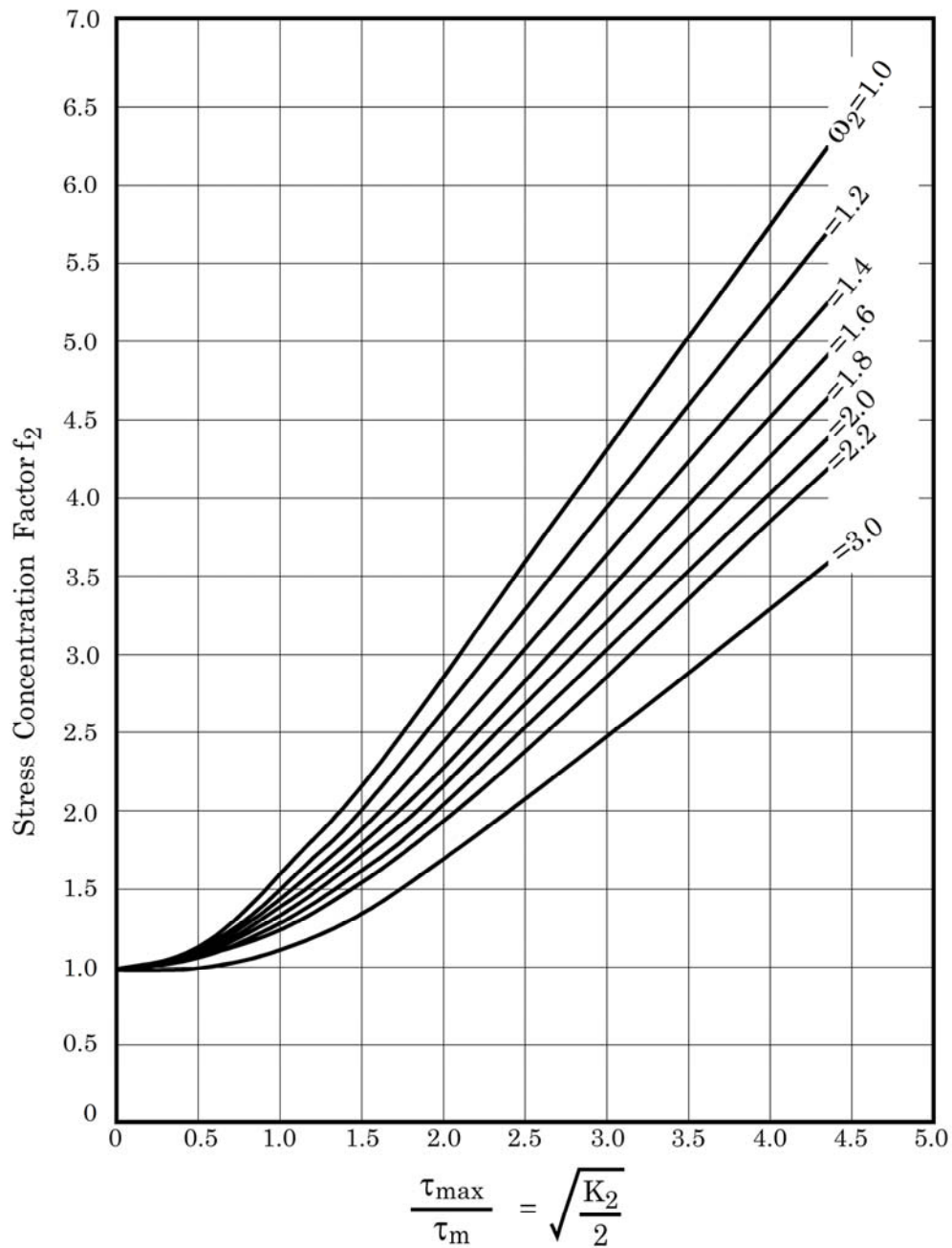

Figure 10.11-7 - Stress concentration factor as a function of correlation factor with stiffness ratio parameter

The peak shear stresses obtained by using the linear elastic theory are reduced when the characteristic shear stress-strain curve is non linear. This reduction is important only when a static analysis is performed. For life endurance calculations only the linear elastic region of the characteristic curve can be used.

10.11.4.2 Large overlap length and adherends of the same materials and thicknesses

When overlap sheets are of the same material, $E_1=E_2$, $t_1=t_2$, therefore:

$$\omega_2 = \frac{E_1 t_1 + E_2 t_2}{E_1 t_1} = 2 \quad [10.11-26]$$

and:

$$\frac{\tau_{\max}}{\tau_m} = \sqrt{\frac{K_2}{\omega_2}} \frac{1 + \cosh \sqrt{\omega_2 K_2}}{\sinh \sqrt{\omega_2 K_2}} = \sqrt{\frac{K_2}{2}} \coth \sqrt{\frac{K_2}{2}} \quad [10.11-27]$$

When $K_2 > 10$, the variable $\coth \sqrt{\frac{K_2}{2}}$ is approximately 1, which results in:

$$\frac{\tau_{\max}}{\tau_m} = \sqrt{\frac{K_2}{2}} = \sqrt{\frac{GL^2}{2Ett_a}} = L \sqrt{\frac{G}{2Ett_a}} \quad [10.11-28]$$

$$\tau_{\max} = L \tau_m \sqrt{\frac{G}{2Ett_a}} \quad [10.11-29]$$

$$\tau_m = \frac{N/2}{Lb} \quad [10.11-30]$$

$$\tau_{\max} = \frac{N}{2b} \sqrt{\frac{G}{2Ett_a}} \quad [10.11-31]$$

For long overlap lengths, the maximum shear stress is independent of the length of the joint. Considering that the load transfer is concentrated at the ends of the joint, the shear stress is reduced to zero in the middle part of the overlap zone; as shown in Figure 10.11-7.

As the **lap joint** length increases, the mean shear stress decreases. This leads to higher shear stress concentration factors. However, for $K > 10$, this behaviour is linear; as shown in Figure 10.11-8.



Figure 10.11-8 - Shear stress distribution for large overlap lengths

10.11.4.3 Shear stresses in the adhesive due to temperature

Shear stresses occur in the adhesive due to different coefficients of thermal expansion, α_T of the adherends.

For this kind of loading it is impossible to define a comparative correlation factor; shown in Figure 10.11-9.

It, therefore, appears reasonable to formulate the shear stress as a function of the normalised overlap length, x/L due to a 100 K temperature rise; as illustrated in Figure 10.11-10 and Figure 10.11-11. These figures show bonded joints between **CFRP** HT unidirectional (60 vol.%) and aluminium, titanium, **GFRP** quasi isotropic, and **GFRP** unidirectional materials.

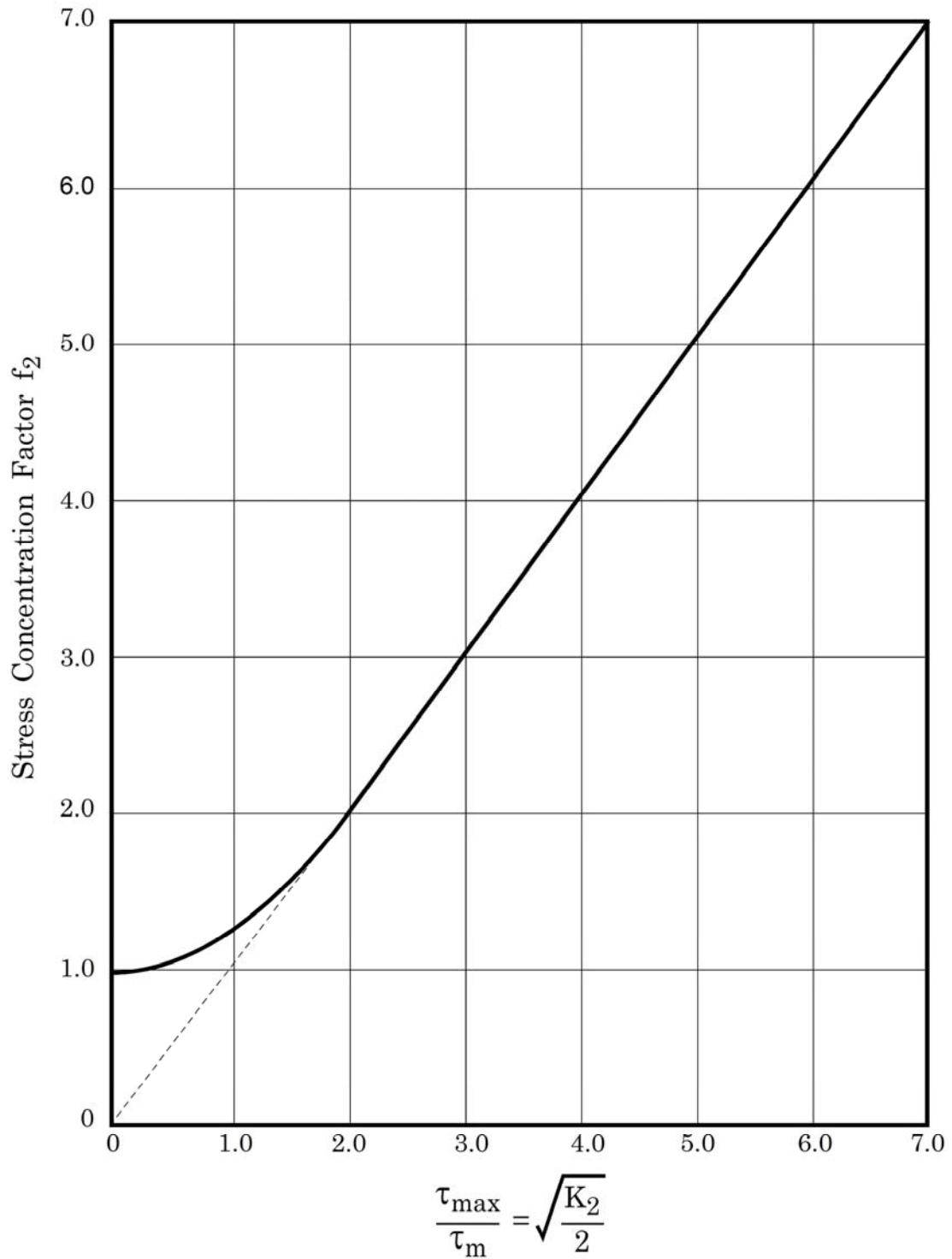

Figure 10.11-9 - Stress concentration factor for large overlap lengths

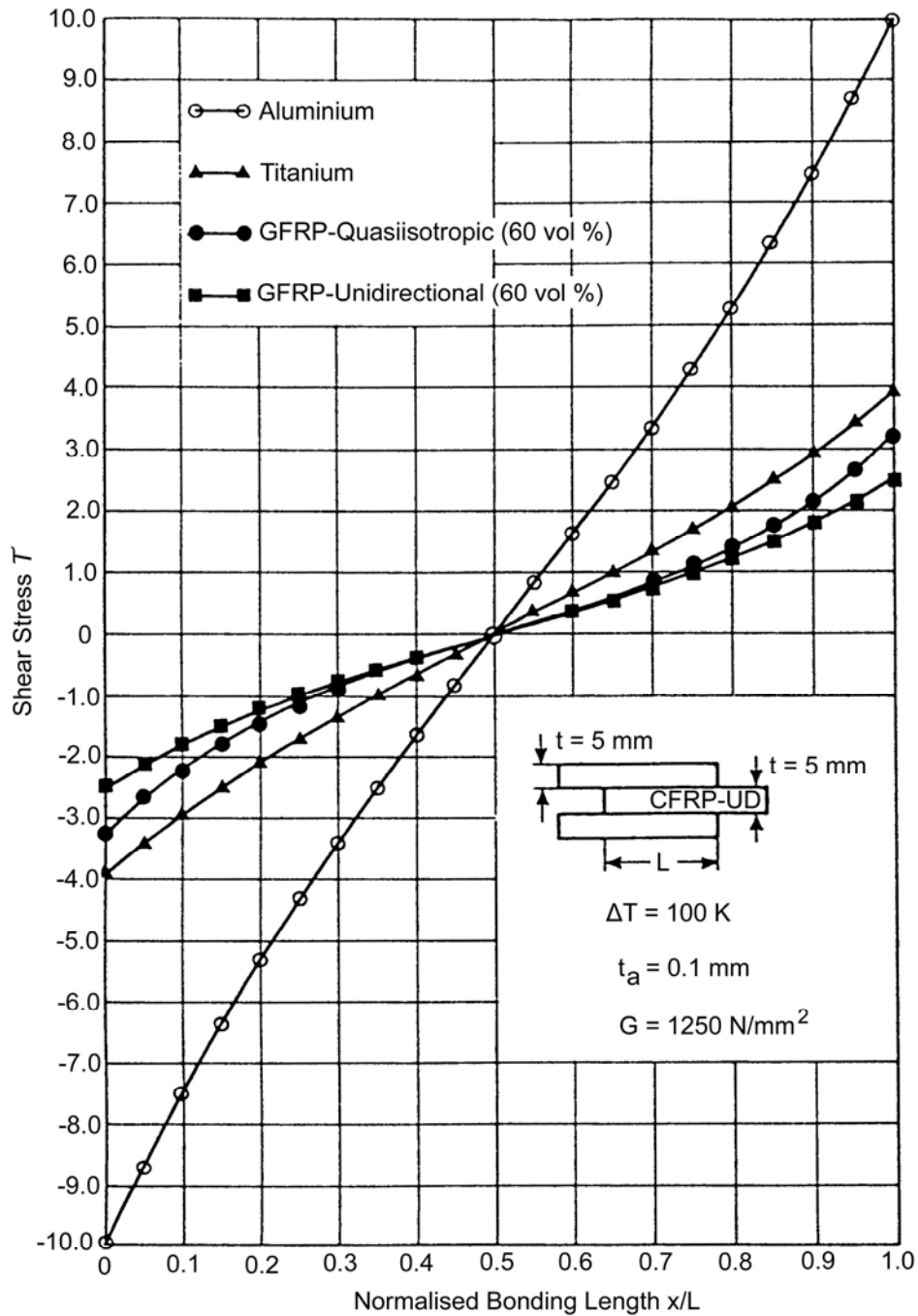

Figure 10.11-10 – UD CFRP-HT: Shear stress distribution versus the normalised bond length

The maximum shear stresses are

- independent of the overlap length, L

but

- directly dependent on the product of the difference in temperature and the difference in the coefficient of thermal expansion of the adherends.

The theory does not consider that the shear stress at $x/L = 0$ and $x/L = 1$ are zero.

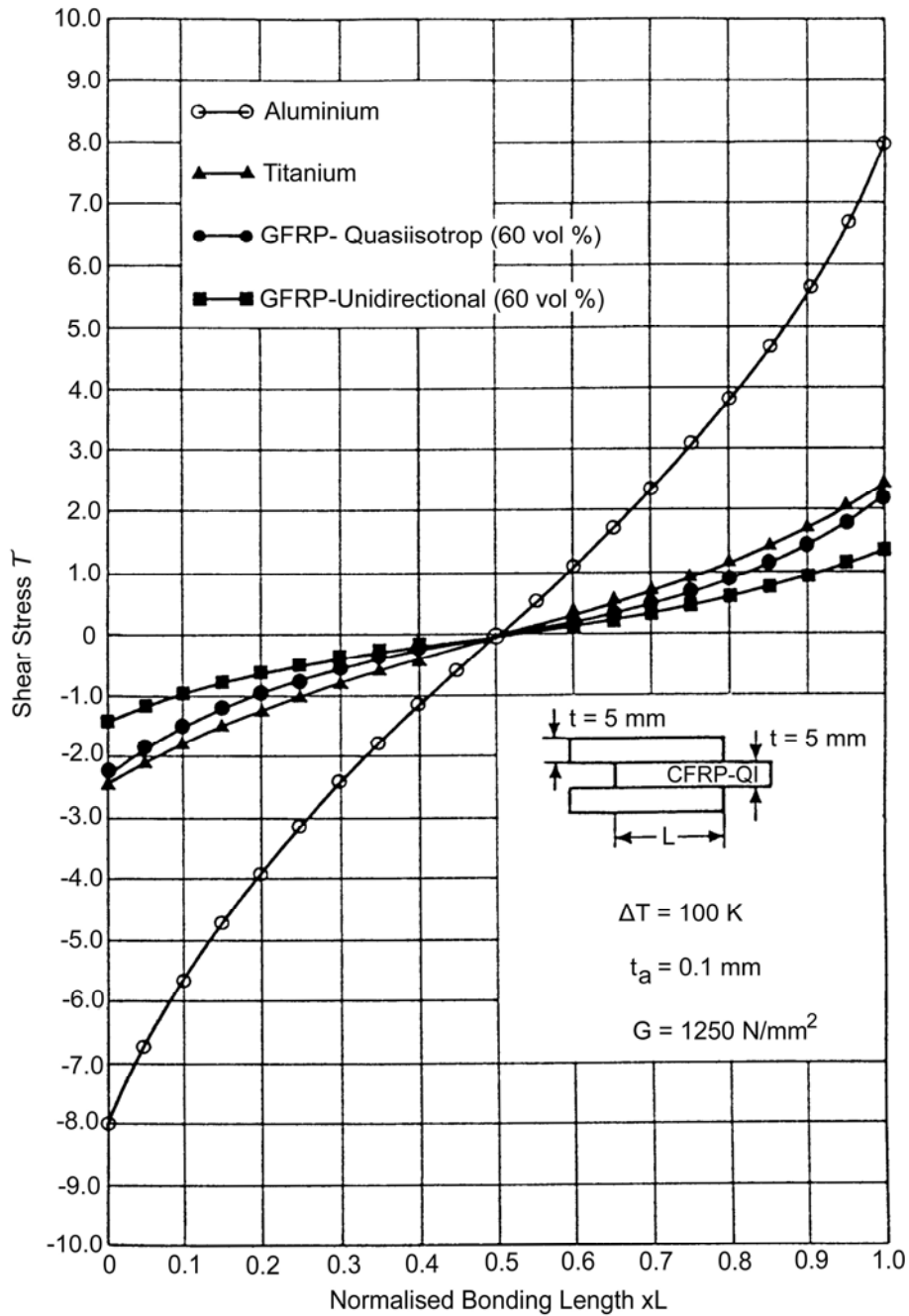

Bonded joint between CFRP-HT quasi-isotropic (60 vol.%) and aluminium, titanium, GFRP quasi-isotropic, and GFRP unidirectional materials.

Figure 10.11-11 – Quasi-isotropic CFRP-HT: Shear stress distribution versus the normalised bond length

10.11.5 Single taper scarf joint

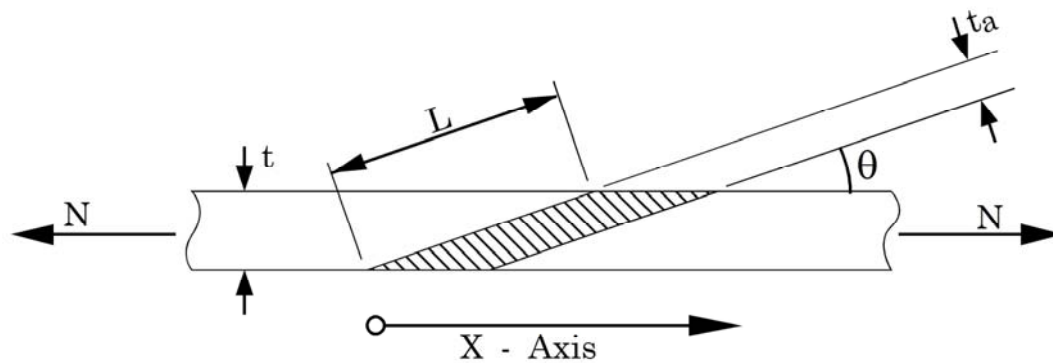

Figure 10.11-12 - Analysis: Notation for single taper scarf joint

The tensile load, N produces a shear stress, τ_m in the adhesive layer:

$$\tau_m = \frac{N \cos \theta}{L} = \frac{N \cos \theta}{t} \sin \theta \quad [10.11-32]$$

$$\tau_{\max} = K \tau_m \quad [10.11-33]$$

where:

$$K = \sqrt{\frac{1}{4} \left[\tan \theta (1 - \psi) - \frac{E_a}{E} \cot \theta \right]^2 + 1} \quad [10.11-34]$$

and:

$$\psi = \nu_a - \nu_{xz} \frac{E_a}{E} \quad [10.11-35]$$

In general,

$$\theta < 20^\circ \text{ and } \frac{E_a}{E} \ll 1$$

Hence:

$$K \approx 1 \text{ and } \tau_{\max} \approx \tau_m$$

10.11.6 Double taper scarf joint

10.11.6.1 Symmetrical

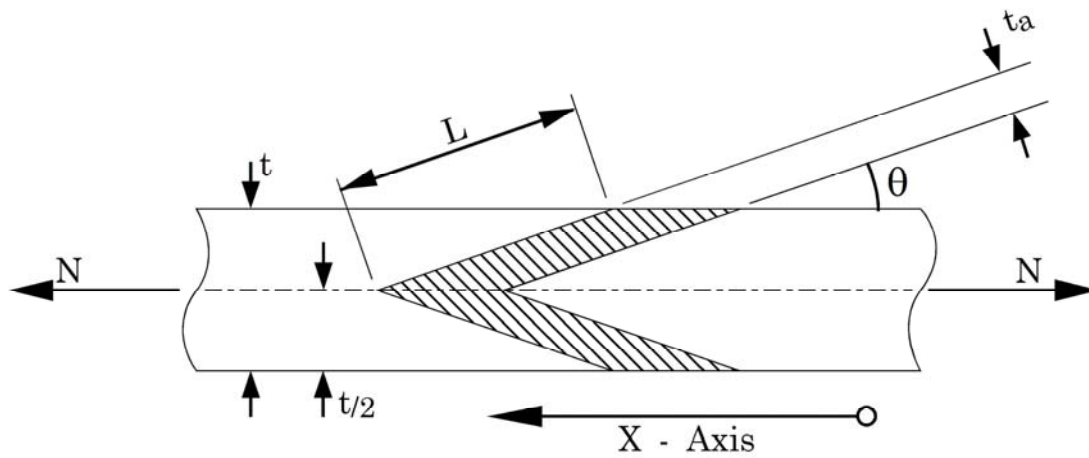

Figure 10.11-13 - Analysis: Notation for symmetrical double tapered scarf joint

The tensile load, N produces a shear stress τ_m in the adhesive layer, according to:

$$\tau_m = \frac{N \cos \theta}{2L} = \frac{N \cos \theta}{2t} 2 \sin \theta = \frac{N \cos \theta \sin \theta}{t} \quad [10.11-36]$$

$$\tau_{\max} = K \tau_m \quad [10.11-37]$$

where:

$$K = \sqrt{\frac{1}{4} \left[\tan \theta (1 - \psi) - \frac{E_a}{E} \cot \theta \right] + 1} \quad [10.11-38]$$

and:

$$\psi = \nu_a - \nu_{xz} \frac{E_a}{E} \quad [10.11-39]$$

This case is similar to the single taper scarf joint with the difference that the bond length needed is half that of the double lap shear joint.

10.11.7 Stepped lap joint

10.11.7.1 Recessed and simple

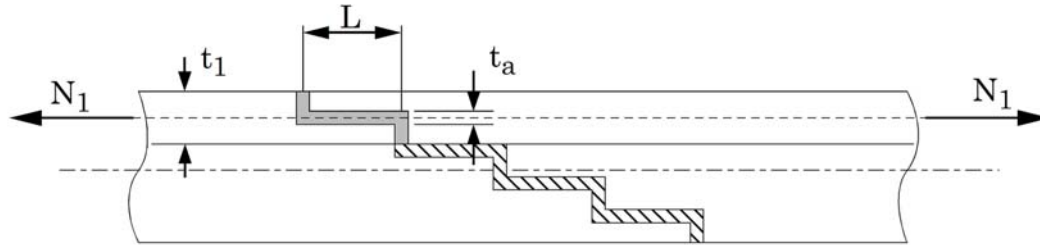

Figure 10.11-14 - Analysis: Notation for stepped lap joint (recessed and simple)

For three or fewer steps, this type of joint can be analysed by taking each lap as a single lap of thickness, t .

The recessed and simple configurations are similar, with the only difference that the load transfer (in the case of three or less steps) occurs generally about the common midplane.

For each step:

$$\tau_m = \frac{N}{L} \quad [10.11-40]$$

$$\tau_{\max} = K \tau_m \quad [10.11-41]$$

where:

$$K = \frac{1}{4} [WL(1 + 3\alpha) \coth WL + 3(1 - \alpha)] \quad [10.11-42]$$

$$W = \left[\frac{2(1 - \lambda_{xy})G}{Ett_a} \right]^{1/2} \quad [10.11-43]$$

$$\alpha = \frac{1}{1 + 2\sqrt{2} \tanh \left[\frac{L}{t} \left[\frac{3(1 - \lambda_{xy})N}{2Et} \right]^{1/2} \right]} \quad [10.11-44]$$

$$\lambda_{xy} = \mathbf{v}_{xy} \mathbf{v}_{yx} \quad [10.11-45]$$

For each step:

N is N_1 , N_2 or N_3

L is L_1 , L_2 or L_3

t is t_1 , t_2 or t_3

There are stress concentrations in the case of three or fewer steps.

For four or more steps, shown in Figure 10.11-15, the analysis of double lap joints can be carried out by taking the step thickness t_1 and $t_2/2$.

[See: Double lap shear joint]

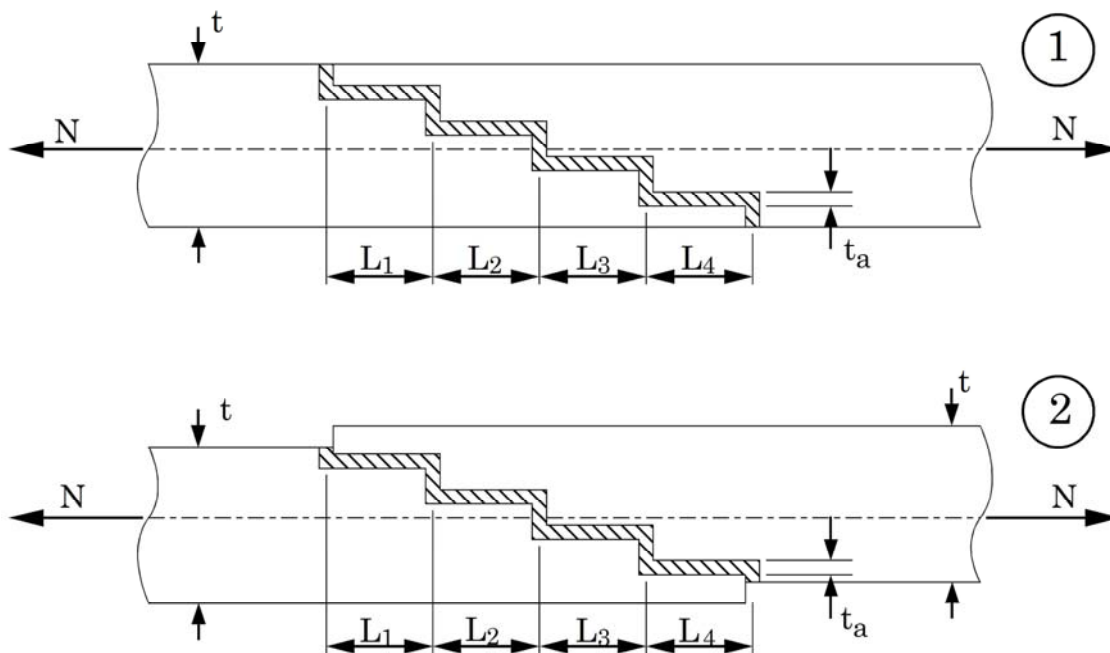

Figure 10.11-15 - Analysis: Notation for recessed and simple scarf joints (four or more steps)

10.11.8 Analysis of environmental factors

The effects of the environment on the properties of adhesive bonds are part of the joint analysis, [See: 7.3, 10.3].

An example of the analytical approach used to evaluate the effects of temperature on adhesive shear stress is included in the Astrium spread-sheet, [See: 10.14].

The **ESAComp**[®] commercial software, [See: 10.13, Annex B], has the capability to analyse the effects of temperature and moisture, either singly or combined, for various joint configurations.

[See also: Shear stresses in the adhesive due to temperature for double-lap joint configuration]

10.12 Analytical design tools

10.12.1 General

Analytical computer programs, of varying complexity, have been developed to aid the design of joints. These are almost a necessity for the more complex stepped and **scarfed** joints between dissimilar adherends.

The analysis tools and software cited are examples of what is available. It does not infer an endorsement for its adoption in space projects without undergoing the necessary evaluation processes.

10.12.2 Commercial software

Some examples of commercially-available analysis software include:

- **ESAComp**[®] is a software package available from [Componeering Inc.](#), Finland, Ref. [10-13], . It is widely used by design engineers and stress analysts for the design and analysis of composite laminates and structural elements; including bonded joints, [See: 10.13].
- [ESDU International](#) produce design aids for engineers working in a range of engineering fields; several of their products are for bonded joint design and analysis, [See: 10.15].
- Finite element analysis is needed for the analysis of joints of complex section, Ref. [10-5]. A number of software packages are based on linear-elastic or non-linear-elastic models, Ref. [10-2]. [See also: 21.6 for an example of the use of **FEA** models in analysing bonded joints between **CFRP** tubes and titanium end fittings].
- Hart-Smith developed computer programs for analysing double-lap and single-lap **joints**, with identical or dissimilar **adherends**, for parallel, stepped, scarf and double straps, Ref. [10-3].

10.12.3 In-house software

Many aerospace organisations develop their own, in-house software for design calculation and analysis purposes. The software is based on universally-accepted mathematical expressions, often adapted for use as a spread sheet.

An example of an in-house, spread-sheet application is provided by Astrium (Germany), [See: 10.14].

10.13 ESAComp[®]

10.13.1 Background

ESAComp[®] is software for the analysis and design of composite laminates and laminated structural elements.

The development work was initiated by the [European Space Agency](#) - ESTEC, who envisioned open software which combines all necessary composites analysis and design capabilities under one

unified user interface. Although it originated in the aerospace field, ESAComp has developed as a general tool for people dealing with composites, both in industry and in research.

The core of the ESAComp® development work was conducted under an ESA/ESTEC contract by [Helsinki University of Technology, Laboratory of Lightweight Structures](#) and its partners. The first official release of ESAComp was in 1998. In 2000, the development work was transferred to [Componeering Inc.](#) (Finland), which also serves as the software distributor and provider of ESAComp support services. Version 4 was released in 2007.

Owing to the ability to interface with widely-used finite element software packages, ESAComp fits seamlessly into the design process.

[See also: [Componeering Inc.](#) website for access to program and documentation]

10.13.2 Usage and scope

10.13.2.1 General

ESAComp® has a vast set of analysis and design capabilities for solid and sandwich laminates and for micro-mechanical analyses. It also includes analysis tools for structural elements, including:

- Plates.
- Stiffened panels.
- Beams and columns.
- Mechanical joints.
- Bonded joints.
- Add-on modules: Cylindrical shells, stiffened cylindrical shells.
- Interface modules for commercial FE analysis software.

10.13.2.2 Bonded joints

The ESAComp® analysis features for bonded joints include:

- Types of joints: single and double lap; single and double strap; single and double sided scarfed lap; bonded doubler.
- Beam and plate models for adherends, linear and non-linear adhesive models.
- Combinations of axial, bending, in-plane and out-of-plane shear loads.
- Joint deflection forces and moments in adherends, adhesive stresses, margins of safety for cohesive failure of adhesive and laminate failure due to in-plane and bending loads.

10.13.3 Analysis and data

ESAComp® is based on the concept of objects, which represent the individual elements of a more complex structure, e.g. fibres, matrix materials, plies, laminates, adhesives, joints and loads

Bonded joints, or similar complex items, are created by combining simpler objects, e.g.:

- Fibres and matrix materials are combined to form plies

- Plies are combined to form laminates
- Laminates are combined to form structural elements

The properties and geometry of the adhesive joints between such structural elements are then defined. Unlike matrix materials, the adhesives can behave in a non-linear stress-strain fashion.

The geometric boundary conditions for the bonded joint and the mechanical loads applied are combined as a single object.

Analyses are performed by first selecting the objects and stipulating any additional data for the analysis. For example, the additional data can include selection of the analysis type (load response or failure), adhesive model (linear elastic or non-linear), and adherend model (plate or beam).

A load response analysis gives as output the fundamental variables for the adherends and the adhesive layer stresses, a typical example of this shown in Figure 10.13-1, Ref. [10-13].

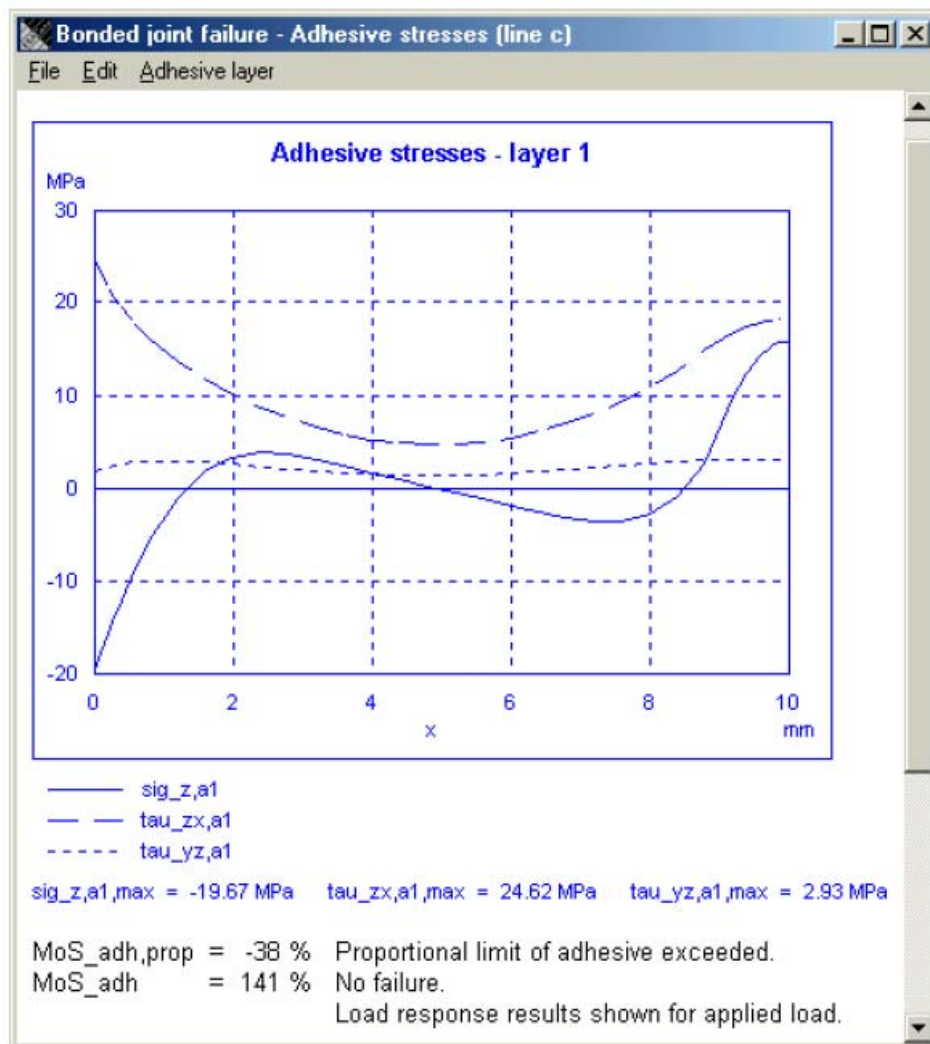

Predicted using the non-linear adhesive model

Figure 10.13-1 – ESAComp: Double lap joint - example of stresses in the adhesive layer (non-linear adhesive model)

Failure analysis gives the same output as the load response analysis and, in addition, the reserve factor or margin of safety for the cohesive failure of the adhesive; as shown in Figure 10.13-2, Ref. [10-13].

The failure analysis is performed by iterative use of the load response analysis while incrementing the load until failure is reached. The fundamental variables and the adhesive layer stresses determined in the failure analysis are given for the applied load or for the failure load if the margin of safety is less than zero.

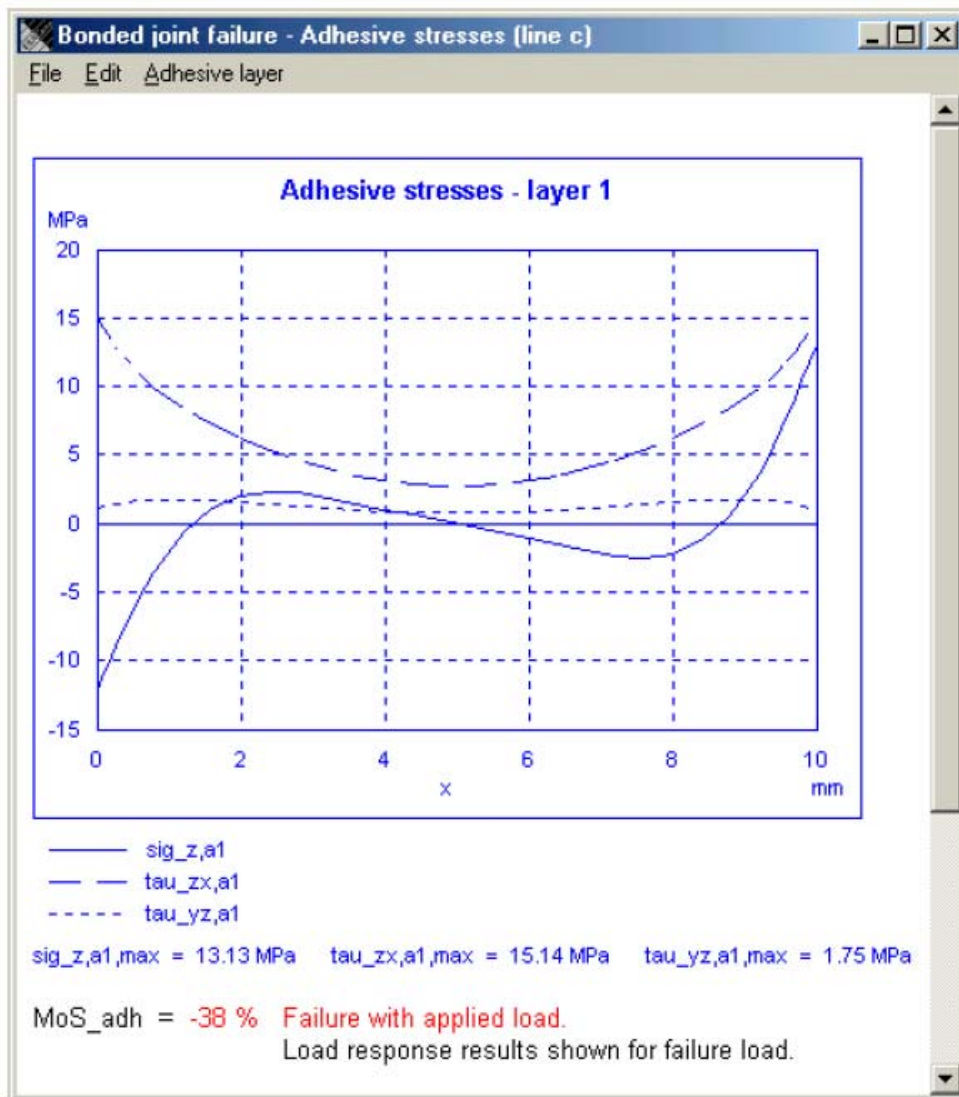

Predicted using the non-linear adhesive model

Figure 10.13-2 – ESAComp: Double lap joint - example of stresses in the adhesive layer (linear adhesive model)

In addition to cohesive failure of the adhesive, failure of the adherends due to joint-induced bending moments is predicted. Laminate FPF first-ply-failure analysis is used for assessing laminate failure of potentially critical locations in the vicinity of the joint. The in-plane forces and bending moments acting at these locations are obtained from the joint analysis. For comparison, FPF reserve factors or margins of safety computed away from the joint are also displayed.

Other possible bonded joint failure modes, such as adhesive-to-adherend interface failure or failure in the adherends are not predicted, but the adhesive stresses computed in the joint analysis can be used as the basis for assessing the criticality of these modes.

[See also: Annex B for **ESAComp** interactive example]

10.14 Astrium: Example spreadsheet

10.14.1 General

Many aerospace organisations develop their own, in-house software for design calculation and analysis purposes, often in the form of a spreadsheet using widely-known, commercial software packages.

The example of an in-house, spread-sheet application is provided by Astrium GmbH, Germany, which uses Microsoft Excel®.

The Astrium GmbH spreadsheet application is given as an example only and does not infer an endorsement for its adoption in space projects without undergoing the necessary validation processes.

The file can be accessed via following link [Astrium-Example-Joint Design.xls](#),

or by opening the file: Astrium-Example-Joint Design.xls (which is included in the zip-file of this handbook).

10.14.2 Usage and scope

The spreadsheet is used for linear-elastic analysis of new joints under design loads.

10.14.3 Analysis and data

10.14.3.1 General

For convenience, the spreadsheet is structured into a number of worksheets.

10.14.3.2 Test sample

This includes a description of the verification steps in the analysis of bonded joints, e.g.:

- Recalculate stress distribution of the test sample, normally same adhesive tested at RT;
- Determine peak stress at the edge of the sample;
- Calculate stress distribution in the new joint;
- Demonstrate positive margin of safety. The test sample needs to be similar to or stiffer than the new joint;
- Verification of bonded joints under extreme temperatures. Testing is needed for temperatures outside the qualification temperatures of the adhesive;
- Lay-up of **CFRP adherends**: The out-of-plane skin strength (similar to 90° strength of UD) can be very low and thus failure of the bonding occurs in the first layer due to out-of-plane stresses in the order of the maximum shear stresses in the bond, [See also: 6.4].

10.14.3.3 Fatigue

The proposed approaches for verification of fatigue are based on either available fatigue data for materials or from the structural Material Handbook; ECSS-E-HB-32-20[See: 11]:

- test data on similar joint geometry and materials;
- test data for same adhesive but different joint.

Figure 10.14-1 shows a typical output from the fatigue analysis which shows a comparison between the materials data input approach and that determined using the handbook design guidelines, [See: 11].

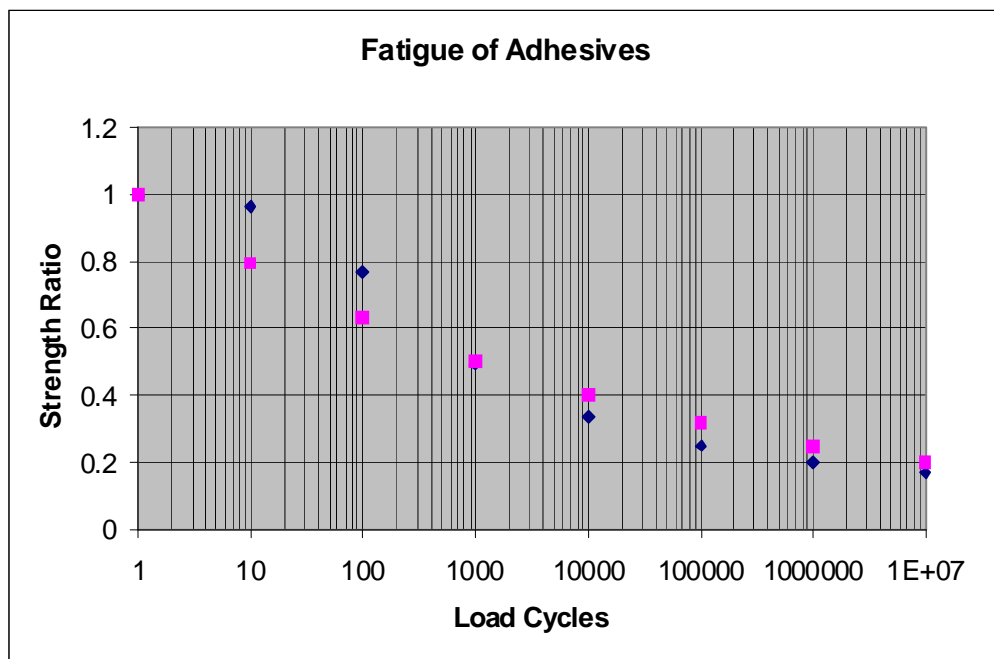

Figure 10.14-1 – Astrium example spread-sheet: Fatigue data, determined by analysis

10.14.3.4 Materials

This gives details of the adherends to be bonded, property data for adhesives and the bond characteristics, e.g.

- Adhesive: product reference number and source;
- Adherend, e.g. material and thickness;
- Elastic modulus (adhesive);
- Ultimate strain (adhesive);
- Shear modulus (adhesive);
- Shear strength (average);
- Bondline length;
- Bondline thickness;

- Fatigue 10^4 cycles peak stress;
- Fatigue endurance 10^7 cycles peak stress;
- Reference, data source or notes relating to the origin;
- Type of sample, e.g. standard test method.

10.14.3.5 New joint: Linear analysis under design loads

The worksheet includes input data (fixed values) and calculated variables. The output is determined using the data for positions along the bondline and can also be presented graphically; as shown in Figure 10.14-2

Input				Variables (calculated)						
	E-modulus	thick-ness	CTE	G-modulus	E*T	Ce	R	lambda	Fth	Fth0
Adherend 1	70000	1	2.30E-05		70000	41176.47	0.258643	0.508569	2.20E-03	80.84917
Adherend 2	100000	1	1.00E-06		100000					
Adhesive		0.1		1065			max.	Fthermal=	-	90.5882
Length [mm]	20									
Line Load [N/mm]	100			Smean=	5					
Temperature	100			Kt,mech=	5.98349					
Output (calculated)										
Position	Xi	Smech	Sthermal	Scombined						

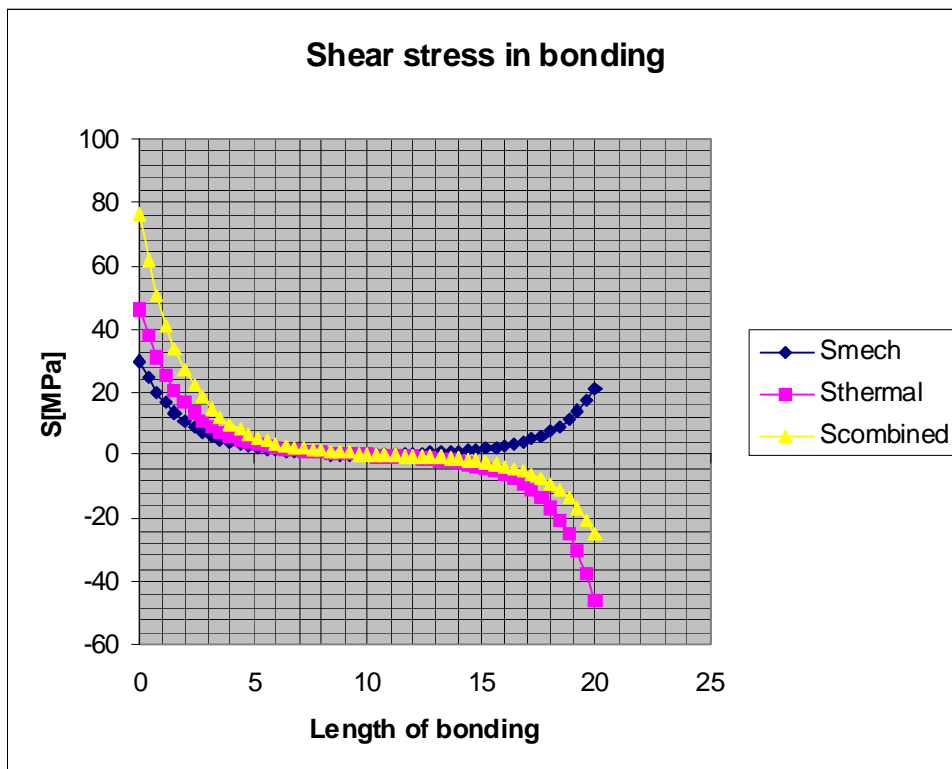

Figure 10.14-2 – Astrium example spread-sheet: Joint design (new)

10.15 ESDU data and software

10.15.1 General

[ESDU International plc](#) (UK) provide a range of data and computer-based analysis tools for bonded joints; as shown in Table 10.15-1.

Users are advised to check the availability of data and the status of software directly with the supplier.

Table 10.15-1 - ESDU data items for bonded joints

ESDU Data Item [See: 10.15]	Title
ESDU 78042: Bonded joints - 1	Shear stresses in the adhesive in bonded single-step double-lap joints in tension.
ESDU 79016: Bonded joints – 2	Inelastic shear stresses and strains in the adhesive bonding of lap joints loaded in tension or shear.
ESDU 80011: Bonded joints – 3	Elastic stresses in the adhesive in single-step double-lap bonded joints.
ESDU 80039: Bonded joints – 4	Elastic adhesive stresses in multi-step lap joints loaded in tension.
ESDU 81022: Bonded joints – 5	Guide the use of data items in the design of bonded joints.

10.15.2 ESDU 78042: Bonded joints - 1

10.15.2.1 Title

Shear stresses in the adhesive in bonded single-step double-lap joints loaded in tension.

10.15.2.2 Usage and scope

In order to design bonded lap joints it is necessary to determine the stress distribution in the adhesive. The shear stresses are one of the major components of the stress distribution. Therefore an assessment of their maximum value, taking into account their inelastic behaviour, is necessary. This Data Item is complementary to the computer program in ESDU Data Item No. 79016, and examines the single step joint.

A major design objective is that of minimising stresses by careful selection of joint geometry and adhesive.

[See also: 10.15.6 "ESDU 81022: Bonded joints – 5" for peel or direct normal stresses]

10.15.2.3 Analysis and data

The distribution of shear stress in the adhesive is determined by means of a shear lag analysis. This stress results from the transmission of the in-plane tension or shear loads from one adherend to the

other, via the adhesive. The analysis takes account of the non-linear stress-strain shear characteristics of the adhesive. The adherends are assumed to be rigid in flexure, hence, no account is taken of any peel or bending effects in the adhesive or the adherends. The adherend is assumed to behave elastically.

The joint stresses are calculated with the aid of the program in ESDUpac A7916, [See also: 10.15.3 "ESDU 79016: Bonded joints – 2"], and are presented graphically for three different adhesive materials (properties stated). The graphs show how the maximum stress is influenced by the geometry and stiffnesses of the joint, and aid the use of the program. Clear trends are discernible and the factors influencing the stresses and their relative sensitivity can be seen.

10.15.3 ESDU 79016: Bonded joints – 2

10.15.3.1 Title

Inelastic shear stresses and strains in the adhesives bonding lap joints loaded in tension or shear.

10.15.3.2 Usage and scope

In order to design bonded lap joints, it is necessary to determine the stress distribution in the adhesive. In order to smooth the stress distribution, most joints are stepped, hence details of the stress distribution at each step are needed. Shear stresses are a major component of the stress distribution and their maximum value, taking into account the inelasticity of the adhesive and adherend stiffnesses, is necessary. A design objective is to select the combination of step geometries and adhesive stiffness to minimise the shear stresses and so obtain an optimum joint.

[See also: 10.15.6 "ESDU 81022: Bonded joints – 5" for peel stresses]

10.15.3.3 Analysis and data

The distribution of shear stress in the adhesive is determined by means of a shear lag analysis. This stress results from the transmission of the in-plane tension or shear loads from one adherend to the other, via the adhesive. The analysis takes account of the non-linear stress-strain shear characteristics of the adhesive. The adherends are assumed to be rigid in flexure, hence no account is taken of any peel or bending effects in the adhesive or the adherends. The adherend is assumed to behave elastically. Each step is divided up into small increments and the stress distribution over each increment is assumed to be uniform.

10.15.3.4 ESDUpac A7916

Previously ESDUpac E1007.

This program calculates the shear stresses and strains in the adhesives in multi-step lap joints:

- Input
 - Number of steps in joint.
 - Geometry and elastic properties of adherends over each step.
 - Elastic shear modulus for adhesive.
 - Shear stress in the adhesive at its elastic limit.
 - Shear stress to which the adhesive stress-strain curve is asymptotic.
 - Number of increments in each step.

- Requirement for tension or transverse shear loading on joint.
- Output
 - Adhesive shear stresses and strains at each increment on every step.
 - Adherend nominal stresses at each increment on every step.
 - All input data.

10.15.4 ESDU 80011: Bonded joints – 3

10.15.4.1 Title

Elastic stresses in the adhesive in single-step double-lap bonded joints.

10.15.4.2 Usage and scope

In order to design bonded joints, it is necessary to determine the stress distribution in the adhesive. The normal (through-thickness) stresses and the shear stresses are the major stresses governing joint design. The normal stresses peak at the ends of the joints. This Data Item is complementary to the computer program in Data Item No. 80039, [See: 10.15.5 "ESDU 80039: Bonded joints – 4"], and examines a single-step joint. A major design objective is minimising the stresses by careful selection of joint geometry and adhesive.

10.15.4.3 Analysis and data

The data are based on the elastic flexible joint analysis, as described in 10.15.5 "ESDU 80039: Bonded joints – 4". The joint stresses are calculated with the aid of the program of ESDUpac A8039 and are presented graphically for a range of non-dimensional parameter ratios of joint component stiffnesses and geometry. The graphs show how the stresses are influenced by the geometry and stiffnesses, and so aid design of this and more complex types of joints. Clear trends are discernable and the relative sensitivity of stresses to the factors affecting them can be seen.

10.15.5 ESDU 80039: Bonded joints – 4

10.15.5.1 Title

Elastic adhesive stresses in multi-step lap joints loaded in tension.

10.15.5.2 Usage and scope

In order to design bonded joints it is necessary to determine the stress distribution in the adhesive. The normal (through-thickness) stresses and the shear stresses are the major stresses governing joint design. The normal stresses peak at the ends of the joint, and where steps in the adherend are introduced, the maximum usually occurs at the extreme ends. A design objective is the selection of joint geometry and adhesive to prevent failure under the normal stresses developed.

10.15.5.3 Analysis and data

The program is based on the elastic flexible joint analysis. The analysis determines the distribution of shear stresses and normal stresses in the adhesive resulting from the transmission of in-plane

tension loads between adherends via the adhesive. The joint is assumed to be free from external bending moments. The assumptions made are:

- Adherend stresses normal to the plane of the joint and adhesive stresses in the plane of the joint are negligible.
- The joint and its adjacent sheet are taken to behave according to the theory of cylindrical bending of plates of stepped cross-section and neutral plane.
- The adhesive layer behaves elastically, is negligibly thin and provides a perfect shear connection between the two adherends.

Consequently, at both ends of the bonded length, and the inter-step boundaries, the total joint depth is immediately effective in bending and in tension. This leads to an overestimate of the stress, but has little influence on the stresses in the case of multi-step joints.

10.15.5.4 ESDUpac A8039

Previously ESDUpac E1020.

This program calculates the elastic shear and normal stresses in a bonded lap joint.

- Input
 - Number of steps in the joint and joint configuration type number.
 - Elastic properties of adherends.
 - Elastic properties of adhesive.
 - Geometry and applied loading.
- Output
 - Shear and normal stress distribution across the joint and their ratios to their average value in the joint.
 - Joint geometry and elastic properties of the adhesive and each adherend.
 - Applied loading.
 - All input data.

10.15.6 ESDU 81022: Bonded joints – 5

10.15.6.1 Title

Guide to the use of data items in the design of bonded joints.

10.15.6.2 Usage and scope

In order to make the most efficient use of data for the analysis of bonded joints it is necessary to understand their limitations. It is also helpful to know their relationships to the other analytical methods available. The influence of the data on the resulting designs is also of interest. The scope of the data available in ESDU Data Items on bonded joints is described, together with the available data on joint design; as summarised in Table 10.15-1.

10.15.6.3 Information and guidance

The major theories on analysis of the strength of bonded joints are briefly noted. A comparison of the analytical methods and their relevance to joint design is given. This commences with the joint types and then relates joint failure modes to the data available for assessing failure.

A major factor in designing bonded joints is the availability of the strength and stiffness properties of the adhesive. Where these are not available they are determined experimentally. Suitable test methods for this are described. Data for 14 adhesives are listed and shear stress-strain curves given. The major factors influencing the strength data are discussed and the influence of some are illustrated, e.g. temperature and humidity.

10.16 Design chart

10.16.1 Aide memoire

The successful design of an adhesively-bonded joint relies on the full evaluation of numerous interrelated factors.

Figure 10.16-1 serves as an *aide-memoire* for the many factors to be considered during a bonded design. It also shows cross-references to guidelines given in this handbook and to some mandatory ECSS standards for space applications.

10.16.2 Joint category

Joints can be categorised regarding their role and criticality within a structure. This is linked to the means needed to verify their integrity, e.g. through inspection and testing. Figure 10.16-2 shows an example of this approach; provided by Astrium Ltd., UK.

The chart in Figure 10.16-2 has been adapted slightly from an original provided by Astrium UK which had a copyright statement. Its inclusion in the final version of the handbook remains the subject of the written approval of Astrium's legal department.

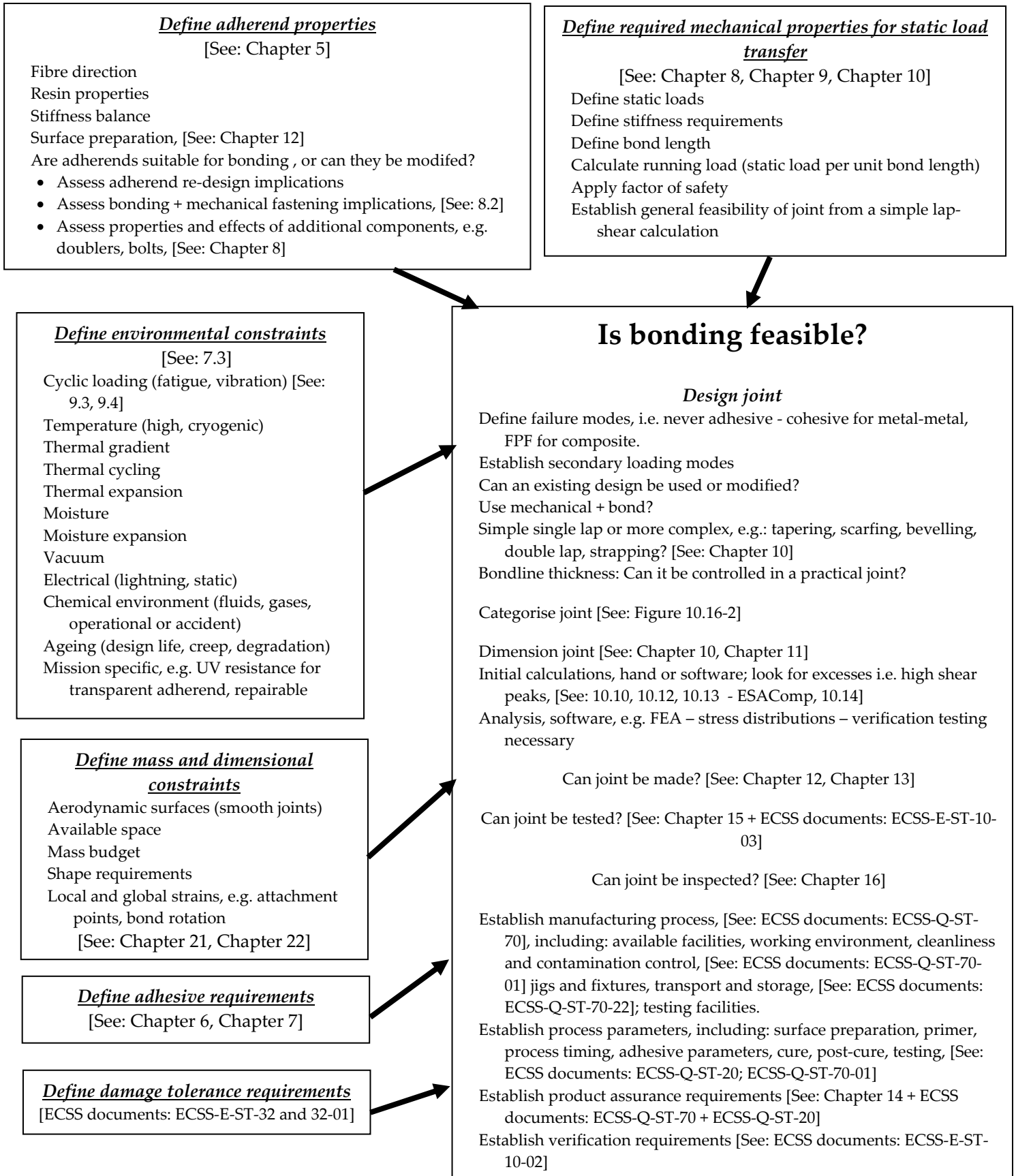
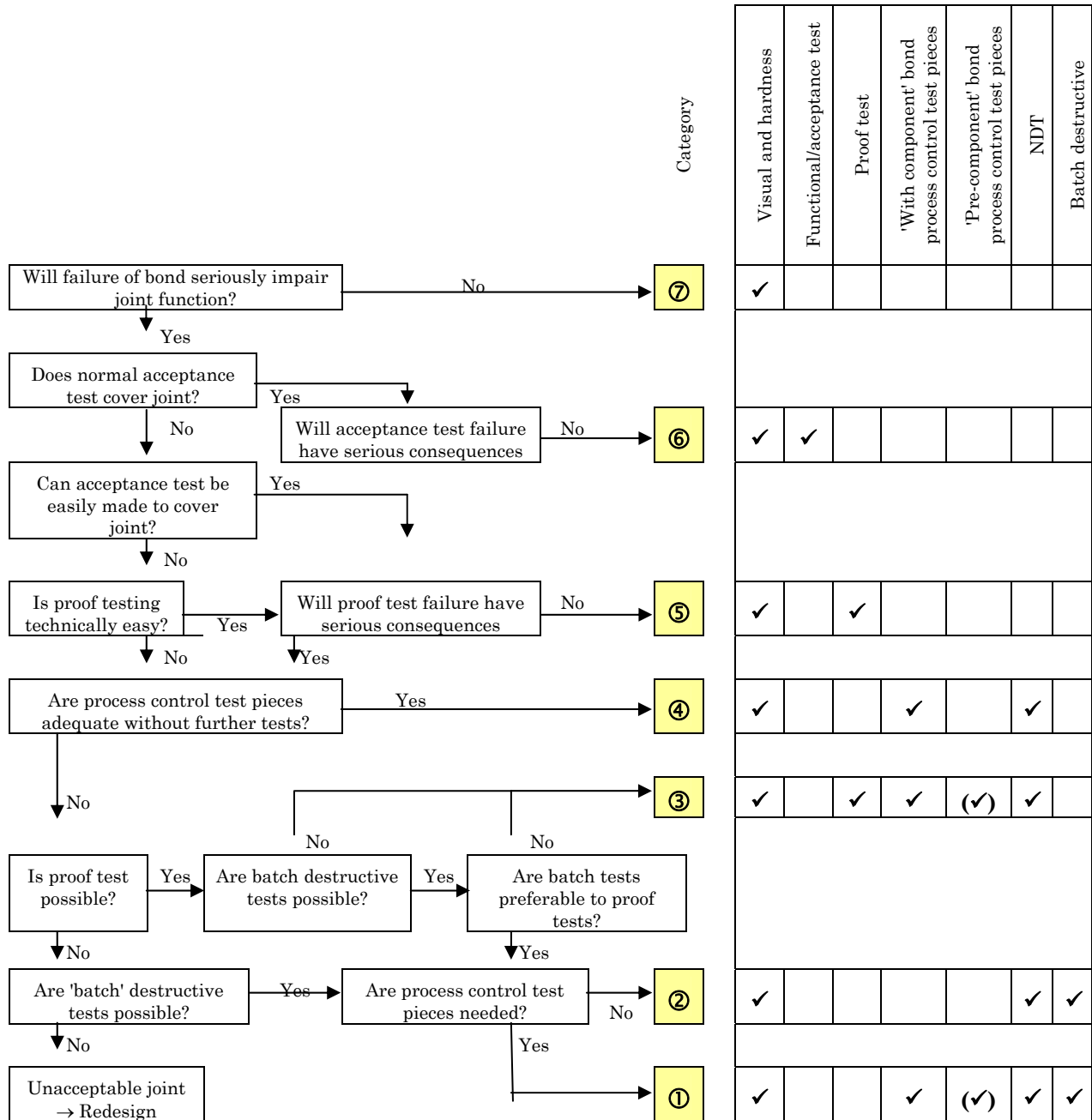

Figure 10.16-1 – Design chart: Aide memoire ‘factors to consider’



© Courtesy of Astrium Ltd, Stevenage, UK

- Key:
- (a) Pre-component bond test pieces are only necessary for surface preparations with a life greater than 7 days.
 - (b) Test needed

This chart has been adapted slightly from an original provided by Astrium UK which had a copyright statement. Its inclusion in the final version of the handbook remains the subject of the written approval of Astrium's legal department.

Figure 10.16-2 – Design chart: Example of joint category procedure

10.17 References

10.17.1 General

- [10-1] K. Stellbrink: DLR-Stuttgart, D
'Preliminary Design of Composite Joints'
DLR-Mitteilung 92-05, April 1992, ISSN 0939-298X
- [10-2] ECSS-E-HB-32-20: Structural materials handbook; previously ESA
PSS-03-203
- [10-3] L.J. Hart-Smith: McDonnell Douglas Aircraft Co, USA
'Design of Adhesively Bonded Joints'. In *Joining Fibre- Reinforced
Plastics*'. Edited by F.L. Matthews p271-311
Elsevier Applied Science. ISBN 1-85166-019-4, 1987
- [10-4] L.J. Hart-Smith: McDonnell Douglas Aircraft Co, USA
'Adhesive Bonded Joints for Composites-Phenomenological
Considerations'
Conference on Advanced Composites Technology arranged by
Technology Conference Associates. El Segundo 1978
- [10-5] R.D. Adams
'Theoretical Stress Analysis of Adhesively Bonded Joints
Joining Fibre-Reinforced Plastics'. Edited by F.L. Matthews
p185-226. Elsevier Applied Science. ISBN 1-85166-019-4, 1987
- [10-6] L.J. Hart-Smith: McDonnell Douglas Aerospace, USA
'The Bonded Lap Shear Test Coupon - Useful for Quality Assurance
but Dangerously Misleading for Design Data'
Proceedings of 38th International SAMPE Symposium, 10-13 May
1993, p239-246
- [10-7] ASTM STP 749
- [10-8] O. Volkersen
Luftfahrtforschung 15, 41; 1938
- [10-9] M. Goland & E. Reissner
J. Appl. Mech., Trans. ASME 66, A17; 1944
- [10-10] L.J. Hart Smith
'Design and Analysis of Adhesive Bonded Joints'
McDonnell Douglas Co. Report No. 6059A; 1972
- [10-11] ESDU 79016: Inelastic shear stresses and strains in the adhesives
bonding lap joint loaded in tension or shear, 1979
- [10-12] H. Hertel
'Leichtbau'
Springer Verlag, Berlin, 1960

- [10-13] F. Mortensen, O.T. Thomsen, M. Palantera: Aalborg University (DK) / Compoengineering Inc. (Finland)
'Facilities in ESAComp for analysis and design of adhesively bonded joints'
Proceedings of European Conference on Spacecraft Structures, Materials and Mechanical Testing, ESA/ESTEC Noordwijk (NL), 29th Nov. - 1st Dec. 2000. ESA-SP 486
- [10-14] A5-SG-1-10
- [10-15] ATV-AS-SSS-1100
- [10-16] P. Cawley
'NDT of adhesive bonds'
Chapter 13, Flight-Vehicle Materials, Structures, and Dynamics - Assessment and Future Directions
Vol. 4 Tribological Materials and NDE
ASME Publication, 1992, ISBN 0-7918-0662-6
- [10-17] N. Wood
'Large area composite inspection system (LACIS) - automation of traditional inspection techniques'
39th International SAMPE Symposium, April 11-14, 1994
p1375-1390
- [10-18] W.P. Winfree
'Thermal QNDE detection of airframe disbonds'
NASA-CP-3160, 1991, p249-260
- [10-19] D.R. Prabhu & W.P. Winfree
'Automation of disbond detection in aircraft fuselage through thermal image processing'
Review of Progress in Quantitative Non-destructive Evaluation
Volume 11B, 1992
Plenum Press, ISBN 0-306-44206-X, p1323-1330
- [10-20] D.W. Lowden
'Quantifying disbond area'
Proceedings of the International Symposium on Advanced Materials for Lightweight Structures, March 1992
ESA SP-336, p223-228
- [10-21] T. Pialucha & P. Cawley
'The detection of a weak adhesive/adherend interface in bonded joints by ultrasonic reflection measurements'
Review of Progress in Quantitative Non-destructive Evaluation
Volume 11B, 1992
Plenum Press, ISBN 0-306-44206-X, p1261-1266
- [10-22] P.N. Dewen & P. Cawley
'An ultrasonic scanning technique for the quantitative determination of the cohesive properties of adhesive joints'
Review of Progress in Quantitative Non-destructive Evaluation,
Volume 11B, 1992, Plenum Press, ISBN 0-306-44206-X, p1253-1260

10.17.2 ECSS documents

[See: [ECSS](#) website]

ECSS-E-ST-10	System engineering general requirements
ECSS-E-ST-10-02	Verification
ECSS-E-ST-10-03	Testing
ECSS-E-ST-32-01	Fracture Control
ECSS-E-ST-32	Structural general requirements
ECSS-E-HB-32-20	Structural materials handbook; previously ESA PSS-03-203
ECSS-E-HB-32-22	Insert design handbook; previously ESA PSS-03-1202
ECSS-E-HB-32-23	Threaded fasteners handbook; previously ESA PSS-03-208
ECSS-Q-ST-20	Quality assurance
ECSS-Q-ST-70	Materials, mechanical parts and processes
ECSS-Q-ST-70-01	Cleanliness and contamination control
ECSS-Q-ST-70-02	Thermal vacuum outgassing test for the screening of space materials
ECSS-Q-ST-70-04	Thermal testing for the evaluation of space materials, processes, mechanical parts and assemblies
ECSS-Q-ST-70-06	Particle and UV radiation testing of space materials
ECSS-Q-ST-70-21	Flammability testing for the screening of space materials
ECSS-Q-ST-70-22	Control of limited shelf-life materials
ECSS-Q-70-71	Data for the selection of space materials and processes

10.17.3 Other standards

NASA-STD-6001	Flammability, odor, offgassing and compatibility requirements and test procedures for materials in environments that support combustion; previously NASA NHB 8060.1 (parts A and B).
MIL-HDBK-17	Polymer Matrix Composites Vol. 3: Materials usage, design and analysis

11

Design allowables

11.1 Introduction

A series of design curves provide information on the shear stresses and joint strengths expected in bonded joints with different ratios of overlap length (L) and **adherend** thickness (t). Both static and dynamic loads are considered, as are the effects of temperature. The design curves are reproduced from Ref. [11-1].

Table 11.1-1 summarises the various bonded joint configurations, with links to the relevant figure.

Table 11.1-1 – Design curves: Summary of bonded joint configurations

Load	Adherends	Adhesive	Temperature (°C)	See: Figure
Single Lap Joint, [See: 11.2]				
Static	C/E→C/E	High Mod.	RT and 180	Figure 11.2-1
	C/E→St	High Mod.	RT and 180	Figure 11.2-2
	C/E→St	Med. Mod †	RT	Figure 11.2-3
	C/E→St or C/E	Metlbond 329-7	RT and 180	Figure 11.2-4
	C/E→C/E	Metlbond 329-7	RT, 120 and 180	Figure 11.2-5
	C/E→C/E sandwich skin	Metlbond 329-7	RT and 180	Figure 11.2-6
Dynamic	C/E→C/E ‡	Metlbond 329-7	RT	Figure 11.2-7
	C/E→C/E ‡	Metlbond 329-7	180	Figure 11.2-8
Double Lap Joint, [See: 11.3]				
Static	C/E→Ti	Med. Mod †	-	Figure 11.3-1
Symmetrical Scarf Joint, [See: 11.4]				
Static	C/E→Ti	Metlbond 329-7	RT and 180	Figure 11.4-1
	C/E→Ti	Metlbond 329-7	RT and 180	Figure 11.4-2
Dynamic	C/E ‡ → Ti	Metlbond 329-7	RT and 180	Figure 11.4-3
	C/E ‡ → Ti	Metlbond 329-7	RT and 180	Figure 11.4-4
	C/E ‡ → Ti	Metlbond 329-7	RT and 180	Figure 11.4-5
Key: C/E: Carbon/epoxy †: Shell 951 St: Steel ‡: Intermediate strength Ti: Titanium				

11.2 Single lap joint

11.2.1 Static loading

11.2.1.1 CFRP/epoxy adherends

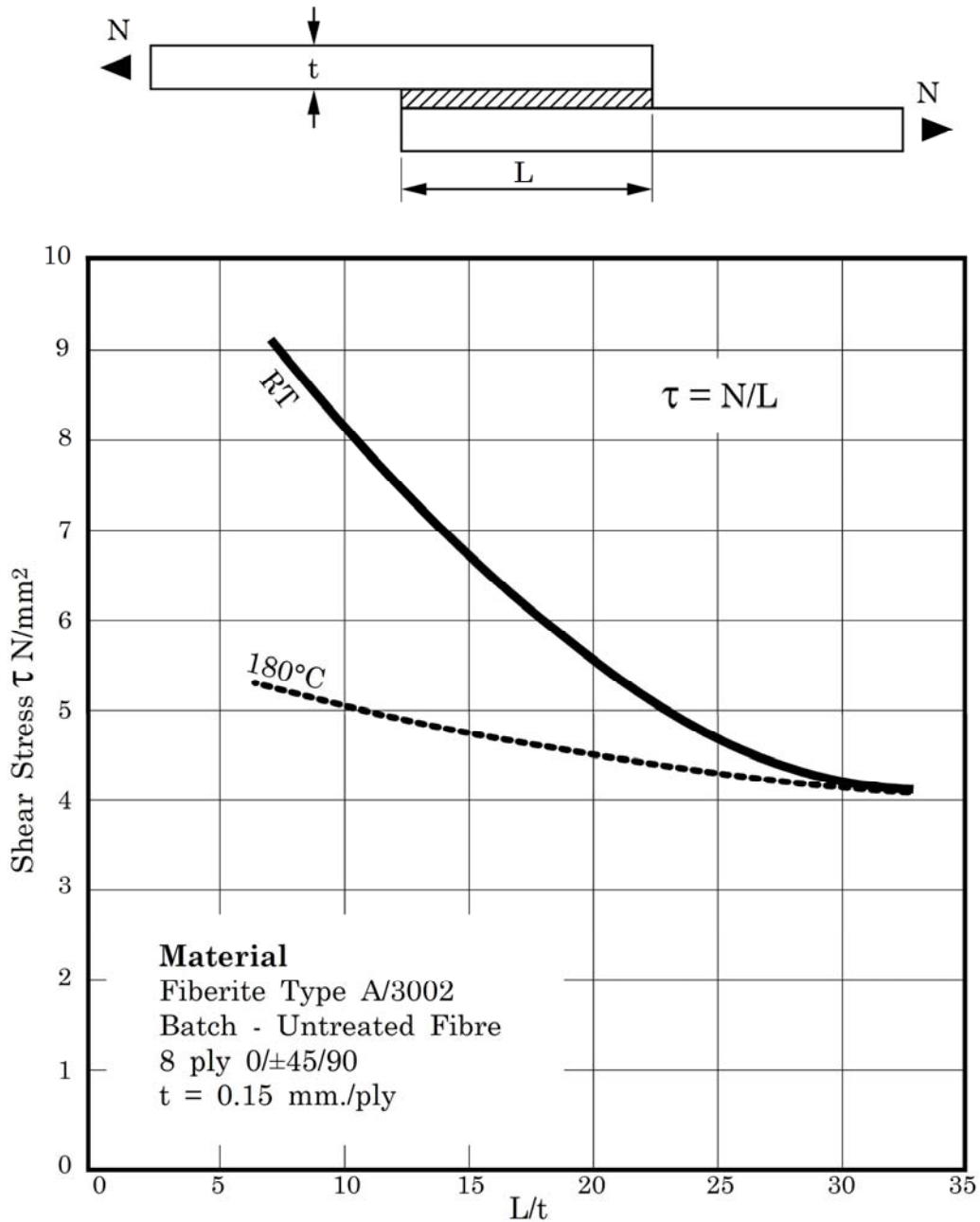

Adherends: CFRP/epoxy; high modulus adhesive; RT and 180 °C.

Figure 11.2-1 - Design curve: Static loaded single lap joint with CFRP/epoxy adherends

11.2.1.2 CFRP/epoxy and steel adherends

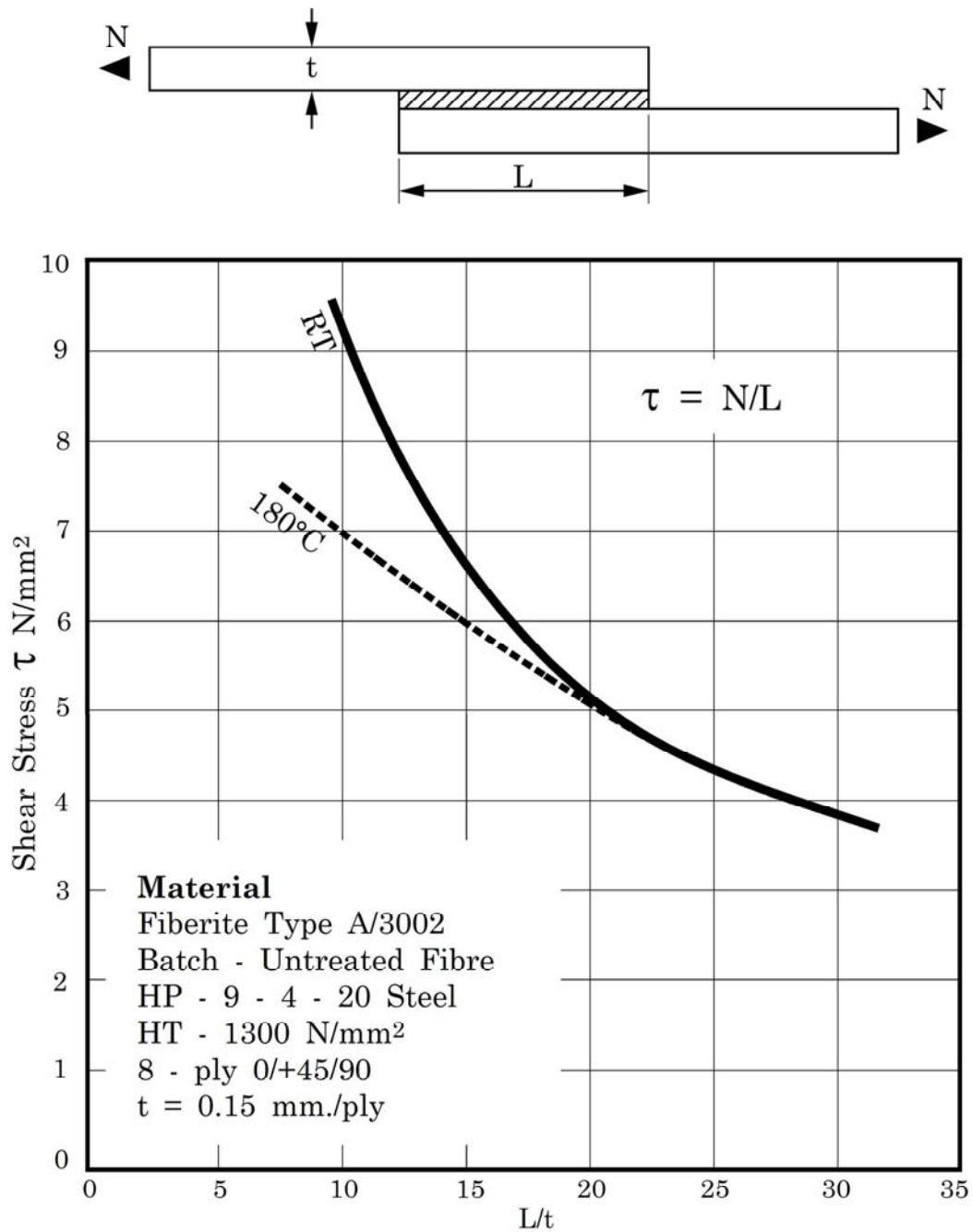

Adherends: CFRP/epoxy-to-steel; high modulus adhesive; RT and 180 °C.

Figure 11.2-2 - Design curve: Static loaded single lap joint with CFRP/epoxy-to-steel adherends

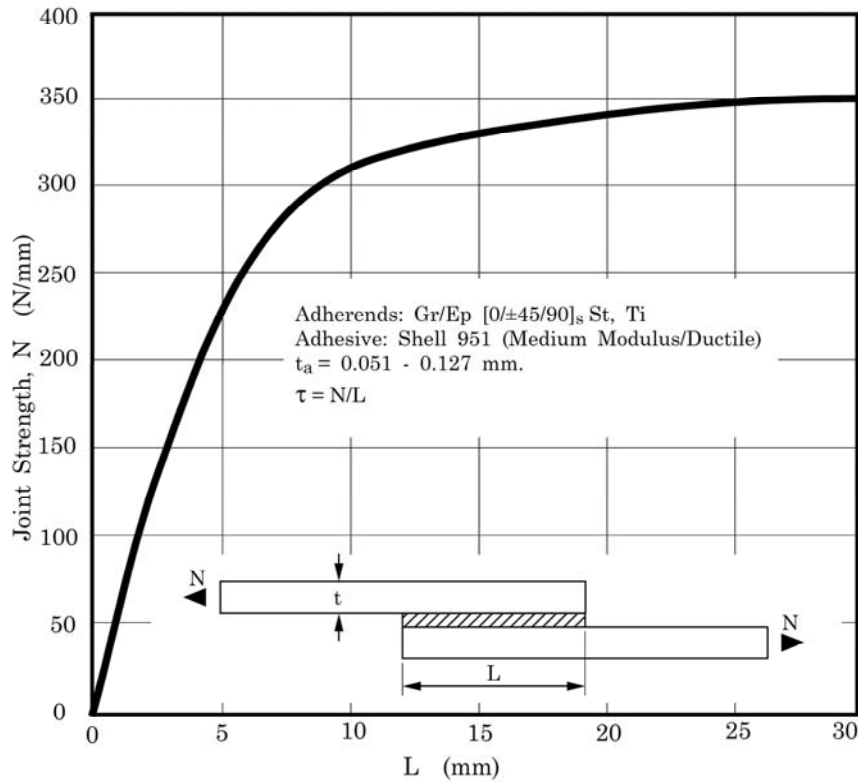

Adherends: CFRP/epoxy-to-steel; medium modulus adhesive; RT.

Figure 11.2-3 - Design curve: Static loaded single lap joint with CFRP/epoxy-to-steel adherends

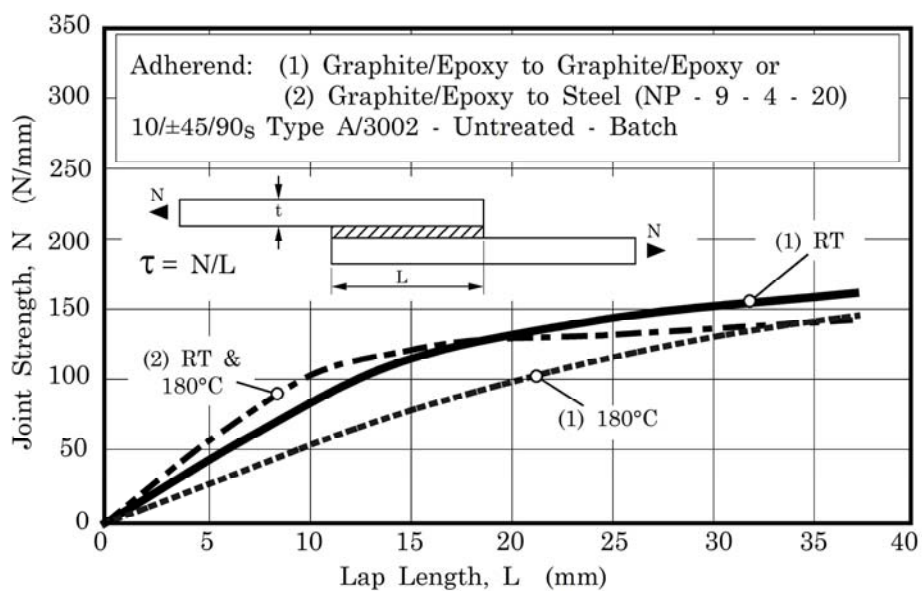

Adherends: CFRP/epoxy or CFRP/epoxy-to-steel; high modulus adhesive; RT and 180 °C.

Figure 11.2-4 - Design curve: Static loaded single lap joint - joint strength versus overlap length for CFRP/epoxy and CFRP/epoxy-to-steel adherends

11.2.1.3 Joint strength - CFRP/epoxy adherends

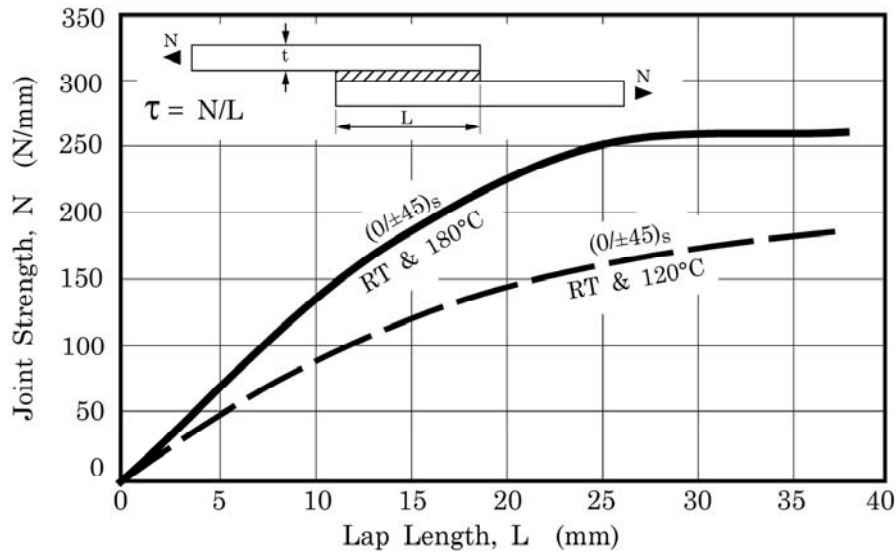

Adherends: CFRP/epoxy; high modulus adhesive; RT, 120 °C and 180 °C.

Figure 11.2-5 - Design curve: Static loaded single lap joint - joint strength versus overlap length for CFRP/epoxy adherends

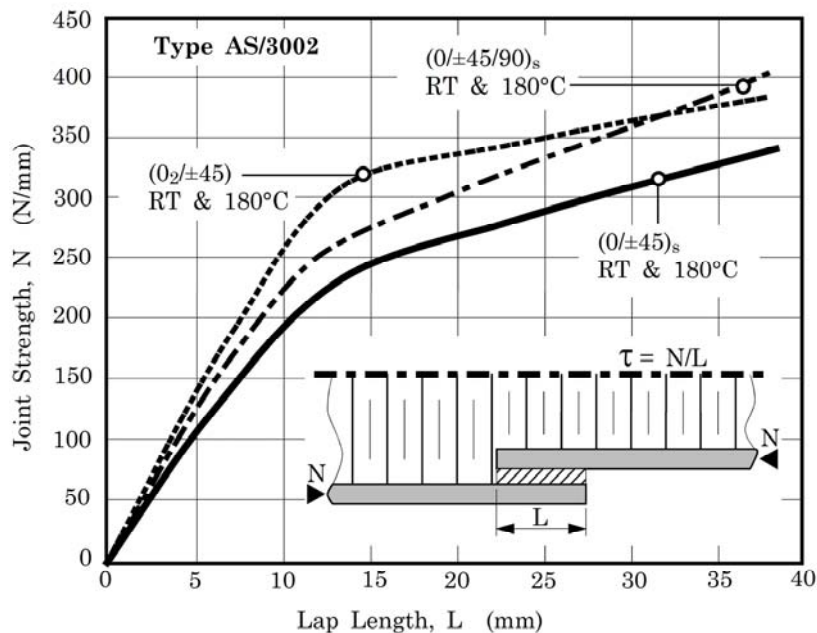

Adherends: CFRP/epoxy; high modulus adhesive; RT and 180 °C.

Figure 11.2-6 - Design curve: Static compression loaded single lap joint (stabilised sandwich, lower bond) - joint strength versus overlap length for CFRP/epoxy adherends

11.2.2 Dynamic loading

11.2.2.1 CFRP/epoxy adherends

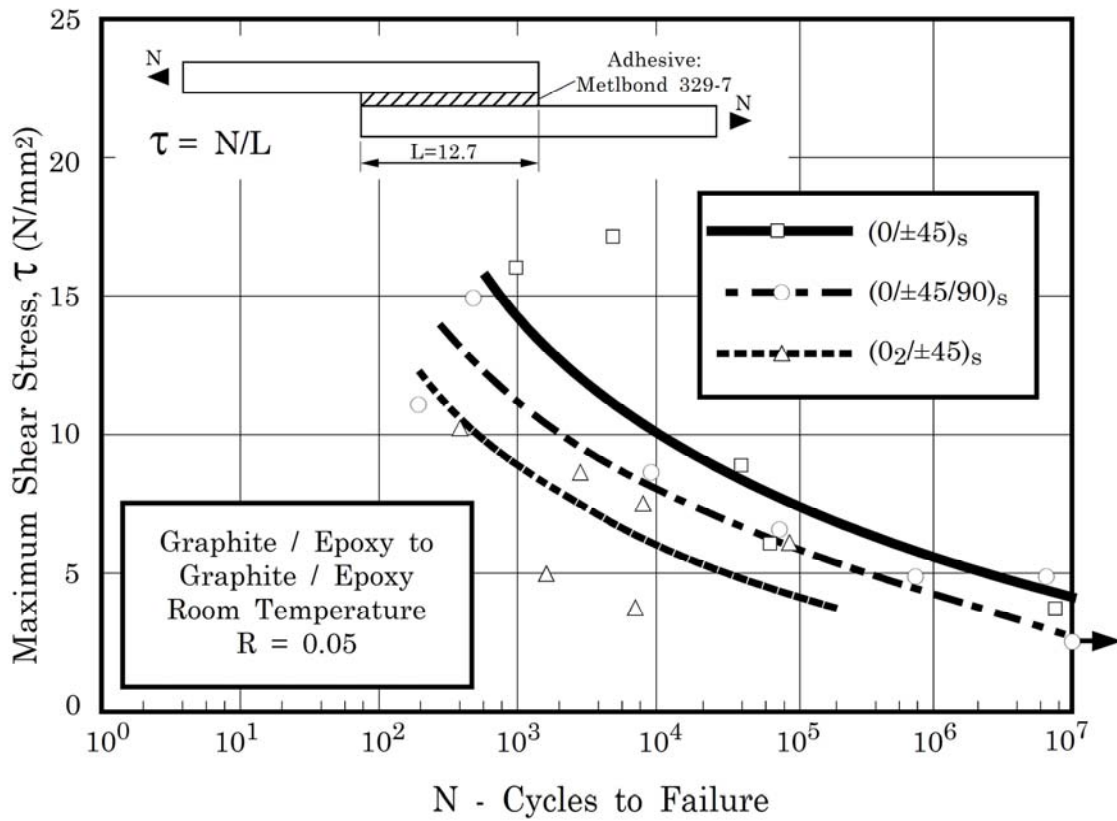

Adherends: Intermediate strength CFRP/epoxy; high modulus adhesive; RT.

Figure 11.2-7 - Design curve: Single lap joint - tension fatigue S-N curve at RT for CFRP/epoxy adherends

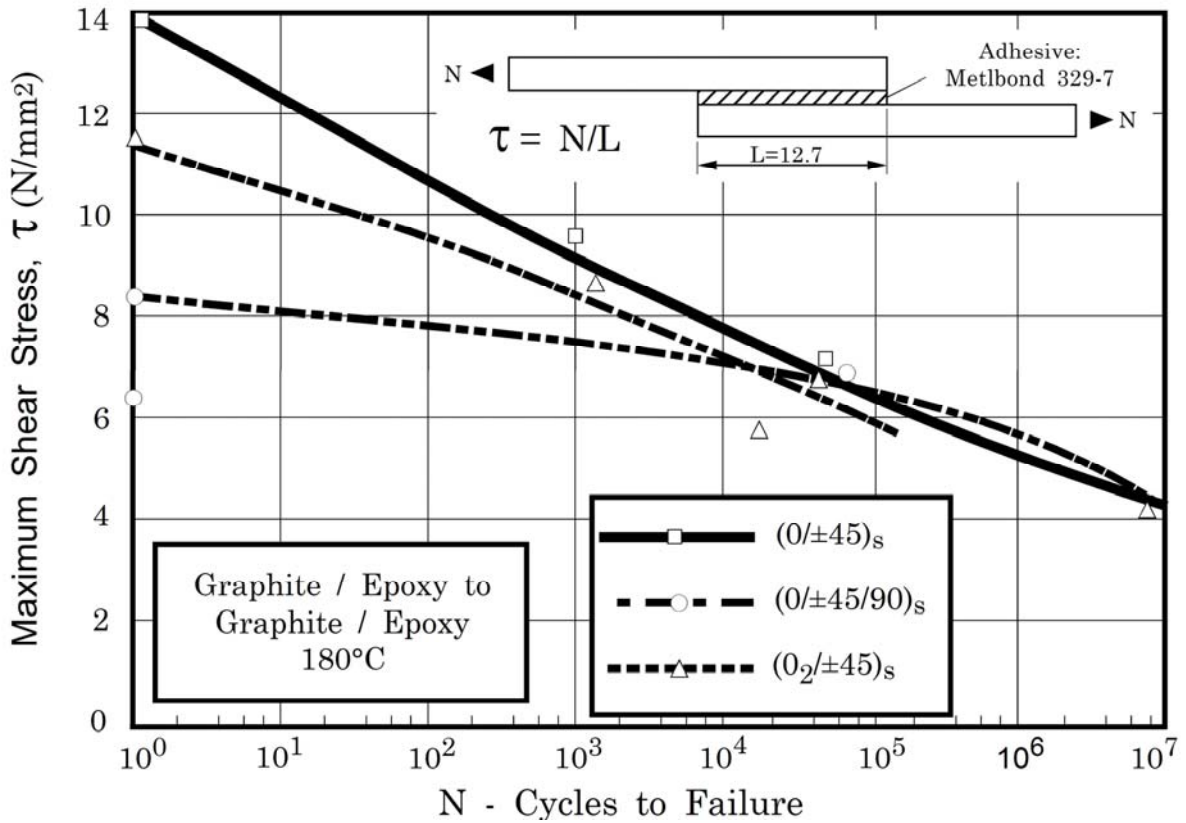

Adherends: Intermediate strength CFRP/epoxy; high modulus adhesive; 180 °C.

Figure 11.2-8 - Design curve: Single lap joint - tension fatigue S-N curve at 180 °C for CFRP/epoxy adherends

11.3 Double lap joint

11.3.1 Static loading

11.3.1.1 CFRP/epoxy to titanium

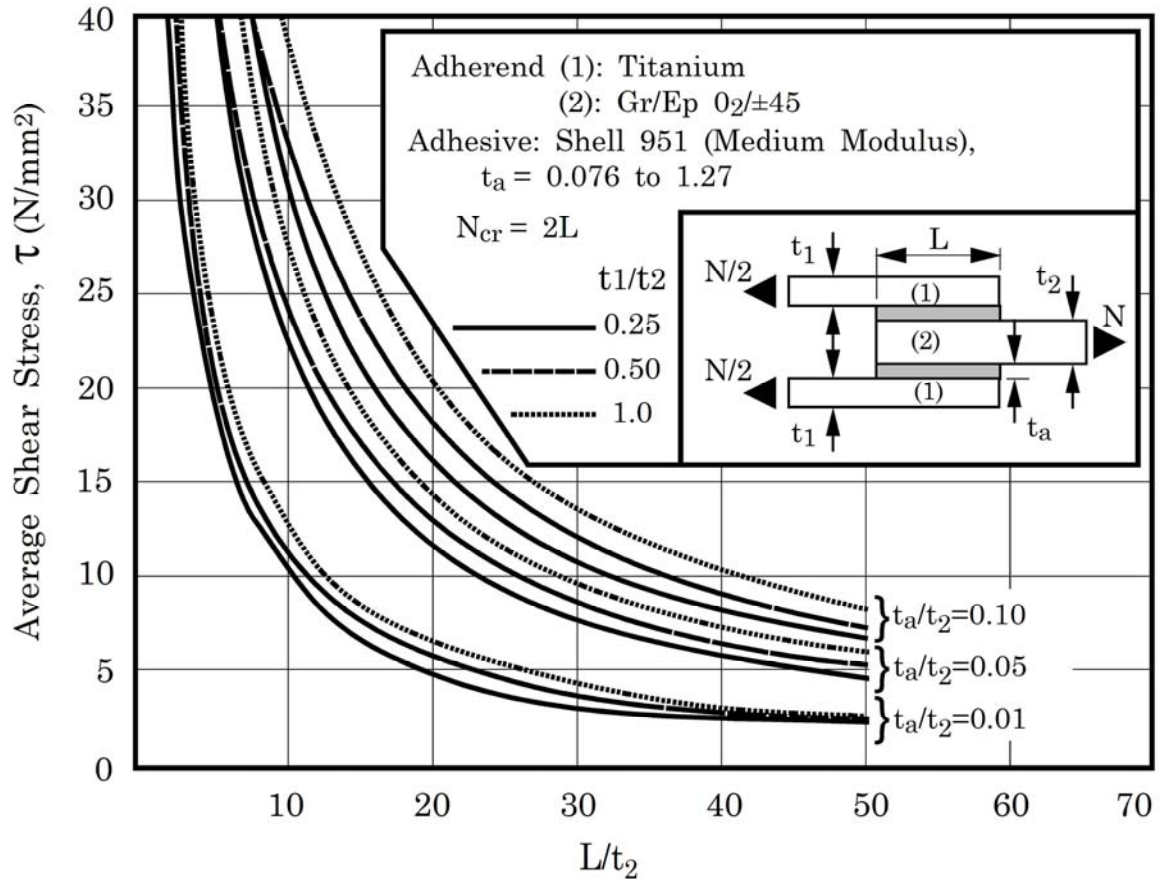

Adherends: CFRP/epoxy to titanium; medium modulus adhesive.

Figure 11.3-1 - Design curve: Static loaded double lap joint for CFRP/epoxy to titanium adherends

11.4 Symmetrical double scarf joint

11.4.1 Static loading

11.4.1.1 CFRP/epoxy to titanium

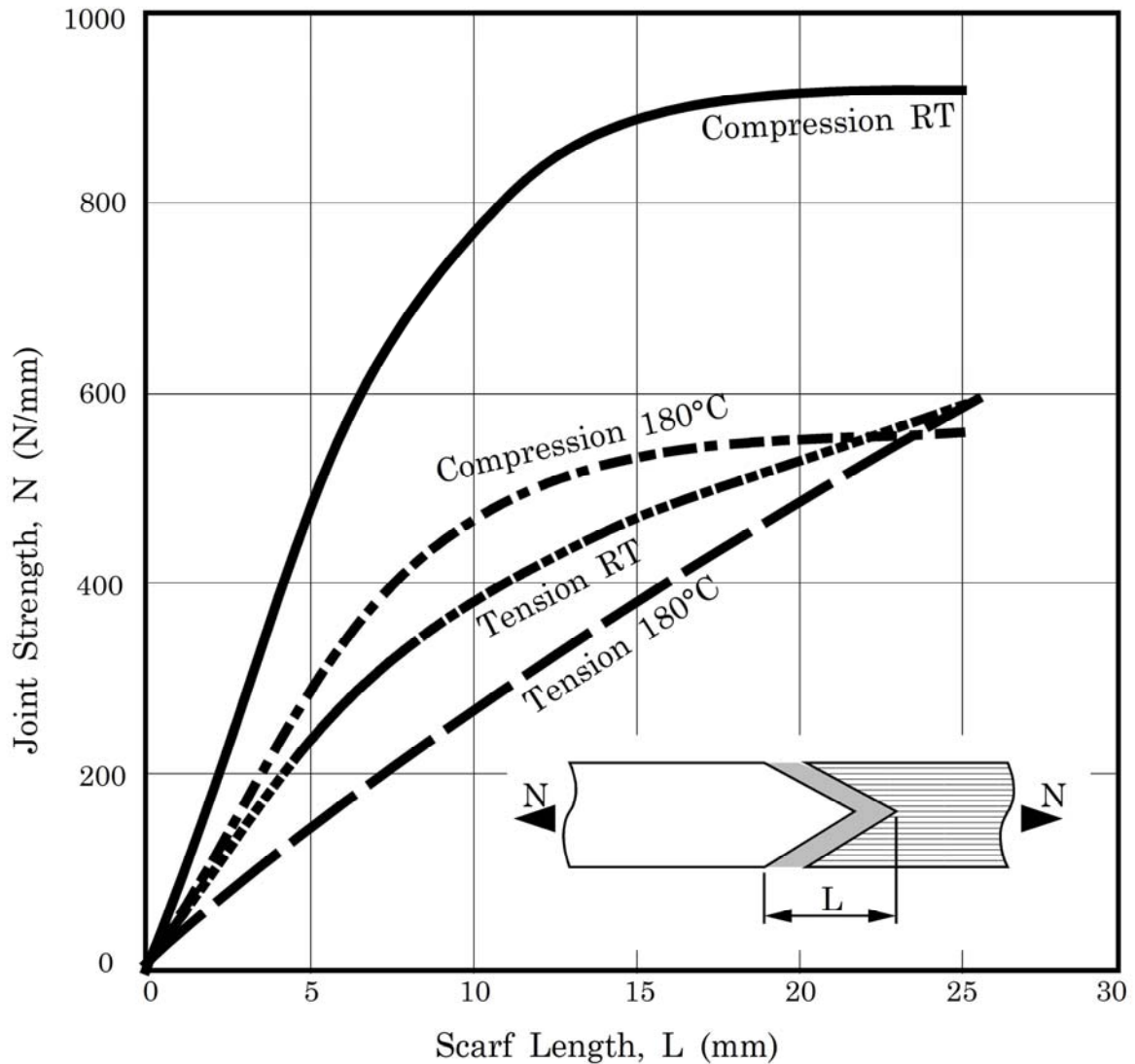

Adherends: CFRP/Epoxy [0/±45]_{2s} to titanium; high modulus adhesive; RT and 180 °C.

Figure 11.4-1 - Design curve: Static loaded double scarf joint for CFRP/epoxy to titanium adherends

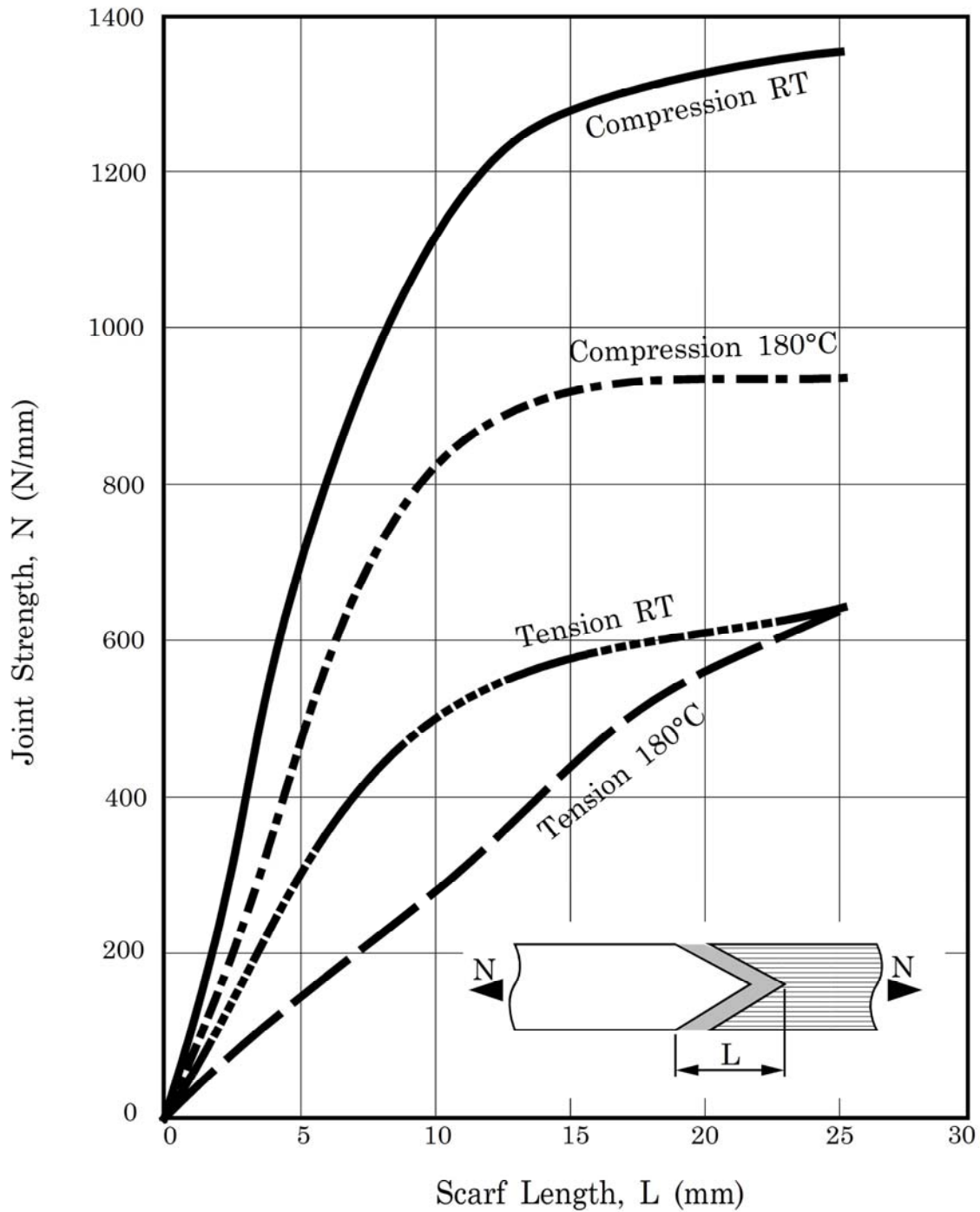

Adherends: CFRP/Epoxy [0/±45]_{2s} to titanium; high modulus adhesive; RT and 180 °C.

Figure 11.4-2 - Design curve: Static loaded double scarf joint for CFRP/epoxy to titanium adherends

11.4.2 Dynamic loading

11.4.2.1 CFRP/epoxy to titanium

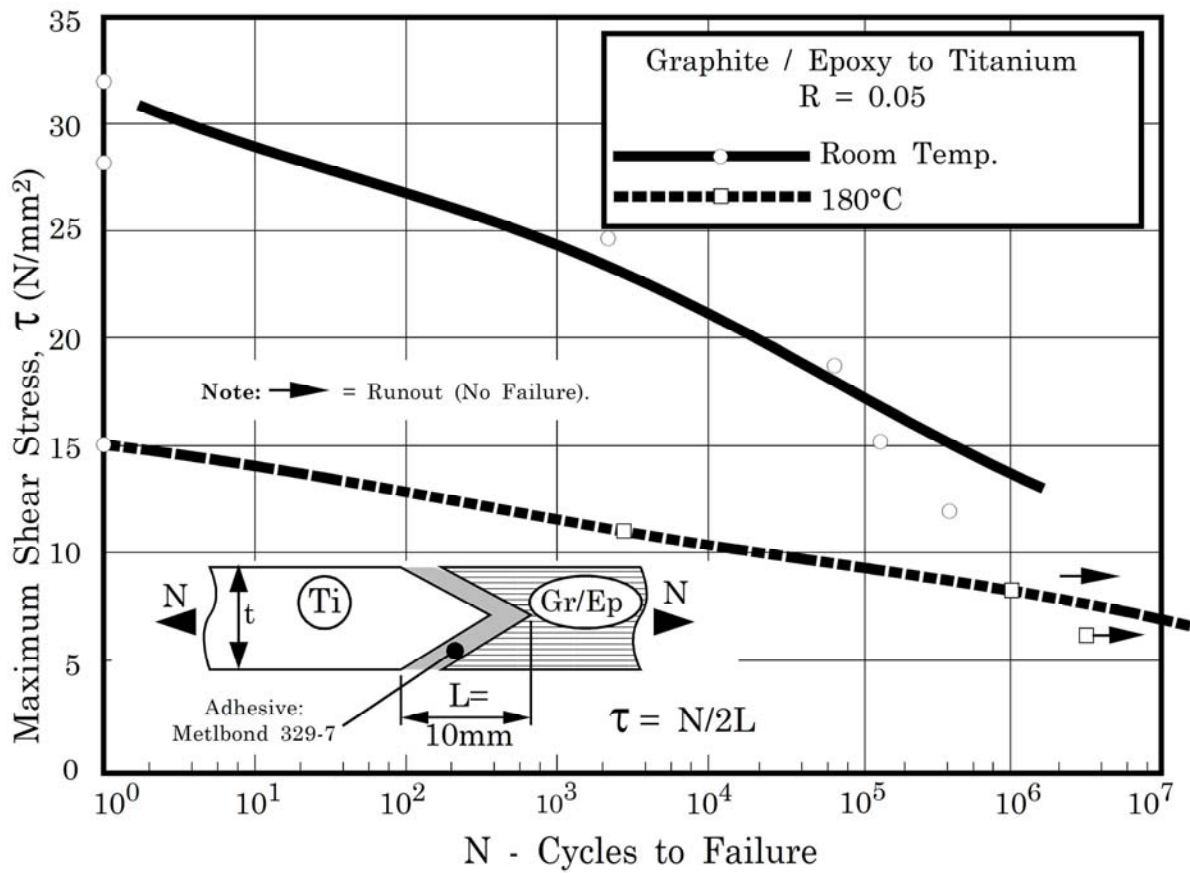

Adherends: Intermediate strength CFRP/Epoxy [0/±45/90]_{2s} to titanium; high modulus adhesive; RT and 180 °C.

Figure 11.4-3 - Design curve: Double scarf joint tension fatigue S-N curve for CFRP/epoxy to titanium adherends

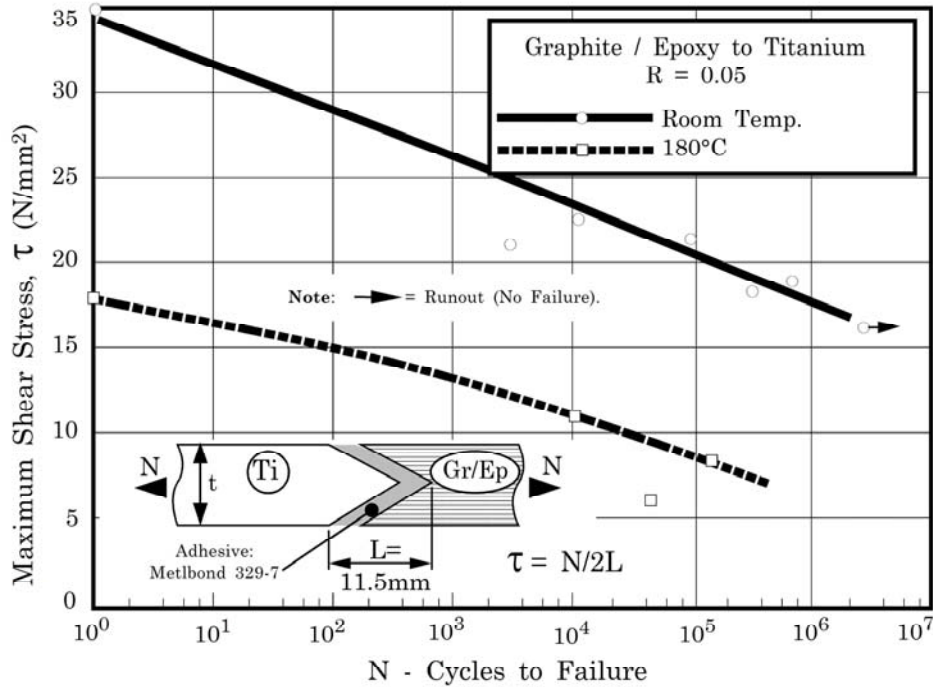

Adherends: CFRP/epoxy [0/±45]_{2s} to titanium; high modulus adhesive; RT and 180 °C.

Figure 11.4-4 - Design curve: Double scarf joint tension fatigue S-N curve for CFRP/epoxy to titanium adherends

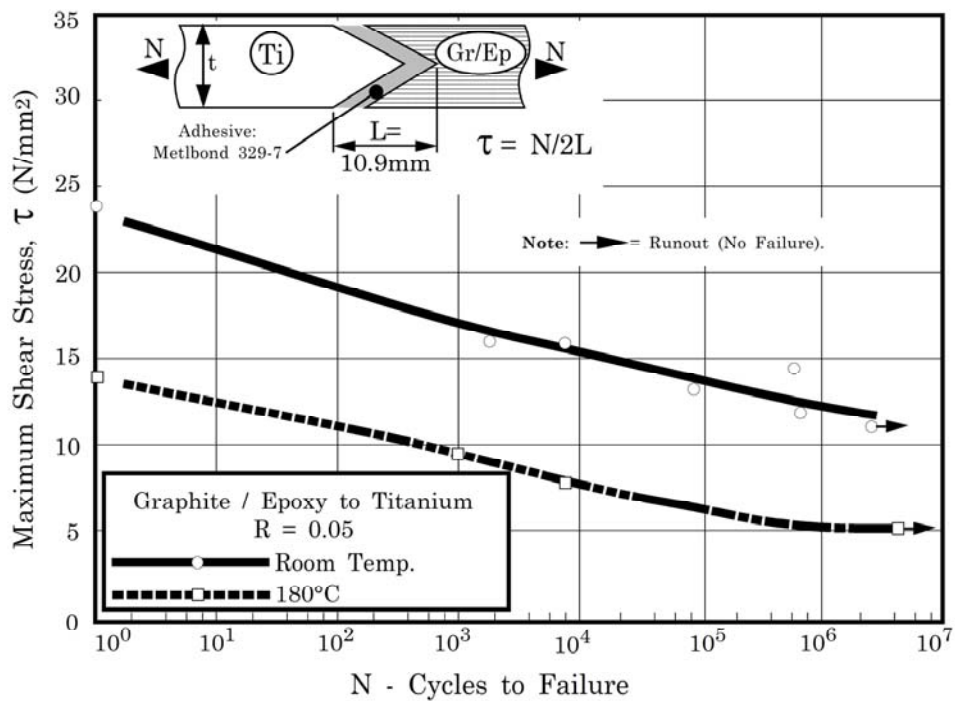

Adherends: CFRP/epoxy [0/±45]_{2s} to titanium; high modulus adhesive; RT and 180 °C.

Figure 11.4-5 - Design curve: Double scarf joint tension fatigue S-N curve for CFRP/epoxy to titanium adherends

11.5 References

11.5.1 General

- [11-1] ECSS-E-HB-32-20: Structural materials handbook; previously ESA PSS-03-203

11.5.2 ECSS documents

[See: [ECSS](#) website]

- ECSS-E-HB-32-20 Structural materials handbook; previously
ESA PSS-03-203

12

Surface preparation

12.1 Introduction

12.1.1 General

12.1.1.1 Objectives of surface preparation

All **adherends** need some form of preparation before bonding in order to obtain a good quality bond with optimum mechanical performance and **durability**. The objective of surface preparation is to:

- remove contaminants, and
- create a chemically compatible surface for the adhesive.

The success of surface preparation strongly affects the strength and durability of a structural adhesive bond. The extent of surface preparation necessary depends on many factors, including the:

- adhesive system's tolerance to contamination,
- type and extent of mechanical loading on the joint,
- type and extent of environmental loading on the joint,
- criticality of joint failure.

These factors are often dictated at the adhesive selection and joint design phases.

12.1.1.2 Methods

Some of the more widely known and accepted surface preparation methods used for the adhesive bonding of aerospace materials are discussed. The techniques are grouped according to the broad classes of adherend to which they are appropriate, i.e.:

- **thermosetting** matrix composites, [See: 12.2];
- **thermoplastic** matrix composites, [See: 12.3];
- aluminium alloys, [See: 12.4];
- titanium alloys, [See: 12.5].

The methods described, including some newer techniques, are used in the factory environment during either the manufacture or assembly of structures. Different methods are used for the preparation of existing structures for bonded repairs, [See: 19].

12.1.1.3 Composites

The basic process for composites involves creating a new, clean surface by cleaning and abrasion, or by peel-ply. Some chemical-based techniques have been tried for thermoplastic matrix composites:

- **thermosetting** matrix composites, [See: 12.2].
- **thermoplastic** matrix composites, [See: 12.3].

12.1.1.4 Metals

On exposure to the atmosphere, surface oxide films form on most metals used in aerospace structures, i.e.:

- aluminium alloys, [See: 12.4];
- titanium alloys, [See: 12.5].

The surface preparation techniques for these metals concentrate on modification or chemical conversion of oxide films to improve their:

- oxide cohesive strength,
- structure,
- stability,
- porosity,
- thickness,
- wettability.

12.1.2 Standard processes

Numerous surface preparation procedures have been developed. Some, with proven performance through accumulated experience, are standardised and accepted across the aerospace industry. The PAA phosphoric acid anodising technique for aluminium alloys has been in use for 20 years. The CAA Bengough process is the common European surface treatment. Other methods can be classed as 'in-house', and, although the same basic technique can be widely used, the precise details vary between different companies. This applies most commonly to composite materials. Efforts are being made to standardise the most common methods with proven performance; especially abrasion techniques.

[See also: [22-8] for a list of ASTM procedures]

12.1.3 Development processes

As new structural materials are considered for bonded structures, techniques for their surface preparation are under evaluation. Some of the established techniques can be appropriate directly or need modification to achieve acceptable bond performance.

12.1.4 Process steps

Surface preparation methods normally consist of a sequence of operations, each of which needs careful implementation and strict control. Some methods are very complicated, and involve the use of chemical baths containing aggressive, harmful reagents.

12.1.5 Legislation

Recent and growing concern over the ecological impact of industrial chemicals has led to increasing legislation restricting the use of certain substances. Some of the now restricted substances have traditionally been used for pre-bonding surface preparation, e.g. heavy or toxic metals and certain organic solvents. This has serious implications for some of the proven and established pre-bonding techniques. Consequently new methods, reducing or eliminating restricted chemicals, are under development. In particular, chemical baths eliminating chromium ions and **primers** containing no organic solvents (or with much reduced levels). Many of these recent methods and substances are undergoing evaluation to determine their effect on bond strength and **durability**, Ref [12-16].

[See also: 12.4]

12.2 Composites: Thermosetting matrix

12.2.1 General

The surface preparation methods described here were developed principally for **epoxy**-based fibre-reinforced composites, but are also considered for other thermoset matrix composites, e.g. **bismaleimide**, **polyimide**.

During the composite manufacturing process, contamination of the surfaces to be bonded can occur as a result of:

- handling and machining (grease and dust);
- transfer of release agents used in moulding operations.

Extensive surface analysis of composites identified the particular need for preventing contamination by silicon and fluorine, Ref. [[12-1], [12-2], [12-3]]. Such substances are used in a wide range of mould release agents.

In addition to contamination, the as-moulded composite surface can be unsuitable for bonding, e.g.:

- too smooth a surface gives poor mechanical keying for adhesives,
- a resin rich surface is structurally weak, Ref. [12-4].

12.2.2 Techniques

Mechanical surface preparation methods applicable to **thermoset** resin composites can be grouped as either:

- abrasion, or
- creation, or exposure, of a new surface, e.g. using a **peel ply**.

Within each group, a variety of different procedures have been developed by both adhesive manufacturers and end users. Adhesives suppliers also provide advice on surface preparation.

12.2.3 Abrasion

Abrasion of the surfaces to be bonded is usually undertaken after a degreasing and cleaning operation. Cleaning can use either a solvent or detergent, depending on the sensitivity of the resin matrix or adhesive to solvents.

After abrasion, the surfaces are cleaned again and a **primer** (compatible with the adhesive and the resin matrix) can be applied.

The effect of mechanical abrasion is to:

- reduce the thickness of the external resin-rich composite layer,
- roughen the surface to create a 'mechanical key' and increase the effective area of bonding,
- increase the surface energy of the composite to be bonded (faying surface).

Fibres close to the composite surface cannot be damaged when using abrasion techniques.

Figure 12.2-1 shows an example of the abrasion method for advanced composites; as used in the USA, Ref. [12-5].

Figure 12.2-2 shows a simpler method applied in the USA and Europe. This method is also advised by some adhesive manufacturers for bonding composites with **epoxy**, **phenolic** or **-imide** type resin matrices, Ref. [12-6].

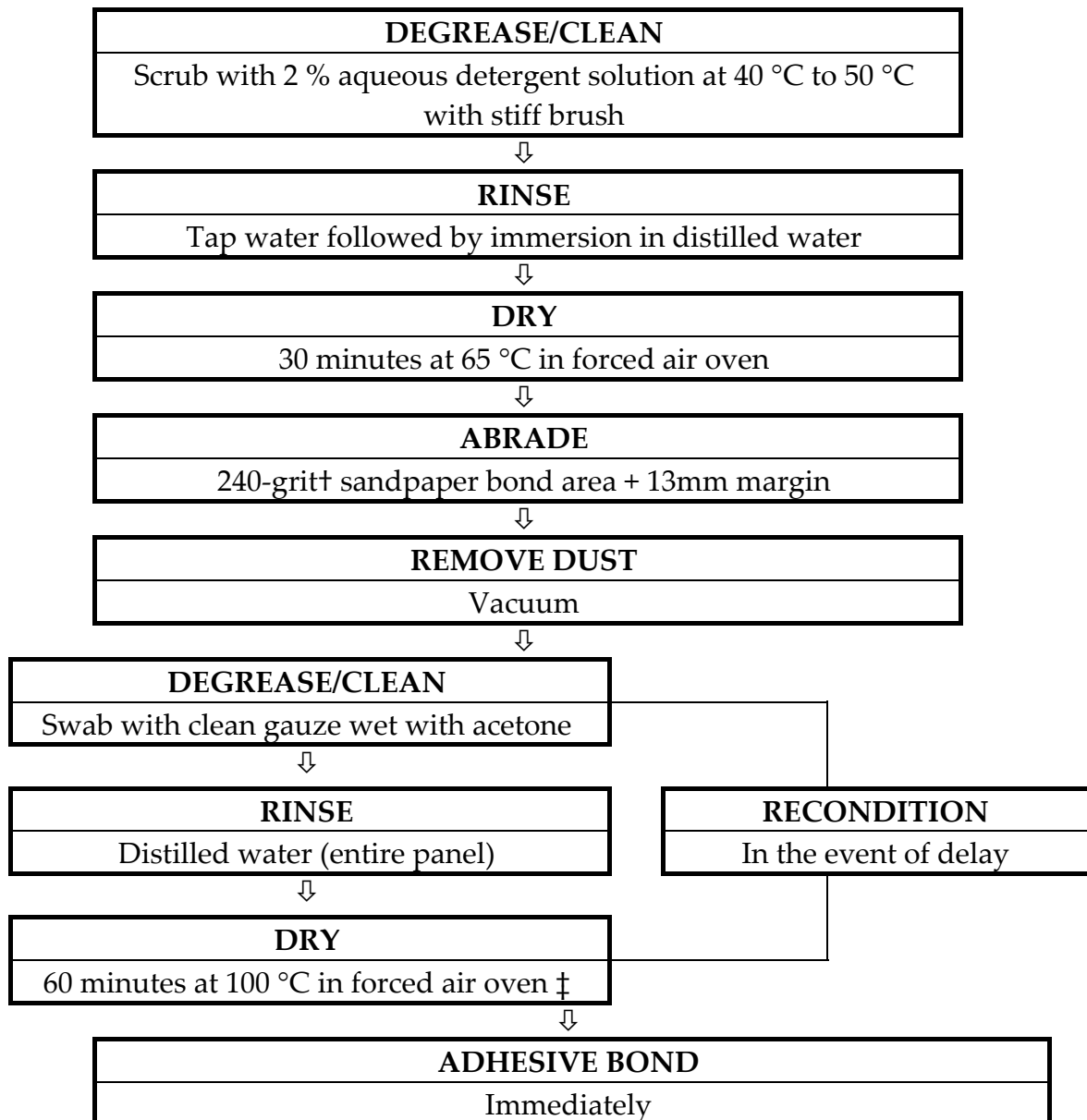

† : 120-grit sandpaper used in some processes.

‡ : Some processes stipulate longer times.

Figure 12.2-1 - Thermosetting matrix composites: An abrasion surface preparation method

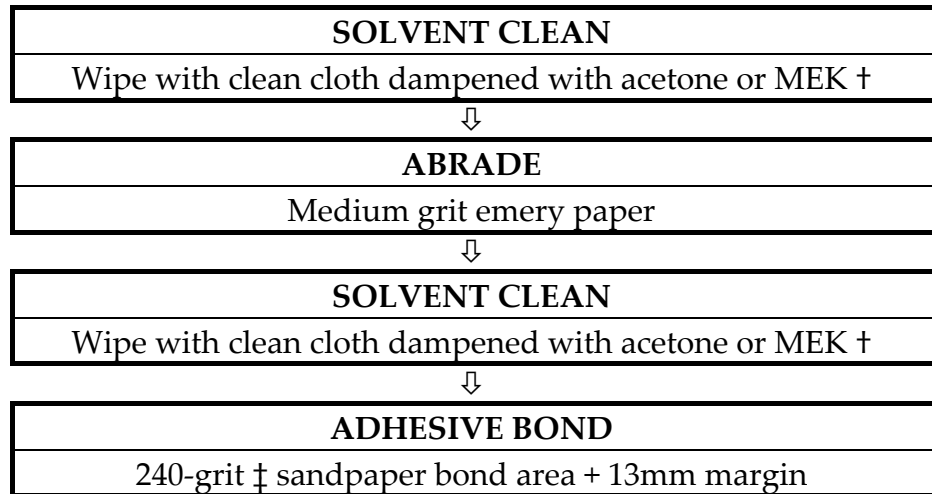

†: MEK - methyl ethyl ketone, specific gravity @ 20 °C : 0.82

‡: 120-grit sandpaper used in some processes.

Some resins are sensitive to MEK, e.g. Ciba Geigy 914.
 Chloroethene is sometimes substituted for MEK, but is less effective.
 Strict health and safety regulations apply to the use of MEK.

Figure 12.2-2 - Thermosetting matrix composites: A simple abrasion surface preparation method

12.2.4 Peel ply

12.2.4.1 General

The creation of a new surface by the complete removal of the outermost layer of a composite prior to bonding minimises contamination by grease, dirt and mould release agents.

To remove the as-moulded surface, a sacrificial external ply is incorporated into the composite lay-up prior to curing. In some cases, the **peel ply** is placed beneath the outermost composite ply, Ref. [12-7].

To expose the clean surface for bonding, the sacrificial plies are peeled from the composite, hence their name peel plies. The new surface is rough, since the matrix resin conforms to the **peel ply** weave during cure. Often no subsequent abrasion or cleaning operations are needed, which can reduce the bonding process time.

12.2.4.2 Selection

Peel plies are usually scoured fabrics of nylon, glass or polyester. Teflon-coated peel plies cannot be used on areas to be adhesively bonded. The choice of peel-ply weave can dictate the final surface roughness of the composite bonding surface.

Some of the factors to consider in the selection of a peel-ply include:

- is the peel ply chemically clean and treated to avoid contamination?

- is the weave style suitable? Some fabrics are less effective barriers to mould release agents than others.
- does the fabric create a very rough surface? Extremely rough surfaces can inhibit bonding because the asperities do not always fill with adhesive.
- peel plies are usually approved for particular uses, e.g. each combination of adhesive and adherend.

Variability in **peel plies**, resulting from minor changes in suppliers' products, is known to affect the performance of adhesive bonds. Consequently, quality control procedures are now applied to peel-plies, and other consumables used in adhesive bonding, in order to limit variations.

Along with stipulating fibre and weave-style, additional QA measures for peel plies are usually related to cleanliness, storage and handling.

12.3 Composites: Thermoplastic matrix

12.3.1 General

As **thermoplastic** matrix composites become of interest for certain aerospace applications, the joining methods considered include:

- adhesive bonding, with **thermosetting** adhesives;
- thermal bonding, often described as fusion or welding, which create a bond by either, [See also: 13.7]:
 - remelting the composite matrix phase;
 - melting an intermediate **thermoplastic** layer placed in the **bondline**.

12.3.2 Proposed methods

A summary of surface preparation techniques investigated for joining thermoplastic composite materials is given in Table 12.3-1, Ref. [12-4], [12-6], [12-8]. Some methods rely on mechanical abrasion of the surfaces, and others on immersion in chemical baths after solvent degreasing.

The methods proposed are compiled from experimental studies. As yet there are no widely accepted standard procedures.

Table 12.3-1 - Surface Preparation: Proposed methods for thermoplastic composites

Technique	Process	Use	Comments
Peel ply	As for CFRP/ epoxy	Inappropriate owing to process temperature and inherent toughness of matrix	
Abrasion	Fine-to-medium grit emery paper	PEEK, PS, PPS	Does not always produce high bond strengths
Grit blast	Alumina grit	APC-2, PS, PPS	Good bond strength
Chromic acid etch	Immerse in bath, rinse and dry	PEEK	Good bond strength
Sodium dichromate/ sulphuric acid	Immerse in bath, rinse and dry	Udel [®] , Astrel [®]	-
Sodium hydroxide	Immerse, rinse and dry	PI	-
Corona discharge		APC2, PPS, PS	Possible use
Gas plasma	Ammonia Argon Oxygen	APC2, PS, PPS Noryl [®] , Vectra [®] Torlon [®] , Ryton [®]	Gas selection optimised for highest bond strengths
Flame treatment		PPS	
Bond promoters and primers	Organo-silane and proprietary primers		Possible use
Key: PPS Polyphenylene sulphide PEEK Polyetheretherketone PS Polysulphone PI Thermoplastic polyimide			

12.4 Aluminium alloys

12.4.1 Aerospace aluminium alloys

12.4.1.1 Pre-bonding surface preparation

The pre-bonding surface preparation of aluminium alloys has been studied extensively by the aerospace industry for many years. A large number of process methods have been proposed, but relatively few have resulted in consistent, environmentally-resistant, adhesive bonds. Those with proven performance are standardised and widely accepted within the industry and include:

- CSA - potassium dichromate/sulphuric acid, e.g. DTD 915b(ii) (1956);

- Forest Products Laboratory, Optimised Forest Products Laboratory (FPL) etch,
- Chromic acid anodising (CAA) of Al and Al-alloys, e.g. CAA: MOD Def. Stan 03-24/1 (1984),
- Phosphoric acid anodising (PAA) of aluminium structural bonding, e.g. Boeing BAC 5555 (1974).

Chemical treatments modify or convert the naturally-occurring aluminium oxide film to a form more suitable for bonding. These are known as chemical conversion coatings, [See also: ECSS documents: ECSS-Q-70-71].

A variety of surface preparation methods exist, differing only in minor chemical composition changes in the baths and variations in processing temperatures and times.

Chemical treatments are applicable to sheet materials, but can be too aggressive for very thin materials, e.g. foils in aluminium honeycomb cores, [See: Solvent vapour cleaning].

Many of the chemicals used in the preparation of metals are toxic or strongly oxidising. Stringent health and safety procedures apply to their handling and storage.

12.4.1.2 Post-surface preparation

To prevent contamination after surface preparation, the surfaces to be bonded cannot be exposed to physical handling or atmospheric environments. A corrosion-inhibiting primer is often used to protect the surface between preparation and bonding.

Adhesive manufacturers usually stipulate the **primer** to be used for a particular adhesive. Such primers need not be mandatory, and joints prepared without them can give better results.

Prepared surfaces can degrade with time, so bonding is carried out within a period stipulated by quality assurance procedures.

12.4.2 MMC and Al-Lithium alloys

Initial studies on the surface preparation of metal matrix composites and aluminium-lithium alloys considered the suitability of some standard surface treatments. The usual preparation methods for aluminium alloys were tested on SiCp silicon-carbide particle reinforced **MMC** and Al-Li alloys.

Table 12.4-1 summarises the surface treatments used for some particular materials in bonding tests, Ref. [12-9], [12-10]. The pre-bonding treatments produced acceptable bond strengths, although their long-term **durability** needed further investigation.

Table 12.4-1 - Al-Li alloys and SiC particle MMC: Evaluation of surface preparation methods

Adherend	Adhesive	Surface Treatment
8009	XEA9674 BMI + X268-9 primer FM680 PI + BR680 primer X2550 BMI + X268-9 primer	BAC5555
SiCp/8009	XEA9674 BMI + X268-9 primer FM680 P I+ BR680 primer X2550 BMI + X268-9 primer	BAC5555
Weldalite® RX818-T8	AF191 epoxy, 177 °C	BAC5555
SiCp/8090	AF191 epoxy, 177 °C	BAC5555
T3 BA 8090C	Toughened epoxy, 120 °C cure	CSA etch
		CSA + CAA [Def. Stan 03-24/1]
		CSA + PAA [BAC5555]
Key: BMI - bismaleimide PI - polyimide CSA - potassium dichromate/sulphuric acid pickle CAA - chromic acid anodise PAA - phosphoric acid anodise SiCp – silicon carbide particle reinforced		

12.4.3 Optimised Forest Products Laboratory (FPL) etch

12.4.3.1 Process steps

Figure 12.4-1 shows the FPL procedure and indicates those steps which need stringent control in order to maintain a satisfactory pre-bonding treatment.

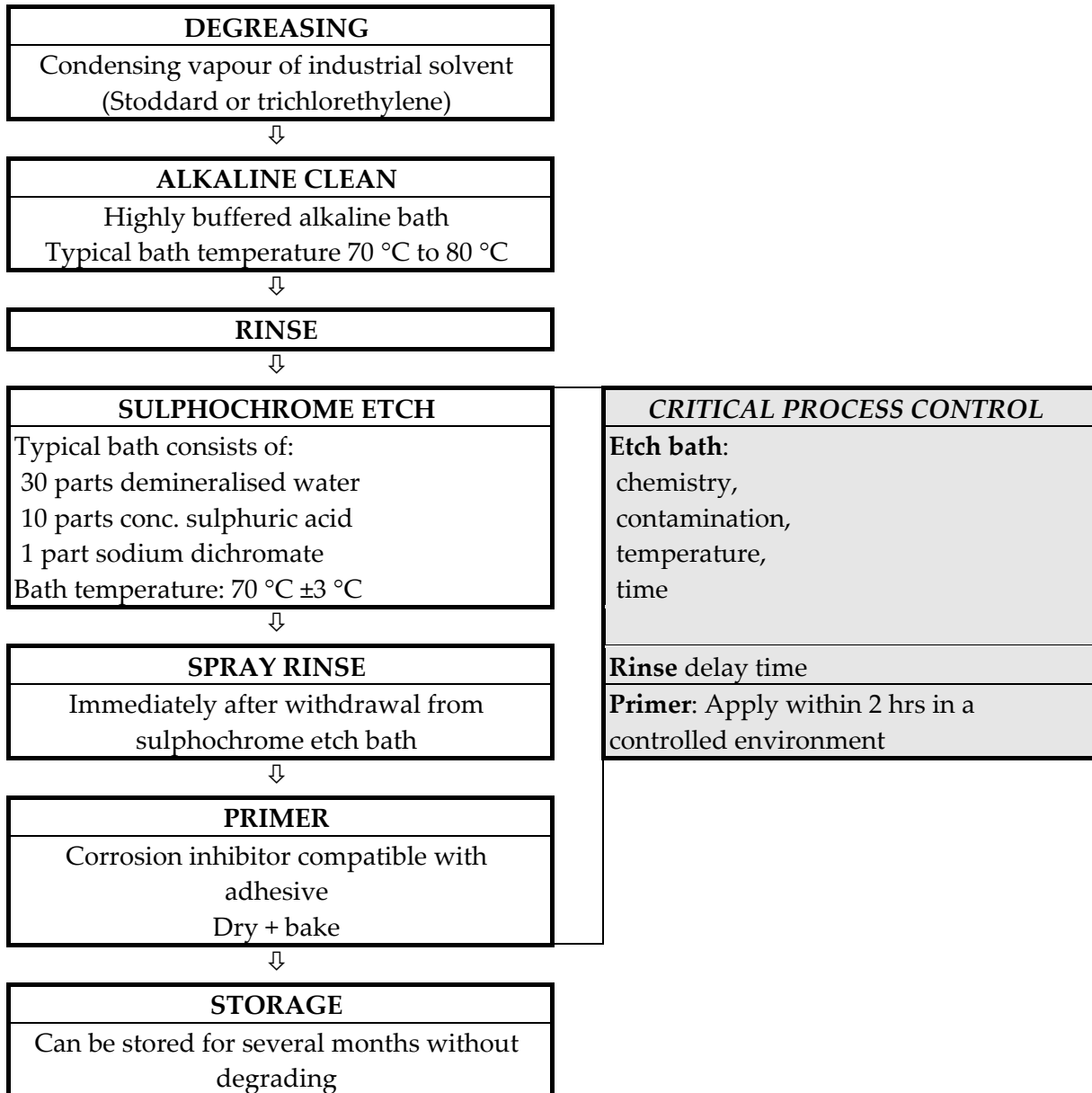

Figure 12.4-1 - Aluminium alloy surface preparation: FPL etch process

12.4.3.2 Adhesive compatibility

The FPL process is most compatible with 175 °C epoxy curing adhesives using primers. Its success with 120 °C curing adhesives is less controllable and resultant bond strengths have proved highly variable. Fluorine-containing contaminants can have a very detrimental effect on bond durability.

12.4.4 Phosphoric acid anodising (PAA)

12.4.4.1 General

Also known as ‘phos-anodising’, it was introduced in 1974 by The Boeing Airplane Company. An exhaustive test programme, combined with years of experience, has shown it to be the most durable pre-bonding surface treatment for aluminium alloys. Variations on this technique are also used for in-service bonded repairs, [See also: 19.2].

The process steps are shown in Figure 12.4-2, which also indicates those procedures needing strict control in order to achieve a satisfactory prebond treatment.

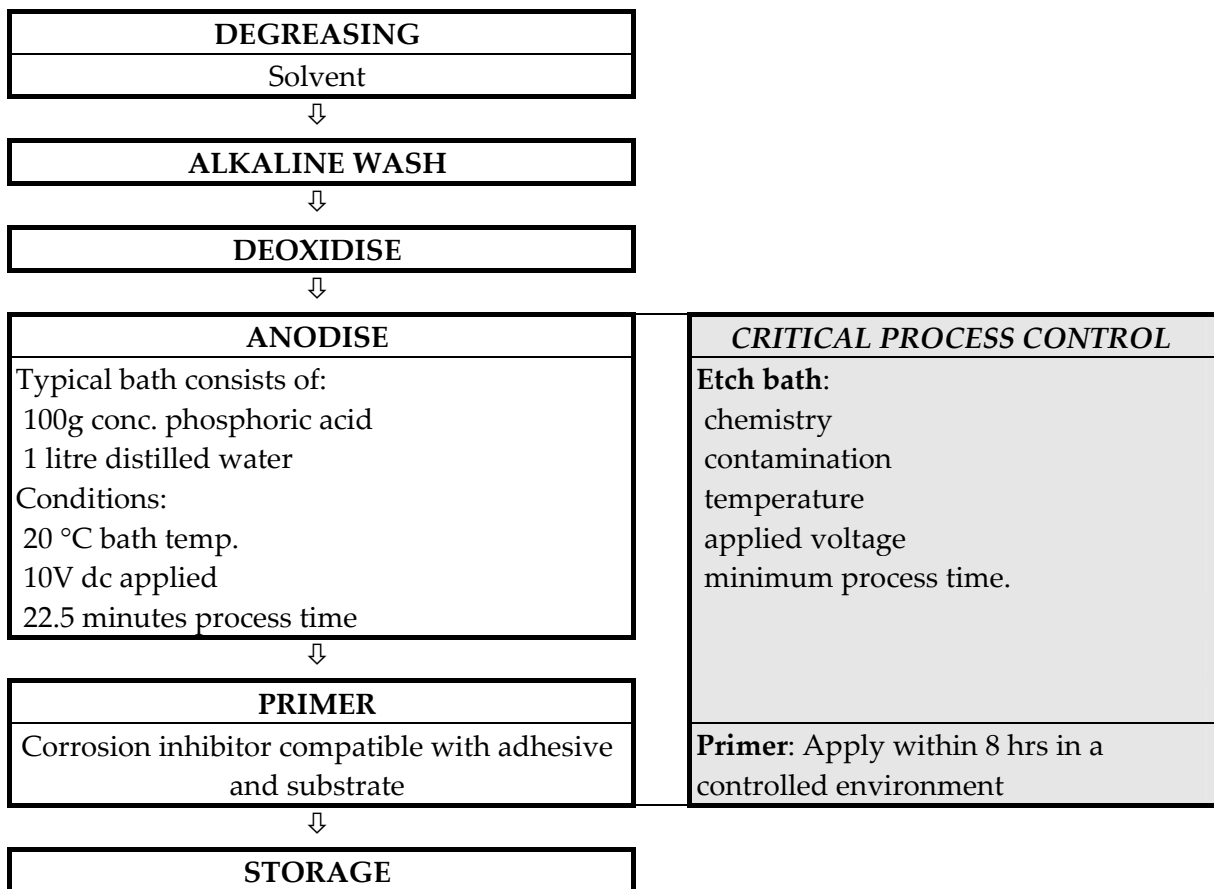

Figure 12.4-2 - Aluminium alloy surface preparation: Phosphoric acid anodise (PAA) process

12.4.4.2 Adhesive compatibility

The treatment is compatible with most commercially available **primers** and adhesives.

12.4.5 Chromic acid anodising (CAA)

Studied as part of the PABST programme, it was concluded that very careful monitoring of the treatment was necessary to achieve both consistent and reliable bonds. Despite this, chromic acid anodising has demonstrated its success in the aerospace industry for many years.

The process steps are shown in Figure 12.4-3, which also indicates the critical control needed.

Some CAA processes include a chemical bath 'sealing' operation. This is detrimental to adhesive bonding, but is sometimes used prior to painting.

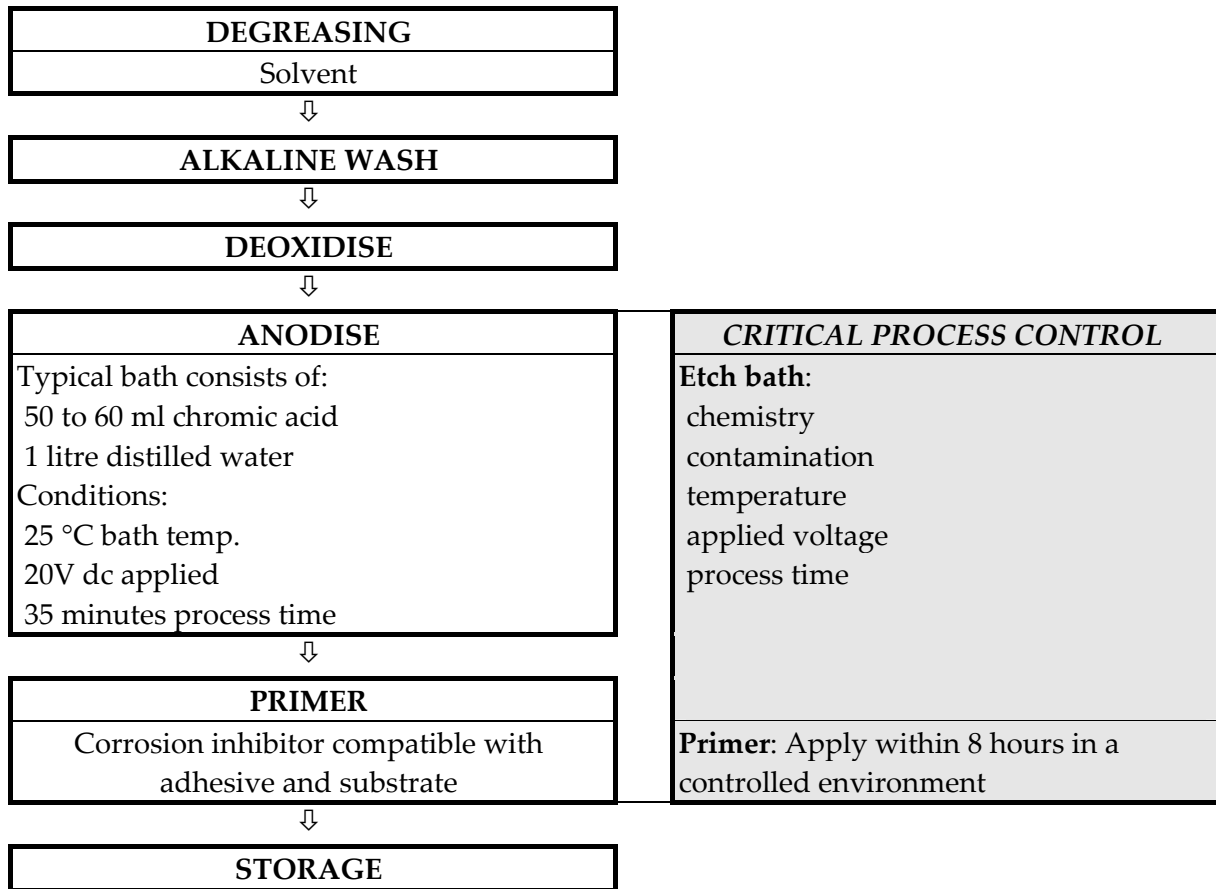

Some CAA processes include a chemical bath 'sealing' operation. This is detrimental to adhesive bonding, but is sometimes used prior to painting.

Figure 12.4-3 - Aluminium alloy surface preparation: Chromic acid anodise (CAA) process

12.4.6 Boric sulphuric acid anodising (BSAA)

12.4.6.1 General

The BSAA method, developed by Boeing (US Patent No. 4,894,127), is intended as a replacement for CAA chromic acid anodising. This is in response to US legislation on limiting Cr⁶⁺ emissions, Ref. [12-11]. It has also been evaluated as a pre-bonding surface treatment for the more common aerospace structural aluminium alloys, Ref. [12-12].

[See also: Development processes]

12.4.6.2 BSAA compared with CAA Process

An FAA-certified test programme compared boric sulphuric acid anodising with chromic acid anodising. This study showed that the two techniques gave similar results in shear, tension and wedge tests, and that BSAA was better in peel (wet floating roller bell peel). The BSAA failure

mode with epoxy AF73M adhesive was 100% cohesive, compared with 100% adhesive for the CAA prepared test coupons, Ref. [12-12].

BSAA coated surfaces appear clear, so difficult to detect visually. They do not have the grey mat surface produced by CAA, nor do they produce 'rainbow colours' under polarised light like PAA processed surfaces. Electrical resistance tests detect their presence.

Since the process was adopted as a pre-bonding treatment by Rohr (California) in 1990, it has been monitored carefully and routinely by surface analysis, corrosion tests and adhesive bonded wedge tests.

Production control samples of bare 2024-T3, approximately 3.2 mm thick, were bonded with AF73M adhesive. Wedge tests were carried out after environmental exposure. Any samples failing to meet the pass-fail crack propagation criteria were examined. Proper processing produces no crack growth under test, and the failure mode was 100% cohesive.

Figure 12.4-4 shows the BSAA process used by Rohr as a pre-bonding surface treatment, Ref. [12-12].

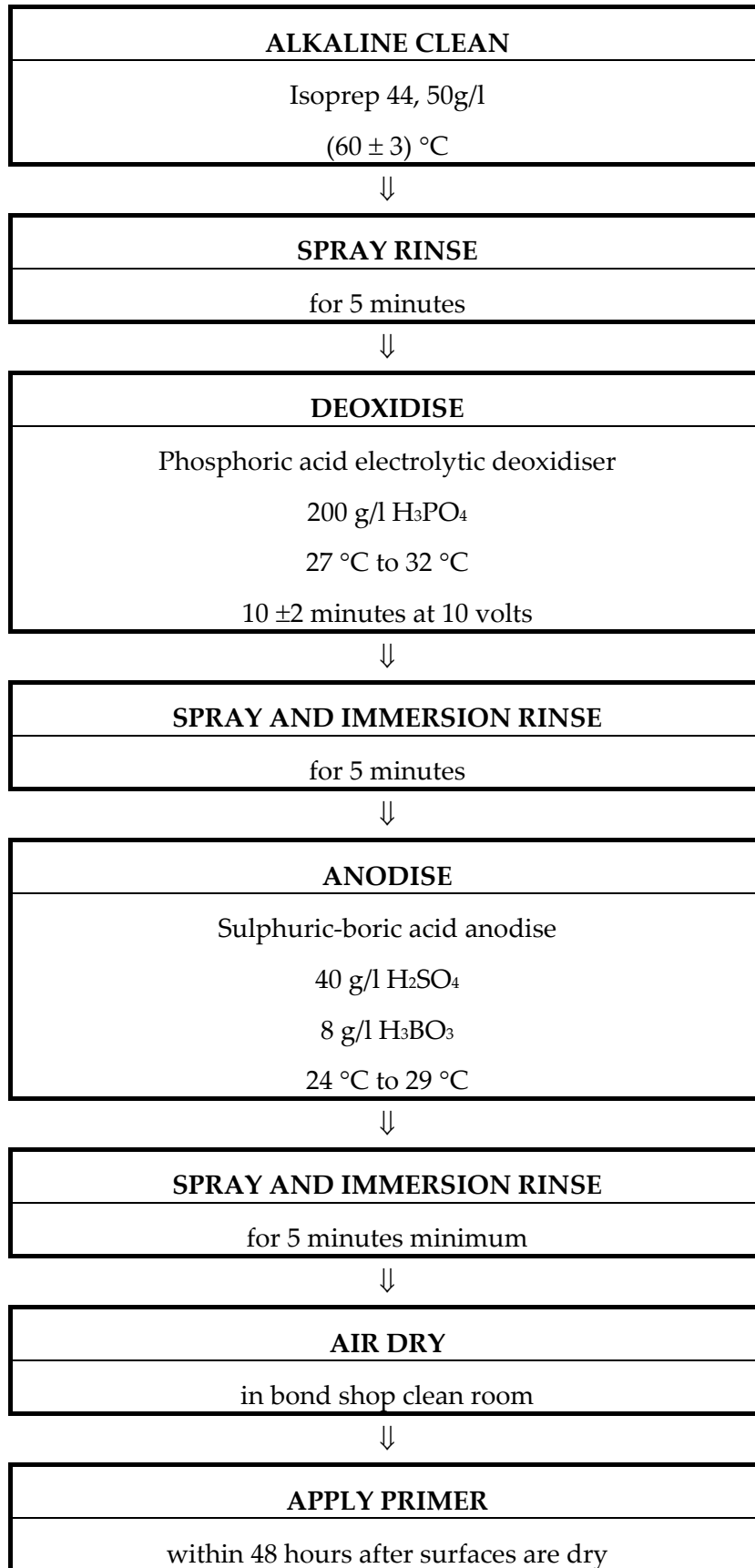

Figure 12.4-4 - Aluminium alloy surface preparation: Boric/sulphuric acid anodise (BSAA) process

12.4.7 Thin film sulphuric acid anodising (TFSAA)

Conventional sulphuric acid anodising (MIL-A-8625) is a corrosion protection treatment for aluminium alloys, but cannot be used for a pre-bonding treatment as the thick oxide coating fails cohesively or at the oxide-to-substrate interface, Ref. [12-13].

TFSAA is a modified sulphuric acid anodising treatment, developed by the Douglas Aircraft Company. It aims to provide corrosion resistance and durable adhesive bonds with a single process. The work evaluated the effects of processing parameters on the average coating weight growth rate, ACWGR, on bare 2024-T3 and 7075-T6. No data on bonded joint performance was given, Ref. [12-13].

12.4.8 Solvent vapour cleaning

12.4.8.1 General

Solvent vapour cleaning is a widely-used industrial cleaning technique, where the sample is held in a condensing solvent vapour. Condensed vapour runs back down into the heated solvent reservoir, carrying contaminants with it. The solvent re-appears, continuing the process, but the contaminants remain in the liquid solvent. This process, shown in Figure 12.4-5, can be used as:

- a degreasing method prior to chemical treatments for sheet or components,
- a pre-bonding treatment for aluminium honeycomb cores.

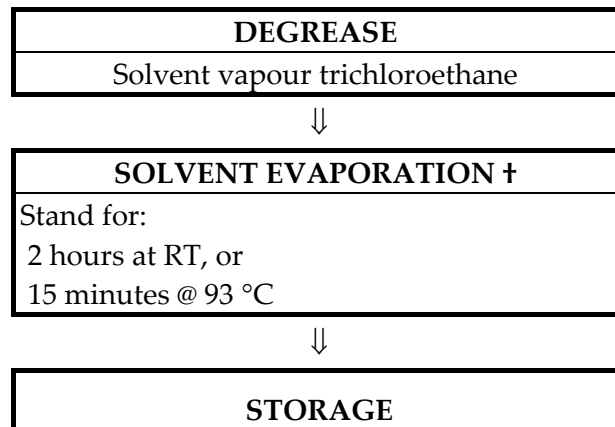

Key: †: CRITICAL PROCESS CONTROL: Ensure all solvent has evaporated.

Figure 12.4-5 - Aluminium honeycomb preparation: Solvent vapour cleaning

12.4.8.2 Aluminium foils

Acid etching and anodising processes tend not to be used for thin foils and complex **honeycomb** structures because adequate process control is difficult. The final removal of the corrosive reagents is also difficult, especially with perforated honeycomb cores.

12.4.9 Development processes

The majority of proven prebonding treatments use solvents for degreasing; many use chromium-containing chemicals too. Finding replacement surface treatment processes that conform to legislation restricting the use of heavy-metals and solvents, whilst providing adequate bond characteristics, is a continuing task within the aerospace community. The legislation affects not only bonding pre-treatment, but also those used prior to painting, for corrosion resistance, along with platings processes to inhibit wear and friction, e.g. cadmium and chromium. For bonding pre-treatments, the major concern is the presence and use of Cr6 in chemical-conversion coatings, e.g. chromating.

Figure 12.4-6 summarises various processes applied to aluminium alloys within the aerospace sector, Ref. [12-16].

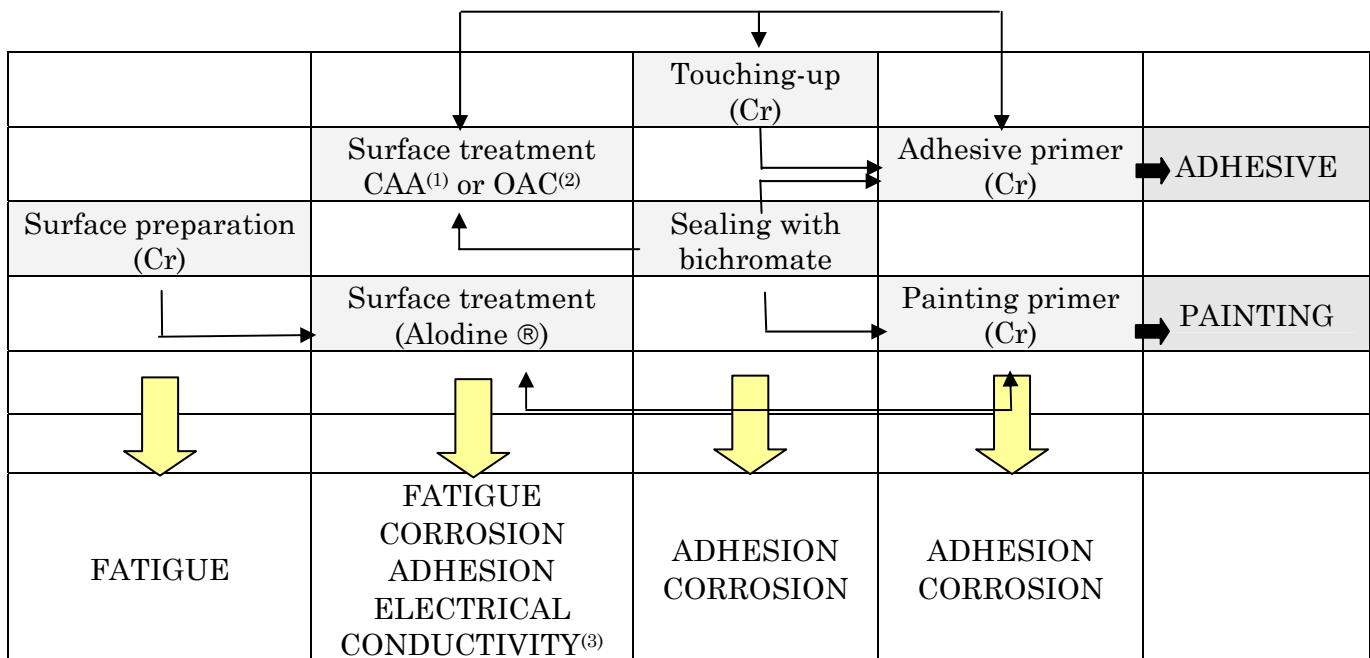

CAA: Chromic acid anodising process.

OAC: 'oxydation anodique chromique' the French term for CAA, which is a particular surface treatment for light alloy to avoid corrosion.

Alodine® is an industrial commercial chromating process that provides an electrically-conductive surface finish. It is used for corrosion protection of non-painted parts and also for a pre-painting surface treatment, rather than as a process prior to bonding.

Figure 12.4-6 – Surface preparation: Processes applied to aluminium alloys within the aerospace sector

In addition to the Boric sulphuric acid anodising (BSAA) process, other surface protection processes under consideration include, Ref. [12-16]:

- pickling, already used prior to some chemical conversion treatments. An acceptable level of bond strength should be proven.
- anodising, e.g. Phosphoric acid anodising (PAA); double anodising, MAA, CAA/OAC, tartaric acid. Adhesion and, in some applications, sealing need evaluation, along with demonstrating an acceptable level of bond strength.

Table 12.4-2 gives some of the processes under consideration, Ref. [12-16]. In general, these aim to either convert the Cr⁶ content to Cr³, or develop processes using other chemicals to which the legislation does not apply currently.

The suitability of the development processes for the surface treatment of aerospace materials prior to structural bonding should be established.

Methods and processes used to ensure adhesion of paint to prepared surface does not automatically mean that good strength and **durability** is achieved for any adhesively bonded joints made using the same surface preparation route.

Table 12.4-2 – Surface preparation: Development processes

Process type		Comments	
Conversion with Cr ³	Cr ³ hydroxide, precipitation of Cr ³ on cathodic sites (high pH).	No free chromium. Industrial process.	Good conductivity. Good corrosion protection. Good adhesion of paint.
Sol-gel	Oxides of silicon, zirconium, titanium and aluminium.	Application by dipping or spray-gun. Localised application possible, e.g. repair use	Nonconductive coating. Good adhesion of paint.
Cerium salts	CeO ₂ precipitation on cathodic sites.	Specific treatment for aluminium platings. Improved corrosion resistance of oxide coating.	Good corrosion protection. Good adhesion of paint. Weak in fatigue.

12.5 Titanium alloys

12.5.1 General

A wide variety of surface preparation methods exist for titanium alloys, especially the most commonly used Ti-6Al-4V alloy. Each organisation tends to create its own procedures for a particular application. Adhesive manufacturers also provide several alternative methods, Ref. [12-14].

The basic types of method involve:

- acid or alkali etch, which produce a pitted surface;
- anodising and conversion coatings (also known as chemical conversion coatings), which enhance and modify the naturally-occurring oxide layer.

Degreasing and cleaning stages cannot use chlorinated solvents. Any initial surface deposits are removed with non-metallic abrasives.

The processes employ strongly oxidising agents, so stringent safety measures in handling and storage of reagents is necessary.

The replacement of chrome-containing substances is under consideration because of environmental legislation.

12.5.2 Acid or alkali etch

Figure 12.5-1 summarises the process steps for an etching, or pickling, process.

Many different etching or pickling reagents are used, e.g. phosphate-based etches; sulphuric acid, hydrogen peroxide etches; alkaline etches.

Boeing BAC5890 is a nitric-hydrofluoric acid etch followed by CAA chromic acid anodising. This has been used for Ti-6Al-4V **honeycombs** with bonded aluminium alloy skins, Ref. [12-10] [12-10].

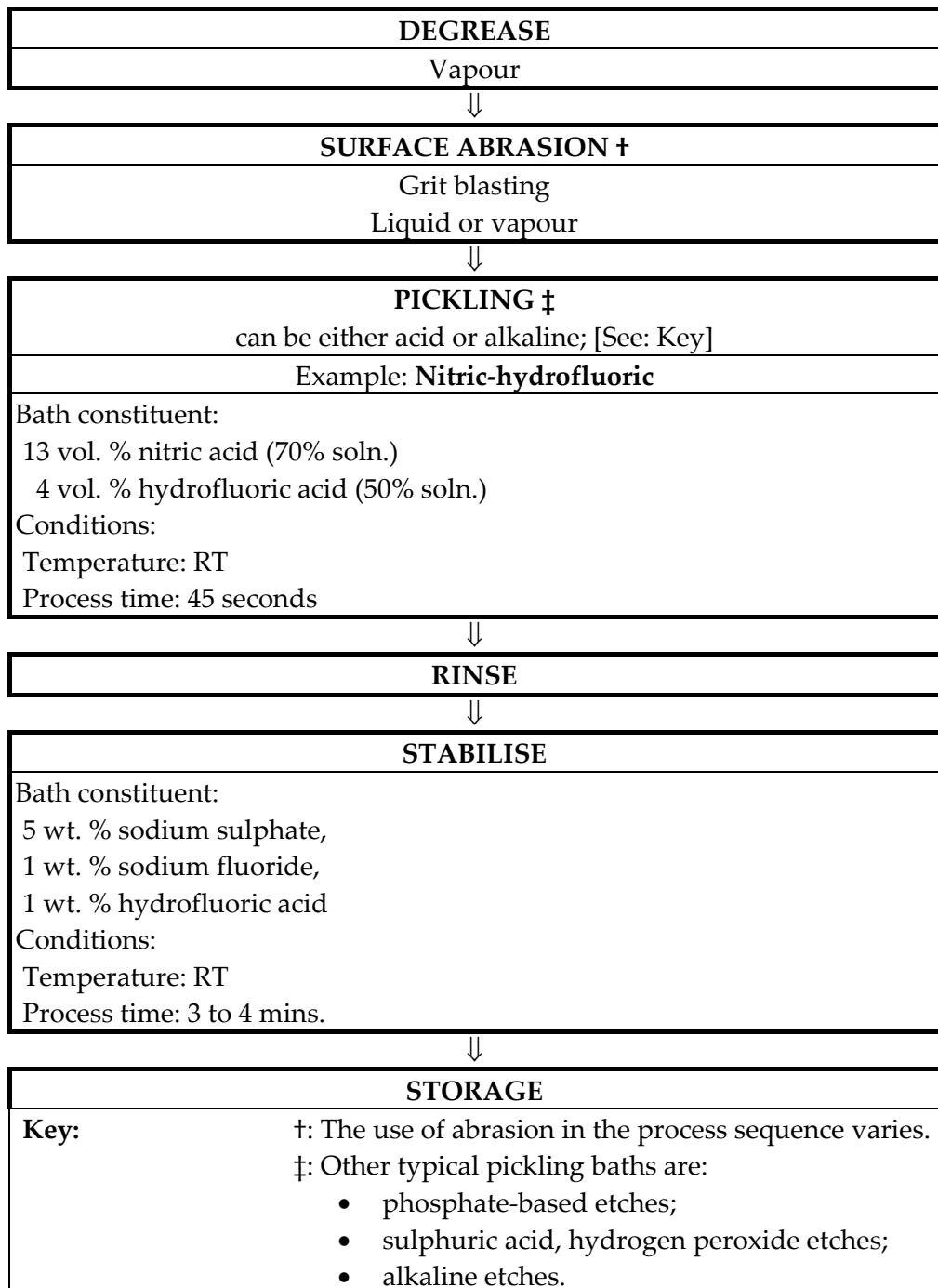
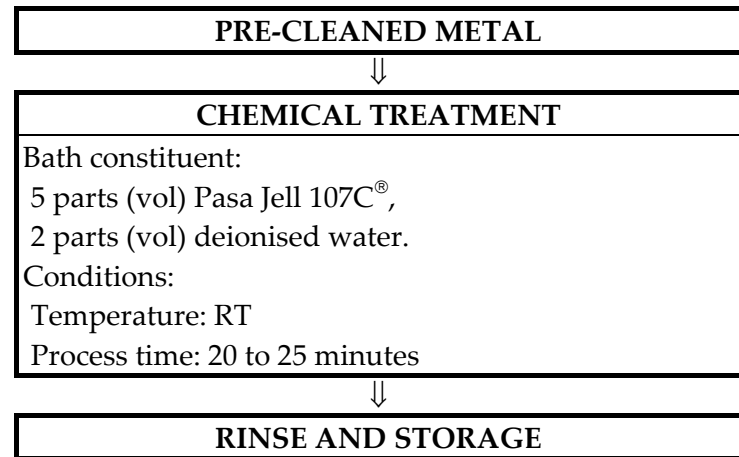

Figure 12.5-1 - Titanium alloy surface preparation: Etching

12.5.3 Non-chromium proprietary process

Figure 12.5-2 summarises the Pasa Jell 107C[®] process, widely used in the USA. It has performed well with epoxy adhesives curing at 170 °C. It has also been used to evaluate polyimide adhesives in preference to chromic acid anodising, Ref. [12-15].



® SEMCO Corporation

Figure 12.5-2 - Titanium alloy surface preparation: Pasa Jell 107C[®]

12.6 References

12.6.1 General

- [12-1] L.J. Matienzo et al: Martin Marietta Aerospace Labs, USA
 'Surface Preparation of Bonded Advanced Composites. Pt.1-
 Effect of Peel Ply Materials and Mould Release Agents on Bond
 Strength'
 Proceedings of 30th National SAMPE Symposium
 March 19-21, 1985
- [12-2] D.L. Messick et al
 'Surface Analysis of Graphite Fibre-reinforced Polyimide Composites,
 Pt.1'
 Proceedings of 15th National SAMPE Conference
 October 4-6, 1983, p170-189
- [12-3] A.V. Pocius & R.P. Wenz
 'Mechanical Surface Preparation of Graphite-epoxy Composite for
 Adhesive Bonding'
 SAMPE Journal, Sept./Oct. 1985, p50-58
- [12-4] J.M. Marinelli & C.L.T. Lambing: Alcoa, USA
 'A Study of Surface Treatments for Adhesive Bonding of Composite
 Materials'
 Proceedings of 38th International SAMPE Symposium
 10-13 May 1993, p1196-1210

-
- [12-5] Engineering Design Handbook
'Joining Advanced Composites'
DARCOM Pamphlet No. DARCOM-P 706-316
ADA/072 362. March 1979
- [12-6] Dexter Hysol: Hysol Aerospace Products Handbook
- [12-7] G. Lubin (Editor)
'Handbook of Composites'
Van Nostrand Reinhold, 1982. ISBN 0-442-24897-0
- [12-8] J.W. Powers: American Cyanamid Co., USA
'Recent developments in Adhesives for Bonding Advanced
Thermoplastic Composites'
Proceedings of 34th International SAMPE Symposium
8-11 May, 1989, p1987-1998
- [12-9] J.A. Bishop et al: Ciba-Geigy/UMIST, UK
'Characterisations of Adhesive/Adherend Interfaces in the
Aluminium-Lithium Bonded Joint'
Proceedings of conference 'Materials & Processing -
Move into the 90's'
- [12-10] Anon: Boeing Defense & Space Group/NASA
'System integration & Demonstration of Adhesive Bonded High-
temperature Aluminium Alloys for Aerospace Structure Phase 2/Final
report'
NASA-CR-191459
- [12-11] P.H. Wu: Boeing Commercial Airplanes, USA
'Implementation of Boric Sulphuric Acid Anodize at Boeing Wichita
Replacement for Chromic Acid Anodize'
Proceedings of 38th International SAMPE Symposium
10-13 May 1993, p796-804
- [12-12] J. Mnich & C. Schoneman: Rohr Inc., USA
'Sulphuric/Boric Acid Anodizing Status Report: First 22 months of
Operation July 1990 to May 1992'
Proceedings of 38th International SAMPE Symposium
10-13 May 1993, p819-833
- [12-13] D.P. Mancini: McDonnell Douglas Helicopter Co., USA
'Process variable Characterisation of Thin Sulphuric Acid Anodizing'
Proceedings of 38th International SAMPE Symposium
10-13 May 1993, p805-818
- [12-14] I. Skiest (Editor)
'Handbook of Adhesives'. 3rd Edition
Van Nostrand Reinhold Co. 1990
ISBN 0-442-28013-0
- [12-15] A.M. Brown et al: Boeing Defense & Space Group, USA
'Advanced Thermoplastic Resins- Phase II'
Report NAS 1 26:187548, Contract NAS1-17432, September 1991
- [12-16] EADS – Space Transportation
'The problem of Cr6 and Cd interdiction of use'
-

12.6.2 ECSS documents

[See: [ECSS](#) website]

ECSS-Q-70-71

Data for the selection of space materials and processes

13

Bonding methods

13.1 Introduction

13.1.1 Basic methods

Adhesive bonding can be carried out either:

- during the composite lay-up stage, where joints can be made with or without an adhesive. If separate adhesives are used, cure occurs at the same time as the composite prepreg. Both of these variants are described as 'Co-curing', [See: 13.2]
- solely at the assembly stage, where finished components are permanently joined together or to other parts of the structure; known as 'Secondary bonding'. It is used extensively to assemble metal and composite-to-metal structures, [See: 13.3]

Thermoplastic matrix composites can be joined by thermal bonding techniques, where either the matrix or an interlayer of thermoplastic is melted in the joint region, [See: 13.7].

13.1.2 Adhesives

13.1.2.1 Co-curing

Co-curing with an adhesive normally employs a **film** adhesive, which is chemically compatible with the matrix resin. It is cured to give the desired properties at the same cure temperature as that of the composite lay up, [See: 13.2].

13.1.2.2 Secondary bonding

Secondary bonding can make use of **film** or **paste** adhesives. Again the adhesive is chosen to be chemically compatible with the adherends. Curing occurs:

- at a temperature lower than the cure temperature of the composite, and
- at a temperature that does not alter the heat treatment of metal components.

Mixed composite and metal assemblies tend to use **RT-curing** adhesives; often post-cured at moderate temperatures, e.g. 40 °C to 50 °C. High-temperature-cure adhesives are not used because of thermal expansion differences that cause stresses in the joint on cooling, [See: 13.3]

13.1.3 Composite structures

13.1.3.1 Structural joints

The choice between co-curing or secondary bonding has a number of implications at the design stage, as well as for the manufacture. Factors influencing this choice are summarised in Table 13.1-1.

Table 13.1-1 - Comparison between co-curing and secondary bonding as an assembly technique for composite structures

Co-cure	Secondary bonding
Parts to be joined are both composite	Parts to be joined are composite, metal or a mixture of both.
Mechanical performance criteria of joint region can be met by either: <ul style="list-style-type: none"> • composite resin matrix, • adhesive. 	Adhesive is chemically compatible with all adherends. Cure does not degrade adherends: <ul style="list-style-type: none"> • temperature, • time, • pressure.
Adhesive is compatible (chemically + cure) with composite.	Mechanical performance criteria of joint region can be met by adhesive.
Composite lay-up has been designed for co-curing.	Composite lay-up has been designed for adhesive bonding.
Adjacent plies of preferred orientation without compromising strength-stiffness of composite.	Surface preparation methods and equipment are available.
Tooling is available for complex geometry needed and is cost effective.	Jigs and tools are available.
Process machinery is available for total component size: <ul style="list-style-type: none"> • lay-up, • autoclaves, • ovens (post-cure). 	Process machinery is available: <ul style="list-style-type: none"> • mixing and metering, • application aids, • ovens and autoclaves (films).
Dimensional tolerances on components can be met.	Tolerances on components are designed for necessary bondline thickness.
Thickness of adherends in the joint overlap is acceptable. Note: Wide variations in thickness within a single component result in changes to the composite cure schedule.	Inspection and test criteria can be met.
The total component size can be handled with subsequent damage.	Finished component can be assembled from items from many sources.
The design of the joint is such that it limits the opportunity for defects, e.g. voids, resin rich zones, non-uniform bondline thickness.	
Inspection and test criteria can be performed on the finished complex shape and size of the component.	
Finished component is a single-source operation.	

In general, composite lay-ups are specifically designed for bonding, such that the surface plies in the bond region are orientated in the loading direction. This can be achieved by adding additional plies in the joint, rather than adjusting the overall composite lay-up and hence modifying its overall stiffness or strength.

13.1.3.2 Bonded stiffeners

Where a thin laminate needs a localised increase in strength or stiffness, additional composite material, in the form of a flat or shaped stiffener, can be adhesively bonded to the laminate. This is not a joint in the true sense since the laminate is continuous, i.e. the load path is not disrupted. However, the bond is responsible for ensuring that the stiffener remains attached and consequently its integrity is then guaranteed.

13.2 Co-curing

13.2.1 Applications

13.2.1.1 General

A significant advantage of using advanced composites is that single components with complex geometries can be produced in one operation. This reduces the number of parts, in comparison with a metal assembly of equivalent performance. It does however mean that the process equipment used, i.e. autoclaves and associated consumables; need to cope with large, often fragile, items of complicated shape. Likewise, the inspection of large, complex objects is more difficult than that of individual components.

In practice, composite structures are manufactured using a mixture of **co-curing** and secondary bonding assembly operations.

Co-curing is used extensively in the manufacture of **sandwich panels**, where the skins are co-cured to the **honeycomb** core. Joints between laminated items and stiffeners can also be co-cured, Ref. [13-1].

[See also: 22 for case studies of co-cured sandwich structures]

13.2.1.2 Lay-up

With careful design, composite lay-ups are created so that the part can be manufactured as a single entity. This can be achieved by combining the various 'lay-ups' either with or without an adhesive.

Both of these techniques, shown schematically in Figure 13.2-1 are known as **co-curing**. However significant differences exist between them and these are described in Table 13.2-1.

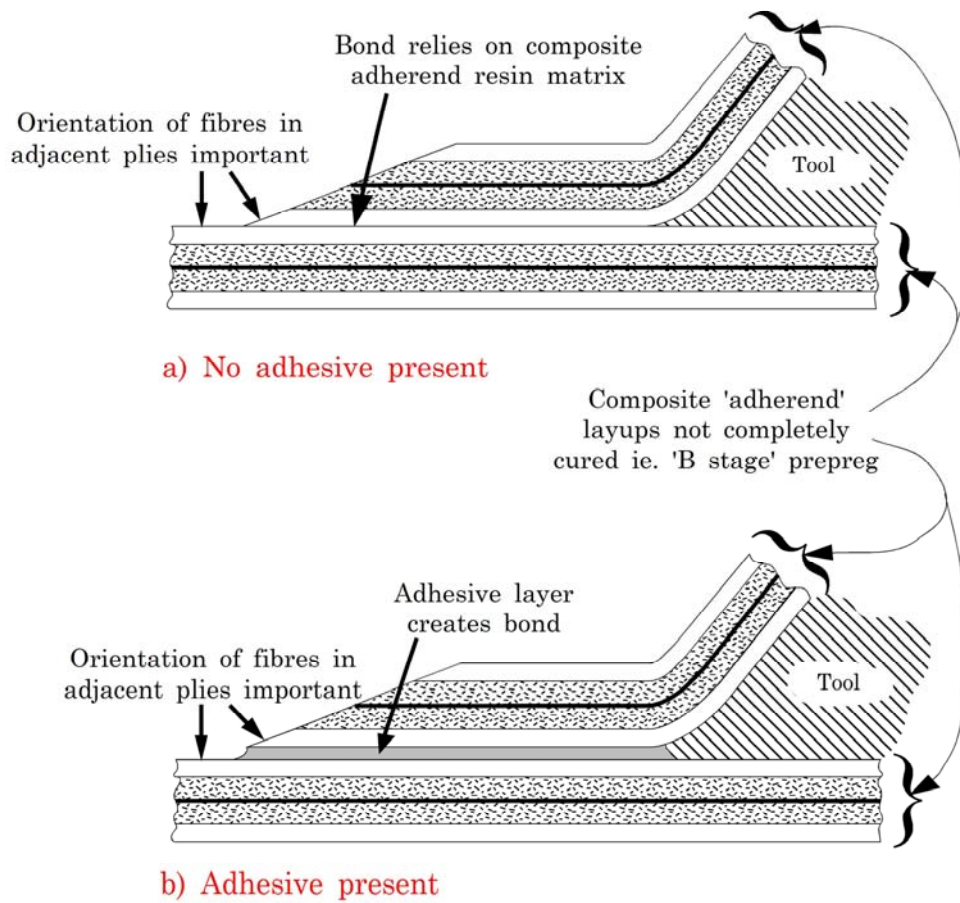

Figure 13.2-1 - Diagram of co-curing joints for composites: With and without an adhesive layer

Table 13.2-1 - Co-curing methods for composites: With and without an adhesive layer

Co-cure: No Adhesive	Co-cure: With Adhesive
Composite resin matrix is responsible for load transfer between two or more composite parts.	Adhesive is responsible for load transfer between two or more composite parts.
Mechanical performance of joint region can be met by resin matrix: <ul style="list-style-type: none"> • strength, • stiffness, • strain to failure. 	Mechanical performance of joint region can be met by adhesive: <ul style="list-style-type: none"> • strength, • stiffness, • strain to failure.
Only used where there is no or low incidence of shock loading.	Adhesive is chemically compatible with composite matrix and fibres.
	Adhesive cure schedule, to give adequate joint performance, is compatible with composite resin matrix cure schedule, e.g. temperature and pressure.

13.2.1.3 Composite resin matrix state

Co-curing is undertaken before the resin matrix of the **adherend** is cured, i.e.:

- wet (**filament winding**, wet-lay up),
- **B-stage** (prepreg and tapes),
- gelled (filament winding, wet lay-up).

Different adhesives are often used for B-stage and gelled resin states.

13.2.2 Loading

13.2.2.1 General

The expected loading modes and load levels need close consideration for **co-cured** parts. Non-ideal loading modes, such as **peel**, should be minimised, [See also: 8.3].

13.2.2.2 Co-cured joints without an adhesive

Load transfer relies on the properties of the resin matrix. Most matrix resins have lower strain to failure than proprietary adhesives. Good strength joints are obtained where:

- no obvious bondline is visible, i.e. the matrix content and distribution is the same as within the composite,
- the **bondline** contains no voids or other defects.

13.2.2.3 Co-cured joints with an adhesive

The adhesive acts as the load transfer medium. The design takes into account that the loads experienced can be met both by the adhesive, and locally by the composite.

13.2.3 Adhesives

13.2.3.1 General

Film adhesives, either supported or unsupported, are preferable to pastes for **co-curing**.

Adhesive suppliers offer assistance in the selection of their products for co-curing operations.

13.2.3.2 Unsupported films

The bonding of **honeycomb** sandwich panels uses unsupported films which 'reticulate' or retract to the cell walls during processing, as shown in Figure 13.2-2. The final **bondline** forms adhesive fillets along the cell walls rather than a uniform layer of adhesive across the internal sides of the skins.

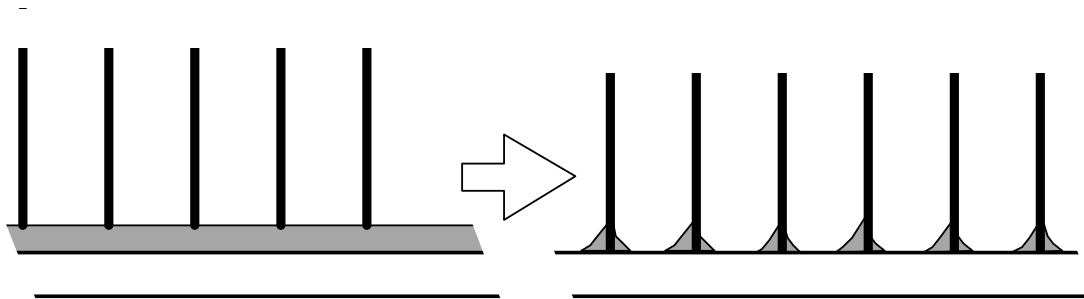

Figure 13.2-2 - Reticulating film adhesive during cure

13.2.3.3 Supported films

The role of a carrier in a supported **film** adhesive is to aid **bondline** thickness control. Often a number of different types of carrier materials and thicknesses are available for a particular adhesive. A reference for the type of carrier is often encrypted into the adhesive product code.

The carrier material is selected to be such that the composite cure schedule does not degrade or destroy it, disrupting the bondline. For **-imide** type adhesives with higher-temperature cures, the carrier is normally glass rather than nylon or polyester, [See also: 6]

13.2.4 Tooling

The tooling design for co-curing operations should ensure that all the parts are adequately supported during the cure sequence.

Problems have been encountered when thin skin laminates are co-cured onto **honeycomb** cores, because the cells do not provide adequate support. Consequently the fully cured sandwich panel has a dimpled appearance, which is unacceptable for antenna dishes with their high dimensional and geometrical tolerances.

13.3 Secondary bonding

13.3.1 General

The assembly of cured composite or metal parts, or a combination of both, forms the majority of secondary bonding operations. It is widely used for the assembly of aerospace structures. It also enables joining of component parts from different sources.

[See also: 21 for examples of secondary bonded structures]

13.3.2 Adhesives

13.3.2.1 General

The adhesives used can be either **paste** or **film** types, the choice depending on the joint design and on whether particular properties such as '**gap-filling**' are necessary. This is possible with pastes, but not with film types. Some adhesive formulations foam during cure, giving a large increase in volume; between 1.5-times and 5-times, typically. These are used for **honeycomb** core splices and close-outs.

[See also: 6 for adhesive characteristics and properties]

13.3.2.2 Films

Films are particularly useful, and easier to handle than pastes, for certain applications, e.g.:

- large areas of thin **bondline**,
- overlap type arrangements, or
- bonding cured thin skin laminates to **honeycomb** cores.

13.3.2.3 Pastes

Pastes are generally used for:

- bonding edge members, either structural or cosmetic;
- placing inserts into honeycomb panels;
- bonding metal fittings to composites and honeycomb panels.

13.3.3 Tooling

In addition to composite moulding tooling, additional jigs and tools are needed for secondary bonding. These are usually less sophisticated than for moulding.

13.4 Applying adhesives

13.4.1 Film adhesives

13.4.1.1 General

Supplied as sheets or rolls, **film** adhesives are sandwiched between two release sheets. Film thicknesses are generally in the range of 150µm to 250µm, although others are available. The choice of thickness largely depends on the final bondline thickness needed and whether the adhesive is supported on a carrier material.

13.4.1.2 Storage

Film adhesives need refrigerated storage (−20 °C, typically) as soon as they are delivered. They are stored in sealed containers to prevent moisture contamination. Moisture evaporates from the outside of the container before opening for use. Adhesive manufacturers' provide guidance for storage. Film adhesives are classed as limited shelf-life materials, [See: ECSS documents: ECSS-Q-ST-70-22].

13.4.1.3 Handling

Handling operations for film adhesives are the same as those for thermosetting prepreg materials, so the precautions taken regarding storage, cleanliness and application are the same. Adhesive manufacturers' provide guidance for handling.

13.4.1.4 Application

Guidelines for the application of film adhesives include:

- Adherend surfaces for bonding are cleaned and properly prepared, [See also: 12 for surface preparation].
- One release ply is removed and the adhesive film placed on one of the adherends.
- Adhesive film is cut to shape and rolled to remove trapped air.
- The other release ply is removed just before assembling the mating part. Premature removal of the release ply can enable moisture, dust or other contamination of the adhesive bondline.
- Assembly is made within the period specified for the adhesive; also known as the working-life.

13.4.1.5 Working life

The working-life of film adhesives is often several days at 25 °C, but decreases with increasing temperature.

13.4.2 Paste adhesives

13.4.2.1 Storage

The storage temperature for a **paste** adhesive depends on the particular type. Some are stored at room temperature, whilst others need refrigeration. In all cases they are stored in sealed containers

to prevent moisture contamination. Before resealing containers after use, it can be necessary to back-fill with an inert gas. For those which have been stored cold, moisture will evaporate from the outside of the container before opening for use. Paste adhesives are classed as limited shelf-life materials, [See: ECSS documents: ECSS-Q-ST-70-22]

13.4.2.2 Handling

Accurate metering and thorough mixing of two-part adhesives is necessary. Adhesive manufacturers' provide guidance for handling.

13.4.2.3 Application

Guidelines for the application of paste adhesives include:

- **Adherend** surfaces for bonding are cleaned and properly prepared, [See also: 12 for surface preparation].
- **Paste** adhesives can be applied manually or automatically:
 - One-part adhesives can be applied with a simple gun device, Ref. [13-2]; as shown in Figure 13.4-1.
 - Two-part systems need precise metering of each component and complete mixing prior to their application. Some equipment enables both metering and mixing; as shown in Figure 13.4-2, Ref. [13-2].
- Assembly is made within the period specified for the adhesive; also known as the **pot-life**.

13.4.2.4 Pot life

The pot life is usually quoted for a predetermined mixed quantity at a particular temperature. Pot-life is reduced for larger mix quantities because heat from the exothermic cure reaction escapes less easily.

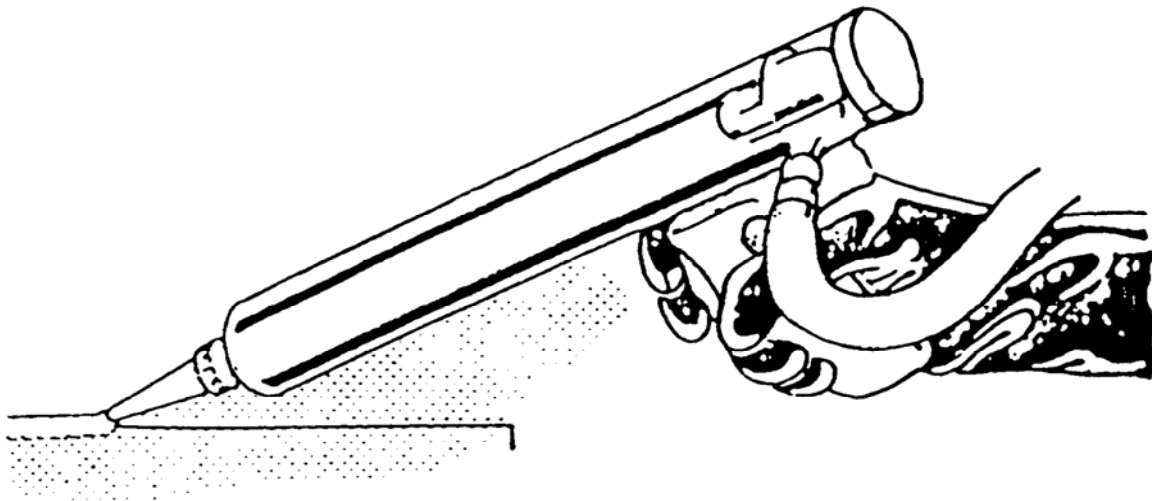

Figure 13.4-1 - Hand operated applicator for one-part paste adhesives

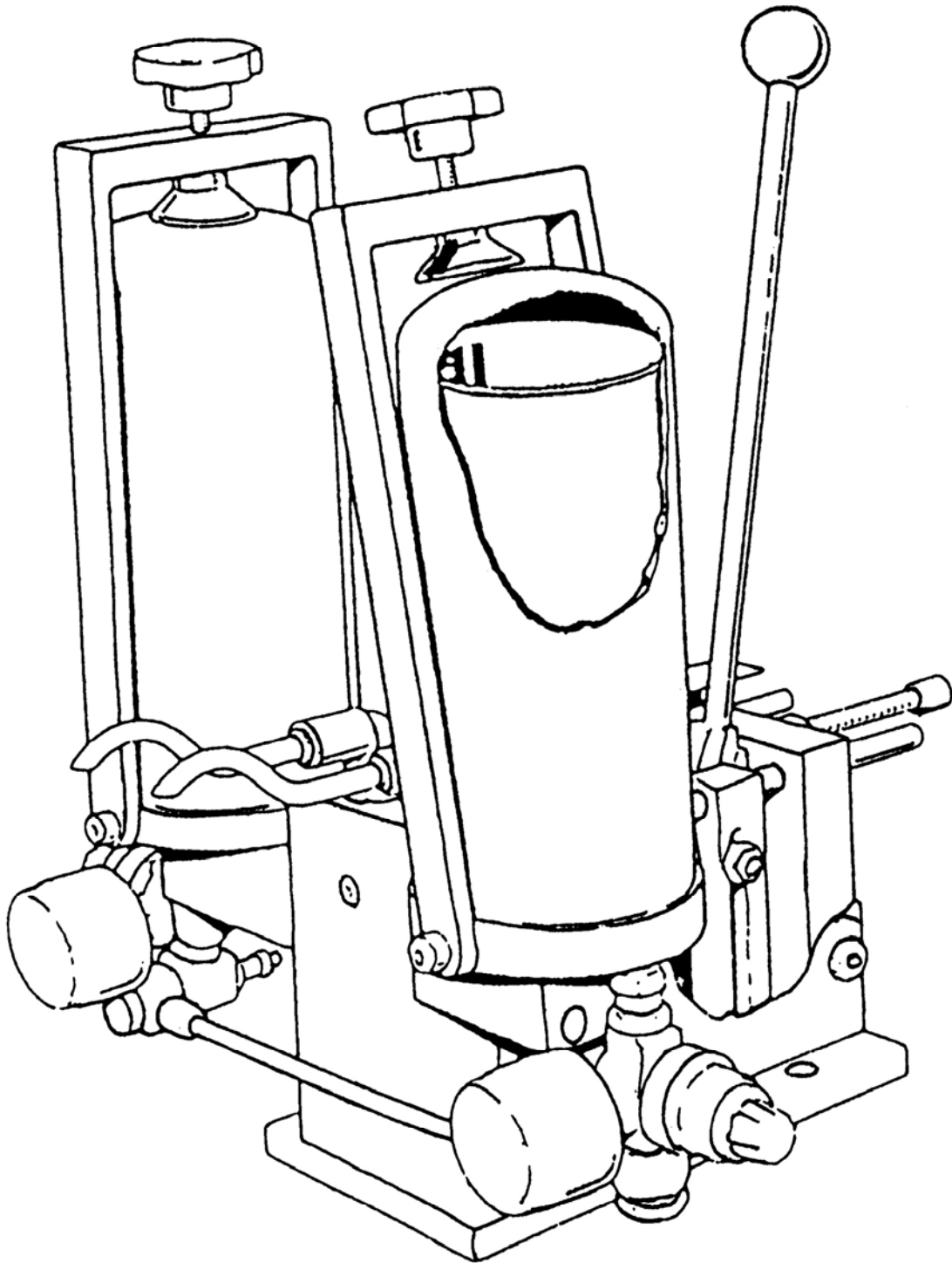

Figure 13.4-2 - Hand operated proportioning machine for two-part paste adhesives

13.4.3 Manufacturing processes

The typical operations involved in applying both **film** and **paste** adhesives are shown in Figure 13.4-3, [See also: 13.5].

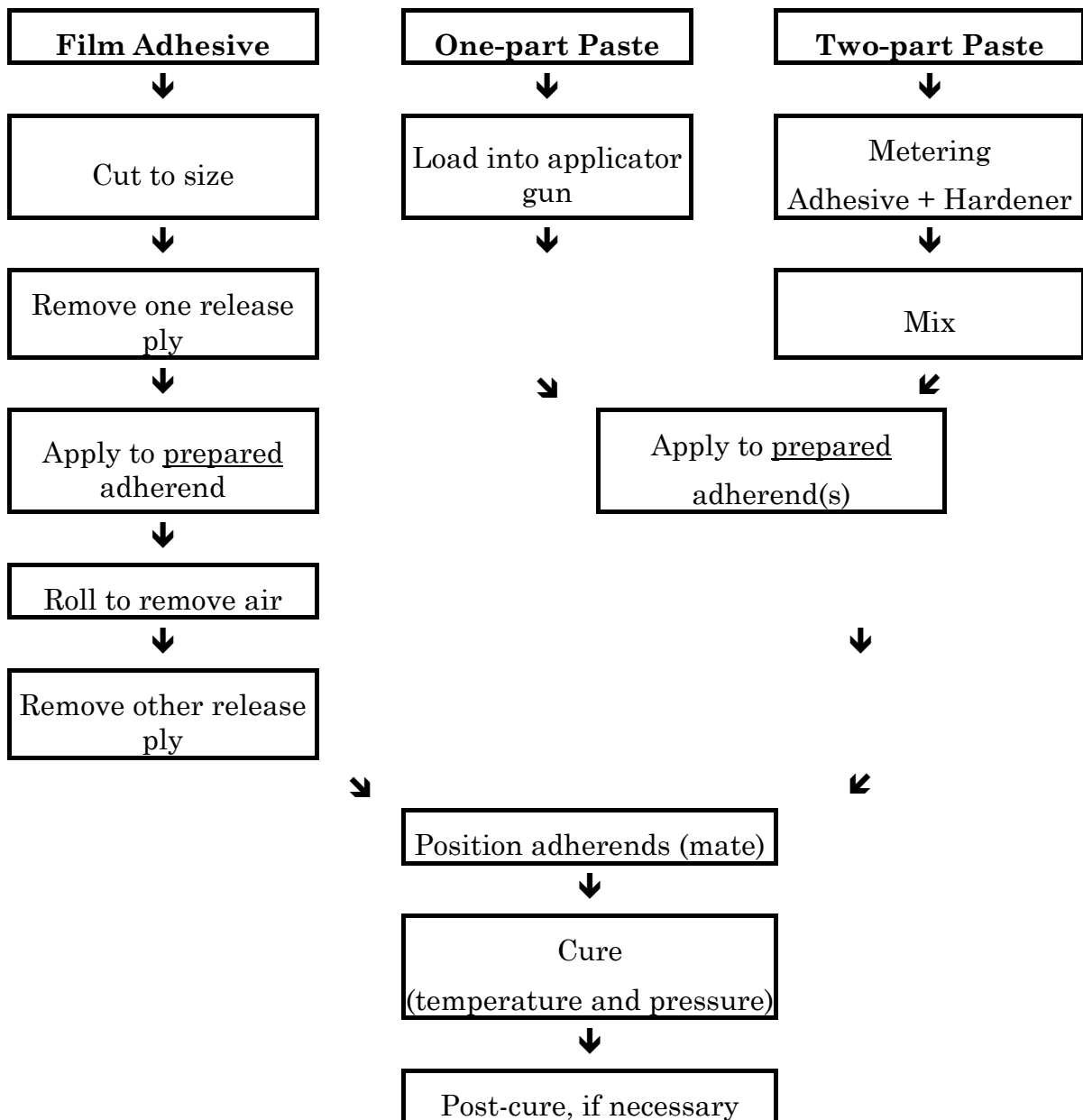

Figure 13.4-3 - Typical application route for film and paste adhesives

13.5 Manufacturing factors for adhesives

13.5.1 General

Details of the factors involved in the manufacture of adhesively bonded joints either by use of a **film** or **paste** adhesive are shown in Table 13.5-1.

The factors were identified in the adhesive selection and design process, [See also: Figure 7.2-1].

13.5.2 Product-specific factors

Each proprietary product has particular demands that should be met during manufacture, e.g. pot- or working-life, cure schedules.

Information provided by adhesive manufacturers aim to ensure correct processing to obtain **bondline** integrity.

Table 13.5-1 - Manufacturing factors for adhesives

	FILM		PASTE	
	Unsupported	Supported	One-part	Two-part
Shelf Life	1 year for sub-zero storage, typically		6 months for cold storage, typically	1 year for cold storage, typically
Storage	Cold: -18 °C for maximum shelf life		Cold: 5 °C for maximum shelf life, typically	
Physical state	No carrier	Carrier	Various viscosity products available. Some are thixotropic. Can contain glass spheres for bondline control. Can be filled with metallic or non-metallic phases.	
	Various areal weights and thickness (150µm to 250µm, typically)			
Gap filling	Poor		Good	
Moisture sensitivity	Slight in uncured state. Dry storage needed		Slight in uncured state. Dry storage needed	Hardeners and catalysts tend to be moisture sensitive
Packaging	Sheets or rolls (10m ² to 60m ² , typically)		Metal tins or drums (50g to 2kg typically). Larger quantities also available.	
Equipment	Cutting and placement. Jigs to position parts. Cure oven or autoclave.		Gun applicator	Metering and mixing applicator.
Clean-up	Low. Tooling cleaned with solvents or abrasives (if cured)		Low-to-moderate. Machinery and tooling cleaned with solvents.	
Waste	Low		Low-to-moderate, depending on equipment used.	
Labour	Depends on equipment used.			
Pot Life	-		Depends on volume and temperature	0.5 to 2 hrs at RT, typically
Working Life	Several days from cold storage. Several hours during assembly		-	
Handling	Films become tacky as they warm up. Tack aids placement.		Not to be moved until cure is advanced after adherends are mated on jigs.	
Plant Environment	Cleanliness, moisture and temperature need control, e.g. 40% to 60%RH; 18 to 24 °C, typically. Venting of solvents and odours necessary. Filtering incoming air.			
Flash Point	95 °C for adhesive constituents, typically. Venting of solvent vapours necessary.			
Cure Temperature	Epoxy: 120 °C or 175 °C Polyimide: 177 °C + Post-cure 290 °C Bismaleimide: 177 °C + Post-cure 220 °C, typically		Epoxy: RT	Epoxy: less than 100 °C
Cure Pressure	100 to 350 kNm ⁻² , typically		Low. Often only enough pressure to maintain adherend position.	
Cure Time	Epoxy: 0.5 to 1 hour Polyimide: 2 to 3 hours, inc. post-cure Bismaleimide: 2 to 3 hours, inc. post-cure		Handleable after 24 hours. Full cure 7 to 14 days	2 to 3 hours, inc. post-cure
Health and Safety	Adhesives and their constituents contain organic compounds that can cause skin, eye or respiratory irritations. Conformance to all regulations for handling adhesives and solvents are mandatory			

13.6 Bondline integrity

13.6.1 General

The ultimate strength attainable by an adhesive bond can be significantly reduced by deviation from the correct production sequence.

13.6.2 Manufacturing-related factors

Manufacturing-related factors known to profoundly affect the properties of the final bond are listed to serve as a check-list. These points are included in a quality management system operating in the assembly plant, [See also: 14]:

- Ensure that storage of adhesives is monitored and that stipulated shelf-life limits are observed.
- Avoid moisture contamination of adhesives, especially those removed from cold storage.
- Adhesives removed from cold storage need to warm thoroughly to room temperature before use.
- Apply correct surface pretreatments for a particular adherend-adhesive combination.
- Ensure that release sheets are removed completely from film adhesives.
- Avoid handling prepared adherends and film adhesives in the bond area without adequate protection against contamination, e.g. dust, grease and moisture.
- Two-part paste metering and mixing equipment needs regular cleaning and calibration.
- Clean and maintain equipment regularly, including tooling jigs.
- Monitor cure oven and autoclave temperature. The charging load can affect this.
- Ensure strict observance of regulations for the handling and disposal of adhesives and solvents.

13.7 Thermal bonding thermoplastic composites

13.7.1 General

Thermoplastics have the ability to be repeatedly resoftened and shaped, a property that **thermosetting** materials do not possess, Ref. [13-3]. Being able to use the matrix thermoplastic as an adhesive to join components is attractive because it matches the adhesive bond performance to that of the composite. This echoes the established practice of using thermosetting epoxy adhesives with epoxy matrix resin systems.

The thermoplastics used as composite matrix phases melt at relatively high temperatures. Cooling from the laminating temperature is carefully controlled to achieve the correct polymer morphology, hence properties.

Thermal bonding processes are optimised such that the cooling rates used do not compromise the mechanical performance of the composite in the joint region.

Thermal bonding processes, often called ‘Welding techniques’, can be grouped as those which:

- do not use an interlayer; known as ‘Direct bonding’, Ref. [13-3];
- use a thermoplastic interlayer in the joint, e.g. ‘Thermabond process’, Ref. [13-4].

13.7.2 Direct bonding

13.7.2.1 Temperature

To create an adhesive bond, the thermoplastic composite is locally heated to a temperature at which the matrix is molten and of relatively low viscosity. This local heating can be achieved by a number of different techniques; as shown in Table 13.7-1, Ref. [13-5].

Table 13.7-1 - Thermoplastic matrix composites: Welding techniques

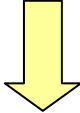
Technique	Lap shear strength	Comments
Vibration welding	Best	Preliminary technology study on APC2 coupon samples to ASTM D-1000
Resistance welding		
Induction welding	Worst	

13.7.2.2 Pressure

A low pressure is applied to hold the adherends in position as the joint cools. With no cure schedule, such as that needed for thermosetting adhesives, the process times can be greatly reduced, making the process less expensive, [See also: 13.8 for rapid adhesive bonding].

The applied pressure is sufficient to hold the adherends together whilst softened, but not cause fibre motion or permanent distortion within the heated area of the composite. This can be difficult to achieve in practice

13.7.3 Thermabond process

Thermabond was developed by ICI for PEEK matrix laminates. It involves laminating a surface film of PEI thermoplastic onto the areas to be bonded during the manufacture process of the composite laminate. As the melting temperature of PEI is lower than that of PEEK, bonding can be achieved at a lower temperature than that of direct bonding, and without incurring problems of fibre motion or distortion to the laminate.

A development of this process uses a 100µm thick PEI film interlayer inserted between the two ‘standard’ thermoplastic composite adherends. This avoids the need to laminate the PEI film during composite manufacture, Ref. [13-4]. Again a lower temperature is needed for bonding.

The factors having a positive influence on the toughness of joints produced by this method are:

- the interlayer, which creates surface migration of fibres in the joint zone,
- the amorphous state of the surfaces of the adherends before welding,
- the amorphous state of the joint after welding.

13.7.4 Welding techniques

Specialised welding techniques can be used to remelt the matrix in the bond region producing a fusion bond without the need for a separate adhesive phase, Ref. [13-3], [See: Table 13.7-1; 13.8 for rapid adhesive bonding]. In other studies, ultrasonic and vibration welding caused fibre damage and breaks in the surface plies of composites, Ref. [13-4].

13.8 Rapid adhesive bonding (RAB)

13.8.1 General

The RAB technique, involving localised heating of the **bondline**, was developed by NASA Langley Research Centre, Ref. [13-6].

RAB is a potential assembly, or secondary bonding, technique for both composite and metal components for space use. A complete evaluation programme, to investigate mechanical and environmental tolerance, is needed to ascertain the durability of bonded assemblies destined for space.

13.8.2 Applications

Potential RAB uses include:

- **Thermoplastic** 'adhesives', [See also: 13.7];
- **Thermosetting** adhesives;
- Aircraft windscreen repairs;
- Hydraulic tube repairs;
- General repairs of aircraft control surfaces;
- Space hardware assembly;
- 'Spot bonding' adherends together prior to full autoclave joint consolidation.

13.8.3 Materials

13.8.3.1 Adherends

The RAB technique was initially evaluated for joining:

- thermoplastic matrix composites;
- thermosetting matrix composites;
- metals.

Table 13.8-1 summarises the various types of adherends investigated, Ref. [13-6].

Table 13.8-1 - Rapid adhesive bonding (RAB): Adherends

Product Code	Description	Application
Composite:		
-	Carbon fibre reinforced polyimide	Laminate, faceskins for honeycomb sandwich
T300/5208	Carbon fibre reinforced epoxy	Laminate, faceskins for honeycomb sandwich
Nomex	-	Honeycomb core
Metal:		
-	Aluminium alloy	Sheet and honeycomb core
Ti-6Al-4V	Titanium alloy	Sheet and honeycomb core
Beta-alloy	-	Shape memory metal sleeve for hydraulic tube repairs
Tinel	-	
Nitinol	-	
Plastic:		
-	Polycarbonate	Aircraft windshields
-	Acrylic	Aircraft windshields

13.8.3.2 Adhesives and interlayers

A **thermoplastic** interlayer or **thermosetting** adhesive is placed in the bondline. Table 13.8-2 summarises types of adhesives investigated, Ref. [13-6].

Table 13.8-2 - Rapid adhesive bonding (RAB): Adhesives

Product code	Supplier	Description
Thermosetting:		
HT424	Cyanamid	Epoxy-phenolic
Scotchweld EC1386	3M	Epoxy paste
AF163	3M	Elastomer modified epoxy
	† NASA-Langley	Bismaleimide-siloxane diamine
Thermoplastic:		
P-1700	Union Carbide	Polysulphone
	† NASA-Langley	Polyimidesulphone (PISO ₂)
LARC-TPI	Gulf	Thermoplastic polyimide
PEEK	ICI	Polyetheretherketone
	† NASA-Langley	Polyphenylquinoxaline (PPQ)
Ultem	General Electric	Polyetherimide
	† NASA-Langley	Silane end capped polyimide
	† NASA-Langley	Linear thermoplastic polyimide with silane additions
	† NASA-Langley	Hot-melt polyimide (BDDA+APB)

Key: † Experimental adhesive - not commercially available

13.8.4 Process

The characteristics of the equipment used in the RAB process are:

- direct heating of the **bondline**, avoiding heating of the whole structure,
- no heating of jigs and fixtures,
- factory and site assembly, with a portable unit.

13.8.5 Equipment

The equipment, shown schematically in Figure 13.8-1, Ref. [13-6], consists of:

- a low-power toroidal induction heating unit, using eddy currents as the heating medium.
- a metal susceptor which, coated with a **thermoplastic** or sandwiched between two **thermoset** adhesive films, localises the heating to the bondline.
- a commercial fibre optic **IR** temperature probe to monitor the **bondline** temperature. This is an important process parameter.

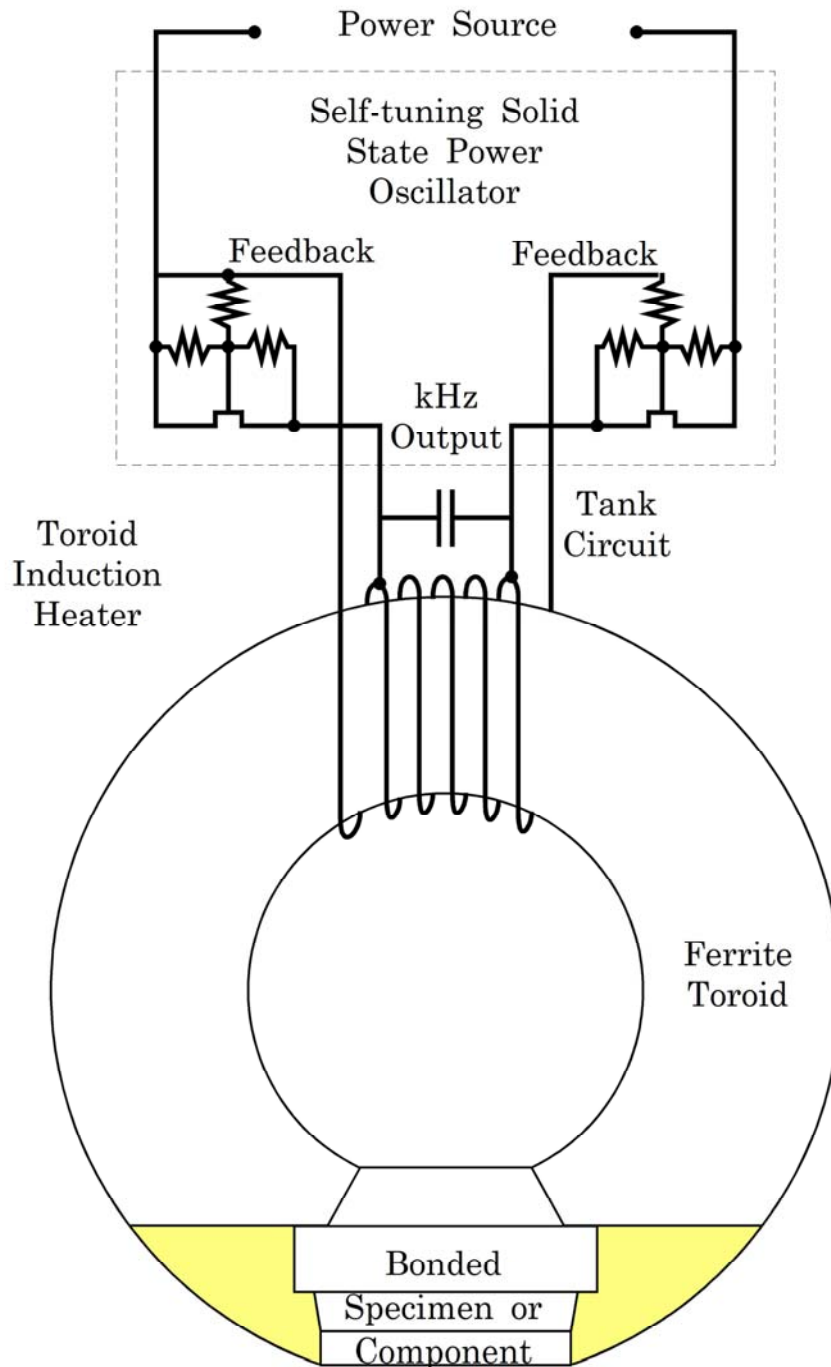

Figure 13.8-1 - Rapid adhesive bonding (RAB) equipment

13.8.6 Carbon fibre reinforced composites

A simplified process can be used for **CFRP** materials because the carbon reinforcement acts as a satisfactory susceptor for induction heating. This avoids the need for an additional metal susceptor in or at the bondline. Carbon-reinforced thermoplastic composites can also be 'welded' without an additional interlayer, Ref. [13-3], [13-6].

[See also: 13.7 for various thermal bonding techniques]

13.8.7 Joint strength

Preliminary coupon trials showed that the lap shear strengths obtained are comparable with those achievable by conventional manufacturing methods.

Short-term thermal cycling showed no significant deterioration of properties, and water-boil tests indicated an encouraging environmental stability, even where steel susceptors were present in the **bondline**.

13.9 References

13.9.1 General

- [13-1] U. Glaser & H. Krings: MAN, G
'Joining of BMI'
ESA SP-303 (June 1990), p127-130
- [13-2] Ciba Geigy
'Users Guide to Adhesives'
Publication No. A17d, June 1982
- [13-3] C.A. Arnold: Westlands Aerospace, UK
'The Potential of Thermoplastic Composites for European Space Projects', Westlands Report for ESTEC, 1988
- [13-4] B. Goffaux & I. Verpoest: Katholieke Univ. Leuven, B
'Thermal Bonding of Thermoplastic Composites'
ESA SP-303 (June 1990), p345-350
- [13-5] D.M. Maguire: FMC Corporation, USA
'Joining Thermoplastic Composites'
SAMPE Journal Vol. 25, No. 1. Jan./Feb. 1989
- [13-6] J.D. Buckley et al: NASA-Langley, USA
'Equipment and Techniques for Rapid Adhesive Bonding of Composites'
Advanced Composites American Society for Metals, 1985
p155-162

13.9.2 ECSS documents

[See: [ECSS](#) website]

ECSS-Q-ST-70	Materials, mechanical parts and processes
ECSS-Q-ST-70-01	Cleanliness and contamination control
ECSS-Q-ST-70-22	Control of limited shelf-life materials
ECSS-Q-70-71	Data for the selection of space materials and processes

14

Quality assurance

14.1 Introduction

14.1.1 Documentation

Joining of materials involves a sequence of operations, all of which need strict control and documentation, as does any consistently repeatable manufacturing process.

Adhesive bonding of materials for expensive, high-reliability, aerospace components and assemblies needs complete procedural documentation. This is mandatory for all stages, from initial procurement, incoming inspection, bonding procedures, testing (coupons, subassemblies and finished items) and inspection. Unless the 'acceptability' of each stage of the sequence can be ensured, the quality of the bond, and consequently the overall integrity of the assembly, cannot be guaranteed or qualified.

Some of the factors to be incorporated into a quality assurance programme for bonded joints are presented, [See: 14.2].

14.1.2 Standards

ECSS provide a series of normative standards for the manufacture of space structures, [See also: [22-8]]. Of these, those that apply to materials, process selection and quality control are covered by the ECSS-Q-series [See: ECSS documents] of standards, [See: [ECSS website](#)].

14.1.3 Aerospace applications

With the increase of bonded aerospace structures, particularly for civilian aircraft, aviation authorities are considering all aspects of adhesive bonding, Ref. [14-2], [14-3], [14-4].

Recent and upcoming space missions have demanded that adhesives survive in harsher environments for longer periods. As a consequence, the performance of adhesives and processes under extreme space environments is of interest, Ref. [14-5].

The outcome of such evaluations provides valuable feed-back for the evolution of quality assurance procedures and documentation for new applications.

14.2 Quality system

14.2.1 General

The role of quality assurance in adhesive bonding is to ensure that:

- materials stipulated in the design are obtained, stored and used correctly; as stated in the procurement specification and confirmed by incoming inspection.
- each joint made meets the materials and process specification(s) and is fully documented,
- test data are accumulated and that the bonded structure is qualified for space use,
- bonded-joint data acquired from testing, inspection or in-service experience are 'fed-back' into manufacturing documentation.

Previously accumulated data can aid the design process for all subsequent, similar, structures.

[See: ECSS documents: ECSS-Q-ST-20; ECSS-Q-ST-70]

14.3 Specifications

14.3.1 Procurement

14.3.1.1 Objective

The aim of a materials procurement specification is ensure that any factors that are known, or suspected, to have a detrimental effect on the as-designed bond performance are identified and values that cannot be exceeded stated. These values then form the basis of material incoming testing and inspection. Materials which do not meet the procurement specification are rejected or subjected to further evaluation to ensure that the characteristics have not degraded to unacceptable levels.

An industry perspective of important factors adhesively bonded structures are described in Ref. [14-2], [14-3], [14-4].

14.3.1.2 Establishing a specification

Given the long and expensive process involved to gain approval for new materials for aerospace applications, material users tend to use adhesive systems that they have accumulated data and experience of for similar applications.

Establishing procurement specifications for new aerospace structural adhesive systems can be a collaborative effort between material suppliers and materials users. This is normally undertaken during the design-development stage.

It is essential that any changes made by the material supplier to a product destined for aerospace applications is notified to the material user; including those resulting by environmental legislation, Ref. [14-2].

14.3.1.3 Feed-back

Feed-back from the incoming inspection and manufacturing processes is used to revise procurement specifications.

14.3.1.4 Paste and liquid adhesives

Procurement specifications for **paste** and liquid adhesives can be based on the parameters applied to resins, with additional factors for any particular adhesive system, e.g. filler materials, [See also: 14.4]

14.3.1.5 Film adhesives

Procurement specifications for **film** adhesives can be based on the parameters applied to the resin phase within prepregs, with additional factors for a particular adhesive system, e.g. specifying the carrier of supported films; rheological characteristics; foaming characteristics of splice-type adhesive systems, [See also: 14.4]

14.3.2 Incoming inspection

Incoming inspection is often conducted on a batch (or lot) basis for materials. The inspection and testing parameters, along with the values that form accept or reject criteria, are stipulated in the procurement specification. Incoming inspection can involve checking the essential chemical and mechanical characteristics of materials using a variety of standardised or in-house procedures, [See also: 14.4]. The results are documented within the quality system and also ensure traceability of materials.

14.3.3 Design

During the design stages, many factors are assessed and decisions made. This ultimately results in a specification for a bonded joint, detailing what is needed and, often, how it is carried out. The limits or design allowables placed on these form the pass or fail criteria of the specification. Such factors can include, for example, the geometrical tolerance on the bond area, the cure schedule to be used or the coupon tests necessary to ensure adequate surface preparation.

An industry perspective of important factors adhesively bonded structures are described in Ref. [14-2], [14-3], [14-4].

14.3.4 Processes

A method or process procedure for carrying out each task is then established to meet the specification. In addition to the process itself, items are identified which need routine monitoring and control, [See also: 14.4]. Experience shows that effort expended in process control and monitoring at each stage of the manufacturing sequence is more cost effective than implementing complex and expensive 'end item' non-destructive testing, Ref. [14-4]. It enables any deviant items to be identified and corrected or replaced prior to finishing the manufacturing.

An industry perspective of important factors adhesively bonded structures are described in Ref. [14-2], [14-3], [14-4].

14.3.5 Materials

14.3.5.1 Limited shelf-life materials

Materials that can degrade or change in properties during extended storage are called limited shelf life, [See: ECSS documents: ECSS-Q-ST-70-22]. The types of bonding-related materials classified as limited shelf life include:

- Adhesives and constituent parts, e.g. base resin, hardener, **catalyst**.
- Solvents and chemicals for cleaning and surface preparation of adherends;
- Mixtures of reagents used for surface preparation of adherends;
- Prepregs used for **co-cured** joints;
- **Primers**;
- Sealants;
- **Potting** compounds.

For such materials, manufacturers and suppliers state a shelf life, under given environmental conditions.

14.3.5.2 Fillers and bulking agents

Although some materials used in bonding processes do not degrade or alter during storage, they are susceptible to contamination, especially by moisture and dust. This applies to fillers and other bulking agents used to modify the viscosity of paste adhesives. Usually the materials themselves are inert and not prone to absorb moisture, e.g. glass or ceramic oxides, but in fine powder forms, they need to be stored in clean, dry conditions or dried before use.

14.3.5.3 Peel plies

Peel plies, used to create new surfaces on composite **adherends**, are usually specified in the same way as reinforcing fibre plies, e.g. fibre type, weave, finish and packaging. They also need to be stored in clean, dry conditions and only handled in a clean working environment. Impregnation of peel plies with release agents can affect bond performance and **durability**, Ref. [14-2].

14.3.5.4 Consumables

Ancillary materials used in bonding processes cannot contaminate the bond. This includes the type of disposable wipes, gloves, tools and containers used for mixing and applying adhesives or holding solvents.

All of the measures taken to ensure that consumables are stored and used in a responsible manner are documented in the quality system.

14.3.5.5 Working environment

The performance and durability of bonded joints can be significantly affected by contamination during processing. Measures to control contamination and cleanliness in the working environment are strictly imposed, [See: ECSS documents: ECSS-Q-ST-70-01].

14.3.5.6 Health and safety

Some materials and processes involved in adhesive bonding are capable of affecting the health of operators. These are cited in manufacturers' material safety sheets.

National regulations are applied regarding the personal protection equipment needed for operators in the working environment.

14.3.6 Training personnel

14.3.6.1 Manufacturing processes

The performance of structural adhesive bonds is strongly linked to the application and strict control of each step of every manufacturing process. Adequate training, along with regular monitoring and documentation, of personnel involved in any bonding-related process is an essential part of the quality assurance system.

Some other aspects to be covered by training include:

- Handling of raw materials, process chemicals and equipment,
- Cleanliness and contamination control of environment, raw and prepared materials and equipment,
- Safety-related aspects of materials and process chemicals.

14.3.6.2 Inspection processes

Personnel involved with the inspection and testing of adhesive bonds need to have the necessary qualifications to a stipulated level within recognised standards, e.g. use of non-destructive testing equipment for defect detection.

14.4 Check lists

14.4.1 Material procurement

14.4.1.1 Liquid and paste adhesive systems

An adhesive system can comprise several different constituents, e.g. base resin, hardener, catalyst, modifiers. Each constituent needs to be identified and labelled clearly with a number of items, including:

- Manufacturer's name,
- Product name,
- Identification number(s),
- Batch number,
- Date of manufacture,
- Release date,
- Packaging requirements,

-
- Storage requirements,
 - Allowable shelf life for under stated storage conditions,
 - Allowable out life for stated working conditions,
 - Mix ratios for constituents (manufacturer recommendations)
 - Contamination, usually expressed as 'contamination free' by suppliers,
 - Material safety datasheet (MSDS),

Table 14.4-1 gives a basic summary of the parameters considered appropriate for batch testing and inclusion in procurement specifications for the constituents of liquid resins and paste adhesive systems; based on ESA-PSS-56 [14-6]. These were derived for epoxy-based liquid resin systems but can be adapted for different base resin materials, e.g. polyimide, bismaleimide, cyanate ester.

A blend is made from a stated proportion of each of the constituents (also known as mix ratio) and is expressed as either a volume ratio or by weight. Complete and proper mixing is essential; as per manufacturers' recommendations. The characteristics of the blend are determined in the uncured and cured state. Cure-related properties, e.g. viscosity, gel time, are measured at stated temperatures and conditions. Each parameter is measured according to appropriate test standards, stated in the procurement specification, [See: [22-8] for a summary of test methods].

Table 14.4-1– Procurement check-list: Paste adhesives – summary
A: Constituent of adhesive system

	Density	Solid content or volatile content	Viscosity or melting ¹	Epoxy content or equivalent ¹	Amine number or anhydride value or nitrogen content	Refractive index (liquids only)
Base resin	●	●●	●●	●●	●	●●
Hardener	●	●	●	●	●	●
Catalyst ²	●	●	●	●		●
Modifier	●		●			●
Solvent	●					●

Key: 1: if applicable; 2: where appropriate

B: Blend

	Gel time, at stated temperature	Viscosity versus temperature ⁴	Viscosity versus time, at stated temperature ⁴	Density	Glass transition temperature (Tg)
Uncured ³	●●	●●	●	○	●
Cured			●	○	●

 Key: 3: prior to release for use in production;
 4: viscosity - time-related or temperature-related, not both;
 ○: Can be useful for filled adhesive systems

14.4.1.2 Film adhesives

A film adhesive is essentially a thin layer of a partly-cured blend. The cure chemistry is arrested at a predefined point as part of the adhesive manufacturing sequence by transfer and storage in cold conditions. The stipulated storage conditions are also used when transporting materials, between manufacturer and purchaser, to ensure that the cure state remains stable.

All **film** adhesive products need to be identified and labelled clearly with a number of items, including:

- Manufacturer's name,
- Product name
- Product type, e.g. base resin type,
- Identification number(s),

- Batch number,
- Date of manufacture,
- Release date,
- Mass per unit area,
- Film thickness,
- Volatile content and type,
- Supported or unsupported, with full description of carrier (scrim) material, including: material, type, batch number.
- Backing sheet description, e.g. material type, colour,
- Reeled materials: width and length.
- Sheet materials: dimensions of sheet and number of sheets
- Packaging requirements,
- Storage requirements,
- Allowable shelf life under stated cold storage conditions,
- Allowable 'warm-up' period necessary between removal from cold storage and production use under working conditions,
- Allowable out life under stated working environment conditions,
- Contamination, applies to adhesive film, carrier scrim (if present) and backing sheets; usually expressed as 'contamination free' by suppliers,
- Material safety datasheet (MSDS),

Table 14.4-2 gives a basic summary of the parameters considered appropriate for batch testing and inclusion in procurement specifications for film adhesive systems.

Table 14.4-2 – Procurement check-list: Film adhesives – summary

	Visual inspection for defects ²	Identify adhesive system ³	Volatile content	Gel time, at stated temperature	Tack	Mass per unit area	Glass transition temperature (T _g)
Uncured ¹	●	●	●	●	●	●	●
Cured	●	●	●	●	●	●	●
Key: 1: prior to release for use in production; 2: Defects, including splits and severe creases in the backing sheets; 'dry' areas for supported materials; variations in thickness; colour; 3: sample of adhesive used for a chemical analysis 'finger-print' check.							

14.4.1.3 Batch testing of adhesive systems

The type of tests stipulated aim to ensure the material meets those stipulated in the procurement specification. They tend to monitor those properties that are known to be detrimental to bond performance, e.g.

- material chemistry-related, using analytical techniques, such as:
 - HPLC – high pressure liquid chromatography, which determines the chemical constituents of resins and enables a chemical finger-print for comparison between batches.
 - Infrared spectroscopy, which is an alternative for HPLC.
 - DSC – differential scanning calorimetry, which enables the cure characteristics to be assessed, e.g. reaction start temperature, heat of polymerisation, peak temperature (polymerisation), glass transition temperature.
 - DMA – dynamic mechanical analysis, which can be used on uncured and cured materials to measure the mechanical properties over a range of temperatures, e.g. modulus and glass transition temperature.
- process-related, e.g. a simple, standard mechanical test is performed, e.g. lap shear, peel test, and the failure mode checked.

If stated in the procurement specification, the material manufacturer undertakes the batch testing and the results are included in the product release documentation.

Whilst some batch tests are only applied once to particular batch, other tests are applied to samples taken from the start and end of a production run. For large batches, sampling is also done at predefined points within it. Batch testing can be done by the material end user.

Each parameter is measured according to the test standard stated in the procurement specification, [See: [22-8] for a summary of test methods].

14.4.1.4 Incoming inspection of adhesive systems

Incoming inspection can include ‘full’ batch testing, if not undertaken by the material manufacturer, or a repeat of one or more tests to verify the material is ‘as-specified’ and that no degradation has occurred to the material, e.g. poor storage during transporting.

Each parameter is measured according to the test standard stated in the procurement specification, [See: [22-8] for a summary of test methods].

The results of incoming inspection are used for ‘trend analysis’ of frequently-used materials to monitor any changes associated with product evolution or improvements by manufacturers’.

14.4.2 Bonded joints

14.4.2.1 General

Table 14.4-3 gives a check list of those factors to be considered during the entire design, manufacture and inspection sequence for producing bonded joints. It identifies individual process steps in which a variation within pre-set parameters can result in the production of a defective bond. These need close monitoring and control.

The testing and evaluation conducted is far more extensive than that stated in the procurement specification.

Table 14.4-3 – Check list: Adhesive bonding

Adherends <i>Which materials are to be joined?</i>	Composite-to-Composite - is co-cure possible? What is the composite? <i>Fibre and resin combination. Lay up and no. of plies. Orientation of surface plies. Mechanical properties.</i>
	Composite-to-Metal <i>CTE</i> of each adherend. <i>Mechanical properties.</i> Is <i>corrosion</i> a problem?
Adhesives <i>Which adhesives are applicable?</i> [See: ECSS documents: ECSS-Q-ST-70]	Are adhesive properties defined? <i>Outgassing, mechanical, CTE, service range, flammability, toxicity. Offgassing</i> for manned structures.
	What does the adhesive system need? <i>Storage, cure (temperature, time, pressure), bonding, out life (film), pot life (paste).</i>
	What is the development status? Commercial product widely available, special product, cost, <i>lot reproducibility.</i>
	What <i>test data</i> are available? e.g. <i>mechanical, chemical, thermal, environmental (durability).</i>
	<i>Product assurance</i> - known use in space applications? <i>Testing</i> to known <i>standards</i>
Joint design	What is wanted of the component and the joint within it? Mechanical loading, thermal loads, thermal cycling, vibration, fatigue, service temperature(s), service environment, intended life, dimensional stability.
	Is a full range of <i>data</i> available?
	What features are required? Dimensional stability, smooth surfaces, geometry of adherends and component, size limitations (<i>manufacturing</i>).
	What joint <i>analysis</i> is needed? <i>How</i> is it to be achieved?
Manufacturing [See: ECSS documents: ECSS-Q-ST-70]	What <i>surface preparation</i> is required? Abrasion, etch, anodise.
	Use of a <i>primer</i> ?
	<i>Monitor and control: etching, anodise bath constituents, temperature, voltage, wash, storage and handling.</i>
	Factory environment: <i>Monitor and control - temperature, moisture and contaminants.</i>
	What <i>equipment</i> is required?
	<i>Metering, mixing and application.</i>
	<i>Tooling</i> (jigs and fixtures).
	Autoclave and cure oven - <i>temperature, pressure, time.</i>
	<i>Total removal of release sheets (film adhesives).</i>
	Control of <i>release agents</i> on tooling.
<i>Bondline</i> control.	
Testing	Adhesive property confirmation - <i>test specifications.</i>
	<i>Sub-assembly testing.</i>
	Preflight test: vibration, simulation of flight and deployment.
Inspection	What defects are likely?
	What <i>inspection equipment</i> is needed and available to find defects? <i>Calibration</i> of equipment; <i>training</i> of personnel
	<i>Effect of defects</i> on desired performance? Critical defects (size and position)– reject or repair criteria.
Parameters that need monitoring and control are shown in <i>red italic.</i>	

14.5 References

14.5.1 General

- [14-1] L.J. Hart-Smith: McDonnell Douglas Aerospace, USA
'How to get the Best Value for each Dollar spent Inspecting Composite and Bonded Aircraft Structures'
Proceedings of 38th International SAMPE Symposium
10-13 May 1993, p226-238
- [14-2] DOT/FAA/AR-05/13: 'Assessment of Industry Practices for Aircraft Bonded Joints and Structures'
Office of Aviation Research, Washington DC, Final report, July 2005
Download (PDF format) from Federal Aviation Administration William J. Hughes Technical Center Technical Reports page:
actlibrary.tc.faa.gov
- [14-3] NIAR/FAA (USA): Bonded Structures Workshop, Seattle, WA, 16th - 18th June, 2004.
Download from: www.niar.witicha.edu/faa
- [14-4] FAA/CAA (Europe): Adhesive Bonding Workshop, CAA – Civil Aviation Authority, Gatwick (UK), 26th – 27th October, 2004.
Download from: www.niar.witicha.edu/faa
- [14-5] J. R. Williamson et al: ESA-ESTEC TEC-QMC, NL
'An overview of recent adhesive bonding programmes conducted within ESA's materials physics and chemistry section (TEC-QMC) '
Paper 128: European Conference on Spacecraft Structures, Materials & Mechanical Testing 2005, Noordwijk, The Netherlands, 10 – 12 May 2005. Proceedings ESA SP-581 (August 2005) on CDROM
- [14-6] ESA-PSS-56 ESA-PSS-56

14.5.2 ECSS documents

[See: [ECSS](http://www.ecss.eu.org) website]

15

Test methods

15.1 Introduction

15.1.1 Use of test methods

15.1.1.1 Adhesive selection

Several methods exist for characterising adhesives. These provide mechanical property data for an adhesive, including ASTM standard test methods, to aid adhesive selection.

Test methods that are widely-used to evaluate adhesives are described, with respect to those biased towards aerospace industry, [See also: [22-8]].

15.1.1.2 Joint design

Several methods exist for characterising bonded joints. In general, these make use of fracture mechanics to determine the quality of adhesive-bonded assemblies to aid the joint design process.

Test methods that are widely-used to evaluate structural bonded joints are described, [See also: [22-8]].

15.1.2 Adhesives for space use

15.1.2.1 Basic characteristics

Some basic demands made of adhesives include, Ref. [15-1]:

- high T_g glass-transition temperature;
- high HD heat-distortion temperature;
- relatively low cure temperature;
- low **outgassing** characteristics;
- low **offgassing**, for manned environments;
- capability of bonding dissimilar materials;
- ductility to withstand mismatched CTE coefficients of thermal expansion of dissimilar adherends.

Ideally an adhesive is cured at the mid point of its expected thermal excursions.

15.1.2.2 Product data

Although adhesive manufacturers and suppliers provide some property data on their products, it is rare that they have a complete data set for design purposes without further evaluation programmes by the user. This particularly applies to outgassing characteristics or other demands specific to the space environment.

[See also: 6 for characteristics and properties of adhesives]

15.1.2.3 Adhesive screening tests

US federal specification MMM-A-132 describes a series of properties for bonded metal-to-metal airframe structures, i.e. skin-to-skin, or skin-to-spars and stringer; as measured using various standard test methods. The objective is to classify adhesives into a 'Class' and 'Type'.

MIL-A-25463, another US federal specification, sets out a similar series of demands for adhesive bonds in metal skin-to-metal **honeycomb sandwich** panels. Table 15.1-1 lists some of the tests used within each US federal specification.

American sources of adhesives tend to cite federal specification or ASTM standards when an adhesive conforms to a particular standard, whereas European sources of adhesives tend to cite ASTM, ISO or national standards.

[See also: 7.6 for a method of screening large numbers of adhesives for space use]

Table 15.1-1 - Adhesive screening: Example of US federal specifications

MMM-A-132, Type 1, Class 3	Average
Tensile shear:	
-55°C (± 3°C)	17.24 MPa
24°C (± 3°C)	17.24 MPa
82°C (± 3°C)	8.62 MPa
30 days salt-spray 24°C (± 3°C)	15.52
30 days at 50°C (± 3°C), 95%-100%RH	15.52
7 days immersion in various aviation type fluids	15.52
Fatigue strength:	
24°C (± 3°C)	4.14 MPa at 10 ⁷
Creep rupture:	
24°C (± 3°C); 11.04 MPa, 192 hours	0.38 mm max.
180°C (± 3°C); 5.52 MPa, 192 hours	0.38 mm max.
MIL-A-25463, Type 1, Class 2	Average
Sandwich peel strength:	
-55°C (± 1°C)	8.90 MPa
24°C (± 3°C)	15.57 MPa
82°C (± 1°C)	22.24 MPa
Flatwise tensile strength:	
-55°C (± 1°C)	2.41 MPa
24°C (± 3°C)	3.11 MPa
82°C (± 3°C)	1.86 MPa
150°C (± 3°C)	2.41 MPa
Flexural strength:	
-55°C (± 1°C)	7785 N
24°C (± 3°C)	7785 N
82°C (± 3°C)	5358 N
150°C (± 3°C)	6673 N
192 hours exposure 150°C (± 3°C)	5338 N
30 days exposure to 90%-100%RH & 50°C (± 1°C)	6673 N
30 days exposure to salt-spray	6673 N
30 days exposure to a hydrocarbon fuel	6673 N
Creep deflection (flexure for max. 192 hours load):	
24°C (± 3°C); 4448N load	0.635 mm max.
82°C (± 3°C); 3559N load	1.274 mm max.
150°C (± 3°C); 4448N load	1.274 mm max.

15.1.3 Characterisation of adhesives

15.1.3.1 Features of adhesives

Adhesives can be grouped as ductile or brittle. Their stress-strain response is non linear. They are usually viewed as having elastic-plastic characteristics, [See also: 10.2].

15.1.3.2 Adhesive characterisation

To characterise individual adhesives, there are various test methods which assess fracture characteristics relevant to joint design. The properties of adhesives affect the static joint strengths and durability in fatigue. The fracture toughness of adhesives is important for long-life structures. This led to the development of specific test methods for aircraft constructions.

15.1.4 Assessment of adhesive bonding process

15.1.4.1 Strength of bonded joints

Fracture mechanics concepts characterise the strength of adhesively bonded joints in terms of a critical value of an appropriate fracture parameter. Crack face displacements distinguish between three modes of fracture:

- tensile opening (Mode I);
- in-plane shear (Mode II);
- anti-plane shear (Mode III).

Where linear-elastic fracture mechanics is applied, a number of fracture parameters in the form of stress intensity factors (K_I , K_{II} and K_{III}) and energy release rates (G_I , G_{II} and G_{III}) are most commonly used.

When the extent of inelastic deformation near the crack front is relatively large, crack tip opening displacements, crack opening angles and the J-integral (where deformation plasticity holds) are used as fracture parameters, Ref. [15-2].

15.1.4.2 Average stress criterion test methods

For adhesive tests using average stress criterion, there is an assumption that failure is controlled by the magnitude of the stress. Hence, tests are devised to measure the stress (generally an average) at which failure occurs. Most recognised standard tests, e.g. ASTM, are in the average stress criterion group.

15.1.4.3 Fracture mechanics test methods

Adhesive tests using concepts of fracture mechanics evaluate the quality of adhesives and to design bonded joints. These put emphasis on the presence of stress raisers in initiating failure, Ref. [15-3].

15.1.4.4 Objectives of test

The test methods aim to determine:

- modulus;
- strength;
- fracture properties;
- durability under:
 - tension,

- shear,
- cleavage,
- peel.

No single test method provides the ideal conditions for characterising adhesives. At a practical level, the performance of an adhesive is influenced by the adherends and the limited volume of adhesive.

15.1.5 Test methods and standards

Some of the commonly applied test methods are summarised, by specimen type, in Table 15.1-2, Ref. [15-17].

Test methods are often known by the name of the type of specimen used, rather than by their actual application.

Table 15.1-2 – Test methods and standards: Summary

Test	Properties	Fatigue, [See: 15.7]	Creep, [See: 15.8]	Environmental, [See: 15.9]	Standards [See also: [22-8]]
Tensile, [See: 15.2]					
Tensile butt joint	Tensile strength and modulus	(x)	✓	✓	ASTM D897 ASTM D2095 EN 26922
Peel, [See: 15.6]					
T-peel	Peel strength	x	(?)	✓	ISO 8510 (pt2) ISO 11339 ASTM D 1876
Climbing drum	Peel strength, skin stiffness	x	x	x	ASTM D 3167 BS 5350 (ptC13)
Floating roller	Peel strength	x	x	x	ASTM D 3167 DD ENV 1967:1996
Cleavage, [See: 15.4] and Mode I fracture toughness					
Wedge (cleavage), [See: 15.5]	Fracture energy	x	(?)	✓	ASTM D 3762
Compact tension	Cleavage strength	✓	✓	✓	ASTM D 1062 BS 5350 (pt C1)
DCB double cantilever beam, [See: 15.4]	Mode I fracture toughness	✓	x	✓	ASTM D 3433
CDCB contoured DCB +	Mode I fracture toughness	✓	x	✓	ASTM D 3433
Shear, [See: 15.3]					
Single-lap	Shear strength	(x)	✓	✓	ASTM D 1002 ASTM D 3166 EN 1465 BS 5350 (ptC5)

Test	Properties	Fatigue, [See: 15.7]	Creep, [See: 15.8]	Environmental, [See: 15.9]	Standards [See also: [22-8]]
Double-lap	Shear strength	✓	(?)	✓	ASTM D 1002 ASTM D 3166 EN ISO 9664 BS 5350 (ptC5)
V-notched beam	Shear strength and modulus	✗	✗	✓	ASTM D 5379 (composites); no adhesive standard
Arcan	Shear strength and modulus	✓	✗	✓	No standard
Shear, [See: 15.3] and Mode II fracture toughness					
Thick adherend, [See: 15.3]	Shear strength and modulus	✗	(?)	✓	ASTM D 3165 ISO 11003
Torsion butt	Shear strength and modulus	✓	✓	✓	No standard
Napkin ring, [See: 15.3]	Shear strength	✓	✗	✓	ASTM E 229
ENF end notch flexure	Mode II fracture energies	✓	✗	✓	No standard
Key: ✓ suitable (✗) limited † Contoured DCB also known as Tapered DCB (?) possible ✗ unsuitable					

15.2 Tensile tests for adhesives

15.2.1 General

Tensile tests can be grouped as those used for:

- Adhesive evaluation, Ref. [[15-4], [15-7]], e.g. ASTM D-897;
- Sandwich panels: Flatwise tensile strength, metal-to-**honeycomb** core bonds to determine flatwise tensile strength, e.g. ASTM C-297 and EN 2243-04.

15.2.2 Adhesive evaluation

Testing by direct tensile loading, as shown in Figure 15.2-1, is simple to undertake, but has the fundamental weakness that tensile loading is inappropriate for structural bonded joints and so is not used by designers.

Such test methods are used by adhesive suppliers to provide comparative properties on different adhesives. Their significance has reduced as more relevant test methods have been introduced.

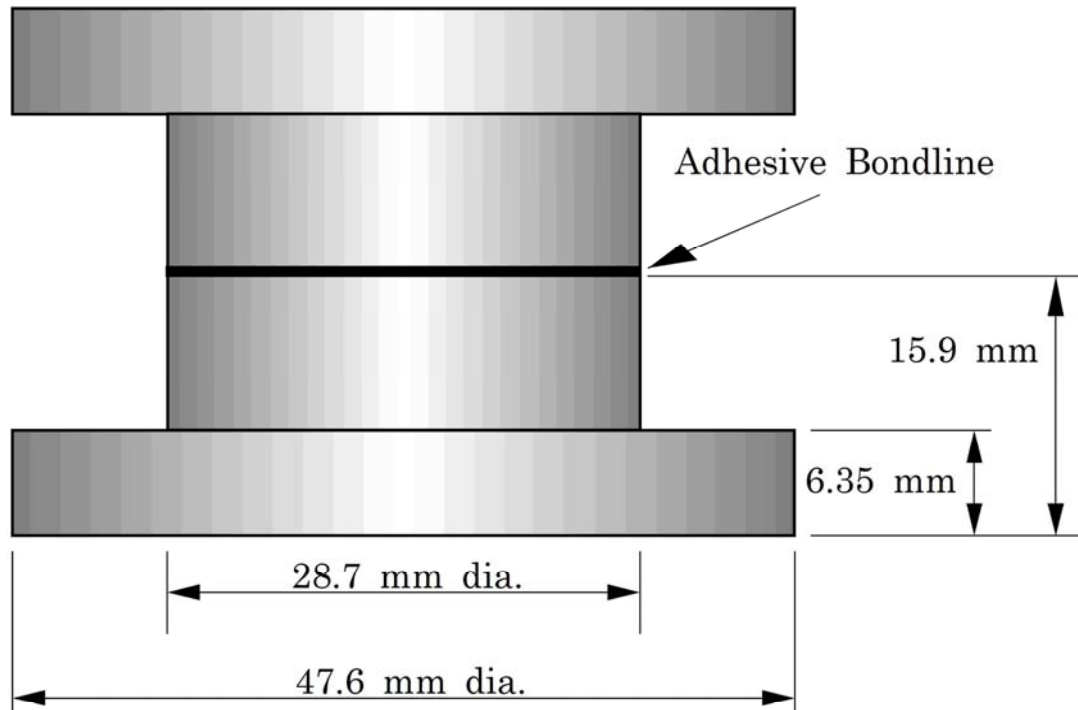

Figure 15.2-1 - ASTM D-897: Metal test specimen

15.2.3 Sandwich panels: Flatwise tensile strength

FWT flatwise tensile strength is often quoted in manufacturers' literature and is also mentioned in MIL specifications for screening adhesives used for sandwich bonding, [See also: Table 15.1-1].

ASTM C-297-61 (1988) and UK specification BS 5350 pt.6 are FWT tests.

15.3 Shear tests for adhesives

15.3.1 General

The transfer of load between **adherends** is best achieved by as pure a state of shear stress as possible.

Shear tests are very common because specimens are simple to manufacture and test. The methods favoured for producing shear modulus and shear strength data for adhesives are:

- Napkin ring specimens, Ref. [15-6];
- Thick adherend single lap specimens, Ref. [15-7].

15.3.2 Napkin ring

The test produces very uniform stresses in the adhesive layer. ASTM D-0229, previously ASTM E-229, involves the torsional loading of two metallic rings bonded together, as shown in Figure 15.3-1.

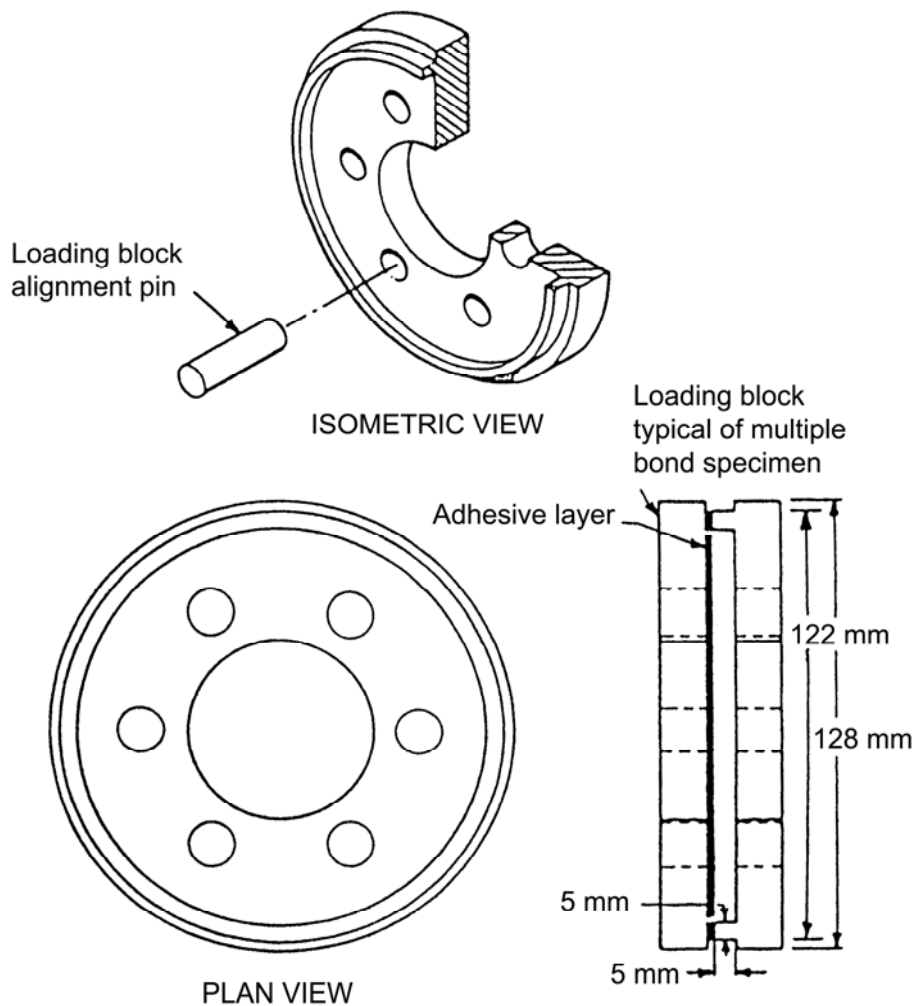

Figure 15.3-1 - ASTM D-0229: Napkin ring shear test

15.3.3 Thick adherend single lap

Thick **adherends** reduce, but do not entirely eliminate, **peel stresses**. This method has been partially adopted in ASTM D-3165. A true thick adherend tensile lap specimen is given in ASTM D-3983, which uses steel adherends 20 mm thick. Although the standard refers to non-rigid adhesives, with low shear modulus, the principle remains sound.

15.3.4 Single lap

15.3.4.1 Metal adherends

The most popular and widely used test standards are:

- ASTM D-1002, which specifies a test for metal-to-metal bonds; as shown in Figure 15.3-2. Standards D-2295 and D-2557 are procedures for using D-1002 at elevated or low temperatures.
- ASTM D-3165 for properties of adhesives in laminated metal assemblies; as shown in Figure 15.3-3. EN 2243-01 is also a single-lap test method for structural adhesives.

These tests are the origins of most lap- or tensile shear strengths reported in adhesive manufacturers' literature or within experimental studies on developing bonding techniques.

Stress concentrations, especially edge effects, and associated limitations on interpreting and extrapolating data have been widely studied and clearly recognised, Ref. [15-8], [15-9]. It is a simple test configuration for process control checks, but cannot be used to generate design data, Ref. [15-9].

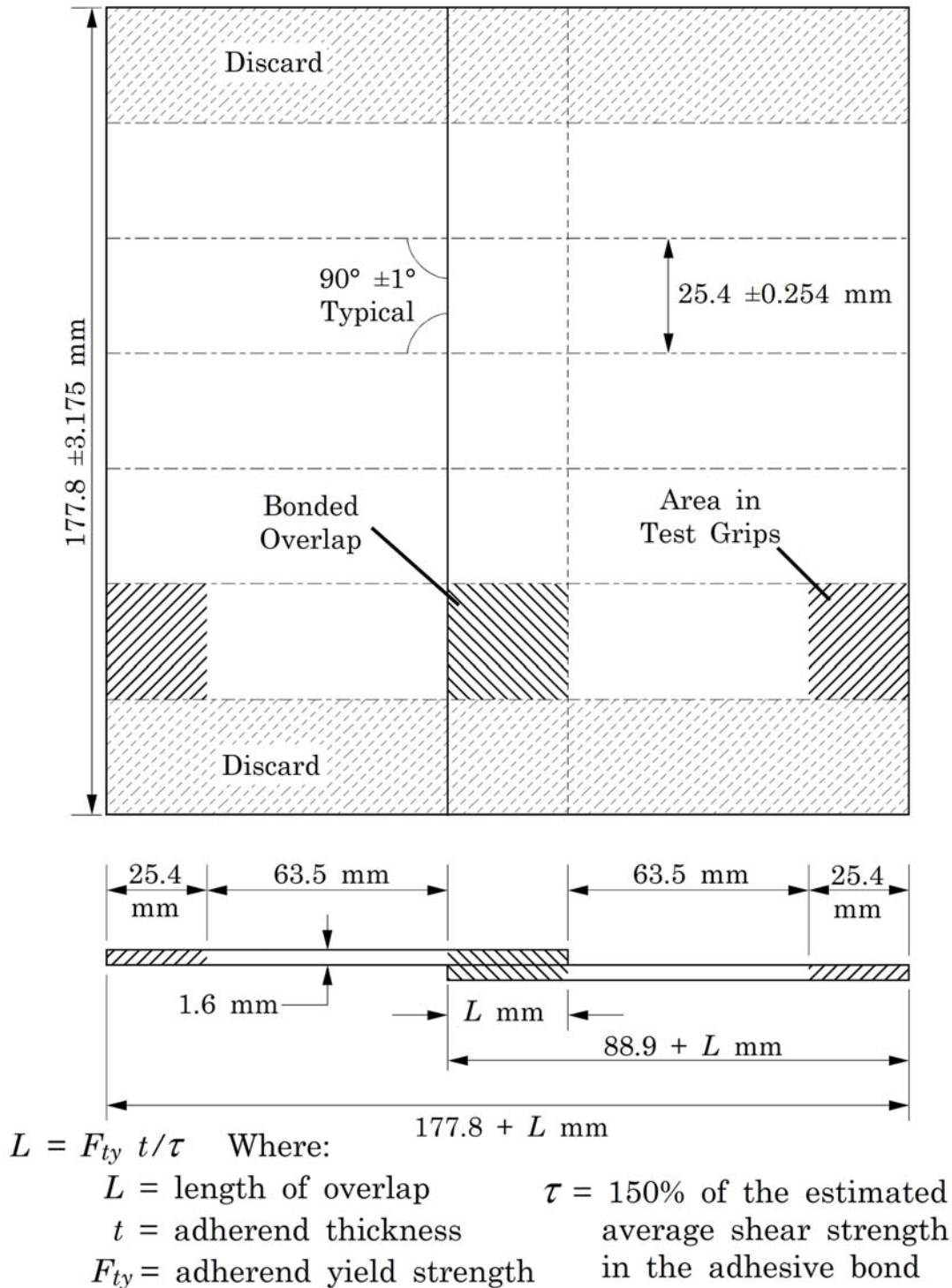
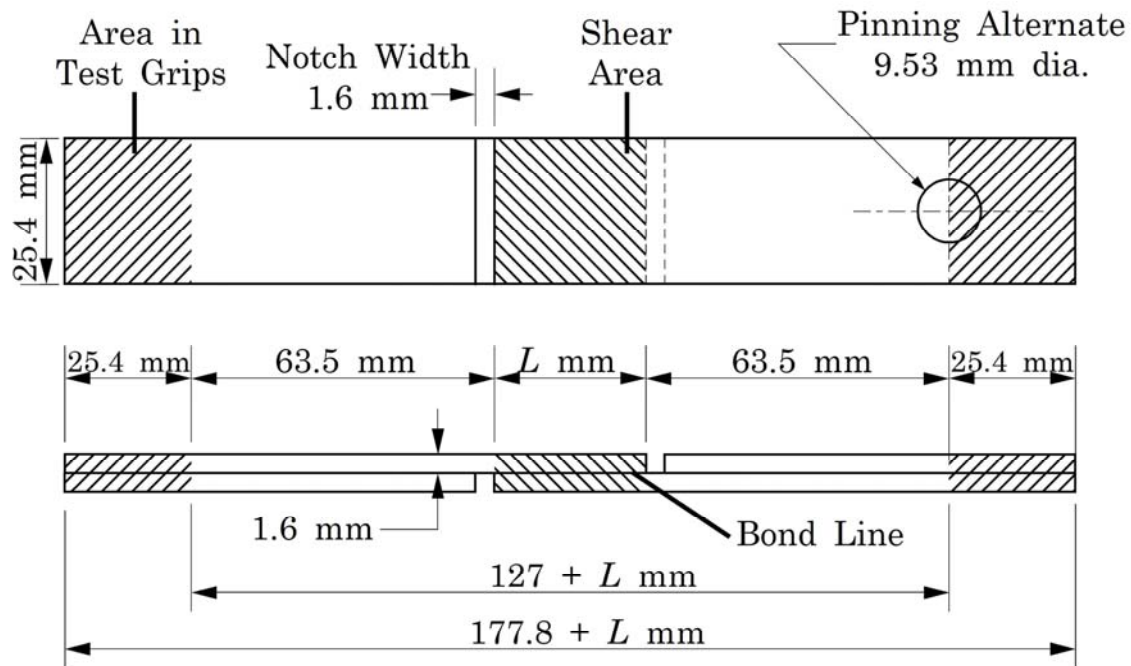

Figure 15.3-2 - ASTM D-1002: Single lap test specimen



$$L = F_{ty} t / \tau$$

Where: L = length of overlap
 t = adherend thickness
 F_{ty} = adherend yield strength
 τ = 150% of the estimated average shear strength in the adhesive bond

Figure 15.3-3 - ASTM D-3165: Single lap test specimen

15.3.4.2 Composite adherends

The test methods are also used to assess adhesively-bonded composite **adherends** rather than metals. The precautions applied to metals also apply to composites

Specimen geometries, other than those quoted by ASTM standards, can be used if data is needed on specific adherend materials, construction and thicknesses.

15.3.4.3 Rigid plastic adherends

ASTM D-3163 and ASTM D-3164 are similar to D-1002 in using the simple single overlap joint for rigid plastic adherends.

15.3.5 Double lap

ASTM D-3528 considers double lap shear joints in tension; as shown in Figure 15.3-4. The double lap alleviates some of the distortion and cleavage stresses that occur in single lap specimens. For making comparisons, testing both bondlines at the same time can complicate the interpretation, Ref. [15-8].

Type A Specimen

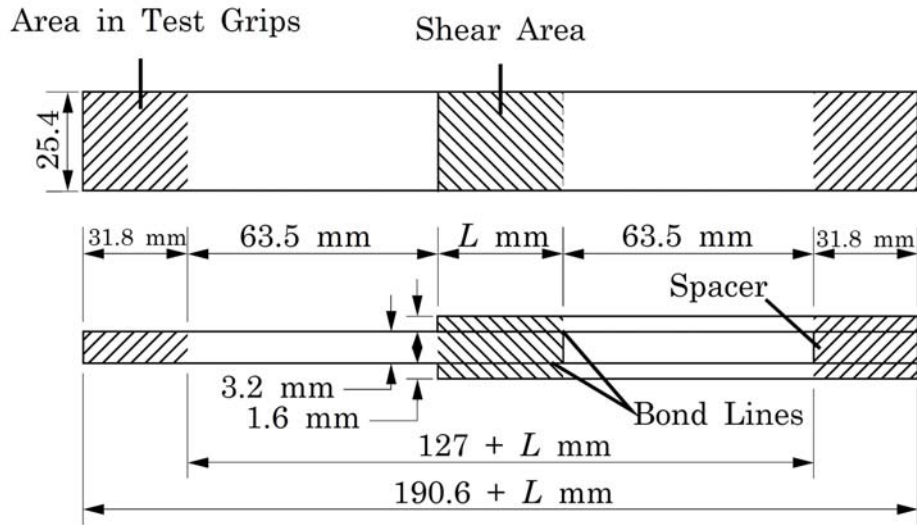

Type B Specimen

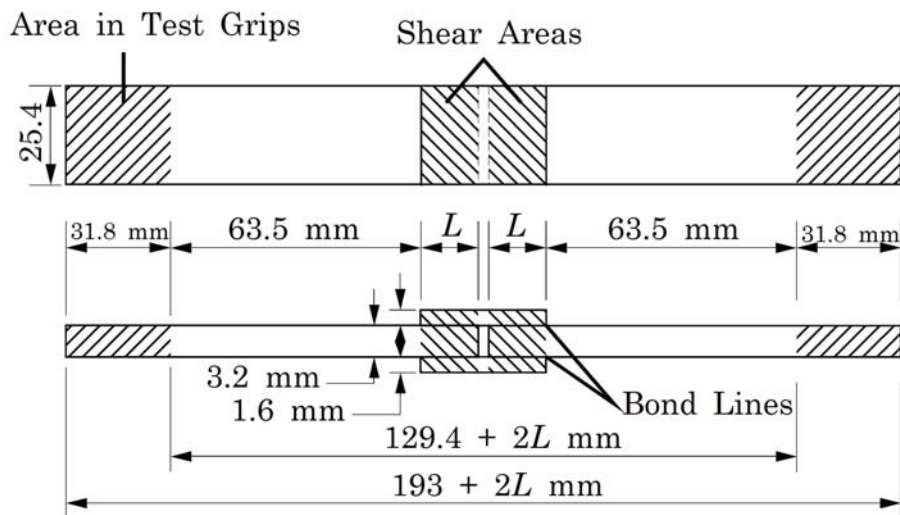

Figure 15.3-4 - ASTM D-3528: Double lap test specimen

15.3.6 Cracked lap shear (CLS)

CLS gives a mix of Mode I and Mode II loadings, Ref. [15-4], [15-10]. A schematic outline of the specimen is shown in Figure 15.3-5, which represents a simple structural joint subjected to in-plane loading. Features of this test method, which is not covered by an ASTM standard, include:

- The magnitude of each shear and peel stress component can be modified by changing the relative thicknesses of strap and lap adherends.
- The **adherends** can be composites.
- It is usual to fatigue load the specimen to create the initial sharp debond (a), [See: Figure 15.3-5].
- From the propagation of the debond under static loads, the total critical strain energy release rate G_{TC} can be obtained.
- The cyclic debonding behaviour is dependent on G_I , G_{II} and G_{III} .
- The potential applications of the specimen configuration are outlined, Ref. [15-10], where a joint can have an infinite life with a no-growth threshold, G_{th} . This can occur when G_I is less than G_{th} .

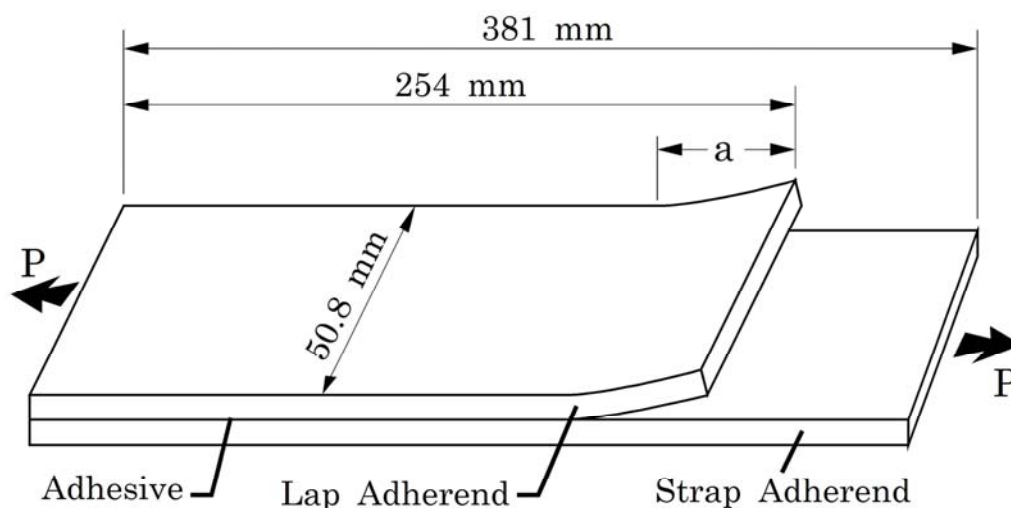

Figure 15.3-5 - Cracked lap shear (CLS) test specimen

15.4 Cleavage of adhesives

15.4.1 General

Cleavage is a pure Mode I form of loading at the debond tip of an adhesive bond. This can be achieved with the aid of a DCB double cantilever beam specimen, providing a means of determining G_{ic} , Ref. [15-11]. This test was used to measure the bondline resin toughness of bonded composites, Ref. [15-12].

ASTM D-3433 provides a method intended for use in metal-to-metal applications; but it can also be used for composite adherends. Best results can be expected when unidirectional composite adherends are used in order to avoid the crack damage growing into the adherends.

15.4.2 Specimen geometry

15.4.2.1 Flat adherend specimen

A flat adherend specimen is shown in Figure 15.4-1.

15.4.2.2 CDCB contoured double-cantilever beam specimen

Figure 15.4-2 shows a contoured double cantilever beam specimen.

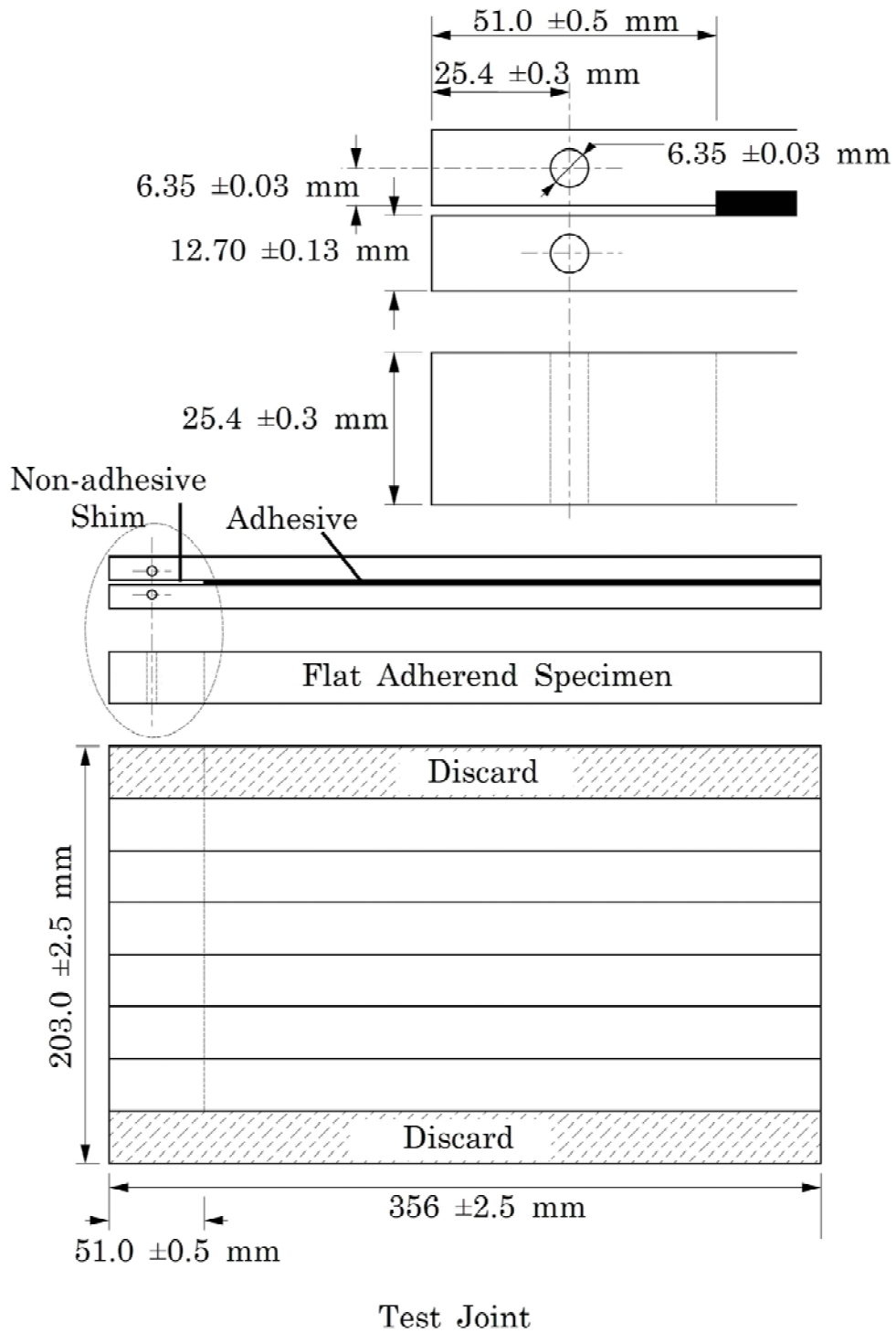

Figure 15.4-1 - ASTM D-3433: Cleavage - flat adherend specimen

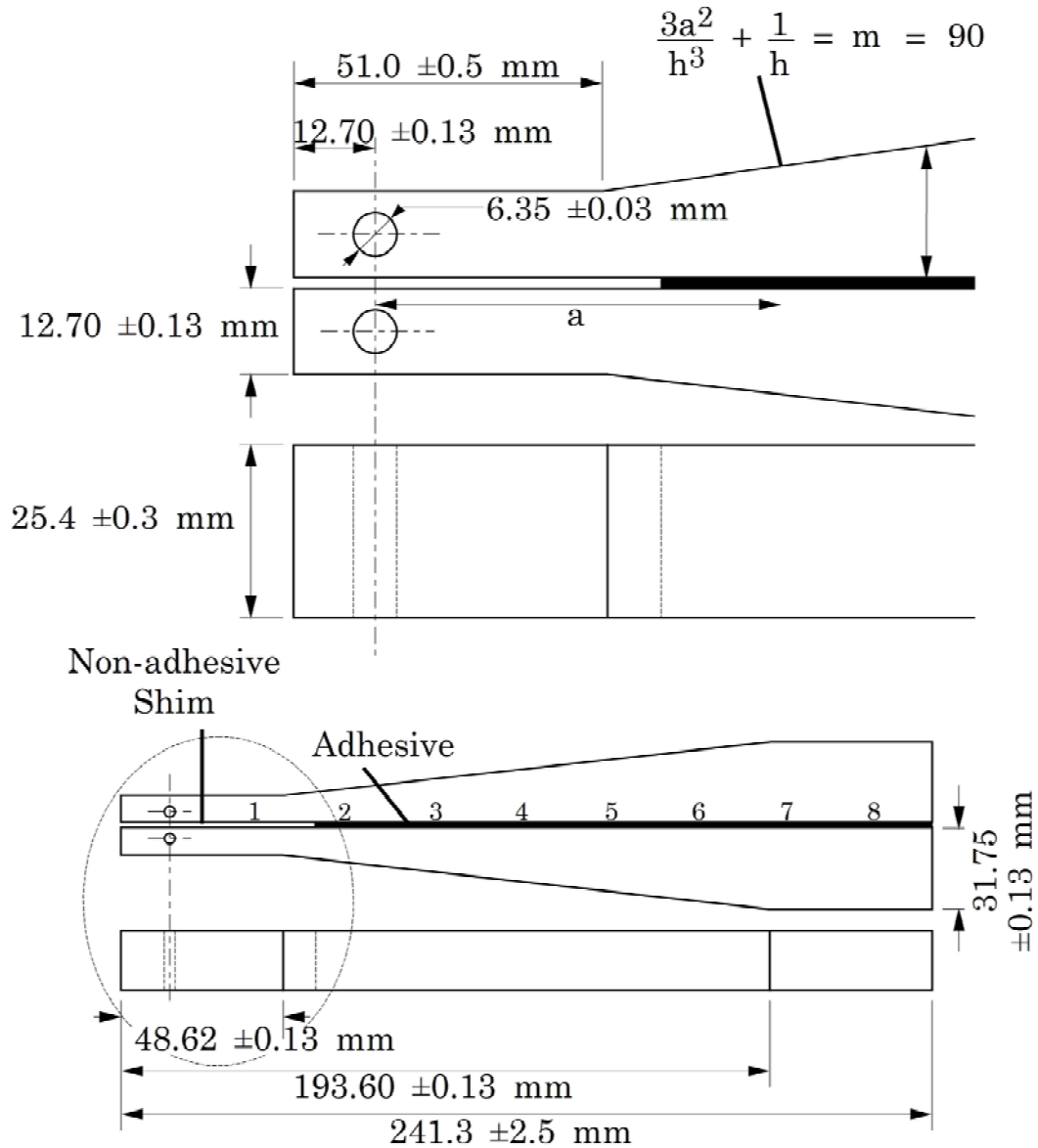

Figure 15.4-2 - ASTM D-3433: Cleavage – CDCB contoured double cantilever beam specimen

15.4.3 Typical test results

15.4.3.1 Flat adherend specimen

A typical load versus time chart is shown in Figure 15.4-3.

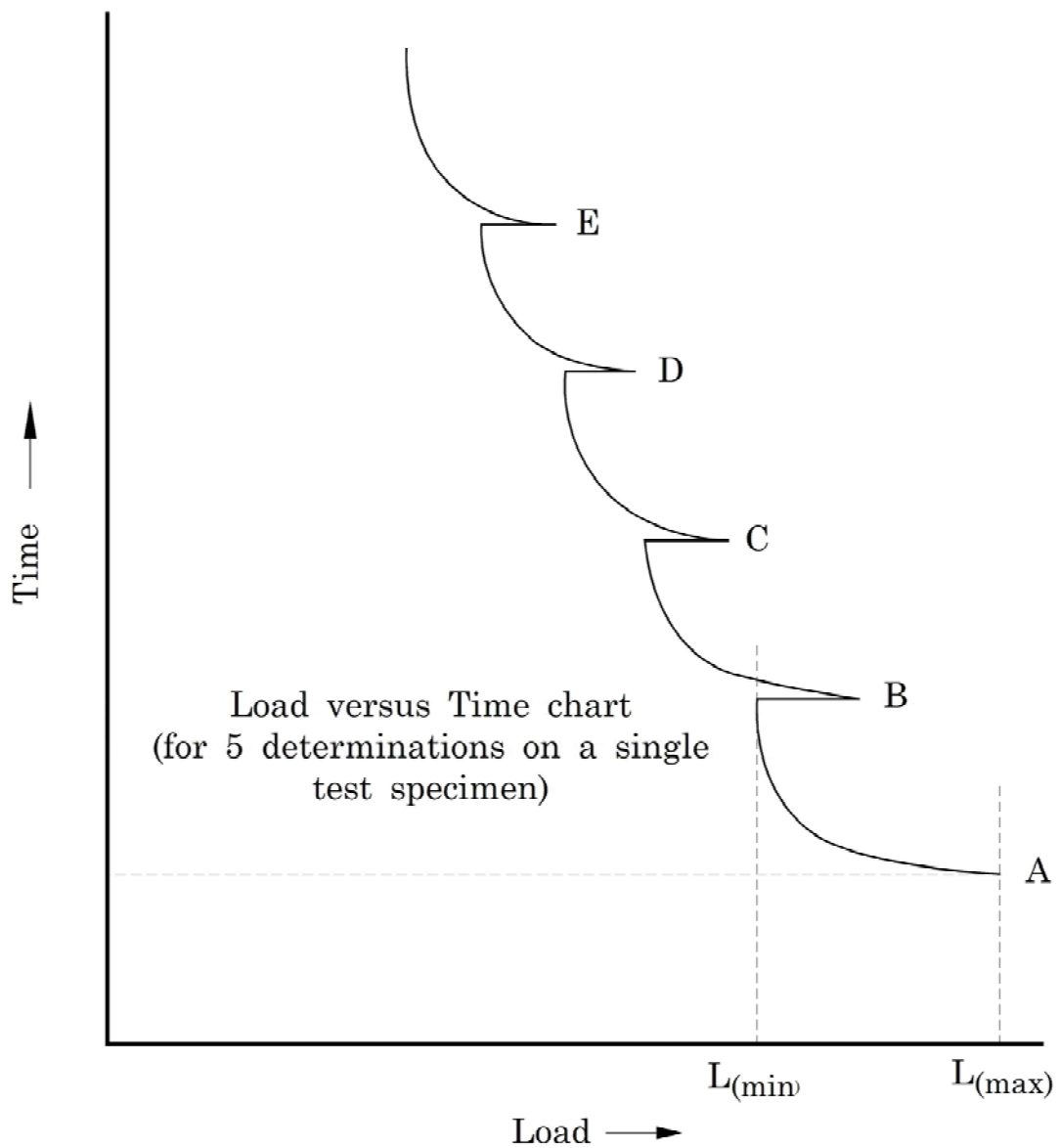

Figure 15.4-3 - ASTM D-3433: Flat adherend test result chart

15.4.3.2 CDCB contoured double-cantilever beam specimen

Figure 15.4-4 shows a typical load versus crack length chart.

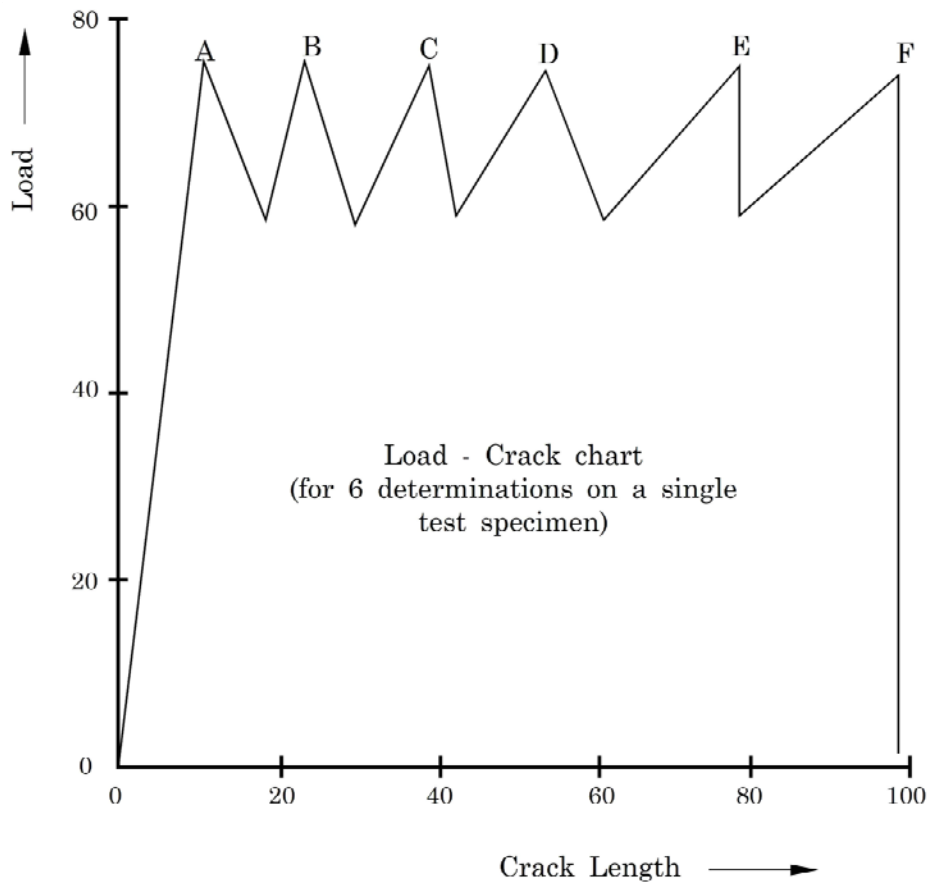

Figure 15.4-4 - ASTM D-3433: Contoured double cantilever beam test result chart

15.4.4 Calculation of fracture strength

15.4.4.1 General

G_{1a} and G_{1c} can be calculated where the:

- opening mode crack arrest toughness, G_{1a} - is the value of G just after arrest of a run-arrest segment of crack extension.
- opening mode fracture toughness, G_{1c} - is the value of G (crack-extension force) just prior to onset of rapid fracture, when G is increasing with time.

When the shear stress on the plane of the crack and forward of its loading edge is zero, the stress state is termed 'opening mode'. The symbol for an opening-mode G is:

- G_I for plane-strain;
- G_1 when the connotation of plane-strain is not wanted.

The validity of G_{1c} and G_{1a} values depends upon establishing a sharp-crack condition in the **bondline**.

The fracture strength of the specimen is influenced by:

- **adherend** surface condition;
- adhesive;
- adhesive-adherend interactions;
- **primers**;
- adhesive-supporting scrim;
- where the crack grows, i.e. in the adhesive or at adhesive-to-adherend interfaces.

A G_{1c} value represents a lower limiting value of fracture toughness for a given temperature, strain rate and adhesive condition as defined by manufacturing variables. This value can be used to estimate the relation between failure stress and defect size.

15.4.4.2 Flat adherend specimen

The fracture toughness is represented by the expression:

$$G_{1c} = \frac{[4L_{(max)}^2][3a^2 + h^2]}{[EB^2 h^2]}$$

For G_{1a} , $L_{(min)}$ replaces $L_{(max)}$ in all tests.

15.4.4.3 CDCB contoured double-cantilever beam

The fracture toughness is represented by the expression:

$$G_{1c} = \frac{[4L_{(max)}^2](m)}{[EB^2]}$$

where: $m = \frac{3a^2}{h^3} + \frac{1}{h}$

$L_{(max)}$ = load to start crack, (N).

$L_{(min)}$ = load at which crack stops growing, (N).

E	= tensile modulus of adherend, (MPa).
B	= specimen width, (mm).
a	= crack length, (mm).
h	= thickness (mm) of adherend normal to plane of bond.

15.4.5 Loading

15.4.5.1 Static

Static can be used with flat adherend and CDCB specimens.

15.4.5.2 Fatigue

Fatigue loading can be used with flat adherend and CDCB specimens.

A load ratio of 0.1 (minimum to maximum) is appropriate. The measured relationship between the debond length and fatigue cycle provides the debond growth rate, da/dN , which in turn can be related to strain energy release rate, G_I .

15.5 Bond durability by wedge test

15.5.1 General

The wedge test was developed by Boeing Airplane Company. It is widely used to determine and predict the environmental durability of adherend surface preparation, Ref. [15-13]. It is also used successfully to assess **bondline durability** with composite **adherends**, Ref. [15-12].

[See also: 20.2 for wedge test use with bonded repairs]

15.5.2 Test specimen and configuration

15.5.2.1 Adherends

ASTM D-3762 refers to adhesion on aluminium alloys, but the test is applicable for other adherends, i.e.:

- metal-to-metal;
- composite-to-metal;
- composite-to-composite.

15.5.2.2 Specimen

Specimen geometries for ASTM D-3762 are shown in Figure 15.5-1.

15.5.2.3 Configuration

The test involves driving a wedge between two strap **adherends** whilst monitoring the crack tip position with time. The wedge imposes a fixed displacement to the adherends and the energy stored in bending provides the driving force for crack growth.

As the available strain energy decreases with the fourth power of crack length, a very wide range of energy release rates is available with the specimen.

15.5.2.4 Environmental exposure

The test is time-dependent, as cracked specimens are given up to 30-days to respond in any environment chosen, e.g. a particular combination of temperature and humidity.

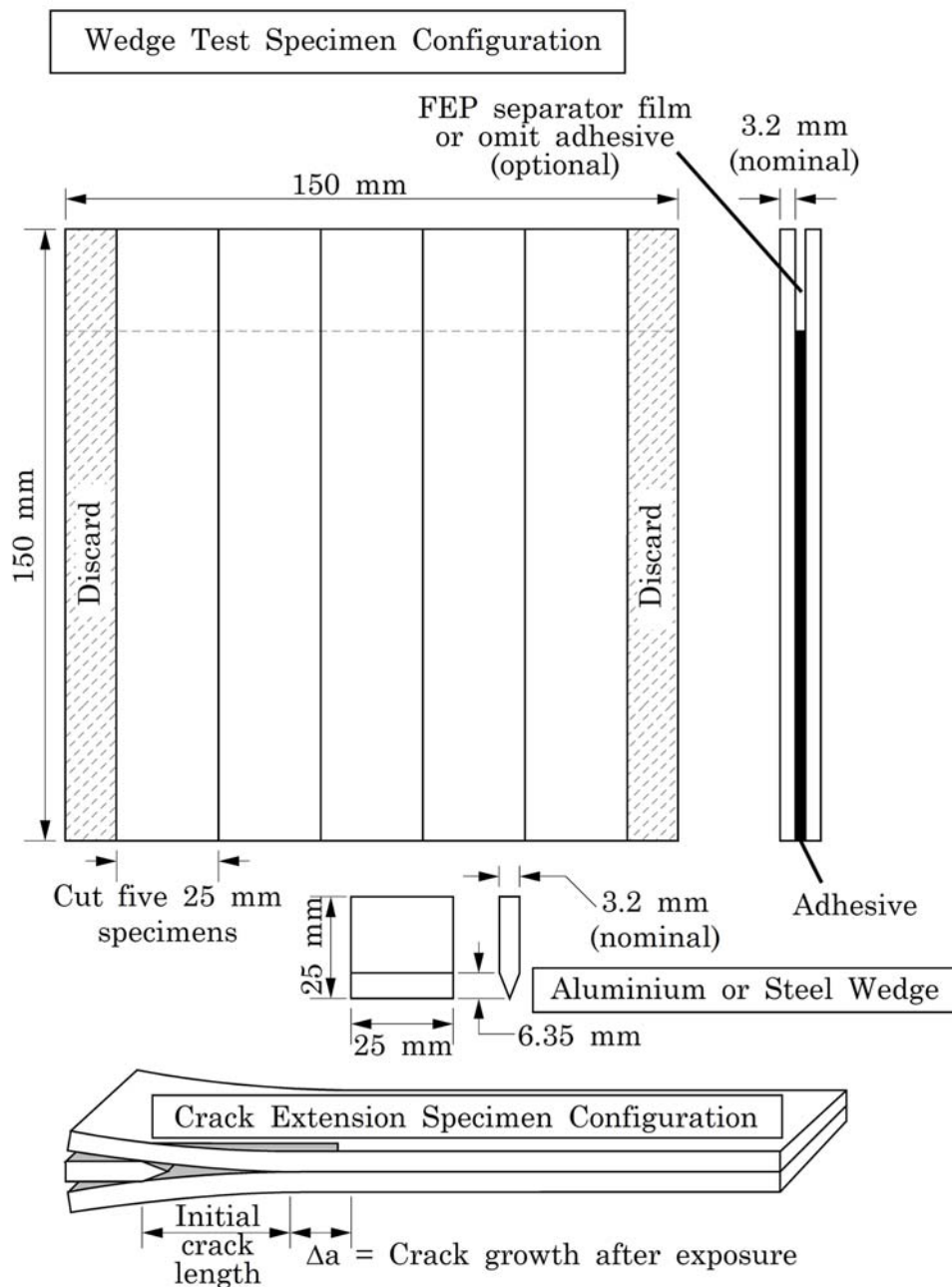

Figure 15.5-1 - ASTM D-3762: Wedge test specimen

15.5.3 Results and analysis

15.5.3.1 Qualitative comparison

Although it is a fracture-type specimen, quantitative analysis is not performed. The test provides a qualitative comparison, i.e.:

- A 'good' toughened adhesive enables the crack to grow slowly to a certain length and stop, presumably at some threshold strain energy release rate.
- A 'poorer', more brittle, adhesive shows faster crack growth and the crack can run out of specimen, resulting in adherend separation.

15.5.3.2 Environmental durability

The findings make it possible to discriminate between the environmental **durability** of a wide range of adhesive and surface preparation systems.

15.6 Peel tests

15.6.1 General

Although **peel** loadings are minimised in structural joint design, with thin gauge materials an element of peel is often unavoidable. Many test methods have been devised for inducing severe peel as a means of determining peel resistance of a whole bond assembly, e.g.

- ASTM standards (D-1781; D-1876; D-3167);
- EN standards (2243-02; 2243-03).

Peel tests are often known by name, e.g.:

- Climbing drum peel test for adhesives, which is used for adhesives;
- T-peel test;
- Floating roller peel.

In all cases, one of the adherends is flexible and deformable. This is normally thin aluminium alloy sheet. It can include metal-to-metal and **sandwich** panel (skin-to-core) constructions. Composites are rarely used in test specimens because they do not possess the necessary plastic deformation characteristics.

The units used to quote values for peel strength are highly test dependent, so comparison of values generated by different test methods is difficult.

15.6.2 Climbing drum peel test for adhesives

Figure 15.6-1 shows the ASTM D-1781 specimen and test assembly. Features of this test include:

- It provides comparative measurements of adhesion and is particularly suitable for process control, showing particular sensitivity to **adherend** surface preparation.
- Direct comparison of different adhesives or processes can only be made when specimen design and test conditions are identical.
- A steady state of peel is needed during testing to provide an average load over a peeled bond length around 125 mm.

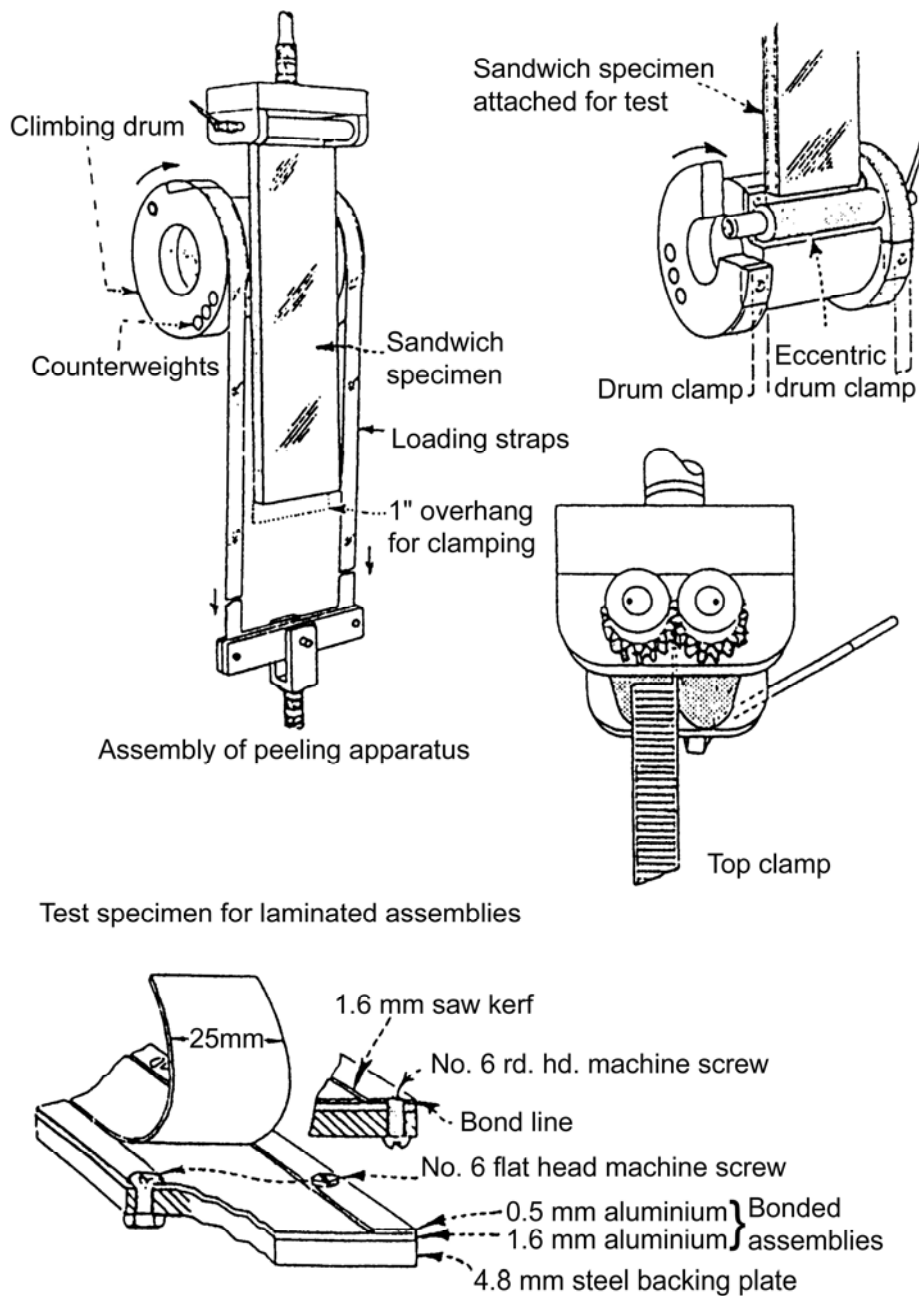
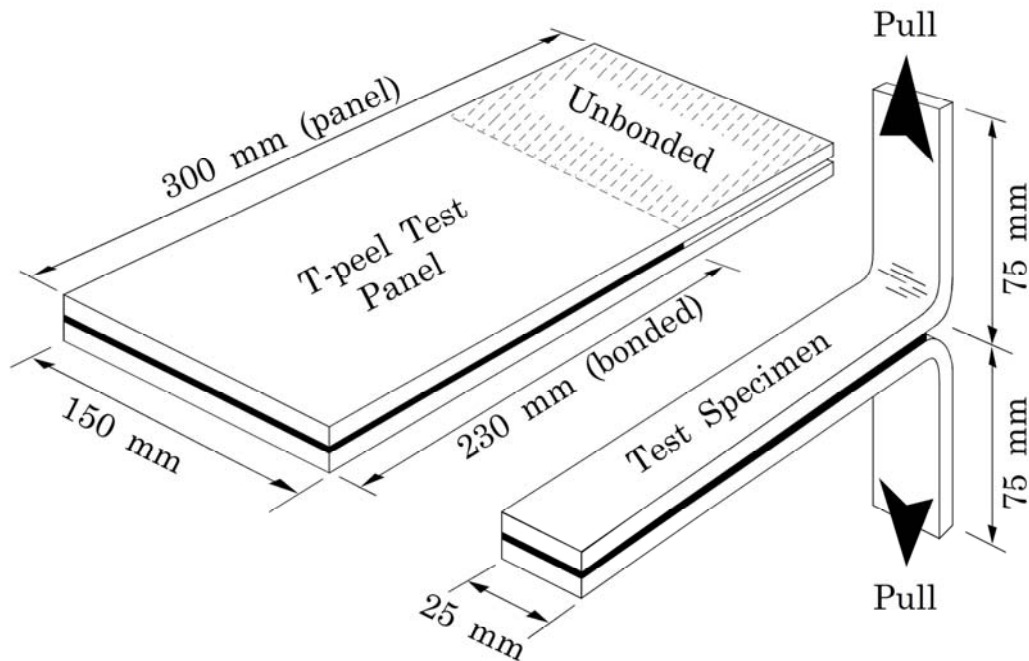

Figure 15.6-1 - ASTM D1781 climbing drum peel test

15.6.3 T-peel test



In ASTM D-1876, T-peel strength is the average load per unit width of bond line to produce progressive separation of two bonded, flexible adherends. The term flexible indicates that the adherends can bend through 90° without breaking or cracking. 2024-T3 aluminium alloy sheet, 0.80mm thick is an appropriate adherend. The specimen geometry is shown in Figure 15.6-2.

Figure 15.6-2 - ASTM D-1876 T-peel test specimen

15.6.4 Floating roller peel

ASTM D-3167 floating roller peel test specimens are made from aluminium alloy sheets 0.63 mm and 1.63 mm thick. The thinner **adherend** is peeled from the thicker one.

This test method is of value for acceptance and process control testing. It can be used as an alternative in ASTM D-1781 when that facility is not available. However, it is a more severe test since the angle of peel is greater.

Figure 15.6-3 shows a schematic representation of specimen and test fixture.

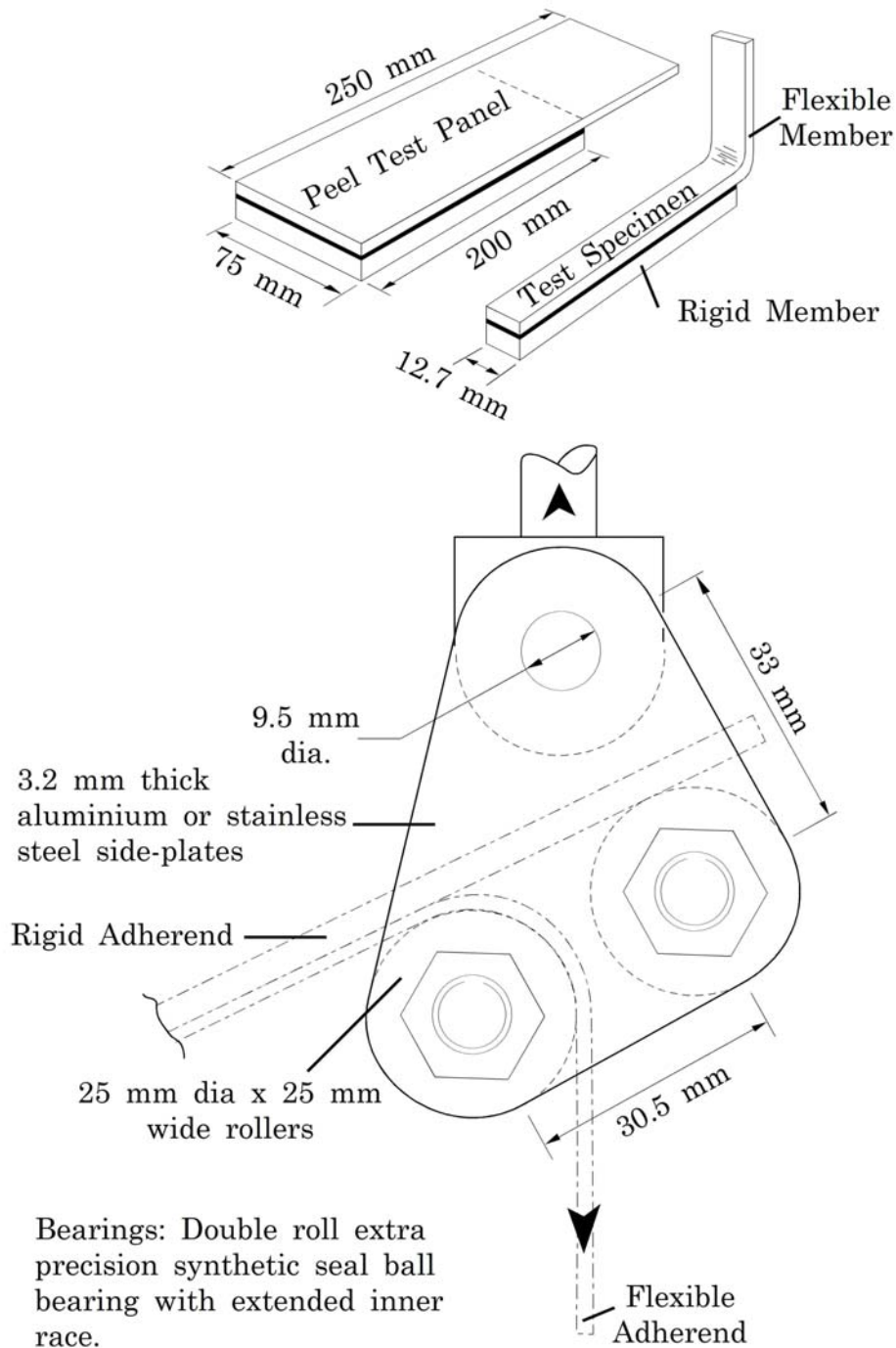

Figure 15.6-3 - ASTM D-3167 floating roller peel test

15.7 Fatigue resistance

15.7.1 Fatigue properties of adhesives

Bonded joints subjected to cyclic loading, especially vibration, can deteriorate in time when the loads involved are insufficient to cause immediate failure.

ASTM D-3166 describes a single lap metal-to-metal shear specimen, loaded in tension. Whilst the specimen is a simple one to manufacture, the test needs a tensile test machine capable of applying sinusoidal cyclic loads at 1800 cycles per minute or more.

15.7.2 Fatigue resistance of bonded joints

15.7.2.1 General

Test methods used to establish the fatigue resistance of bonded joints vary between companies but can be grouped as those needing either:

- specimens having geometries and materials similar to the intended application, Ref. [15-14] or,
- standard test specimens tested under cyclic loading, Ref. [15-15].

Figure 15.7-1 shows examples of both groups of fatigue test specimens.

Test Article	Specimen Configuration
Single Lap	
Double Butt-strap	
Hard Point	
Doubler	
Stringer Runout	
 Stringer to Frame Attachment (pull up)	

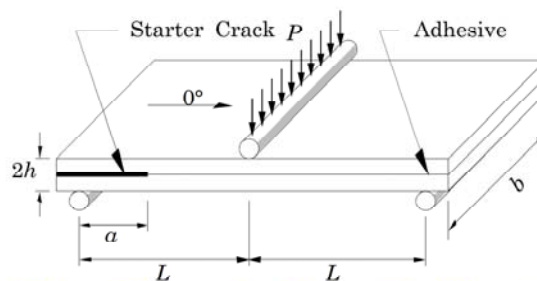

End-notched Flexure Specimen ($L = 50.8\text{mm}$, $2h = 4.1\text{mm}$, $b = 25.4\text{mm}$)

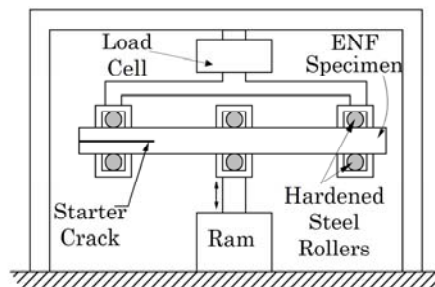

Fatigue loading fixture for End-notched Flexure Specimen

Figure 15.7-1 - Examples of fatigue test specimens

15.7.2.2 Application-based tests

Application-based fatigue tests are commonly included in the design-evaluation exercises. Here the material thickness, overlap lengths and other basic design features are varied and their effect on fatigue resistance established. These tests can also be conducted under simulated service environments in terms of temperature and moisture.

15.7.2.3 Modified standard tests

Modified standard test procedures are used to gain understanding of fatigue failure mechanisms and fracture mechanics studies. These tests establish the influence of cyclic loading on Mode I, II and III energy release rates. Examples of test specimens used for these studies are:

- CLS cracked lap shear, [See: 15.3]
- DCB double cantilever beam, [See: 15.4]
- ENF end notch flexure.

The effect of environment on energy release rates can also be included.

Caution is needed when selecting the frequency for cyclic loading. High frequencies (30 Hz to 50 Hz), as used in metal fatigue tests, can provide misleading results for adhesively-bonded specimens because the adhesive has insufficient time to creep, Ref. [15-16].

Low frequencies (1 Hz to 2 Hz), used to simulate fuselage pressurisation cycles, produce lower fatigue lives in adhesively-bonded specimens because of accumulated creep effects. This is also dependent on the specimen overlap geometry where long overlaps are more creep resistant than short overlaps, [See: Figure 10.2-3], Ref. [15-16].

An alternative approach is to simulate the cyclic loading regime of the intended application. Here, both the frequencies and loads are varied over a period of time.

15.7.3 Acoustic fatigue

Tests are normally application driven, [See also: 9.4].

15.8 Creep resistance

15.8.1 Adhesive properties

Long-term viscoelastic deformation can be a problem for low modulus adhesives under moderate loading. Temperature and moisture also affect the **creep** rate.

For screening aerospace structural adhesives, maximum limits for creep deformation are stated for a given temperature and time, and under a given load, [See: Table 15.1-1].

Limits set for different temperatures also help determine the usable service temperature range.

15.8.2 Test methods

Standard ASTM test methods are:

- ASTM D-1780: Single lap shear specimen, tensile loading with measurement of bondline deformation,
- ASTM D-2293: Single lap shear specimen, compression loading,
- ASTM D-2294: Single lap shear specimen, tensile loading.

ASTM D-2293 and D-2294 test rigs use spring-loaded actuator devices.

15.9 Environmental resistance

15.9.1 Earth

15.9.1.1 Environmental factors

Most of the environmental factors considered are related to aircraft, including:

- chemical resistance,
- ageing, usually combined temperature and moisture cycling,
- weathering,
- radiation (high energy),
- extremes of temperatures,
- bacterial attack.

15.9.1.2 Test methods

Numerous test methods are used for determining environmental effects on the performance of adhesives and adhesive bonds, [See also: Table 15.1-2; [22-8]].

15.9.2 Space

15.9.2.1 Environmental factors

The important properties of adhesives that dictate their tolerance to the space environment are, Ref. [15-2]:

- T_g glass transition temperature,
- CTE coefficient of thermal expansion,
- moisture absorption,
- **outgassing** characteristics, expressed as:
 - collected volatile condensed matter (% CVCM),
 - total mass loss (% TML),
 - recovered mass loss (% RML).

15.9.2.2 Test methods

Within the ASTM-series of standard practices are methods for the testing of adhesives and plastics, Ref. [15-3]. These can be applied to the evaluation of adhesive materials for space use.

Methods for measuring **offgassing** and **outgassing** characteristics were developed by the space industry to meet its particular needs.

A listing of relevant test methods is given in Table 15.9-1, [See also: [22-8]].

Table 15.9-1- Environmental durability in space: Standard test methods

Subject	Standard [See also: [22-8]]
Glass transition temperature	ASTM D-3418
Coefficient of thermal expansion	ASTM D-696
Moisture absorption	ASTM D-570
Outgassing characteristics	ECSS-Q-ST-70-02
NASA/SRI requirements specification ⁺	NASA-STD-6001
Thermal cycling	ECSS-Q-ST-70-04
Particle and UV radiation	ECSS-Q-ST-70-06
Offgassing of toxic materials	ECSS-Q-ST-70-29
Flammability	ECSS-Q-ST-70-21
Key: +	Flammability, odor, offgassing and compatibility requirements and test procedures for materials in environments that support combustion; previously NASA NHB 8060.1

15.10 References

15.10.1 General

- [15-1] B.J. Mulroy Jnr. & D.M. Mazenko
‘Structural Adhesives for Space Systems’
Proceedings of Conference on Structural Adhesives and Bonding
California, March 13th to 15th, 1979, p340-359
- [15-2] K. Leichti et al
‘Experimentally determined Strength of Adhesively Bonded Joints’
Joining Fibre-reinforced Plastics. F.L. Matthews (Editor)
Elsevier Applied Science, 1987. ISBN 1-85166-019-4
- [15-3] Annual Book of ASTM Standards. Volume 15.06: Adhesives
- [15-4] G.P. Anderson et al
‘Evaluation of Adhesive Test Methods’
Adhesive Joints - Formation, Characteristics & Testing
K.L. Mittal (Editor), p.269-287. Plenum Press Publication. 1984
- [15-5] G.P. Anderson et al

- 'Analysis and Testing of Adhesive Bonds'
Academic Press. 1977. ISBN 0-12-056550-1
- [15-6] W.T. Carvill & J.P. Bell
'Torsional Test Methods for Adhesive Joints'
Journal of Adhesion. Vol. 6, p185-193, 1974
- [15-7] T.B. Frazier
'A Computer-assisted Thick Adherend Test to Characterise the
Mechanical Properties of Adhesives'
Proceedings of National SAMPE Technical Conference, 1970
Vol. 2, p71-88
- [15-8] I. Skiest (Editor)
'Handbook of Adhesives'. 3rd Edition
Van Nostrand Reinhold Co. 1990
ISBN 0-442-28013-0
- [15-9] Dr. L.J. Hart-Smith: McDonnell Douglas Aerospace, USA
'The Bonded Lap Shear Test Coupon - Useful for Quality Assurance
but Dangerously Misleading for Design Data'
Proceedings of 38th International SAMPE Symposium
10-13 May 1993, p239-246
- [15-10] S. Mall & W.S. Johnson
'Characterisation of Mode 1 and Mixed-Mode Failure of Adhesive
Bonds between Composite Adherends'
Composite Materials: Testing and Design (Seventh Conference)
ASTM STP 893. J.M. Whitney (Editor), p322-334
- [15-11] K.L. Mittal (Editor)
'Adhesive Joints-Formation, Characteristics and Testing'
Plenum Press Publication 1984
- [15-12] M. Kemp: DRA, UK
'A Comparison of Test Methods for Evaluating the Bonding of a
Composite Repair Patch to a Composite Substrate'
Proceedings of 6th European Conference on Composite Materials
ECCM6, Bordeaux, France, 20-24 September 1994, p317- 322
- [15-13] Encyclopaedia of Material Science and Engineering Vol. 1
1986. p.365-377.Pergamon Press ISBN 0-08-022158.0
- [15-14] A. Galasso et al
'Aspects of the Fatigue Behaviour of Typical Adhesively
Bonded Aircraft Structures'
'New Materials and Fatigue Resistant Aircraft Design'
Published by Engineering Materials Advisory Services Ltd., UK
- [15-15] S. Mall & N.K. Kochhar
'Characterisation of Debond Growth Mechanisms in
Adhesively Bonded Composites Under Mode II Static and
Fatigue Loadings'
Journal of Engineering Fracture Mechanics Vol. 31, No.5
1988, p747-758
- [15-16] A.A. Baker & R. Jones (Editors)

'Bonded Repair of Aircraft Structures'
Martin Nijhoff Publishers, 1987. ISBN 90-247-3606-4

- [15-17] W. Broughton & M. Gower: NPL (UK)
'Preparation and Testing of Adhesive Joints'
Measurement Good Practice Guide No. 47
ISSN 1368-6550 (September 2001)

15.10.2 ECSS documents

[See: [ECSS](#) website]

ECSS-Q-ST-70	Materials, mechanical parts and processes
ECSS-Q-ST-70-02	Thermal vacuum outgassing test for the screening of space materials
ECSS-Q-ST-70-04	Thermal testing for the evaluation of space materials, processes, mechanical parts and assemblies
ECSS-Q-ST-70-06	Particle and UV radiation testing of space materials
ECSS-Q-ST-70-21	Flammability testing for the screening of space materials
ECSS-Q-ST-70-29	Determination of offgassing products from materials and assembled articles to be used in a manned space vehicle crew compartment
ECSS-Q-70-71	Data for the selection of space materials and processes

15.10.3 Other standards

NASA-STD-6001	Flammability, odor, offgassing and compatibility requirements and test procedures for materials in environments that support combustion; previously NASA NHB 8060.1 (parts A and B).
---------------	--

[See also: [22-8]]

16 Inspection

16.1 Introduction

Inspection and quality assurance of structural bonded joints are closely linked. Quality control determines acceptable process criteria, usually on coupons, but also on full structures.

The aim of quality control is to ensure that the properties demonstrated in testing reflect the properties achieved by the structure, [See also: 14.1].

The terms NDT non-destructive testing and NDI non-destructive inspection are often interchangeable.

Non-destructive testing, NDT, confirms whether the manufacturing process has successfully avoided creating defects that reduce the structural integrity. Any limitations of the NDT techniques used also need to be taken into account. Those defects which are not detectable should be prevented by adequate quality control, [See: 16.2].

[See also: 20.1 for NDT in service]

16.2 Role of inspection

16.2.1 General

The structural bond integrity is assessed and monitored during manufacture and throughout the service life of the structure. Most design data, and much of the manufacturing and in-service integrity data, are derived from mechanical property testing of both coupons and full-size structures, [See also: 20.1 for NDT in service].

16.2.2 Quality control and inspection

Confidence in bonded structures is based on the assurance that the level of adhesion in the manufactured structure is the same as that derived by test. This overall assurance can only be provided by quality control and non-destructive testing; which are very closely related. The application of NDT at the end of the manufacturing cycle provides the final reassurance of the success of the quality control procedures, Ref. [16-1], [16-2], [16-3].

16.2.3 Non-destructive testing

16.2.3.1 Limitations

Aspects of NDT that are particularly significant for bonded joints are:

- a non-destructive evaluation can only be achieved where the bond is accessible to the inspection equipment; a factor frequently overlooked by designers,
- no NDT techniques provide a quantitative assessment of bonded joint strength.

16.2.3.2 Acceptance criteria

It is necessary to establish NDT calibration methods and define acceptance criteria that take into account features resulting solely from the bonding process. The adherends, be they composite or metal, are inspected and accepted prior to bonding.

16.3 Defects

16.3.1 Bonded joints

16.3.1.1 Overlap joints

Direct overlaps are the most common forms of load-bearing joint and are used in numerous assemblies, [See also: 21].

16.3.1.2 Sandwich panels

Adhesives are used in **sandwich** panels for:

- skin-to-core bonding,
- edge member bonding,
- attachment of other fittings, e.g. **inserts**, [See: ECSS documents: ECSS-E-HB-32-22].

Structural edge members are designed to connect composite **honeycomb sandwich** components to other parts of the structure. The joint between the honeycomb sandwich and the edge member can transfer loads from bolts, rivets or adhesive joints and distribute them throughout the face skins. The shear component of these loads is transferred from the edge member to the honeycomb core by means of an adhesive bond parallel to the core cell walls. This bond is usually made with a foaming adhesive. In this situation porosity in the adhesive is permissible, [See also: 22].

16.3.2 Adhesion

16.3.2.1 General

In order to assess the true quality of an adhesive bond, non-destructive examination needs to detect the main classes of defects which can significantly impair joint strength, e.g.:

- the effect of surface contamination,

- amount of porosity in the adhesive,
- voidage,
- delaminations and debonds.

16.3.2.2 Surface contamination

Surface contamination of adherends by grease, fluids and solvents is avoided through strictly-controlled quality assurance procedures during the surface preparation and pretreatment stage, [See: 12].

It is particularly difficult to detect contamination in a completed joint using NDT techniques.

A contaminated bond can give the impression of intimate contact between adhesive and adherend, but lacks shear strength and, in effect, behave like a disbond.

Solid forms of contaminant such as grit, swarf and polymer backing sheets can be readily detected and the area of disbond quantified.

16.3.2.3 Porosity and voids

Porosity in the adhesive and voidage between adhesive and adherend result from insufficient control during processing. These can be detected and quantified by NDT methods.

16.3.2.4 Delamination and disbands

Delaminations within adherends or debonds between adherend and adhesive normally occur in service. These can be readily located by NDT.

16.3.3 Cohesive properties of adhesives

As well as the **adhesion** characteristics, the **cohesive** qualities of the adhesive need to be determined. Porosity, the state of cure and the adhesive layer thickness are the important parameters.

Experience shows that under- or over-curing are usually found by process condition monitoring or from test coupons made at the same time as component; known as witness samples.

If a wrongly cured bond goes unnoticed, the only equipment with any chance of detecting the defect is the 'Fokker Bond Tester'; providing there is sufficient accumulated experience of the same adherend and adhesive.

Variations in the thickness of the adhesive layer can be quite large, from 50% to 400% of the ideal. These variations can be quantified non-destructively, if necessary, [See: 16.7].

16.3.4 Significance of defects

16.3.4.1 General

The discovery of a defect in an adhesively-bonded joint raises questions that need to be answered, i.e.

- Presence, why is it there?
- Effect on joint load-transfer, how does it affect the load-transfer properties of the joint?

- Repair, does it need to be repaired?

16.3.4.2 Presence

If all the factors influencing joint design and manufacture are fully evaluated, gross defects are usually avoided.

The designer produces a joint detail that meets the loading regimes and that can be manufactured reliably and repeatedly. This is then verified by acceptance testing procedures. If, despite this, a defect occurs, an investigation of all the procedural documentation is needed to locate the cause and to prevent recurrence.

16.3.4.3 Effect on joint load-transfer

The designer produces a joint detail in which the shear strength of the joint exceeds the adherend strength outside the joint by some ratio; as stated in the specification. The effect of the defect is to reduce that margin by some amount. The strength margin cannot be reduced to less than 50%, [See also: 10.4].

No significant loss of joint strength or increase in adhesive shear stress and strain occurs, despite large defect sizes relative to the overlap length, e.g. a 25.4 mm. disbond in a 50.8 mm. overlap, [See: Figure 10.4-3; Figure 10.4-4; Figure 10.4-5; Figure 10.4-6].

The maximum size of a local bond defect which can be tolerated is established with respect to joint strength and overlap characteristics; as shown in Figure 16.3-1, Ref. [16-4].

The adhesive becomes the weak link if the effective overlap is reduced from the original design value to that corresponding to the shoulder of the potential-bond-shear-strength-curve.

A minimum effective overlap is 50% greater than that; corresponding to the 50% strength margin. It is then unimportant how the remaining effective bond area is distributed throughout the overlap; the strength is essentially the same.

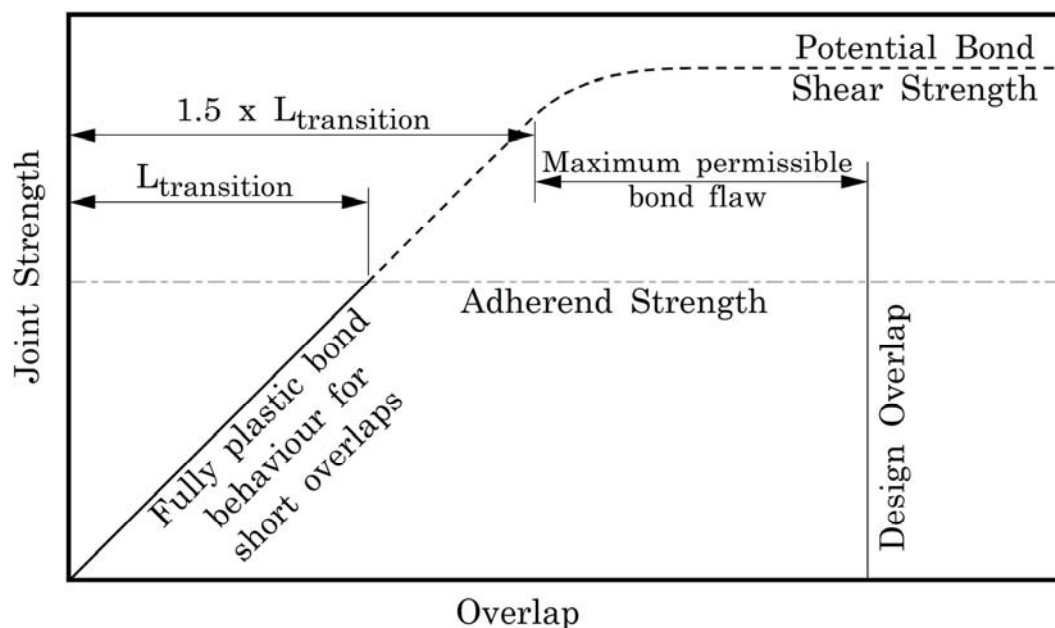

Figure 16.3-1 - Maximum permissible local defect

16.3.4.4 Repair

For gross defects which seriously affect the as-designed properties, the options are to either repair or replace.

For other defects, service experience suggests that unnecessary repairs of defects or damage to adhesive bonds should be discouraged. The exception are any defects that are surface breaking, i.e. edge defects, which need to be sealed to avoid ingress of moisture and corrosion.

Repairs to non-edge defects, such as a central disbond, can only be achieved by perforating the adherend and injecting adhesive or resin mix. This type of repair is avoided as the **adherend** is weakened and, for metals, any surface protection system is breached, Ref. [16-4].

[See also: 17 for bonded repairs]

16.4 Inspection techniques

16.4.1 Commonly-used techniques

16.4.1.1 Initial assessment

For initial assessments, visual inspection and coin tapping are used, Ref. [16-10]. These can provide subjective evidence, particularly in detecting the presence of gross defects such as **delaminations**, **debonds** and severe core damage in **sandwich** panels.

16.4.1.2 NDT techniques

Non-destructive inspection techniques used for adhesive bonds include, Ref. [16-5]:

- ultrasonics, [See: 16.5]:
 - C-scan, which is widely used to locate disbonds.
 - A- and B-scans, which are usually combined with complex signal analysis and processing, Ref. [16-6].
 - Lamb waves (leaky) for interfacial investigation, Ref. [16-7].
 - Acousto-ultrasonic, which is a relatively new technique that shows some promise for qualitative assessments of bond strength, Ref. [16-8], [16-9].
- radiography, using X-rays, [See: 16.6],
- mechanical impedance:
 - Fokker bond tester, [See: 16.7].
 - Acoustic flaw detector, [See: 16.7].
- holography, [See: 16.8],
- thermography, [See: 16.9],
- acoustic emission, [See: 16.10].

[See also: 10.4 for aspects of the inspection of bonded joints]

Table 16.4-1 provides a summary of the capabilities of the NDT techniques appropriate for structural bond examination. The techniques described are used during the manufacture or

assembly stages. Variants of these techniques are used for inspecting structures in service, Ref. [16-17]. [See also: 20].

Table 16.4-1 - NDT Techniques: Summary of defect detection capability

Ultrasonic C-scan [See: 16.5]	X-radiography [See: 16.6]	Fokker Bond Tester [See: 16.7]	Acoustic Flaw Detector [See: 16.7]	Holography [See: 16.8]	Thermography [See: 16.9]	Acoustic Emission [See: 16.10]
Porosity in adhesive. Voidage in bondline						
YES	YES (>0.1mm)	YES (>0.1mm)	NO	NO	YES (gross voids)	NO
Debond in bondline. Delaminations in composite adherends						
YES	NO	YES	YES	YES	YES (gross)	YES
Adherend surface contamination by fluids, oils and grease						
NO	NO	NO	NO	NO	NO	NO
Bondline contamination by solids, including backing sheet						
YES	YES	YES	YES	YES (large)	YES (large)	NO

16.4.2 Developments

16.4.2.1 Bond strength

Techniques under development aim to solve the problem of measuring the bond strength by non-destructive means. Although the work is in the early stages, some successes have been reported on the correlation of NDT results and simple coupon tests, Ref. [16-7], [16-8], [16-9].

Information on development techniques is included for information. only and does not imply that a means of quantitatively measuring bond strength by NDT now exists.

16.5 Ultrasonic

16.5.1 Applications

Ultrasonics is an extremely versatile method of non-destructive testing and is used for inspection of bonded structures. It is widely used within the aircraft industry to inspect large sections of complex shape and construction, Ref. [16-15].

16.5.2 Limitations

The Pulse-echo method only locates defects normal to direction of propagation of sound.

The Through-transmission method only indicates the presence of a defect, not its depth.

Surface condition, finish or the adherence properties of surface coatings can adversely affect coupling of sound to the test article.

A coupling agent is usually necessary, e.g. grease, water, which is not always compatible with cleanliness and contamination control stipulations. Air-coupled systems have been evaluated for some space applications to avoid potential contamination problems, Ref. [16-16]

16.5.3 C-scan

16.5.3.1 General

C-scan techniques are particularly suited to finding delaminations, debonds and cracks. Voids and porosity are also detectable. The minimum size of voids and delaminations detectable with C-scans is around 2 mm, Ref. [16-11], [16-12].

C-scanning can give a total volumetric inspection of the component for defects lying transverse to the propagation direction of the ultrasound.

A beam of ultrasound is projected into the sample and, in the two major variants, either reflected back or received at the backface by a second probe. This either produces a time (hence depth) trace of reflecting features in the sample (A-scan), or a measure of transmitted attenuation. Moving the sampling point over an area of the surface can then produce a two- or three-dimensional map of the sample. A focused transducer enables the reflection technique to be used to perform high resolution area scans of a thin layer within the sample. This can be useful for bondline examination. There are many variations in the implementation methods of the basic forms of C-scanning.

Data derived from B-scan and C-scan reflections can be used to determine flaw depth and area of disbond. Signal processing techniques determine the amplitude and polarity of the signals. Such a technique has been used for the high-resolution imaging of disbonds in **CFRP**-to-titanium stepped lap joints, Ref. [16-6], and for entire sections of composite aircraft structures, Ref. [16-15].

All of the ultrasonic methods provide a hard copy of the output, usually in the form of black and white or colour pictures. Some systems also enable the output from inspection to be superimposed onto design drawings to show defect size and position with respect to the as-designed article, Ref. [16-15]

16.5.3.2 Through-transmission

A pair of transducers is placed one each side of the sample, and measure the attenuation of ultrasound between them. Moving the transducers enables mapping of the attenuation behaviour. Strongly reflecting features, e.g. disbonds, delaminations, reflect sound away from the intended path, hence reducing, or blocking, transmission.

All practical ultrasonic inspection techniques 'couple' the transducers to the sample to enable efficient passage of sound into and out of the material. This is usually achieved by:

- total immersion of component and transducers in water,
- jet-probes with which the ultrasonic energy is coupled to the component along pumped water columns,
- roller probes, where rubber rollers are used in place of the coupling liquid. The versatility of roller probes lies in their non-contaminating operation and handling of non-parallel sections,
- air-coupling, assessed for space applications to avoid potential contamination problems, Ref. [16-16].

16.5.3.3 Pulse-echo

Pulse-echo provides the depth information that through-transmission methods cannot, enabling the planar location of defects. Two modes of pulse-echo examination are used:

- longitudinal waves, which are used for normal incidence examination of the thickness direction of laminates, and are primarily used for bond-line inspection, delaminations and features lying parallel to the surface,
- shear waves, which are propagated at a low angle into the laminate and used to detect such features as transverse cracks, microcracks and features lying out of the lamina planes.

16.5.4 Leaky Lamb waves (LLW)

Two transducers in a 'pitch-and-catch' arrangement are placed at an angle. The probes and test piece are immersed in water, or a water column is maintained between the probes and the part surface.

For a fixed angle of incidence, acoustic waves are mode-converted, inducing Lamb (plate) waves at certain specific frequencies. These propagate along the sample, leaking sound back out into the fluid. When a leaky wave is emitted, it interacts with the directly reflected wave, causing interference phenomena, Ref. [16-14].

The advantages over conventional (body wave) ultrasonics is that:

- lamb waves can be used to generate a large number of data points in a given frequency range;
- lamb-wave velocity is strongly affected by the properties of the interface zone, e.g. total or partial debonds and inclusions;
- velocity of Lamb waves can be accurately measured.

It has been widely used in seismological studies and in the engineering sector, the applications include:

- detection of delaminations (unbonds) in composites,
- detection of disbonds between metals and rubber.

16.5.5 Acousto-ultrasonic

16.5.5.1 General

This is a relatively new technique (circa. 1982) which combines ultrasonic and acoustic emission probes. Repetitive ultrasonic pulses are injected into the test piece by a broadband ultrasonic transducer. A receiving acoustic emission sensor is placed on the same side of the specimen to intercept propagating stress waves.

Although the transmitting transducer injects compression waves normal to the surface, the energy transferred into the material produces stress waves which, like Lamb waves, radiate in the plane of the bond and interact with a significant fraction of the bondline in their path.

The method is attractive because:

- access is only needed to one side of the sample,
- acoustic emission probes have less directional sensitivity than ultrasonic probes, which aids alignment,
- acoustic emission probes are more tolerant of the high attenuation seen with bonded assemblies, especially between composites.

Obtaining and interpreting reproducible received signals is considered to be major difficulty, Ref. [16-9]. Factors such as physical shape of the part, adhesive thickness and adherend type affect the stress wave propagation.

For a practical system, extensive calibration on identical 'good' bonds is needed before analysing 'defective' or 'possibly defective' bonds. Studies have considered a number of materials, including composites. Bonded assemblies tend to be simple constant geometry, overlap types with defects such as voids, total disbonds or degraded adhesive.

16.5.5.2 Adhesion tester

The 'ATACS Adhesion Tester' is a recently-available system based on acousto-ultrasonics. It has demonstrated some correlation between experimental peel strength and predicted peel strength values; although it needs a full 'baseline' data set for adhesive types to be established, e.g. knowledge of carrier type for supported adhesives. The effects of moisture, which change the initial 'dry' adhesive properties, can produce misleading results, Ref. [16-8].

16.6 Radiography

16.6.1 Application

Radiography is suitable for detecting volumetric internal defects and for the inspection of assemblies.

16.6.2 Limitations

Radiography can only detect volumetric defects and cannot be used for the reliable detection of 'lamination-type' defects.

16.6.3 X-radiography

X-radiography enables the volumetric inspection of components. An image is formed on a photographic film or electronic detector following differential absorption of X-ray energy by elements present in the component.

Low energy or 'soft' X-rays of a few tens of keV are used for composites, compared with 50keV to 150keV for metallic sections.

The low absorption coefficient of composite materials provides poor contrast. Consequently, some defect types are not readily detectable by means of X-rays.

In particular, thin debonds and delaminations are difficult to detect because the presence or absence of these has little effect on the absorption characteristics of the material. The technique is better suited to providing information on the physical presence of solid material. Voids within bonds can be detected.

Agents to aid contrast under X-ray examination can be incorporated into either the adhesive itself, or the film adhesive release sheet. Some commercial adhesives are marketed as X-ray opaque, [See: 6].

X-ray examinations are relatively rapid and provide a permanent record of a joint in the form of an image which is readily interpreted by eye.

16.7 Mechanical impedance: Bond testers

16.7.1 Application

Mechanical impedance is usually used to assess the integrity of:

- skin-to-skin bonds,
- skin-to-honeycomb bonds.

16.7.2 Limitations

Techniques are comparative and it is therefore necessary to produce test panels with artificially-induced defects for calibration purposes. The methods do not give information regarding the adhesive quality of bonds. There are also limitations in the thickness of faceskins and doublers that can be tested.

16.7.3 Principle

The structure is excited with relatively low-frequency mechanical vibrations and its response to these excitations is measured. Various methods are used, including:

- excite structure with eddy currents and measure the amplitude and phase of the returning signal,
- excite structure using piezoelectric means and measure the amplitude and phase of the returning signal,
- excite structure using piezoelectric means and measure the amplitude and frequency of the received signal at resonance.

16.7.3.1 Commercial systems

Commercially-available instruments used to measure the integrity of structural bonds are:

- Fokker bond tester;
- Acoustic flaw detector.

The instruments both use piezoelectric crystals to oscillate the component at high frequency (2 kHz to 1 MHz). The mechanical impedance is then measured with the specimen acting as a load on the crystal.

They are essentially comparative techniques detecting the difference in response of different areas. Hence, well defined 'good' and 'bad' areas are needed to calibrate the instruments.

Complete disbonds are relatively straightforward to detect as they cause a major change in the thickness impedance of a bondline. Both instruments are particularly useful in detecting the debond- or delamination-type of defect.

Bond testers measure cohesive properties only, they do not assess adhesion (except with a total disbond), [See also: 16.5].

16.7.4 Fokker bond tester

The Fokker bond tester, Ref. [16-18], is used for the inspection of: adhesively-bonded structures, including:

- bonded sheet-to-**honeycomb** metal and composite assemblies,
- bonds between composite materials, e.g. carbon fibre, boron fibre, glass fibre, fibre metal laminates (**GLARE®** and **ARALL®**),
- delaminations, voids and porosity in composite materials,
- brazed honeycomb,
- thickness measurement.

The equipment is highly developed and has an enormous existing documentation particularly on metal-to-metal bonds.

In the hands of an experienced operator, it is a very powerful bond testing device. However, it is a manually-operated, point testing device needing a coupling liquid.

16.7.5 Acoustic flaw detector

An acoustic flaw detector is a dry probe instrument, so avoids the need for a couplant. The tip of the probe often has a PTFE cover to provide low friction for lateral movements of the probe.

Its importance lies in its ability to inspect complex shapes with double curvatures. Operation is usually manual.

16.8 Holography

16.8.1 Application

Holography is particularly suited to non-contact inspection of sandwich constructions and antenna configurations. Internal and external features can be examined, including any bonded surfaces. The technique is most appropriate for thin composite sections; of the order of 1 mm thick.

16.8.2 Limitations

Holographic inspection needs special working conditions, free from vibration.

16.8.3 Principle

The monochromaticity and coherence of laser light enables holograms to be produced, storing reflected intensity and phase information from the sample.

In testing, a hologram of the component or structure is produced. This is then used to project a holographic image onto the subject in exactly the same position in space. The visual information from the two now matches exactly in phase and intensity. The subject is then deformed slightly, often by gentle heating. This causes the visual information from the subject to change slightly, and this light interferes with the holographic image forming an interference fringe system over the surface of the subject.

The shape and distribution of these fringes is determined by the amount of strain in the surface of the subject. If there are any discontinuities in this surface then they are visualised as discontinuities in the fringe pattern. It is this fringe pattern and the disturbances caused to it by defects which constitute the inspection method. The benefit of this method is that it is completely non-contact operation which enables viewing of the whole item under test.

The defects that give rise to the greatest variations in surface strain are of the **debond** and **delamination** variety.

16.9 Thermography

16.9.1 Application

Thermographic techniques can be used to detect gross voidage, **delamination** and **debonds** (100mm²) in entire structures.

16.9.2 Limitations

Thermography needs special facilities and experience of the particular material combinations within the structure under test.

16.9.3 Principle

Heat is applied to one side of the item under test and is conducted through the structure. The heating methods used include:

- thermal pulse, where the uptake and spread of thermal energy is monitored,
- thermal soak, where the gradual dissipation of heat is studied.

Any discontinuities present affect the rate of heat conduction, hence different areas emit different temperatures. These effects can then be correlated with the integrity of the structure or the defect population present.

Depending upon the technique employed, either the incident or remote surfaces can be monitored for changes in temperature. Techniques used for the detection of surface heat distribution, include:

- infra-red scanning,
- temperature-sensitive media, e.g. liquid crystals, paints, thermo-phosphors,
- thermocouples,
- infrared imaging, using CCD TV cameras.

Signal processing of the thermal distributions recorded by IR imaging (digital or analogue) aids positioning of discontinuities and defects, Ref. [16-13].

16.10 Acoustic emission

16.10.1 Application

Acoustic emission is a contact technique that relies on mechanical straining of the component or structure under test. It can indicate the significance of a defect without identifying its nature, Ref. [16-14].

AE can be regarded as not truly nondestructive, in that emissions are generated by failure mechanisms within a structure. It is often used to monitor acoustic events when a proof test is mandatory, e.g. pressure vessels, and during qualification testing on structures.

Historical data for proof-loaded structures is available from testing numerous items, which aids interpretation of AE data.

16.10.2 Limitations

Accumulated experience with a material and structural configuration is needed to determine the character of the emissions associated with a particular defect type. The acoustic signature of each defect type should be known. Such signatures are often material and structure dependent, so computer-aided pattern recognition is important.

With bonded joints, **delaminations** and **debonds** can be detected, but little else.

16.10.3 Principle

The structure is instrumented with acoustic emission sensors, which are effectively high-sensitivity microphones. The number and position of each sensor is usually determined by the particular structure under test, e.g. position of joints or other features, and the need to triangulate between sensors to give the position of detected noise.

The item under test is then loaded and any noise emanating from the structure is monitored and recorded. In general, the discriminating factors are:

- if no emissions occur it is concluded that, however many defects are present and whatever their type, they have not propagated, or resulted in damage, during proof testing.
- if emissions are detected, it is an indication of strain energy release and hence damage has occurred.

Triangulation techniques compare the arrival time of the same sound event at several different transducers; known as time-of-flight. This locates the position of acoustic sources. The frequency and amplitude description of the event is compared with reference data to determine the type of damage.

Signal processing has enabled AE to gain greater acceptance for the inspection of structures, including condition monitoring of tank structures for space vehicles, [See: ECSS documents: ECSS-E-HB-32-20].

AE can also be combined with ultrasonics, [See: 16.5].

16.11 References

16.11.1 General

- [16-1] ECSS-E-HB-32-20:: Structural materials handbook; previously ESA PSS-03-203
- [16-2] G. Jackson & G.A. Marr
'Quality Control of Adhesive Bonding in the Manufacture of Aircraft Structures'
International Conference on Structural Adhesives in Engineering 2-4 July 1986. IMechE Conference Publications 1986-6, Paper C181/86, p133-138
- [16-3] Dr. L.J. Hart-Smith: McDonnell Douglas Aerospace, USA
'How to get the Best Value for each Dollar spent Inspecting Composite & Bonded Aircraft Structures'
Proceedings of 38th International SAMPE Symposium 10-13 May 1993, p226-238
- [16-4] A.A. Baker & R. Jones (Editors)
'Bonded Repair of Aircraft Structures'
Martin Nijhoff Publishers, 1987. ISBN 90-247-3606-4
- [16-5] Special Issue: NDT of Composites and Bonded Joints
NDT International Volume 21 Number 4, August 1988

-
- [16-6] K.I. McRae: Dept. of National Defence, Canada
'High Resolution Ultrasonic Imaging of Disbonds in Adhesively Bonded Composite Structures'
Report No. 91-30283, March 1989
- [16-7] A.K. Mal et al: Uni. of California/McDonnell Douglas Corp, USA
'Analysis of Leaky Lamb Waves in Bonded Plates'
International Journal of Engineering Science, Vol.27, No.7, 1989, p779-791
- [16-8] R.F. Wegman: Adhesion Associates, USA
'The Evaluation of the Properties in Adhesive Bonds by Non-destructive Evaluation'
Proceedings of 38th International SAMPE Symposium, 10-13 May 1993, p834-844
- [16-9] A. Fahr & S. Tanary: National Research Council, Canada
'Nondestructive Evaluation of Adhesively-Bonded Joints'
AGARD-CP-462, Paper No. 7, May 1990, ISBN 92-835-0546-8
- [16-10] R.D. Adams & P. Cawley
'Low-velocity Impact Inspection of Bonded Structures'
1986 IMechE Paper C181/86 p241-256
- [16-11] R.J. Schliekelmann
'Quality Control of Adhesive Bonded Joints'
1986 IMechE Paper C182/86 p241-256
- [16-12] B.B. Djordjevic & J.D. Venable
'Nondestructive Evaluation of Bonded Metal and Composite Structures'
Proceedings of the 13th Symposium on Non destructive Evaluation April 21-23, 1981. p68-76
- [16-13] P. Cielo et al
'Thermographic Nondestructive Evaluation of Industrial Materials and Structures'
Materials Evaluation April 1987 p452-465
- [16-14] J.L. Rose & E. Segal
'Nondestructive Testing Techniques for Adhesive Bond Joints'
Research Techniques in Nondestructive Testing, Volume IV
R.S. Sharpe (Editor). Academic Press 1980 p275-316
- [16-15] Ultrasonic Sciences Ltd, UK - website.
'Multi-axis automatic ultrasonic inspection systems for advanced composite aircraft structures'; 2003
- [16-16] R. W. A van der Ven & H. Bolks: Fokker, NL.
'Air coupled ultrasonic C-scan (AIRSCAN®) for non-destructive inspection'
ESA Conference on Spacecraft Structures, Materials & Mechanical Testing, March 1996. Abstracts, p94

- [16-17] 'Nondestructive evaluation'
Published in 'New Materials for Next-Generation Commercial
Transports', Committee on New Materials for Advanced Civil
Aircraft, National Research Council.
National Academies Press, 2000, ISBN 0309053900
- [16-18] Servicing Europe NDT, Roosendaal, NL -website
Fokker Bond Tester (supply, calibration and repair)

16.11.2 ECSS documents

[See: [ECSS](#) website]

- | | |
|-----------------|---|
| ECSS-E-HB-32-20 | Structural materials handbook; previously
ESA PSS-03-203 |
| ECSS-E-HB-32-22 | Insert design handbook; previously ESA PSS-
03-1202 |

17

Materials for repairs

17.1 Introduction

17.1.1 General

Aspects of repair and maintenance techniques are discussed because of their possible relevance to long-life or reusable space structures. The repair methods are mainly based on existing aeronautical practice but can also be appropriate to European-based space programmes.

The adhesively-bonded repair of cracked or damaged, primary and secondary aircraft structures is well-established and supported by extensive test, analysis and experience. Attempts to standardise bonded repair procedures for aerospace structures resulted in US MIL-HDBK-337, Ref. [17-1].

17.1.2 Repair procedures

Repair documents are developed by aircraft manufacturers, each using their own preferred methods and procedures. These normally reflect the component's initial fabrication methods, e.g. adhesive type, processing. Those responsible for carrying out repairs usually refer to manufacturers' recommendations, but modifications to the materials or procedures are sometimes made depending on the facilities and expertise available.

17.1.3 Repair levels

17.1.3.1 General

The defined levels of repair are classed as:

- Depot repairs;
- Field repairs;
- battle damage, i.e. a temporary repair made to active military aircraft. Such repairs are usually made to restore aerodynamic control surfaces only.

17.1.3.2 Depot repairs

Facilities and equipment available are likely to be extensive; often to the same level as those found in the original manufacturing plants, e.g. autoclaves and controlled environments.

Permanent repairs are often extensive and technically difficult to achieve in other conditions. **Film** adhesives are usually used.

17.1.3.3 Field repairs

Skilled personnel and the equipment available can vary, e.g. no autoclave and possibly no cold storage for materials. The procedures are likely to differ from those used in the depot, e.g. surface preparation, heated blankets for curing.

Permanent repairs are made without extensive disassembly of the structure. **Paste** adhesives are preferred because of their simplified storage and curing processes.

17.1.4 Basic features of bonded repairs

Adhesive bonding is stiffer than riveting and fails at lower relative displacements between the joined parts. Consequently, closer attention is needed for bonded repairs than for conventional riveted types, including, Ref. [17-2]:

- Design detail,
- Load distribution,
- Damage tolerance,
- Environment, notably moisture,
- Surface preparation
- Bonding processes and procedures.

17.1.5 Objective of repair

17.1.5.1 General

According to the repair principles of the aircraft industry, which are based on FAA regulations, a repair to a structural part made of composite materials has to restore the ultimate design strength of the part for its remaining service life, Ref. [17-3].

Repairs are accomplished by applying either metal or composite patches to the damaged part.

17.1.5.2 Basic repair methods

Bonded composite repairs are very effective in extending the life of a cracked metal structure, Ref. [17-10].

The effect of moisture is an important factor in adhesive selection. Surface preparation is equally, if not more, important in obtaining an adequate bonded repair.

Bonding with selective riveting or bolting is also a viable repair method. The fasteners provide peel resistance and a fail-safe load path for the bonded repair, Ref. [17-2].

17.1.6 Materials

17.1.6.1 Parent adherend

The parent **adherend** is the material of the damaged component and can be either metal or composite alone or mixed materials, e.g. **honeycombs**, [See: 17.2].

17.1.6.2 Repair patch

A repair patch can be made of either metal or composite, [See: 17.3].

17.1.6.3 Adhesive

An adhesive is used for bonding the repair patch to the parent **adherend**, [See: 17.4].

17.1.7 Design

The same integrated materials selection and design approach applies to bonded repairs as that for structural bonding during manufacture. Therefore, the principles described for adhesive bonding are equally applicable, [See also: 7].

Table 14.01.1 provides some examples of material combinations for particular bonded repair applications, Ref. [17-1], [17-4], [17-5].

17.1.8 Quality assurance

Rigorous quality assurance procedures, [See: 14], are applied to control materials, processes and consumables, e.g. release films, bagging materials, [See also: 14.3].

Table 17.1-1 - Bonded repairs: Examples of applications and materials

Adherend [patch:substrate]	Adhesive [Supplier]	Application	Comments
Carbon/epoxy: composite	EA9330 [Loctite]	L-1011 vertical fin. repair of lightning strike damage	Bonding of pre-cured laminated patches
	Metlbond 329 [Cytec]		
Glass/epoxy: Kevlar/epoxy	EA9330 [Loctite]	AH-1 composite main rotor blade	Skin patch for small punctures and cuts. Plug patch for skin and core. V-shaped double patch for trailing edge.
	HP341 [Hexcel]		
Boron/epoxy: AU4SG Al alloy	AF126 [3M]	Mirage III. Lower wing skin fatigue cracks	AU4AG. French alloy similar to 2024-T6
Boron/epoxy: 7075-T6	AF 126 [3M]	Hercules wing planks. Stress corrosion cracks	-
-: Mg-alloy	-	Macchi landing wheel fatigue cracks	Bond durability remained a problem
-: 7075-T6	-	F111 console-truss stress corrosion cracks	-
Carbon/epoxy. Nomex core sandwich panels	-	Eurocopter, Ref. [17- 4]	Repairs to helicopter airframe structures. Brite- Euram 'Desir' project.
Glass/epoxy: Boron/epoxy	Metlbond 1113 [Cytec]	F-104 nosedome, Ref. [17-5]	Design- development study, practical implementation.

17.2 Parent adherends

17.2.1 Materials

Repairs are needed because of defects or damage occurring either during manufacturing or after routine inspection in service.

Components made from any of the common aerospace materials can be considered for bonded repairs at some point in their lives, i.e.:

- advanced composites, e.g. carbon, **aramid** and glass fibres combined with epoxy or other types of resin,
- metal alloys, e.g. aluminium, titanium.

[See: 5; ECSS documents: ECSS-E-HB-32-20]

17.2.2 Sandwich structures

Thin-skinned **honeycomb** core **sandwich** panels are used extensively in many types of aerospace structures. The thin skins, often made of composite, are susceptible to low-energy impact damage that can reduce strength and stiffness or expose the core.

Occurrences of damage to sandwich structures are fairly frequent because of their wide use and the fragility of the thin face skins.

17.3 Repair patches

17.3.1 Materials

17.3.1.1 General

Normally, the same types of materials described as **adherends** can be used as repair patches. Composite patches can be used to repair metal components and, to a lesser extent, metals to repair composites.

17.3.1.2 Selection factors

The choice of material for the patch depends on a number of factors, including:

- design loads of the component to be repaired,
- geometry of the component in damaged region,
- facilities and level of experience of the labour available to make the repair.

17.4 Adhesives

17.4.1 General

Several different types of adhesive are used within structural repairs, Ref. [17-1]:

- Structural,
- Splice,
- Fillers and mastics, although not classed as structural adhesives.
- Potting compounds.

[See also: [17-1]: MIL-HDBK-337 for lists of typical types of adhesives]

17.4.2 Structural

17.4.2.1 Film

Film (supported or unsupported versions) are used for:

- skin-to-skin bonds,
- skin-to-core bonds.

Film adhesives provide a more uniform bondline thickness and are generally easier to apply than paste adhesives. Their processing conditions mean that they are normally used in depot-level repairs.

17.4.2.2 Paste

Where accessibility is a problem, **paste** adhesives (filled or unfilled) with various cure temperatures, [See: Temperature factors], are used for:

- skin-to-skin bonds,
- skin-to-core bonds.

Depending on the particular product, they can be more tolerant of processing variations, e.g. **RT**-cure types can also be cured at a moderate temperature to reduce processing time, or vice versa.

17.4.3 Splice

Splice adhesives, which are usually **films** but can be **paste**, are foaming types that increase in volume from 50% to 200%, depending on cure conditions.

Some are compatible with structural adhesives, in that they can be co-cured at the same temperature. Their uses include:

- core-to-core,
- core-to-fitting.

17.4.4 Fillers and mastics

Although not structural adhesives, fillers and mastics are used to restore aerodynamic surfaces or to seal surfaces, e.g.

- Thixotropic two-part paste systems which cure at RT or moderate temperatures. They are used to fill dents and fissures in surfaces and can be machined after cure. They are considered to be adhesives because they adhere to the substrate.
- Two-part polymeric materials which cure at a variety of temperatures for various service uses, e.g. a barrier against the environment (fluid resistance, insulation, corrosion inhibiting) and provide aerodynamic smoothing.

17.4.5 Potting compounds

Potting materials comprise of a liquid resin adhesive combined with a filler phase, e.g. microballoons or powders. Cure is usually at RT or a moderate temperature. Their uses are mainly determined by viscosity, e.g.:

- Core filler, used to fill **honeycomb** cells locally, are thixotropic or moderately viscous (applied by spatula).
- Injectable, used to fill voids or honeycomb cells, and are low viscosity, two-part, moderate temperature or RT-cure systems.

17.4.6 Properties

17.4.6.1 General

The desired properties of an adhesive for repairs include:

- Mechanical properties (strength, toughness),
- Environmental durability,
- Processing characteristics,
- Temperature factors (cure and service temperatures).

17.4.6.2 Mechanical properties

The selection process that applies to bonded repairs is essentially the same as that for structural bonding, [See: 5], with special attention paid to the effects of, [See also: Temperature factors]:

- Adhesive cure temperature on properties,
- Maximum service temperature on properties.

17.4.6.3 Environmental durability

For some applications, such as repairs to external surfaces of aircraft, the environmental tolerance of adhesives, and especially hygrothermal effects, need rigorous attention.

When components are repaired after some period in service, the consideration extends to the tolerance of an adhesive to:

- Substances or contaminants on the parent adherend surface,

- The ability to prepare adherends, e.g. on-aircraft field repairs. This is related to whether repairs are depot- or field-implemented, [See: 17.1], hence, the availability of facilities and skilled labour.

17.4.6.4 Processing characteristics

Most adhesives used for repairs are selected from those for structural bonding that are available, known and well-documented. They are often described as 'repair adhesives' and possess characteristics that are suitable for depot level.

For field-level repairs, adhesive manufacturers have developed variants of structural adhesives, without loss of mechanical or environmental durability, which are more tolerant to processing variations, including, Ref. [17-6]:

- Surface preparation methods,
- **Bondline** thickness,
- Mix ratio,
- Cure factors: temperature, time, pressures,
- Storage conditions at RT.

17.4.6.5 Temperature factors

On the basis of cure temperature and upper service temperature, adhesives can be grouped as shown in Table 17.4-1, Ref. [17-1].

Table 17.4-1 - Repair adhesives types: Grouped by cure and service temperatures

Group	Typical cure temperature (°C)	Typical service temperature (°C)
I	RT	60 to 80
II	121	80
III	RT	177
IV	177	177
V	177	204

17.4.7 Repair adhesive selection factors

17.4.7.1 Aircraft industry

Some guidelines for adhesive selection with respect to cure and service temperatures, include Ref. [17-1], [17-7]:

- Maximum service temperature, where requirements are defined for the aircraft, i.e.:
 - temperature of ~80 °C: subsonic aircraft (transports); except around high heat areas and auxiliary power units (APU).
 - temperature of 177 °C to ~204 °C: supersonic aircraft (fighters and attack). Nacelle structures, Ref. [17-8], [17-9].

- Accelerated cure: Where possible, equivalent elevated temperature cure instructions are given for RT cure materials. These can be used where the repair schedule does not enable the longer RT cure,
- Reduced-temperature cure: Where possible, optional lower curing temperatures are provided for the elevated temperature cure materials. The use of a lower cure temperature can be desirable for:
 - local repairs, where it can be difficult to get the area up to temperature because heat is conducted into the surrounding structure, i.e. near a heavy metal fitting or heavy structure. Therefore an adhesive with a low minimum heat-up rate is needed.
 - local repair not fully supported on tooling: An adhesive with a cure temperature lower than that of the original adhesive is needed to avoid softening the surrounding adhesive. Generally, a difference in cure temperature of 10 °C between original and repair adhesive is advisable.
- Elevated cure adhesives are generally preferred to RT cure systems, as they are typically stronger and tougher and also have better environmental resistance,
- Appropriate service temperature: It is advisable not to use a higher service temperature adhesive (177 °C to 204 °C) where a 82 °C service temperature adhesive is sufficient. By increasing the service temperature, these adhesives typically have a lower peel strength and toughness,
- Matrix cure (composite adherends): Adhesives which cure at a temperature lower than that of the matrix resin are selected. This is to avoid damaging the composite adjacent to the repair during curing.

17.4.7.2 Space industry

The guidelines for selection of a repair adhesive used in the aircraft industry are also appropriate to space structures.

Repairs to space structures also need to consider the mandatory **outgassing** and **offgassing** requirements, [See: 7.6].

17.5 References

17.5.1 General

- [17-1] MIL HDBK 337: Adhesive Bonded Aerospace Structure Repair 1982
- [17-2] ECSS-E-HB-32-20: Structural materials handbook; previously ESA PSS-03-203
- [17-3] A.A. Baker & R. Jones (Editors)
'Bonded Repair of Aircraft Structures'
Martinus Nijhoff Publishers, 1987. ISBN 90-247-3606-4
- [17-4] K. Wolf & R. Schindler: Eurocopter Deutschland GmbH, G
'Repair Methods for CFRP Sandwich Structures'
Proceedings of 6th European Conference on Composite Materials
ECCM6, Bordeaux, France, 20-24 September 1994, p491- 496
- [17-5] C.L. Ong & S.B. Shen: Aeronautical Research Lab, Taiwan

- 'Repair of F-104 Aircraft Nosedome by Composite Patching'
Theoretical & Applied Fracture Mechanics 15, 1991, p75-83
- [17-6] M.J. Cichon: Hysol Aerospace Products, USA
'Repair Adhesives: Development Criteria for Field Level Conditions'
Proceedings of 34th International SAMPE Symposium
8-11 May, 1992, p1052-1066
- [17-7] R.F. Wegman & T.R. Tullos: Adhesion Associates, USA
'Adhesive Bonded Structural Repair: Pt. I -Materials & Processes,
Damage Assessment & Repair'
SAMPE Journal, Vol. 29, No.4, July/August 1993, p8-13
- [17-8] Dr. W. McGavel : Short Bros, UK
'Application of Composites'
ESA SP-336 (October 1992), p29-31
- [17-9] M.J. Curran & N.C. Eaton: Westlands Aerospace, UK
'Application of Advanced Materials to Aircraft Nacelle Structures'
ESA SP-336 (October 1992), p57-62
- [17-10] M.L. Overd
'Carbon Composite Repairs of Helicopter Metallic Primary Structures'
7th. International Conference on Composite Structure. Composite
Structures 25 (93), p557-565

17.5.2 ECSS documents

[See: [ECSS](#) website]

ECSS-E-HB-32-20 Structural materials handbook; previously
ESA PSS-03-203

18

Design of repairs

18.1 Introduction

18.1.1 Basic categories of repair

18.1.1.1 General

Repairs are categorised as:

- bonded only,
- bonded and bolted,
- bolted only.

18.1.1.2 Bonded only

The main reasons for using bonded repairs are similar to those of structural bonding, e.g.

- thin structures, e.g. less than 1 mm thick, are usually ideal for bonding,
- bonded joints can be much stronger than bolted joints in thin materials,
- dissimilar materials are suitable for adhesive bonding,
- reduces corrosion,
- seals joints,
- no fastener holes, which can weaken structures,
- reduces stress concentrations,
- produces a smooth surface finish.

Bonded repairs are applicable to space structures comprising:

- composite laminates and skins,
- metal skins,
- sandwich panels.

18.1.1.3 Bonded and bolted

A combined approach to repairs aims to combine the benefits of bonding and bolting, e.g. avoiding environmental degradation (bonding) in a joint between thick materials (bolted).

18.1.1.4 Bolted only

The main reasons for using bolted repairs are similar to those for mechanically fastening structural joints, e.g.

- bolted repairs are used on thick substrates, e.g. usually 10 mm or thicker,
- **peel** stresses are likely to cause a bonded-only repair to detach from the parent adherend.
- meticulous surface preparation is not necessary,
- ease of inspection,
- can be easily disassembled,
- high confidence is needed in the repair of a critical structure.

Space structures tend to use thin materials, so options to use bolted repairs are much lower than in aircraft-type structures.

18.1.2 General design concepts

18.1.2.1 Repair objective

The objective of a repair is to return the structure to its undamaged condition, such that it can support all the design loads for the intended service life.



The design of a repair depends greatly upon the particular component and the extent of the damage incurred, e.g. sandwich panel with one or both skins punctured. Accessibility is also a design factor.

Attempts to standardise design and repair procedures have been made, Ref. [18-1], [18-2], [18-3], [18-4], based on the:

- type of damaged component (laminate, **sandwich** structure with metal or composite skins),
- extent of the damage, as determined by pre-repair inspection (major, minor),
- role of the component (structural or non-structural).

Table 18.1-1 shows examples of basic repair concepts and comments on their application, Ref. [18-5].

Table 18.1-1 - Basic design concepts for repairs

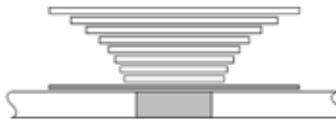
TYPE	CONCEPT	COMMENTS
Bonded and Bolted		<ul style="list-style-type: none"> • Metal patch can be used. • <u>Precured composite patch</u> can be used. • Special attention needed when drilling fastener holes.
Bolted External	<ul style="list-style-type: none"> • Used for <u>delamination critical parts</u>, e.g. skin to stringer. • Used to prevent peel of external bonded repair. 	<ul style="list-style-type: none"> • Metal patch can be used. • <u>Precured composite patch</u> can be used. • Special attention needed when drilling fastener holes. • Blind fasteners (used where access is limited) are considered to be TEMPORARY REPAIRS because of low pull-out strength. • Sealant needed between carbon composite and metal to avoid corrosion problems.
Sandwich Structures	Core not damaged.	• Repair concept same as for thin component, accessible from one side.
	Minor core damage.	• Use <u>microballoon filled resin paste</u> to repair core.
	Severe core damage.	• Replace core.
Flush		<ul style="list-style-type: none"> • Patch has same ply orientation as parent. • Strength recovery approx. 60% • Restores smooth surface of structure. • Drying of parent needed to maximise strength recovery. • Adhesive film used between parent and patch. • Cover plies used on top and bottom faces, if accessible. • Patch cured in place with heated blankets and vacuum bags.
Repair		<ul style="list-style-type: none"> • Strength recovery approx. 60% • Restores smooth surface of structure. • Drying of parent needed to maximise strength recovery. • Patch cured in place with heated blankets and vacuum bags. • Material is placed parallel to surface. • Concept used by Airbus Industries.
External Repair		<ul style="list-style-type: none"> • PRE-CURED PATCHES • Strength recovery approx. 25% to 60% • Drying of parent needed to maximise strength recovery. • Cure temperature affects final strength recovered. • Advisable for thin laminates, lightly loaded.
		<ul style="list-style-type: none"> • PATCHES CURED IN PLACE • As above.

18.1.3 Composite repair design concepts

18.1.3.1 General

Based on experience of repairing of aircraft composite structures, some established repair approaches are summarised, Ref. [18-8].

To prevent damaging composite materials and repair patches, all drilling and fastener installation processes need the same stringent control as those used in manufacturing.

18.1.3.2 Cosmetic and temporary repairs

Superficial, non-structural repairs use a filler material, e.g. thickened resin only, to restore surfaces and prevent fluid incursion until permanent repairs can be made. Cosmetic or temporary repairs do not restore strength in a composite part, so are only used when load-bearing is not a concern. High shrinkage of fillers can result in their cracking after an aircraft returns to service.

18.1.3.3 Resin injection repairs

Resin injection can be used when delamination is limited to a single ply; often a fabric ply in aircraft. Resin injection does not restore strength, so is generally considered as a temporary measure that can slow the spread of delamination. A main benefit of resin injection is that it is economical.

18.1.3.4 Semi-structural plug and patch repairs

Plugs and patches made with either mechanically-fastened or adhesively-bonded doublers provide repairs offering some strength. These repairs are particularly effective with thick laminates or when inserts are used to carry bolt loads.

18.1.3.5 Structural mechanically-fastened doublers

Fully structural repairs with bolted doublers can be used in highly-loaded laminates. The additional layers of reinforcement produce added stiffness or strength. In practice, it is often the only practical means of repairing such structures. The repairs are not smooth, so can disrupt aerodynamics or affect the radar signature. The original damage is not removed, so the repair aims to transfer loads around the damaged section. The doublers also create stress concentrations at their corners and edges.

18.1.3.6 Structural bonded external doubler

Bonded external doublers are often used to perform repairs on lightly-loaded, thin laminate structures. This type of repair is usually achieved by wet lay-up of materials designed for room-temperature or high-temperature use. Bonded doublers restore a significant proportion of the original composite strength, although the stiffness can be significantly reduced. Compared with flush repairs, they are easier to implement.

18.1.3.7 Structural flush repairs

Flush repairs restore the structural properties of the composite by forming a joint between the prepared repair area and the repair patch. The patch is installed after all the damage is removed. Each ply of the laminate is replaced with the same, or a comparable, material. The size of the repair

patch exactly fits the area prepared for the repair. An oversized, cosmetic layer is added that, after sanding, provides a smooth external surface.

18.1.4 Sandwich panels, laminates and sheet metal

The materials and processes used to repair **sandwich** panels, bonded sheet metal and bonded composite assemblies are fairly standard. Each manufacturer has repair documents, also known as technical orders, detailing their preferred procedures, Ref. [18-7].

Structural joint design principles are a good basis for designing most bonded repairs, [See: 10].

18.1.5 Cracked metal components

The design approach for the repair of cracked metallic components tends to vary more between organisations. The techniques used for these repairs are a combination of experimental and analytical studies; often using finite element and other mathematical modelling tools. One reason for this is that cracks are often located in areas of the aircraft having complicated geometries, associated with fasteners or a combination of bolting and bonding. Consequently each bonded repair tends to be unique and needs an extensive evaluation exercise, Ref. [18-4]. [See also: 18.5]

18.2 Concepts for laminates

18.2.1 General

The aim is to remove damaged material and replace it with either the same material or another which has:

- sufficient stiffness and strength,
- compatibility with the adherend, both mechanically and chemically.

This can be achieved by:

- Flush repairs, where the replacement material is tailored to the existing laminated structure.
- External repairs, where a patch is applied over the damaged area.

18.2.2 Flush repairs

Flush repairs are applied to thick laminates comprising of a large number of plies, e.g. more than 10. They are not used for thin laminates, such as **honeycomb** skins, [See also: Table 18.5-1].

Factors to consider include:

- careful machining is needed to remove the damage from the laminate without creating further damage around the zone,
- design of prepreg lay-up to be compatible with the **adherend** lay-up, e.g. ply orientation, lay-up order.

18.2.3 External repairs

External patches are applied over the damage zone after some level of damage removal and surface preparation. External patches are used on the majority of thin laminates, including **sandwich** panel skins.

The patches can be made of, [See also: Table 18.5-1]:

- plies of prepreg laid up on top of an adhesive film, which are subsequently **co-cured** and bonded,
- plies of cured prepreg laid up with alternating layers of adhesive film, which are bonded in place,
- a pre-cured composite patch bonded with adhesive film to the laminate.

Composite patches are applied to both composite and metal **adherends**, whereas metal patches are normally only applied to metal adherends.

18.3 Concepts for sandwich panels

18.3.1 Repair objectives

The objective of a **sandwich** panel repair is to restore the skins, replace the damaged **honeycomb** core and the bonding between core and skins, such that the mechanical and environmental resistance is returned to the expected design levels.

The type and extent of damage to sandwich panels varies widely, e.g. from a surface dent in one skin, to perforation of both skins with the honeycomb core between destroyed. Consequently, the design of repairs for sandwich panels can be fairly simple or need a number of stages, Ref. [18-3]. Accessibility to one or both sides of the damaged sandwich panel also affects the design of a repair.

Figure 18.3-1 shows repair concepts for single-side and both-side access of sandwich panels with severe damage to their honeycomb core, Ref. [18-5].

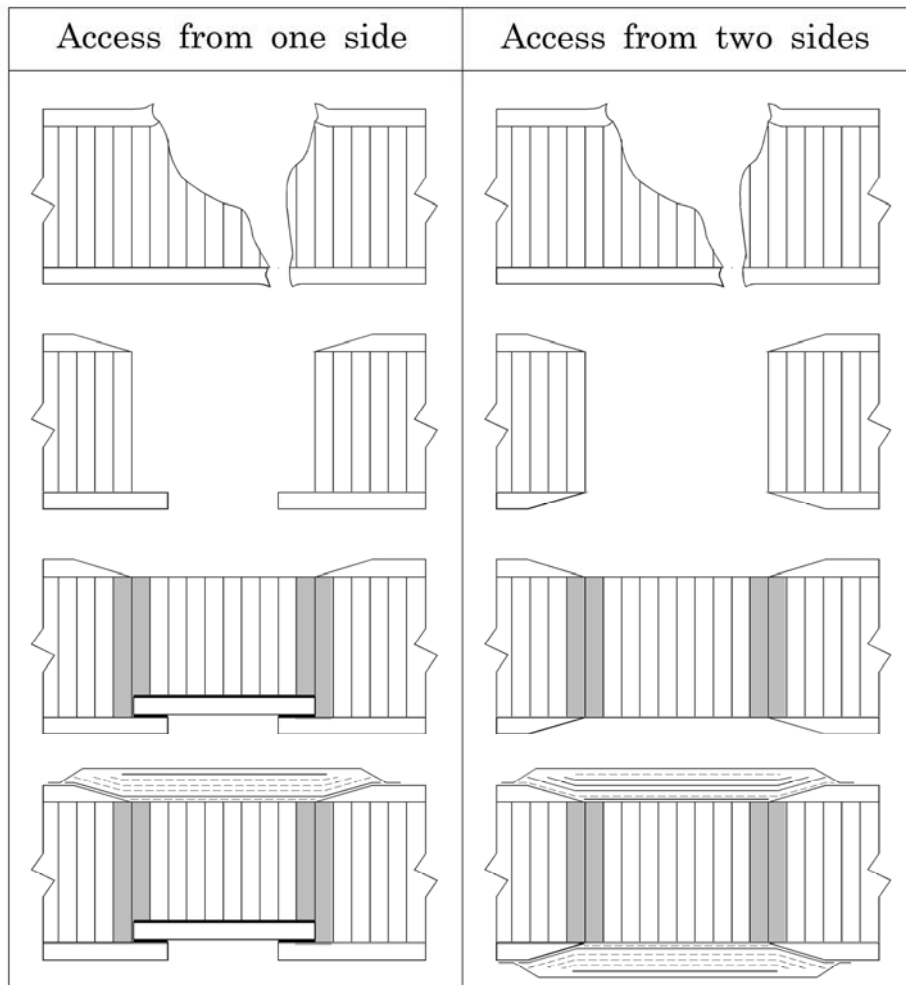

Figure 18.3-1 - Sandwich panel repair concepts

18.3.2 Field level repairs

In addition to the basic demand of restoring strength, stiffness and durability, field repair design need to be optimised for, Ref. [18-6]:

- minimum time, expense and effort,
- no special tools necessary,
- capability of on-aircraft repair,
- low skill level.

Figure 18.3-2 shows three concepts developed for evaluation for helicopter structural **sandwich** panels, Ref. [18-6].

Table 18.3-1 compares the concepts after initial evaluation of mechanical performance, Ref. [18-6].

Environmental studies established if the preferred option 'RS3' performed adequately, Ref. [18-6].

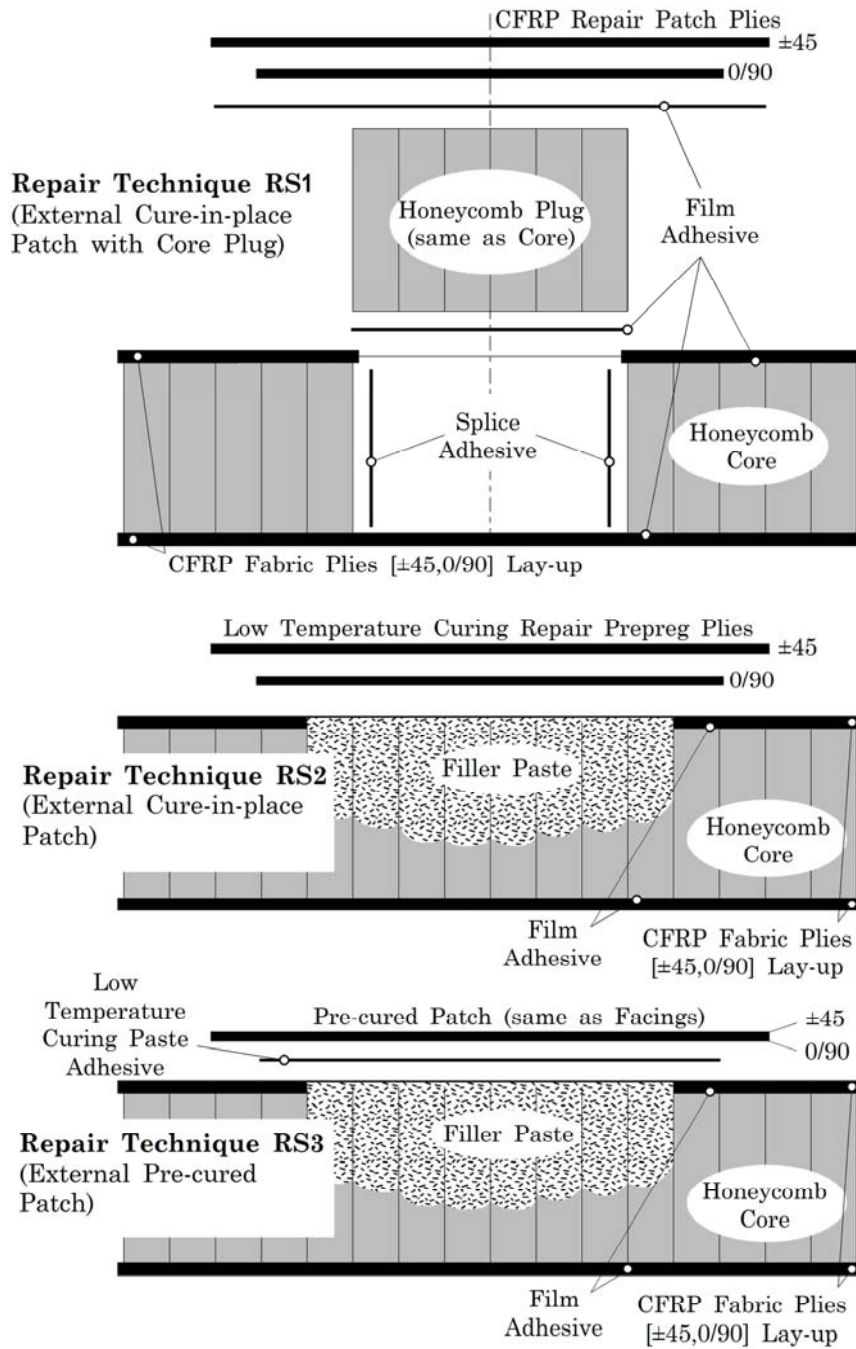

Figure 18.3-2 - Field level sandwich panel repair concepts

Table 18.3-1 - Field level sandwich panel repairs: Comparison of design concepts

Equipment	Repair concept		
	[See also: Figure 18.3-2]		
	RS1	RS2	RS3
	Autoclave, vacuum	Heater lamp or blanket, vacuum	Heater lamp or blanket, vacuum
Personnel skill	100%	~80%	~60%
Repair time (without curing)	100%	~70%	~50%
Cure time	100%†	400%†	200%†
	100%‡	100%‡	50%‡
Cure temperature	100%†	74%†	48%†
	100%‡	68%‡	51%‡
Cure pressure	3† bar	vacuum	vacuum
	4‡ bar		
Restored compressive strength	100.2%†	96.4%†	99.4%†
	98.5%‡	99.5%‡	105.7%‡
Key: † Material 1: 125 °C cure fabric prepreg ‡ Material 2: 175 °C cure			

18.4 Design parameters: Thin skin constructions

18.4.1 Design principles

18.4.1.1 General

Bonded joint principles and procedures are appropriate for this type of bonded repair, [See: 10].

18.4.1.2 Overlap guidelines

Figure 18.4-1 summarises the design parameters, Ref. [18-7]. These are single lap joints with support from the core. As a first estimation only, overlap sizes are determined by:

- unsupported single-lap joints, where overlap (l) is 80 times the central skin thickness (t_1),
- double-lap joints, where overlap (l) is 30 times the central skin thickness (t_1),
- **honeycomb** panel facing sheets, where overlap (l) is 50 to 60 times the skin thickness (t_1).

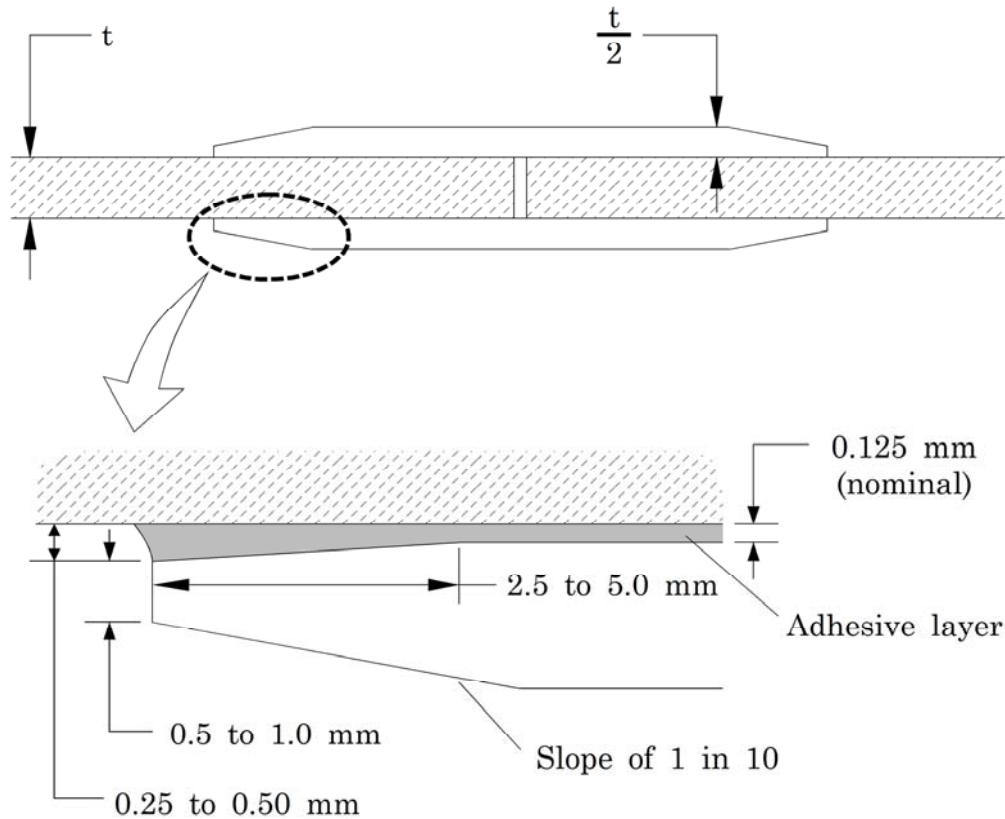

Central sheet thickness, t_1 (mm)	1.02	1.27	1.60	1.80	2.03	2.29	2.54	3.18
Splice sheet thickness, t_0 (mm)	0.64	0.81	1.02	1.02	1.27	1.27	1.60	1.80
Recommended overlap ¹ , l (mm)	30.7	36.1	42.7	46.7	51.1	55.9	60.7	72.1
Strength of 2024-T3 Al-alloy (MPa)	456	570	719	810	913	1027	1141	1426
Potential ultimate bond strength (MPa) ^{2,3}	1352	1503	1690	1844	1911	2053	2133	2442

- 1 Based on 71 °C dry or 60 °C/100 % RH properties needing longest overlap. Values apply for tensile or compressive in-plane loading. For in-plane shear loading, slightly different lengths apply.
- 2 Based on -45 °C properties giving lowest joint strength and assuming taper of outer splice straps thicker than 1.27 mm strength values corrected for adherend stiffness imbalance.
- 3 For nominal adhesive thickness, $\eta = 0.127$ mm for other thicknesses. Modify strengths in ratio $(\eta/0.005)^{1/2}$.

Figure 18.4-1 - Design parameters: Thin skin constructions

18.4.1.3 Adhesive types

The overlaps, as given in Figure 18.4-1 and approximated in the guidelines are applicable to:

- most ductile structural adhesives,
- most brittle high-temperature structural adhesives (but are conservative),
- adhesives cured at room temperature and limited to a lower service temperature.

Where the overlap length is limited because of inadequate space, a brittle high -temperature structural adhesive can be appropriate, but the maximum thickness of **adherends** to be bonded is reduced.

18.5 Design parameters: Crack patching metals

18.5.1 Principles

Several analytical and modelling approaches have been developed to aid design of repairs to cracked metal components. These are in addition to experimental evaluation and assessment. Table 18.5-1 summarises the design input parameters for crack patching, Ref. [18-7].

Table 18.5-1 - Design parameters: Crack patching metal components

Parameter	Comments
CRACKED METAL COMPONENT	
<ol style="list-style-type: none"> 1. Thickness 2. Modulus 3. Length of longest available (permissible) overlap length perpendicular to the crack which can be covered by the patch. 4. Patch width 5. Magnitude of peak cyclic stress normal and parallel to crack 6. Ration of peak cyclic stress to minimum stress (both normal to crack) 7. Coefficient of thermal expansion 8. Level of restraint offered by rigid substructure 9. Operating temperature 10. Operating environment 11. Crack size 	<p>To assess the effectiveness of repair, representative data is needed for:</p> <ul style="list-style-type: none"> • rate of crack growth as a function of cyclic stress intensity, • crack growth retardation effects, and influence on stress ratio (point 6)
PATCH	
<ol style="list-style-type: none"> 1. Tensile modulus 2. Shear modulus 3. Thickness per ply 4. Allowable tensile strain WITH strain concentration effects 5. Co-efficient of expansion 	<p>Point 2 can show environmental sensitivity, e.g. temperature and moisture.</p>
ADHESIVE	
<ol style="list-style-type: none"> 1. Thickness 2. Effective shear modulus 3. Effective Yield Shear stress 4. Allowable cyclic strain for various levels of durability. 5. Cure temperature 	<p>Point 2, 3 and 4 are sensitive to the environment, e.g. temperature, moisture and loading rate. Environmental effects cannot be ignored.</p>

18.6 References

18.6.1 General

- [18-1] R.F. Wegman & T.R. Tullos: Adhesion Associates, USA
'Adhesive Bonded Structural Repair: Pt. I -Materials & Processes, Damage Assessment & Repair'
SAMPE Journal, Vol. 29, No.4, July/August 1993, p8-13
- [18-2] R.F. Wegman & T.R. Tullos: Adhesion Associates, USA
'Adhesive Bonded Structural Repair: Pt. II -Surface Preparation Procedures, Tools, Equipment & Facilities'
SAMPE Journal, Vol. 29, No.5, Sept./Oct. 1993, p8-13
- [18-3] R.F. Wegman & T.R. Tullos: Adhesion Associates, USA
'Adhesive Bonded Structural Repair: Pt. III -Repair of Composite, Honeycomb Cored and Solid Cored Structures'
SAMPE Journal, Vol. 29, No.5, Nov./Dec. 1993, p8-12
- [18-4] MIL-HDBK-337: Adhesive Bonded Aerospace Structure Repair 1982
- [18-5] ECSS-E-HB-32-20: Structural materials handbook; previously ESA PSS-03-203
- [18-6] K. Wolf & R. Schindler: Eurocopter Deutschland GmbH, G
'Repair Methods for CFRP Sandwich Structures'
Proceedings of 6th European Conference on Composite Materials ECCM6, Bordeaux, France, 20-24 September 1994, p491- 496
- [18-7] A.A. Baker & R. Jones (Editors)
'Bonded Repair of Aircraft Structures'
Martinus Nijhoff Publishers, 1987. ISBN 90-247-3606-4
- [18-8] M.J. Hoke
'Composite Repair Techniques'
Flightline: Vantico Technical Newsletter on Aircraft Adhesives and Syntactics
Volume 3, Number 1, First Quarter, 2003

18.6.2 ECSS documents

[See: [ECSS website](#)]

ECSS-E-HB-32-20	Structural materials handbook; previously ESA PSS-03-203
-----------------	---

19

Repair techniques

19.1 Introduction

The integrity of a bonded repair depends upon:

- locating and removing damaged material,
- proper surface preparation of, [See: 19.2]:
 - damaged component (parent adherend).
 - repair patch.
- proper positioning of repair materials, e.g. core plugs, fillers, adhesives and patches, [See: 19.3],
- proper consolidation and cure of adhesives and patch (for composites), [See: 19.4].

A number of techniques have been developed to enable repair patches to be applied successfully to damaged composite and metal parts. Some have become standardised procedures, Ref. [19-1], [19-2], [19-3], [19-4].

Procedures vary for repairs made at depot or field level, [See: 17.1], largely because the available facilities and skill levels are different. In general, on-aircraft repairs are made at field level, whereas operations needing major disassembly are completed at depot level.

19.2 Surface preparation

19.2.1 General

Surface preparation is needed for both the:

- damaged component, i.e.:
 - Paint removal.
 - Adherend (Metal adherends: Tank processes or Composite adherends).
- repair patch, i.e.
 - pre-cured composite patch.
 - metal patch.

The processes used for structural bonding are applicable for bonded repairs, [See: 12]. Some techniques are modified for repairs made without disassembly of the structure, e.g. Metal adherends: Non-tank processes using gelled reagents to prevent drip or flow onto adjacent surfaces. Processes using solvents and chromium-containing reagents are under review regarding their conformity with environmental legislation, [See: 12.4].

Table 19.2-1 summarises processes used for various adherends.

Table 19.2-1 - Bonded repairs: Surface preparation

Adherend	Process	Comments
Composite	Peel ply Surface abrasion Surface erosion	For precured patches, care is needed to ensure the surface is not too rough, causing voidage in bondline. Use silicon carbide papers or pads. Suitable for patch and substrate.
Aluminium alloys	PAA - Phosphoric acid anodise	Tank process, needing removal and immersion of adherends to be repaired. [See: 12.4].
	PACS - Phosphoric acid containment system process (see 19.2.6.3)	Non tank version of PAA in which the electrolyte is contained. [See Figure 19.2-2:]
	PANTA - Phosphoric acid non tank anodising process (see 19.2.6.2)	Non tank process. Uses thixotropic agent to gel electrolyte. Used on vertical and undersurfaces of components, does not require their removal. [See: Figure 19.2-1]
	Barium sulphate-thickened FPL Forest Products Lab	Barium sulphate-thickening agent. Highly corrosive and toxic. Process temp. 66 °C. Not advisable because of difficulty in removing electrolyte.
Titanium alloys	Modified PAA treatment	-

19.2.2 Guidelines

Adhesion is affected by the surface condition of the adherends and the environment in which the bond functions. Guidelines for surface preparation include, Ref. [19-2]:

- knowledge of the adherend materials is needed, including the fabrication route and surface condition,
- careful handling and use of solvents, to avoid solvent attack of near-by surfaces or health effects for the user,
- beware of contamination and only wipe parts with clean cotton cloths without sizing or finishing. Likewise paper towels with low or no organic binders. Synthetic cloths cannot be used
- hot solvent washing or vapour degreasing cannot be used to clean composite materials, or for secondary bonding preparations,
- regular quality control of cleaning or chemical baths,

- cleanliness, vigilance and attention to process details are very important,
- follow the process procedures and never modify temperatures and times without authorisation.

19.2.3 Paint removal

19.2.3.1 Solvent

Paint on metal surfaces can normally be removed using MEK methyl-ethyl-ketone, Ref. [19-2]. For composites, the use of solvents can damage the adherend, therefore alternative methods are used.

Health and safety regulations are imposed on the use of MEK.

19.2.3.2 Sanding

Paint removal techniques vary with the adherend material, general guidelines include:

- metals, make use of 80 to 100 grit paper, followed by light sanding with 400 grit papers, but avoid abrading the adherend, especially clad thin skins,
- composites, lightly sand with 400 grit paper, but avoid abrading the adherend and exposing the fibres.

19.2.3.3 Grit or plastic media blasting

Grit-blasting, using a variety of abrasive media, is sometimes used on both metal and composite components. This process is not appropriate for aramid composites or transparent engineering plastics. Damage to the composite **adherend** needs to be prevented.

19.2.4 Composite adherends

19.2.4.1 General

The preparation of composite faying surfaces is a crucial step in the adhesive bonding process because correct preparation largely determines the success or failure of a bonded repair.

Chemical treatments are not used, preparation is by mechanical abrasion, machining, sanding or grinding, [See: Table 19.2-1].

Glass and carbon composites can be prepared with conventional tools and abrasives, whereas **aramid** fibre composites need special tools.

19.2.4.2 Abrasion procedure

An example procedure:

- remove paint,
- wipe with solvent,
- abrade surface lightly (180 or other specified grit paper),
- remove dust and debris by vacuum suction,
- protect the surface with wax-free paper until the assembly is bonded.

19.2.5 Metal adherends: Tank processes

These are used where damaged metal components can be removed from the structure and immersed in a chemical bath.

The processes are the same as those used for initial structural bonds, [See: 12; Table 19.2-1].

19.2.6 Metal adherends: Non-tank processes

19.2.6.1 General

Non-tank processes are used when a repair is made on the structure, usually without major disassembly, e.g. aircraft skins.

19.2.6.2 PANTA - Phosphoric acid non tank anodising process

Modified electro-chemical processes have been developed for 'localised' surface preparation.

The PANTA process, as shown in Figure 19.2-1, uses an inert 'filler' agent mixed with chemicals to produce a thixotropic or gelled electrolyte. This is more handleable for preparing vertical or 'underneath' surfaces.

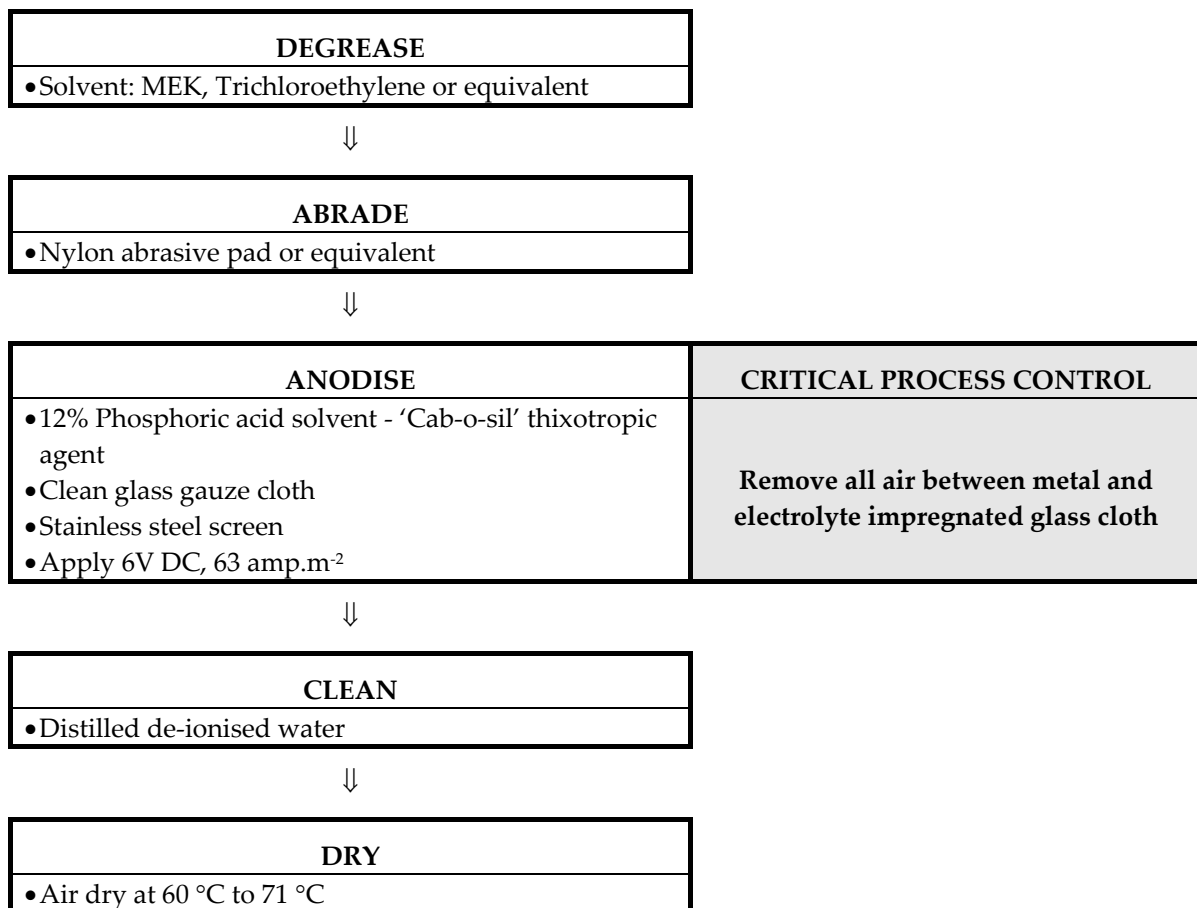

Figure 19.2-1 - Surface preparation for repairs to aluminium alloys: PANTA process

19.2.6.3 PACS - Phosphoric acid containment system process

This is a development of the Boeing PAA process, [See also: 12.4]. As the name suggests, the electrolyte is contained to prevent it contaminating nearby surfaces. Figure 19.2-2 shows the PACS assembly, Ref. [19-2].

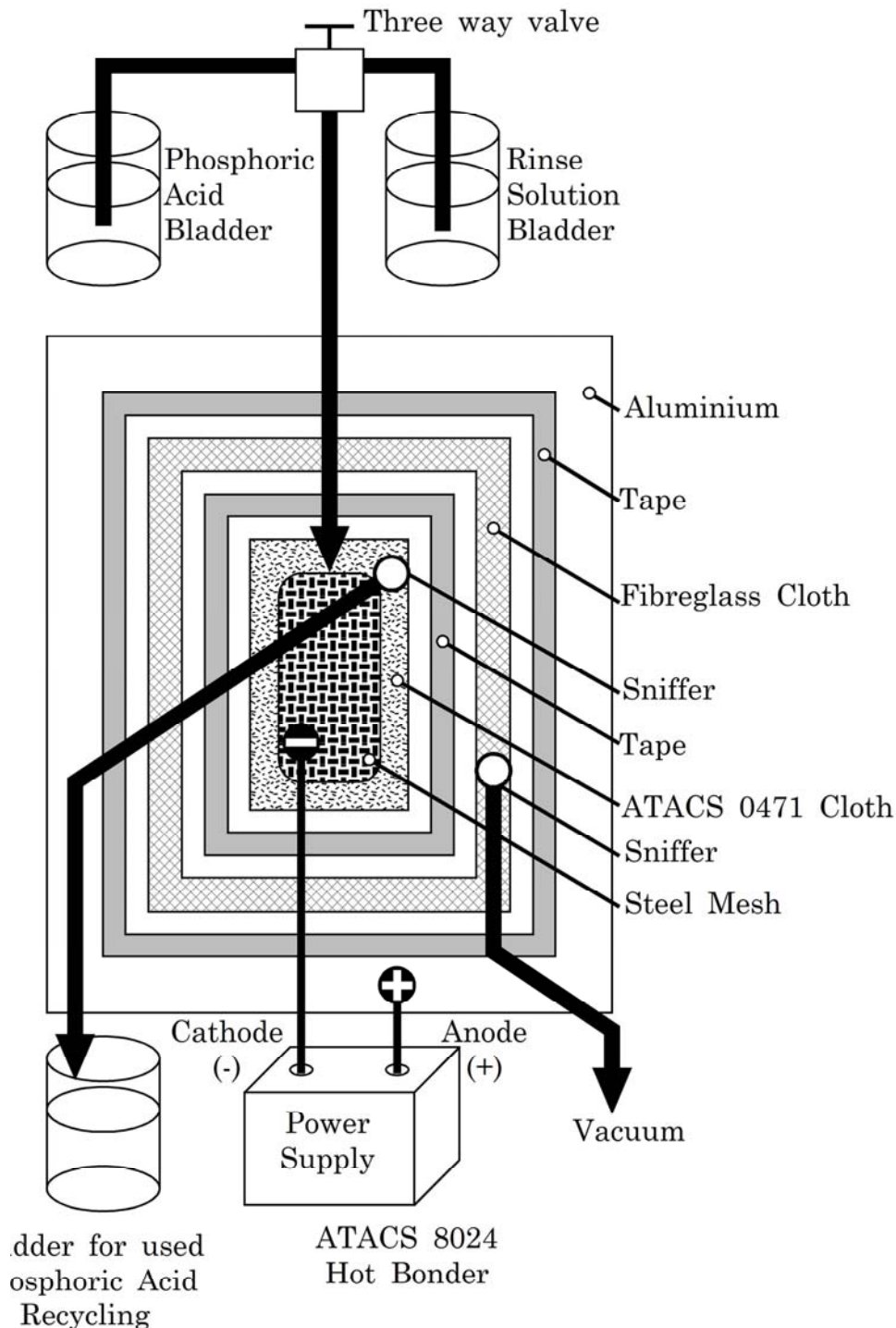

Figure 19.2-2 - Surface preparation for repairs to aluminium alloys: PACS process equipment set-up

A study to compare the PACS performance with that of the PAA (tank process) concluded that, Ref. [19-5]:

- the process produced similar surface oxide layers, but with a finer morphology,
- bond performance (wedge test) was acceptable except for those samples anodised at 38 °C (100 °F), which showed unacceptable crack growth,
- the ease of use was improved.

As with all phosphoric acid anodising processes, a primer is used prior to bonding to protect the fragile oxide layer.

19.2.7 Use of chemical processes

All chemical preparation methods need rigorous removal of chemical residues after the process is completed. This is of particular importance where the repair site is close to fasteners or crevices, which trap chemicals that can cause corrosive damage.

Strict regulations relating to the safe handling and disposal of chemicals are imposed.

19.3 Repair procedures

19.3.1 Basic methods

The various techniques developed for bonded repairs are grouped as:

- **co-cure**,
- secondary bonding,
- wet lay-up.

Co-cure and secondary bonding techniques are appropriate for permanent bonded repairs at depot or field level.

Wet lay-up methods were developed mainly for temporary battle damage repairs to military aircraft, although some sandwich panel repair procedures also use wet-lay up.

Table 19.3-1 describes the method and applications of each of these groups.

Table 19.3-1 - Basic methods for bonded repairs

Application	Process	Comments
Co-cure		
Composite repair patch to metal or composite adherend.	<ul style="list-style-type: none"> • Prepreg plies applied. • Adhesive and composite patch cured in a single cure cycle. • Film adhesives used. 	<ul style="list-style-type: none"> • Compatible cure conditions for adhesive and patch matrix. • Cure temperature cannot be detrimental to a composite adherend. • Composite adherend needs drying prior to bonding (reduce moisture content). • Cure temperature cannot induce severe residual loading to metal adherend after cooling.
Secondary bonding		
Precured composite and metal patches to metal or composite adherend.	<ul style="list-style-type: none"> • Precured composite or metal patch applied and adhesive cured. • Paste and film adhesives used. 	<ul style="list-style-type: none"> • Adhesive cure cannot be detrimental to composite matrix (patch or adherend). • Composites need drying before bonding (reduce moisture).
Wet lay-up		
Composite repair patch.	<ul style="list-style-type: none"> • Fabric plies, resin impregnated and often applied directly to adherend surfaces. 	<ul style="list-style-type: none"> • Non-permanent repairs of laminates for environmental barriers only. • Poor structural performance because of high matrix content of patch. • Used for sandwich panel skin repairs.

19.3.2 Standard procedures

In addition to those procedures dictated in the relevant aircraft documentation, repair procedures for laminates, sheet metal and sandwich panels have been standardised, Ref. [19-1], [19-2], [19-3], [19-4]. These standards contain the step-by-step instructions for making repairs to a variety of materials with a range of levels of damage.

19.3.3 Example: Sandwich panel repair

19.3.3.1 Application

A description of a **sandwich** panel repair is given in full to show the level of detail needed, Ref. [19-3]. It describes the repair of composite faced structure containing major core damage with a hole in one skin only. In this case, the damage is too large to repair with an adhesive plug, and needs replacement of the core. The repair method, as shown in Figure 19.3-1, uses wet lay-up of patch material. Other procedures use prepreg patches; precured or **B-stage**.

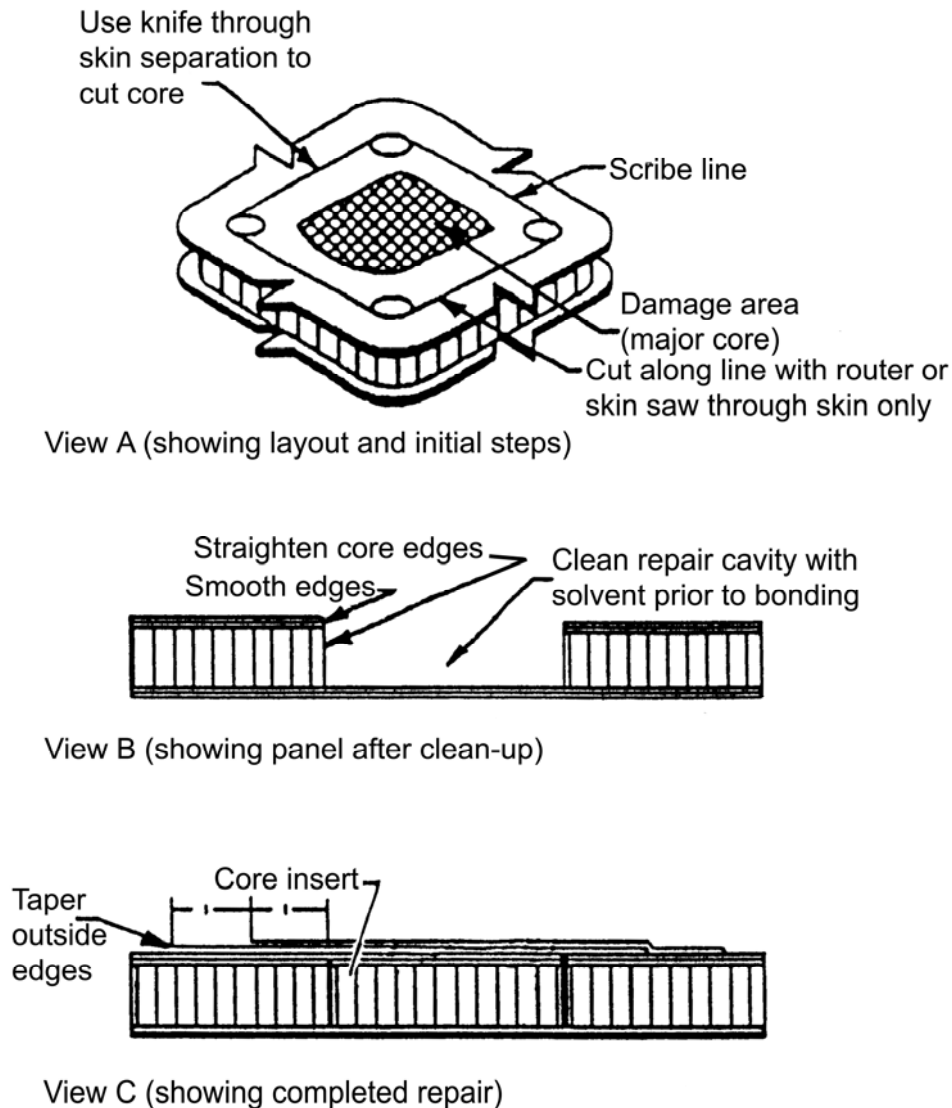

Figure 19.3-1 – Example: Sandwich panel repair procedure

19.3.3.2 Repair method

cover the damage with a solvent resistant pressure-sensitive tape,

mask off an area about 100 mm larger on all sides than the area to be repaired,

clean the masked off area with a trichloroethane dampened clean white cloth and remove any paint by means of an appropriate method,

using a scribe, lay out the skin and core area to be removed. The layout area should have about 3 mm radius corners, and the scribe marks cannot extend beyond the radii, [See: Figure 16.03.1 View A],

drill four holes of diameter $>6.3\text{mm}$ on the corners of the layout, being careful not to drill into the bottom skin,

cut the skin between the holes using an appropriate tool, e.g. a skin saw, sharp knife. A special tool can be needed for cutting some advanced composite skins, e.g. aramid composites. A depth control is used on power tools to protect the core while cutting the skin

cut through the core with a sharp knife to the opposite skin, following the cut in the skin,

remove the damaged skin,

remove and clean out the affected honeycomb core, [See: Figure 16.03.1 View B]. Needle-nosed and duck-billed pliers are useful for this purpose. After removal of the core, the hexagon impressions are removed from the adhesive on the bottom skin. The adhesive need not be removed if it does not peel from the skin. Rotary files, wire brushes or sanding discs can be used to remove the adhesive if it is necessary to do so. Excessive pressure on the bottom skin causes delamination,

smooth all sharp edges in the top skin with a file or suitable grinder,

make a replacement core insert from equivalent material to fit the removed section. Keep the core ribbon direction the same as the original core,

clean the honeycomb core and the cavity with trichloro-ethane and dry with clean, dry, oil-free compressed air,

mix the repair adhesive in accordance with the manufacturers' instructions. For large depot repairs, a structural film adhesive and a core splice adhesive can be used

apply the adhesive to the sides and bottom of the cavity. Place the core insert in position and fill all open areas in the bondline with adhesive,

apply vacuum bag pressure and cure in accordance with adhesive manufacturers' instructions. Remove the bag,

cut a glass cloth insert the same size as the core insert and of the same number of plies as the original skin,

mix the laminating adhesive in accordance with the manufacturers' instructions,

impregnate the plies of glass cloth and position them over the core insert. If possible, attempt to maintain the original orientation,

add two more plies of impregnated glass cloth so that the first overlaps the repair by about 25 mm on all sides. The second overlaps the first by about 25 mm on all sides. [See: Figure 16.03.1 View C].

cover the repair with a release film material and then with an aluminium plate (about 3 mm thick) and which is about 6 mm larger than the last ply. Apply the vacuum bag and cure in accordance with the adhesive manufacturers' instructions,

remove the bag and sand the repair to obtain a smooth surface and feathered edges,

paint, as necessary.

19.4 Equipment

19.4.1 Tools

Various tools are needed for structural repairs, e.g.:

- metal working tools used for sheet and honeycombs,
- cutting prepreg and fabric,
- machining composite laminates.

19.4.2 Process equipment

The process equipment needed for bonded repairs is similar to that used for producing structural bonds, [See: 13], along with some modified units for local repairs.

19.4.3 Hot bonding equipment

Process equipment for hot bonding includes:

- controllers, with temperature monitoring and vacuum source. Either as a combined unit or separate. Depending on the sophistication, heat-up rate, dwell time and sometimes cooling rate can be programmed,
- heater blankets, normally silicone rubber sheets or pads with embedded electrical heating elements of various sizes. The blanket is about 50 mm larger than the repair area. Typical power is about 2 W cm^{-2} ,
- vacuum equipment, with valves, base plates and tables,
- autoclave (Depot level repairs): The size and control equipment depend on the type of repair and the component dimensions,
- cure ovens (Depot level or some field repairs): The size and control equipment depend on the type of repair and component dimensions,
- vacuum bagging, with various consumables and tooling are needed to seal a repair area in an impervious plastic film during the cure cycle; either on the structure or when removed and placed in an autoclave or oven for curing. Some adhesives, notably films, need elevated temperature and pressure applied during cure. Vacuum bagging can provide a local area subjected to a pressure of 0.1 MPa (15 psi) whilst being heated.

19.4.4 Facilities

Controlled atmospheres and 'clean room' conditions for the working area are normally stipulated.

19.4.5 Selection of equipment

Table 19.4-1 summarises factors involved in the selection and use of equipment for bonded repairs, Ref. [19-6]. The comments apply to epoxy-based adhesives.

Higher-temperature adhesives need equipment capable of achieving temperatures approaching 400 °C for post-curing. These adhesives are only appropriate for adherend materials that are capable of withstanding the processing temperatures without degrading.

Table 19.4-1 - Use of equipment for bonded repairs

Equipment	Comments
Surface preparation	[See: 19.2]
Adhesive application	[See: 13]
Cure: Paste adhesives †	
Paste adhesives (1- and 2-part) usually cure at less than 100 °C and need only a low pressure to maintain positioning of patch to adherend.	
Positioning jigs	Locate and retain patch and adherend.
Cure: Film adhesives †	
Most film adhesives need temperatures of 120 °C to 170 °C with pressures of 100 kNm ² to 350 kNm ² to achieve proper consolidation and cure.	
Heater lamps	Radiant heat from lamps positioned in repair zone.
Heater pads and blankets	Placed over patch, often combined with vacuum bag.
Hydraulic rams	Pressure applied cannot deform the adherend.
Screw jacks	<ul style="list-style-type: none"> • Even pressure needed over bond area. • Complicated jigs are often necessary for complex geometry parts.
Vacuum bag	Nominal pressure: 100kN m ⁻² . Care is needed to ensure: <ul style="list-style-type: none"> • removal of air in bag, especially for complex geometries which can trap air, moisture and solvents • air and contaminants do not enter the bag. • fasteners are sealed with a non-corrosive compound.
†: Epoxy adhesives. Manufacturers' provide detailed cure schedules. Higher-temperature curing adhesives need different equipment, [See: 19.4].	

19.5 References

19.5.1 General

- [19-1] R.F. Wegman & T.R. Tullos: Adhesion Associates, USA
 'Adhesive Bonded Structural Repair: Pt. I -Materials and Processes, Damage Assessment and Repair'
 SAMPE Journal, Vol. 29, No.4, July/August 1993, p8-13
- [19-2] R.F. Wegman & T.R. Tullos: Adhesion Associates, USA
 'Adhesive Bonded Structural Repair: Pt. II - Surface Preparation Procedures, Tools, Equipment & Facilities'
 SAMPE Journal, Vol. 29, No.5, Sept./Oct. 1993, p8-13
- [19-3] R.F. Wegman & T.R. Tullos: Adhesion Associates, USA
 'Adhesive Bonded Structural Repair: Pt. III - Repair of Composite, Honeycomb Cored and Solid Cored Structures'
 SAMPE Journal, Vol. 29, No.5, Nov./Dec. 1993, p8-12

- [19-4] MIL-HDBK-337: Adhesive Bonded Aerospace Structure Repair 1982
- [19-5] S.S. Saliba: Uni. Dayton Research Institute, USA
'Phosphoric Acid Containment System (PACS) Evaluation for On-aircraft Anodization of Aluminium Surfaces'
Proceedings of 38th International SAMPE Symposium
10-13 May 1993, p1211-1223
- [19-6] A.A. Baker & R. Jones (Editors)
'Bonded Repairs for Aircraft Structures'
Martinus Nijhoff Publishers, 1987. ISBN 90-247-3606-4

20

Test and inspection of repairs

20.1 Introduction

20.1.1 Testing

The techniques used for testing repairs are the same methods described for testing structural bonds, [See also: 15]. This applies to [See: 20.2]:

- Adhesive acceptance tests,
- Tests on samples which simulate repaired items (design verification).

20.1.2 Inspection

20.1.2.1 Pre-repair

Pre-repair inspection determines and quantifies the extent of damage, [See: 20.4].

20.1.2.2 Post-repair

Post-repair inspection establishes that the repair is properly bonded and that no further damage has been caused by the repair process, in particular by the curing of the adhesives, [See: 20.5].

20.1.2.3 NDT methods

The non-destructive testing methods used are based on those used for structural bonds, [See: 16], but can be modified to be portable units and used on localised areas.

Guidelines are provided on the selection and use of NDT methods for bonded repairs, [See: 20.3]. The techniques described are mainly those used for metallic materials and metal-skinned **honeycombs** found in aircraft structures.

20.2 Testing

20.2.1 Adhesive acceptance tests

The test methods applicable for each adhesive lot are, Ref. [20-3]:

- lap shear,

- metal peel,
- **Honeycomb** peel,
- Film weight.

20.2.2 Durability of bonded repairs

The Boeing wedge test, [See: 15.5], has been used to assess the durability or life-rating of bonded repairs, Ref. [20-1]. The results of this test are used to assess the applicability of the repair method.

The recognised classes of repair are:

- Permanent primary structure repair, where crack growth is less than 12.7 mm after immersion in water at 20 °C for 1 hour,
- Permanent secondary structure repair, where crack growth is less than 38.1 mm after immersion in water at 20 °C for 1 hour,
- Temporary secondary structure repair, where no wedge test is necessary provided that the lap shear strength is considered adequate with the surface preparation used.

20.3 Inspection

20.3.1 General

Non-destructive testing and inspection techniques are described in 16.4.

20.3.2 In-service damage

20.3.2.1 General

Most damage to aircraft structures occurring in service is caused by, Ref. [20-5]:

- Impact damage,
- Corrosion,
- Fabrication errors,
- Vibration.

20.3.2.2 Impact damage

The causes of impact damage are numerous and include:

- Runway debris,
- Dropped tools,
- Walking on 'no-step' assemblies,
- Hail,
- Bird strike.

Impact imposes strain on the adhesive which can cause it to crack or separate from the adherends. It can also result in crushing of sandwich cores.

Under service conditions damaged cores resonate, degrading the adhesive by fatigue and ultimately leading to **debonding**.

20.3.2.3 Corrosion

Good design is the first line of protection against corrosion for bonded assemblies. This avoids sites which trap moisture and enables fabrication to be carried out without compromising the corrosion performance of the structure.

During fabrication, the best protection against future corrosive attack is proper surface preparation prior to bonding.

Poor surface preparation leaves contamination or an unstable surface oxide condition which can enable:

- Moisture ingress,
- **Debonding**,
- **Crevice Corrosion**,
- **Galvanic Corrosion**.

Clad 7XXX-series aluminium alloy sheets are prone to **bondline** corrosion, whereas clad 2XXX-series alloys are more tolerant.

Unclad versions of these alloys have acceptable performance, provided that adequate preparation is carried out and corrosion-inhibiting primers are used.

Moisture ingress into aluminium core **sandwich** panels causes corrosion of the core. The moisture enters either by:

- Penetration at the bondline, affecting a number of adjacent cells,
- Skin perforation, caused by impact.

In perforated cores the cells are linked, so damage resulting from moisture ingress can be more extensive.

20.3.2.4 Fabrication errors

Despite all of the effort taken to ensure that the bonds produced are of adequate strength, NDT methods cannot measure adhesion, [See: 16]. Consequently, a poorly adhering bond is very difficult to identify. In-service failures can result from weak bonds caused by:

- Poor surface preparation,
- Unstable oxide failure,
- Corrosion,
- Improper cleaning.

The cleaning of **honeycomb** cores after machining operations is particularly difficult, so needs strict monitoring, to avoid core-to-skin disbonds occurring in service.

20.3.2.5 Vibration

Operational experience of bonded honeycomb primary structures, such as the horizontal and vertical stabilisers on military aircraft, e.g. F-15, showed that they are prone to accelerated degradation under high levels of vibration by:

- moisture intrusion,
- corrosion,
- skin-to-core debonding (as a result of moisture and corrosion).

20.3.3 Calibration

Ideal standard test pieces are essential for the calibration of inspection instruments. Usually a minimum of two assemblies with known voids present are needed.

The ideal standard test pieces are, Ref. [20-3]:

- replicates of the structure, including material, thickness and any particular features, e.g. risers, doublers,
- fabricated in the same way as the structural bond,
- made with deliberate voids and disbonds in the bondline to be inspected.

20.3.4 Standards

Where ideal standards are not available, those which resemble as closely as possible the items to be inspected are used.

Honeycomb standards cannot be used for metal-to-metal or vice versa.

Where no standards are available, a known undamaged area can be used to compare with the repaired area. Several inspections are made, often using different instruments. Knowledge of the precise configuration, e.g. bondlines, adhesive thickness, skin thickness, is essential for correct interpretation of the results.

20.3.5 Guidelines on NDT sensitivity

Defect sizing and location sensitivity for different techniques varies with a number of factors, including part complexity and operator skill level. Most of the techniques can detect defects most of the time. However, there are also some circumstances where special techniques and skills are needed for a reliable inspection.

Figure 20.3-1 summarises the defect detection capabilities of several established techniques for bonded metal laminated constructions, Ref. [20-3].

The minimum detectable size is different for different numbers of bonded metal sheets. For composite materials, the minimum detectable sizes indicated on Figure 20.3-1 are different.

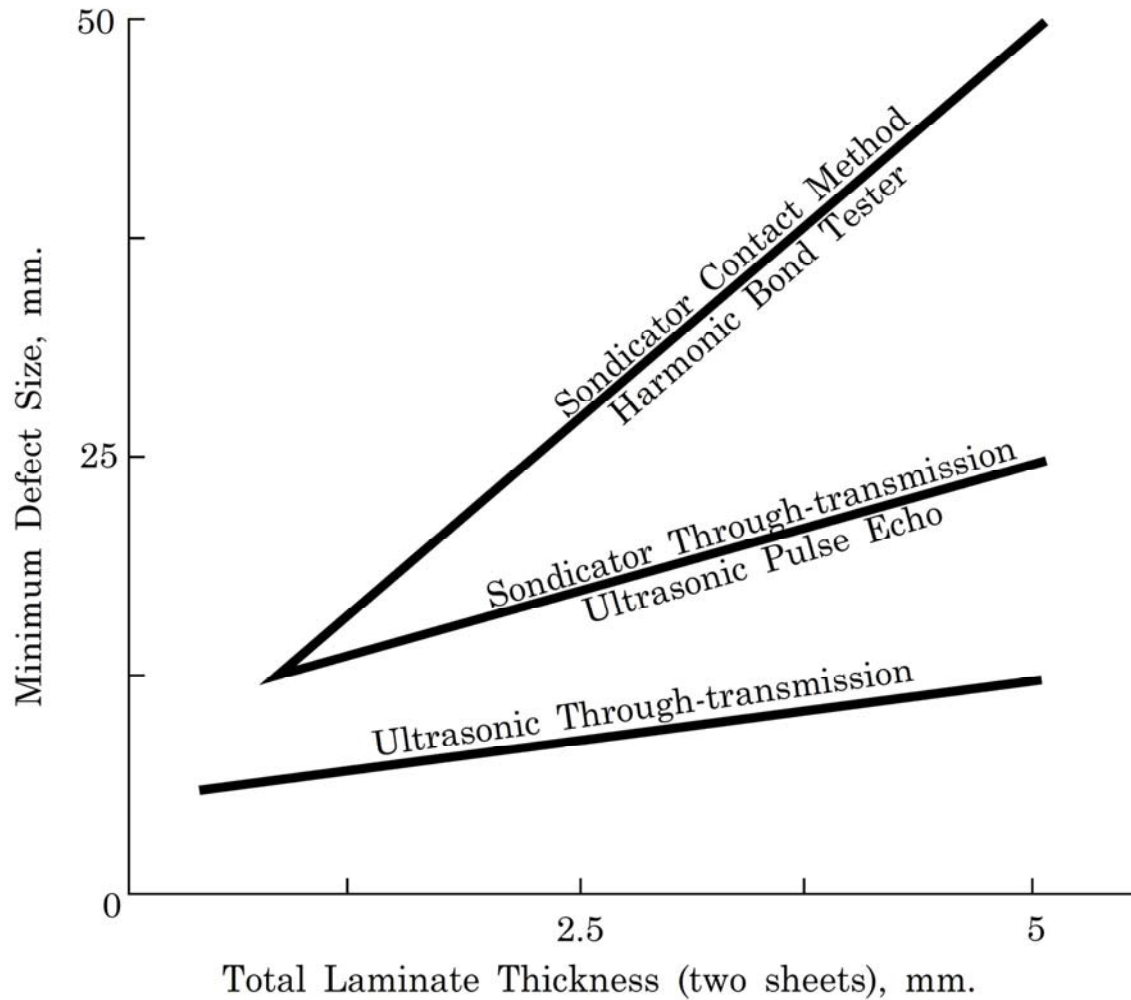

Figure 20.3-1 - Example of NDT Instrument sensitivity: Bonded metal constructions

20.4 Pre-repair inspection

20.4.1 Damage assessment

The aim is to determine the extent and severity of the damage. It can involve a number of inspections and evaluations in order to assess the, Ref. [20-3], [20-4]:

- Type and extent of damage,
- Amount of the structure to be replaced,
- Safety evaluations necessary before returning to service,
- Justification for repair,
- Cost.

Early detection of damage is important because the site can then be repaired before secondary deterioration occurs, e.g. moisture ingress or other contamination.

20.4.2 Guidelines

Most common types of mechanical damage can initially be detected visually, although composite materials can exhibit only limited external indications. Other techniques are used to map the extent of the damage.

Some guidelines for examining a damaged structure are:

- outline the damage area after visual examination,
- verify and revise the outline by tap test,
- verify further by using a portable NDT instrument, such as a 'bond tester':
 - metal-to-metal laminations, use of the Fokker Bond Tester can usually trace a well-defined outline.
 - visible cracks in a metal skin, where the extent can be determined by eddy current inspection.
 - **honeycomb** structure, where an X-ray examination is conducted to determine the extent of core damage and moisture in the core.
 - adhesive potting or foam-splice areas, where X-ray inspection is advisable.
 - multi-laminated area, where through-transmission ultrasonic inspection is advisable.
 - multiple bondline in honeycomb structure, where through-transmission ultrasonic inspection is advisable.

A cleaning process is needed to remove the couplant after inspection. Perforated areas are sealed to prevent couplant entering the structure.

20.4.3 Selection of NDT technique

Table 20.4-1 summarises the defect detection capabilities of various NDT techniques for bonded metal constructions, Ref. [20-3].

[See also: 16].

Table 20.4-1 - Pre-repair defect inspection methods

	Visual	Tapping	Resonance	Ultrasonic				X-ray	Eddy current	Acoustic emission	Thickness gauging†
				low frequency		high frequency					
				Portable	T-T	P-E	T-T				
Metal-to-metal honeycomb sandwich											
Moisture, oil				□	○			●		○	
Core corrosion				□	○	○	○	●		○	
Core crushing	□			○	○		○	●			
Face sheet delamination	□	□	○	○	○		●				
Back sheet delamination	□			□	○		●				
Void, porosity		□	○	○	○		●				
Skin cracks	□								●		
Face sheet corrosion (internal)						○				●	
Metal-to-non-metal honeycomb sandwich											
Moisture, oil				□	○			●		○	
Core corrosion				□	○		○	●	○	○	
Core crushing	□			○	○	○	○	●			
Face sheet delamination	□	□	○	○	○		●				
Back sheet delamination	□			□	○		●				
Void, porosity		□	○	○	○		●				
Skin cracks	□								●		
Face sheet corrosion (internal)										●	
Metal-to-metal single laminate											
Bondline corrosion			○	□	○	○	○		○	●	○
Delamination		□	●	○	○	□	●				
Voids		□	●	○	○	□	●				
Skin cracks	□								●		
Metal-to-metal multilaminate											
Bondline corrosion			○	□	○	○	○		○	●	○
Delamination		□	○	□	○	□	●				
Voids		□	○	□	○	□	●				
Skin cracks	□								●		
Key: ●: Preferred T-T: Through-transmission †: Ultrasonic or Eddy current ○: Alternative P-E: Pulse-echo □: Limited alternative											

20.5 Post-repair inspection

20.5.1 Repair verification

The objective is to ensure that:

- no area is left unbonded,
- no additional delamination or debonding occurred during the cure cycle.

20.5.2 Guidelines

The inspection procedure is guided by whether or not test standards are available, [See: 20.3].

The inspection steps for a repair include:

- conduct visual inspection of repaired area for obvious defects,
- conduct NDT with one or more portable instruments, [See also: Selection of NDT technique]:
 - metal-to-metal bonded repairs (narrow laminated steps), consider using the Fokker Bond Tester.
 - adhesive potting or foam splice in **honeycomb** structure, where an X-ray examination is advisable.
 - multi-laminated or multiple bondlines in honeycomb structure, where ultrasonic through-transmission is most successful.
- check availability of standards, if not then compare with an undamaged area,
- repeat the inspection using various instrument settings, and verify the results with another type of instrument. Changes in the structure resulting from repair can affect instrument readings.

20.5.3 Selection of NDT technique

Table 20.5-1 summarises defect detection capabilities of various NDT techniques for bonded metal constructions, Ref. [20-3].

[See also: 16]

Table 20.5-1 - Post-repair defect inspection methods

	Visual	Tapping	Resonance	Ultrasonic				X-ray	Eddy current	Acoustic emission
				low frequency		high frequency				
				Portable	T-T	P-E	T-T			
Metal-to-metal honeycomb sandwich										
Face sheet delamination	□	□	□	○	○		●			○
Back sheet delamination				□	○		●			
Void, porosity	□	□	□	○	○		●			
Void in potting								●		
Core defect				○	○		●	●		
Metal-to-non-metal honeycomb sandwich										
Face sheet delamination	□	□	□	○	○		●			○
Back sheet delamination				□	○		●			
Void, porosity	□	□	□	○	○		●			
Void in potting								●		
Core defect							●	●		
Metal-to-metal single laminate										
Delamination		□	●	○	○	○	●	○		
Voids		□	●	○	○	○	●	○		
Metal-to-metal multilaminate										
Delamination		□	○	□	○	○	●	○		
Voids		□	○	□	○	○	●	○		
Key: ●: Preferred ○: Alternative □: Limited alternative T-T: Through-transmission P-E: Pulse-echo										

20.6 References

20.6.1 General

- [20-1] A.A. Baker & R. Jones, (Editors)
 'Bonded Repair of Aircraft Structures'
 Martinus Nijhoff Publishers, Dordrecht, 1987.
 ISBN 90-247-3606-4
- [20-2] ECSS-E-HB-32-20: Structural materials handbook; previously ESA
 PSS-03-203
- [20-3] MIL-HDBK-337: Adhesive Bonding Aerospace Structural Repair 1982
- [20-4] R.F. Wegman & T.R. Tullos: Adhesion Associates, USA

'Adhesive Bonded Structural Repair: Pt. I -Materials & Processes,
Damage Assessment & Repair'
SAMPE Journal, Vol. 29, No.4, July/August 1993, p8-13

- [20-5] J. Wilson & D.P. Bashford: BNF-Fulmer, UK
'Inspectability In-service of Composite and Metallic Structures'
BNF-F Report No. R1176/D14/January 1991
ESA Contact No. 7090/87/NL/PP

20.6.2 ECSS documents

[See: [ECSS](#) website]

ECSS-E-HB-32-20 Structural materials handbook; previously
ESA PSS-03-203

21

Case studies on bonded connections

21.1 Introduction

21.1.1 General

The major uses of adhesive bonding technology in aerospace structures can be divided into:

- Assembly processes, where some case studies are given as examples of adhesive bonding techniques; [See: 21],
- Manufacturing processes, where some case studies of techniques are given as examples of the use of adhesive bonding; [See: 22].

21.1.2 Assembly processes

Joints between manufactured components are either solely composite or solely metal or, more often, composite to metal joints.

The bonded areas are relatively small with respect to the overall structure, e.g. end fittings on tubes, lap joints between sheet materials.

Most of the assembly processes are secondary bonding.

21.1.3 Manufacturing processes

Joints are made during the manufacture of a structural material. The prime example is sandwich panels of which various types are used extensively in aircraft and spacecraft structures.

The bond areas can be extensive and contribute to the whole material performance, [See: 22].

21.1.4 Case studies

21.1.4.1 General

The case studies selected show the use of adhesive bonding in the assembly of aerospace structures consisting of mixed metal and fibre-reinforced composite materials.

21.1.4.2 Aluminium alloys

Adhesive bonding is well-established for aluminium alloys, as:

- panels,

- end-fittings for composite tubes,
- metal skin-to-core **sandwich** panels, [See: 22].

21.1.4.3 Titanium alloys

Design of dimensionally-stable structures has led to titanium alloys being selected for end-fittings for some composite tubes instead of aluminium alloys.

21.1.4.4 Foam-cored sandwich panels

Structural foams have replaced traditional **honeycomb** cores for some aircraft applications, especially where problems occurred with corrosion damage in service to honeycomb cores after impact damage, fatigue and moisture ingress.

21.2 Aluminium alloy end fittings for CFRP tubes

21.2.1 Source

Lockheed Missiles and Space Co. California, USA. SAMPE Journal May-June 1987.

21.2.2 Application

Metallic end fittings on carbon fibre composite tubes for space truss structures, Ref. [21-1].

21.2.3 Objective of study

21.2.3.1 Concept

This was a technology study to compare methods of fixing end fittings to composite tubes. Minimal attention was paid to manufacturing cost and weight.

21.2.3.2 Materials

Carbon-fibre composite tubes having metallic end fittings that are either bonded, bolted or both bonded and bolted.

Table 21.2-1 gives the role, material selection parameters and identified materials for each item in the concept design.

As this was a technology study, several options were evaluated for end-fittings and adhesives. This process produced a preferred solution to undergo a test programme (detail design study) in order to validate the design.

A full evaluation of all the material selection and design parameters (as identified in this handbook) was not undertaken because it was a technology study.

Table 21.2-1 - Case study: CFRP tube/Al alloy - Material selection concept design study

Part	Role	Selection parameters	Material options
Composite tube	Primary axial reinforcement	<ul style="list-style-type: none"> •High stiffness •Minimum weight •Low CTE •Good tensile strength 	Pitch 75
	Off-axis reinforcement	<ul style="list-style-type: none"> •Known ease of use with fabric 	Fiberite HME 176
	Matrix, support fibres	<ul style="list-style-type: none"> •177 °C cure •Meet space performance demands •Established performance data •Cost and availability 	Fiberite 934 epoxy resin
	Buffer layer (between carbon composite and metal end-fitting)	<ul style="list-style-type: none"> •Machinability •Corrosion inhibition •Thermal mismatch 	181 style E-glass fabric
End fitting	Enable load transfer between tube assemblies in truss structure.	<ul style="list-style-type: none"> •Low cost •Machinability •Low weight 	Aluminium 6061 -T6 alloy
			Ti-6Al-4V
		<ul style="list-style-type: none"> •Low CTE 	SiC/6061 -T6 MMC (25 vol% SiC reinforcement)
Adhesive	Attachment of end fittings to tubes	<ul style="list-style-type: none"> •RT curing 	EA934
		<ul style="list-style-type: none"> •Acceptable lap shear properties 	Epibond1210A/9615A
		<ul style="list-style-type: none"> •Compatible with metal and composite (availability of primer) 	Epon 828/Versamid 125
		<ul style="list-style-type: none"> •Acceptable environmental tolerance 	
Fastener	Attachment of end fittings to tubes	<ul style="list-style-type: none"> •Space acceptable •Use with composites 	Composi-Lok MBF 2001 x 6mm

21.2.3.3 Joint design and analysis

Assemblies destined for operation in space experience different loading phenomena at the various stages of deployment and service life. Those considered were:

- launch:
 - acoustics during launch,
 - acceleration.
- space:
 - low temperature,
 - transfer orbit loads,
 - thermal cycling,
 - vacuum,
 - oscillatory and quasi-static loads,
 - thermal and mechanical loads.

21.2.4 Parameters for design

The main design parameters were:

- stiffness,
- strength,
- thermal cycling.

The joint design chosen was a cylindrical overlap between the metal end fitting and the composite tube, as shown in Figure 21.2-1

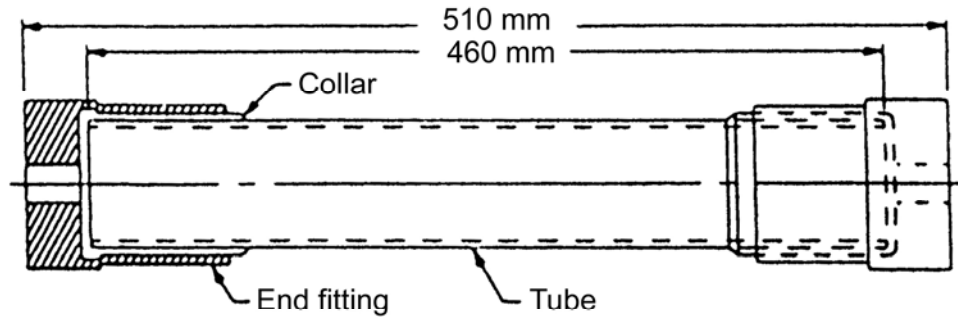

a) General view

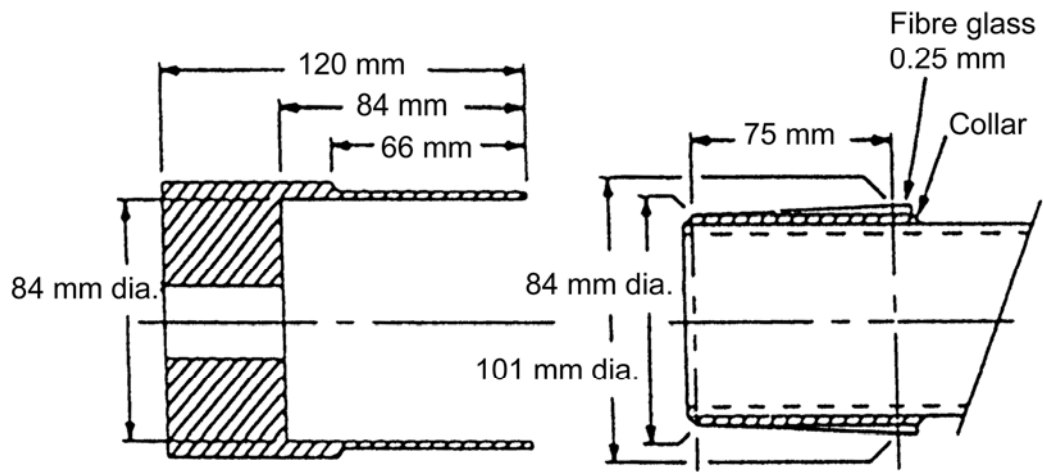

b) End fitting detail

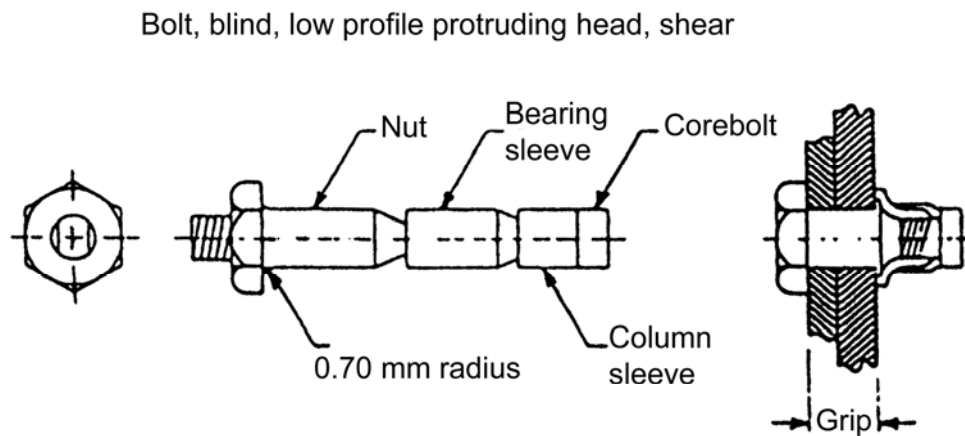

c) Composi-Loc mechanical fastener

Figure 21.2-1 - Case study: CFRP tube/Al alloy - Joint design for tubular specimens and end fittings

Joint analysis was performed with a finite-element model to determine the response of joints to mechanical and thermally-induced loads.

Analysis indicated that if the stiffness criterion was relaxed, then the strength improved. This resulted in a materials change in the tube construction in order to meet the new criteria; as shown in **Table 21.2-2**.

Table 21.2-2 - Case study: CFRP tube/Al alloy - Material selection detail design study

Part	Material options	Problem	Material change
Composite tube	Pitch 75	<ul style="list-style-type: none"> • relax stiffness criteria • increase strength 	T50 PAN
	Fiberite 176 fabric	<ul style="list-style-type: none"> • relax stiffness criteria • increase strength • ease of producing fibres 	T300 unidirectional tape
	Fiberite 934 epoxy resin	-	-
	181 E-glass fibre	<ul style="list-style-type: none"> • torque criteria for fasteners needed carbon/epoxy collar 	T300 unidirectional tape plus 181 E-glass fabric
End fitting	Aluminium 6061-T6	-	Continue
	Ti-6Al-4V	<ul style="list-style-type: none"> • Time-cost to machine too long 	Not considered further
	SiC/6061-T6 MMC	<ul style="list-style-type: none"> • Time-cost to machine too long 	Not considered further
Adhesive	EA934	-	Continue
	Epibond121 OA/9615A	<ul style="list-style-type: none"> • Thermal cycling reduced strength to below that of EA934 for 6061-T6 	Not considered further
	Epibond 828/ Versamid 125	<ul style="list-style-type: none"> • Non-thixotropic behaviour, so difficult to apply 	Not considered further
Fastener	Composi-Lok MBF 2001 x 6mm	-	Continue

21.2.5 Manufacture

The bonding procedure is shown schematically in Figure 21.2-2, which also includes details of the surface preparation of the **adherends**.

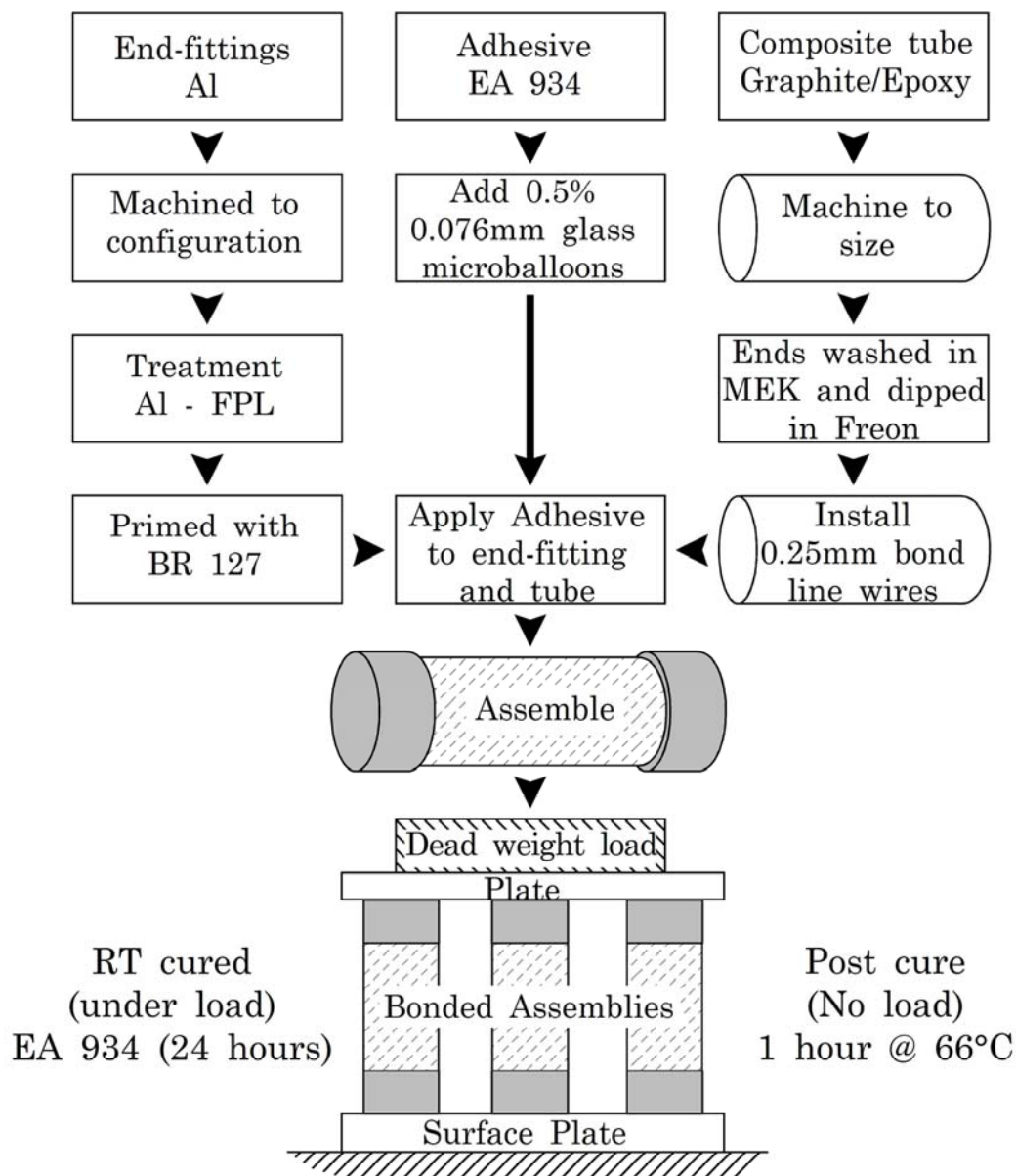

Figure 21.2-2 - Case study: CFRP tube/Al alloy - Bonding procedure for end fittings

Microspheres (ballottini) were used as a thickening agent and, to achieve a bondline thickness of 0.25 mm, stainless steel wires were placed in the bondline.

Bonded and bolted joints were produced in the same way, with a subsequent drilling operation to install the fasteners (12 in total per end fitting).

Solely bolted joints were produced as a comparison.

21.2.6 Inspection

21.2.6.1 General

No details of bonded joint inspection are given.

21.2.6.2 Testing

The test programme, in a number of stages, was devised to:

- ascertain the effect of additions of glass microspheres (ballottini) on lap shear properties,
- investigate adhesive options before and after thermal cycling,
- compare strength and stiffness of tube and end fitting assembly, before and after thermal cycling, for bonded, bolted-and-bonded and solely bolted joints.

21.2.7 Conclusions

The preferred method of attaching end-fittings was bolted-and-bonded joints. These exhibited superior strength and stiffness retention after thermal cycling.

The preferred materials for the assembly were:

- composite tube, made from carbon-fibre reinforced epoxy with an E-glass buffer layer;
- adhesive system, comprising of EA934 with 0.5% glass ballottini and stainless steel wires for bondline control.
- end fitting, made from aluminium alloy 6061-T6.
- fastener: Compositi-Lok MBF2001 x 6 mm.

21.2.8 Comments on case study

The study demonstrated the importance of using materials which have an established performance database. Where a property is unknown, a validation exercise is necessary.

The benefits of low CTE offered by MMC and Ti-alloy end-fittings were offset by the increased time and cost in machining over that initially estimated.

Epon 828/Versamid adhesive proved difficult to handle during manufacturing because of its non-thixotropic behaviour.

The study also shows that the tube design and manufacture was an iterative process, e.g. finding that a relaxation in the stiffness criterion and an increase in strength meant that, by substitution of materials, there was an associated cost benefit.

The theoretical joint analysis by a finite-element model assisted in predicting performances.

21.3 LVA launch vehicle attachment ring and CFRP thrust cone

21.3.1 Source

British Aerospace, Space and Communications Division, Bristol. ESA SP-243 workshop on Composites Design for Space Applications.

21.3.2 Application

Bonded joint between a LVA launch vehicle attachment ring and **CFRP** thrust cone, Ref. [21-2].

21.3.3 Objective of study

To consider two joint design options by comparing their performance in terms of strength and mass, and selecting the optimum design.

21.3.4 Concept

An adhesive connection was needed between a cylindrical CFRP-skinned aluminium-alloy **honeycomb sandwich** and a metallic attachment ring.

The options were either:

- a bonded and bolted design, or
- a 4-lap shear face configuration.

21.3.5 Joint design and analysis

The assemblies were destined for launch by Space Shuttle and had to conform with NASA requirements, with the completed spacecraft structure undergoing static qualification tests to ultimate load levels (limit x 1.4). Each flight cone was subjected to a static acceptance test at proof load level (limit x 1.1).

The thrust cone was manufactured from three 120° segments of **CFRP**-faced, aluminium alloy **honeycomb**. These were joined axially by bonded CFRP butt straps; as shown in Figure 21.3-1

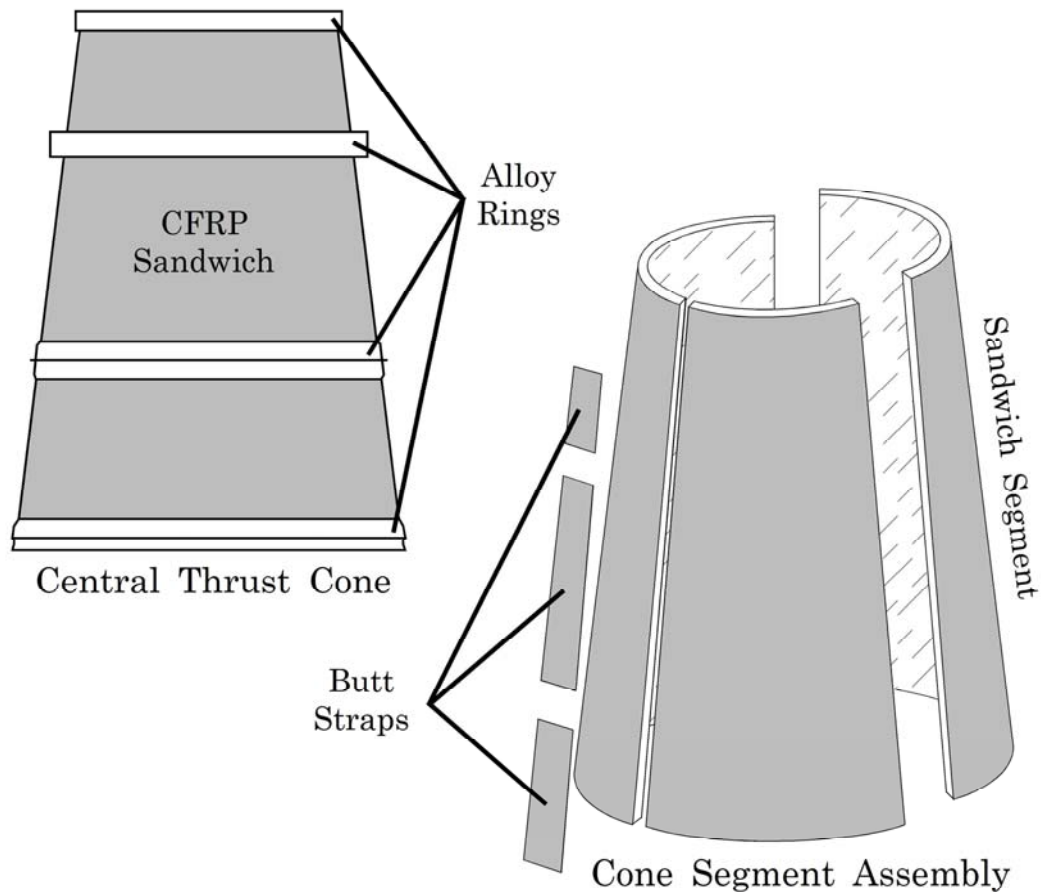

Figure 21.3-1 - Case study: LVA ring/CFRP thrust cone - Basic construction of thrust cone assembly

Four aluminium alloy rings were connected by various means to the cone, the lower of the four being the interface flange for attaching the spacecraft to the launch vehicle. During launch a large bending moment is induced on the LVA frame-to-cone joint which is reacted by differential axial compression and tension loads across the diameter of the joint. These loads are reacted by the bond between the **CFRP sandwich** segments and the machined alloy frame.

The maximum ultimate running load was ± 150 N/mm from a combination of static and vibration loading.

A base line LVA frame joint was assessed, consisting of a simple twin lap shear bond; as shown in Figure 21.3-2. This proved inadequate, and the two realistic options shown were compared, both by finite-element analysis and mechanical testing of representative sections.

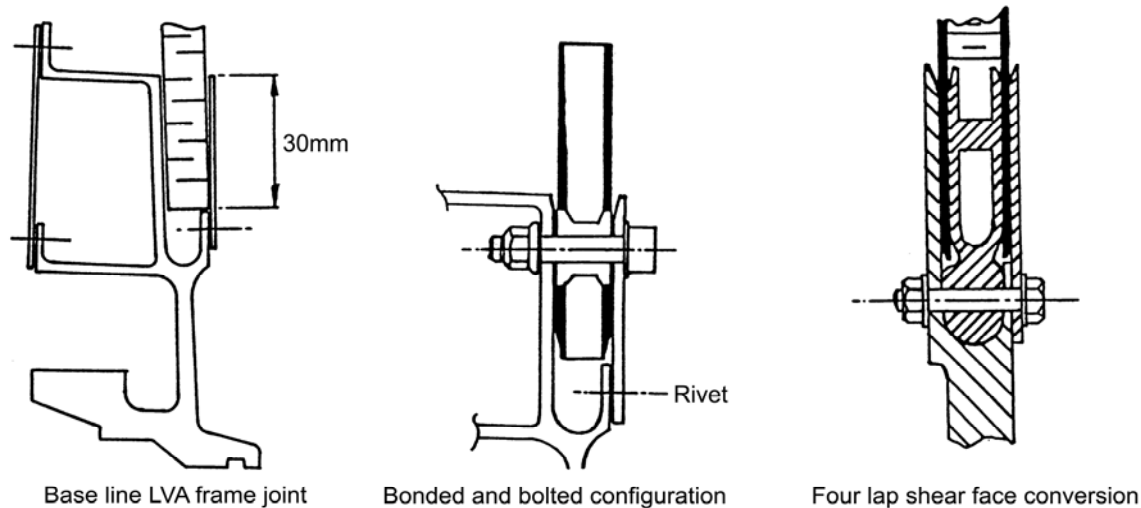

Figure 21.3-2 - Case study: LVA ring/CFRP thrust cone - Joint configurations for LVA ring to thrust cone connection

The general features used in both options to reduce the peak adhesive shear stresses at the edge of the bond were:

- increasing the thickness of the alloy closing plate and the **CFRP** skin in the region of the joint in order to balance the stiffness of the adherends, i.e. $E_{1t1} = E_{2t2}$,
- chamfering the edges of the adherends, so thickening the adhesive at the ends of the joint. The chamfering was seen to increase the failure load of representative joints by 56%.

The twin double-lap face configuration was selected to balance the joint. This gave much lower shear and peel stresses than the single lap shear of the baseline configuration. The mass penalty of this, over the baseline joint, was 3.2 kg.

For the bonded and bolted concept, the **peel** stresses are minimised by the constraint imposed by the bolts, adherend stiffness balancing and chamfering. The mass penalty of this joint over the baseline design was 1.4 kg.

The failure loads in tension, for preliminary tests on two specimens of each type, were:

- four lap shear face: 667 N/mm and 737 N/mm,
- bolted (no adhesive): 244 N/mm,
- bolted and bonded: 340 N/mm.

These figures demonstrate the efficiency of the all-bonded construction. However the bonded and bolted version was chosen because it had adequate strength, was lighter and easier to manufacture and was fail-safe.

21.3.6 Manufacture

Production engineering modified the envisaged design to aid the manufacturing and assembly processes. The modifications were:

- the lower 60 mm of the **CFRP** skins were increased in thickness from 0.6 to 1.2 mm. This was achieved by means of a bonded doubler with a section of cured laminate for the outer skin. Laminating and co-curing the extra thickness was used on the inner skin with decreasing lengths of prepreg to give a tapered profile,
- the **honeycomb** in the lower 60 mm of the cone was replaced with a syntactic foam filler of **epoxy** resin with glass microballoons,
- inserts (14 mm diameter) were potted into the cone segments positioned at 20 mm from the lower edge,
- the machined alloy frame and loop-shaped closing plates had chamfers machined on their top edges.

21.3.7 Assembly

The main assembly steps were:

- the top and bottom frames were fitted into the cone assembly jig to maintain the relative positions of the upper and lower interfaces of the cone,
- the three segments were then bonded onto the top and bottom frames by means of Araldite 2004 epoxy paste adhesive,
- the closing plates were bonded onto the segments and riveted to the machined frames, thus forming a double lap joint at each end of the core.

Once the adhesive was cured, 66 holes were drilled through the closing plates, inserts and machined frame at the base of the core. The 5 mm bolts were then fitted and torque tightened to form the complete bolted and bonded LVA frame joint.

Surface preparation techniques received close attention and various options were evaluated for both the aluminium alloy and **CFRP**.

For the alloy, abrasive blasting and solvent wiping produced the strongest joints and this was adopted. The use of primers or etches proved unnecessary as environmental stability (resistance to moisture ingress) was not needed.

Combined **peel ply** and subsequent manual light abrasion proved appropriate for the **CFRP**.

21.3.8 Inspection

No information was provided on inspection.

21.3.9 Test

As part of the development testing programme, representative joint test samples were loaded in tension and compression. The specimens revealed three modes of localised failure before ultimate load.

The third discontinuity in the load-deflection curve resulted from failure of one side of the main bonded joint at one end of the specimen. This was deemed to be the ultimate strength of the joint.

The results from 20 test specimens were:

x:	311 N/mm
S.D.:	47 N/mm
'A'- value allowable:	156 N/mm

21.3.10 Conclusions

The results obtained from the tests on joint samples proved, with a high level of confidence, that the chosen design was capable of withstanding the ultimate flight loads imposed on the joint. This was verified by:

- the development testing of a complete cone,
- qualification testing of the complete spacecraft structure;
- proof testing of each flight cone.

No failures occurred during any of these tests.

21.3.11 Comments on case study

The case study shows the process undertaken to select a joint design strong enough to take the desired running load.

The final design met this criterion, whilst at the same time satisfying the need for mass control, ease of manufacture and fail-safe characteristics.

Inspectability is one area where the joint configuration can cause problems, unless each manufacturing stage was closely monitored.

21.4 Shuttle pallet satellite (SPAS) primary framework structure

21.4.1 Source

MBB-Messerschmitt-Bölkow-Blohm GmbH, Ottobrunn, Germany.

- ESA SP-243 Workshop on Composites Design for Space Applications.
- Composite Structures 6 (1986) p183-196.

21.4.2 Application

To provide a low-cost, multi-purpose satellite structure operated from the US Space Shuttle, Ref. [21-3].

21.4.3 Objective of study

To form a connection between CFRP and titanium for the strut end-fittings of a structural framework.

21.4.4 Concept

To form a scarf, double-shear bonded joint between the CFRP composite tube and titanium alloy.

21.4.5 Materials

Details of the materials used are given in Table 21.4-1.

The materials selected reflected the need to manufacture struts of different lengths and with particular directional mechanical properties. This warranted using two forms of carbon fibre to balance stiffness and strength criteria. The subsequent manufacturing route was fairly novel for a composite structure.

Table 21.4-1 - Case study: SPAS - Material selection/design study for SPAS-01 framework

Part	Role	Selection parameters	Materials selected
Composite tube	Primary axial (0°) reinforcement	<ul style="list-style-type: none"> • High stiffness • Minimum weight • Low CTE • Acceptable tensile strength • Windable 	Toray M40 Carbon fibres (modulus 392 GPa)
	Off-axis (90°) reinforcement	<ul style="list-style-type: none"> • Lower cost than primary reinforcement • Acceptable compromise between stiffness and strength • Windable 	Toray T300 Carbon fibres (modulus = 235 GPa)
	Matrix resin for reinforcement fibres	<ul style="list-style-type: none"> • Suitable for resin injection into dry fibre reinforcement • RT cure with elevated temperature curing capacity to 120 °C 	Ciba-Geigy CY209/HT972 epoxy resin
End fitting	To enable load transfer between strut and node elements	<ul style="list-style-type: none"> • Machinable • Acceptable strength- and stiffness-to-weight • Electrochemically compatible with CFRP 	Titanium alloy Ti-6 Al-4V
Adhesive	Attachment of end fittings to composite tube	<ul style="list-style-type: none"> • RT cure • Compatible with adherends • Acceptable lap shear properties • Space acceptable 	Ciba-Geigy HV138M/HT998 epoxy adhesive

21.4.6 General requirements and overall design description

The SPAS-01 was designed as a low-cost, multi-purpose satellite structure. The framework subsystem is illustrated in Figure 21.4-1. The specification was:

- modular construction for adaptation to different payloads,
- high structural stiffness to fulfil the dynamic requirements of the Space Shuttle,
- lighter than a fully metallic structure,
- good dimensional stability under fluctuating thermal conditions,
- a large number of hard points for payload attachment, arranged in a standardised pattern, for various types of payloads.

Titanium node elements were used for connecting the struts to the attachment points for the payload.

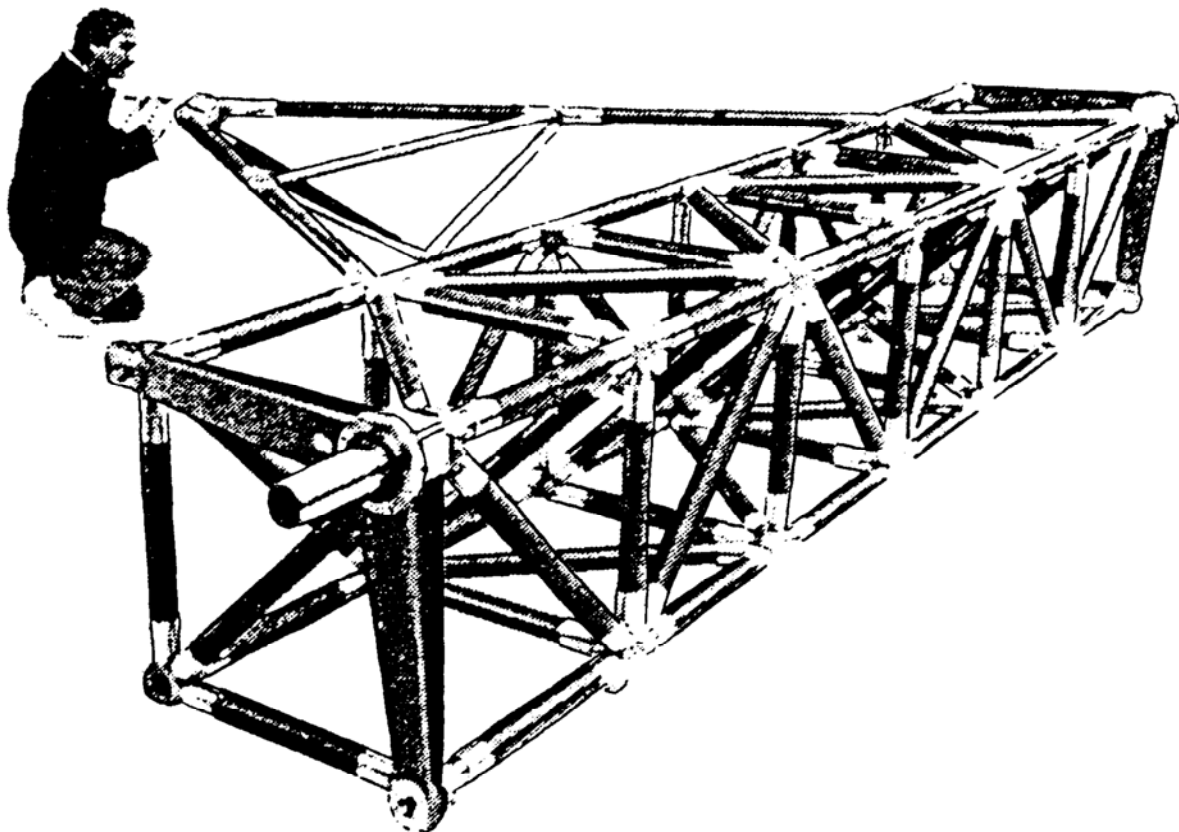

Figure 21.4-1 - Case study: SPAS-01 primary structure

21.4.7 Joint design analysis

For the CFRP-to-titanium bonded section two main criteria had to be fulfilled:

- uniform stress distributions along the bonded section with the suppression of peak stresses in the case of external loads and thermally induced loads,
- extremely close manufacturing tolerances for the CFRP tubes and titanium alloy end-fittings.

After several design exercises considering the type and stiffness of different composite materials, as well as the dimensions of the bonded area, the bonded section shown in Figure 21.4-2 was selected.

The features of the selected design were:

- the scarf contours of the adherends provided continuous load transfer over the total length of the bonding area and reduced the peak stresses at the ends of the overlap,
- the **adherends** were balanced in stiffness at all locations ($E_{1t1} = E_{2t2}$), providing a symmetrical stress distribution along the overlap.

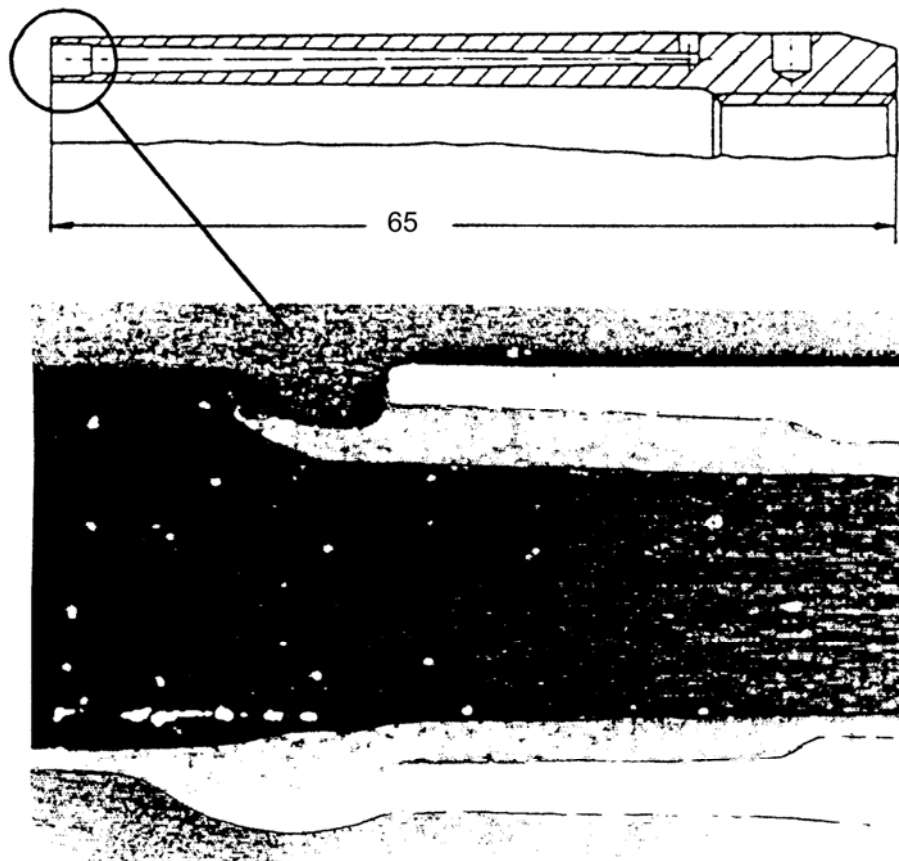
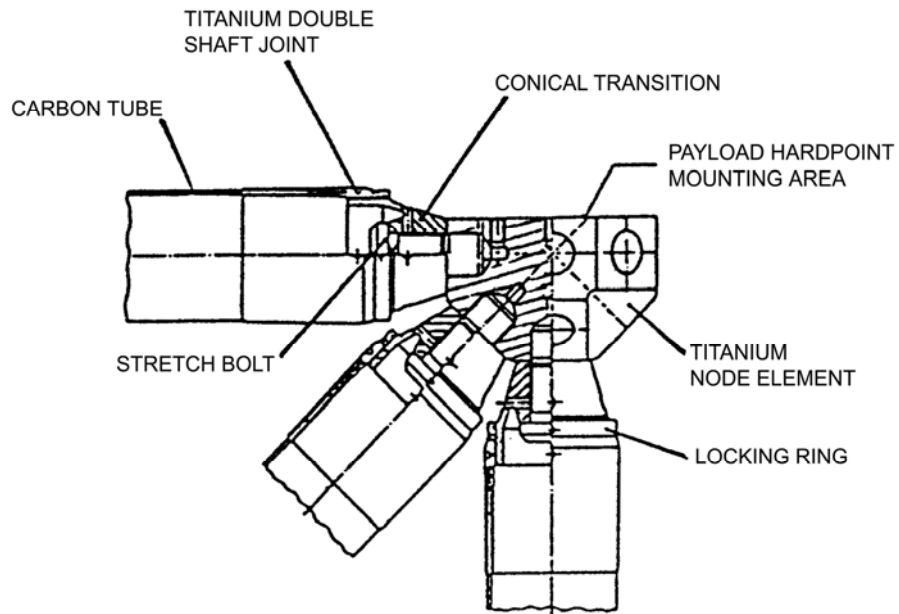

Figure 21.4-2 - Case study: SPAS - details of joint dimensions

21.4.8 Manufacturing

21.4.8.1 CFRP tube

The fabrication process consisted of:

- dry winding the fibres onto a steel mandrel with a polished hard-chrome surface. This provided the inner tube diameter. Controlled pretension of both the 0° and 90° fibres was needed to guarantee alignment,
- placing the wound tube and mandrel in a heated mould, evacuating the mould and injecting with resin, followed by post-curing to 120 °C,
- removal of excess resin by machining and grinding of the conical end section to provide the scarf.

21.4.8.2 End-fittings

The fittings were machined from a single piece of Ti-6Al-4V alloy. The 50 mm deep bonding groove was made by an automatically controlled electro-erosive process.

Non-destructive inspection was carried out by dye penetrant crack detection.

21.4.9 Bonding process

The bonding pretreatments used were:

- ultrasonic cleaning of the titanium in Turku and freon,
- abrasion, and freon vapour cleaning for CFRP.

After drying, the paste adhesive, HV138M/HT998, was applied to both alloy and CFRP and the two then assembled using a guided support device.

21.4.10 Test

The tests performed to verify the integrity of the joints were:

- axial load (tension-compression),
- bending load,
- fatigue life,
- thermal cycling,
- combined thermal and axial loading.

Some struts from the flight hardware lot (5%) were destructively tested by alternating tension and compression loading, i.e.:

Tension	Compression
+ 10kN	-20kN
+ 30kN	-40kN
	... /continued

This gave failure in tension at a mean of 222.75 kN \pm 17 kN with an ultimate load capacity P99.95% = 167 kN.

Fatigue testing was carried out at an axial load level of \pm 120 kN for 10^5 cycles on another 5% of flight items. These showed no loss of strength during subsequent destructive testing.

The struts were also pre-conditioned with 10 thermal shock cycles between +65 °C and -50 °C.

Alternating tensile-compressive rupture testing was conducted at -65 °C where a failure load in tension of 151 kN was recorded. This confirmed the predicted reduction in load capacity of 0.88 kN per °C below 20 °C.

All of the struts fabricated (over 450 in number) were acceptance tested to 145 kN; where this was 1.2 x maximum expected limit load.

21.4.11 Inspection

Dye penetrant crack detection was used on the metal end-fittings.

No information was given on the inspection of completed struts.

21.4.12 Conclusions

The joint design for the end fitting and CFRP tube was selected to provide mass efficiency and a substantial load-carrying capacity, i.e. 220kN. The efficiency was achieved through using a double lap scarf joint, hence the need for a specialised manufacturing route.

21.4.13 Comments

This programme represented a major development in joints for space hardware. Over 450 struts were made of different dimensions, but having the same overall design.

These have been applied to the:

- EBS - European bridge assembly on Spacelab FSLP mission,
- USS - Unique support structure on Spacelab mission D1,
- Eureca - European retrievable carrier

21.5 MD 11 outboard flap vane

21.5.1 Source

Westland Aerospace, IoW, UK.

- 34th International SAMPE Symposium, 8-11 May 1989.
- ESA SP-336 (October 1992), p57-62.

21.5.2 Application

Wing flap vane on McDonnell Douglas MD 11 aircraft which is a development of the existing DC10, Ref. [21-4].

21.5.3 Objective of the study

To design, develop and manufacture a flap vane in composite materials which is a direct replacement for the existing metal item.

21.5.4 Parameters for design

The final design needs to:

- withstand all loads (customer specified),
- use composite materials,
- not use **honeycomb** cores,
- only make limited use of mechanical fastening and only where necessary,
- be an adhesively-bonded assembly,
- be interchangeable with the existing metal design, so avoiding redesign of flap or wing structures,
- retain splice joint.

21.5.5 Concept

Three concepts were considered:

- a. **CFRP-epoxy** skins, foam core and a pair of ribs at each flap track attachment point,

CFRP-epoxy skins with two spars, foam core and a pair of ribs at each flap track attachment point,

CFRP-epoxy skins with two spars, no core, a large number of ribs between track positions as well as the pair of ribs at each flap track attachment point.

All three concepts use **film**, and some foaming, adhesives for bonding skins, ribs, and foams together. Concept 1 was selected on the basis that it fulfilled the technical demands along with constraints imposed on weight and cost.

21.5.6 Materials

21.5.6.1 General

Table 21.5-1 summarises the materials used, with the basic design illustrated in Figure 21.5-1.

Table 21.5-1 - Case study: MD 11 outboard flap vane - materials

Skins: Upper Lower	Carbon fibre-epoxy fabric: 5H satin prepreg, 177 °C cure Lay-up ⁽¹⁾ : Between track positions: (0°/+45°/-45°/0°); At track positions: (0°/90°/+45°/-45°/-45°/+45°/90°/0°)
Ribs	Composite
	Splice joint: Aluminium alloy
Foam core	Rohacell 51WF and 71WF
Housings for flap track goose necks	AA 7075-T6511
Gooseneck fittings	MIL-S.8844 300M steel
Splice fittings	AA 7075-T7351
Adhesives †	Co-cured: External surfacing of skins. Secondary bonding: Rib pockets (bonded and riveted). Splice joint (bonded and riveted to skins) Skin-to-core Core-to-core
(1): 0° = spanwise	
†: Product names not stated	

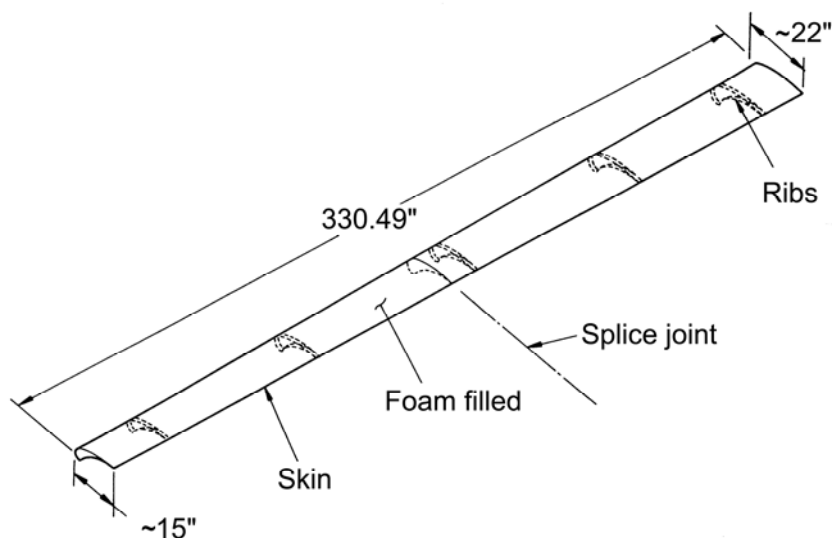

Figure 21.5-1 - Case study: MD 11 outboard flap vane - basic structure

21.5.6.2 Basic features

A foam core is used instead of **honeycomb** because:

- concerns were expressed by aircraft manufacturers (an original stipulation),
- it withstands design loads and processing loads, whereas honeycomb tends to collapse edgewise,
- it is easily machined to complex profiles, e.g. aerofoil and rib sections,
- it has an acceptable machined surface for bonding,
- core expansion during bonding supplied the pressure needed for successful bonds,
- it has low compressive creep, e.g. during bonding,
- it has an upper temperature range 180 °C to 200 °C (for short periods), when heat-treated and stabilised.

21.5.7 Joint design

Although specific details were not given, aspects of the joint design are illustrated:

- skin lay-up and joints; shown in Figure 21.5-2,
- ribs; shown in Figure 21.5-3,
- splice joint analysis; shown in Figure 21.5-4.

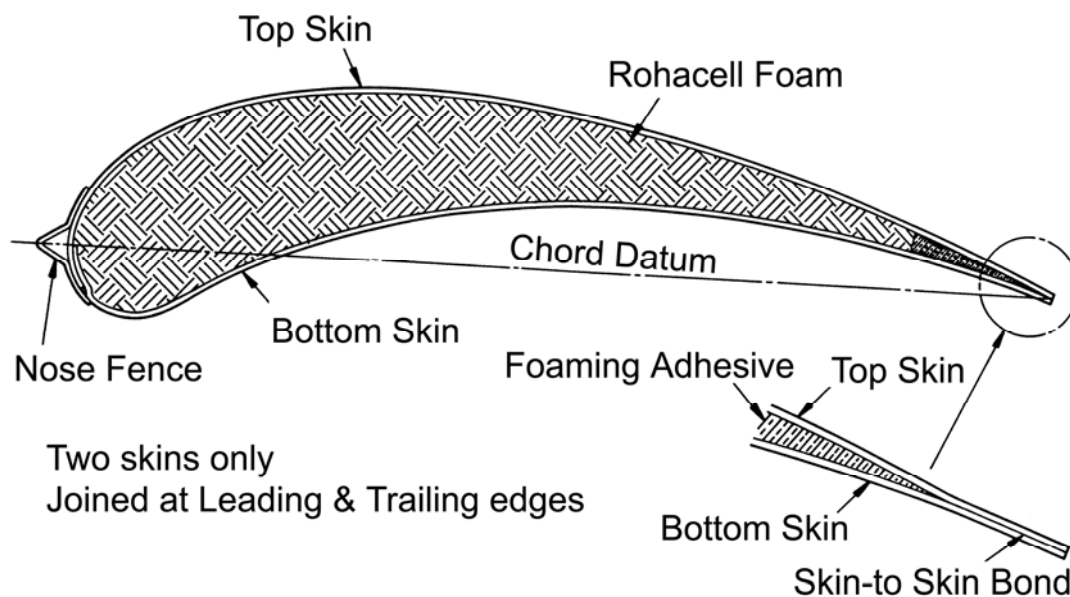

Figure 21.5-2 - Case study: MD 11 outboard flap vane - skin lay-up and joints

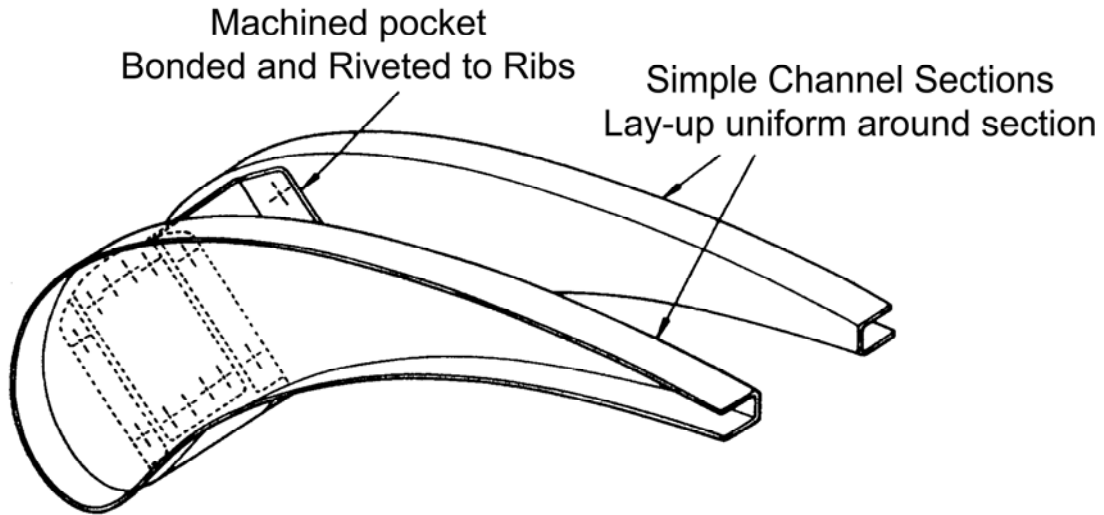

Figure 21.5-3 - Case study: MD 11 outboard flap vane - ribs

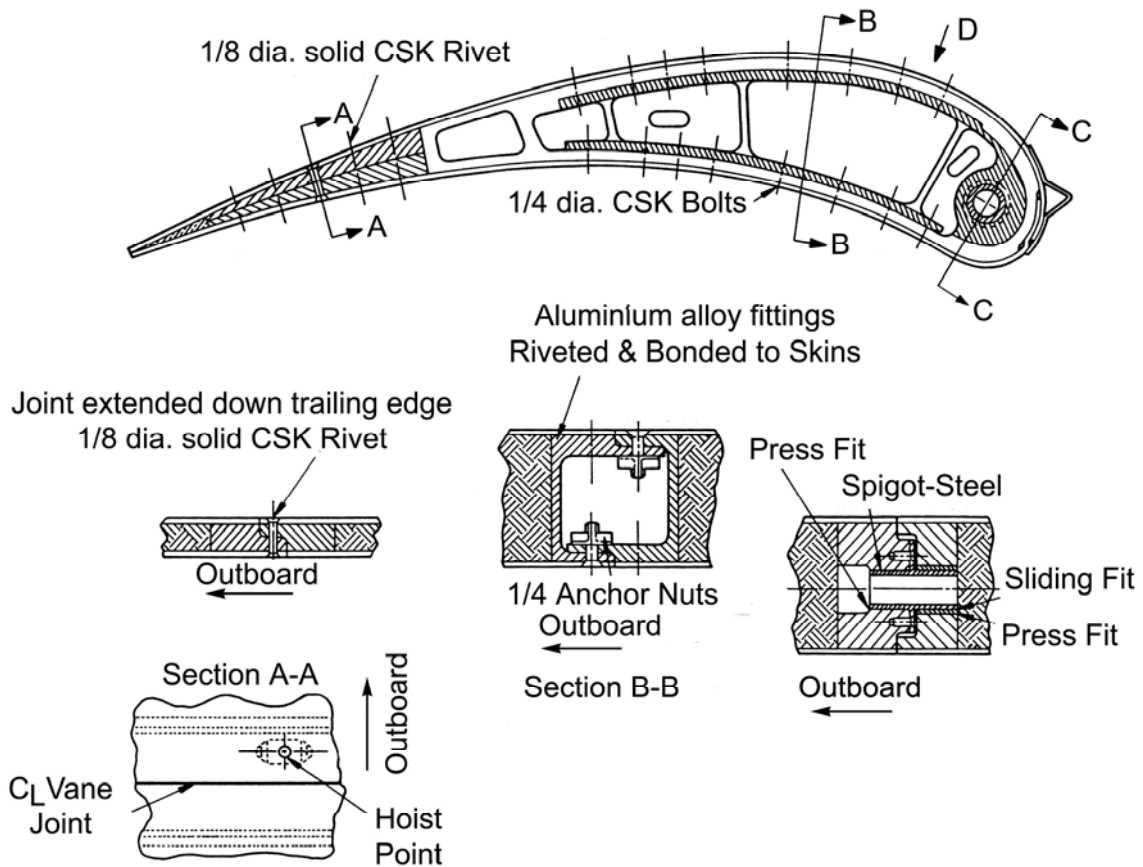

Figure 21.5-4 - Case study: MD 11 outboard flap vane - splice joint analysis

21.5.8 Manufacturing

21.5.8.1 General

The overall manufacturing process was:

- component parts manufacture,
- areas for bonding incorporated peel plies,
- structure assembled by two-step adhesive bonding.

Originally assembly was a three-step bonding process, but problems with CTE differences between core and tool caused jig pin failures.

21.5.8.2 Adhesive assembly process

The two-step adhesive bonding process was:

- step 1, where foam cores, rib assemblies and bottom skin were assembled, and
- step 2, where the top skin was assembled.

Foam core is **hygroscopic** and needs rigorous control of storage, handling and drying conditions.

21.5.8.3 Modifications to assembly

The modifications made were:

- film adhesive replaced foaming adhesive between cores and ribs because of migration into the **film** adhesive glue lines,
- core positive tolerance $0+0.010''$ (0.25 mm) lengthwise, for film adhesive at ribs.

21.5.9 Test

21.5.9.1 Materials test programme

The foam core was tested for stiffness and strength by subjected it to compressive and shear testing at RT and elevated temperatures with various moisture contents.

Other material tests were not stated.

21.5.9.2 Qualification testing

This was undertaken at structural element and component level:

- structural element level:
 - strength of gooseneck to flap vane attachment.
 - splice joint to flap vane.
 - durability and damage tolerance test on two-dimensional specimen with two gooseneck fitting supports.
- component level:

- full flap vane assembly to confirm static proof load performance.
- durability, damage tolerance and failure tests.

The proof test was done prior to damage tolerance tests to ensure compliance with the stipulation to fulfil the proof test programme 3-months prior to the aircraft's first flight.

Precise details were not given, other than that the vane performed as predicted under test.

21.5.10 Inspection

21.5.10.1 Non-destructive testing

A combined ultrasonic C- and A-scan technique was used to check:

- composite parts for voids, **delamination** and foreign objects,
- adhesive bonds (final stage).

21.5.10.2 Mechanical straightness

Profile checks were done in the assembly jig prior to machining:

- gooseneck fitting holes and faces,
- splice joints.

21.5.11 Conclusions

The composite flap vane was designed and manufactured. Compared with the all-metal design, it showed weight-saving benefits and no corrosion.

21.5.12 Comments on case study

The case study demonstrates the successful use of adhesive bonding with a foam core material, rather than the more established **honeycomb** core materials.

Whereas selection of bonding pressures needs to avoid the inadvertent crushing or deforming of a honeycomb core, a foam core provides an 'even' bonding surface during the adhesive cure cycle.

Foam cores need drying before assembly and curing. If not, moisture affects the adhesive bond strength and durability.

21.6 CFRP-titanium tubular bonded joint

21.6.1 Source

Mr Bruno Fornari: Alenia Spazio and Politecnico di Torino, Italy. Paper presented at International Conference 'Spacecraft Structures and Mechanical Testing', Paris, 21-24 June, 1994.

21.6.2 Application

Truss frameworks for high-stability satellite structures, such as antenna towers, payload supports and optical benches, Ref. [21-5].

21.6.3 Objective of study

Design, development and testing of a joint between an UHM ultra high modulus CFRP tube and a titanium end-fitting.

21.6.4 Parameters for design

The parameters were:

- high structural stiffness,
- high thermal stability at operating temperature regimes,
- tensile failure load exceeding 30100 N,
- reduced weight compared with corresponding metal structure,
- minimum need for machining (**adherend** manufacture),
- simplicity of joint assembly,
- RT adhesive bonding (minimise residual stress),
- possibility of adjusting the strut alignment during the structure assembly (extended adhesive curing time).

21.6.5 Concept

Figure 21.6-1 shows the sectioned bonded joint concept.

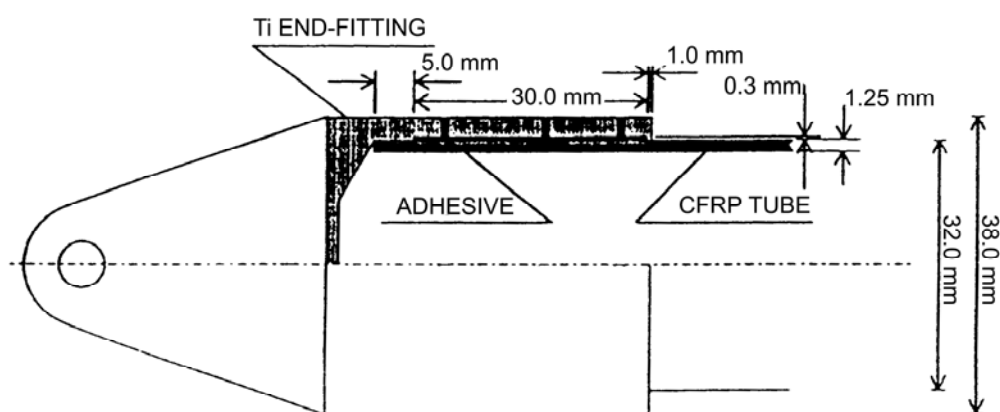

Figure 21.6-1 - Case study: CFRP Tube/titanium fitting - bonded joint section

21.6.6 Materials

Table 21.6-1 gives the material properties.

Table 21.6-1 - Case study: CFRP tube/titanium fitting - material properties

Property	Value
UHM Carbon/epoxy: Ciba/Brochier GY70/V108	
Lay-up: [$\pm 20^\circ$, 0°] ₄ s, wall thickness: 1.25mm, 32mm OD.	
Tensile elastic modulus (GPa)	
Axial	242.7
Transverse	6.45
Shear modulus (GPa)	12.31
CTE ($\times 10^{-6} \text{C}^{-1}$)	
Axial	-1.7
Transverse	24
Titanium Ti-6Al-4V alloy: End caps machined from bar	
Tensile elastic modulus (GPa)	110
Shear modulus (GPa)	42.6
CTE ($\times 10^{-6} \text{C}^{-1}$)	10
Adhesive: Hysol EA9321	
Shear modulus (GPa)	1.18
Shear strength (MPa)	
elastic limit	14
ultimate	32
Tensile modulus (GPa)	2.7
Cure time at RT (days)	5 to 7
Pot life at RT (mins)	40
Primer: American Cyanamid BR127	

21.6.7 Joint design

The main joint design features include:

- simple single-lap configuration; shown in Figure 21.6-1
- **CFRP** tube dimensions:
 - 32 mm external diameter.
 - wall thickness 1.25 mm.
 - 200 mm length (for test samples).
- titanium end-cap fitting, comprising of a tube centring aid - two rims machined inside cap (1 mm from opening and 5 mm from blind end),
- **bondline** dimensions, as dictated by rim position and rebate depth between them:
 - adhesive layer thickness of about 0.3 mm.
 - overlap length of 30 mm.
- holes for adhesive injection into the bondline, comprising of 12 drilled holes (in three rows).

21.6.8 Analysis

21.6.8.1 General

Traditional and FEM analyses were performed to determine the bonded tubes suitability for use in optical payload supports. The parameters investigated were:

- strength regarding composite **delamination** resistance and load-carrying ability of adhesive layer,
- stiffness regarding theoretical values to be correlated with mechanical test data,
- thermal and moisture expansion for stresses induced by environmental variations (details not given).

21.6.8.2 Strength analysis

The findings relating to the strength analysis were:

- Hart-Smith theory, assuming fully elastic behaviour of the adhesive as a boundary condition. Calculated joint static load-carrying capacity without damage gave 20000 N. This value indicated the proof-load for the strut strength verification.
- Linear FEM provided:
 - Stress distribution in adhesive close to composite; as shown in Figure 21.6-2. Two high stress peaks occurred at the ends of the Ti-adhesive interface, (22.5 MPa maximum for 50000N load case). This is lower than adhesive ultimate tensile strength (37 MPa).
 - Two other peaks corresponded to the position of the internal rims in the fitting, which acted as stress-raisers.

- Stress distribution through composite thickness; as shown in Figure 21.6-3. Maximum stress occurred in the outer +20° ply at the overlap end. It was assumed to be responsible for the joint failure.
- Peel stress distribution in the adhesive layer; as shown in Figure 21.6-4. Despite the joint rotational symmetry, the analysis showed that peel stresses cannot be ignored. Two stress peaks at the overlap ends induce premature joint failure.
- Non-linear FEM considered elastic behaviour of adherends and plasticity of the adhesive and gave:
 - Completeness of model, joint response closer to reality.
 - Stress distributions were the same for linear and non-linear analyses.
 - Reduced stress values from calculations.

Linear analysis is valuable for optimising joint design and comparison of different solutions, but non-linear analysis is essential if reliable quantitative results are needed.

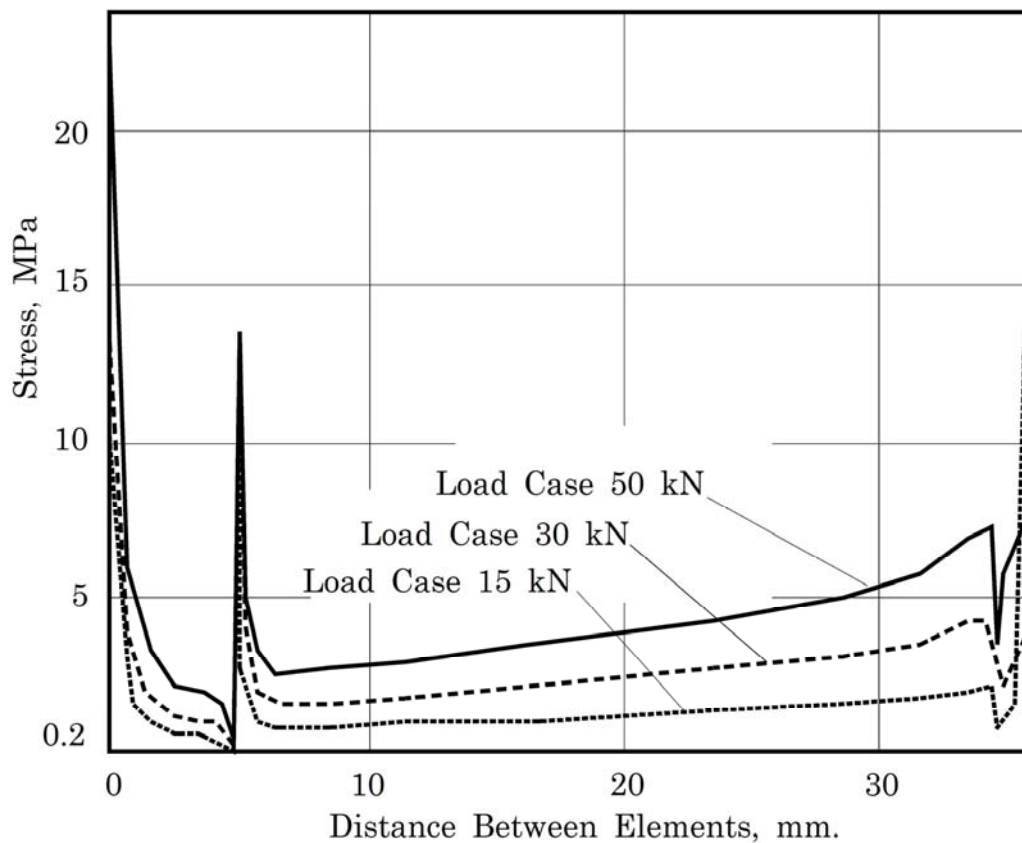

Figure 21.6-2 - Case study: CFRP tube/titanium fitting - tensile stress distribution in adhesive layer

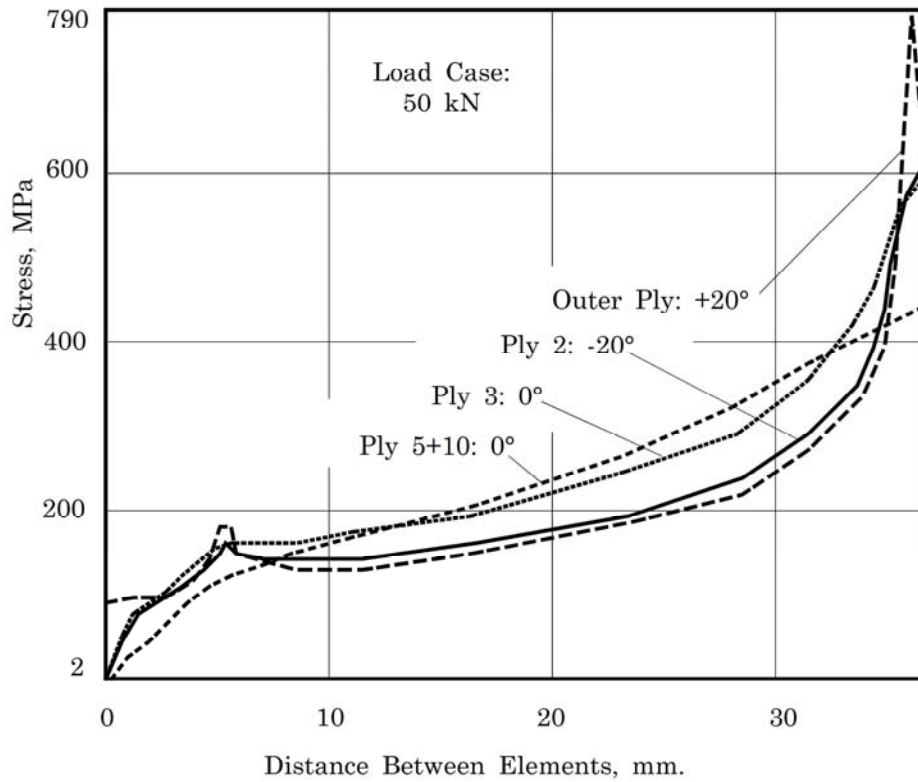

Figure 21.6-3 - Case study: CFRP tube/titanium fitting - tensile stress distribution in composite

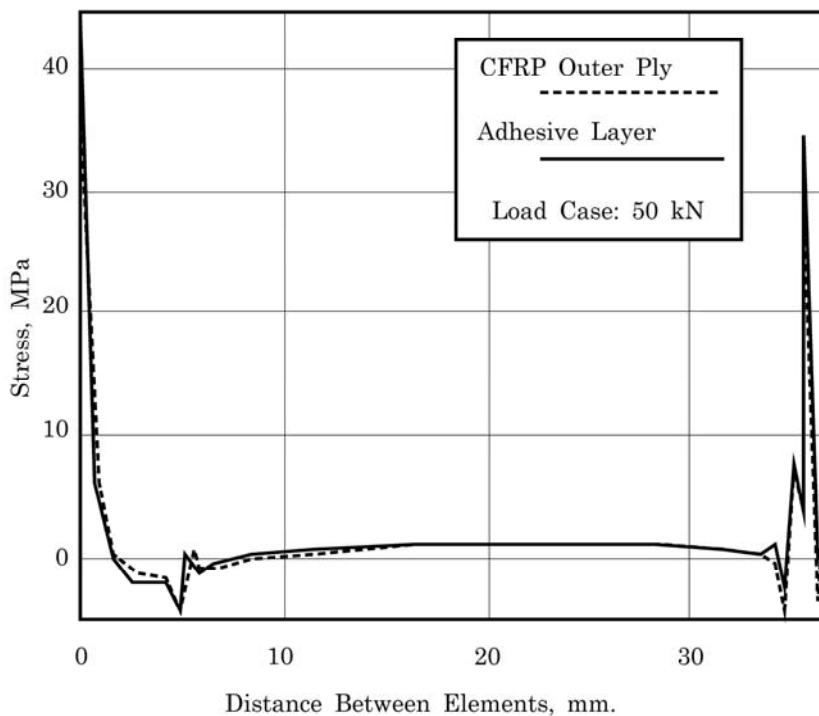

Figure 21.6-4 - Case study: CFRP tube/titanium fitting - peel stress distribution in adhesive layer and composite external ply

21.6.8.3 Stiffness analysis

Figure 21.6-5 shows the analytical notation for the strut sections.

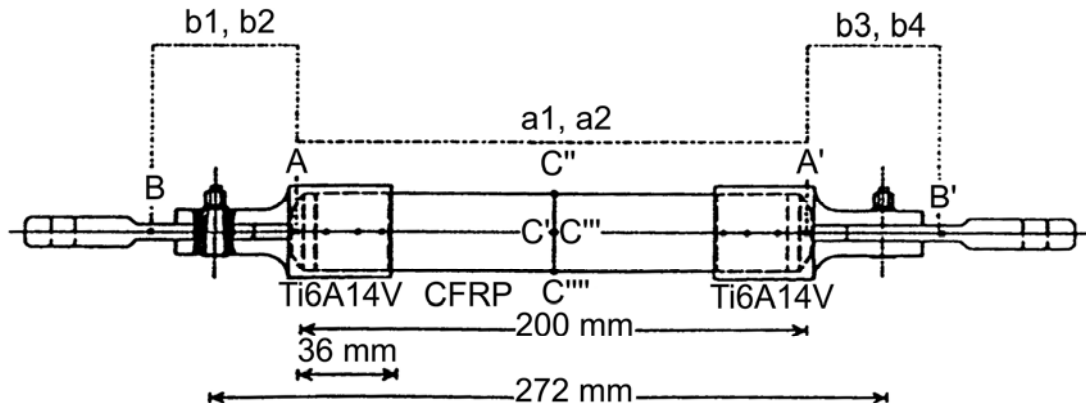

Figure 21.6-5 - Case study: CFRP/titanium end-fitting - analytical notation

The stiffness of the strut was modelled by FEM (bonded joint + mechanical fasteners), compared with experimental results and the model corrected; as shown in Table 21.6-2.

The results show that:

- fastener stiffness A-B and A'-B' were overestimated, so the model was adjusted slightly,
- corrected model was proved reliable when used to predict results for vibrational sinusoidal tests during the qualification stage of the real structure with this type of joint. The calculated frequency accuracy was better than 1%.

Table 21.6-2 - Case study: CFRP/titanium end-fitting - stiffness analysis results

Strut section	Stiffness, $\times 10^8$ N/m		
	Theoretical	Experimental	Corrected theoretical
A-B	3.97	1.67	1.86
A'-B'	3.97	2.12	1.86
A-A'	1.68	1.67	1.68
B-B'	0.908	0.641	0.60

21.6.9 Manufacture

21.6.9.1 Test specimens

A total of 8 test specimens, each consisting of a 200 mm long composite tube with an end-fitting bonded on each end were produced.

The manufacturing process is shown in Figure 21.6-6.

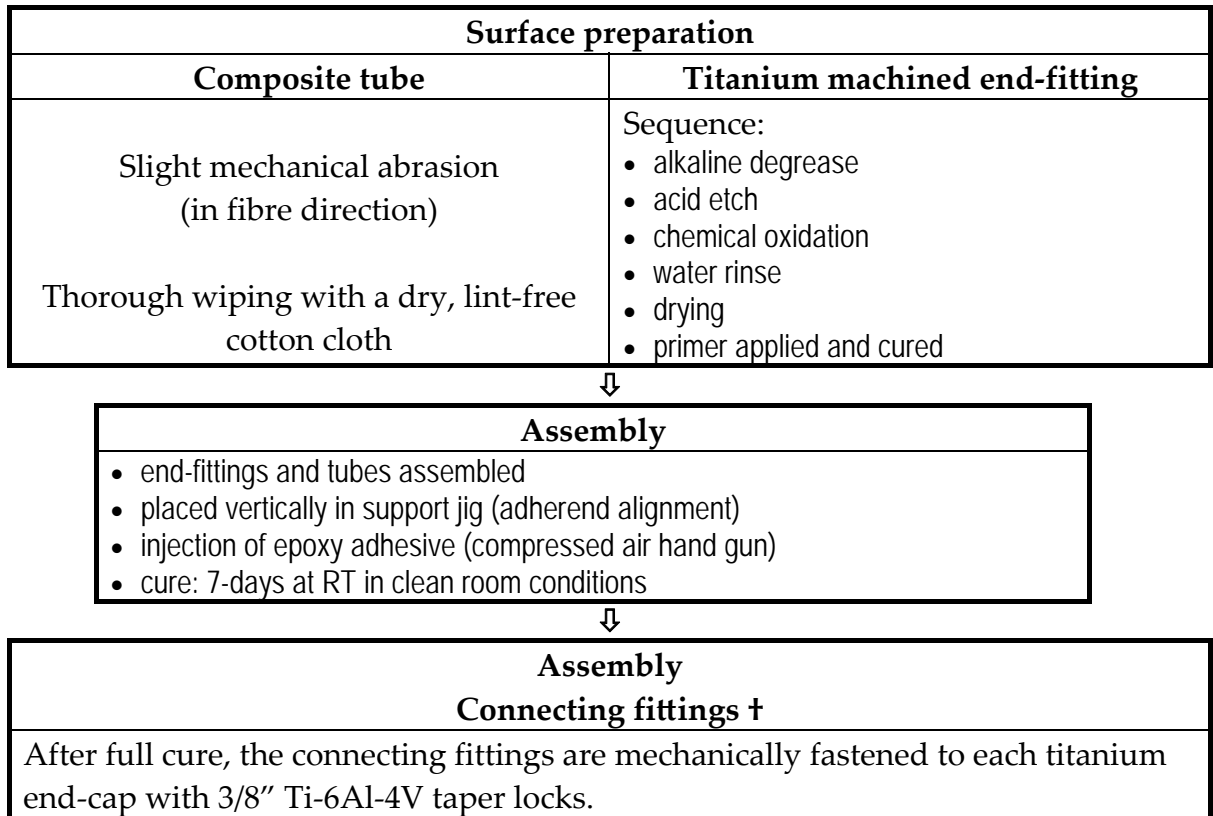

Key : † Connecting fittings are mechanical attachments of the struts to the nodes of the real structure. They are an integral part of the test specimen and their contribution to stiffness was measured during mechanical testing.

Figure 21.6-6 - Case study: CFRP/titanium end-fitting - manufacturing procedure

21.6.10 Test

21.6.10.1 General

An extensive test programme included:

- stiffness measurements in tension (15000N) and compression (-150000N),
- ultimate strength measurements under tensile axial loading.

21.6.10.2 Instrumentation

CFRP tubes were strain gauged at quadrants to mid-section; shown as position C in Figure 21.6-5, to measure composite deformation and to detect tube misalignment.

LVDTs mounted on strut sections measured the contribution to overall stiffness from adherends, bonded joint and mechanical joint. The LVDT positions and measurements were:

- at positions a1 and a2 (central), measurement of the sum of deformations of CFRP tube + bonded joint, between A-A',
- at positions b1 and b2, measurement of deformation of mechanical joints A-B,
- at positions b3 and b4, measurement of deformation of mechanical joints A'-B'.

21.6.10.3 Test results

The tests results can be summarised as:

- the CFRP tube showed perfect elastic behaviour in tension and compression,
- linear behaviour was seen at A-A', which contained the bonded joint,
- slight deviation from linearity was seen in tensile tests at B-B' (containing mechanically fastened joint),
- mechanical joints accounted for nearly all of the 60% of the strut overall deformation (rather than material deformation),
- failure tensile loads:
 - mean: 50400 N.
 - standard Deviation: 1800 N.
 - number of tests: 8.

Bonded joint strength was superior to the value needed.

21.6.10.4 Failure analysis

The failure analysis can be summarised as:

- all specimens failed in the bonded section by composite **delamination**, which affected the external $\pm 20^\circ$ plies,
- failure began at the end of the adhesive overlap (probably peel stresses, as shown in the analysis),
- without 0° plies in contact with the adhesive, the 20° ply shear strength was poor and the faying area prone to interlaminar shear fracture,
- **peel** loads; as summarised in Figure 21.6-7, the sequence of events was:

at the end of the overlap, peel loads caused matrix failure in the external ply. Consequently the stress distribution in the composite changed and the tensile stress further increased in the outer ply,

fibre final fracture in tension,

composite delamination, caused by the interlaminar shear strength reduction.

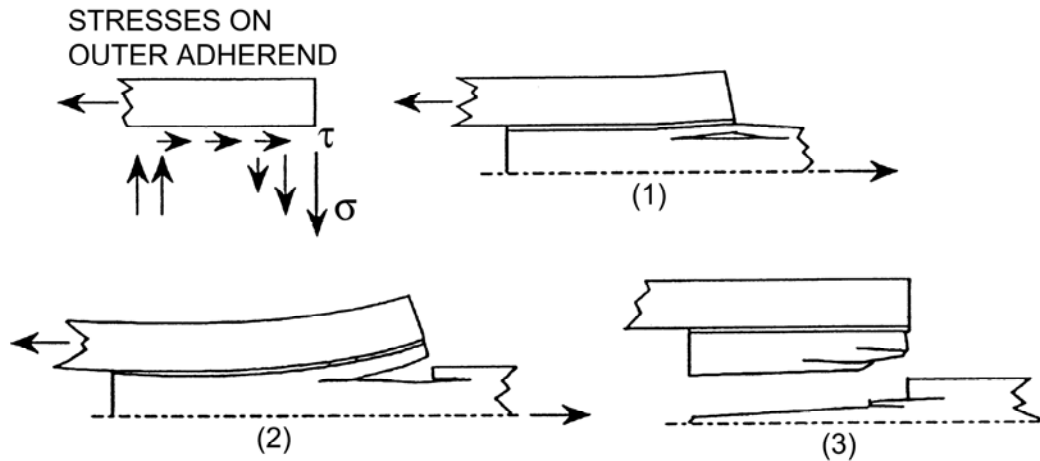

Figure 21.6-7 - Case study: CFRP/titanium end fitting - bonded joint failure mechanism

21.6.11 Inspection

No details given.

21.6.12 Conclusions

The main conclusions of the work included:

- suitability of the joint design was confirmed by mechanical tests,
- measured properties met the initial stiffness and strength criteria, i.e. strength in excess of 30100N whereas the mean strength achieved was 50400N,
- the type of joint failure suggested some general design considerations or modifications,
- minor design modifications:
 - change in the design of the adherend free-ends.
 - introduction of external plies in the load direction.
- substantial design modifications, using other joint configurations to reduce peel, stress concentrations in the adhesive, e.g. scarf joint; which approaches the maximum efficiency.

A change to scarf-type joints needs extensive and expensive adherend manufacturing, strict control of assembly procedures and therefore impair cost-efficiency of the joint concept.

21.6.13 Comments on case study

The case study illustrates the secondary bonding of a typical component part (strut member) of a lightly-loaded space structure.

High dimensional stability and stiffness are the governing design criteria, rather than high strength. The stiffness and CTE imbalance between metals and composites needs to be reduced to a minimum, hence the use of titanium alloys for the end-fitting.

An RT-curing **paste** adhesive was selected where dimensional stability was critical or where assembly procedures could not provide precise **bondline** control and pressure application; implying that film adhesives with elevated temperature and pressure curing cannot be used.

The stiffness demands were met with the metal-CFRP design, but the strength exceeded the desired value considerably.

The mode of failure highlights the need to ensure that the composite lay-up is tailored for adhesive bonding. Also, that peel stresses (a common problem in single overlap type joints) are considered in the analysis of tubular joint design and modifications are considered to minimise them, possibly by tapering adherends. The use of an UHM composite probably exaggerates the problem.

The proposed redesign with a scarf joint, giving higher joint efficiency, can be the ideal solution mechanically, but complicates the manufacturing and is expensive, given that the demands were met by the simple overlap joint.

21.7 Ariane 5 ACY 5400 upper payload extension ring

21.7.1 Source

Contraves Space AG, Zürich- Switzerland.

Paper Presented at the 3rd European Conference on Launcher Technology, Strasbourg, December 2001.

21.7.2 Application

Structural bonded joint between aluminium flange rings and CFRP-skinned aluminium-honeycomb cylindrical shell, Ref. [21-6].

The 5.4 m diameter extension rings are produced in different heights to provide Ariane 5 with a flexible payload volume.

In the longest version, it is 5.4 m diameter and 2.0 m in height, the total structure weight is less than 250 kg.

21.7.3 Objective

The design-development study aimed to:

- minimise the component mass and costs within a project with very tight time constraints, i.e. 8-months,
- demonstrate mass and cost savings of bonded joints compared with mechanically-fastened joints,
- demonstrate performance of bonded joints compared with riveted joints,
- develop and demonstrate reliability of serial manufacturing of bonded joints for large structures.

21.7.4 Concept

The ACY5400 is an external structure of the upper part of the Ariane 5 launcher, as shown in Figure 21.7-1, Ref. [21-6].

The assembly comprises of cylinders of different heights, i.e. 0.5m, 1m, 1.5m or 2m, depending on the launcher configuration. This enables more flexibility for the Ariane-5 payload volume.

Figure 21.7-2 shows the overall concept, Ref. [21-6].

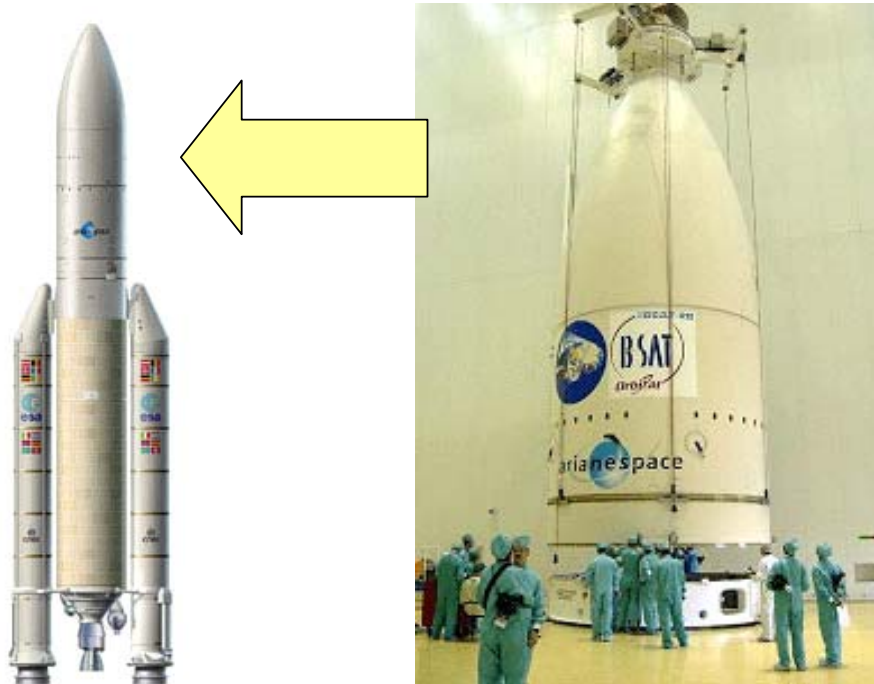

Figure 21.7-1 – Case study: Ariane 5 ACY 5400 - location

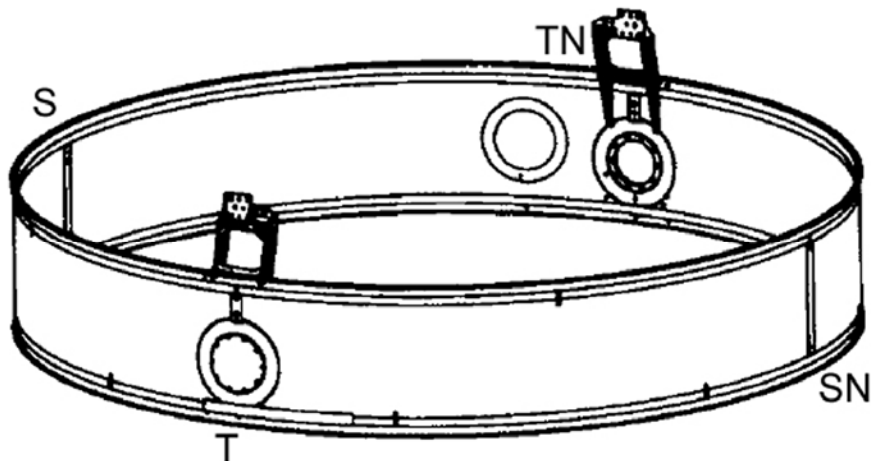

Figure 21.7-2 – Case study: Ariane 5 ACY 5400 - concept

The shell is made from **CFRP** skins (1.1 mm thick) with an aluminium **honeycomb** core of thickness 22.8 mm. The **sandwich** cylinder is adhesively-bonded to the upper and lower aluminium alloy attachment rings.

The interface ring-to-shell joints are solely bonded using an **epoxy**-based adhesive cured at room temperature. This reduced costs and avoided the need for extra equipment and processes.

Within the Ariane programs, it is the highest strength joint yet developed between metallic and composite components.

21.7.5 Joint design and analysis

21.7.5.1 General

Numerous factors were considered with respect to their application within large, highly-loaded joints, [See also: Manufacture].

Figure 21.7-3 shows a sectional view of the bonded joint detail, Ref. [21-6].

Some of the features include:

- tapered aluminium fitting to reduce peel,
- optimised stiffness-ratio between the rings and the **sandwich** structure to enable load distribution and reduce load concentrations.

In lightweight assemblies, local deformations cannot be ignored in highly-loaded joints because these have significant effects on **peel** and bond strengths.

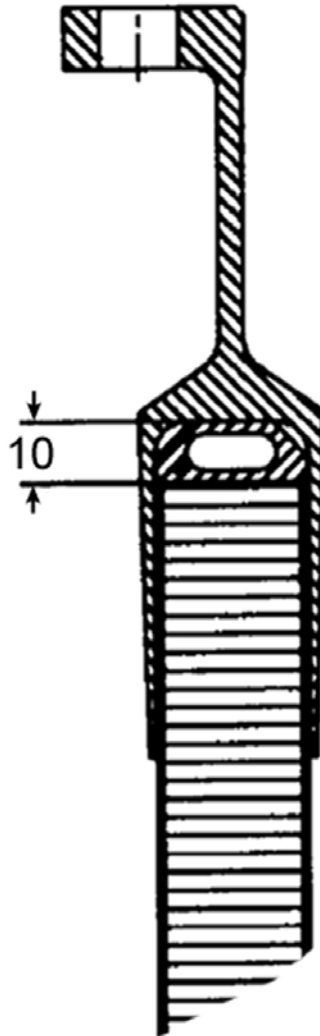

Figure 21.7-3 – Case study: Ariane 5 ACY 5400 - sectional view of bonded joint

Figure 21.7-4 shows that connections without any form fitting can result in large variations of:

- **bondline** thickness: variations between 0.2 mm and 0.7 mm,
- symmetrical axial loading: up to 15% between facesheets.

Variations from the nominal design are incorporated in the analysis and verification to determine tolerances.

The bond design was optimised in three main ways, [See also: Manufacture]:

- facesheet surface properties and preparation (grinding),
- aluminium surface treatment,
- adhesive selection.

All of these factors were influential.

The development was made using mainly representative components, in which all details of the joint were present, [See also: Test].

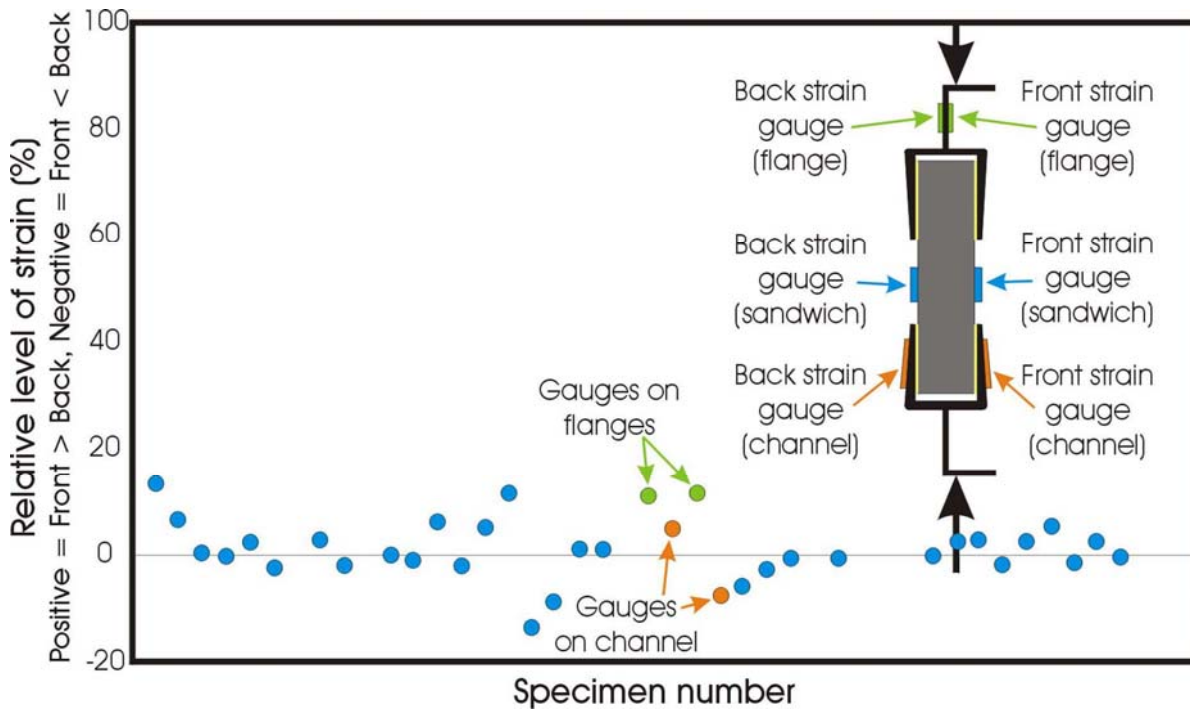

Figure 21.7-4 – Case study: Ariane 5 ACY 5400 - effect of bondline thickness

21.7.5.2 Loading

Simple shear load evaluation cannot be applied to such large joints, e.g. as used for fasteners and inserts. Some of the additional considerations included:

- flatwise tensile loading, i.e. yield, peel,
- effect of components perpendicular to main load axis,
- local stress concentrations, i.e. within the adhesive.

21.7.5.3 Failure modes and criteria

Cohesive-type failures within the adherends can be predicted by failure criteria provided that the precise conditions are known, e.g. humidity.

Adhesive failure, resulting from improper surface preparation, is not predictable, so verification by test is necessary.

21.7.5.4 Calculation and analysis methods

Hand calculations, based on empirical formulae, can be used to evaluate shear-stress peaks in bonds. Iterative programs that include non-linear shear stress characteristics of the adhesive can also be used.

21.7.5.5 Finite element analysis

Bonded joints can be simulated with complex FE models. Stress distributions can be determined using correct adhesive material models and non-linear solvers.

Failure criteria can be applied if all the necessary parameters are known.

Figure 21.7-5 shows a very detailed FE model of the ACY5400 bonded joint. Here, only half of the joint with the aluminium flange and the sandwich is represented.

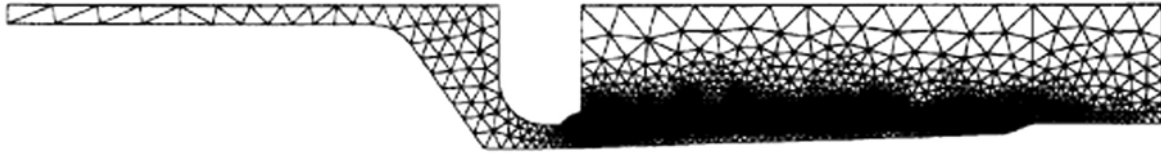

Figure 21.7-5 – Case study: Ariane 5 ACY 5400 - example of (half) FE model for joint

FE methods are useful during design studies for comparisons between different designs and configurations, but cannot evaluate absolute margins.

In general, prediction of the performance of large highly-loaded joints is very difficult due to the extreme complexity of parameters that are taken into account. Consequently, verification is performed by testing.

21.7.6 Manufacture

21.7.6.1 General

The joint strength can be affected by many process-related parameters, including:

- precise manufacturing process and conditions,
- surface preparation, of both metal and composite adherends,
- method of applying the adhesive,
- curing (initial and use of a post-cure).

Quality control is a major task for high-strength bonded joints in which the resulting joint performance is very sensitive to the process parameters. The tasks include:

- adhesive evaluation, using standard tests to determine the mechanical characteristics. The results are then used to determine margins of safety,
- verification programme, strictly controlled by product assurance regulations, which covers all aspects of the design-development and production phases.

The final joint design allowables are very sensitive to the manufacturing stage; consequently successful bonding relies on a proper evaluation of the parameters during development to ensure that adequate process control is established.

A further point to be considered is the move from manufacturing of a 'single unit' to 'serial production'. In developing the processes, their suitability for automation should be considered and any adverse affects on bond performance evaluated thoroughly, [See also: Production test].

21.7.6.2 Manufacturing process and conditions

Adhesive selection is determined by the type of adherends to be bonded, joint function, e.g. structural and load-bearing demands, suitable manufacturing equipment and cost. Manufacturing processes are strongly associated with the selected adhesive.

For ACY 5400, with its demand for high-strength bonded joints between large composite and metal components, the choice of a space-approved adhesive with adequate performance is somewhat limited.

The room temperature curing epoxy-based adhesives considered are shown in Table 21.7-1.

Table 21.7-1 – Case study: Ariane 5 ACY 5400 - potential adhesives

Adhesive product name	Supplier	Comments
EA9394	Hysol	RT cure
EA9392	Hysol	RT cure
Araldite® 2014	Vantico	RT cure
Redux® 312	Hexcel	RT cure

Room temperature curing is of particular importance for structures too large to fit inside conventional-sized autoclaves and also to avoid local thermal distortion of the structure caused by heated blankets, [See also: Cure].

The size of the assembly and suitable equipment is a consideration as to whether a joint can be successfully post-cured or not.

Some additional factors that were influential on bond performance included:

- working conditions, e.g. temperature and especially humidity, can have a profound effect on the resulting adhesive bond, so need careful control. This was achieved for ACY 5400 by using clean-room facilities in which the environment is controlled. Handling of parts is also carefully monitored to avoid contamination of prepared surfaces,
- lead time, e.g. delay between surface preparation of metal components and bonding. Acceptable lead times are established as part of the manufacturing process control procedures because oxidation of prepared surfaces can have a significant affect on bond performance.

21.7.6.3 Surface preparation

The surface preparation of adherends is known to have a crucial effect on the mechanical characteristics of bonds, both initial and long-term. This is especially true of highly-loaded joints.

Different types of adherends need a different surface preparation methods. Over the years significant effort has been placed on optimising methods for aerospace materials, e.g. frequently-used metal alloys and composites.

Although chemical-based methods, such as etching and anodising, are known to give strong, durable bonds, the size of the metal ring components in ACY 5400 rendered this impracticable.

Instead abrasion techniques, both manual and automated, were evaluated.

The surfaces of composite materials are often prepared by solvent cleaning and abrasion techniques, whereby contaminants are removed by the solvent and the surface resin content of the composite reduced without damaging the reinforcement fibres close to the surface.

The surface resin content is known to affect flatwise tensile properties and peeling.

For ACY 5400 sandwich components, a manual abrasion technique was used because this enabled control of the process.

Whilst surface primers can aid bonding and provide protection of prepared metal surfaces, their application increases both cost and production times. Consequently, no primer was used for ACY 5400 metal rings.

Primers are not usually used on composite materials.

21.7.6.4 Adhesive application method

For large bond areas, commonly used methods for applying paste-type adhesives, e.g. by brush or roller, can be difficult to control.

Injection of adhesive through holes in the ACY 5400 assembly proved more reliable. It also enabled a uniform **bondline** thickness to be achieved and meant that the structure was pre-assembled and aligned before bonding.

21.7.6.5 Cure

A room temperature curing **epoxy** adhesive was used to assemble the ACY 5400 structure. Although a post-cure at elevated temperature, usually conducted in an autoclave, can enhance the high-temperature performance, this relies on the availability of suitable equipment. For large structures, it is not feasible, so a local-heating method, e.g. with hot blankets, can be considered providing that local heating does not distort the structure, [See: Manufacture].

21.7.7 Assembly

Pre-assembly and alignment of the ACY 5400 prior to bonding was possible because the adhesive was injected. This method is of particular interest for maintaining bondline thickness control of large structures that can be difficult to handle and align if a paste adhesive is applied by brush or roller.

21.7.8 Inspection

Quality control was assured using four samples manufactured under the same conditions and at the same time as each global item. These samples were flat but their representativeness was demonstrated through qualification tests of the whole structure.

21.7.9 Test

21.7.9.1 General

Prediction and verification of bonded joints cannot be achieved by analytical methods only. A comprehensive testing programme is therefore essential. The development programme of ACY5400 had three different verification tests:

- component tests,
- in-process samples tests,
- full-scale qualification tests.

Owing to the tight programme schedule, the serial production started before the qualification of the structure was achieved. Testing on the early production units contributed to the qualification process.

21.7.9.2 Component tests

Component tests are relatively cheap and can give a good overview of the behaviour of bonded joints. It is however very difficult to apply realistic load conditions and to guarantee representativeness.

21.7.9.3 Witness (in-process) samples

Witness samples, also known as 'in-process', are made from exactly the same materials as those used in the structure, e.g. facesheet, **sandwich** and metals, and undergo exactly the same preparation processes as the full-scale structure, e.g. aluminium fitting, grinding, facesheet preparation, cleaning, storing, adhesive injection, curing. These samples, although flat rather than curved, are then acceptance tested, as shown in Figure 21.7-6.

Witness samples were the same as the development **bondline** component samples used in the project.

The acceptance criteria established were:

- tensile proof load test passed,
- average series result not more than 10% below expected value (compressive test),
- single result below acceptance value (compressive test).

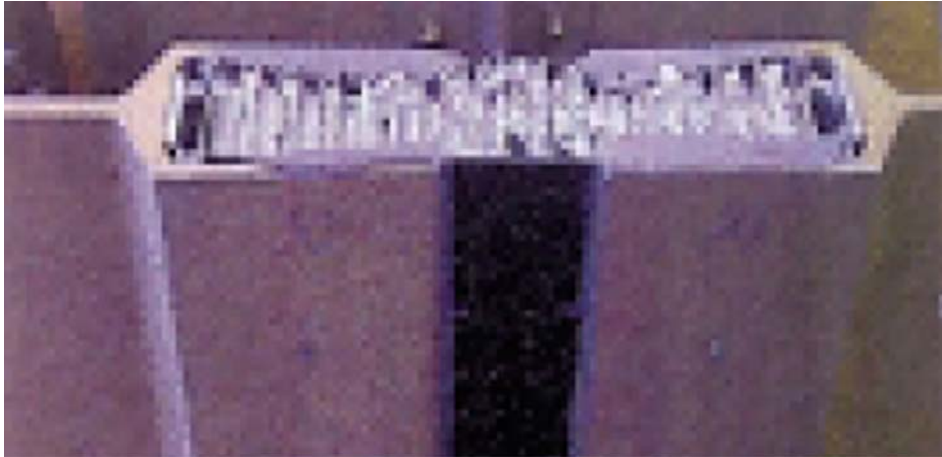

Figure 21.7-6 – Case study: Ariane 5 ACY 5400 - witness sample under test

It is very important that samples represent the real structure and this cannot be ignored. During the qualification program for ACY 5400 the ‘qualitative representativeness’ was ensured. The witness (in-process) samples and full-scale rupture test on the qualification model showed rupture loads within 5%.

21.7.9.4 Full-scale qualification test

Structural qualification tests are necessary to prove the overall structural ability by demonstrating sufficient strength with certain margins under realistic and complex loading conditions. In order to verify the structural strength of ACY 5400, several scenarios were tested covering a large section of the bonded joint subjected to ultimate loads.

A typical load case for Ariane-5 launcher environment is shown in Table 21.7-2.

Table 21.7-2 – Case study: Ariane 5 - typical static load case

Global load	Force or Moment
Bending	8135.7 kNm
Axial force	1314.0 kN
Shear force	648.0 kN

21.7.9.5 Production test

Usually in a launcher project, the transition to serial production is made after the qualification is achieved. In the design-development of ACY 5400, the timescale of 8-months prevented this.

Results from early production testing proved a valuable source of data regarding the move towards serial manufacturing. Experience gained from the investigation highlighted the approach used to successfully resolve such problems.

A loss in performance, attributed to the implementation of serial manufacturing methods, was seen between various models under test.

After investigation, the two apparent rupture levels were attributed to a different failure mode occurring, i.e.:

- failure type-1 (1000 N/mm): Fracture of facesheet, showing that the bond is stronger than the structure,

- failure type-2 (500 N/mm): Adhesive fracture in the bond, resulting in clean aluminium surfaces on one side and sandwich delamination on the other,
- detailed examination of the bond fracture surfaces showed:
 - metal components, where the presence of residual Alodine coating was responsible for failure type 2. The presence of Alodine is difficult to detect by visual inspection. The automated surface preparation was not as efficient at removing it compared with the manual preparation method used during development. As a result the adhesion between the adhesive and the aluminium fittings was significantly degraded.
 - composite materials, where the prepared composite surface showed evidence of circumferential cracks along the bonding edges and breaks in many carbon fibres on the outer layer (in the flight direction). These were attributed to the automated abrasion technique having a tangential direction which disrupted the first ply of the M40J prepreg tape, causing unacceptable levels of fibre breaks and cracking.

21.7.10 Conclusions

21.7.10.1 General

As of 2001, 6 ACY 5400 upper payload extension rings have been manufactured of which 5 have flown.

In the longest version, it is 5.4m diameter and 2.0 m height, the total structure weight is less than 250 kg.

21.7.10.2 Mass comparison

In comparison with a conventional riveted assembly, the bonded joint configuration demonstrated several advantages; as summarised in Table 21.7-3.

Table 21.7-3 - Case study: Ariane 5 ACY 5400 - comparison between bonded and riveted assembly

Parameter (*)	Adhesive bonded	Riveted	Comments
Mass (total kg) ⁽¹⁾ comprising of: metal ring fitting fastening sandwich (reinforcement)	182.5	206.5	
	84	80	
	10 (adhesive)	13 (rivets)	
	71	96	
Compressive strength (max.)	-1156 N/mm	-	19.5 MN pure axial compression
A-value (failure mode 1)	-727 N/mm	-	Composite facesheet fracture
A-value (failure mode 2)	-365 N/mm	-	Adhesive failure
Manufacturing	1 week (approx.)	-	3-days surface preparation; 2-days adhesive injection + 1-day cure at RT
Costs	10% (approx.) less than riveted concept		Development of bonding more expensive than riveted concept.
Reliability	Strict process control necessary	-	Surface preparation Bonding
Key: (*) assuming the same load; (1) mass of electrical system (7.5 kg) and 'other' (10kg) are identical for both adhesive and riveted configurations			

21.7.10.3 Strength

Based on the compressive strength values given in Table 21.7-3, a value of -365 N/mm in the upper parts of a launch structure is considered to be 'high'. Given that the adhesive failure mode can be eliminated by proper surface preparation, the -727 N/mm **A-value** is more realistic. It is unlikely that riveted joints can achieve such high-levels of load transfer.

Under other loading directions, especially where **peel** can occur, the joint strength can be reduced. Peel effects are best avoided by proper design and, if possible, selection of higher peel-resistant adhesives. Some adhesives exhibit higher peel resistance but have reduced lap shear strengths.

Owing to concerns regarding the strict control necessary for adhesive bonding, a bolted joint concept was adopted. This used bonding between composites but using an autoclave process. Also, a less mass-critical condition was achieved for the higher performance new Ariane 5.

21.7.11 Comments on case study

The ACY 5400 design-development programme showed that bonded joints are feasible for large, highly-loaded space structures.

It also provided valuable insight into factors that need full consideration when moving from 'single unit' to 'serial production' of such structures and how they can be resolved successfully.

It demonstrated adhesive bonding to be the lightest, fastest and most economical way of producing joints, although the preparation and QA effort remained a significant cost factor.

21.8 SRM - solid rocket motors: Flexible joints

21.8.1 Source

- SNECMA Moteurs, Le Haillan, France
3rd European Conference on Launcher Technology, Strasbourg, December 2001, Ref. [21-7].
- EADS Launch Vehicles, Saint Médard-en-Jalles, France.
SAMPE European Conference and Exhibition, Paris, 200?, Ref. [21-8].

The case study illustrates the approach of EADS-LV and SNECMA in the design-development of adhesive bonded flexible connections on SRM constructions, based on their experience of solid propulsion motors for military applications.

21.8.2 Application

21.8.2.1 General

Solid propulsion and solid rocket motors are complex constructions with component parts made of different types of metals, polymers, elastomers and high-performance fibre-reinforced plastics. These materials are often joined by bonding rather than by mechanical fastening, Ref. [21-7].

The increasing use of composite materials, usually in the form of filament-wound cases, means that bonding is preferable to mechanical fastening providing that the resulting bonds meet the mechanical performance and durability demands, Ref. [21-7], [21-8].

21.8.2.2 Flexible joints

Figure 21.8-1 shows the position of flexible joints in an example design, Ref. [21-7]. These are:

- joint between the skirt and the case,
- polar boss to case junction, flexible bearing.

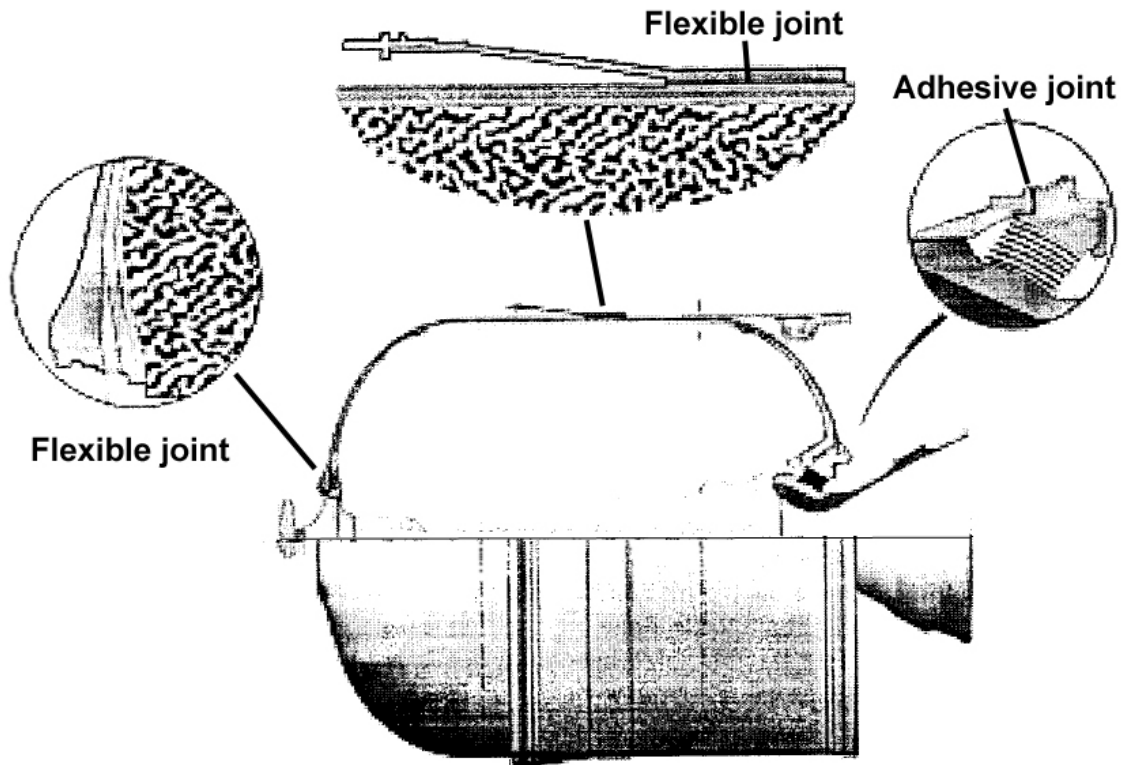

Figure 21.8-1 – Case study: SRM – position of flexible joints

21.8.3 Objective of study

The design-development of adhesively-bonded flexible connections on SRM constructions; based on solid propulsion motors for military applications.

21.8.4 Parameters for design

21.8.4.1 General

The parameters are often based on those from similar applications or from the project pre-design analysis, for example:

- Mechanical performance, e.g. ultimate loads, factor of safety and knowledge of stress concentrations,
- Service, e.g. pressure cycles, thermal conditions and service life,
- Manufacturing, e.g. materials to be bonded (adherends), adhesives, processes.

21.8.4.2 Design approach

Figure 21.2-2 summarises an example of the design approach for flexible joints on SRMs, Ref. [21-7].

Whilst some aspects of the approach are similar to the design of structural bonded joints, additional factors need to be taken into account regarding the flexibility needed within junction

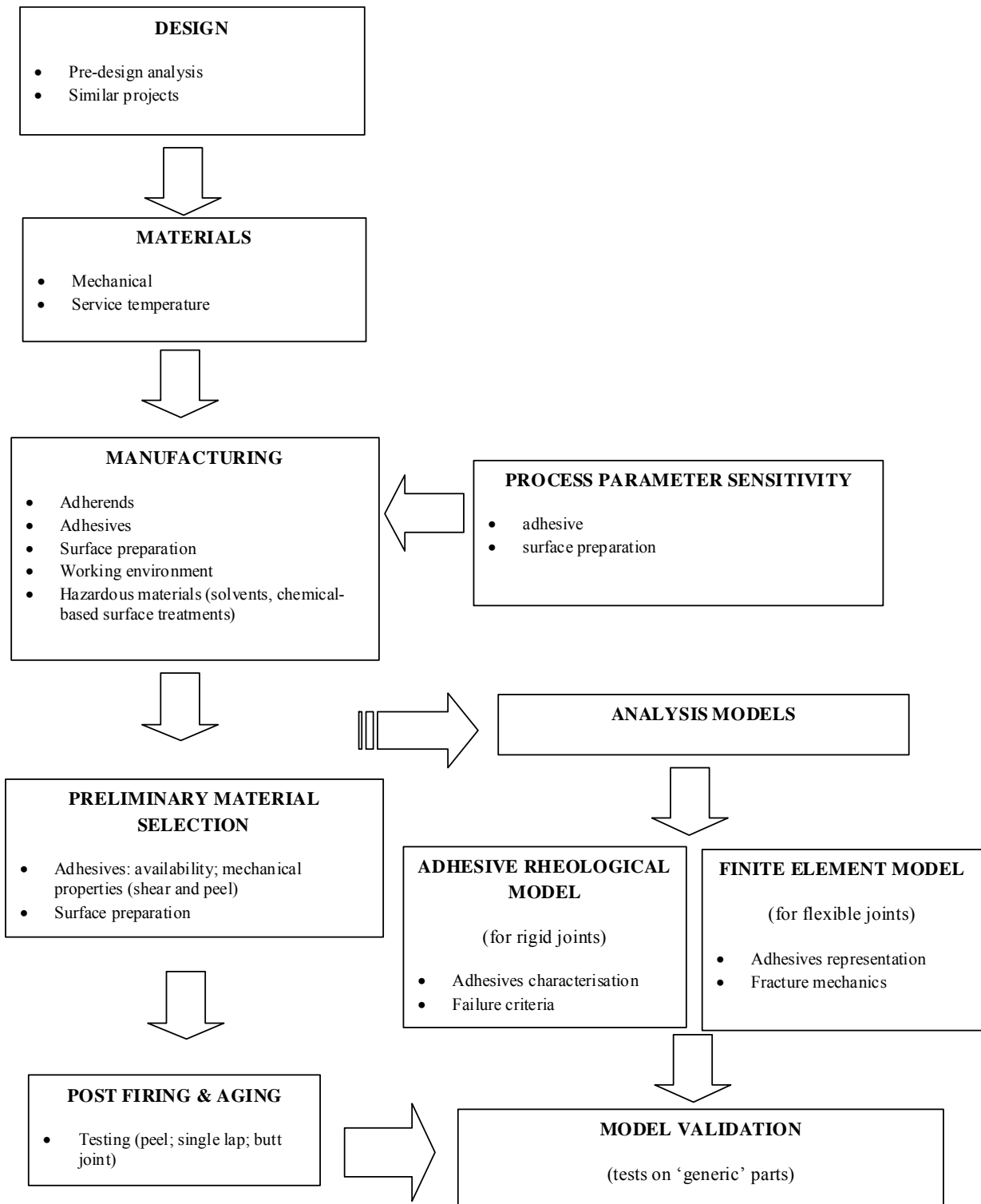

Figure 21.8-2 – Case study: SRM flexible joints – example design approach

21.8.5 Concept

In general, a motor case comprises of a pressurised vessel that is attached to a skirt, which is in turn fixed to a support structure. The displacement of the case, e.g. caused by pressurisation or temperature, results in dimensional changes that need to be accommodated by the case-to-skirt joint. The joint also needs to be flexible and enable load to be transmitted to the support structure via the skirt.

Flexible joints can be achieved by placing an elastomer (rubber) between the skirt structure and the case; as shown in Figure 21.8-3, Ref. [21-8]. The elastomer is adhesively bonded on both sides, e.g. to the skirts and to the case.

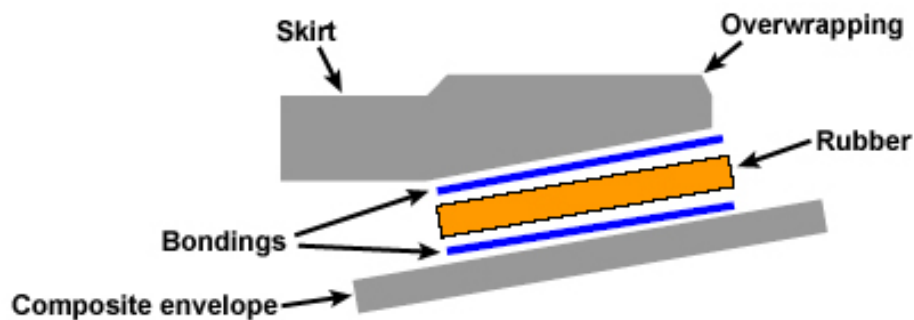

Figure 21.8-3 – Case study: SRM – example of flexible joint concept

21.8.6 Materials

21.8.6.1 General

Depending on the particular design, the materials encountered in flexible joints can be:

- Case, e.g. :
 - metal (Al-alloys, Ti-alloys, steel).
 - composite, e.g. **filament wound** cases or overwrapping on metal liners.
- Skirt, e.g. metal alloys or composite,
- Boss, e.g. metal alloys,
- Adhesive, e.g. 3M EC 2216, Ref [21-7],
- Elastomer (type not stated).

21.8.6.2 Adhesive selection

Factors considered in the selection of adhesives include:

- Substrates to be bonded, e.g. types of material; geometry: size, shape, tolerances; accessibility; resistance to heat and pressure (during cure and in-service); thermal expansion coefficients, including differences between substrates to be joined,
- Commercial availability of an adhesive throughout the production life,

- Manufacturing-related, e.g. pot life, cure (temperature and pressure); bondline thickness; viscosity; surface preparation processes,
- Mechanical performance, e.g. strength related to glass transition temperature (lap shear strength, peel, wedge tests). The SNECMA approach screens adhesives with respect to:
 - ultimate stress criterion from preliminary design taking into account factors of safety.
 - fracture toughness for necessary energy release rate corresponding to nondetectable defects by NDI.

For filament-wound substrates, screening adhesives to assess peel strengths using a hoop-shaped test specimen can be considered, Ref. [21-7].

21.8.7 Joint design

An example of a flexible joint design between a case and skirt is shown in Figure 21.8-4, Ref. [21-8].

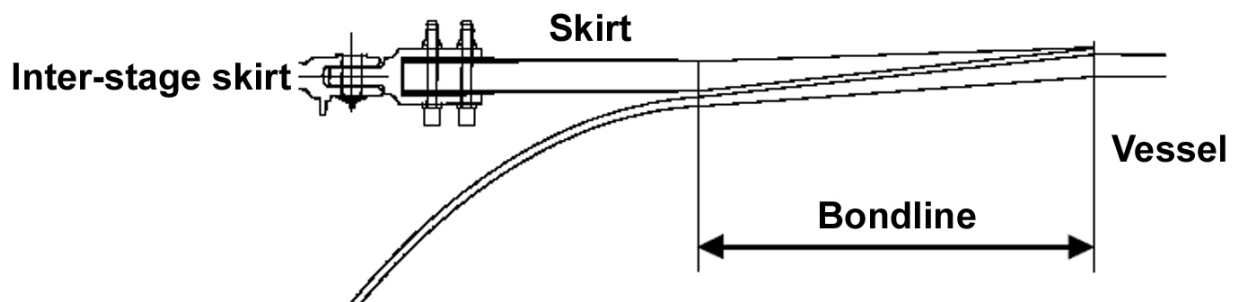

Figure 21.8-4 – Case study: SRM – example of flexible joint design

21.8.8 Analysis

A variety of analytical techniques can be applied to SRMs, including:

- Adhesive rheological model: more appropriate to rigid joints, e.g. bonding nozzles, rather than in flexible joints, where the elastomer plays this role. From experimental evaluation, the mechanical behaviour of an adhesive can be expressed as a non-linear elastic Mooney-Rivlin rheological model, with damage effects on bulk modulus, Ref. [21-7],
- Finite element models, Ref. [21-7], [21-8]:
 - nozzle-related, based on MARC finite element code (MSC Software), Ref. [21-7].
 - adhesive-related: Some FEM analyses link nodes from both adherends and aim to interpret node reactions as bondline loads. Owing to the differences in stiffness between the adherends (metal or composite) and adhesive, the results tend to be unreliable. Including the adhesive in the model (meshing) is somewhat difficult because the adhesive layer is thin (0.2mm to 1mm, typically), Ref. [21-7].

- Fracture mechanics model (strain energy release rate, G by J-integral calculation): Developed by SNECMA to predict stress concentrations in bonds after motor firing where bond failure occurred. This approach has been applied to, Ref. [21-7]:
 - analysis of rigid joints (nozzles) with high stress concentrations or large bond defects detected by NDI.
 - adhesive failures in flexible joints.

Models are validated by testing to failure of 'generic' parts selected from the critical load cases determined from pre-design analyses. Generic parts are similar mechanically to real case loadings (stress field and failure propagation trend) but in which instrumentation is relatively straightforward and the parts are low cost and quick to manufacture, Ref. [21-7].

21.8.9 Manufacture

21.8.9.1 General

Numerous factors need to be considered in the development of manufacturing process procedures. A variation within one factor can result in significant scatter of the characteristics of adhesive bonds, e.g. mechanical performance or durability.

21.8.9.2 Surface preparation

Parameters associated with grit blasting that are known to have an effect on adhesive bonding include, Ref. [21-7]:

- grit material, e.g. corundum (alumina); sand; glass; metal beads,
- grit size and shape,;
- virgin or recycled grit media,
- process pressure and angle.

Primers can help reduce variations caused by grit blasting and improve bond **durability**. However, use of **primers** is another process that needs to be stipulated.

Peel plies and sanding are other surface preparation methods used in motor cases, Ref. [21-8]. Again, all process parameters should be stipulated and variations evaluated regarding bond strength and durability.

21.8.9.3 Adhesive bonding

Factors associated with bonding that are known to have an effect include, Ref. [21-7]

- shelf life (at stated storage conditions),
- warm-up time (from cold storage),
- mix ratio (two-part adhesives),
- pot life, as a function to working temperature and relative humidity,
- adhesive thickness,
- applied load during cure,
- cure temperature cycle.

21.8.10 Test

21.8.10.1 General

The various test methods used can be grouped as those related to:

- material selection, where tests aim to screen possible adhesives and provide an indication of their mechanical performance under envisaged service conditions, [See also: Adhesive selection],
- process selection: surface preparation, bonding and cure, [See also: Manufacture],
- performance of bond in real construction, i.e. post-firing.

21.8.10.2 Coupons

Tests are conducted to recognised standards, e.g.:

- adhesive screening tests, e.g.
 - lap shear to ASTM D 1002-72, ISO 4587.
 - peel test, such as floating roller-type, possibly combined with hot-wet conditioning, Ref. [21-8].
 - wedge test.
 - **filament-wound** hoop samples, Ref. [21-7].
- represent actual bond, e.g. combined materials in flexible joints,
- manufacturing-related, e.g. vertical bonding, working environment humidity and temperature.

21.8.10.3 Generic samples

These sample-types are used for model validation. They are developed to provide data for comparison with a particular model, e.g. adhesive rheological model, Ref. [21-7]:

- 'Althof' or thick adherend shear test, e.g. ISO 11003-2;
- Triaxial tensile test adapted from a 'poker chip' test configuration to limit shear at edges and ensure failure in the centre of the specimen;
- Pin test (adhesive) in triaxial compression;
- Contoured double cantilever beam, e.g. ASTM D3433;
- End notch flexure

FEM validation tests include:

- Quadruple shear test 'QS' to indicate weaknesses in bonds not shown in standard shear tests coupons or in standard peel tests, Ref. [21-8],
- Normal tensile test, e.g. to indicate behaviour under hydrostatic conditions, Ref. [21-8].

21.8.10.4 Scale and real size

Scale tests are used to determine behaviour and characteristics of the construction for justification and qualification of bonds, e.g.:

- in-house test specimen devised to represent shear and normal stresses encountered in the nozzle housing to divergent bonding, Ref. [21-7],
- evaluate configuration-related effects that cannot be easily simulated in laboratory coupon tests e.g. changes in winding angles, effect of post-proof test interlaminar microcracking. An example of this is a hydrostatic proof test on a reduced-scale component to instigate shear failure of skirt-to-vessel bonded joint, Ref. [21-8].
- hydro-proof tests to validate the design with respect to performance (loads, safety margins) and damage levels (determined by NDI).

21.8.10.5 Post-firing

These constitute a series of tests that aim to confirm mechanical performance of scale 1 parts with laboratory test coupons and to determine any changes during production, the effect of nonconformity (raw material or component level), effects due to aging, Ref. [21-7]. The test specimens used can be grouped as:

- flexible joint:
 - **Peel** test (90° roller peel type) to characterise the bonding between the elastomer and the structural part. Precautions are taken to ensure delamination in the composite is avoided. Peeling and failure mode are determined. A cohesive failure mode is stipulated.
 - Butt joint test to estimate normal stress at failure and to indicate the weakest component or interface within a joint configuration, e.g. composite-to-adhesive-to-elastomer construction.
- rigid (structural) joints:
 - modified single lap shear used to monitor any manufacturing-related changes in performance and aging effects.

21.8.11 Inspection

Both SNECMA and EADS-LV use non-destructive inspection techniques on motor cases and assemblies to determine defect levels, e.g. disbonds in bondlines. No details of techniques are given.

21.8.12 Comments on case study

Motor case designs have both rigid (structural) and flexible types of joints. The design approach for a flexible joint is different compared with a rigid joint, e.g. analysis models, material screening and property measurement.

Both SNECMA and EADS-LV have successful design concepts for flexible joints in motor case assemblies. Both use an elastomeric layer in the bondline to give a substrate-to-adhesive-to-elastomer-to-adhesive-substrate joint configuration. The substrate materials can be composite or metal, depending on the motor case application. Both organisations have developed SRM concepts from solid propulsion motor technologies used for military applications.

Both SNECMA and EADS stipulate a cohesive failure mode in motor case bonded joint concepts; for both rigid and flexible joints.

The analytical approaches used share similarities, e.g. use of **FE** and other models, where model verification is provided by testing at various levels. Both organisations cast doubt on the applicability of standard shear test data and have developed in-house or modified specimens to represent a particular joint design details. **Peel** tests are considered valuable for screening adhesives and evaluating bond performance.

Successful adhesive bonding relies on evaluation of process-related parameters and strict control measures are necessary.

21.9 References

21.9.1 General

- [21-1] Lockheed Missiles & Space Co. California
SAMPE Journal May-June 1987
- [21-2] British Aerospace, Space and Communications Division, Bristol
ESA SP-243 Workshop on Composites Design for Space Applications
- [21-3] Messerschmitt-Bölkow-Blohm GmbH, Ottobrunn, Germany
ESA SP-243 Workshop on Composites Design for Space Applications
& Composite Structures 6 (1986) p183-196
- [21-4] Westland Aerospace, IoW. UK
34th International SAMPE Symposium, 8-11 May 1989 &
ESA SP-336 (October 1992), p57-62
- [21-5] B. Fornari: Alenia Spazio/Politecnico di Torino, Italy
Paper presented at International Conference 'Spacecraft Structures
and Mechanical Testing', Paris, 21-24 June, 1994
- [21-6] R. Gonzalez, P. Vogt & A. Gonzalez: ONES\Contraves Space
AG\ESA
'Implementation of high-performance and reliable structural bonded
joints'
Proceedings of the 3rd European Conference on Launcher
Technology, Strasbourg, December 2001
- [21-7] D. Fontanet et al : SNECMA Moteurs, Le Haillan, France
'Design of Bonded Joints in Solid Rocket Motors'
Proceedings of the 3rd European Conference on Launcher
Technology, Strasbourg, December 2001.
- [21-8] J-M. Gautier : EADS Launch Vehicles, France.
'Rationale to Design Adhesive Bonding on Solid Rocket Motor Cases
at EADS Launch Vehicles'
Proceedings of SAMPE European Conference and Exhibition, Paris,
2003

22

Case studies on bonded structural materials

22.1 Introduction

22.1.1 General

The major uses of adhesive bonding technology in aerospace structures can be grouped as:

- assembly techniques: Bonded joints between manufactured components, either composite and metal components or, more often, composite to metal joints, [See: 21.1],
- manufacturing techniques, where joints are made between types of materials during the manufacture of a structural material. The prime example is the sandwich panel of which various types are used extensively in aircraft and spacecraft structures. Here the bonded areas can be extensive (although individual bondlines at cell walls can be small in comparison with the total area) and contribute to the whole material performance.

22.1.2 Sandwich structures

22.1.2.1 Secondary bonding

Sandwich construction was originally a secondary bonding application, where pre-cured skins were bonded onto the core.

22.1.2.2 Co-curing

Co-curing technology, where the laminate skins and adhesive are cured at the same time, is now much more common, largely because of the savings from reduced tooling and autoclave processing cycles.

An alternative co-curing route for producing **sandwich** panel components is to **filament-wind** the skins, gel the resin, assemble the core and then wind the outer skin. The whole item is then co-cured. This process is most appropriate for cylindrical objects. The tooling is limited to a winding mandrel. Although the filament winding can be automated (saving time and expense on ply lay-up), there remains a large manual labour input for core assembly, including adhesive core-to-core bonding and film adhesive for skin-to-core bonding.

22.1.3 Metal laminates

FML fibre metal laminates are laminates comprising of fibre-reinforced adhesive layers between aluminium sheets, [See: ECSS-E-HB-32-20: Structural materials handbook; previously ESA PSS-03-203].

The bonding of an aluminium-tantalum mixed-metal laminated structure for radiation shielding on interplanetary probes is described to illustrate the concept of bonded materials for a specific space application, [See: 22.5].

22.2 CFRP central cylinder for satellites

22.2.1 Source

CASA Space Division, Madrid, Spain.

ESA SP-336 (October 1992), p. 33-38.

22.2.2 Application

Central cylinder of telecommunications satellites, Ref. [22-2].

22.2.3 Objective of study

To establish the appropriate design and manufacturing techniques for a CFRP thrust cylinder. A CFRP version can offer improved specific strength and stiffness, hence mass-efficiency, compared with traditional aluminium designs.

22.2.4 Parameters for design

22.2.4.1 General

The design-development study used the criteria from the Artemis central cylinder (upper part only).

22.2.4.2 Functional

The criteria included:

- top-end flange, for connection to the Earth facing panel,
- bottom-end flange for connection to the lower cylinder and main platform,
- two mounting areas for connecting propellant tanks,
- two areas for attaching shear webs.

22.2.4.3 Stiffness

The static stiffness criteria were:

- Longitudinal $K_c \geq 145$ MN/m.

- Transverse $K_c \geq 16.0$ MN/m.
- Torsion $K_g \geq 13.0$ MN/m/rad.

When loaded, the natural frequency in each lateral direction was to be less than 25.6 Hz.

22.2.4.4 Strength

The cylinder had to withstand the stated design loads without permanent deformation or failure. To minimise weight, the smallest permissible margin of safety was used.

22.2.5 Concept

22.2.5.1 General

In axial compression primary structures, the structural concepts are commonly:

- monocoque reinforced skins,
- sandwich shell,
- reinforced corrugated skins.

A comparison of these concepts is shown in Table 22.2-1.

Table 22.2-1 - Case study: CFRP central cylinder - trade-off between design concepts

	Sandwich	Corrugated	Monocoque reinforced panels
Experience	Yes	No	Yes
Design flexibility	Good	Medium	Bad
Shell manufacturing			
Tool	Cylindrical	Cylindrical corrugated	Cylindrical and expansion modules
	Continuous lay-up	Discontinuous lay-up	Discontinuous lay-up
Process	Complicated with adhesive film and honeycomb	Complicated with adapting to corrugation	Complicated with adapting to expansion modules
Assembly			
Tool	End-rings	End-rings Stability frames	End-rings Stability frames
Process	Inserts	Stability frames	Stability frames
Trade-off conclusions			
	Accepted - prior knowledge of critical design areas, quality control procedures, reduced costs (no stability frames). Co-cure cost savings (one tool, two cure cycles), use of unsymmetric skins.	Rejected - large number of stringers making manufacturing complicated.	Rejected - labour intensive due to asymmetry between hats and webs (thickness and lay-up). Stability frames increases cost.

22.2.5.2 Design of structure

The structure consists of the elements shown in Figure 12.2-1.

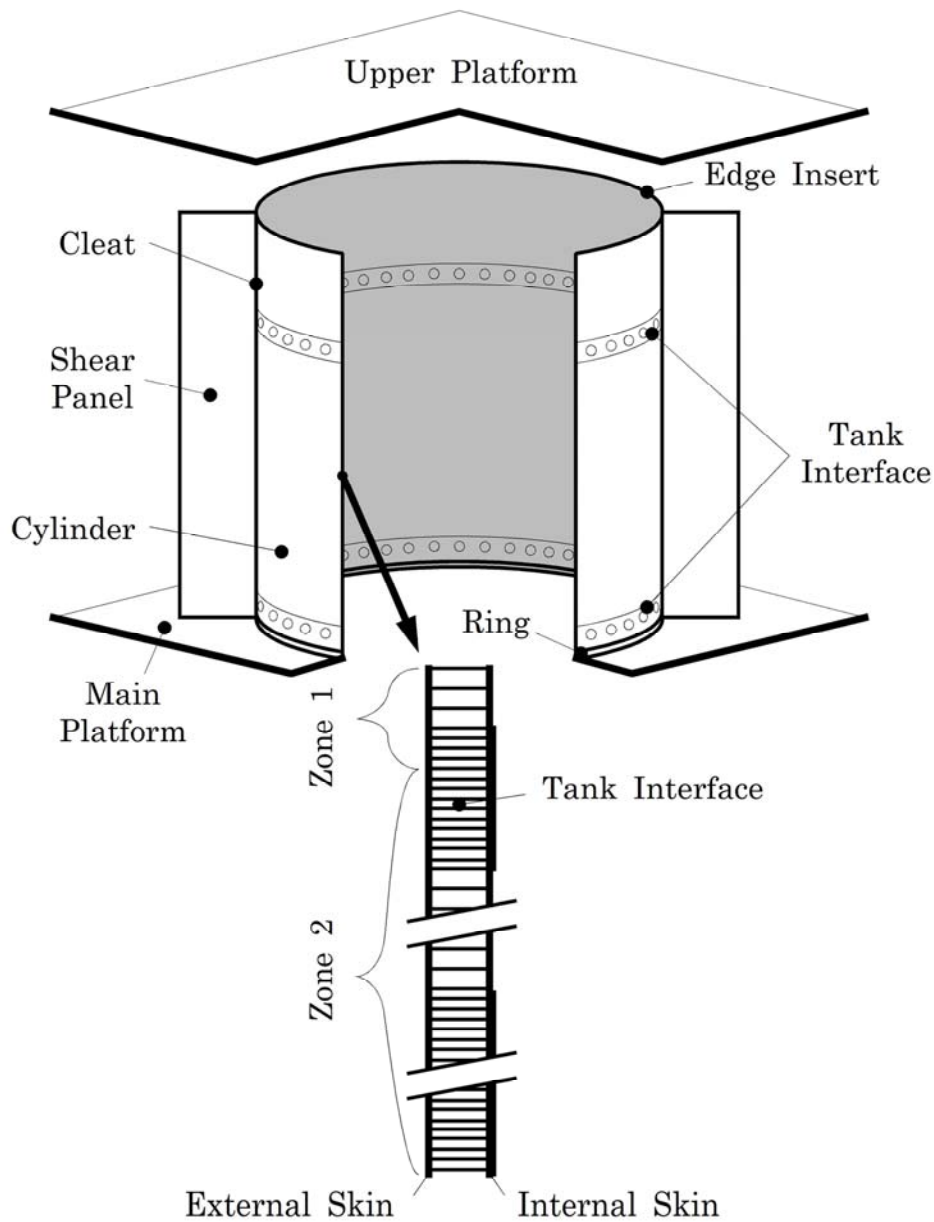

Figure 22.2-1 - Case study: CFRP central cylinder - structural elements

22.2.5.3 Cylinder

The main design features of the cylinder were:

- a **sandwich** construction with **CFRP** skins and aluminium core, **co-cured** in a female mould,
- two zones (1 and 2) with different skin thicknesses,
- skin and core reinforcements for tanks and shear web attachments.

22.2.6 Materials

22.2.6.1 Sandwich skins

Fabric was used instead of UD as it is easier to handle for the co-curing process and less sensitive to void content.

The lay-up with cross-ply in the outer plies is for best skin stability. HM fibre M40 (baseline configuration) was selected as a best compromise on performance-to-cost. UHM fibres tend to be brittle, poor in compression and expensive. The newer fibre M55J (back-up configuration) was more expensive than M40, but had improved properties compared with UHM variants and is also weavable.

The chosen fabric construction was:

- 90% HM or UHM fibre in the warp direction,
- 10% HS fibre in the weft direction.

Resin Ciba 914 provides good processability with medium pressures and low outgassing.

The ply thickness was 1.8 mm and the **sandwich** skin lay-ups were:

- baseline configuration: Vicotex 914/34%/G829,
 - Zone 1: Two layers (+25°, -25°).
 - Zone 2: Four layers (+25°, 02°, -25°).
 - Reinforcements: Vicotex 914/42%/G802 n*(±45°).
- back-up configuration: Vicotex 914/34%/G969.
 - Zone 1: Two layers (+25°, -25°).
 - Zone 2: Four layers (+25°, 02°, -25°).
 - Reinforcements: Vicotex 914/42%/G802 n*(±45°).

22.2.6.2 Sandwich core

The varieties of cores were:

- Main core: OX-5056 3/16" .0007P. Thickness 12mm (minimum thickness for standard riveted assembly).
- Reinforcement core: CRIII-5056 1/8" .002P (reinforced for tank interface).

22.2.6.3 Core-to-skin bonding

The adhesive system used was:

- Adhesive: Redux 319L.
- **Primer:** Redux 119.

22.2.6.4 Lower ring

The lower ring was made of aluminium alloy 7075-T351, machined from forging. Machined forgings are the only way to obtain good circumferential properties.

22.2.7 Joint design

The different types of joints used were:

- lower ring at the interface with the main platform of the satellite. An upper ring was not used to save mass. The joint configuration is shown in Figure 19.02.2 and used:
 - adhesively- bonded with Ciba HT138M/HV998 adhesive; riveted with NAS 1919C-045-03 rivets.
- edge inserts at the interface with the upper platform. The joint configuration is shown in Figure 22.2-3 and used 40 inserts (Heli-coil LN 9039-02-060) co-cured with cylinder,
- tank interface inserts using 40 inserts per tank (80 total). The joint configuration is shown in Figure 22.2-4,
- shear panel interface cleats; as shown in Figure 22.2-5 used:
 - Two cleats bonded (HT138/HV998) and riveted (NAS 1919C-045-03) to the central structure provide the interface with the shear panel.
 - The skins are reinforced where the cleats are attached.

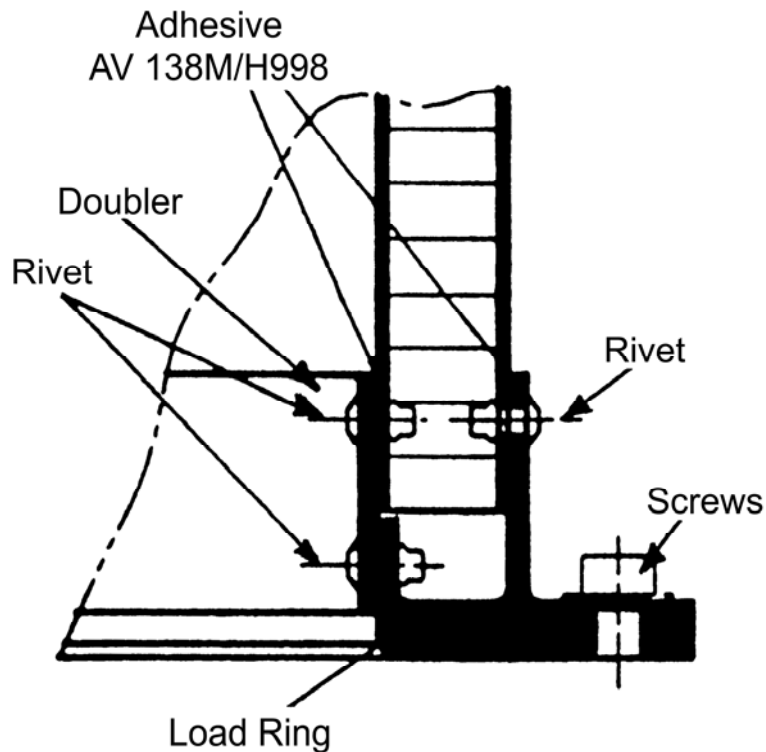

Figure 22.2-2 - Case study: CFRP Central cylinder - lower ring joint

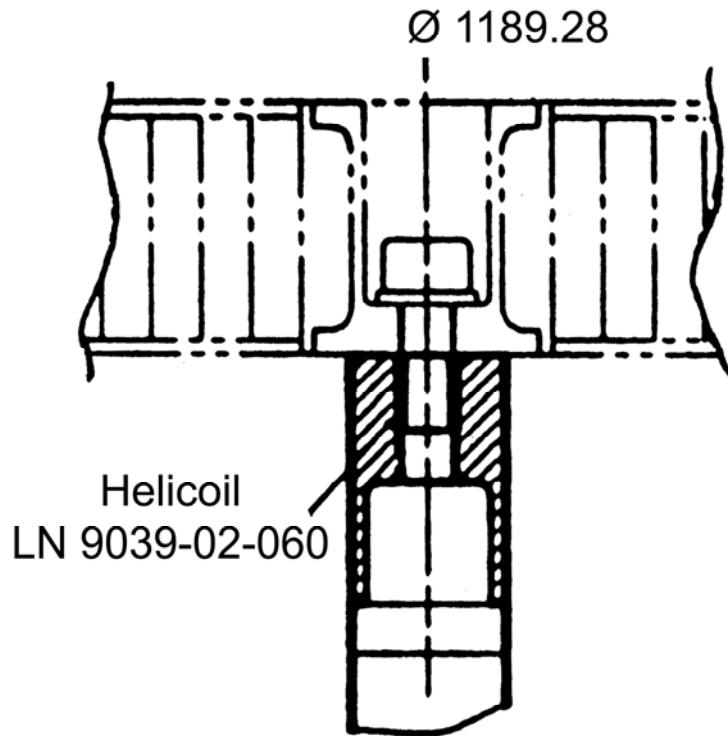

Figure 22.2-3 - Case study: CFRP central cylinder - edge inserts

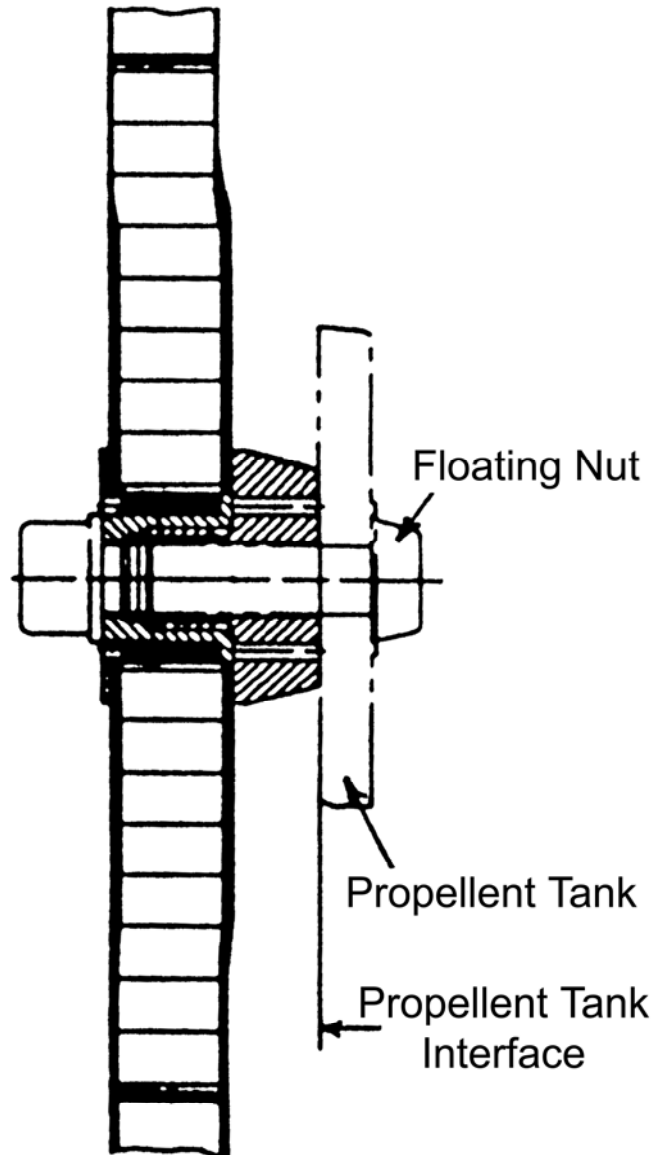

Figure 22.2-4 - Case study: CFRP central cylinder - tank interface inserts

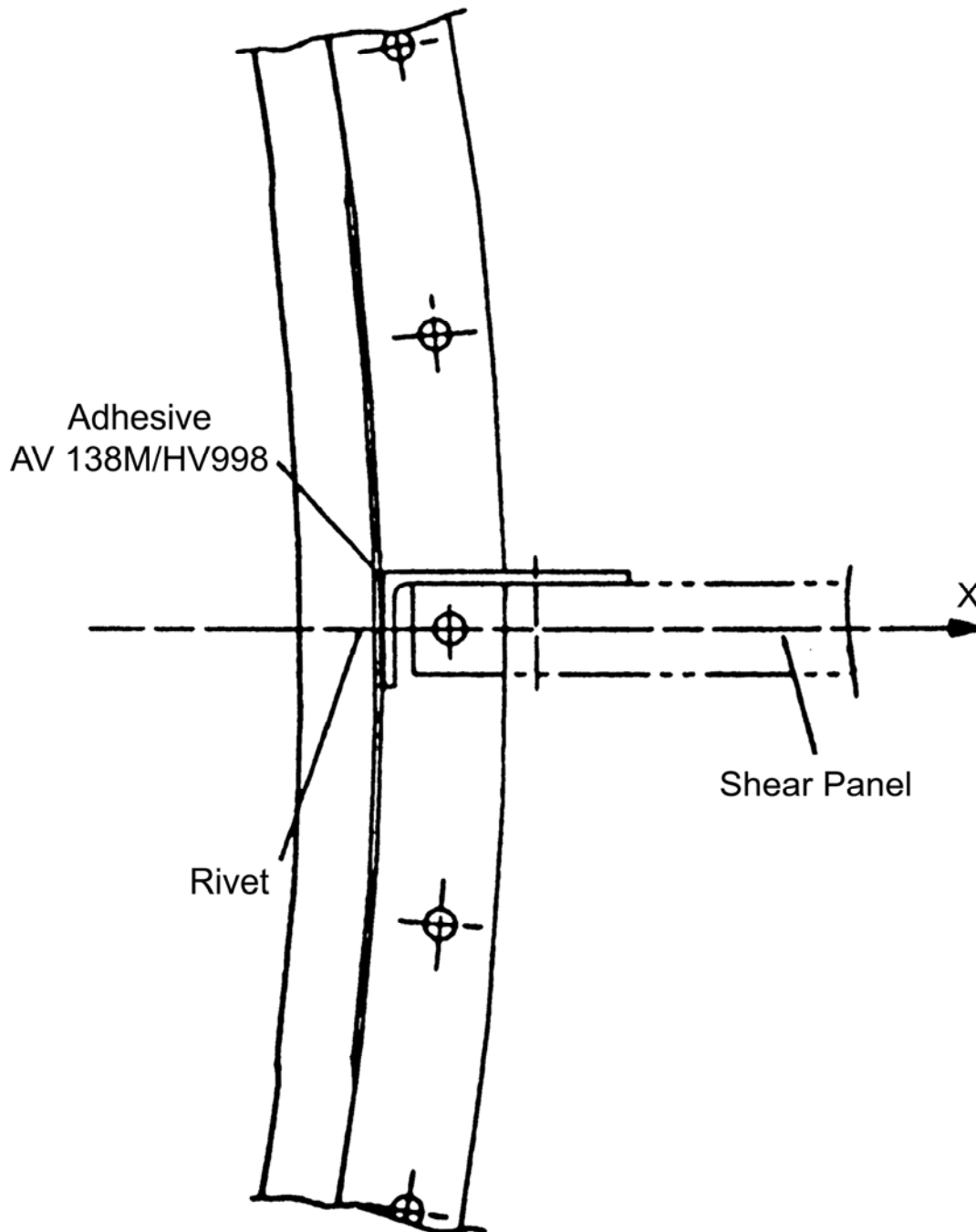

Figure 22.2-5 - Case study: CFRP central cylinder - shear panel interface cleats

22.2.8 Manufacture

22.2.8.1 Demonstrator

The manufacturing development was done with a reduced size demonstrator (actual diameter, 400 mm height) incorporating the main critical areas:

- base-line material choice,
- thick and thin multidirectional configurations,

- longitudinal and circumferential reinforcements,
- edge inserts (10),
- tank interface inserts (10).

22.2.8.2 Process

The demonstrator was produced in a single, **co-cure** process using a female mould.

22.2.8.3 Observations

Some of the features of the demonstrator included:

- skins:
 - assembled vertically;
 - no drapability problems;
 - each skin compacted once;
 - no wrinkles.
- cure:
 - Pressure selected as best compromise between **honeycomb** crushing strength and skin porosity.
 - Temperature homogeneity monitored to assess whether the correct axisymmetrical temperature distribution was achieved.
- finished item:
 - very good external finish.
 - axisymmetrical inhomogeneities can cause lack of circularity.
 - external surface circularity: 2.6 mm,
 - internal surface circularity 2.8 mm (main factor was longitudinal reinforcement),
 - straightness (longitudinal reinforcement): 0.25 mm.

22.2.9 Test

22.2.9.1 General

The development tests conducted can be grouped as those for characterising:

- material,
- component.

22.2.9.2 Material

The tests determined guaranteed values for:

- tensile, compressive, shear moduli and strengths, and
- ILSS for both skin materials.

22.2.9.3 Component

The types of tests used and the values obtained were:

- shell **sandwich** tests for edgewise compression and flatwise tensile. Guaranteed **bondline** strength = 3.6 MPa,
- junction tests using flat specimens, for upper and tank inserts, and cleats, were tested for tensile and shear strength. The lower ring was tested for tensile load, to establish the bearing strength of **CFRP** skins.

22.2.10 Inspection

Visual inspection and measurements of circularity were made, although no details were given.

22.2.11 Analysis

22.2.11.1 Mechanical

Structural analysis was conducted for baseline and back-up configurations to establish:

- dynamic stiffness (normal modes),
- strength and verification (two load cases),
- local analysis of cylinder joints with tanks, upper platform and lower cylinder.

Structural static and dynamic analyses were conducted with FEM models of the cylinder.

Table 22.2-2 summarises the stiffness results.

A loss of about 5% was seen when a simulated tank stiffness was included in the model. The margins of safety for skin rupture stress, dimpling, wrinkling and core shear failure were, for both load cases, in excess of 100%.

Table 22.2-2 - Case study: CFRP central cylinder - structural analysis stiffness results

Mode	Type	Frequency (Hz)	
		Baseline	Back-up
Dynamic analysis			
1 and 2	lateral	26.0	28.5
3 and 4	lateral	83.9	96.2
5	axial	107.7	109.8
Static stiffness			
Lateral	(10^6 N/m)	19.4	23.4
Longitudinal	(10^6 N/m)	282	320
Torsional	(10^6 N/m/rad)	15.93	20.84

22.2.11.2 Mass

Mass analysis of both configurations is shown in Table 22.2-3. The back-up configuration, using the M55J fibre, is the most mass-efficient concept.

Table 22.2-3 - Case study: CFRP central cylinder - mass analysis

Cylinder structure (kg)	Configuration	
	Baseline	Back-up
Sandwich core	4.34	4.34
Sandwich skin	13.61	11.51
Adhesives	1.86	1.86
Ring	3.69	3.69
Inserts	2.35	2.35
Cleats	1.15	1.15
Mass (total)	27.00	24.54

22.2.12 Conclusions

A mass-efficient CFRP central cylinder was designed with:

- optimised variable thickness,
- UHM fibres (introduced in early-1990s),
- cost-effective co-curing technology,
- manufacturing feasibility proven by demonstrator model.

The next demonstrator model was used for static qualification tests. The back-up configuration was selected for further study.

22.2.13 Comments on case study

The case study illustrates the use of adhesive bonding in the manufacture of a critical satellite component in composite material, with the aim of improving performance whilst saving mass.

The manufacture of the shaped structural **sandwich** panel is only possible with adhesive bonding. Likewise, the fitting of attachments to other parts of the structure, i.e. using potted inserts and joints using bonding and riveting.

The use of **co-curing** enables a complicated shaped part to be manufactured in a reduced number of process steps, which reduces the cost.

22.3 Filament wound thrust cylinder

22.3.1 Source

Stork Product Engineering/Ultra Centrifuge, NL.

ESA SP-336 (October 1992), p. 51-56.

22.3.2 Application

Thrust cylinder for satellites - DRS-like applications, Ref. [22-3].

22.3.3 Objective of study

This was a feasibility study to design, develop and manufacture a demonstrator **filament-wound CFRP/aluminium honeycomb sandwich** satellite central thrust cylinder.

22.3.4 Parameters for design

The design requirements were taken from ITALSAT 2 for the design-development study; as given in Table 22.3-1.

Table 22.3-1 - Case study: Filament wound thrust cylinder - design parameters

Mass	<20 kg
Eigenfrequency:	
Lateral	>15 Hz
Axial	>40 Hz
Stiffness:	
Lateral	8.0 MN/m
Axial	112.5 MN/m
Torsional	7.7 MNm/rad

22.3.5 Concept

22.3.5.1 General

Trade-off studies between monocoque, stiffened and **sandwich** concepts showed, as expected, the better mass and stiffness performance of sandwich structures, [See also: 22.2].

22.3.5.2 Basic

A cylindrical CFRP-skinned aluminium **honeycomb** core sandwich shell.

Inner and outer skins were produced by wet winding. Skins and honeycomb were bonded with a heat-curing structural adhesive. Lower and upper end rings bonded with an RT-curing paste adhesive (without additional fasteners, [See: 22.2]), post-cured to optimise mechanical and space environmental properties.

22.3.5.3 Local reinforcements

Local reinforcement was used for:

- inner skin: CFRP used at lower tank interface and lower end ring. Segmented aluminium ring at the lower tank interface was cold bonded to the skin and joined by cold bonded coupling pieces,
- outer skin: CFRP used at upper tank interface, lower tank interface and lower end ring,
- core: smaller cell size and greater wall thickness honeycomb was used at upper and lower tank interfaces and lower end ring.

22.3.6 Materials

Table 22.3-2 summarises materials used in the demonstrator part.

Table 22.3-2 - Case study: Filament wound thrust cylinder - materials

Materials	Product code
Sandwich panel:	
Carbon fibre	M46JB
Resin system	EPON [®] 9400/9450
Honeycomb	1/4"-5052-0.0007P 1/8"-5052-0.0010P
Adhesives:	
Film	FM300
Foaming	FM410
Cold bonding	EC2216 A/B
Aluminium alloy:	
Parts	2024-T3
Core	5052

22.3.7 Design

The main features of the design are summarised as:

- winding:
 - thin skins (0.3mm = 3 layers),
 - fibre volume fraction, V_f : 53%,
 - fibre placement accuracy: $\leq 0.5^\circ$,
 - excellent dimensional accuracy, e.g. 1110mm ± 0.2 mm,
 - Skin lay-up: ($\pm 22.5^\circ/90^\circ$),
- local reinforcements: CFRP braids ($0^\circ/90^\circ$) and ($\pm 45^\circ/90^\circ$),
- no potting of **honeycomb** core cells at attachment points,
- two types of honeycomb (denser cell pattern at attachment points),
- bonded end rings without mechanical fastening, due to high accuracy of winding.

22.3.8 Joint design

The end ring area and tank interface are shown in Figure 22.3-1.

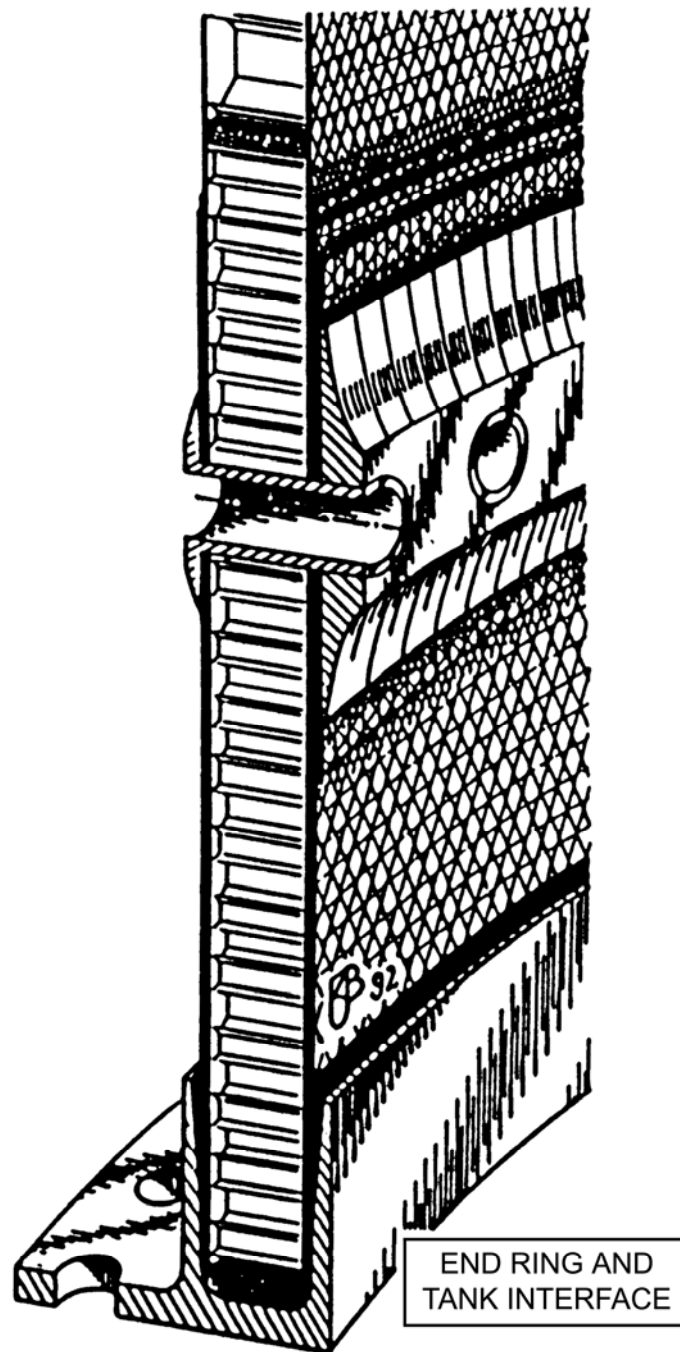

Figure 22.3-1 - Case study: Filament wound thrust cylinder - joint design: Tank interface and end ring

22.3.9 Analysis

No details were given for critical design elements.

22.3.10 Manufacture

The manufacturing sequence is summarised in Figure 22.3-2, with emphasis on the various adhesive bonding operations.

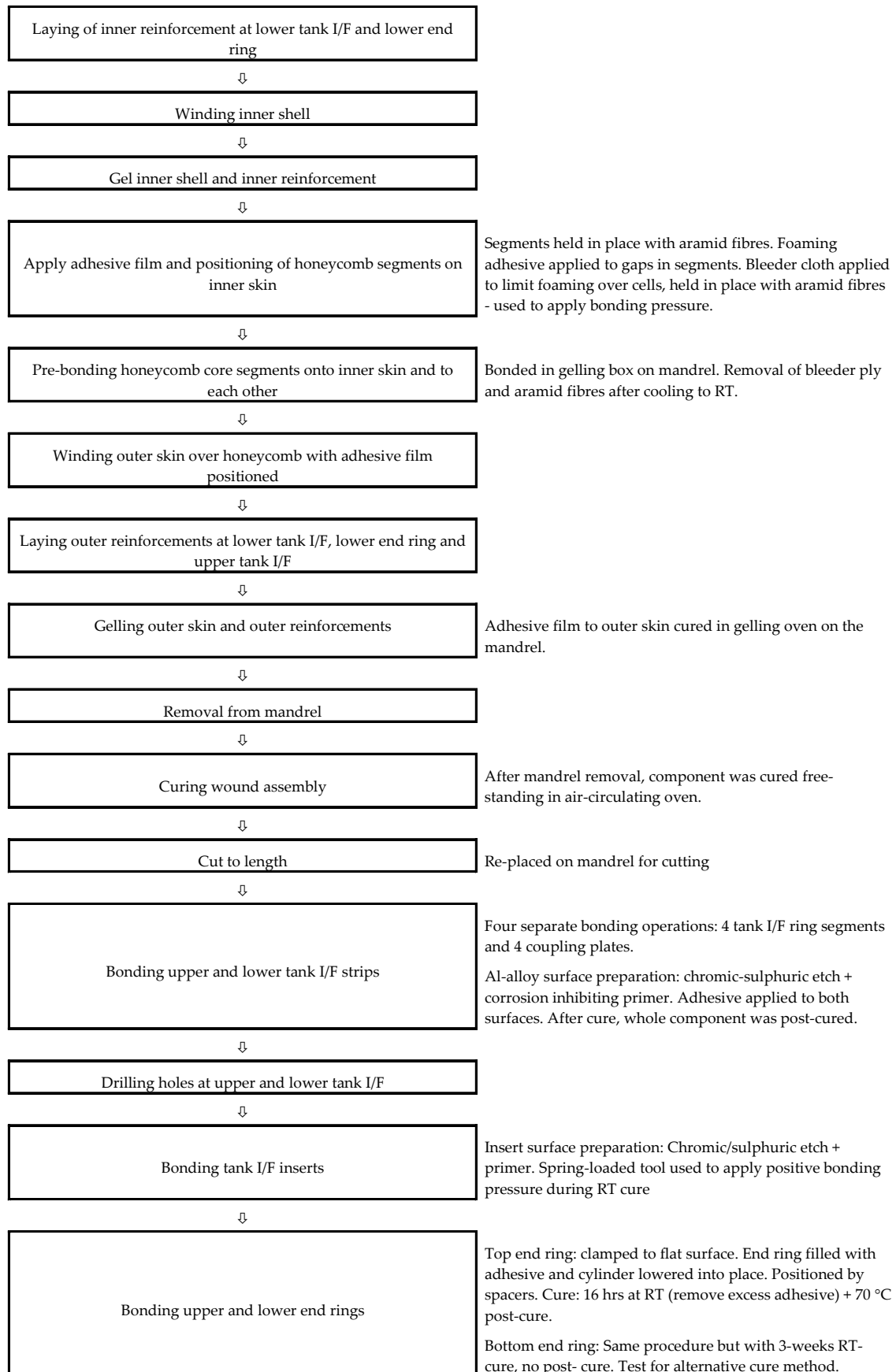

Figure 22.3-2 - Case study: Filament wound thrust cylinder - manufacturing sequence

22.3.11 Test

22.3.11.1 Initial tests

These were conducted on:

- small wound cylinders: volume fraction V_f , σ -allowables, E , T_g , layer thickness,
- dummy mandrel: fibre angle, tow gaps.

22.3.11.2 Critical design areas

The tests conducted at critical areas were:

- short column test,
- flatwise tensile test,
- bonding - end rings and tank interface.

22.3.12 Inspection

Visual and coin-tapping for disbonds.

22.3.13 Conclusions

The feasibility was proven and characterised by:

- highly-automated processing giving low recurring costs, short production times and good reproducibility,
- bonded end rings, due to dimensional accuracy (0.2 mm),
- lower mass resulting from winding technology and innovative design. Actual mass: 18.78 kg, compared with target 20 kg,

Verification tests on full scale demonstrator were the next stage.

22.3.14 Comments on case study

The case study demonstrates the ability to fabricate cylindrical sandwich structures with **filament wound** skins. The external windings apply the bonding pressure for the **film** adhesive, **co-cured** with the gelling stage for the skins.

Secondary bonding is used for end ring fittings and inserts. No additional fasteners are used.

The claim of being a highly-automated manufacturing process relates only to the skins. There are a number of manual operations necessary for placing and bonding of the **sandwich** panel components.

Whilst the manufacturing sequence for the **sandwich** structure is more complicated than the single co-cured route used by CASA, [See: 22.2 and 22.4], assembling the end ring attachment is simpler and avoids the need for drilling thin composite skins in the joint region.

22.4 Ariane 4 payload adapter 937B

22.4.1 Source

CASA Space Division, Madrid, Spain.

ESA SP-303 Space Applications of Advanced Structural Materials (March 1990), p. 79-84.

22.4.2 Application

Payload adapter for Ariane 4 launch vehicle, Ref. [22-4]. Support for satellites of up to 2300 kg, in single or dual launch configuration. Its role is to ensure mechanical continuity between:

- inner zone of the VEB and the satellite (single launch) lower position (dual launch).
- upper zone of SPELDA and satellite (dual launch, upper position).

22.4.3 Objective of study

A design-development programme for the conical **CFRP sandwich** structure with metal fittings for interfacing equipment.

22.4.4 Parameters for design

22.4.4.1 Functional

The criteria imposed were:

- fulfil single and dual launch possibilities.
- umbilical link with the satellite via the fairing or the vehicle equipment bay.
- release the satellite from launch vehicle.

22.4.4.2 Mechanical

The critical load case corresponds to the maximum dynamic pressure at $M = 1.2$, where:

- calculated loads acting on the upper interface are:
 - Lateral force (z) = 42797 N.
 - Bending moment (MF) = 52247 N.
 - Longitudinal force (N) = 37559 N.
- at upper interface:
 - Maximum compressive flux = 95.0 N/mm.
 - Maximum tensile flux = 68.5 N/mm.
 - Band tension = 27.7 kN.
- factors of safety (applied in analysis):
 - General loads $1.25 \times$ ultimate; with $1.1 \times$ for overfluxes,
 - Band tension factor 1.1.

22.4.5 Concept

Figure 22.4-1 shows the one-piece tronco-conical **CFRP sandwich** shell with two metallic end rings for interfacing with the adjacent structures. Other features were:

- connector supports to transmit load from the connector to the structure.
- spring supports to transmit spring load to the structure.
- transducer supports for accelerometer and microswitch mountings.

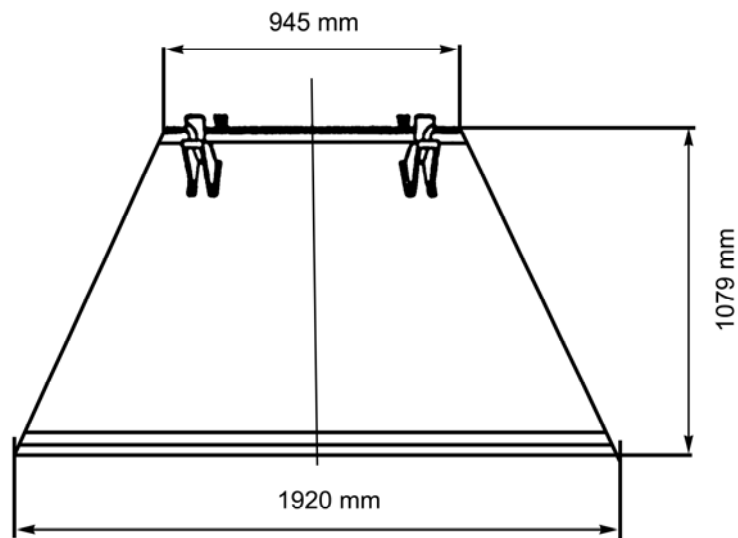

Figure 22.4-1 - Case study: Ariane 4 payload adapter - overall view of adapter 937B

22.4.6 Materials

Table 22.4-1 summarises the materials used for the different component parts.

Table 22.4-1 - Case study: Ariane 4 payload adapter - materials

Component	Material
Upper ring	AA 7075-T7351 machined from forging
Core:	Skins: Vicotex 914/G829 Lay-up: (+45°/0°/-45°)
Central zone:	Skin thickness: 1.08 mm Honeycomb NIDA4.20P; thickness 12 mm Four holes total area 1963 mm ² for venting
End zones:	Skins: Vicotex 914/G829 Lay-up: (+45°/0°/-45°) PLUS 3 layers Vicotex 914/G803 (±45°) Honeycomb core: NIDA3.58P sandwich thickness: 15 mm
Adhesives:	Honeycomb joints: BSL208/5-NA foaming Skin-to-honeycomb: BSL319L + Primer BSL119
Lower ring	AA 7075-T7351
Connector supports	AA 7075-T6 and AA 2024-T3
Spring supports	AA 7075-T6 and AA 2024-T34
Transducer supports	AA 7075

22.4.7 Design

The possible design solutions considered were:

- classical solution, where the **sandwich** shell was divided into 4- segments with cover joints between them.
- single tronco-conical sandwich shell, which was more difficult to manufacture, but reduced assembly costs.

The dimensions were 1079 mm high, 1920 mm bottom diameter and 945 mm top diameter.

22.4.8 Joint design

22.4.8.1 General

The use of an adhesive was made because of:

- joint integrity;
- reduced 'telegraphing' effect of core;
- confidence in **sandwich** performance;
- ease of manufacturing compared with other option to use two different prepregs with same fabric, but different resin contents.

The mass increase due to the adhesive was about 4 kg.

22.4.8.2 End rings

The upper and lower aluminium alloy end rings were bonded and riveted to the sandwich structure Figure 22.4-2 shows the joint detail.

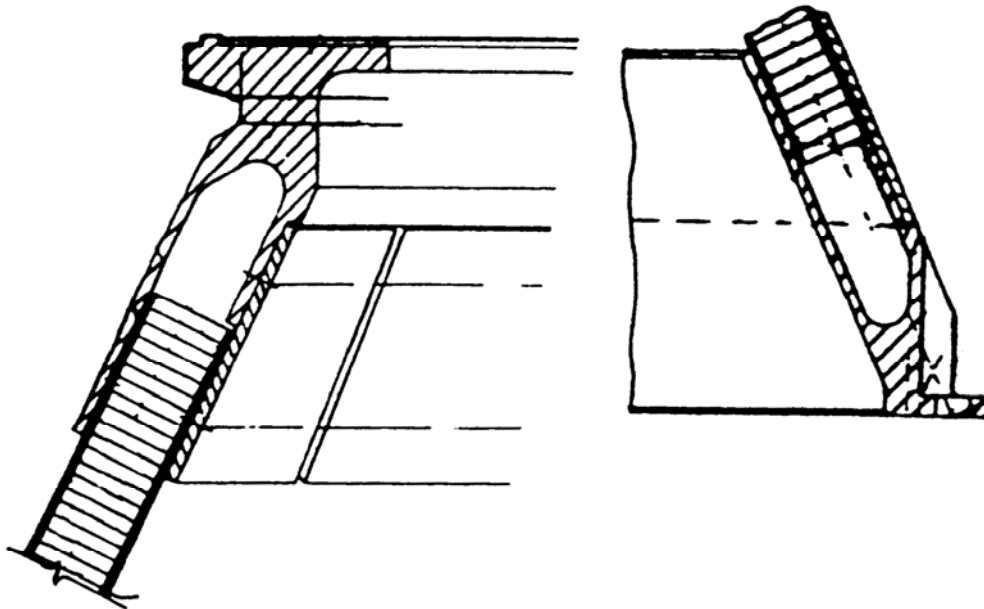

Figure 22.4-2 - Case study: Ariane 4 payload adapter - end ring joint

22.4.9 Analysis

22.4.9.1 General

The MSC® NASTRAN models used were:

- Cyclic symmetry model; to analyse stiffness.
- Complete model; to analyse general instability, stresses, influence of SPELDA and temperature.

22.4.9.2 Failure modes of structure

Table 22.4-2 summarises the margins of safety for each mode.

Table 22.4-2 - Case study: Ariane 4 payload adapter - margin of safety for failure mode analysis

	Margin of safety	
General instability	5	
Stress analysis		
Sandwich instability:		
intracell buckling	5	
Wrinkling	5	
core shear	5	
skin failure	2.2	
Thermal analysis	Hot	Cold
Sandwich instability:		
intracell buckling	5	5
Wrinkling	5	-
core shear	5	5
skin failure	1.2	1.9
Rings:		
upper interface (both)	2.7	
upper ring	5	
lower ring	5	
Over fluxes	0.61	
Inserts:		
normal to skin	5	
in plane	2.4	
Rivets:		
on upper ring	0.32	
on lower ring	1.56	

22.4.9.3 Stiffness analysis

The characteristics were:

Longitudinal 90.0 Hz

Transverse f 23.5 Hz

where:

f with simulated payload rigidity

22.4.10 Manufacturing

Co-curing was selected as this enabled cost savings by:

- Only needing one tool,
- Using two less autoclave cycles.

Two shells, 1/4 scale, were produced with and without reinforcement for the ring attachments. The final goal was to manufacture by co-curing the shell in one integral piece.

Significant effort was needed to develop a successful manufacturing process. Table 22.4-3 summarises the conclusions of the manufacturing development.

Table 22.4-3 - Case study: Ariane 4 payload adapter - manufacturing development summary

Factor	Comments
Tack Drapability	Lay-up in quasi-vertical position. No drape problems
Skin compaction ⁽¹⁾	Inner skin: Ply 1 + after every 3 plies Outer skin: Each ply, otherwise wrinkles formed if more than one ply was compacted at a time.
Cure cycle ⁽²⁾	Pressure: Compromise between skin porosity and honeycomb crush strength. Temperature distribution: <5 °C in a vertical position within the autoclave.
External finish ⁽³⁾	Good finish with caul plate. Future use of female mould ^{(1) (3)}
Circularity ⁽⁴⁾	Model 1: 0.9 mm (too high) Model 2: 0.2 mm (expected for full scale item)
Cone angle deviation	Model 1 (no reinforcements): <0.05° Model 2 (with reinforcements): <0.1°
Key: (1) Female mould selected for 1/1 scale item; (2) For full scale items, a horizontal position is needed; (3) External surface the better one with a female mould; (4) Curvature is reduced in the actual (real) size item.	

22.4.11 Test

22.4.11.1 Development tests

The development tests provided:

- materials characterisation by determining guaranteed values for skin lay-ups, i.e.:
 - tensile modulus and strength, Poisson's ratio,
 - compression modulus and strength,
 - shear modulus and strength,
 - ILSS interlaminar shear stress.
- component characterisation consisting of:
 - Shell sandwich tests, using edgewise compression, flatwise tensile at RT and 100 °C. Guaranteed values for bondline strength were 2.68 MPa at RT and 3.17 MPa at 100 °C.
 - Riveted junctions, using tensile test on plane specimens (simulated joint between ring and sandwich). Strength value 524 N/mm², bearing failure mode.

22.4.11.2 Qualification tests

The qualification tests aimed to:

- verify the correct dimensioning and manufacturing of the separation subsystem.
- measure the transverse and longitudinal stiffness of the adapter, which provided the frequency results:
 - Longitudinal: 104 Hz,
 - Transverse: 22.8 Hz.
- prove structural integrity under ultimate loads, which gave the results:
 - No permanent deformation under elastic limit loads ($j = 1.1$ corrected),
 - Structural integrity checked under ultimate loads ($j = 1.25$ corrected)
- measure net energy transfer in the payload dummy during separation

22.4.12 Inspection

Visual, but no details given.

22.4.13 Conclusions

Use of **co-cure** technology demonstrated the design and manufacture of a conical **sandwich** structure for use as the Ariane 4 payload adapter.

Adhesive bonding was used within the sandwich panel construction. The attachment rings, top and bottom, are a mixed bonded and riveted joint.

22.4.14 Comments on case study

The case study demonstrates the successful use of adhesive bonding in a complex sandwich panel structure.

Co-curing the whole assembly reduced the tooling and (autoclave) processing costs.

Mixed bonded and mechanical fastening is used for attachment rings, presumably to provide sufficient confidence in the joint performance.

22.5 Galileo radiation shielding

22.5.1 Source

Jet Propulsion Laboratory, USA.

4th International SAMPE Electronics Conference, 12-14 June 1990.

22.5.2 Application

Radiation protection shields for spacecraft electronic devices, especially for deep-space missions. The shield consists of several shear plates (bus panels) which form the outer shell of the Galileo spacecraft. These face directly into deep space, Ref. [22-5].

22.5.3 Objective of the study

The development and qualification of materials and processes for an aluminium and tantalum adhesively-bonded laminated structure. The laminate also provides sufficient structural properties to act as a shear plate for mounting electronic assemblies.

22.5.4 Parameters for design

22.5.4.1 Radiation fluence and flux levels

Table 22.5-1 provides an estimate of the radiation levels expected for the Galileo mission.

Table 22.5-1 - Case study: Galileo radiation shielding - estimated radiation levels

Particle type	Fluence	Flux
Electron (3MeV equiv)	$6 \times 10^{17} \text{ e/m}^2$	$9 \times 10^{12} \text{ e/m}^2.\text{s}$
Proton (20MeV equiv. $E > 1\text{MeV}$)	$3 \times 10^{15} \text{ p/m}^2$	$9 \times 10^{11} \text{ p/m}^2.\text{s}$
Proton (20MeV. $E > 22\text{MeV}$)	$1.5 \times 10^{14*} \text{ p/m}^2$	$6 \times 10^9 \text{ p/m}^2.\text{s}$
Key: * Assumes protons $< 22\text{MeV}$ are eliminated by 100 thou of aluminium. Dose level for Jupiter Orbit Insertion (JOI) + 12 orbits = $1.4 \times 10^{10} \text{ rad (Si)}$; Radiation design margin (RDM) = 2, dose level is $2.8 \times 10^{10} \text{ rad (Si)}$.		

22.5.4.2 Criteria

Table 22.5-2 gives the criteria for the design. The laminate overall dimensions were 914 × 914 mm.

Table 22.5-2 - Case study: Galileo radiation shielding - design criteria

Parameter	Criteria
Type of adhesive	Film, preferably.
Cure temperature	RT or low temperature (<120 °C).
Strength property	Min. tensile shear strength 17.24 MPa at -30 °C, 25 °C and 85 °C.
Bondline thickness	Uniform. Between 25 µm and 100 µm.
Warpage	≤1 mm/m ⁻¹ in suspended free-state vertical plane.
Permissible voidage	≤5% total. Single void ≤40 mm ² or 6.3 mm on a side.
Ageing	Good ageing stability.
Outgassing	Meet TML and VCM requirements.
Surface treatment	Not be detrimental to metallic structure.

22.5.5 Concept

The numerous configurations considered were based on adhesive bonding technology and metal deposition techniques; as shown in Table 22.5-3.

Configuration B, C and F concepts were selected.

Explosive forming proved too difficult, whereas electroforming showed promise.

22.5.6 Materials

22.5.6.1 General

Table 22.5-4 gives the materials for various parts of the radiation shielding.

Table 22.5-3 - Case study: Galileo radiation shielding - concepts

Configuration ⁽¹⁾	Description (material thickness, mm)	Weight (kg/m ²)
A	Aluminium plate (5).	14.0
B	Aluminium-tantalum-aluminium. (0.8-0.25-0.8). Adhesively bonded.	9.0
C	Aluminium-tantalum-aluminium. Explosively formed ⁽²⁾ .	8.7
D	Glass laminate-tantalum-glass laminate (0.8-0.25-0.8). Adhesively bonded.	7.0
E	Laminated plastic facing-tantalum-laminated plastic	-

	facings. Adhesively bonded.	
F	Plasma-coated Tantalum (0.125) on both sides of aluminium.	6.2
G	Electroformed ⁽³⁾ tantalum on aluminium.	-
H	Honeycomb sandwich structure, with tantalum foil adhesively-bonded on to aluminium honeycomb.	5.0
I	Honeycomb sandwich structure, with tantalum foil adhesively-bonded on plastic honeycomb.	-
<p>Key: (1) Configuration B, C and F concepts were selected; (2) Explosive forming proved too difficult; (3) Electroforming showed promise</p>		

Table 22.5-4 - Case study: Galileo radiation shielding - materials

Tantalum sheet	AMS 7849A or ANSI/ASTM B64-77 Thickness: 0.010 inches
Aluminium sheet	Outer face: 6061-T6 (QQ-A-250/11) Thickness: 0.032 inches
	2024-T6, 0.063 inches thick for tensile shear panels, (MMM-A-132 spec.)
Potential adhesives	EC2216 B/A, 2-part RT-cure epoxy (3M)
	EA9309 2-part epoxy RT or elevated cure (Hysol)
	FM73M, modified epoxy film, 250°F cure.

22.5.6.2 Adhesive selection

The adhesives were selected on the basis of:

- existing JPL approved materials,
- tensile and shear strength data supplied by manufacturer,
- adhesive qualified under Federal specification MMM-132-A, [See also: 15 for details of adhesive properties to meet this standard].

22.5.7 Design

22.5.7.1 Properties of bonded joint

Table 22.5-5 gives the desired properties for the bonded joints.

Table 22.5-5 - Case study: Galileo radiation shielding - properties for Al-Ta-Al bonded joints

Properties	Adhesive		
	EC2216	EA9309	FM73M
Average tensile shear strength (MPa) †			
-30 °C	15.5	32.0	33.5
+25 °C	18.2	29.2	37.7
+85 °C	1.5	2.6	30.1
Average flatwise tensile strength (MPa) ‡			
+25 °C	-	-	42.3
Key: †: Fed.Spec MMM-A-132; Al-Ta-Al bonds, [See also: 15.1 for specification] ‡: Modified ASTM C297, loading rate 8.3 MPa/min.to 9.7 MPa/min.			

FM73M was selected after further testing of Al-Ta-Al bonds because:

- a **bondline** thickness of 25 µm to 75 µm was achieved,
- the strength criterion was met over a temperature range of -30 °C to +85 °C.,
- EC2216 and EA9309 showed high strength at -30 to +25 °C, but about 90% of RT strength at +85 °C,
- the failure mode was consistent and virtually 100 % cohesive over whole test temperature range,

The failure mode was unpredictable for EC2216 and EA9309.

22.5.7.2 Laminate design

Concept configuration B was selected; as shown in Figure 22.5-1, [See also: Table 22.5-3].

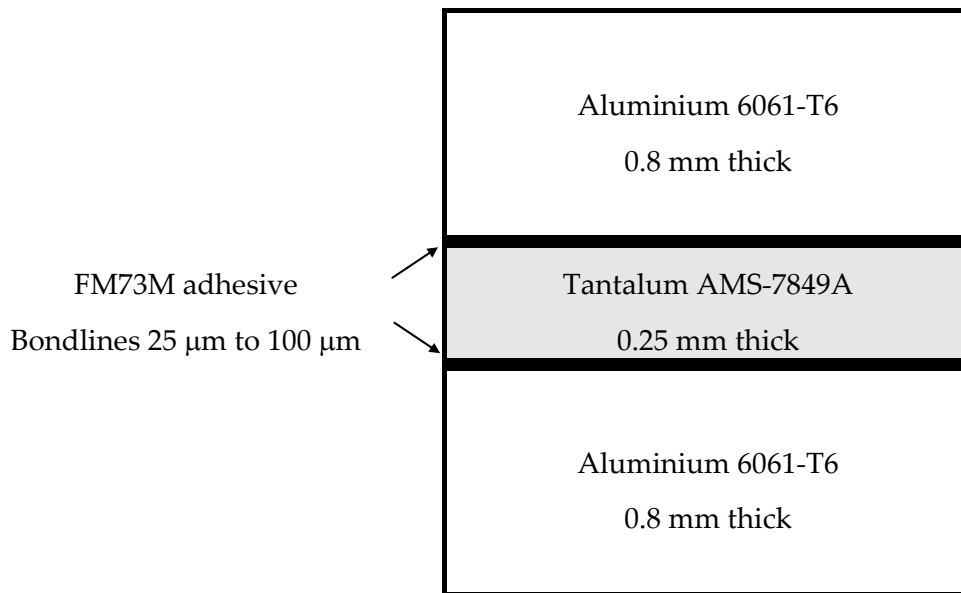

Figure 22.5-1 - Case study: Galileo radiation shielding - laminate design

22.5.8 Analysis

No details stated. [See: Test; Inspection].

22.5.9 Manufacturing

22.5.9.1 Tantalum surface preparation

The tantalum etching procedure, developed by JPL, produces a clean surface with acceptable surface roughness after 8 minutes etching.

The etch bath constituents do not cause hydrogen embrittlement of tantalum or any other undesirable effects. The process steps are:

- degrease with 1,1,1 trichloroethane (MIL-T-81533 Spec),
- immerse parts for 8 mins. to 12 mins. in aqueous solution of Oakite® 61A alkaline cleaner, at 71 °C to 82 °C,
- rinse thoroughly in hot tap water (49 °C to 71 °C),
- immerse parts and agitate continuously for 4 mins. to 6 mins. in etch bath comprising of:
 - Nitric acid (2 vol.).
 - Sulphuric acid (2 vol.).
 - Hydrofluoric acid (1 vol.).
 - Deionised water (5 vol.), with specific conductance <100 µΩ,
- Rinse parts thoroughly in deionised water,
- Oven dry for 15 mins. to 30 mins. at 71 °C.

22.5.10 Test

Mechanical tests, mainly to screen potential adhesives and determine the adhesive bond strengths included, [See also: 15]:

- tensile shear tests, using a Ta strip (12.5 mm x 175 mm x 0.25 mm) bonded between two AA 2024-T3 sheet (100 mm x 175 mm x 1.6 mm); with an overlap of 12.5 mm, as per ASTM D1002. Each overlap had two adhesive bondlines,
- flatwise tensile tests, using coupons cut (25 mm x 25 mm x 2 mm thick) from laminates previously tested by NDT and shown not to contain voids,
- warpage test, using laminate coupons (25 mm x 150 mm) - symmetrical and asymmetrical (bimetal) thermally-cycled between -30 °C and +85 °C, where:
 - symmetrical laminates, showed no warpage over temperature range irrespective of adhesive cure temperature.
 - asymmetrical laminates, showed measurable warpage at RT as a result of cure temperature. Warpage doubled when cooled to -30 °C, but had practically no warpage at +85 °C.

22.5.11 Inspection

Ultrasonic C-scan was used for detection of unbonded areas. The technique was verified by making 'defective' laminates with known unbonded regions.

22.5.12 Conclusions

The design-development study concluded that:

- a mixed-metal adhesively-bonded laminated metal sheet was produced in which:
 - tantalum sheet provided radiation protection.
 - aluminium provided anchoring and additional radiation protection.
- acceptable weight.
- the radiation protection criteria for interplanetary spacecraft, such as Galileo, were met.
- a manufacturing process was devised which produced:
 - acceptable bond strength over the range of temperature;
 - acceptable warpage levels after thermal cycling.
- the inspection method to locate unbonded areas was based on ultrasonics.

22.5.13 Comments on case study

This case study illustrates the role of adhesive bonding in the manufacture of specialist mixed-metal laminated sheet materials for space use.

Whilst primarily offering radiation protection, the laminate also carried light loads imposed by mounting electronic equipment.

The adhesive selection and testing process for a spacecraft are detailed, with reference to the numerous standards applied.

The concept of the laminate chosen shares similarities with the manufacture of structural FML fibre metal laminates, such as ARALL[®], but without the added complication of reinforcing fibres within the bondline, [See also: ECSS-E-HB-32-20: Structural materials handbook; previously ESA PSS-03-203]

22.6 References

22.6.1 General

- [22-1] ECSS-E-HB-32-20: Structural materials handbook; previously ESA PSS-03-203
- [22-2] CASA Space Division, Madrid, Spain
ESA SP-336 (October 1992), p33-38
- [22-3] Stork Product Engineering/Ultra Centrifuge, NL
ESA SP-336 (October 1992), p51-56
- [22-4] CASA Space Division, Madrid, Spain
ESA SP-303 (June 1990), p79-84
- [22-5] Jet Propulsion Laboratory, USA
4th International SAMPE Electronics Conference, 12-14 June 1990
- [22-6] ECSS-E-ST-32-01 – Space engineering – Fracture control
- [22-7] ECSS-Q-ST-70-29 – Space product assurance – Determination of offgassing products from materials and assembled articles to be used in a manned space vehicle crew compartment
- [22-8] ECSS-Q-ST-70-02 – Space product assurance – Thermal vacuum outgassing test for the screening of space materials methods and standards

A.1 Introduction

Numerous test methods and standards are used during the selection and design of adhesively-bonded joints. Some are referred to or described within this handbook, [See: 15].

This annex provides a collated list of those test methods and standards commonly used by adhesive manufacturers and within research and development studies.

The list is neither exhaustive, nor fully cross-referenced to all national or international standards.

Always contact standards organisations to obtain the latest version of a standard.

A.2 ASTM standards

A.2.1 General

ASTM have developed a wide range of standards covering all aspects of adhesives and bonding, Ref. [A-1]. Details of standards are available from the ASTM web site, [See: [ASTM International](#)].

Tests conducted to ASTM methods are widely quoted by adhesive manufacturers and in research and development studies, where property data is often stated to an ASTM standard. The standards listed here are selected for their relevance to aerospace bonding applications. [See also: 15], and are grouped by:

- Surface preparation methods for:
 - Metal adherends.
 - Plastic adherends.
- Mechanical testing methods for:
 - Metal bonding, e.g. tensile properties, shear properties, flexural strength, peel, cleavage, impact, fatigue, creep, fracture strength and durability.
 - Plastic bonding, where many of the ASTM specifications listed for metal bonding can be used directly, or be modified to be used, for adhesive bonds with advanced composite adherends; except some peel tests in which composites do not have sufficient ductility. For creep and fatigue mechanical testing, those test methods developed for wood can be considered. The specifications listed are for engineering plastics, and can also be considered for testing composite bonds, [See also: Sources: ECSS-E-HB-32-20 Structural materials handbook].
- Environmental resistance, [See also: 15]
 - Metal bonding.
 - Plastic bonding, where many of the ASTM specifications listed for metal bonding can also be used directly or be modified to be used for adhesive bonds with advanced composite adherends. The specifications listed are for engineering plastics, and may also be considered for testing composite bonds.
- Adhesive characteristics, where several specifications relating to the physical and working properties of adhesives are quoted by manufacturers. These include tests for:
 - adhesive composition and chemical properties, e.g. non-volatile and filler contents of various types of adhesives;
 - applied adhesive weight.
 - rheological and tack properties of adhesives, e.g. viscosity, density and flow characteristics.
 - electrical properties, e.g. electrical insulation, volume resistivity and conductivity, electrolytic corrosion (of copper).
 - working and storage life properties, e.g. usable lives established by bond strengths, susceptibility to attack by cockroaches and rats.

A.2.2 Surface preparation

A.2.2.1 General

[See also: 12 and 19.2 for description of some methods]

A.2.2.2 Metal adherends

D-2651 Practice for the preparation of metal surfaces prior to adhesive bonding.

- D-2674 Method of analysis of sulphochromate etch solution used in surface preparation of aluminium.
- D-3933 Practice for preparation of aluminium surfaces for structural adhesive bonding (Phosphoric Acid Anodising).

A.2.2.3 Plastic adherends

- D-2093 Practice for the preparation of surfaces of plastics prior to adhesive bonding.

A.2.3 Mechanical testing: Metal bonding

A.2.3.1 Tensile

- D-0897 Test method for tensile properties of adhesive bonds.
- C-0297 Flatwise tensile strength of metal-to-honeycomb core bonds.
- D-2095 Test method for tensile strength of adhesives by means of bar and rod specimens.
- D-2094 Practice for preparation of rod and bar specimens for adhesion tests [See: D-2095 for test method].
- D-1002 Test method for shear properties of adhesives in shear by tension loading (metal-to-metal).
- D-2295 D-1002 for elevated temperatures and reduced temperatures.
- D-3165 Test method for strength properties of adhesives in shear by tension loading of laminated assemblies.
- D-3528 Test method for strength properties of double lap shear adhesive joint by tension loading.

A.2.3.2 Shear

- D-4501 Test method for shear strength of adhesive bonds between rigid substrates by the block-shear method. [Compressive shear.]
- D-3983 Test method for measuring strength & shear modulus of non-rigid adhesives by thick adherend tensile lap specimen.
- D-4027 Test methods for measuring shear properties of structural adhesives by the modified-rail test.
- D-0229 Test method for shear strength and shear modulus of structural adhesives. [Napkin ring test.]
- D-1144 Practice for determining strength development of adhesive bonds. [Based on D-1002 lap shear specimen.]

A.2.3.3 Flexure

- D-1184 Test method for flexural strength of adhesive bonded laminated assemblies.

A.2.3.4 Peel

- D-0903 Test method for peel stripping strength of adhesive bonds.
- D-1781 Method for climbing drum peel test for adhesives.
- D-1876 Test method for peel resistance of adhesives (T-peel test).
- D-3167 Test method for floating roller peel resistance of adhesives.

A.2.3.5 Cleavage

- D-1062 Test method for cleavage strength of metal-to-metal adhesive bonds.

A.2.3.6 Impact

- D-0950 Test method for impact strength of adhesive bonds.

A.2.3.7 Fatigue

- D-3166 Test method for fatigue properties of adhesives in shear by tension loading (metal-to-metal).

A.2.3.8 Creep

- D-1780 Practice for conducting creep tests on metal-to-metal adhesives.
- D-2293 Test method for creep properties of adhesives in shear by compression loading (metal-to-metal).
- D-2294 Test method for creep properties of adhesives in shear by torsion loading (metal-to-metal).

A.2.3.9 Fracture strength and durability

- D-3433 Practice for fracture strength in cleavage of adhesives in bonded joints. [Double cantilever specimen.]
- D-3762 Test method for adhesive bonded durability of aluminium [Wedge test.]

A.2.4 Mechanical testing: Plastic bonding**A.2.4.1 General**

Standards marked * are appropriate to Metal bonding.

A.2.4.2 Tensile

- D-1344 Tensile.
- D-2095 Tensile *
- D-3163 Test method for determining the strength of adhesively-bonded rigid-plastic lap-shear joints in shear by tension loading.
- D-3164 Test method for determining the strength of adhesively bonded plastic lap-shear sandwich joints in shear by tension loading.

A.2.4.3 Shear

- D-3983 Shear strength and modulus *
- D-4501 Shear strength *

A.2.4.4 Flexure

- D-1184 Flexural strength *

A.2.4.5 Peel

- D-0903 Peel *
- D-1781 Peel *
- D-3167 Peel *

A.2.4.6 Cleavage

- D-3807 Test method for strength properties of adhesives in cleavage peel by tension loading (engineering plastic-to-engineering plastic).

A.2.4.7 Adhesion

- D-3808 Practice for qualitative determination of adhesion for adhesives to substrates by spot adhesion test method.

A.2.5 Environmental resistance**A.2.5.1 General**

Standards marked * are appropriate to Metal bonding, [See also: 15 for discussion of some methods]

A.2.5.2 Metal bonding

- D-0896 Test method for resistance of adhesive bonds to chemical reagents.
- D-1151 Test method for effect of moisture and temperature on adhesive bonds.
- D-1183 Test methods for resistance of adhesives to cyclic laboratory ageing conditions.
- D-1828 Practice for atmospheric exposure of adhesive bonded joints and structures. Note: weathering.
- D-1879 Practice for exposure of adhesive specimens to high-energy radiation. Note: x-ray, gamma, electron, beta, etc.
- D-2295 Shear strength (D-1002), low temperatures.
- D-2557 Shear strength (D-1002), high temperatures.
- D-4299 Test method for effect of bacterial contamination on permanence of adhesive preparations and adhesive films.
- D-4300 Test method for effect of mould contamination on permanence of adhesive preparations and adhesive films.

A.2.5.3 Plastic bonding

D-0896	Chemical: *
D-1151	Moisture and temperature *
D-1183	Cyclic ageing *
D-1828	Atmospheric *
D-1879	High energy radiation *
D-2295	Low temperature shear *
D-2557	High temperature shear *
D-2918	Durability of adhesive in peel.
D-2919	Durability of adhesive in shear.
D-4299	Bacterial contamination *
D-4300	Mould contamination *
D-3929	Practice for evaluating the stress cracking of plastics by adhesives using the bent-beam method.

A.2.6 Adhesive characteristics

A.2.6.1 General

Refer to [ASTM International](#) website for details. For storage and working life properties.

A.2.6.2 Aerospace applications

Additional properties of interest to bonding applications are given, [See also: A.4; A.5]

D-3418	Glass transition temperature [For adhesives.]
D-696	Coefficient of thermal expansion. [For adhesives, adherends and mixed-material bonded assemblies, e.g. metals and composites.]
D-570	Moisture absorption [For adhesives, composite adherends and bonded assemblies.]

A.3 Standards

A.3.1 NASA standards

NASA documentation is cited within materials engineering ECSS standards and are relevant to this handbook.

NASA-STD-6001	Flammability, odor, offgassing and compatibility requirements and test procedures for materials in environments that support combustion; previously NASA NHB 8060.1 (parts A and B).
NASA RP-1124	Outgassing data for selecting spacecraft materials

A.4 European specifications

A.4.1 General

There are a large number of standards in use across Europe, covering all aspects of adhesive bonding within various industry sectors. Those listed here are some examples from:

- AECMA for European aerospace applications;
- EN standards, proposed pan-European Euro Normes;
- ISO standards from the international standards organisation.

Where an EN standard has been adopted by the standards organisation of a particular country, it is prefixed by a country code, e.g. BS EN for those adopted by British Standards Institute in the UK; NF EN within France.

A.4.2 AECMA

Some examples of standards relevant to adhesives and bonding are given. The prefix *pr* indicates provisional, always check the source standardisation group for the latest version.

<i>pr</i> EN 2000	QA Requirements for Manufacture and Procurement of EN-aerospace Standard Products
<i>pr</i> EN 2310	Non-metallic Materials: requirements and methods for Inflammability for Qualification

Green papers are available for:

EN 2243-01 Structural adhesives Single-lap shear test method.

EN 2243-02 Peel (metal-to-metal) Test Method.

EN 2243-03 Peeling Test: Metal-to-Honeycomb Test Method.

EN 2243-04 Metal-to-Honeycomb Core Flatwise Tensile Test Method.

EN 2243-05 Ageing Tests.

A.4.3 EN standards

EN 204	Classification of non-structural adhesives for joining of wood and derived timber products.
EN 205	Test Methods for wood adhesives for non-structural applications - Determination of tensile shear strength of lap joints.
EN 301:1992	Adhesives, phenolic and aminoplastic, for load-bearing timber structures: classification and performance requirements.
EN 302	Adhesives for load-bearing timber structures: test methods: Part 1:1992 Determination of bond strength in longitudinal tensile shear. Part 2:1992 Determination of resistance to delamination (Laboratory method).

	Part 3:1992 Determination of the effect of acid damage to wood fibres by temperature and humidity cycling on the transverse tensile strength.
	Part 4:1992 Determination of the effects of wood shrinkage on the shear strength.
EN 542:1995	Adhesives. Determination of density. (Norme Française T76-090).
EN 543:1995	Adhesives. Determination of apparent density of powder and granule adhesives. (Norme Française T76-091).
EN 582:1994	Thermal spraying. Determination of tensile adhesive strength.
EN 827:1995	Adhesives. Determination of conventional solids content and constant mass solids content. (Norme Française T76-101).
EN 924:1995	Adhesives. Solvent-borne and solvent-free adhesives. Determination of flash point, (Norme Française T76-093).
EN 1464:1995	Adhesives. Determination of peel resistance of high-strength adhesive bonds. Floating roller method. (Norme Française T76-112).
EN 1465:1995	Adhesives. Determination of tensile lap-shear strength of rigid-to-rigid bonded assemblies. (Norme Française T76-107).
EN 2243	Aerospace Series - Structural Adhesives - Test Methods: Part 2:1991 Peel metal-metal. Part 3:1992 Peeling test metal - honeycomb core. Part 4:1991 Metal-honeycomb core flatwise tensile test. Part 5:1992 Ageing tests.
EN 2374	Aerospace Series - Glass Fibre Reinforced Mouldings and Sandwich Composites - Production of Test Panels.
EN 2497	Aerospace Series - Dry Abrasive Blasting of Titanium and Titanium Alloys.
EN 26922:1993; ISO 6922:1987	Adhesives. Determination of tensile strength of butt joints.
EN 28510	Adhesives. Peel test for a flexible-bonded to-rigid test specimen assembly: Part 1:1993; ISO 8510-1:1990 90° Peel. Part 2:1993; ISO 8510-2:1990 180° Peel.
EN 29142:1993; ISO 9142:1990	Adhesives. Guide to the selection of standard laboratory ageing conditions for testing bonded joints.
EN 29653:1994; ISO 9653:1991	Adhesives. Test method for shear impact strength of adhesive bonds.
EN 60454	Specifications for Pressure Sensitive Adhesive Tapes for Electrical Purposes: Part 1 General Requirements. Part 2 Methods of Test.

prEN 2667:Part 6	Test Method for the Determination of Water Absorption of Structural Foam Film Adhesives.
prEN 2757	Test Method for Determining the Drying and Ignition Residues of Adhesive Primers.

A.4.4 ISO standards

ISO 4578:1990 Ed.2	Adhesives - Determination of peel resistance of high-strength adhesive bonds - Floating roller method.
ISO 4587:1995 Ed.2	Adhesives - Determination of tensile lap-shear strength of rigid-to-rigid bonded assemblies.
ISO 4588:1989 Ed.1	Adhesives - Preparation of metal surfaces for adhesive bonding.
ISO 6237:1987 Ed.1	Adhesives - Wood-to-wood adhesive bonds - Determination of shear strength by tensile loading.
ISO 6238:1987 Ed.1	Adhesives - Wood-to-wood adhesive bonds - Determination of shear strength by compression loading.
ISO 6922:1987 Ed.1; BS EN 26922:1993	Adhesives - Determination of tensile strength of butt joints.
ISO 8510:1990 Ed.1; BS EN 28510-1 & -2:1993	Adhesives - Peel test for a flexible-bonded-to-rigid test specimen assembly. Part 1: 90 degree peel. Part 2: 180 degree peel.
ISO 9142:1990 Ed.1;	BS EN 29142:1993 Adhesives - Guide to the selection of standard laboratory ageing conditions for testing bonded joints.
ISO 9653:1991 Ed.1;	BS EN 29653:1994 Adhesives - Test method for shear impact strength of adhesive bonds.
ISO 9664:1993 Ed.1	Adhesives - Test methods for fatigue properties of structural adhesives in tensile shear (Norme Française T76-111).
ISO 10123:1990 Ed.1	Adhesives - Determination of shear strength of anaerobic adhesives using pin-and-collar specimens.
ISO 10354:1992 Ed.1	Adhesives - Characterisation of durability of structural-adhesive-bonded assemblies - Wedge rupture test.
ISO 10363:1992 Ed.1	Hot-melt adhesives. - Determination of thermal stability. (Norme Française T76-120).
ISO 10364:1993 Ed.1; BS 5350:Part B4:1993	Adhesives - Determination of working life (pot life) of multi-component adhesives.
ISO 10365:1992 Ed.1	Adhesives - Designation of main failure patterns (Norme Française T76-130).
ISO 10964:1993 Ed.1	Adhesives - Determination of torque strength of anaerobic adhesives on threaded fasteners.
ISO 11003:1993 Ed.1	Adhesives - Determination of shear behaviour of structural bonds. Part 1: Torsion test method using butt-bonded hollow cylinders. Part 2: Thick-adherend tensile-test method.

- ISO 11339:1993 Ed.1; BS 5350:Part C12:1994 Adhesives - 180 degree peel test for flexible-to-flexible bonded assemblies (T-peel test).
- ISO 11343:1993 Ed.1 Adhesives - Determination of dynamic resistance to cleavage of high strength adhesive bonds under impact conditions - Wedge impact method.
- ISO 13445:1995 Ed.1 Adhesives - Determination of shear strength of adhesive bonds between rigid substrates by the block shear method.

A.5 Aircraft specifications

A.5.1 Surface preparation

A.5.1.1 General

The standard procedures used for pre-bonding preparation of metals quoted by many adhesive suppliers and within development studies are those process specifications developed by aircraft manufacturers; especially Boeing Airplane Company (BAC).

[See also: A.2; A.4; A.6]

A.5.1.2 Aluminium alloys

BAC 5555 Phosphoric acid anodising of aluminium alloys for structural bonding.

A.5.1.3 Titanium alloys

BAC 5890 Anodising of titanium for adhesive bonding.

A.5.2 Development processes

The majority of proven prebonding treatments use solvents for degreasing; many use chromium-containing chemicals too. Legislation restricting the use of heavy-metals and solvents means developing new surface treatment processes that provide adequate bond characteristics. This is a continuing task within the aerospace community, [See: 12.4].

A.6 US federal specifications

The specifications listed were derived specifically for aerospace structural bonding applications and are often quoted in publications of US-origin.

- MMM-A-132 Airframe structure (metal-to-metal).
- MIL-A-25463 Sandwich panels (metal skin:metal honeycomb).
- MIL-A-8625 Anodic coatings for aluminium and aluminium alloys; describes anodising processes

MIL-C-5541	Chemical conversion processes on aluminium alloys; describes chromating processes
MIL-HDBK-337	Adhesive bonded aerospace structure repair

A.7 References

A.7.1 General

- [A-1] R. Hussey & J. Wilson: RJ Technical Consultants
'Structural Adhesives Directory and Databook'
Chapman & Hall, ISBN 0 412 71470 1 (1996)

A.7.2 Sources

American Society for Testing Materials, [See: [ASTM International](#)]
International Organisation for Standards, [Email: [ISO](#)]

Annex B

ESAComp®: Example

B.1 Introduction

B.1.1 General

The ESAComp® software package is widely-known within the aerospace industry, [See: 10.13]. The design and analysis process for adhesive bonds within ESAComp® is described in a technical paper, presented at an ESA-ESTEC conference in 2000.

Under ESA-ESTEC funding, [Componeering Inc.](http://www.componeering.com) (Finland) developed an on-line interface for bonded joint design and analysis based on the approach used in ESAComp® (www.esacomp.com).

For further information visit the [Componeering Inc.](http://www.componeering.com) website.

B.1.2 Web-based application concept history

B.1.2.1 Initial Approach

Firstly, adhesive plies and reinforced plies are defined. Reinforced plies are stacked to form laminates. If non-composite adherends are to be considered, a single ply laminate can be defined.

Laminates and adhesive plies are then combined to form joints. The mechanical load applied on a joint becomes a load object together with the support condition. A bonded joint analysis is specified by selecting a joint and a load object. The problem is solved using ESAComp® analysis tools. Results are provided according to the specified analysis type in numeric and graphic forms. This workflow covers several parts of the design chart, [See: Figure 10.16-1], which serves as an aide memoir to factors to be considered during a bonded design.

In the initial implementation, reinforced plies can be isotropic or orthotropic. Adherend failure is not covered in the analysis. Consequently, only the engineering constants are needed for reinforced plies. In addition, thickness of the ply is needed. The input data for adhesives are the engineering constants of an isotropic material and the failure strength in tension and compression. Only linear-elastic material model is considered currently, though bi-linear models can be used for adhesives in ESAComp®.

Originally the idea was that the user defines laminates by giving their in-plane and bending stiffness. However, it became evident that it is actually easier to create a web interface for defining laminate lay-ups layer-by-layer because internally ESAComp® handles laminates this way. The advantages were that no modifications were needed in ESAComp® itself and the possibility to define laminate lay-ups is a possible further development for ECSS-related web applications.

The joint types that were implemented during this initial project were single lap and double lap joints because these joint types are widely considered in the handbook, [See: Chapter 10], and they are also among the joint types covered by ESAComp®. The full capabilities of ESAComp® were used when it came to the implementation of possible load cases and boundary conditions.

In the load response, adhesive stresses are provided using both a graphical presentation and displaying maximum absolute values of stress components as numerical values. Failure analysis calculates the margin to failure in the adhesive in terms of margin of safety.

B.1.2.2 Data input

A web application consists of forms displayed in the web browser. A 'wizard-type' design approach was used in which the user has only a few choices or input fields on one form; instead of complex, fully interactive forms instigated under HTML.

B.1.2.3 Material database

The handbook describes several adhesive systems, [See: Chapter 6], but complete sets of material design properties are not given.

In developing the web-based application, one epoxy-based film adhesive and one epoxy-based paste adhesive were included in the material database of the web application. Two representative reinforced plies were also created in the database.

Additional material data can be easily added in the database. The data is entered as static information in the system, i.e. it is available for later use once it is defined.

B.1.2.4 Evaluation

The web application was set-up for test on a server within the Componeering intranet.

B.1.2.5 Verification

The interaction between the different modules of the web-based system was verified successfully.

The validity of results provided by the system was also verified against results produced with ESAComp® directly.

B.2 References

B.2.1 General

- F. Mortensen, O.T. Thomsen & M. Palanterä: Aalborg University (Denmark)/Componeering Inc. (Finland)
'Facilities in ESAComp for analysis and design of adhesive bonded joints'
Proceedings of European Conference on Spacecraft Structures, Materials and Mechanical Testing, ESA/ESTEC, Noordwijk, The Netherlands, 29 November – 1 December 2000. ESA SP-468
- H. Katajisto & P. Kleimola: Componeering Inc (Finland).
'ESAComp Working Example - Final Report' December 2005.
ESTEC Contract No. 15865/CCN03 – WO 01