

# UNIFIED FACILITIES CRITERIA (UFC)

---

## DESIGN: CLEAN ROOMS



APPROVED FOR PUBLIC RELEASE; DISTRIBUTION UNLIMITED

UFC 4-310-02N  
16 January 2004

## UNIFIED FACILITIES CRITERIA (UFC)

**DESIGN: CLEAN ROOMS**

Any copyrighted material included in this UFC is identified at its point of use.  
Use of the copyrighted material apart from this UFC must have the permission of the  
copyright holder.

U.S. ARMY CORPS OF ENGINEERS

NAVAL FACILITIES ENGINEERING COMMAND (Preparing Activity)

AIR FORCE CIVIL ENGINEERING SUPPORT AGENCY

Record of Changes (changes indicated by \1\ ... /1/ )

| <u>Change No.</u> | <u>Date</u> | <u>Location</u> |
|-------------------|-------------|-----------------|
|                   |             |                 |
|                   |             |                 |

**UFC 4-310-02N**  
**16 January 2004**

## FOREWORD

The Unified Facilities Criteria (UFC) system is prescribed by MIL-STD 3007 and provides planning, design, construction, sustainment, restoration, and modernization criteria, and applies to the Military Departments, the Defense Agencies, and the DoD Field Activities in accordance with [USD\(AT&L\) Memorandum](#) dated 29 May 2002. UFC will be used for all DoD projects and work for other customers where appropriate. All construction outside of the United States is also governed by Status of forces Agreements (SOFA), Host Nation Funded Construction Agreements (HNFA), and in some instances, Bilateral Infrastructure Agreements (BIA.) Therefore, the acquisition team must ensure compliance with the more stringent of the UFC, the SOFA, the HNFA, and the BIA, as applicable.

UFC are living documents and will be periodically reviewed, updated, and made available to users as part of the Services' responsibility for providing technical criteria for military construction. Headquarters, U.S. Army Corps of Engineers (HQUSACE), Naval Facilities Engineering Command (NAVFAC), and Air Force Civil Engineer Support Agency (AFCESA) are responsible for administration of the UFC system. Defense agencies should contact the preparing service for document interpretation and improvements. Technical content of UFC is the responsibility of the cognizant DoD working group. Recommended changes with supporting rationale should be sent to the respective service proponent office by the following electronic form: [Criteria Change Request \(CCR\)](#). The form is also accessible from the Internet sites listed below.

UFC are effective upon issuance and are distributed only in electronic media from the following source:

- Whole Building Design Guide web site <http://dod.wbdg.org/>.

Hard copies of UFC printed from electronic media should be checked against the current electronic version prior to use to ensure that they are current.

### AUTHORIZED BY:



DONALD L. BASHAM, P.E.  
 Chief, Engineering and Construction  
 U.S. Army Corps of Engineers



DR. JAMES W. WRIGHT, P.E.  
 Chief Engineer  
 Naval Facilities Engineering Command

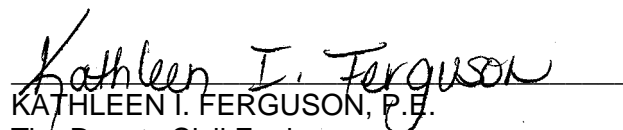

KATHLEEN I. FERGUSON, P.E.  
 The Deputy Civil Engineer  
 DCS/Installations & Logistics  
 Department of the Air Force

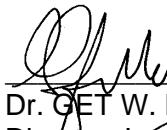

Dr. GET W. MOY, P.E.  
 Director, Installations Requirements and  
 Management  
 Office of the Deputy Under Secretary of Defense  
 (Installations and Environment)

**CONTENTS**

|                                            | Page |
|--------------------------------------------|------|
| CHAPTER 1 INTRODUCTION                     |      |
| Paragraph 1-1 PURPOSE AND SCOPE .....      | 1-1  |
| 1-2 APPLICABILITY .....                    | 1-1  |
| 1-2.1 General Building Requirements .....  | 1-1  |
| 1-2.2 Safety .....                         | 1-1  |
| 1-2.3 Fire Protection .....                | 1-1  |
| 1-2.4 Antiterrorism/Force Protection ..... | 1-1  |
| APPENDIX A MIL-HDBK 1028/5A .....          | A-1  |

## CHAPTER 1

### INTRODUCTION

1-1 **PURPOSE AND SCOPE.** This UFC is comprised of two sections. Chapter 1 introduces this UFC and provides a listing of references to other Tri-Service documents closely related to the subject. Appendix A contains the full text copy of the previously released Military Handbook (MIL-HDBK) on this subject. This UFC serves as criteria until such time as the full text UFC is developed from the MIL-HDBK and other sources.

This UFC provides general criteria for the design of clean rooms.

Note that this document does not constitute a detailed technical design, maintenance or operations manual, and is issued as a general guide to the considerations associated with the design of clean rooms.

1-2 **APPLICABILITY.** This UFC applies to all Navy service elements and Navy contractors preparing designs of clean rooms: all other DoD agencies may use this document unless explicitly directed otherwise.

1-2.1 **GENERAL BUILDING REQUIREMENTS.** All DoD facilities must comply with UFC 1-200-01, *Design: General Building Requirements*. If any conflict occurs between this UFC and UFC 1-200-01, the requirements of UFC 1-200-01 take precedence.

1-2.2 **SAFETY.** All DoD facilities must comply with DODINST 6055.1 and applicable Occupational Safety and Health Administration (OSHA) safety and health standards.

**NOTE:** All **NAVY** projects, must comply with OPNAVINST 5100.23 (series), *Navy Occupational Safety and Health Program Manual*. The most recent publication in this series can be accessed at the NAVFAC Safety web site:

[www.navfac.navy.mil/safety/pub.htm](http://www.navfac.navy.mil/safety/pub.htm). If any conflict occurs between this UFC and OPNAVINST 5100.23, the requirements of OPNAVINST 5100.23 take precedence.

1-2.3 **FIRE PROTECTION.** All DoD facilities must comply with UFC 3-600-01, *Design: Fire Protection Engineering for Facilities*. If any conflict occurs between this UFC and UFC 3-600-01, the requirements of UFC 3-600-01 take precedence.

1-2.4 **ANTITERRORISM/FORCE PROTECTION.** All DoD facilities must comply with UFC 4-010-01, *Design: DoD Minimum Antiterrorism Standards for Buildings*. If any conflict occurs between this UFC and UFC 4-010-01, the requirements of UFC 4-010-01 take precedence.

UFC 4-310-02N  
16 January 2004

**APPENDIX A**

**MIL-HDBK 1028/5A  
CLEAN ROOMS**

**INCH-POUND**

**MIL-HDBK-1028/5A**  
**30 SEPTEMBER 1994**  
**SUPERSEDING**  
**MIL-HDBK-1028/5**  
**15 MAY 1989**

**MILITARY HANDBOOK**  
**ENVIRONMENTAL CONTROL - DESIGN OF CLEAN ROOMS**



AMSC N/A

AREA FACR

**DISTRIBUTION STATEMENT A : APPROVED FOR PUBLIC RELEASE; DISTRIBUTION IS UNLIMITED.**

MIL-HDBK-1028/5A

ABSTRACT

This handbook provides basic design guidance for environmentally controlled clean room facilities and is presented for use by experienced architects and engineers. The contents include design data for the fabrication and construction of closely controlled environmental areas in which varying degrees of dust-free operations can be performed. Criteria cover conventional nonlaminar flow and horizontal and vertical laminar flow with consideration of new construction of clean rooms, prefabricated clean rooms, and the upgrading of existing clean rooms. Additional information can be found in the literature listed in the REFERENCES.



MIL-HDBK-1028/5A

FOREWORD

This handbook has been developed from an evaluation of facilities in the shore establishment, from surveys of the availability of new materials and construction methods, and from selection of the best design practices of the Naval Facilities Engineering Command (NAVFACENGCOM), other Government agencies, and the private sector. This handbook was prepared using, to the maximum extent feasible, national professional society, association, and institute standards. Deviations from these criteria in the planning, engineering, design, and construction of Naval shore facilities cannot be made without prior approval of NAVFACENGCOM HQ (Code 15C).

Design cannot remain static any more than can the functions it serves or the technologies it uses. Accordingly, recommendations for improvement are encouraged and should be furnished to Commander, Naval Facilities Engineering Service Center (NFESC), 560 Center Drive, Port Hueneme, CA 93043; commercial telephone (805) 982-2639.

THIS HANDBOOK SHALL NOT BE USED AS A REFERENCE DOCUMENT FOR PROCUREMENT OF FACILITIES CONSTRUCTION. IT IS TO BE USED IN THE PURCHASE OF FACILITIES ENGINEERING STUDIES AND DESIGN (FINAL PLANS, SPECIFICATIONS, AND COST ESTIMATES). DO NOT REFERENCE IT IN MILITARY OR FEDERAL SPECIFICATIONS OR OTHER PROCUREMENT DOCUMENTS.

## MIL-HDBK-1028/5A

## MAINTENANCE FACILITIES CRITERIA MANUALS

| Criteria Manual | Title                                                         | PA       |
|-----------------|---------------------------------------------------------------|----------|
| MIL-HDBK-1028/1 | Aircraft Maintenance Facilities                               | LANTDIV  |
| MIL-HDBK-1028/3 | Maintenance Facilities for Ammunition, Explosives, and Toxics | NFESC    |
| DM-28.4         | General Maintenance Facilities                                | CHESDIV  |
| MIL-HDBK-1028/5 | Environmental Control - Design of Clean Rooms                 | NFESC    |
| MIL-HDBK-1028/6 | Aircraft Fixed Point Utility Systems                          | SOUTHDIV |

## MIL-HDBK-1028/5A

## CONTENTS

|           |                                                    | Page |
|-----------|----------------------------------------------------|------|
| Section 1 | INTRODUCTION                                       |      |
| 1.1       | Scope .....                                        | 1    |
| 1.2       | Cancellation .....                                 | 1    |
| 1.3       | Policy .....                                       | 1    |
| Section 2 | ENERGY CONSERVATION                                |      |
| 2.1       | General .....                                      | 2    |
| 2.2       | Energy Savings by Clean Room Class Selection ..... | 2    |
| 2.3       | Primary Energy Conservation Considerations .....   | 2    |
| 2.3.1     | Room Layout .....                                  | 2    |
| 2.3.2     | Airflow .....                                      | 2    |
| 2.3.3     | Coils .....                                        | 3    |
| 2.4       | Energy Conservation Design .....                   | 3    |
| 2.4.1     | Dry Coils .....                                    | 3    |
| 2.4.1.1   | Transfer Coil .....                                | 3    |
| 2.4.1.2   | Chilled Water Return Piping .....                  | 3    |
| 2.4.1.3   | Chilled Water Supply Piping .....                  | 4    |
| 2.4.1.4   | Bypass Air .....                                   | 4    |
| 2.4.2     | Duty Cycle .....                                   | 4    |
| 2.4.3     | Humidification .....                               | 4    |
| Section 3 | PLANNING AND DESIGN CRITERIA                       |      |
| 3.1       | General Requirements .....                         | 9    |
| 3.2       | Site Planning .....                                | 9    |
| 3.2.1     | Entrances .....                                    | 9    |
| 3.2.2     | Parking and Service Areas .....                    | 9    |
| 3.2.3     | Isolation .....                                    | 9    |
| 3.2.4     | Soil and Subsoil Conditions .....                  | 9    |
| 3.3       | Materials and Construction Systems .....           | 9    |
| 3.3.1     | Structural Framing .....                           | 10   |
| 3.3.2     | Wall/Partition Construction .....                  | 10   |
| 3.3.3     | Floor Construction .....                           | 10   |
| 3.3.4     | Ceiling Construction .....                         | 10   |
| 3.3.5     | Finishes .....                                     | 10   |
| 3.3.5.1   | Floor Finishes .....                               | 11   |
| 3.3.5.2   | Bases .....                                        | 11   |
| 3.3.5.3   | Wall/Partition Finishes .....                      | 11   |
| 3.3.5.4   | Ceiling Finishes .....                             | 12   |
| 3.3.6     | Trim and Openings .....                            | 12   |
| 3.3.7     | Central Vacuum Cleaning System .....               | 13   |
| 3.3.8     | Support Rooms .....                                | 13   |
| 3.3.8.1   | Change Rooms .....                                 | 13   |
| 3.3.8.2   | Toilets .....                                      | 13   |
| 3.3.8.3   | Washrooms .....                                    | 13   |
| 3.3.8.4   | Locker Rooms .....                                 | 13   |
| 3.3.8.5   | Offices or Supervisor Areas .....                  | 13   |
| 3.3.9     | Clean Room Equipment .....                         | 13   |

## MIL-HDBK-1028/5A

|           | Page                                            |    |
|-----------|-------------------------------------------------|----|
| 3.4       | Vibration Isolation .....                       | 14 |
| 3.4.1     | Isolators .....                                 | 14 |
| 3.4.2     | Consideration of Other Facilities .....         | 14 |
| 3.5       | Acoustics and Noise Control .....               | 14 |
| 3.5.1     | Sound and Impact Noise Isolation .....          | 14 |
| 3.5.2     | Background Noise Levels .....                   | 14 |
| 3.6       | Installation of Utility Sources .....           | 14 |
| 3.7       | Cleaning Requirements During Construction ..... | 15 |
| 3.7.1     | Dust-Producing Construction .....               | 15 |
| 3.7.2     | Air Handling Ducts .....                        | 15 |
| 3.7.3     | Equipment, Furniture, and Utilities .....       | 15 |
| 3.8       | Facility Components .....                       | 15 |
| 3.8.1     | Personnel Air Locks .....                       | 15 |
| 3.8.2     | Equipment Air Locks .....                       | 15 |
| 3.8.3     | Air Showers .....                               | 16 |
| 3.8.4     | Shoe Cleaner .....                              | 16 |
| 3.8.5     | Pass Boxes or Pass Windows .....                | 16 |
| 3.8.6     | Observation Windows .....                       | 18 |
| 3.9       | Color Treatment .....                           | 18 |
| 3.10      | Electrical Systems .....                        | 18 |
| 3.10.1    | Lighting .....                                  | 18 |
| 3.10.2    | Grounding .....                                 | 19 |
| 3.11      | Mechanical Systems .....                        | 19 |
| 3.11.1    | Air Conditioning System Requirements .....      | 19 |
| 3.11.1.1  | General .....                                   | 19 |
| 3.11.1.2  | Filter Installation .....                       | 20 |
| 3.11.1.3  | Operation .....                                 | 20 |
| 3.11.1.4  | System Components .....                         | 20 |
| 3.11.1.5  | Makeup Air .....                                | 20 |
| 3.11.2    | Special Systems and Utilities .....             | 20 |
| 3.11.2.1  | High Vacuum .....                               | 21 |
| 3.11.2.2  | Special Gases .....                             | 21 |
| 3.11.2.3  | Special Cleaning Solvents .....                 | 21 |
| 3.11.2.4  | Exhaust Systems .....                           | 21 |
| 3.11.2.5  | Compressed Air .....                            | 21 |
| 3.11.2.6  | Water Systems .....                             | 21 |
| 3.11.2.7  | Central Vacuum Cleaning Systems .....           | 22 |
| 3.12      | Fire Protection .....                           | 22 |
| 3.12.1    | Construction .....                              | 22 |
| 3.12.2    | Exits .....                                     | 22 |
| 3.12.3    | Sprinkler System .....                          | 22 |
| 3.12.4    | Gaseous Fire Extinguishing Systems .....        | 22 |
| 3.12.5    | Conventional Clean Rooms .....                  | 22 |
| 3.12.6    | Laminar Flow Clean Rooms .....                  | 22 |
| 3.12.7    | Smoke Control System .....                      | 22 |
| 3.12.8    | Control Valves .....                            | 23 |
| Section 4 | ACCEPTANCE TESTS AND CONTAMINATION CURVES       |    |
| 4.1       | Acceptance Tests .....                          | 24 |
| 4.1.1     | Airborne Particle Counts .....                  | 24 |

## MIL-HDBK-1028/5A

|           |                                                                            | Page |
|-----------|----------------------------------------------------------------------------|------|
| 4.1.1.1   | Nonlaminar Flow Clean Rooms .....                                          | 24   |
| 4.1.1.2   | Laminar Flow Clean Rooms .....                                             | 24   |
| 4.1.2     | Individual Tests .....                                                     | 24   |
| 4.1.2.1   | Filters .....                                                              | 24   |
| 4.1.2.2   | Room Pressure Tests .....                                                  | 24   |
| 4.1.2.3   | Airborne Particle Counting .....                                           | 24   |
| 4.1.2.4   | Airflow Test .....                                                         | 24   |
| 4.2       | Distribution Curves and Cleanliness Requirements .....                     | 24   |
| 4.2.1     | Air Cleanliness Classes .....                                              | 24   |
| 4.2.2     | Particle Size Distribution Curves .....                                    | 25   |
| 4.2.3     | Cleanliness Requirements Versus Particle Size<br>Distribution Curves ..... | 25   |
| 4.2.4     | Typical Particle Sizes .....                                               | 25   |
| 4.3       | Guidelines for Clean Room Classes .....                                    | 25   |
| Section 5 | CLEAN ROOM DESIGNS                                                         |      |
| 5.1       | Nonlaminar Flow (Conventional) Clean Rooms .....                           | 30   |
| 5.1.1     | Facility Components .....                                                  | 30   |
| 5.1.2     | Support Areas .....                                                        | 30   |
| 5.1.3     | Electrical Systems .....                                                   | 30   |
| 5.1.4     | Mechanical Systems .....                                                   | 30   |
| 5.2       | Horizontal Laminar Flow Clean Rooms .....                                  | 31   |
| 5.2.1     | Advantages .....                                                           | 31   |
| 5.2.2     | Design .....                                                               | 31   |
| 5.3       | Downflow Clean Rooms (Vertical Laminar Flow) .....                         | 32   |
| 5.3.1     | Advantages .....                                                           | 32   |
| 5.3.2     | Design .....                                                               | 39   |
| 5.4       | Prefabricated Clean Rooms .....                                            | 40   |
| 5.4.1     | Specifications .....                                                       | 40   |
| 5.4.2     | Design Requirements .....                                                  | 41   |
| 5.4.3     | Acceptance tests .....                                                     | 41   |
| 5.5       | Missile Overhaul and Cleaning Facilities .....                             | 41   |
| 5.5.1     | Type Clean Room Required .....                                             | 41   |
| 5.5.2     | Material Handling .....                                                    | 41   |
| 5.6       | Upgrading of Existing Clean Rooms .....                                    | 42   |
| 5.6.1     | Clean Work Stations .....                                                  | 42   |
| 5.6.2     | Movable Laminar Flow Booth (Downflow Units) .....                          | 44   |
| 5.6.3     | Tunnel Units .....                                                         | 44   |
| 5.6.4     | Filter Bank Module .....                                                   | 44   |

## FIGURES

|          |                                                              |    |
|----------|--------------------------------------------------------------|----|
| Figure 1 | Primary Airstream Using a Dry Coil .....                     | 5  |
| 2        | Outdoor Air Transfer Coil With Dry Coils .....               | 6  |
| 3        | Dry Coil Piping .....                                        | 7  |
| 4        | Primary Airstream With Bypass Air .....                      | 8  |
| 5        | Air Shower Velocity Versus Personnel<br>Time in Shower ..... | 17 |

## MIL-HDBK-1028/5A

|        |    | Page                                                                          |    |
|--------|----|-------------------------------------------------------------------------------|----|
| Figure | 6  | Particle Size Distribution Curves .....                                       | 26 |
|        | 7  | Cleanliness Requirements Versus Particle Size<br>Distribution Curves .....    | 27 |
|        | 8  | Typical Particle Size .....                                                   | 28 |
|        | 9  | Plan View of a Conventional Clean Room Area<br>With Clean Work Stations ..... | 33 |
|        | 10 | Horizontal Laminar Airflow Paths .....                                        | 34 |
|        | 11 | Vertical Laminar Airflow Paths .....                                          | 35 |
|        | 12 | Vertical Flow Room With Basement .....                                        | 36 |
|        | 13 | Vertical Flow Ceiling Unit .....                                              | 37 |
|        | 14 | Vertical Laminar Flow .....                                                   | 38 |
|        | 15 | Built-in Clean Work Station .....                                             | 45 |
|        | 16 | Horizontal Laminar Flow Bench .....                                           | 46 |
|        | 17 | Vertical Laminar Flow Bench .....                                             | 47 |
|        | 18 | Laminar Flow Exhaust Hood .....                                               | 48 |
|        | 19 | Movable Laminar Flow Clean Booth .....                                        | 49 |
|        | 20 | Filter Bank Module .....                                                      | 50 |

## TABLES

|                    |   |                                         |    |
|--------------------|---|-----------------------------------------|----|
| Table              | 1 | Guidelines for Clean Room Classes ..... | 29 |
| BIBLIOGRAPHY ..... |   |                                         | 51 |
| REFERENCES .....   |   |                                         | 52 |
| GLOSSARY .....     |   |                                         | 55 |

MIL-HDBK-1028/5A

Section 1: INTRODUCTION

1.1 Scope. This military handbook presents criteria for the fabrication and construction of closely controlled environmental areas in which the following can be performed at Naval Shore activities:

- a) Quality control;
- b) Laboratory techniques and precision control;
- c) Repair, assembly, calibration, and tests of components;
- d) Photoprocessing of high-level photoreconnaissance;
- e) Microminiaturization images;
- f) Loading and unloading of film magazines;
- g) Film editing and cutting;
- h) Print inspection;
- i) Dust-free operations.

The requirements could make it necessary to achieve dust-free areas with precise control over temperature and humidity. In many instances, it is necessary to eliminate particles 0.3 micron and larger from the controlled area.

1.2 Cancellation. This handbook, MIL-HDBK-1028/5A, cancels and supersedes MIL-HDBK-1028/5 dated 15 May 1989.

1.3 Policy. Environmentally controlled facilities must fulfill specific requirements of the Naval Air Systems Command (NAVAIR) and Naval Sea Systems Command (NAVSEA).

## MIL-HDBK-1028/5A

## Section 2: ENERGY CONSERVATION

2.1 General. Energy conservation shall be a major consideration in the design of clean room envelopes, mechanical systems, and electrical systems. NAVFAC DM-3.03, Heating, Ventilating, Air Conditioning and Dehumidifying Systems, contains design criteria that should be considered for general energy conservation measures that would be applicable to clean room design.

2.2 Energy Savings by Clean Room Class Selection. Modern clean room tasks nearly always require laminar flow because of the decreasing size and increasing sophistication of equipment to be maintained. This smaller size equipment may allow smaller sizes of laminar flow clean rooms or may allow suitably designed laminar flow work stations to be used in lieu of the more energy consuming laminar flow room. Classes 10,000 and 100,000 (SI classes M5.5 and M6.5) nonlaminar flow (conventional) clean rooms are useful chiefly to provide a suitable environment for laminar flow work stations. Class 1,000 (class M4.5) clean rooms should not be provided as an environment for laminar flow work stations since they are unnecessarily clean and too expensive to maintain. Class 100 (class M3.5) or better cleanliness is produced at the "first air" leaving a High Efficiency Particulate Air (HEPA) filter that is preceded by a medium or high efficiency prefilter. This cleanliness can be provided by the following laminar flow clean spaces listed in the order of increasing cost to construct and maintain:

- a) Laminar flow work station in a normal air-conditioned space;
- b) Laminar flow work station in a conventional clean room;
- c) Horizontal laminar flow clean room;
- d) Vertical laminar flow clean room.

2.3 Primary Energy Conservation Considerations. Some primary energy conservation measures that should be considered in clean room design are as follows:

2.3.1 Room Layout. Provide compact room layout that will fulfill process requirements without oversizing rooms and increasing capacities of support equipment. Confine the areas with high protection requirements with suitable plastic curtains or dividing walls, thus separating them physically from the external areas with reduced protection requirements.

2.3.2 Airflow

- a) Provide variable speed fan motors, to maintain a constant laminar airflow rate through the filter system, where they are proven to be economical.
- b) Design airflow systems using conservative velocities through coils, filters, and ductwork, thus reducing fan horsepower. (Refer to American Society of Heating, Refrigerating and Air-Conditioning Engineers (ASHRAE) Standard 90A, Energy Conservation in New Building Design.)



## MIL-HDBK-1028/5A

- c) Pass supply and exhaust air through noncontact heat exchangers wherever advantageous.
- d) Exhaust process generated latent loads outside the room, to minimize loads on cooling equipment, when the additional outside air requirements will not increase cooling loads.
- e) Use minimum makeup air quantities consistent with requirements set forth in the ASHRAE handbooks.
- f) Obtain makeup air from adjacent building spaces, when the air will be a cleaner source than outdoor air, to minimize load through air filters.
- g) Include manometers or warning devices on filter banks to indicate dirty filters.

### 2.3.3 Coils

- a) Use dry coil sensible heat removal in primary air circuits of laminar flow rooms. (Refer to paragraph 2.4.1.)
- b) Use sprayed coil dehumidification in makeup air unit where climate renders it economically feasible.

2.4 Energy Conservation Design. The design of clean room spaces should include consideration of innovative design techniques and higher first cost systems that will result in overall energy conservation. The additional first cost of systems and equipment should be compared to the long range energy savings that could be expected over the anticipated period of time that the facility will be in use, by completion of a life cycle cost analysis. Some design techniques and equipment that should be considered are described in paragraphs 2.4.1 through 2.4.3.

2.4.1 Dry Coils. In laminar flow systems, fan sensible heat may be used for reheat purposes; however, fan sensible heat not needed for reheat purposes may be removed from the primary airstream by use of "dry coils." The dry coil should be located in the primary airstream ahead of the HEPA filter, and may be on either side of the primary air fan. The capacity of the coil is regulated by a modulating water valve controlled by a thermostat just downstream of the HEPA filter. (See Figure 1 for a typical primary airstream using a dry coil.) Cooling water for the dry coil can be provided from a transfer coil in a makeup air unit, building chilled water return piping, or building chilled water supply piping.

2.4.1.1 Transfer Coil. If a transfer coil is used to provide cooling water for the dry coils, the transfer coil may be placed in any outdoor air-stream large enough to handle the cooling load of the dry coils under all weather conditions. (See Figure 2 for a typical transfer coil installation and the piping between the transfer coil and the dry coil.)

2.4.1.2 Chilled Water Return Piping. The return line to the building water chiller can be used as a source of cooling water, when the return water

## MIL-HDBK-1028/5A

temperature is low enough to maintain approximately 60 degrees Fahrenheit (°F) (15.6° Celsius (C)) in the dry coil piping loop. (See Figure 3 for a typical chilled water return piping.)

2.4.1.3 Chilled Water Supply Piping. The supply piping from the building water chiller can be used as a source of cooling water when the capacity of the water chiller is sufficient to handle the additional load. (See Figure 3 for a typical two-pipe installation using a feed from chilled water supply piping.)

2.4.1.4 Bypass Air. When dry coils cannot be used, cooling of the primary airstream is accomplished by bypassing part of the primary air through a conventional air conditioning system sized to remove excess heat from the room (see Figure 4).

2.4.2 Duty Cycle

a) Laminar flow work stations should be designed to run only when needed, with allowance made for self-cleaning startup action. Consideration should be given to stored cooling cycles (thermal storage) when cooling is performed at off-peak hours.

b) Laminar flow rooms should be designed to be easily shut down when they are not needed. The use of variable speed fan motors would permit the clean room to "idle" at less than full load when laminar flow is not needed. Thermal storage for chilled water should be considered if the clean room has peaks in its duty cycle.

2.4.3 Humidification. Sprayed coils and wet cooling coils in a laminar flow installation should have air side surfaces which remain clean. Water used for humidification must be free of materials which are contaminating, corrosive, or scaling. If distilled or deionized water is used, consideration should be given to producing the water during off-peak hours and storing it in suitable closed tanks until needed.

MIL-HDBK-1028/5A

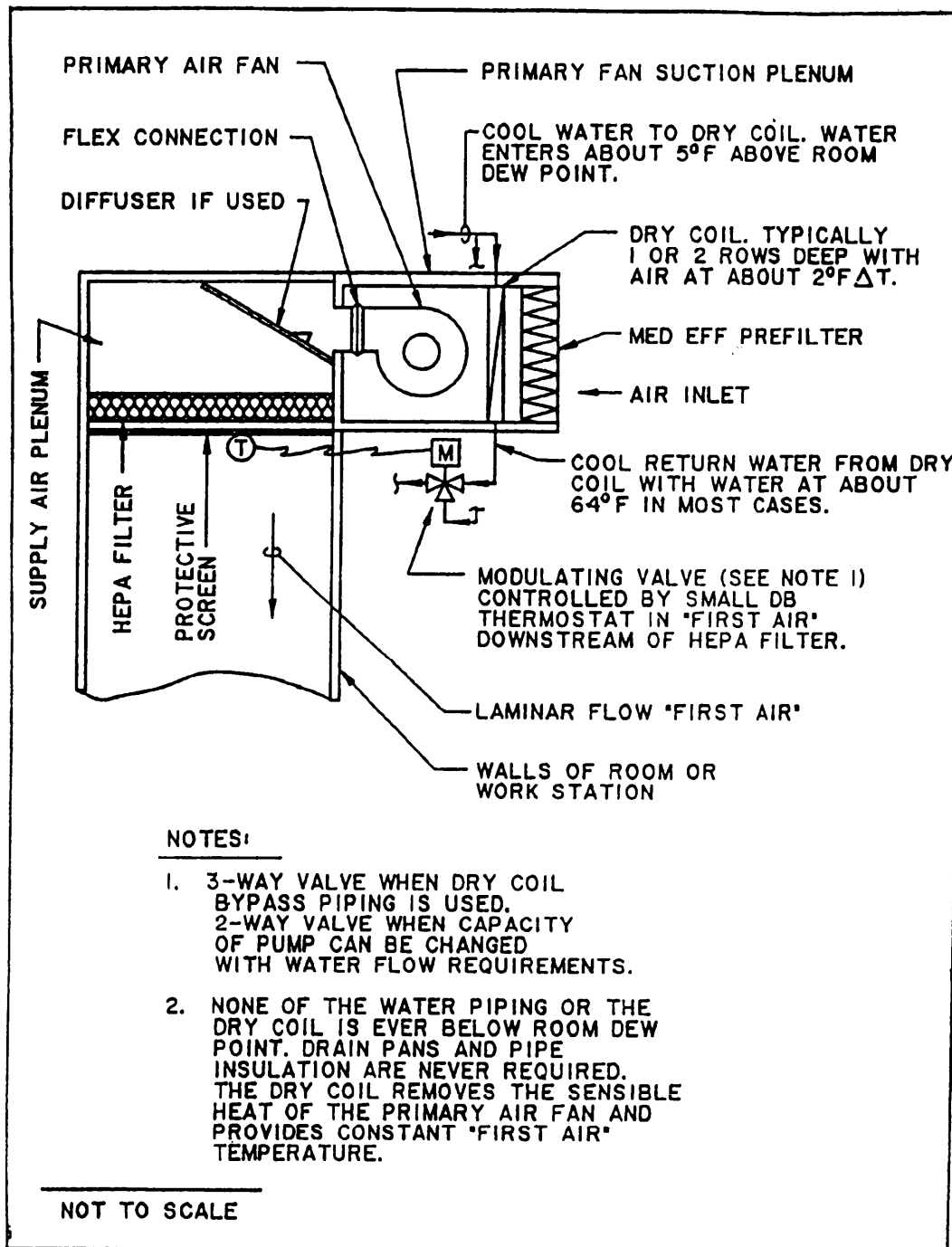

Figure 1  
Primary Airstream Using a Dry Coil

MIL-HDBK-1028/5A

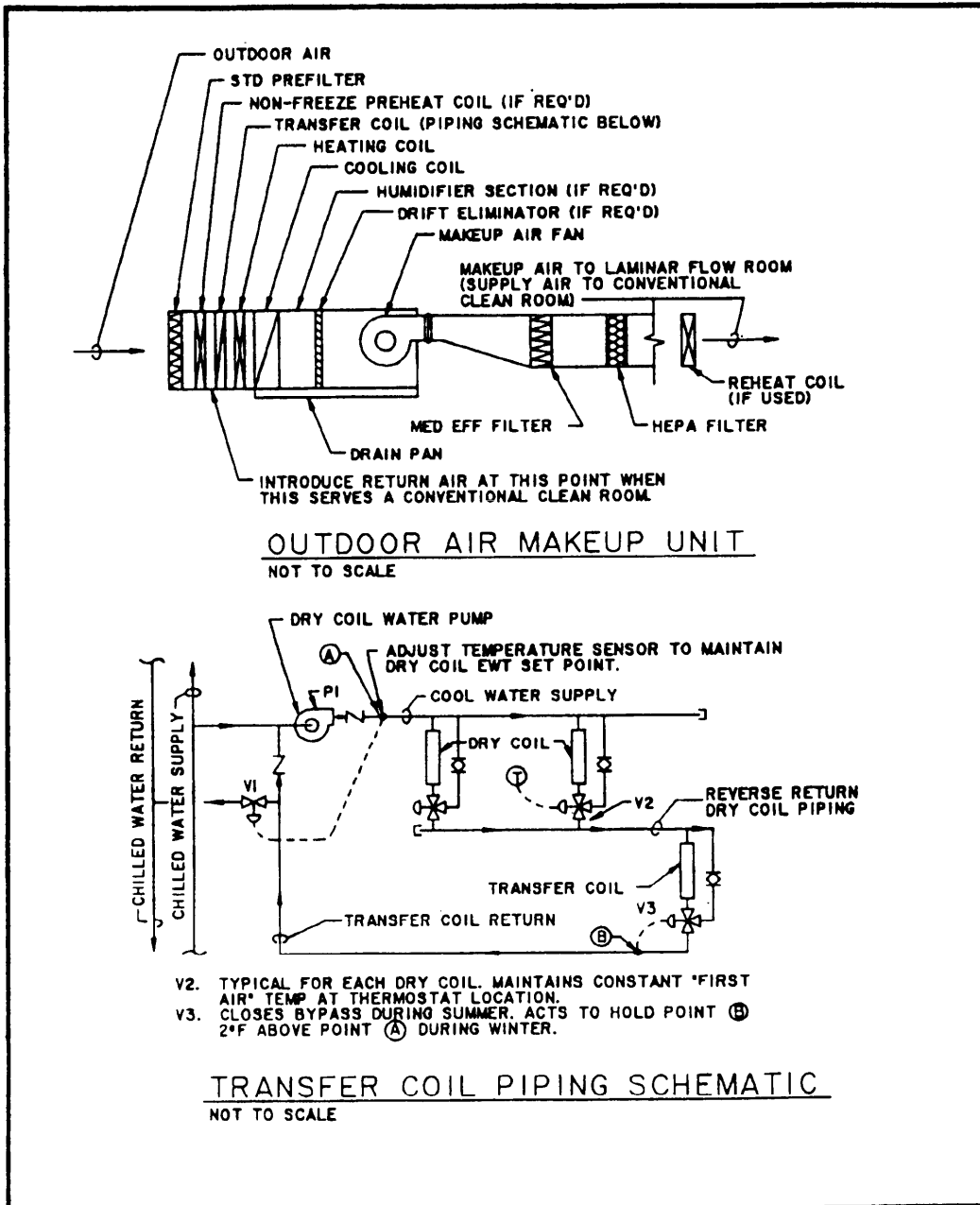

Figure 2  
Outdoor Air Transfer Coil with Dry Coils

MIL-HDBK-1028/5A

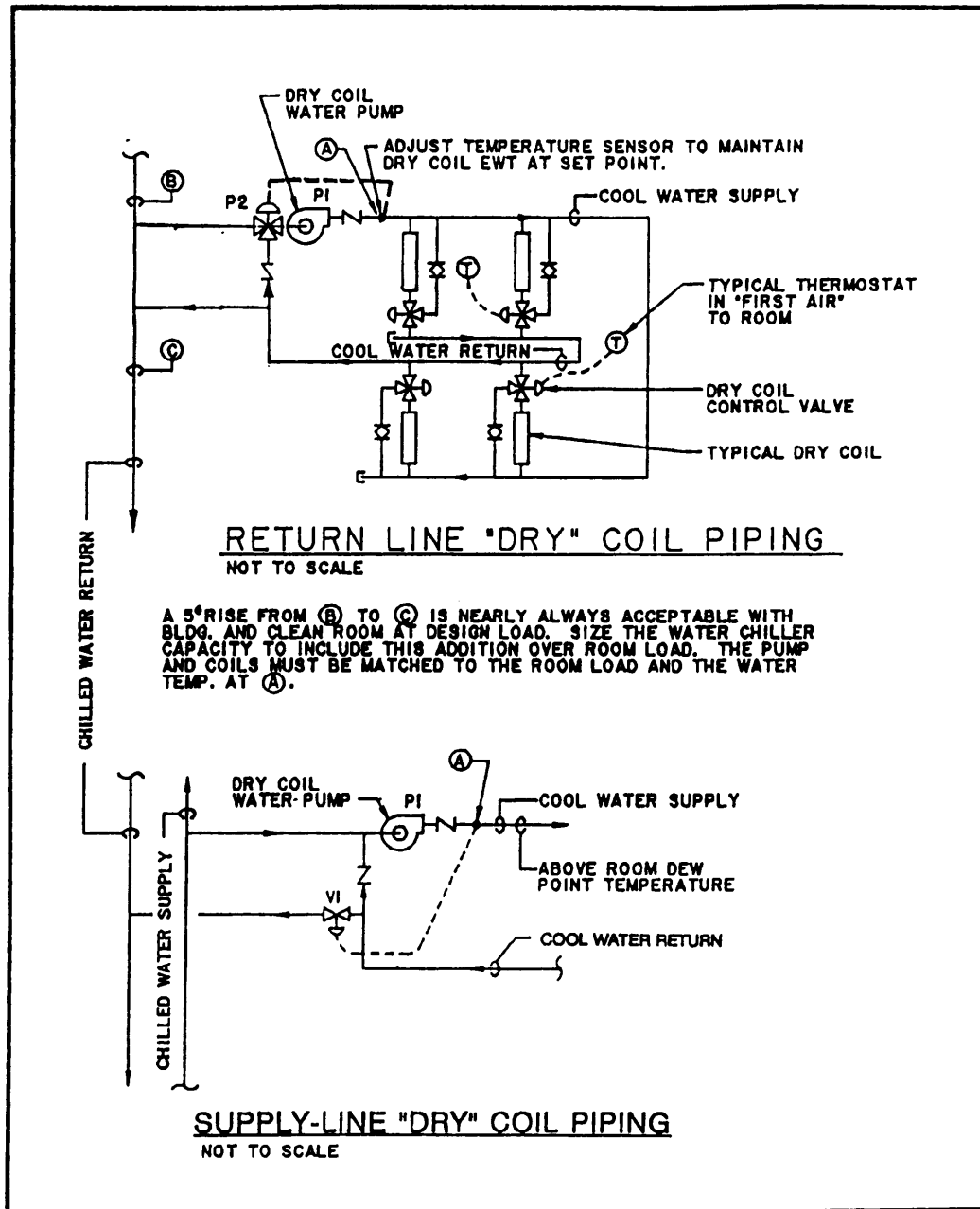

Figure 3  
Dry Coil Piping

MIL-HDBK-1028/5A

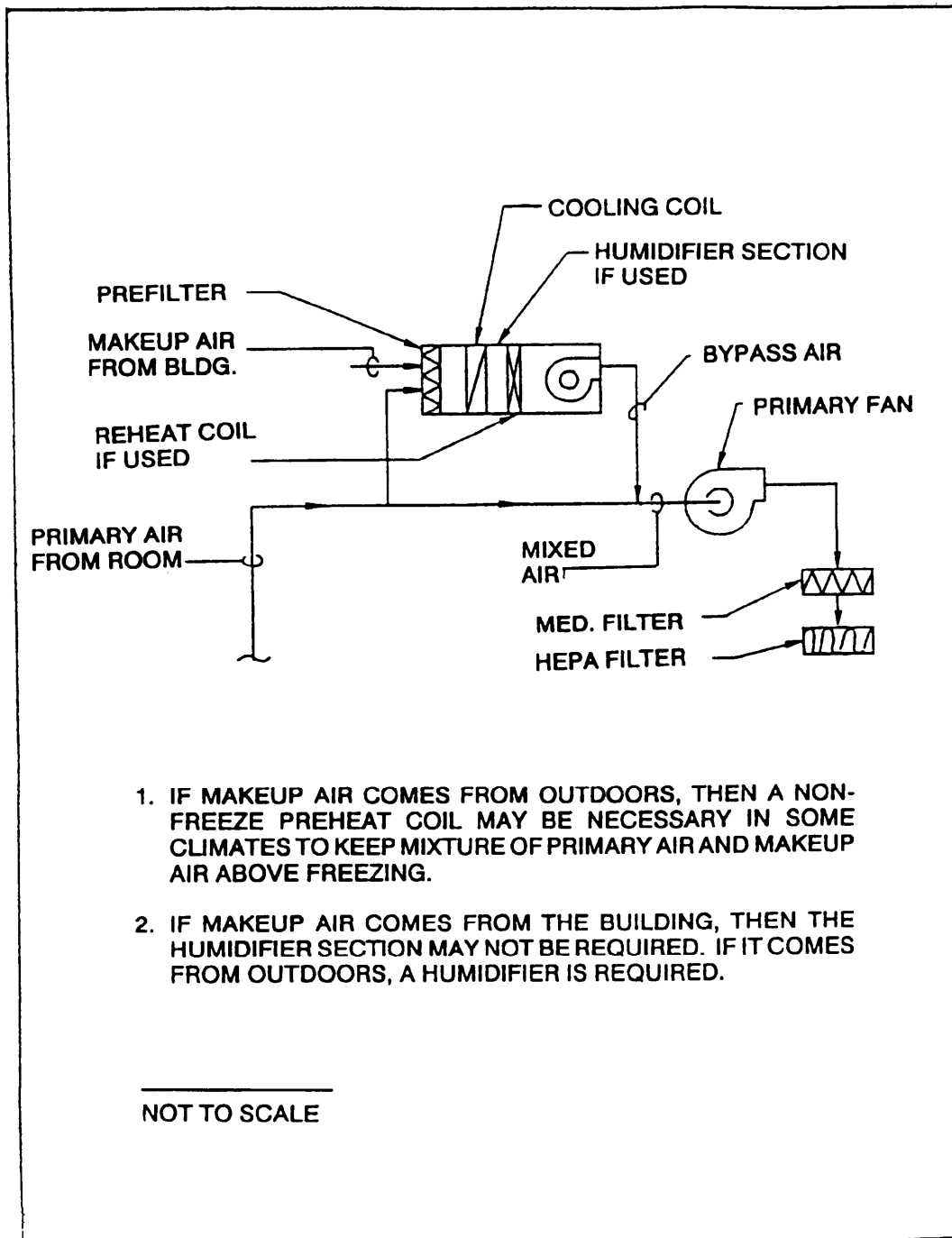

Figure 4  
Primary Airstream With Bypass Air

## MIL-HDBK-1028/5A

## Section 3: PLANNING AND DESIGN CRITERIA

3.1 General Requirements. Proper design and construction can provide a low particle count as well as practical clean room facilities. Good housekeeping practices are essential for the maintenance of a low particle count. Conversion of existing space will probably take precedence over construction of new buildings to provide clean room facilities. Second floors of buildings and mezzanines should not be used if freedom from vibration is required.

3.2 Site Planning. The location of the site and the general siting of buildings shall be in accordance with the activity Master Plan. In layout, the following items must be considered in specifically locating and orienting environmentally controlled facilities and related facilities on the site.

3.2.1 Entrances. Separate entrances for personnel and material and equipment should be maintained when conditions permit.

3.2.2 Parking and Service Areas. Adequate parking areas for staff, operating personnel, and visitors should be conveniently located close to the respective entrances. The parking and service area surfaces should be hard, non-dust-producing, and graded for proper drainage. (Refer to NAVFAC DM-5.04, Pavements.)

3.2.3 Isolation. Avoid areas of high particulate fallout in locating the environmental controlled facilities. The site should not be exposed to:

- a) powerhouse or industrial process stacks;
- b) cement or fertilizer plants;
- c) sand or gravel grading operations;
- d) grain storage areas;
- e) undue noise; and
- f) excessive vehicular traffic.

Consider possible future developments of objectionable conditions. As all clean rooms require fresh air for ventilation and pressurization, thought should be given as to where fresh air may be obtained for minimal particulate content, odors, and chemical contamination.

3.2.4 Soil and Subsoil Conditions. Local ground vibrators should not be overlooked. Transmitted energies from bedrock vibrations of  $10^{-5}$  gravity or ground or air carried vibrations in the range of 0 to 200 cycles per second can disrupt precision measurements.

3.3 Materials and Construction Systems. Buildings shall be of flame-retardant or noncombustible construction in accordance with MIL-HDBK-1001/2, Materials and Building Components, and MIL-HDBK-1002 series, Timber Structures.

## MIL-HDBK-1028/5A

3.3.1 Structural Framing. Structural framing should be designed to minimize vibration transmissions and structural member deflections under varying live loads, such as the movement of maintenance personnel. Excessive vibration and structural deflections could cause failure of filter seals and cracking of internal surfaces of the room. The support of clean room components (ductwork, drop ceiling systems) should be designed with care when the clean room installations are in an existing building.

3.3.2 Wall/Partition Construction. The existence of offsets, ledges, and other horizontal surfaces should be minimized because they allow particles to collect. Rooms of this nature require periodic cleaning to remove accumulated particles. This cleaning can be much more effective if above criteria are followed. In laminar flow rooms, much greater latitude may be taken since the wall surfaces form only a part of the perimeter of the airflow pattern.

3.3.3 Floor Construction. Careful thought should be given to the use of an elevated or false floor such as is used in computer rooms. Elevated floors provide a durable work surface and the flexibility of running services to any point with minimum exposure within the room. Later modification can also be made without exposure of the room to outside contamination. In vertical laminar flow rooms, ensure that

a) elevated floors are used to maintain the parallel airflow pattern through the room, and that

b) perforated dampered floor panels are uniformly located throughout the room in an approximate 30 percent ratio with solid panels to accommodate the airflow.

The preferred finish on floor panels is of the high-pressure phenolic type.

3.3.4 Ceiling Construction. To minimize costs, the ceiling height should be no higher than necessary for the function to be performed in the clean room. The height shall be not less than 8 feet (ft) (2.44 meters (m)) since the ceiling surface and joints may be damaged by activities performed in the room. The minimum height requirement is important in vertical laminar flow rooms because the HEPA filters mounted at ceiling level are easily damaged. Protective screens should be provided wherever necessary to protect the face of HEPA filters. All joints should be sealed to prevent particle induction or loss of room pressurization air.

a) Light fixture housings are to be sealed in a manner which permits relamping from within the room. Fixtures should be uniformly spaced to obtain shadowless lighting at the specified footcandle (lumens per square meter) level. If special lighting is specified, such as yellow or red, light-tight partitioning and proper filtration of light through windows or pass-throughs to adjacent areas will be required.

b) Sprinkler head piping, fire detection, and all other devices which penetrate the ceiling require airtight seals.

3.3.5 Finishes. Wall and ceiling finishes should be designed to minimize generation of particles within the room and compatible with cleanroom



## MIL-HDBK-1028/5A

operations. Finishes should be smooth, easy-to-clean, nonchipping or nonflaking, durable, nonporous and, if required, nonmagnetic, chemically compatible with product, and resistant to storing static charges. The floor finish must meet the same criteria as the walls. This may be accomplished by coatings of epoxy paint or application of a monolithic floor material (such as vinyl), with all joints sealed. Concrete surfaces should be sealed. (Refer to MIL-HDBK-1001/2 for finish criteria of other spaces, such as offices, corridors, toilets.)

3.3.5.1 Floor Finishes. Floors are potentially one of the highest sources of particulate matter in the clean room. They are subjected to shear forces by foot traffic, which continually wear away particles from the surface. Therefore, a surface with long life and high resistance to breakdown should be provided.

a) The floor covering materials should be bonded to the subfloor in strict accordance with the manufacturer's specifications.

b) The minimum acceptable quality floor finish would be vinyl tile or burnished, troweled concrete with surface hardener.

c) An acceptable quality floor finish would be seamless vinyl type sheet material, with coved corners and edges for simplified cleaning. All joints should be flush and tight, and can be sealed by applying heat or vinyl solvent to the edges and allowing them to run together. If the solvent procedure is used to obtain satisfactory results, it is necessary that the joint area be returned to the original flooring hardness. Vinyl type sheets should not be used for slab-on-grade. Sheet material is preferred for conventional clean rooms, but it is not required in laminar flow clean rooms, since dust particles on the floor cannot rise through the laminar air currents.

d) In areas where the floor will be subjected to heavy loading and abrasion by lift trucks and dollies (for instance, in missile overhaul clean rooms), consideration should be given to epoxy, urethane, and polyester coverings. These types of coverings could be necessary because of chemical attack from spillage.

e) Prior to design, a list of all chemicals, acids, and fluids used in clean room work should be provided by the user.

f) Grated floors for downflow clean rooms can be made up of any commercially available grating panels over metal supports. The grating panels should be removable to have access to the prefilter material below. Washable foam has been found satisfactory as prefilter material, and can be laid on wire mesh which in turn can be carried by the grating panel supports.

3.3.5.2 Bases. Where bases are required, coved vinyl or rubber bases or utility moldings should be used. The base material should be compatible with the wall and floor finishes.

3.3.5.3 Wall/Partition Finishes. The wall finish should be durable, smooth, and nonchipping or non-dust-shedding. Horizontal dividing strips or ledges should be avoided. Joints and corners should be kept to a minimum. Coved corners are recommended only for special conditions.

## MIL-HDBK-1028/5A

The walls/partitions should be sealed to prevent contamination through invading air and large losses of air pressure.

a) Some typical acceptable wall/partition finishes are: gypsum wallboard with taped and bedded joints, finished with epoxy paint; concrete masonry units filled to a smooth finish and painted; and plaster with vinyl wall covering, or plastic laminate.

b) Some acceptable basic types of coatings are: acrylic, vinyl, and latex paint.

c) Wood is unacceptable in any cleanroom.

d) Wainscots should be used only when it is an operational requirement, and should be installed with flush horizontal joints between the two partition finishes. The height should be kept to a minimum.

e) When a wainscot is required for impact resistance, the following materials are acceptable: job painted metal, factory prefinished metal, epoxy or polyester glazes, chlorinated rubber enamel, and glazed structural units or glazed tiles with fully grouted mortar joints.

f) For laminar flow clean rooms, no epoxy paints or other special finishes are necessary, since particles from this source do not contribute significantly to the airborne particulate count within the clean room.

3.3.5.4 Ceiling Finishes. Ceilings are not subjected to rough treatment, and the finish does not have to have impact strengths. The finish should not be dust-producing nor collect dust, and should be easy to clean. Acoustic material should be used only in spaces with a high noise level. Some typical acceptable ceiling finishes are:

a) Gypsum board fastened to concealed metal runners, with joints taped and bedded, and finished with an acceptable coating.

b) Suspended ceiling systems with an extruded aluminum inverted "T" grid or a stainless or aluminum-capped steel grid. The lay-in panels and lights should be securely fastened and sealed, to prevent movement or loss of air due to difference in pressure of air above and below the ceiling. The customary installation of sealed lay-in panels prevents removal from below the ceiling, and is a disadvantage when work must be done above the ceiling. Lay-in panels can be either job or factory finished.

c) Acoustical units which are noncombustible and will not shed particles, when acoustical treatment is warranted in accordance with NAVFAC DM-1.03, Architectural Acoustics. For suspended ceiling systems, use concealed metal runners with concealed fastenings and a joint system which will not leak air if the clean room is under positive pressure. Fissured or perforated units should not be used. Acoustical units should not require painting.

3.3.6 Trim and Openings. The number of openings should be kept to a minimum. Doors should be of extruded aluminum or epoxy coated hollow metal. Entryways, doors and pass-throughs should be of correct size to permit personnel and required equipment access to the clean room. Openings should be of the air lock

## MIL-HDBK-1028/5A

type and provide sufficient air seals to allow pressurization of the clean room. Windows should be non-opening, double glazed, sealed, and flush fitting with the cleanroom walls. All frames should be metal and flush fitting.

3.3.7 Central Vacuum Cleaning System. A central vacuum cleaning system should be provided in all classes of clean rooms. Inlets should be flush-mounted in the walls approximately 4 ft (1.22 m) above the floor. They should be spaced so that hose length does not exceed 50 ft (15.25 m) and every spot can be reached within the area.

3.3.8 Support Rooms. Support rooms have usually the same or similar finishes as the clean room, and include change rooms, toilets, washrooms, locker rooms, offices, and lunch areas. Some special considerations are described in paragraphs 3.3.8.1 through 3.3.8.5.

3.3.8.1 Change Rooms. Change rooms should be considered as uncontaminated areas; the air handling system should be designed accordingly. Provisions should be made for metal lockers to hold clean room garments. Benches or foot rails should be provided for use by the employees to put on their shoe covers if they are to be used, or to put on their clean room shoes if separate shoes are to be used. Provide drinking fountain inside the change area. Design room layout to ensure separation between incoming and outgoing employees.

3.3.8.2 Toilets. Toilets should be considered as semicontaminated areas, and the air handling system should be designed accordingly.

3.3.8.3 Washrooms. Washrooms should be considered as semi-contaminated areas, and the air handling system should be designed accordingly. Liquid soap dispensers, foot-or knee-controlled washstands, and filtered air hand dryers should be provided.

3.3.8.4 Locker Rooms. Locker rooms should be considered as uncontrolled areas. The locker room need not be a room, but can be an area where street clothes are stored.

3.3.8.5 Offices or Supervisor Areas. Windows and an intercom system should be installed between the office and the clean room. If the supervisor is required to hold and handle parts while talking to a clean room employee, a glove box type arrangement can be used where the supervisor places his hands into the gloves and into the clean room.

3.3.9 Clean Room Equipment. Materials should be chosen to resist the generation of particles by chipping, flaking, oxidizing, or other deterioration. Normal paint should not be used in areas which are subject to repeated contact with personnel or other objects in the clean room, such as workbench legs. After surfaces have been properly prepared, surfaces which require painting should be painted with an epoxy, polyester, or similar surface coating. Instructions for the preparation and application of these coatings must be followed exactly in order to obtain desired results. Items which can expect to be bumped, knocked, or abraded by personnel should possess a tough, resilient, low particle-generating surface such as stainless steel, a laminated plastic type material, or material of equivalent surface qualities.

## MIL-HDBK-1028/5A

If clean room equipment is not subject to such treatment, the items can be of conventional design. Stainless steel or other metal should not be used for seats. Work tables should be completely covered on the top, sides, and bottom.

3.4 Vibration Isolation. Consideration should be given to isolating the noise and vibration generated by equipment and machinery in accordance with NAVFAC DM-3.10, Noise and Vibration Control of Mechanical Equipment, and NAVFAC Guide Specification NFGS-15200, Noise, Vibration, (and Seismic) Control. Rigid mounting of machines on the supporting structure should be used only for lightweight machines with low unbalanced forces. For critical areas or where special noise problems exist, the machines should be spring-mounted above an inertia pad weighing at least three times as much as the machine, base, and motor. The inertia pad should rest on cork or other resilient material, and, if necessary, be sealed in plastic to contain particles. Whenever possible, structurally separate the floor sections used for personnel movement from floor sections with vibration sensitive equipment.

3.4.1 Isolators. Isolators shall not generate or collect dust particles.

3.4.2 Consideration of Other Facilities. The design should give special attention to ensure that no excessive forces are transmitted to the building structure, nor excessive strain imposed on connecting pipes, ducts, and similar items.

3.5 Acoustics and Noise Control. Noncombustible acoustic treatment of walls and ceilings should be provided in spaces with a high noise level, where sound absorption is required for satisfactory functioning. Sound absorbing materials which fray off particles should not, for any reason, be used in air ducts.

3.5.1 Sound and Impact Noise Isolation. The sound design level for each room in the building should be determined in accordance with the noise criteria of NAVFAC DM-1.03, NAVFAC DM-3.10, and NFGS-15200. The sound design level should be expressed in the maximum permissible sound pressure level for each frequency band. The wall, floor, and ceiling construction should have adequate sound transmission loss and impact noise isolation to accommodate the design level. Openings around pipes and ducts should be sealed tightly to prevent sound leakage between rooms. Barriers should be provided in suspended ceilings above the partitions. In adjacent rooms, cross transmission of noise through the duct system and back-to-back electrical outlets should be avoided.

3.5.2 Background Noise Levels. For most design conditions, background noise limits are established by preferred noise criteria (PNC) curves shown in NAVFAC DM-1.03. For design levels, refer to ASHRAE Handbooks, Fundamentals, Systems Applications and Equipment volumes. All equipment to move the high masses of air should be carefully designed and built to stay within the range of the design levels. Background noise levels should be measured on location. Noise from outdoor equipment should not exceed the normally acceptable background noise level, either outdoors or inside adjacent buildings.

3.6 Installation of Utility Sources. Provisions for concealment of utility sources and future installation of clean work stations should be incorporated in the design without rendering the sources inaccessible for maintenance. Possible

## MIL-HDBK-1028/5A

means of achieving this goal are the use of utility islands at benches, utility peninsulas, utility columns, or plenums. The design should avoid all horizontal ledges on the interior of clean rooms.

Gaskets and seals should be used to ensure that the room pressure will be maintained and no dust will pass into the room where ducts, pipes, conduits, and cables pierce the walls. The seals should be pliable types that can be removed with minimum effort to facilitate remodeling or maintenance, such as silicone rubber or any other comparable sealant. In most instances, the extension of utilities into the clean room should be through utility conduits around the outside of the room.

Proper spacing of utility columns, peninsulas, and plenums, or use of utility duct type floors or basements in the design, will allow future partitioning, installation of future work stations, and other changes at a minimum additional cost. Extensive under-the-ceiling utility services should be avoided. Direct overhead utility connection to work stations and benches should be used if it is the most feasible. The most flexible means of accommodation of utilities is by use of the elevated floor or basement.

3.7 Cleaning Requirements During Construction. Specific provisions for constant, thorough cleanup throughout the construction of a clean facility shall be part of the design. Constant, thorough cleaning and vacuuming of furred wall spaces and all potential sources of dust should be continued until the spaces are closed off. Precautionary measures should be clearly identified in the specifications and made a part of the facility design.

3.7.1 Dust-Producing Construction. Dust-producing construction activities, such as sawing, planing, and sanding, should be accomplished as remote from clean areas as possible. Construction planners should consider the sequence of operations in order to schedule dirty work, such as cutting, plastering, breaking up, and excavating, ahead of other operations. Concrete and mortar surfaces should be sealed if compatible with final finishing material. Never expose HEPA filter to contaminant-producing construction activities.

3.7.2 Air Handling Ducts. Air handling ducts and accessories intended for use downstream of HEPA filter units should be thoroughly cleaned and sealed at the fabrication point prior to shipment. After erection, air handling ducts and equipment shall be vacuumed clean and sealed until used. Access openings in the duct system should remain sealed during construction. Air should not flow unless the HEPA filter units are in place.

3.7.3 Equipment, Furniture, and Utilities. All equipment, furniture, utilities, and material should be thoroughly cleaned prior to installing or placing in the clean room. When the using agency places equipment in the clean room, provisions should be made to clean such items.

### 3.8 Facility Components

3.8.1 Personnel Air Locks. The personnel air lock should be of such a size as to allow material and a number of persons to enter a room at any one time. An interlock door system should be used in such a way that only one door to the air lock is opened at any one time. The room finishes for the air locks will normally be the same as the clean room. No air shall be supplied to the air



## MIL-HDBK-1028/5A

lock, but air should be returned from it. An air lock can be incorporated as an integral unit with an air shower by interlocking the entrance and exit doors of the air shower. A minimum of 50 miles per hour (22.35 meters per second (m/s)) velocities is required for clean air nozzles.

3.8.2 Equipment Air Locks. An equipment air lock should be provided if it becomes necessary to move large equipment in or out of the clean room. The size is determined by the maximum size of equipment which must be moved. The air lock finishes should be similar to the clean room finish except when protective wall treatments are required. A door interlock system shall be used so that only one door to the air lock can be opened at any one time. A nominal amount of air should pass through the air lock to purge contaminants and maintain a positive pressure with regard to the outer area. Air pressure should be the same as for areas with less clean requirements. All items moving through the equipment air lock from an uncontrolled area to the clean room should have rough cleaning operations performed on them prior to entry into the air lock. Final cleaning should be performed in the air lock. Normally, cleaning with vacuum cleaners will be sufficient. For small items, fixtures and products, pass boxes or pass-through windows should be used.

3.8.3 Air Showers. There is a balance between the number of people in the clean room and the contamination level and, therefore, it is necessary to remove particles clinging to clothing before personnel enter the clean room. An air shower can be designed as either a walk-through unit or a stand-in cabinet, depending on the size of the clean room and the number of people to be processed through the air shower. Hand-held air brushes shall be installed within the air shower to increase efficiency. A walk-through air shower can be made integral with the air lock by interlocking the entrance and exit door to the shower, so that only one door can be opened at a time. A stand-in air shower cabinet must be installed within an air lock, and should not accommodate more than 10 persons. The air nozzles and slots should be positioned so that the entire personnel body area is air cleaned. The particulate matter removed should be collected by a vacuum system. Figure 5 shows the recommended velocity time curve for air shower applications. The air impact velocity is measured perpendicular to the surface area of the individual being cleaned. The time shown is minimum, and should be selected at or above the velocity time curve. Velocities greater than those shown on the curve are potentially unsafe for personnel, and should not be used. A minimum of 50 miles per hour (22.35 m/s) is required for clean air nozzles.

3.8.4 Shoe Cleaner. Personnel air locks should be equipped with a shoe cleaner which should have a sole cleaner, side and top brushes, and a vacuum system. The vacuum system can be connected to a janitorial vacuum system. Also a multiple layer tacky or sticky mat should be provided.

3.8.5 Pass Boxes or Pass Windows. Pass boxes, pass windows, or barrel pass-throughs should be provided for the movement of small items, fixtures, and products. Material that resists abrasion and rough wear should be used. Stainless steel or laminated plastic type material, or equivalent type materials, should be used for the countertops of the pass boxes or windows. Edges should be reinforced. The doors should be equipped with interlocks so that both doors cannot be opened at the same time. All framing around openings should be metal to ensure against cracking. Frames should be set flush with the

MIL-HDBK-1028/5A

walls. A telephone or speaking diaphragm shall be provided at each pass box. Pass boxes or windows should not be used for communications.

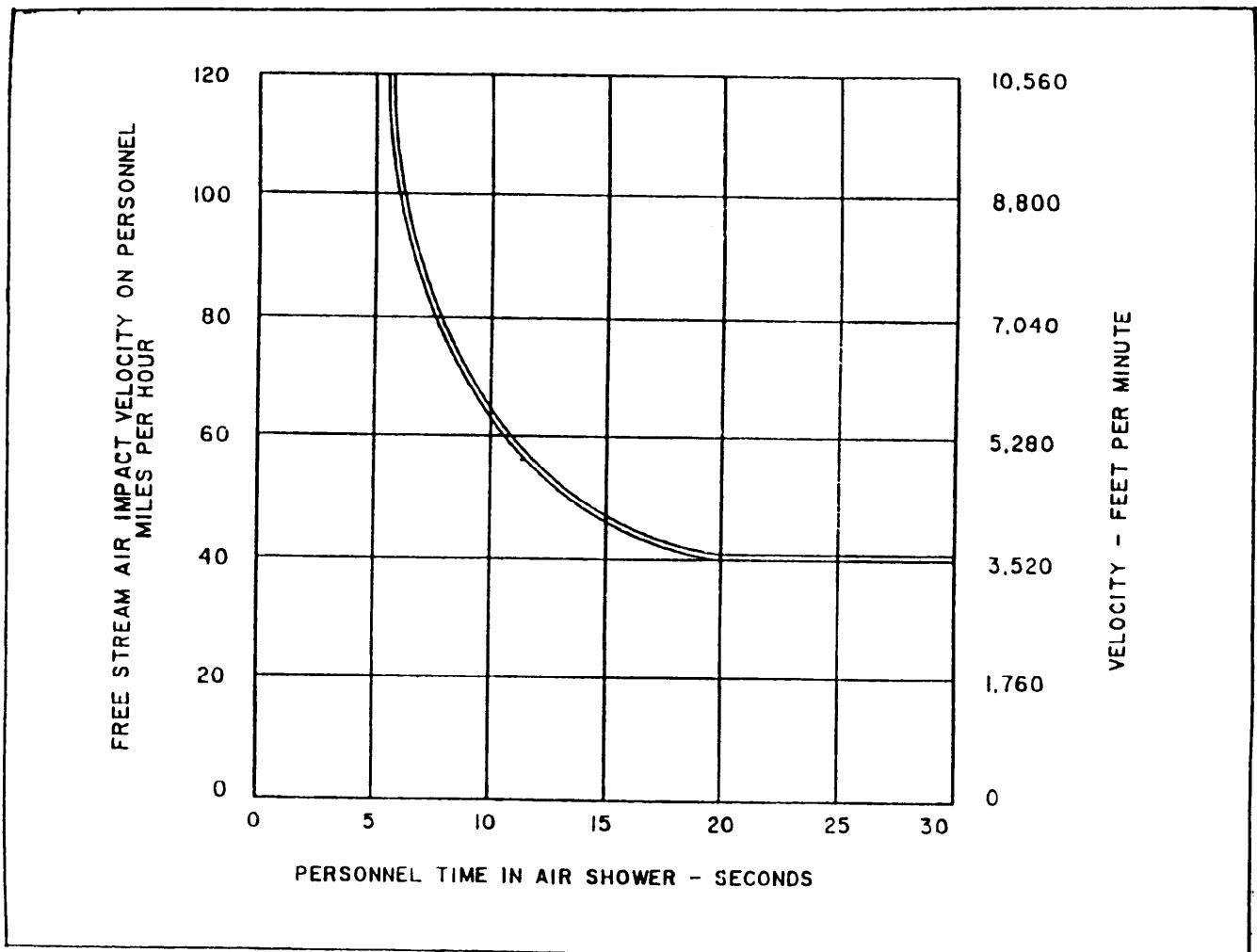

Figure 5  
Air Shower Velocity Versus Personnel Time in Shower

## MIL-HDBK-1028/5A

3.8.6 Observation Windows. Observation windows should have a single pane of glass, set in neoprene gaskets, to ensure against both dust and loss of air pressure. Windows should be flush with interior wall and should have no ledge.

3.9 Color Treatment. The most important consideration in the choice of clean room colors is the prevention of eye fatigue. The causes of eye fatigue must be considered for each area within the clean room to determine a suitable color scheme. The immediate work area (bench tops) should be of a contrasting color to the work so that the outlines of the work are well defined. Instruments, equipment, and similar items surrounding the immediate work area should be of a contrasting color to the immediate work area. Walls within the field of vision should be of the same general tone of color, but not necessarily the same color as that of the equipment. Walls that are not within the field of vision can be light colored. Light colored floors are recommended for their reflectivity.

Colors should become progressively lighter as the eye travels from work to the immediate work area, to machines and equipment, to nearby walls, to other walls/partitions, and to the ceiling. The points of contrast are between the work and the bench tops, and between the bench tops and the surrounding machinery. Light reflection and glare become a hazard because of the need for smooth, hard finishes in clean rooms. Avoid high gloss finishes and location of light fixtures close to walls/partitions or other reflective surfaces.

3.10 Electrical Systems. The electrical services should be concealed under floor or behind walls/partitions, and should be brought into the clean room as near the load center as practicable. Electrical equipment and components which can be located outside of clean rooms and still comply with all applicable codes should not be installed in clean rooms. Overhead entrances, as well as exposed horizontal and vertical runs within the room, should be avoided. The materials and installation should be such that contamination will not be introduced into the room. Electrical components should be installed in recessed enclosures made of stainless steel or anodized aluminum. Access to the components should be restricted by dust-tight and watertight covers.

As a rule, floor-mounted electrical components should be avoided. To prevent malfunctioning of test equipment, power lines of different frequencies should be run in separate raceways and shielded as required. To provide flexibility and convenient connections to equipment that may be moved frequently, trenches or underfloor duct systems should be considered. Interference with airflow or workflow should be held to a minimum. Electrical systems shall be provided in accordance with paragraphs 3.10.1, 3.10.2 and MIL-HDBK-1004/4, Electrical Utilization Systems.

3.10.1 Lighting. Shadowless lighting for the tasks encountered with intensities maintained at the working level shall be in accordance with MIL-HDBK-1190, Facility Planning and Design Guide. When it is impracticable to provide the required intensities with general illumination, supplemental lights can be installed for special operations.

a) The feasibility of utilizing recessed ceiling lights should be considered. The lens and frame should be flush with the ceiling, and sealed to maintain the room pressure gradient and to prevent entrance of contaminants. If



## MIL-HDBK-1028/5A

construction and space are adequate above a suspended ceiling, the feasibility of performing maintenance of fixtures outside the room should be considered.

b) For inverted "T" type suspension ceilings, install fluorescent tubes along the lower surface of the "T" bar support. Install teardrop covers to reduce turbulence. For other type ceilings, lighting fixtures can be surface-mounted on the ceiling if installed in such a manner that they will present a minimum of interference to airflow. The fixture construction should be of nonflaking, non-dust-producing material, and should contain no horizontal ledges that will collect foreign particles.

c) Electrical equipment and installation in air locks and support rooms should be consistent with the permissible degree of contamination and air pressure gradient.

d) Standard commercial fluorescent fixtures can produce electromagnetic interference of sufficient magnitude to adversely affect the operation of sensitive test or electronic equipment. Where such equipment is utilized in a facility, powerline filters should be considered to reduce electromagnetic interference to the tolerable limits.

e) Emergency exit and switchboard lights shall be provided for clean room facilities. The recommended way of providing emergency exit lighting is to wire lamps in selected lighting fixtures to a listed emergency battery pack and its charging system. This approach eliminates a separate emergency fixture.

3.10.2 Grounding. Value of ground resistance shall be in accordance with NAVFAC Guide Specifications NFGS-16402, Interior Wiring Systems, and the applicable requirements of NFPA 70. Some materials, under certain environmental conditions, collect static charges and have a tendency to attract and hold foreign particles, as well as present other operational problems. If the presence of static charges is contemplated, adequate grounding should be provided to alleviate the condition.

### 3.11 Mechanical Systems

3.11.1 Air Conditioning System Requirements. Heating, ventilation, and cooling shall be provided in accordance with NAVFAC DM-3.03.

3.11.1.1 General. Requirements common to all clean rooms are as follows:

a) The air conditioning system shall be designed to maintain 72°F (22.2°C) dry bulb (db)  $\pm 5^\circ\text{F}$  (2.8°C) and 45 percent relative humidity (rh)  $\pm 5$  percent rh, unless work in the room requires other conditions when justified for the process to be performed in the clean room. For comfort conditions, the requirements of NAVFAC DM-3.03 shall be followed. In laminar flow rooms, it is possible to hold much closer temperature control because of the high volume of air being circulated. In this type room, a requirement for  $\pm 1^\circ\text{F}$  (0.6°C) is not uncommon.

Unless process conditions dictate it, do not specify a humidity level of below 40 percent, since special systems may be required to maintain lower humidities. Initial and operating costs of these systems are quite high.

## MIL-HDBK-1028/5A

b) The air distribution system shall be designed to provide a constant air volume flow, and to maintain a clean room positive pressure of 0.05 inch water gauge (0.0124 kilopascal (kPa) (gauge)) above that of any adjacent area. Air lock and showers shall also be maintained at 0.05 inch water gauge (0.0124 kPa (gauge)) above that of any adjacent and less clean area. Constant air volume shall be assured by specifying fans with a steeply rising pressure volume curve and application of variable speed drives. Fans and motors shall be selected that are capable of maintaining design airflow rates with the static pressure drop across all of the filters in the filter system at 2.5 times the initial (design) pressure drop. Gauges should be installed across filters to assure replacement before airflow is inhibited. Give careful consideration to fan motor types as related to energy usage and heat buildup.

c) The supply and return duct system shall be airtight to prevent air leakage into or out of these two system components. Pressure sensitive tape, flange and gasket, or soldered or adhesive sealed joints and seams shall be used. Ducts, diffusers, and other components downstream of the HEPA filters shall be aluminum. Insulation shall be provided with a vapor barrier facing with a permeability rating (perm.) of not less than 0.04 perm. All vapor barrier joints shall be finished to this rating.

d) Conventional clean room conditioning system elements shall be arranged as detailed in Figure 1. The same arrangement should be used for "makeup" air and "bypass" air in laminar flow rooms. Laminar flow rooms should have separate primary fans for air recirculation at the rate required to maintain laminar flow. Primary air fans can have "dry" cooling coils in their inlet or outlet plenums for economically removing the heat of fan motors as well as part of the room sensible heat.

3.11.1.2 Filter Installation. Filter installation mounts shall be accurately detailed to minimize filter change time, to assure proper sealing against leakage, and to provide clearance for adequate inspection and maintenance. Medium efficiency and HEPA air filters shall be placed as close to the entrance into the rooms as practical. Gauges shall be installed across all filter banks, and marked for the filter replacement point static pressure loss. Give special attention to installation of suspended ceiling guide wires as these wires often damage HEPA filters during installation.

3.11.1.3 Operation. The system shall not be operated unless all filter banks are in place and properly sealed.

3.11.1.4 System Components. System components shall be arranged to provide adequate service and maintenance clearance with a minimum of system disassembly.

3.11.1.5 Makeup Air. Makeup air shall be kept to a minimum, consistent with the requirements for personnel, pressurization, and control of room temperature and humidity.

3.11.2 Special Systems and Utilities. Special systems and utilities can be required as a part of the facility design. Requirements for and operating levels needed for special systems shall be furnished by the sponsor command or NAVFACENCOM for incorporation in the facility design.

## MIL-HDBK-1028/5A

3.11.2.1 High Vacuum. Normally, high vacuum for technical use is furnished as collateral equipment by the using agency. Where a central system is required, the capacity, degree of vacuum, and number of stations operating simultaneously shall be as specifically delineated in the project design criteria. Such inlet connectors shall be designed to permit installation in a utility panel or at benches, as required by the design criteria. Except as previously noted, system design shall follow the criteria in NAVFAC DM-3.05, Compressed Air and Vacuum Systems.

3.11.2.2 Special Gases. When required, special gases (such as helium, nitrogen, and oxygen) shall be provided by installation of a piping distribution system connected to a central source. Terminal connection points shall be designed for both a utility panel and a bench location, and shall include a pressure reducing valve, a shutoff valve, and an indicating gauge. Provide point of use filtration.

3.11.2.3 Special Cleaning Solvents. Dispensing and recovery systems for special cleaning solvents (such as halo-carbon compounds) shall be designed according to the flow and cleanliness requirements. Piping, filters, dryers, pumps and compressors, and any special contaminant removal equipment shall be selected to provide the specified solvent cleanliness level and to minimize solvent breakdown (hydrolysis or other decomposition either chemically or thermally). Provide point of use filtration.

3.11.2.4 Exhaust Systems. Exhaust systems for hazardous materials which can be toxic, corrosive, flammable, or radioactive, shall be provided in accordance with MIL-HDBK-1003/17. The systems shall consist of exhaust inlet connection points in the room, contaminant collection equipment, washers, scrubbers, HEPA filters, charcoal filters, or electrostatic filters as applicable, and an exhaust fan or fans. To the maximum extent possible, contaminated portions of the system shall be located outside the occupied area of the building. Exhaust discharge outlets shall be located on the leeward side of all air intakes.

Hazardous-fume-capturing equipment, such as hoods, canopies, or special benches, is normally provided as collateral equipment. Specific volumes of exhaust air shall be determined to allow inclusion in air-conditioning requirements. Exhaust air requirements should be minimized to reduce the energy required to cool the makeup air. Gauges shall be installed across filters of appropriate exhaust systems to assure filter replacement before airflow is inhibited. System operation range shall be marked on gauges. Install gauges where they can be seen during system shut down and turn on procedures. Provide specially designed housings for HEPA exhaust filters which allow for easy bagging of filters.

3.11.2.5 Compressed Air. Design for the compressed air system shall be in accordance with NAVFAC DM-3.05. Where a high degree of cleanliness and dryness is required, proper efficiency filters, dryers, and filter dryers shall be provided at the specified outlets. Where 100 percent oil-free air is required, a carbon or Teflon ring or oil-free rotary liquid displacement type compressor should be provided. Provide point of use filtration.

3.11.2.6 Water Systems. Special water systems to provide special filtering, demineralization, and temperature control of the water for use in sonic cleaners, washdown operations, photographic development work, and similar

## MIL-HDBK-1028/5A

functions, when required, can be provided by a central processing plant or by individual factory assembled units. Care should be exercised to prevent exposed water surfaces from being degraded by particulate contamination in conventional clean rooms.

3.11.2.7 Central Vacuum Cleaning Systems. Central vacuum cleaning systems should be designed to provide approximately four 1.25-inch (31.75-millimeter (mm)) hose outlets in simultaneous use, with a vacuum of 25 inches of water (6.22 kPa) at the end of each hose.

3.12 Fire Protection. Fire protection for clean rooms shall be provided in accordance with MIL-HDBK-1008, Fire Protection for Facilities Engineering, Design, and Construction, and Factory Mutual System, Loss Protection Data, Section 1-56 "Clean Rooms," as applicable to the specific building and to the clean rooms and work stations therein. A summary of the basic guidelines follows.

3.12.1 Construction. Clean rooms, ventilating ducts, and equipment shall be constructed of noncombustible materials as much as practical. Consideration should be given to minimizing the size of clean rooms within practical limits of functions. Separation of clean areas is desirable to minimize damage in the event of fire or related hazards.

3.12.2 Exits. Provide as few entry and exit doors as possible in order to reduce contamination. However, the number, location, and design of exits shall meet the requirements of the NFPA-101/101M, Life Safety Code.

3.12.3 Sprinkler System. Provide automatic sprinkler system where contents or construction is combustible or where hazards of operation warrant.

3.12.4 Gaseous Fire Extinguishing Systems. Carbon dioxide extinguishing systems are not recommended for general clean room use and should be avoided. However, carbon dioxide systems may be used for local application to protect a specific hazard if circumstances warrant. Halon should not be used.

3.12.5 Conventional Clean Rooms. Standard automatic heat or smoke detection systems are suitable for installation in conventional clean rooms.

3.12.6 Laminar Flow Clean Rooms. Consider the following special design feature for laminar flow clean rooms:

a) Place photoelectric type smoke detectors in the return air path after the laminar flow has been broken up by the return grilles and has become turbulent. The number and location of the sensors will depend on the size and arrangement of the room or exhaust system. Smoke detectors shall be interconnected with building fire alarm system.

b) One means of reducing the chance of smoke damage is to provide each laminar flow hood or work station with sprinklers and a manual switch for actuation of a smoke removal system for the hood or work station.

3.12.7 Smoke Control System. In general, smoke control systems should be considered for clean rooms which are susceptible to smoke damage or high contents loss. The smoke control system should be designed to exhaust smoke and

MIL-HDBK-1028/5A

fumes from the clean rooms and to prevent recirculation of the contaminated exhaust air. The smoke control system should be designed to operate automatically upon actuation of any photoelectric type smoke detector in the return air path or manually upon actuation of an emergency switch at the exit.

3.12.8 Control Valves. Provide normally closed valves in all solvent, oxygen, and flammable gas lines to the room that will be de-energized immediately upon actuation of the detection systems. Manually operated control valves must be readily accessible outside the clean rooms.

## MIL-HDBK-1028/5A

## Section 4: ACCEPTANCE TESTS AND CONTAMINATION CURVES

4.1 Acceptance Tests. The number and location of tests vary to suit each individual project, and should be included in the design specifications. The acceptance test can include temperature, relative humidity, positive internal static pressure, rate of airflow, airborne particle count, footcandles of illumination, and operating amperage and voltage.

4.1.1 Airborne Particle Counts

4.1.1.1 Nonlaminar Flow Clean Rooms. For nonlaminar flow clean rooms, specific requirements for clothing (such as head covering, foot covering, smocks, and gloves) should be dictated for all personnel involved, including the testing personnel. For static tests (room at rest), all personnel should be barred from the clean room at least 48 hours, but no more than 168 hours, prior to airborne particle counts.

4.1.1.2 Laminar Flow Clean Rooms. No specific garmenting requirements are necessary for testing personnel in laminar flow clean rooms.

4.1.2 Individual Tests

4.1.2.1 Filters. The test of the filter which is in place should be in accordance with Federal Standard FED-STD-209, Airborne Particulate Cleanliness Classes in Cleanrooms and Clean Zones.

4.1.2.2 Room Pressure Tests. Pressure differential tests shall be accomplished to demonstrate that the pressurization requirement delineated in paragraph 3.11.1.1 b) is being maintained. Measurements can be accomplished using either multicolumn manometers or multiple pressure differential gauges, all mounted on a single panel, to assure observation of all pressure differentials simultaneously. Calibrated electronic sensors with a central display and optional printer may also be used.

4.1.2.3 Airborne Particle Counting. Contaminants shall be measured in accordance with FED-STD-209.

4.1.2.4 Airflow Test. Airflow velocity should be measured through the cross section of the room, perpendicular to airflow.

4.2 Distribution Curves and Cleanliness Requirements

4.2.1 Air Cleanliness Classes. The classification of clean rooms should be limited to the Classes 100; 1,000; 10,000; and 100,000 (Class M3.5; M4.5; M5.5 and M6.5) in accordance with FED-STD-209 whenever possible. Other classifications can be used to define particle count levels where special conditions dictate their use. Such classes will be defined by the intercept point on the 0.5 micron line of Figure 6 with a curve parallel to the established curves. Particle counts are to be taken during normal work activity periods and at locations which will yield the particle count of the air as it approaches the work location (Refer to FED-STD-209).

## MIL-HDBK-1028/5A

4.2.2 Particle Size Distribution Curves. The distribution of airborne particles in Figure 6 illustrates the concentration and size ranges for the various clean room categories. Although not specifically identified in FED-STD-209, Class 10 (Class M2.5) particulate control can be identified by an appropriate parallel line in Figure 6. For particle counts below 10 per cubic foot, a large number of air samplings must be taken to achieve statistically significant data.

4.2.3 Cleanliness Requirements Versus Particle Size Distribution Curves. Figure 7 indicates the relative cleanliness requirements for some products or systems with clearances from 0.00002 to 0.005 inch (0.000508 to 0.127 mm) thin films, and the capacity range of HEPA filter units.

4.2.4 Typical Particle Sizes. The conventional unit of measurement for particles is the micrometer. A micrometer is a millionth of a meter, or approximately 0.00003937 inch. Airborne particles range in size from 0.001 micron to 1,000 micrometers. Most environmentally controlled facilities will control particles 0.5 micrometer and greater. Figure 8 indicates sizes of some typical particles and the range of some cleaning equipment for removing various particle sizes.

4.3 Guidelines for Clean Room Classes. See Table 1 for guidelines for determining classes of clean rooms.



MIL-HDBK-1028/5A

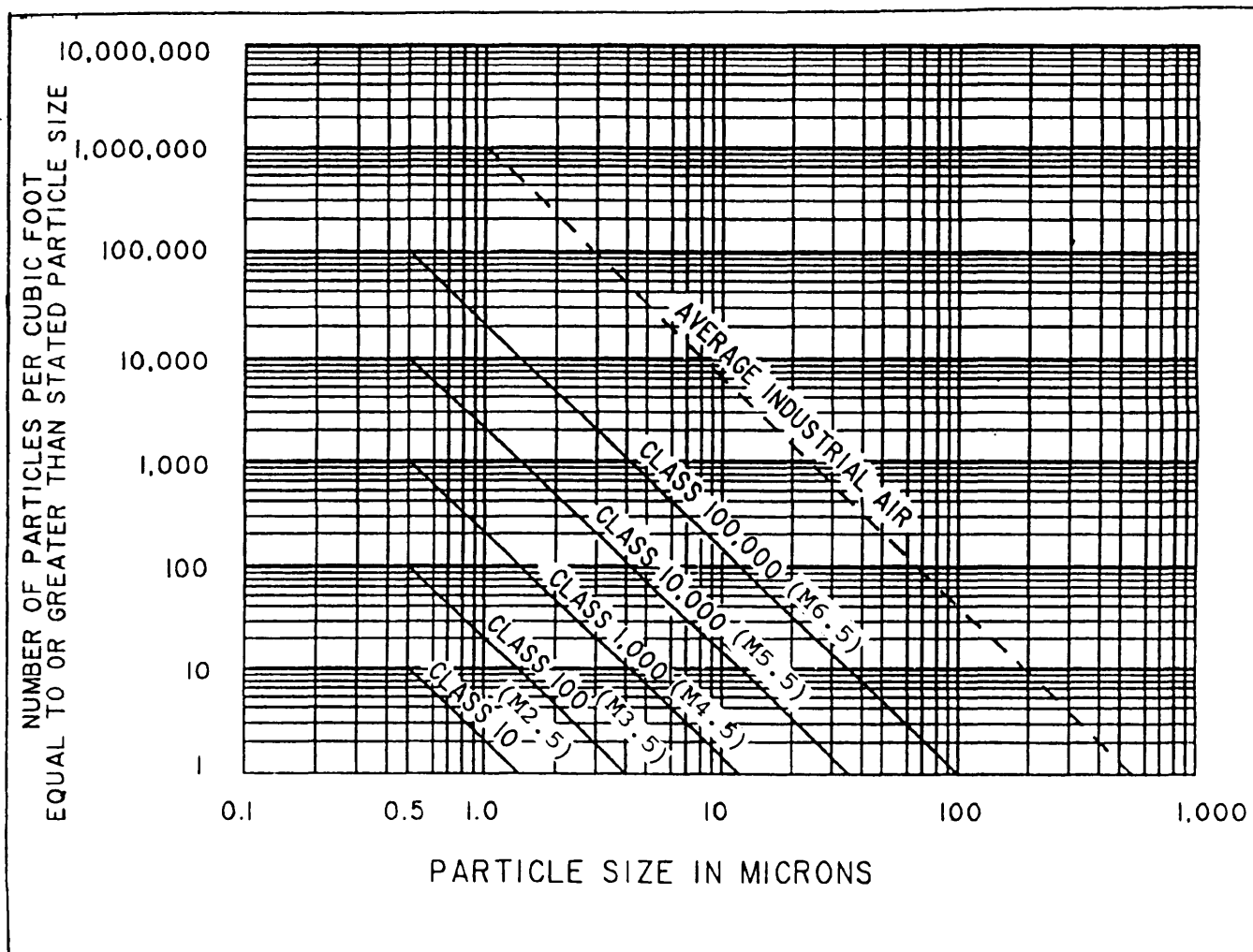

Figure 6  
Particle Size Distribution Curves



MIL-HDBK-1028/5A

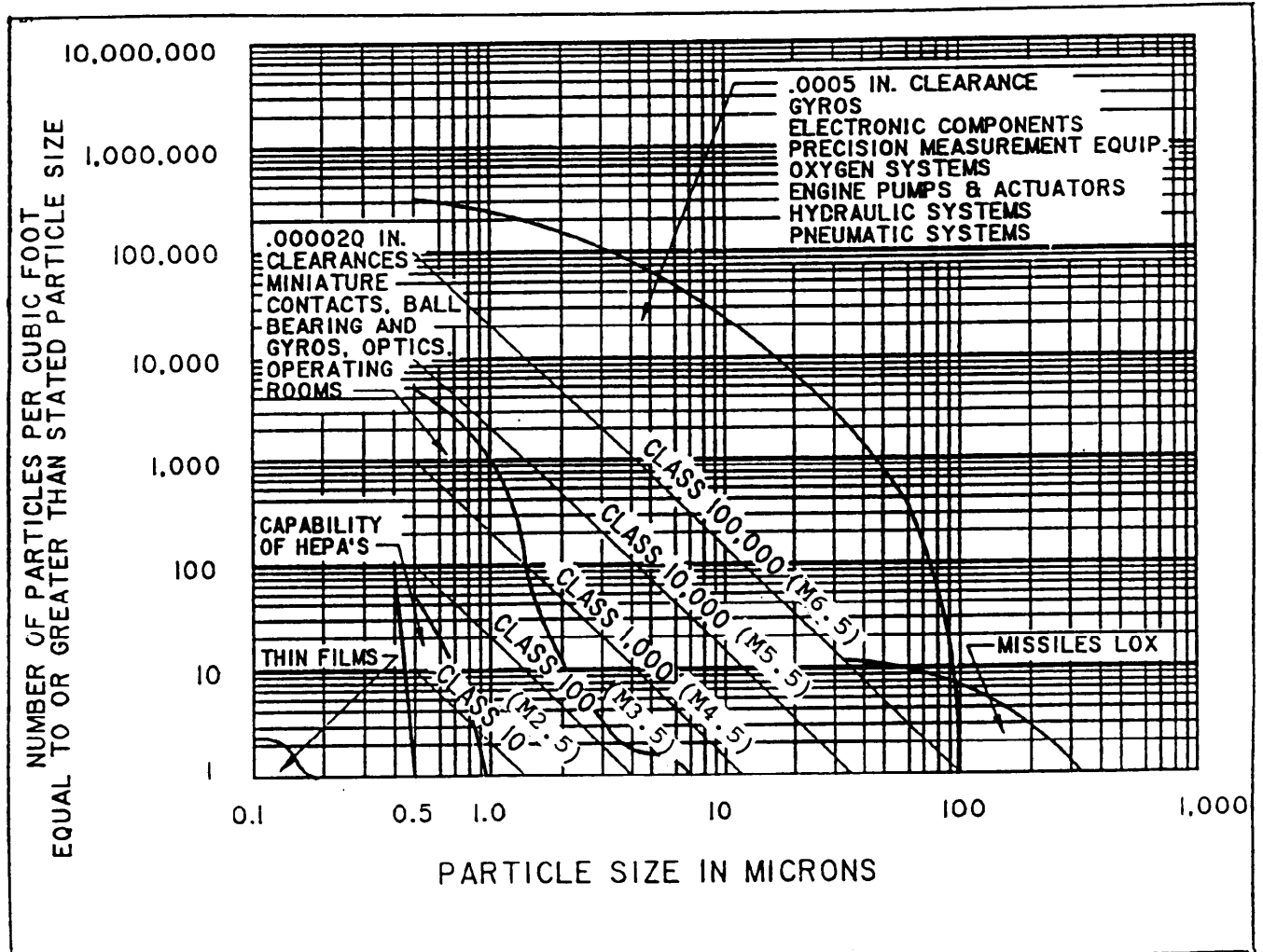

Figure 7  
Cleanliness Requirements Versus Particle Size Distribution Curves

MIL-HDBK-1028/5A

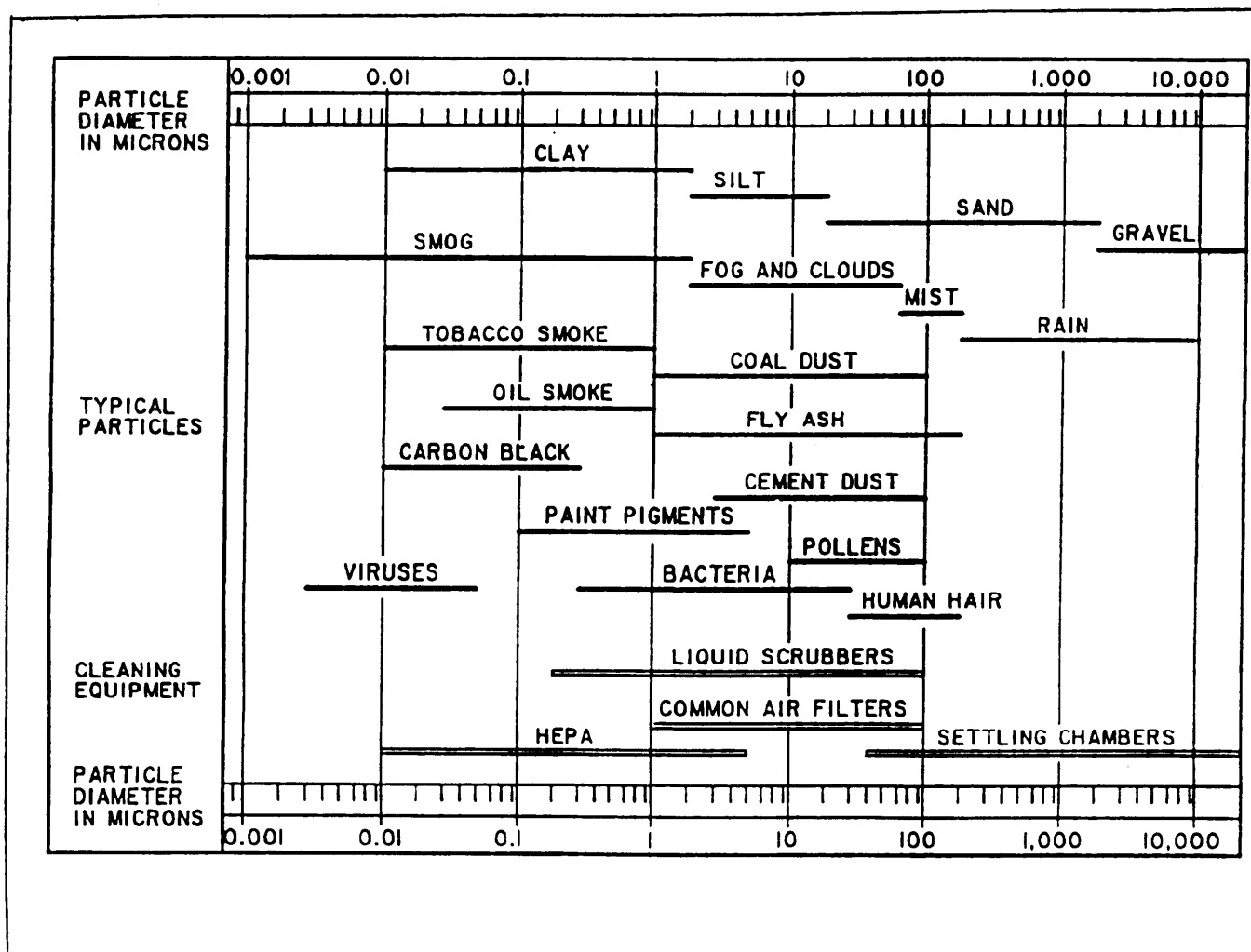

Figure 8  
Typical Particle Size

MIL-HDBK-1028/5A

Table 1. Guidelines for Clean Room Classes.

| TYPE OF FACILITY                                                        | CLASS 100 & 1000<br>(M3.5 & M4.5)                                       | CLASS 10,000<br>(M5.5)                                                                                                                                                                                                                                                                                       | CLASS 100,000<br>(M6.5)                                                                                                                 |
|-------------------------------------------------------------------------|-------------------------------------------------------------------------|--------------------------------------------------------------------------------------------------------------------------------------------------------------------------------------------------------------------------------------------------------------------------------------------------------------|-----------------------------------------------------------------------------------------------------------------------------------------|
| LAMINAR AIR FLOW                                                        | ENTIRE WORK AREA MEETS REQUIREMENTS AT NORMAL WORKING HEIGHT LOCATIONS. | ENTIRE AREA NORMALLY MEETS REQUIREMENTS.                                                                                                                                                                                                                                                                     | ENTIRE AREA MEETS REQUIREMENTS.                                                                                                         |
| VERTICAL FLOW ROOM<br>VERTICAL FLOW CURTAIN UNIT<br>VERTICAL FLOW BENCH |                                                                         |                                                                                                                                                                                                                                                                                                              |                                                                                                                                         |
| CROSSFLOW ROOM<br>TUNNEL ROOM<br>WALL-TO-FLOOR ROOM<br>CROSSFLOW BENCH  | FIRST WORK LOCATIONS MEETS REQUIREMENTS.                                | ENTIRE WORK AREA NORMALLY MEETS REQUIREMENTS IF PARTIAL GENERATION, WORK LOCATIONS AND PERSONNEL ARE REASONABLE CONTROLLED.                                                                                                                                                                                  | ENTIRE AREA NORMALLY MEETS REQUIREMENTS.                                                                                                |
| NONLAMINAR AIR FLOW                                                     | WILL NOT MEET REQUIREMENTS UNDER OPERATING CONDITIONS.                  | IN SOME CASES, CAN BE UPGRADED TO MEET REQUIREMENTS BY PLACING LAMINAR AIR FLOW DEVICES (BENCHES, MODULAR UNITS, TUNNEL ROOMS OR DOWNFLOW CURTAIN UNITS) WITHIN THE ROOM AND CONTINUOUSLY FILTERING THE RECIRCULATED AIR. PERSONNEL AND OPERATING RESTRICTIONS AND JANITORIAL MAINTENANCE ARE ALSO REQUIRED. | WILL USUALLY MEET REQUIREMENTS WITH STRICT OBSERVATION OF RULES GOVERNING PERSONNEL, OPERATIONS, GARMENTING, AND JANITORIAL PROCEDURES. |
| CONVENTIONAL CLEAN ROOM                                                 |                                                                         |                                                                                                                                                                                                                                                                                                              |                                                                                                                                         |

## MIL-HDBK-1028/5A

## Section 5: CLEAN ROOM DESIGNS

5.1 Nonlaminar Flow (Conventional) Clean Rooms. Any clean room in which the air handling system does not create a laminar airflow will be designated as a conventional clean room. The plan view shown in Figure 9 indicates requirements for a conventional clean room area. Special configurations tend to limit the versatility of the clean room, and should be kept to a minimum. The conventional clean room should be limited to approximately 3,000 ft<sup>2</sup> (278.7 m<sup>2</sup>) or 24,000 ft<sup>3</sup> (679.68 m<sup>3</sup>) in size. Ceiling height should be a minimum of 8 ft (2.44 m). If a facility requires a larger area, the area should be divided by partitions. The operational requirements will determine the overall size of the facility. Careful study should be given to the overall layout, to obtain the optimum in traffic flow of personnel, parts flow, record keeping, communications, future expansion, and the provision for clean work stations if required.

5.1.1 Facility Components. (Refer to paragraph 3.8.)

a) Personnel and equipment air locks shall be provided between conventional clean room and less clean areas, such as locker rooms, equipment cleaning rooms, or other uncontrolled areas.

b) Air showers should be provided and incorporated as an integral unit with the air locks.

c) Pass boxes or pass windows shall be provided for the movement of components and pieces of equipment.

d) Observation windows and shoe cleaners shall be provided as required.

5.1.2 Support Areas. Change rooms, toilets, washrooms, locker rooms, offices, and lunch areas shall be provided, as required. (Refer to paragraph 3.3.8.)

5.1.3 Electrical Systems. (Refer to paragraph 3.10.)

5.1.4 Mechanical Systems. (Refer to paragraph 3.11.)

a) Provide sufficient airflow through the HEPA filters to provide a complete clean room air change in 3 to 4 minutes (15 to 20 air changes per hour). Locate the HEPA filters as close to the room distribution outlets as construction will permit.

b) Air distribution shall be through an overhead duct diffuser system. One of the most efficient designs for air entry into the conventional clean room utilizes a large perforated plenum serving as a major portion of the ceiling. Air exit from the clean room (room return air) should be either through the floor or along the perimeter of the wall at floor level and beneath workbenches where possible. Since the floor is generally the most contaminated section of the clean room (particularly the floor area in the proximity of the employee as he stands, sits, or manipulates during his work operations), much of the contamination in the room can be reduced by locating exhaust ducts in this area.

## MIL-HDBK-1028/5A

c) Select diffusion equipment to produce an airflow velocity in the occupied zone 3 to 5 ft (0.914 to 1.52 m) level which shall be not less than 35 feet per minute (fpm) (0.178 m/s) nor greater than 55 fpm (0.279 m/s).

d) Distribution pattern shall not interfere with the airflow requirements of any laminar flow work stations, bench, or hoods within the room.

5.2 Horizontal Laminar Flow Clean Rooms. Figure 10 illustrates the primary airpaths for typical horizontal laminar flow clean room. For each type of airflow, treated makeup air is mixed with return air as required to maintain temperature, humidity, and pressure requirements. "Wall-to-wall" airflow is the most expensive type of horizontal laminar flow clean room to construct and operate; "wall-to-ceiling" airflow is next; and the least expensive airflow is "wall-to-open-end" (tunnel).

### 5.2.1 Advantages

a) The advantages of the horizontal flow clean room in terms of cleanliness are:

(1) The cleanliness level is not entirely dependent upon the operation or activity within the room.

(2) The clean room has self-cleanup capability and quick cleanliness recovery rate.

(3) It is necessary to operate the air handling units only during working hours.

b) The horizontal flow clean room is a departure from the vertical flow clean room (which has the lowest contamination level of all clean room designs) for the sake of economics. The room has a low contamination level, varying from super clean at the air entrance to a lesser degree of cleanliness at the air exit. The cost of achieving and maintaining these low contamination levels is generally less expensive by using a horizontal flow clean room than a conventional clean room; however, room layout is important.

### 5.2.2 Design

a) Personnel air showers, air locks, shoe cleaners, and most other support rooms are not required. Special clothing would not normally be required but is valuable from a psychological standpoint.

b) Sophisticated construction materials and finishes required in conventional clean rooms are normally not necessary, since particulate matter from this source does not accumulate in the room.

c) To ensure the laminar airflow through the entire clean room area, the air supply wall should consist wholly of HEPA filter units. The length of the laminar airflow should not exceed 120 ft (36.58 m). The HEPA filter bank should be protected from damage by appropriate screens or grilles.

## MIL-HDBK-1028/5A

d) The air handling system should be as compact as possible; however, compact designs can create a serious noise problem. (Refer to paragraph 3.5 for noise control.)

e) Electrical systems are stipulated in paragraph 3.10. Light fixtures should be mounted so as not to restrict or cause objectionable turbulence of the airflow or interfere with maintenance of the air filter. Light fixtures should be flush-mounted. However, if surface-mounted fixtures are used, they shall be installed in continuous rows parallel to the direction of the airflow.

f) Mechanical systems are stipulated in paragraph 3.11. Airflow, wall-to-wall, shall be at a velocity of  $90 \pm 20$  fpm ( $(0.457 \pm 0.102$  m/s). The HEPA filter system shall conform to Military Specification MIL-F-51068, Filter, Particulate, High-Efficiency, Fire Resistant, which specifies filters with a minimum efficiency of 99.97 percent, as determined by the homogeneous dioctyl phthalate (DOP) performance test method at airflows of 100 percent and 20 percent of the rated flow capacity of the filter. The DOP method is given in Military Standard MIL-STD-282, Filter Units, Protective Clothing, Gas-Mask Components and Related Products: Performance-Test Methods.

g) For acceptance tests, refer to paragraph 4.1.

5.3 Downflow Clean Rooms (Vertical Laminar Flow). Figure 11 illustrates primary airpaths for typical vertical laminar flow clean rooms. For both types of airflow, treated makeup air is mixed with return air as required to maintain temperature, humidity, and pressure requirements. Ceiling-to-floor airflow is the most expensive type of vertical laminar flow clean room to construct and operate, followed by ceiling-to-wall airflow. Figure 12 illustrates a vertical flow room with a basement containing most of the mechanical equipment, utilities, and process support equipment, such as vacuum pumps and exhaust ducts. This design is only practical in new buildings, where the compact arrangement of support equipment helps offset the room cost. Figure 13 illustrates a vertical flow ceiling unit which can be used as the air handling part of a vertical clean work station or can be used in multiples for an entire clean room. Figure 14 illustrates a vertical laminar flow clean room utilizing multiple fan plenum systems, with each plenum serving several HEPA filter units.

5.3.1 Advantages. The advantages of the downflow clean room are:

a) It has the lowest contamination level of all the clean room designs. The vertical flow clean room produces the shortest distance from contaminant generation to contaminant removal from the clean room. The entire room approaches the cleanliness level of the HEPA filter units.

b) Complete isolation of every operation is provided by streamlines of laminar flow air.

c) The clean room has self-cleanup capability and quick cleanliness recovery.

d) It is unnecessary to perform major cleanup everyday.

MIL-HDBK-1028/5A

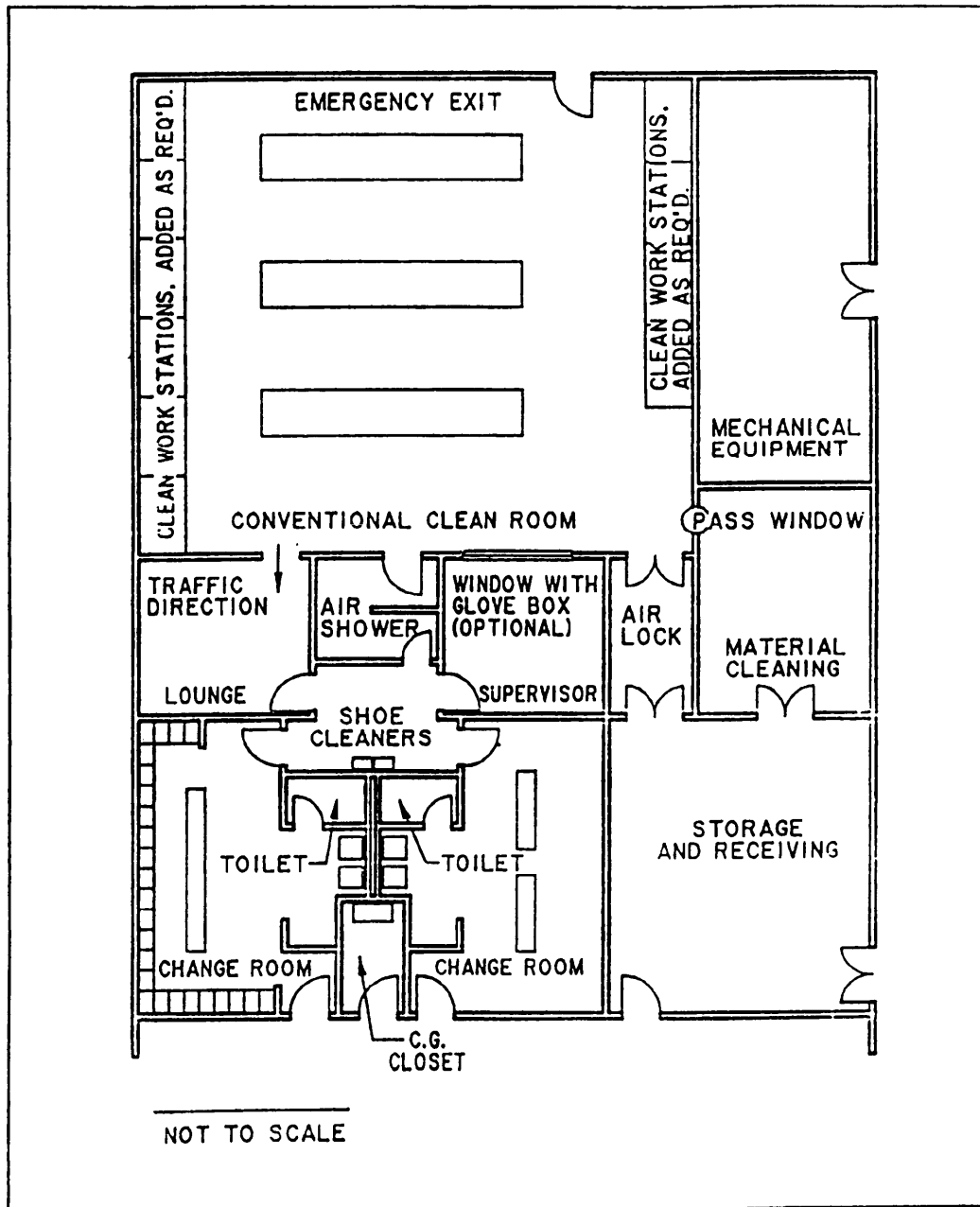

Figure 9  
Plan View of a Conventional Clean Room Area  
With Clean Work Stations

MIL-HDBK-1028/5A

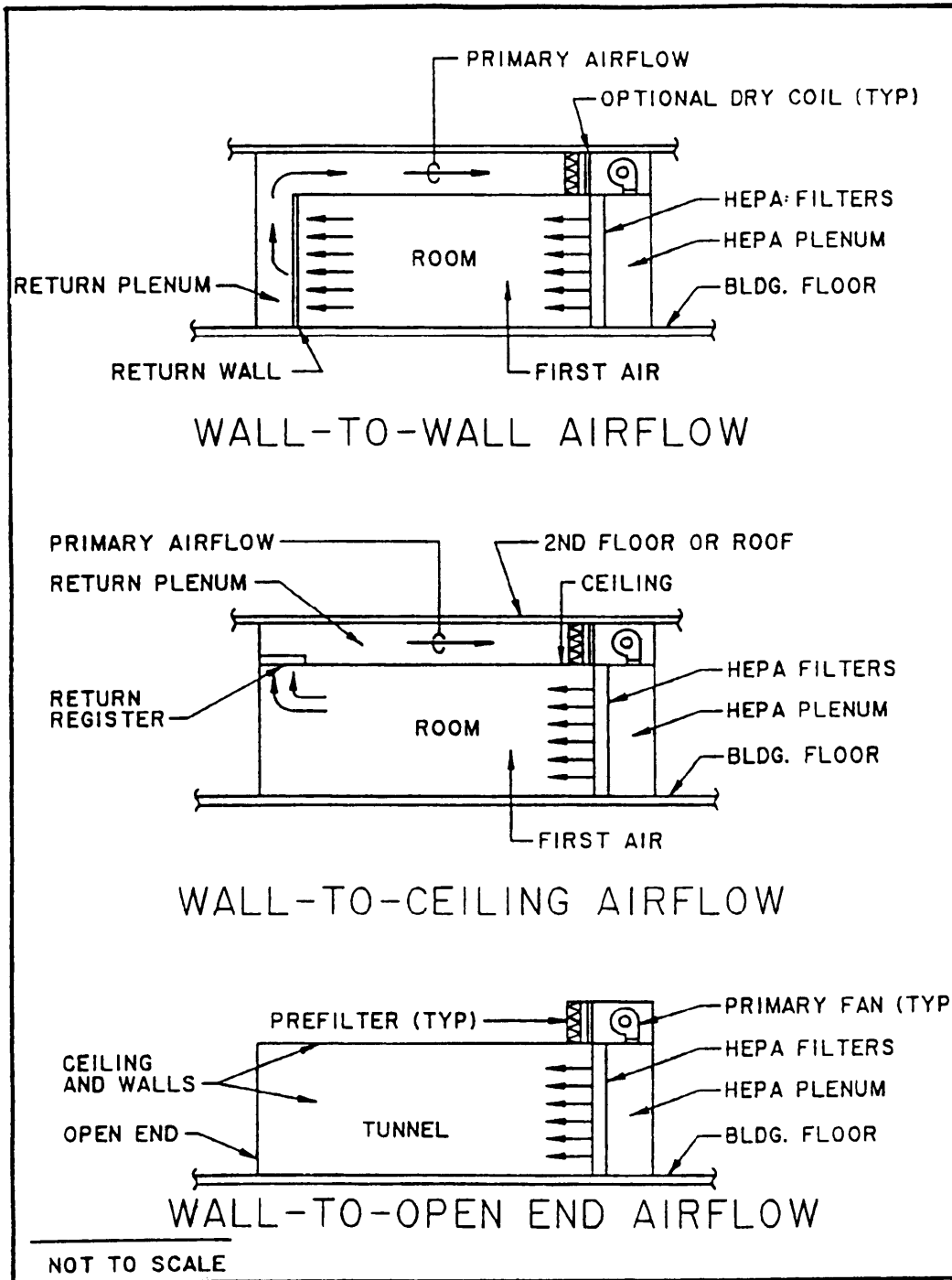

Figure 10  
Horizontal Laminar Airflow Paths



MIL-HDBK-1028/5A

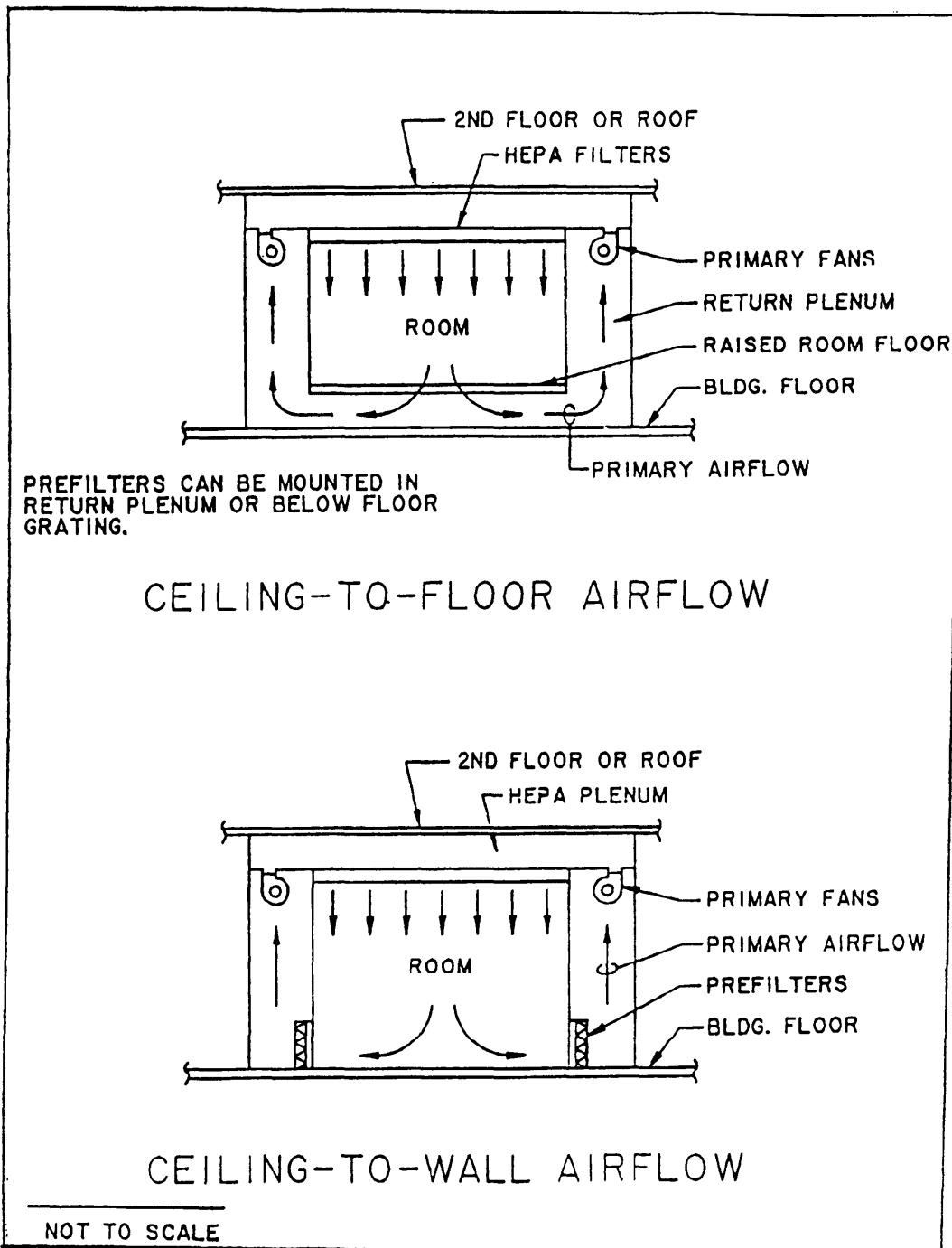

Figure 11  
Vertical Laminar Airflow Paths

MIL-HDBK-1028/5A

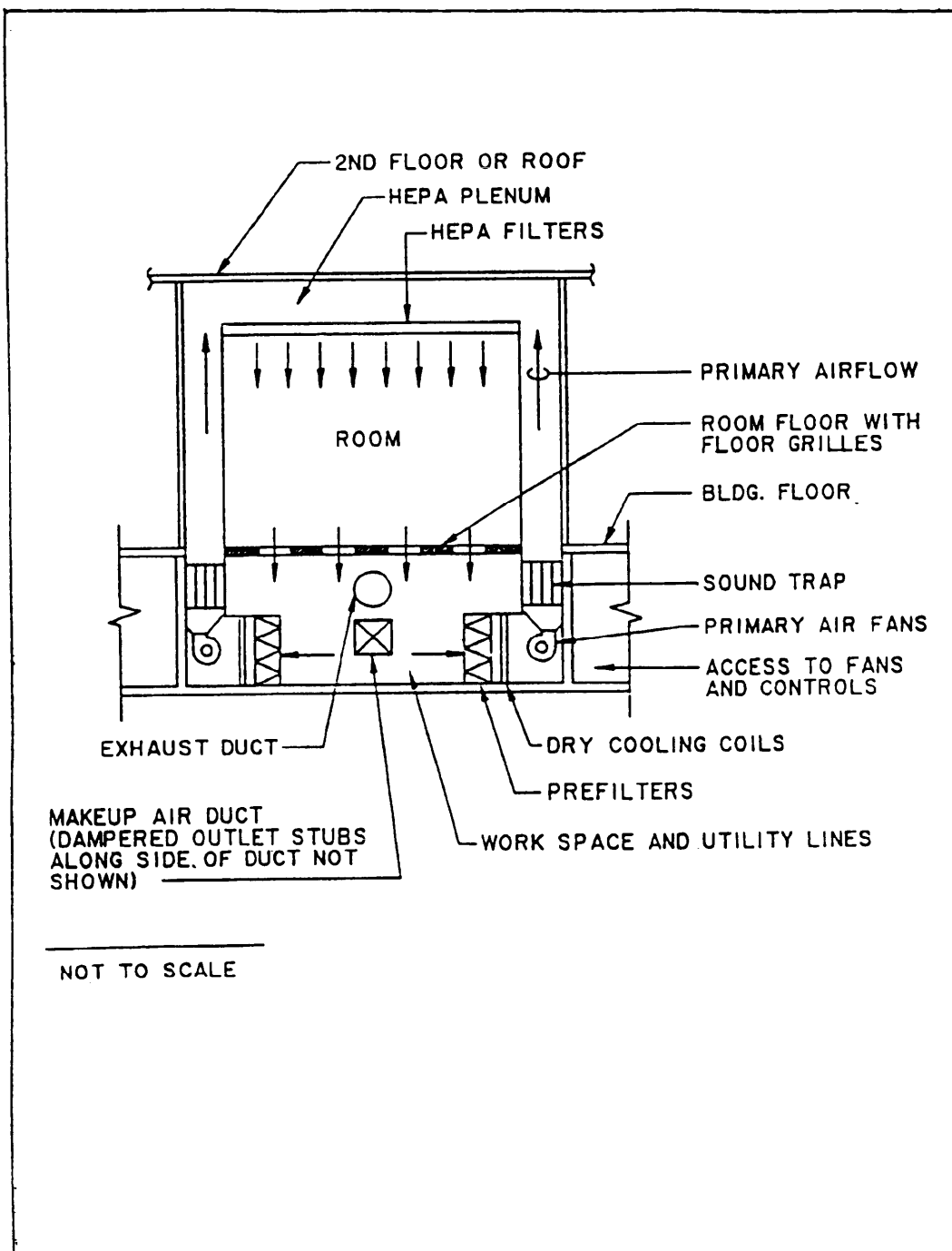

Figure 12  
Vertical Flow Room with Basement

MIL-HDBK-1028/5A

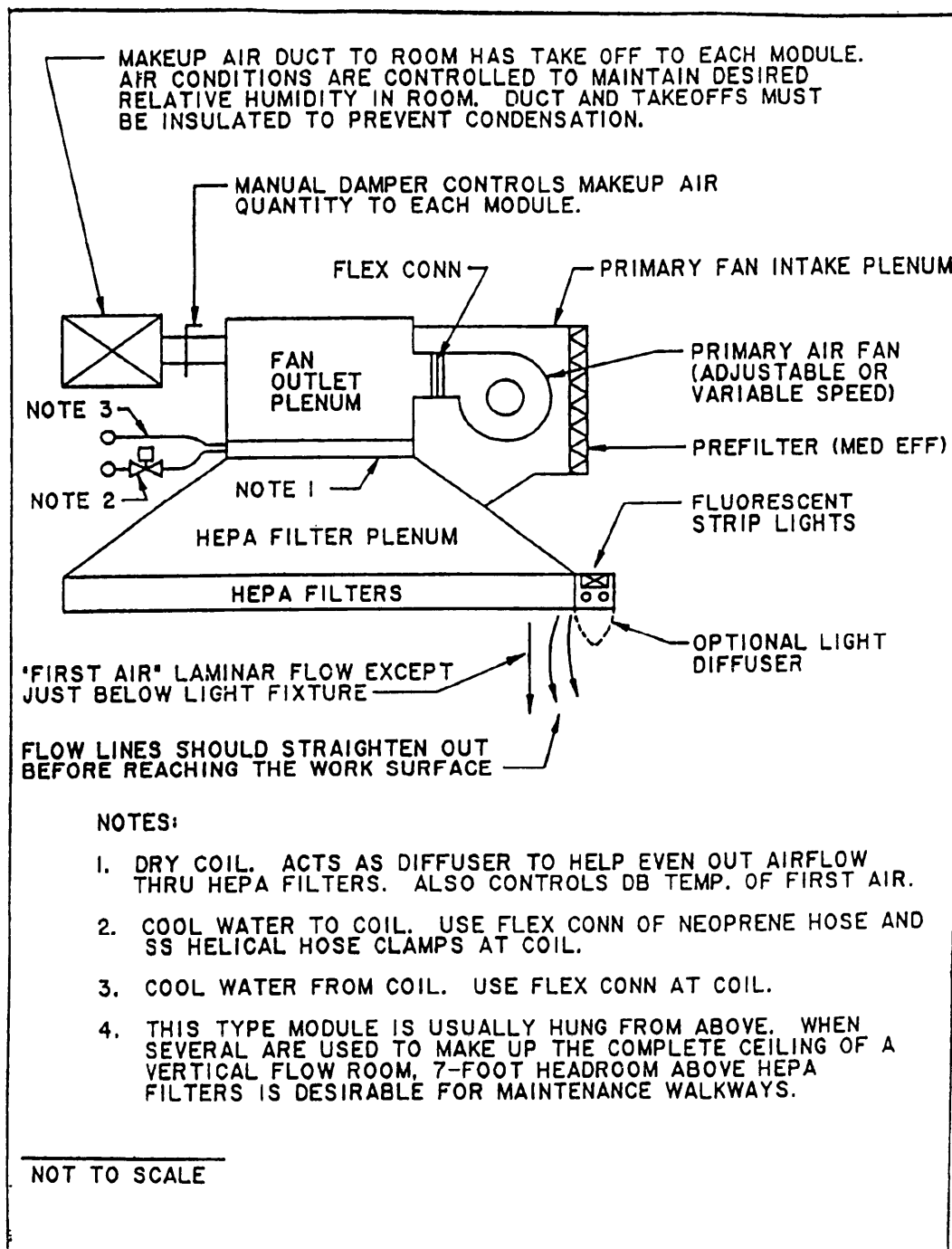

Figure 13  
Vertical Flow Ceiling Unit

MIL-HDBK-1028/5A

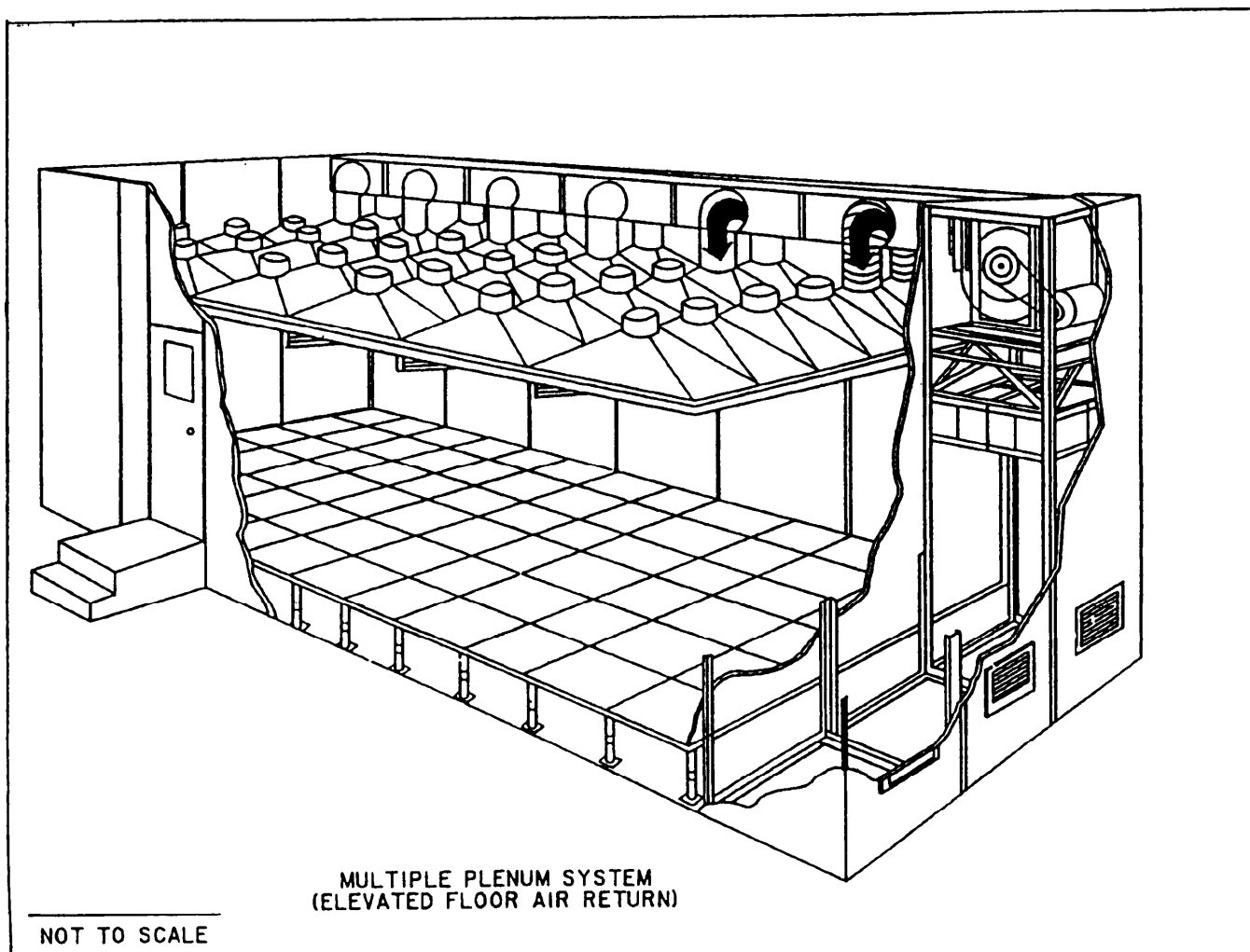

Figure 14  
Vertical Laminar Flow

## MIL-HDBK-1028/5A

5.3.2 Design

- a) Personnel air showers are not required, and the room is operated only during working hours, because it has a rapid recovery rate.
- b) Special clothing would normally not be required; however, knee-length smocks and caps would be useful for psychological reasons to adjust employee attitude to the clean room rules.
- c) The ceiling system consists of HEPA filter units, lighting, and sprinkler heads, which give the effect of a continuous air diffuser for laminar flow of air. Protective grilles, perforated sheets, or screens made of corrosion-resistant, nonshedding material with a minimum of 50 percent free area should be provided on the room side to prevent accidental damage to the filter media. The lights should have a narrow profile.
- d) Requirements for additional space above the ceiling and beneath the floor necessitate careful consideration of the building height. Space above the ceiling is required for items such as air supply ducts or plenum air diffusing space, piping, bracing, catwalks, and access space. Plenum chambers should be designed to ensure uniform airflow, and should be of fireproof construction. The acoustical properties should be in accordance with paragraph 3.5.
- e) Aisles between equipment should not exceed 5 ft (1.52 m), except when larger aisles are needed for access to equipment. Individual items of equipment should be separated a minimum of 4 inches (102 mm). There should be no obstruction between the work area and the ceiling.
- f) Depending on the amount of dirt to be removed, a central vacuum cleaning system, or a specially designed portable vacuum, should be employed.
- g) The construction materials should have low shedding characteristics and should be easily cleaned.
- h) Electrical systems are stipulated in paragraph 3.10. To provide adequate general illumination, special consideration will be required. Probably more supplemental lights, for delicate operations, would be required than ordinarily, since practically the entire ceiling of a vertical laminar flow room is occupied by air filters. One method to consider is utilizing continuous strips of fluorescent lights. Fixtures should be mounted so as not to restrict or cause objectionable turbulence of the airflow or interfere with maintenance of the air filter.
- i) Mechanical systems are stipulated in paragraph 3.11. Airflow, ceiling-to-floor, shall be at a velocity of  $90 \pm 20$  fpm ( $0.457 \pm 0.102$  m/s). HEPA filter banks and perforated metal panels shall extend wall-to-wall and be suspended by minimum width supports to minimize airflow turbulence. The HEPA filter system shall conform to requirements stipulated in paragraph 5.2.2.f.
- j) Refer to paragraph 4.1 for acceptance tests.

5.4 Prefabricated Clean Rooms. There are many types of prefabricated units in existence, manufactured from a variety of materials and in a variety of designs. Among the advantages in this approach, for providing a controlled

## MIL-HDBK-1028/5A

environment, are: lowered engineering costs; flexibility in structure modification, flexibility in structure size; and interchangeability of windows, panels, and other such components.

5.4.1 Specifications. Before including items which would considerably alter designs of prefabricated rooms of an individual manufacturer, consider the specification. Many of the prefabricated clean room manufacturers have had considerable experience in the field, and could contribute useful information to the clean room design specifications. When bids are requested for prefabricated structures, it is recommended that prefabricated room information include, but not be limited to, the following items:

- a) Height, width, and length of room;
- b) Wall construction, including insulation;
- c) Interior and exterior wall finishes;
- d) Coved or uncoved corners for wall joints, floor-to-wall, and wall-to-ceiling;
- e) Floor material and ceiling material and finish;
- f) Entrance door material, size, and location;
- g) Entrance door hardware, such as interlock and panic;
- h) Location, size, and quantity of windows;
- i) Location and size of air shower or air lock;
- j) Columns that are to be boxed and the material to be used;
- k) Pass-through boxes in quantity, size, and location;
- l) Types and location of lighting fixtures;
- m) Lighting intensities in footcandles (lumens per square meter) at bench height;
- n) Temperature, humidity, ventilation, airflow, and air conditioning requirements;
- o) Types of filtration and required range of contamination levels;
- p) Location of air entry and exhaust;
- q) Required air pressure gradients;
- r) Central vacuum cleaning (location of ports and size of ports);
- s) Location and size of water lines and other utilities;
- t) Compressed air outlets location and size, if required;

## MIL-HDBK-1028/5A

- u) Location of intercommunication system, if required;
- v) Number, location, and size of electrical power outlets; and
- w) Power-line filters, if required.

#### 5.4.2 Design Requirements

- a) For clean room design criteria, refer to Section 3.
- b) For conventional clean rooms, refer to paragraph 5.1.
- c) For laminar flow clean rooms, refer to paragraphs 5.2 and 5.3.

#### 5.4.3 Acceptance Tests. For acceptance tests, refer to paragraph 4.1.

5.5 Missile Overhaul and Cleaning Facilities. The conventional clean room provides compatible environmental design and operational standards for missile overhaul and cleaning facilities. These facilities generally need high bay areas to provide for large bulk pieces. The disciplines and techniques currently employed in clean rooms are pertinent to missile overhaul and cleaning facilities.

#### 5.5.1 Type Clean Room Required

a) The conventional clean room is compatible with most cleaning operations with respect to environmental conditions. To a large degree, the requirements depend upon the size of the parts to be cleaned. Other factors involved include chemical attack problems, extra utilities requirements, the effect of the weight of large objects on the floor and fixtures, and the necessity for a large exhaust system. Various operations, such as hydraulic and pneumatic work, should be placed in separate clean rooms.

b) Although the basic cleaning and overhaul activities of operational missiles and other aerospace vehicles are compatible with conventional clean room design, the advent of sophisticated electronic and hydraulic systems makes the use of laminar flow clean rooms necessary. Repair of inertial navigation systems, electronic computer controlled weapons delivery systems, and precise hydraulic servo control systems require the particulate control achieved only by horizontal or vertical laminar flow facilities. Portable clean air units should be considered for local contamination control.

#### 5.5.2 Material Handling

a) Missile overhaul and cleaning facilities employ a large amount of material handling equipment from overhead cranes and hoists to tote boxes. Extreme care should be taken to shield particle producing assemblies of the handling equipment from contaminating the work space.

b) In a facility where large pieces are being handled, transfer of contamination from personnel and tools to the workpiece is as large a factor in contaminating the workpiece as is poor environmental control.

## MIL-HDBK-1028/5A

c) When overhead weight-handling equipment is required, it shall be in accordance with criteria in NAVFAC DM-38.01, Weight-Handling Equipment.

5.6 Upgrading of Existing Clean Rooms. Many existing facilities are inadequate and have severe operating restrictions. Some of the limitations are: air handling equipment must be run continuously, cleanup or janitorial services must be continual, costly clean room garments must be worn and maintained, time is lost getting in and out of the clean room area, and contamination monitoring is constant and costly. The upgrading will not eliminate all of these limitations, but will add flexibility to the facility.

5.6.1 Clean Work Stations. Existing clean rooms can be upgraded by installing clean work stations. The recirculation and filtration of room air through HEPA filter units dilutes the contamination and, dependent on the number of work stations, can approach the cleanliness level of the clean work station. Clean work stations can be arranged in various sizes and configurations to handle many different product lines and functions. Figure 9 shows a schematic floor plan of a utilizing installation's clean work stations.

a) The clean work stations can be attached to the central air handling system, utilities, and cleaning system, or can be self-contained with fan, filters, coils, and controls as required. Self-contained units pick up air from the room. The clean work stations can be constructed and installed or commercially purchased and installed. Some typical clean work stations are:

- (1) Built-in Clean Work Station (see Figure 15);
- (2) Horizontal Laminar Flow Bench (see Figure 16);
- (3) Vertical Laminar Flow Bench (see Figure 17); and
- (4) Laminar Flow Exhaust Hood (see Figure 18).

b) Materials used in the construction shall be smooth, durable, and not easily susceptible to flaking or wear by abrasive action. Glass, plexiglass, laminated plastics on plywood, stainless steel, or equivalent materials can be used. Laminated plastics on plywood should be listed by Underwriters Laboratories, Inc. (UL) UL 586, Standard for Test Performance of High Efficiency, Particulate, Air Filter Units, as having a flame spread rate of 25 or less and a smoke development of 200 or less when tested in accordance with ASTM E84, Standard Test for Surface Burning Characteristics of Building Materials.

c) Clean work stations or benches can be installed with access panels either in front or at the back. Arrange clean work stations along the outer perimeter wall of the clean room. Ducts and utility lines should be on the outside of the clean room. These arrangements should make it possible to service the work stations while the clean room remains in operation.

d) Connections should be made between the work stations and utility housings in a manner to preclude cracks, crevices, ledges, or other dust catchers.



## MIL-HDBK-1028/5A

- e) Random air currents inside the clean work stations should be eliminated. The units should be designed to produce laminar flow air patterns in the work area.
- f) The sealing of the filters can be critical, so check specifications carefully to ensure against leaks.
- g) Consider such features as noiseless, vibration-free operations; accessibility of filters for cleaning and changing; savings in floor space; variable speed blower; operating cost; and elimination of corners at floor level.
- h) The size or shape of the work station varies, depending on the type of work being performed. The flow of air can be horizontal or vertical, as long as the flow is essentially laminar and achieves the cleanliness level desired. Horizontal laminar flow benches shall not be used with hazardous materials.
- i) Modular units are basically clean work stations with support equipment needed to operate the work station. They can be arranged in various configurations. Increased clean room flexibility can be achieved by using modular units. The modular units should be interchangeable, and should be based on a standard module size.
- j) The aisle behind work stations should be 5 ft (1.52 m) in width unless more space is required.
- k) The entire wall above the clean work station can be a bank of filters and the floor can be a grille through which the air is exhausted.
- l) A bank of filters can be installed over the work area and the air exhausted through the bench top. This method can be used for toxic cleaning operations. Regardless of toxicity, the vapor itself is a room contaminant, and should be exhausted out of the room. A similar unit utilizing a floor exhaust can be used for pedestal type operations. The airflow can be shut off, if necessary, while delicate operations are performed.
- m) Special applications could require a unique gas environment or a completely confined atmospheric environment to be maintained in the work station. This design requires a closed and filtered recirculating system.
- n) A laminar flow exhaust hood (see Figure 18) is ideal for cleaning operations. The damper on the exhaust can be regulated so that no air will flow through the front opening or so that air will flow into the hood or out of the hood.
- o) Special care should be given to prevent contamination of items during transfer from clean work stations, especially when the clean work station is in an uncontrolled area. Assemblies transported from station to station should be protected enroute.
- p) Electrical systems are stipulated in paragraph 3.10. Supplemental lighting will be required for clean work stations. Lighting fixtures should be located such that interference with airflow and work procedures will be minimized.

## MIL-HDBK-1028/5A

q) Mechanical systems are stipulated in paragraph 3.11 and in FED-STD-209.

r) For acceptance tests, refer to paragraph 4.1.

5.6.2 Movable Laminar Flow Booth (Downflow Units). The movable laminar flow booth (see Figure 19) can be used for large devices that ordinarily could not be moved into a clean room. The bottom weighted transparent vinyl plastic side curtain should extend down to just above the area to be protected. For sensitive adjustments, the airflow can be shut off, in which case the plastic curtain should be extended to protect the items from stray air currents. (Refer to paragraph 5.6.1.)

5.6.3 Tunnel Units. A filter bank can be used at the end of a tunnel, with walls and ceilings made of light movable materials, for special applications. The air at the open end of the tunnel is not recirculated. The entire cross section of the tunnel must be composed of filters; otherwise, air currents will reintroduce contaminants into the airstream. (See the sketch for wall-to-tunnel airflow in Figure 10, and refer to paragraph 5.6.1.)

5.6.4 Filter Bank Module. A filter bank module is a type of clean work station without the bench surface. It consists of a blower system and HEPA filter units through which the room air is circulated. The filter bank module, similar to the vertical flow ceiling unit in Figure 13, is used in a conventional clean room for reducing the particle count in the vicinity of the module. The required number and size of the filter bank modules depend on the desired level of cleanliness. The module has little effect on remote areas of the room and, while it may be an economical solution to local contamination, it should generally not be considered effective in upgrading the entire room. Figure 20 illustrates a typical situation where filter bank modules might be used to minimize local contamination as products move along a process line.

MIL-HDBK-1028/5A

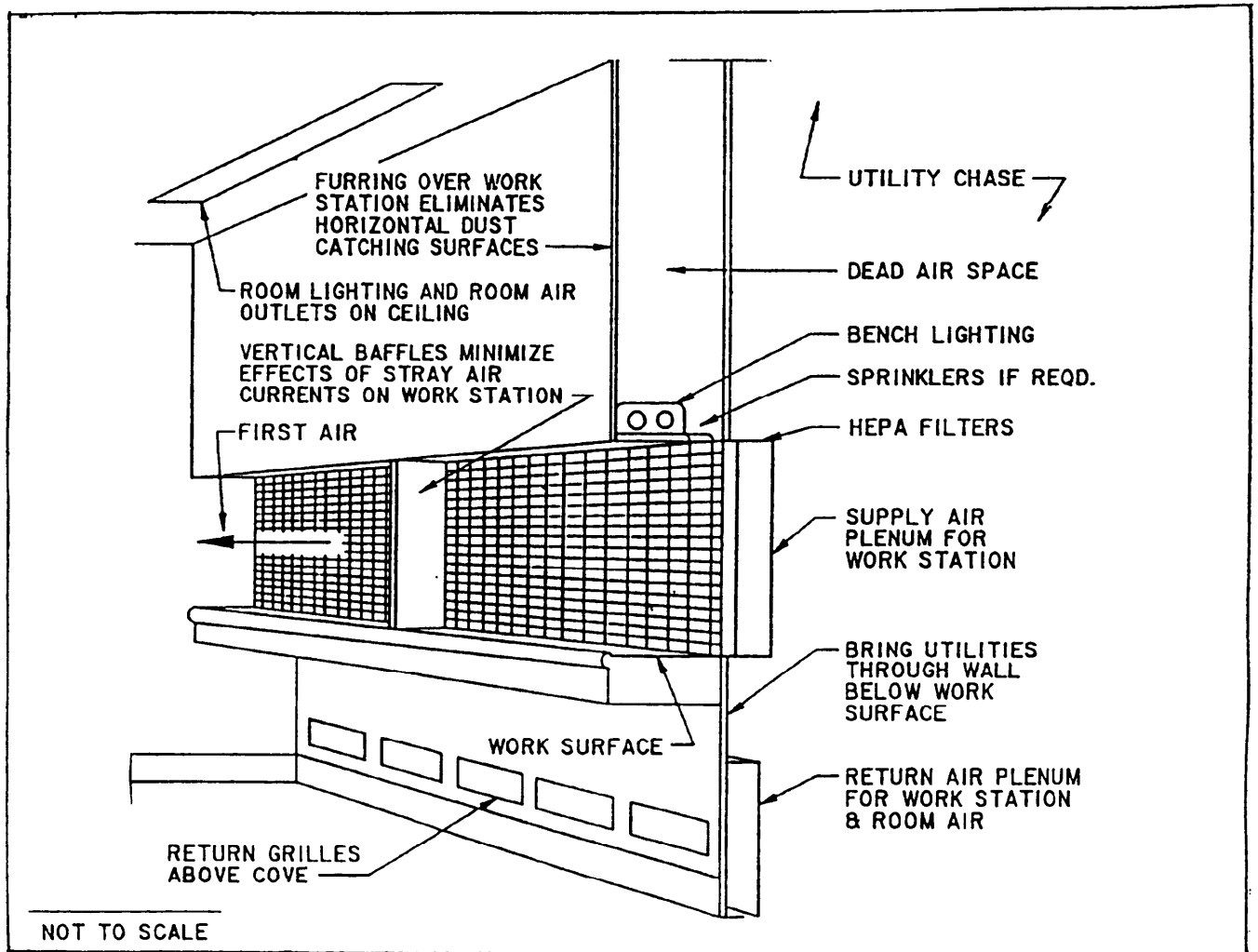

Figure 15  
Built-in Clean Work Station

MIL-HDBK-1028/5A

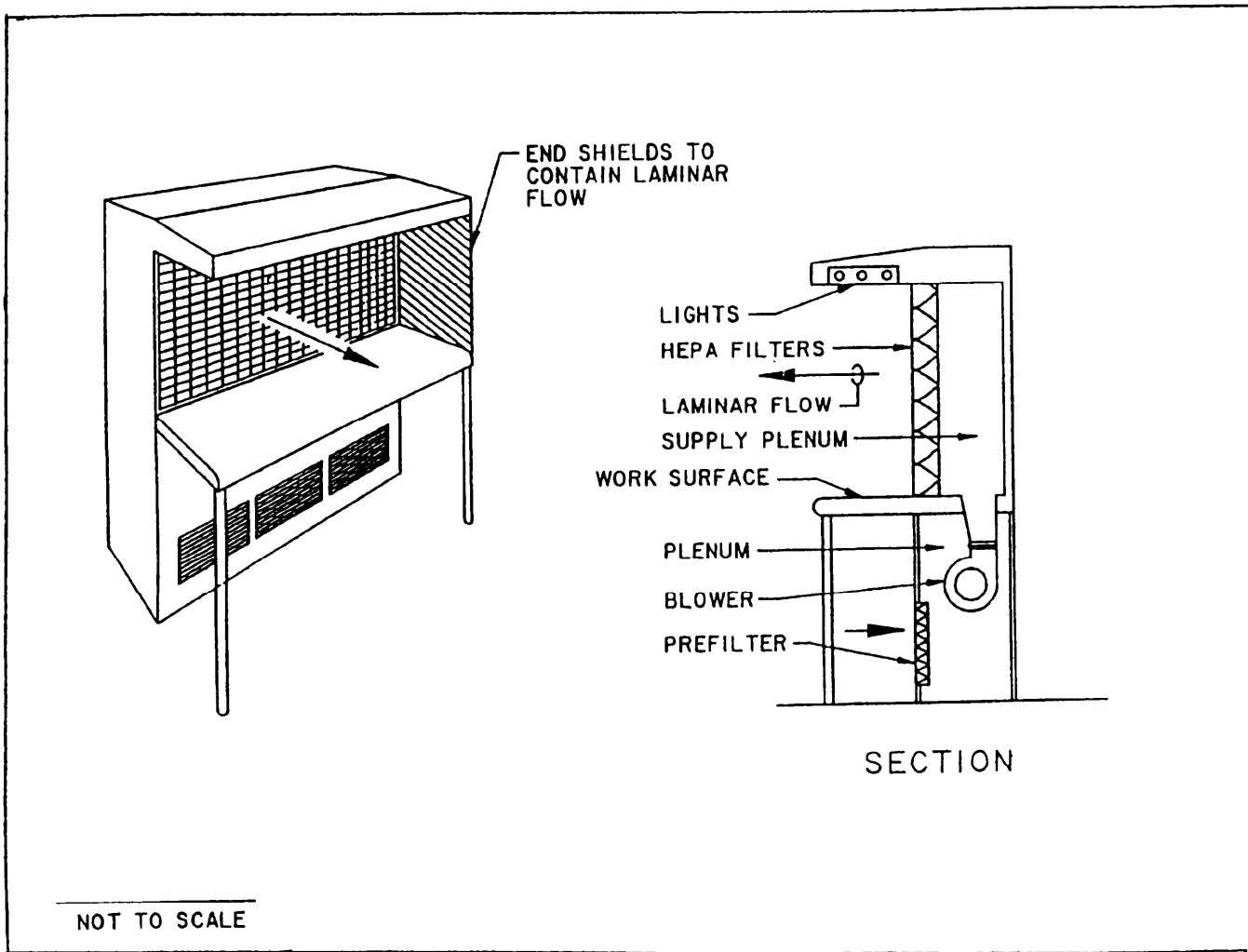

Figure 16  
Horizontal Laminar Flow Bench

MIL-HDBK-1028/5A

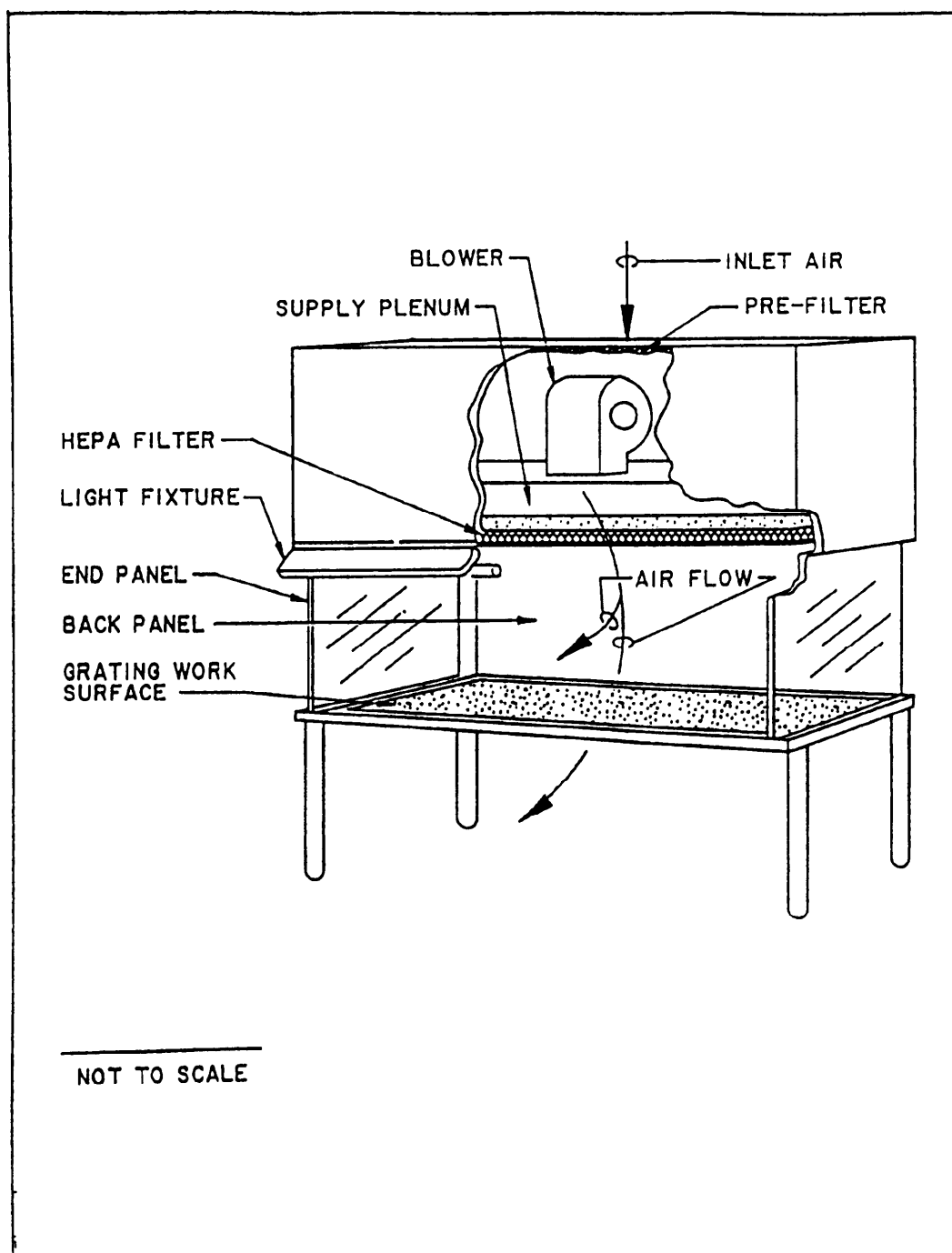

Figure 17  
Vertical Laminar Flow Bench

MIL-HDBK-1028/5A

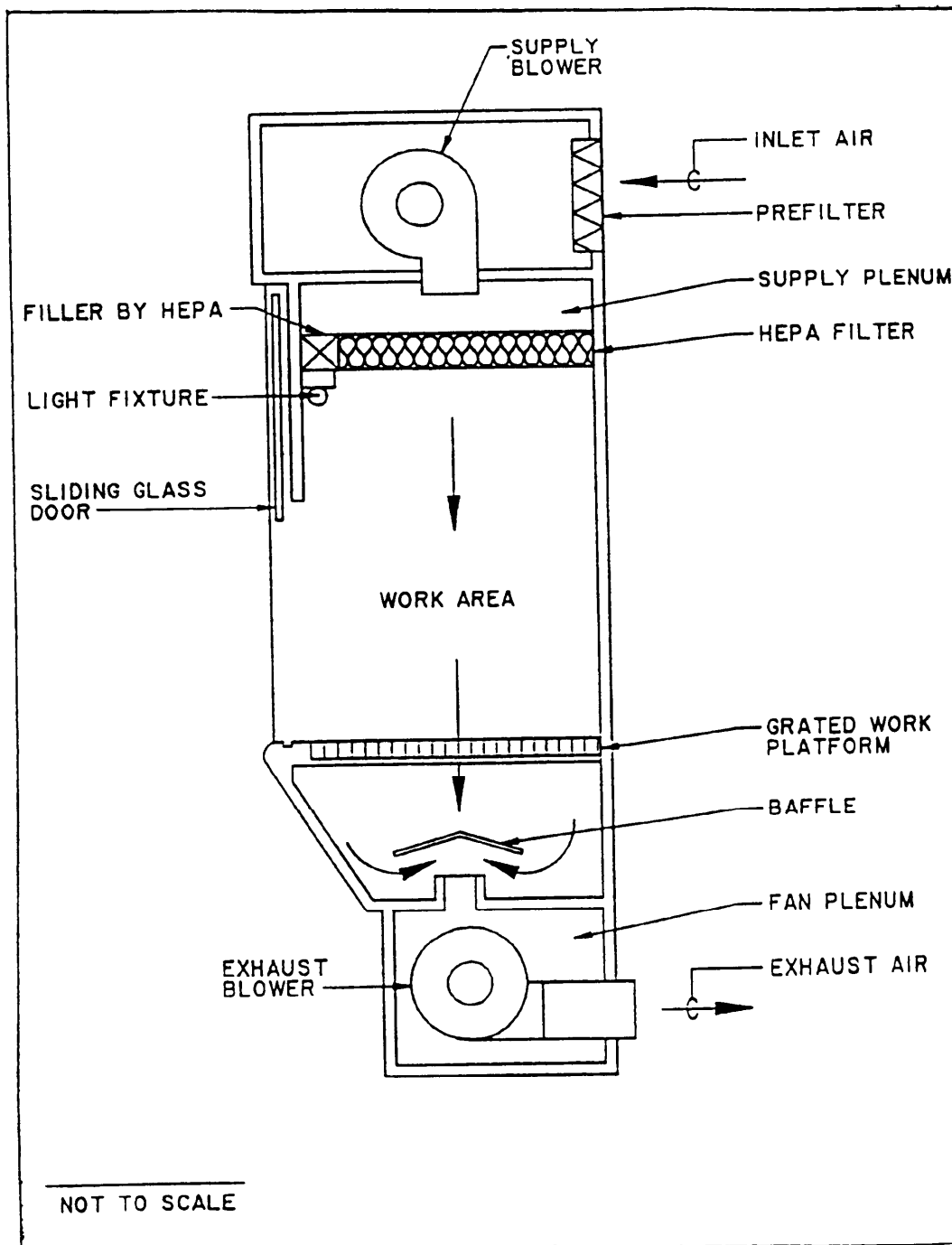

Figure 18  
Laminar Flow Exhaust Hood

MIL-HDBK-1028/5A

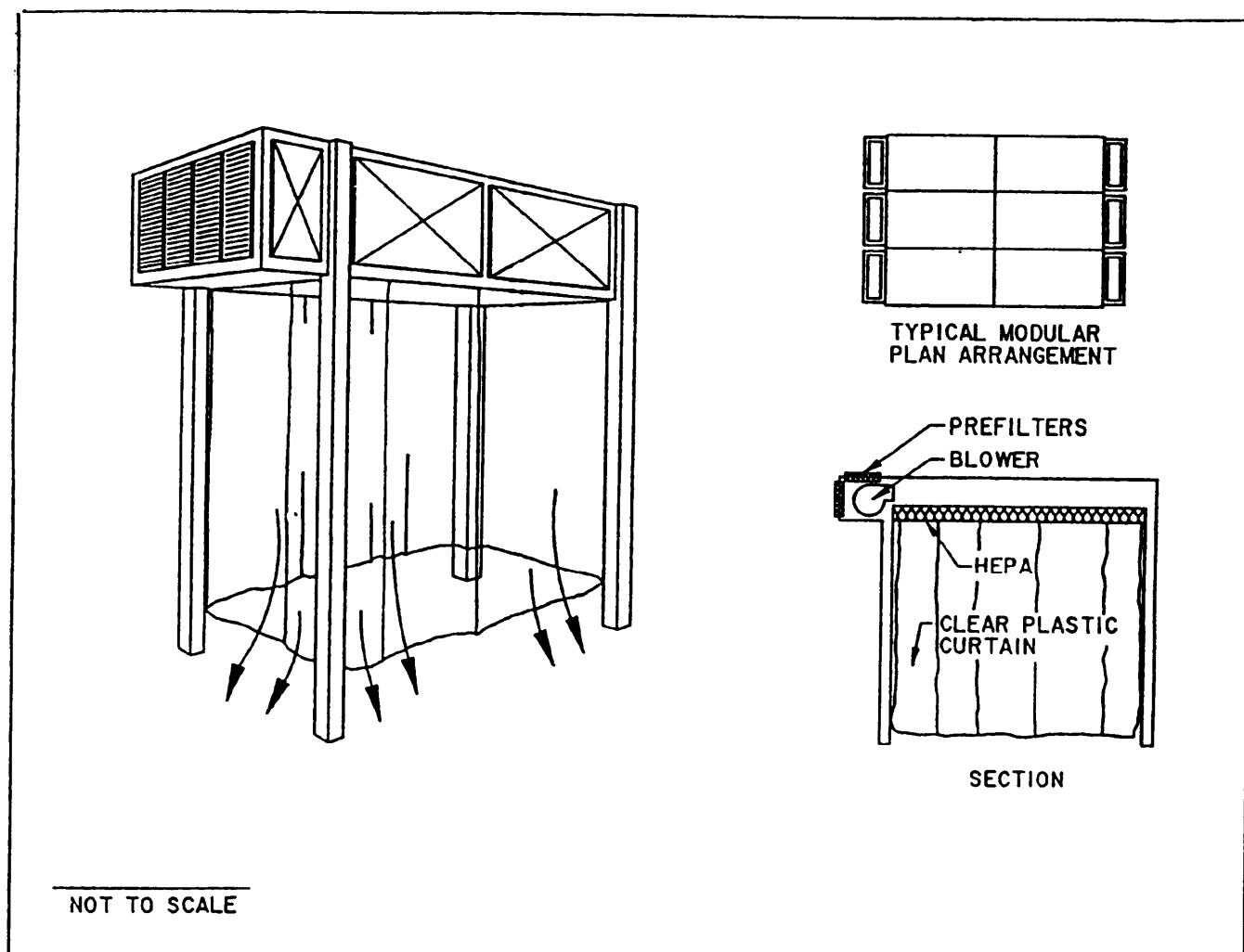

Figure 19  
Movable Laminar Flow Clean Booth

MIL-HDBK-1028/5A

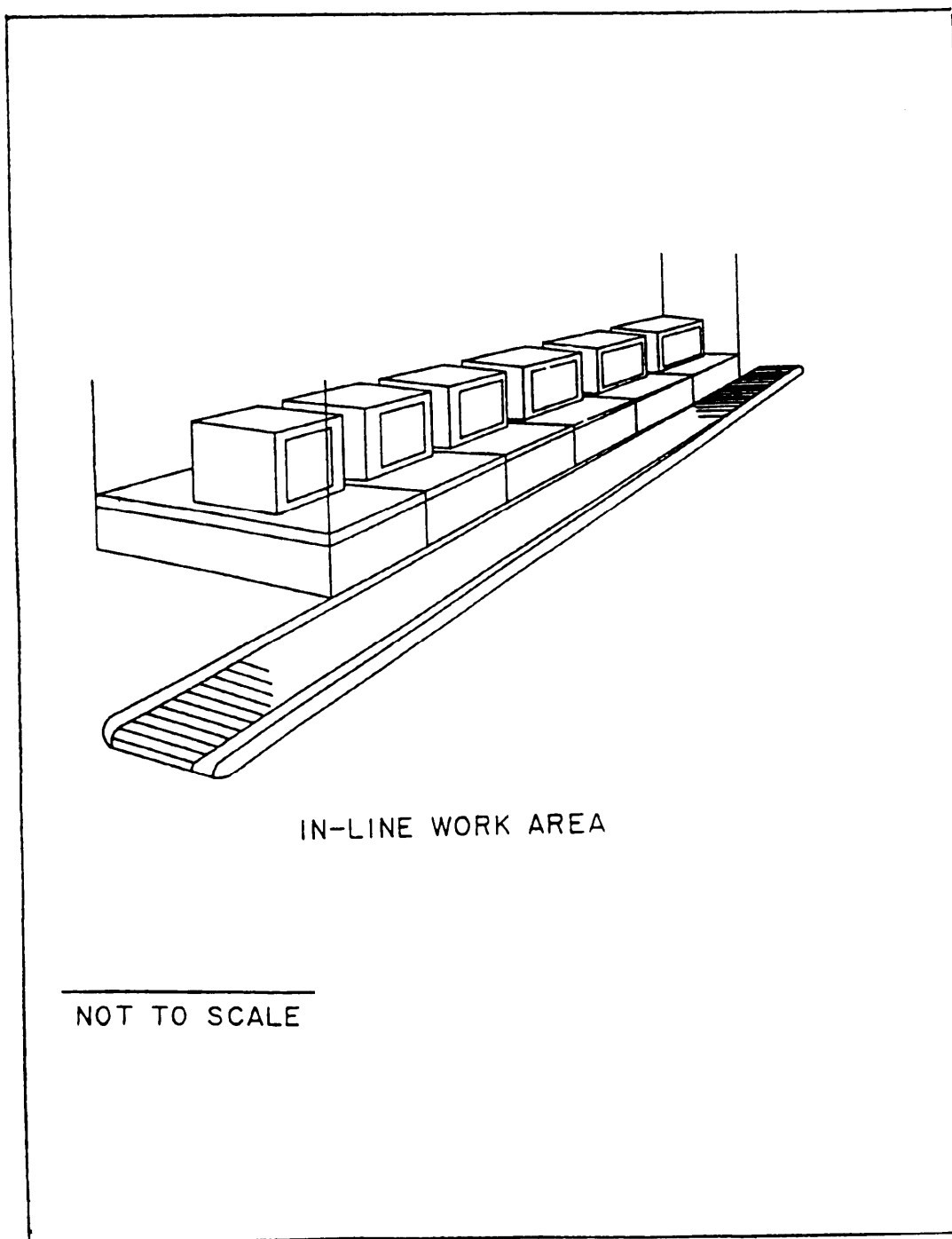

Figure 20  
Filter Bank Module



MIL-HDBK-1028/5A

BIBLIOGRAPHY

American Engineering Council, available at the U.S. Department of Commerce, National Technical Information Service, Operations Division, Springfield, VA 22151.

TID 7023 High Efficiency Particulate Air Filter Units, Guide to Inspection, Storage, Handling, and Installations

MIL-F-51079 Filter, Medium, Fire-Resistant, High-Efficiency

American Society of Heating, Refrigerating, and Air-Conditioning Engineers (ASHRAE), 1791 Tullie Circle, N.E., Atlanta, GA 30329-2305.

Standard 52 Method of Testing Air-Cleaning Devices Used in General Ventilation for Removing Particulate Matter

Occupational Safety and Health Act Standards Manual, Department of Labor, Occupational Safety and Health Administration (OSHA), Washington, DC 20210.

Whyte, W. 1991. "Cleanroom Design," ISBN0471928143, John Wiley & Sons, Inc., New York, NY.

Kozicki, Michael N. 1991. "Cleanrooms, Facilities and Practices." ISBN0442319509, Van Nostrand Reinhold, New York, NY

## MIL-HDBK-1028/5A

## REFERENCES

NOTE: Unless otherwise specified in the text, users of this handbook should utilize the latest revisions of the documents cited herein.

FEDERAL/MILITARY SPECIFICATIONS, STANDARDS, HANDBOOKS AND NAVFAC GUIDE SPECIFICATIONS:

The following specifications, standards and handbooks form a part of this document to the extent specified herein. Unless otherwise indicated, copies are available from the Standardization Documents Order Desk, Bldg. 4D, 700 Robbins Avenue, Philadelphia, PA 19111-5094.

SPECIFICATION

MILITARY

MIL-F-51068 Filter, Particulate (High-Efficiency Fire Resistant)

STANDARDS

FEDERAL

FED-STD-209 Airborne Particulate Cleanliness Classes In Cleanrooms and Clean Zones

MILITARY

MIL-STD-282 Filter Units, Protective Clothing, Gas-Mask Components and Related Products: Performance-Test Methods

HANDBOOKS

MIL-HDBK-1001/2 Materials and Building Components

MIL-HDBK-1002 series Timber Structures

MIL-HDBK-1003/17 Industry Ventilation Systems

MIL-HDBK-1004/4 Electrical Utilization Systems

MIL-HDBK-1008 Fire Protection for Facilities Engineering, Design, and Construction

MIL-HDBK-1190 Facility Planning and Design Guide

NAVFAC GUIDE SPECIFICATIONS

NFGS-15200 Noise, Vibration, (and Seismic) Control

NFGS-16402 Interior Wiring Systems

## MIL-HDBK-1028/5A

## NAVY MANUALS:

Government and private agencies may order Navy manuals by contacting the Naval Publications and Forms Center (NPFC), 5801 Tabor Avenue, Philadelphia, PA 19120-5099.

|          |                                                                  |
|----------|------------------------------------------------------------------|
| DM-1.03  | Architectural Acoustics                                          |
| DM-3.03  | Heating, Ventilating, Air Conditioning and Dehumidifying Systems |
| DM-3.05  | Compressed Air and Vacuum Systems                                |
| DM-3.10  | Noise and Vibration Control of Mechanical Equipment              |
| DM-5.04  | Pavements                                                        |
| DM-38.01 | Weight Handling Equipment                                        |

## NON-GOVERNMENT PUBLICATIONS:

The following publications form a part of this document to the extent specified herein. Unless otherwise specified, the issues of the documents which are DoD adopted are those listed in the Department of Defense Index of Specifications & Standards (DODISS):

AMERICAN SOCIETY OF HEATING, REFRIGERATING, AND AIR-CONDITIONING ENGINEERS. INC. (ASHRAE)

## HANDBOOKS

|               |   |                                        |
|---------------|---|----------------------------------------|
| 1992 Handbook | - | Equipment                              |
| 1991 Handbook | - | HVAC Systems and Applications          |
| 1990 Handbook | - | Refrigeration Systems and Applications |
| 1989 Handbook | - | Fundamentals                           |

## STANDARD

|     |   |                                            |
|-----|---|--------------------------------------------|
| 90A | - | Energy Conservation in New Building Design |
|-----|---|--------------------------------------------|

(Unless otherwise indicated, copies are available from American Society of Heating, Refrigerating, and Air-Conditioning Engineers, Inc., 1791 Tullie Circle, N.E., Atlanta, GA 30329-2305.)

MIL-HDBK-1028/5A

ASTM

- ASTM E84 - Standard Test Method For Surface Burning Characteristics of Building Materials
- ASTM E380 - Standard Practice for Use of the International Systems of Units (SI) (the Modernized Metric System)
- ASTM E621 - Standard Practice for the Use of Metric (SI) Units in Building Design and Construction

(Unless otherwise indicated, copies are available from ASTM, 1916 Race Street, Philadelphia, PA 19103.)

FACTORY MUTUAL ENGINEERING AND RESEARCH

Loss Protection Data, Section 1-56, Clean Rooms

(Unless otherwise indicated, copies are available from Factory Mutual Engineering and Research, 1151 Boston-Providence Turnpike, P.O. Box 9102, Norwood, MA 02062.)

NATIONAL FIRE PROTECTION ASSOCIATION (NFPA)

- NFPA 70 - National Electrical Code
- NFPA 101 - Code for Safety to Life from Fire in Buildings and Structures
- NFPA 101M - Manual on Alternative Approaches to Life Safety

(Unless otherwise indicated, copies are available from National Fire Protection Association, One Batterymarch Park, P.O. Box 9101, Quincy, MA 02269-9101.)

UNDERWRITERS LABORATORIES, INC.

- UL 586 - Standard for Safety High-Efficiency, Particulate, Air Filter Units

(Unless otherwise indicated, copies are available from Underwriters Laboratories, Inc., 333 Pfingsten Road, Northbrook, IL 60062.)

## MIL-HDBK-1028/5A

## GLOSSARY

Air Lock. An air lock maintains the pressurization of a clean room during entry and exit from the room.

Air Shower. A personnel cleaning system utilizing a high velocity air stream and vacuum to remove particulate matter clinging to outer clothing and skin surfaces.

Bypass Air. Primary air which is bypassed through an air conditioning unit before being recirculated through the HEPA filter bank of a laminar flow room.

Cool Water. Water which circulates through dry coils and removes heat from them. Cool water temperature is always above the dew point temperature of the coil airstream.

Dry Coil. A cooling coil whose dry bulb temperature is always above the dew point of the air passing through it. Used in laminar flow systems to remove fan sensible heat from primary airstream.

Dry Piping. Piping which handles supply and return water for a dry coil.

First Air. The air which issues directly from the HEPA filter.

First Work Location. The work location nearest the downstream side of the HEPA filters in a laminar airflow device.

High Efficiency Particulate Air (HEPA) Filter. A filter as specified in Military Specification MIL-F-51068 with a minimum efficiency of 99.97 percent as determined by test. The test can be by the homogeneous dioctyl phthalate (DOP) (Military Standard MIL-STD-282) method or other equally sensitive method at an airflow of 100 percent of the rated flow capacity for all size filters and at 20 percent of the rated airflow for nominal rated capacity for 500, 1,000, and 1,250 CFM.

Laminar Flow. For the purposes of this document, laminar flow is defined as airflow in which the entire body of air within a confined area essentially moves with uniform velocity along parallel flow lines.

Laminar Flow Clean Room. A room in which the laminar airflow characteristics predominate throughout the entire airspace, with a minimum of eddies.

Laminar Flow Clean Work Station. A work station in which the laminar airflow characteristics predominate throughout the entire airspace. It can be a bench or hood, portable or fixed.

Makeup Air. Air supplied to conventional and laminar flow clean rooms so that internal air pressure will be above that of surrounding spaces.

Makeup Air Fan. A fan which handles makeup air.

MIL-HDBK-1028/5A

Medium Efficiency Filter. A filter with an efficiency of 80 to 90 percent minimum as determined by ASHRAE dust spot efficiency test using atmospheric dust.

Nonlaminar Flow (Conventional) Clean Room. A room supplied with filtered air with no specified requirement for uniform airflow patterns or uniform air velocity.

Prefilters. Filters to trap gross particulates located upstream from and with lower collection efficiency than the HEPA filter.

Primary Air. Air which is recirculated through the HEPA filter bank forming the wall or ceiling of a laminar flow room.

Primary Fan. A fan which handles primary air.

Standard Filter. A filter with an efficiency of 80 to 90 percent minimum as determined by ASHRAE weight arrestance test using ASHRAE synthetic dust.

Transfer Coil. Provides alternative source of cooling water in lieu of chilled water from chilled distribution system. For use in the dry coil in the primary airstream of a laminar flow system.

CUSTODIAN  
NAVY - YD2

PREPARING ACTIVITY  
NAVY - YD2

PROJECT NO.  
FACR-1122