

UFC 3-600-01  
26 September 2006

# **UNIFIED FACILITIES CRITERIA (UFC)**

---

## **FIRE PROTECTION ENGINEERING FOR FACILITIES**



**APPROVED FOR PUBLIC RELEASE; DISTRIBUTION UNLIMITED**

**UNIFIED FACILITIES CRITERIA (UFC)****FIRE PROTECTION ENGINEERING FOR FACILITIES**

Any copyrighted material included in this UFC is identified at its point of use. Use of the copyrighted material apart from this UFC must have the permission of the copyright holder.

U.S. ARMY CORPS OF ENGINEERS

NAVAL FACILITIES ENGINEERING COMMAND (Preparing Activity)

AIR FORCE CIVIL ENGINEER SUPPORT AGENCY

Record of Changes (changes are indicated by \1\ ... /1/)

<b>Change No.</b>	<b>Date</b>	<b>Location</b>

---

**This UFC supersedes UFC 3-600-01, dated April 2003, and all subsequent changes.**

**UFC 3-600-01**  
**26 September 2006**

## FOREWORD

The Unified Facilities Criteria (UFC) system is prescribed by MIL-STD 3007 and provides planning, design, construction, sustainment, restoration, and modernization criteria, and applies to the Military Departments, the Defense Agencies, and the DoD Field Activities in accordance with [USD\(AT&L\) Memorandum](#) dated 29 May 2002. UFC will be used for all DoD projects and work for other customers where appropriate.

UFC are living documents and will be periodically reviewed, updated, and made available to users as part of the Services' responsibility for providing technical criteria for military construction. Headquarters, U.S. Army Corps of Engineers (HQUSACE), Naval Facilities Engineering Command (NAVFAC), and Air Force Civil Engineer Support Agency (AFCESA) are responsible for administration of the UFC system. Defense agencies should contact the preparing service for document interpretation and improvements. Technical content of UFC is the responsibility of the cognizant DoD working group. Recommended changes with supporting rationale should be sent to the respective service proponent office by the following electronic form: [Criteria Change Request \(CCR\)](#). The form is also accessible from the Internet sites listed below.

UFC are effective upon issuance and are distributed only in electronic media from the following sources:

- Whole Building Design Guide web site <http://dod.wbdg.org/>.

Hard copies of UFC printed from electronic media should be checked against the current electronic version prior to use to ensure that they are current

### AUTHORIZED BY:

  
DONALD L. BASHAM, P.E.  
Chief, Engineering and Construction  
U.S. Army Corps of Engineers

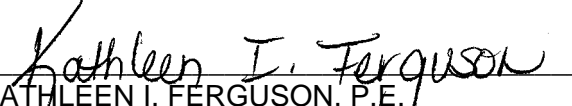
  
KATHLEEN I. FERGUSON, P.E.  
The Deputy Civil Engineer  
DCS/Installations & Logistics  
Department of the Air Force

  
DR. JAMES W. WRIGHT, P.E.  
Chief Engineer  
Naval Facilities Engineering Command

  
Dr. GET W. MOY, P.E.  
Director, Installations Requirements and  
Management  
Office of the Deputy Under Secretary of Defense  
(Installations and Environment)

**UFC 3-600-01**  
**26 September 2006**

**UNIFIED FACILITIES CRITERIA (UFC)**  
**REVISION SUMMARY SHEET**

**Document:** UFC 3-600-01, *Fire Protection Engineering for Facilities*

**Superseding:** This UFC supersedes UFC 3-600-01, dated April 2003, and all subsequent changes.

**Description of Changes:** This update to UFC 3-600-01 clarifies many of the requirements in the April 2003 version, as well as updates references, and further coordinates the services' requirements. New criteria for the following were added:

- Hydrant Color Coding
- Telecommunication Facilities
- Emergency Services Communication Centers
- High Rise Buildings

**Reasons for Changes:**

- New editions of many references, including NFPA 20.
- Clarify position on use of IBC versus NFPA 5000.
- Requirements of NFPA 50 were moved to NFPA 55.

**Impact:**

## CONTENTS

CHAPTER 1 INTRODUCTION.....	1
1-1 SCOPE.....	1
1-2 PURPOSE.....	1
1-2.1 Document Development.....	1
1-3 CRITERIA.....	1
1-3.1 Existing Facilities.....	2
1-3.2 Application/Types of Work Efforts.....	3
1-3.3 Absence of Criteria.....	4
1-3.4 Performance-Based Fire Safety Design.....	4
1-3.5 Conflicts in Criteria.....	5
1-3.6 Authority Having Jurisdiction (AHJ).....	5
1-3.7 Equivalencies.....	5
1-3.8 Waivers.....	6
1-3.9 Antiterrorism Standards.....	6
1-4 DESIGN ANALYSIS.....	6
1-4.1 100% Design Submission.....	7
1-5 SERVICES AND QUALIFICATIONS OF FIRE PROTECTION ENGINEERS.....	7
1-6 FIRE PROTECTION DURING CONSTRUCTION.....	8
CHAPTER 2 BUILDING CONSTRUCTION.....	9
2-1 BASIC CRITERIA.....	9
2-1.1 Egress and Safety to Life.....	9
2-1.2 Partitions.....	9
2-1.3 Type of Construction.....	9
2-1.4 Separation Between Buildings.....	9
2-2 FIRE AREAS.....	10
2-3 BUILDING HEIGHT LIMITATIONS.....	10
2-4 LIMITING INTERIOR FIRE SPREAD.....	10
2-4.1 Door Openings.....	10
2-4.2 Penetrations.....	10
2-5 MEANS OF EGRESS.....	10
2-5.1 Requirements.....	10
2-5.2 Means of Egress Marking.....	11
2-6 INTERIOR FINISH.....	11
2-6.1 Interior Wall and Ceiling Finish.....	11
2-6.2 Interior Floor Finish.....	11
2-7 INSULATION.....	11
2-7.1 Requirements.....	12
2-7.2 Exceptions to Insulation Criteria.....	12
2-8 ROOF COVERINGS AND ROOF DECK ASSEMBLIES.....	13
2-8.1 Roof Coverings.....	13
2-8.2 Roof Deck Assemblies.....	13
2-9 ROOF ACCESS.....	13
2-10 FIRE DEPARTMENT (EMERGENCY) VEHICLE ACCESS.....	13
2-10.1 All-Weather Ground Access.....	13
2-10.2 Vehicle Access.....	14

2-10.3	<b>Aerial Apparatus Access</b> .....	14
2-10.4	<b>Fire Department Connection</b> .....	14
2-11	<b>AIR HANDLING</b> .....	14
2-11.1	<b>Design Requirements</b> .....	14
2-11.2	<b>Corridors</b> .....	14
2-11.3	<b>Plenums</b> .....	15
2-11.4	<b>Smoke and Heat Vents</b> .....	15
2-12	<b>PLASTIC PIPE AND CONDUIT</b> .....	15
2-12.1	<b>Penetrations</b> .....	15
2-12.2	<b>Prohibited Locations</b> .....	15
2-13	<b>FIRE RETARDANT TREATED (FRT) PLYWOOD</b> .....	15
2-13.1	<b>New Construction</b> .....	15
2-13.2	<b>Existing Construction</b> .....	15
<b>CHAPTER 3 WATER SUPPLY FOR FIRE PROTECTION</b> .....		17
3-1	<b>WATER DEMANDS FOR SPRINKLERED FACILITIES</b> .....	17
3-1.1	<b>Factors Influencing the Water Demand for Sprinklers</b> .....	17
3-1.2	<b>Water Demand for Sprinklers</b> .....	17
3-1.3	<b>Water Demand for Hose Streams</b> .....	17
3-1.4	<b>Total Water Demand for Sprinklered Occupancies</b> .....	17
3-1.5	<b>Water Demand for Sprinklers (Special Facilities)</b> .....	17
3-2	<b>WATER DEMANDS FOR UNSPRINKLERED FACILITIES</b> .....	18
3-2.1	<b>Hose Stream Demands for Unsprinklered Facilities</b> .....	18
3-2.2	<b>Hose Stream Demand for Unsprinklered Special Facilities</b> .....	19
3-2.3	<b>Aircraft Parking and Refueling Facilities</b> .....	21
3-2.4	<b>Yard and Outdoor Storage</b> .....	21
3-2.5	<b>Vehicle Parking Areas</b> .....	21
3-3	<b>WATER SUPPLY PRESSURE REQUIREMENTS</b> .....	21
3-3.1	<b>Pressure Required</b> .....	21
3-4	<b>QUANTITIES OF WATER REQUIRED</b> .....	22
3-4.1	<b>Total Storage Capacity</b> .....	22
3-4.2	<b>Reduction in Storage Capacity</b> .....	22
3-4.3	<b>Replenishment of Storage</b> .....	22
3-5	<b>WATER FOR FIRE PROTECTION</b> .....	22
3-5.1	<b>On-Site Storage</b> .....	23
3-5.2	<b>Monitoring</b> .....	23
3-6	<b>FIRE PUMPS</b> .....	23
3-6.1	<b>Requirements</b> .....	23
3-6.2	<b>Pump Type</b> .....	24
3-6.3	<b>Pump Starting Arrangement</b> .....	24
3-6.4	<b>Pump Drive</b> .....	24
3-6.5	<b>Pump Bypass</b> .....	24
3-6.6	<b>Backflow Preventer</b> .....	25
3-7	<b>WATER DISTRIBUTION SYSTEMS</b> .....	25
3-7.1	<b>Distribution Mains</b> .....	25
3-7.2	<b>Valves</b> .....	25
3-7.3	<b>Hydrants</b> .....	25
3-7.4	<b>Pressure-Regulating Valves (PRVs)</b> .....	27

3-7.5	<b>Backflow Prevention and Cross Connection Control</b> .....	28
3-7.6	<b>Meters</b> .....	28
<b>CHAPTER 4 FIRE EXTINGUISHING SYSTEMS</b> .....		29
4-1	<b>GENERAL</b> .....	29
4-1.1	<b>Connections to Fire Reporting Systems</b> .....	29
4-1.2	<b>Plans and Calculations</b> .....	29
4-1.3	<b>Water Flow Testing</b> .....	29
4-2	<b>AUTOMATIC SPRINKLER SYSTEMS</b> .....	29
4-2.1	<b>Characteristics</b> .....	29
4-2.2	<b>Application Requirements</b> .....	29
4-2.3	<b>Design Requirements</b> .....	30
4-3	<b>WATER SPRAY SYSTEMS</b> .....	33
4-3.1	<b>Requirements</b> .....	33
4-4	<b>FOAM SYSTEMS</b> .....	33
4-4.1	<b>Requirements</b> .....	33
4-4.2	<b>AFFF</b> .....	34
4-5	<b>STANDPIPE SYSTEMS</b> .....	34
4-5.1	<b>Class I Standpipe Systems</b> .....	34
4-5.2	<b>Class II and Class III Standpipes</b> .....	34
4-6	<b>DRY CHEMICAL EXTINGUISHING SYSTEMS</b> .....	34
4-6.1	<b>Application</b> .....	35
4-6.2	<b>Design Requirements</b> .....	35
4-6.3	<b>Limitations</b> .....	35
4-7	<b>CARBON DIOXIDE SYSTEMS</b> .....	35
4-7.1	<b>Application</b> .....	35
4-7.2	<b>Design Requirements</b> .....	35
4-8	<b>HALON 1301 SYSTEMS</b> .....	36
4-8.1	<b>Application</b> .....	36
4-9	<b>PORTABLE FIRE EXTINGUISHERS</b> .....	36
4-9.1	<b>Extinguisher Cabinets</b> .....	36
4-10	<b>WET CHEMICAL EXTINGUISHING SYSTEMS</b> .....	36
4-10.1	<b>Application</b> .....	36
4-10.2	<b>Design Requirements</b> .....	36
4-11	<b>CLEAN AGENT FIRE EXTINGUISHING SYSTEMS</b> .....	36
4-11.1	<b>Application</b> .....	36
4-11.2	<b>Design Requirements</b> .....	36
4-12	<b>WATER MIST FIRE PROTECTION SYSTEMS</b> .....	37
4-12.1	<b>Application</b> .....	37
4-12.2	<b>Design Requirements</b> .....	37
<b>CHAPTER 5 FIRE ALARM SYSTEMS</b> .....		38
5-1	<b>PLANS AND CALCULATIONS</b> .....	38
5-2	<b>FIRE ALARM REPORTING SYSTEMS</b> .....	38
5-2.1	<b>Applications</b> .....	38
5-2.3	<b>Requirements</b> .....	38
5-3	<b>FIRE ALARM EVACUATION SYSTEMS</b> .....	39
5-3.1	<b>Applications</b> .....	39

5-3.2	Requirements.....	39
5-3.3	Mass Notification System (MNS).....	40
5-4	<b>AUTOMATIC FIRE DETECTION SYSTEMS.....</b>	40
5-4.1	Applications.....	40
5-4.2	Requirements.....	40
5-4.3	Detection Systems.....	40
<b>CHAPTER 6 SPECIAL OCCUPANCIES AND HAZARDS.....</b>		42
6-1	<b>PERSONNEL HOUSING AND SIMILAR LODGING FACILITIES.....</b>	42
6-1.1	Automatic Sprinkler Protection.....	42
6-1.2	Smoke Detection.....	42
6-1.3	Open Bay Personnel Housing.....	42
6-1.4	Apartment-Style Personnel Housing Quarters.....	42
6-1.5	Common Areas.....	42
6-1.6	Storage Areas, Shops, and Laundry Areas.....	43
6-2	<b>FAMILY HOUSING.....</b>	43
6-2.1	Definitions.....	43
6-2.2	New Family Housing.....	47
6-2.3	Existing Multi-Family Housing.....	48
6-2.4	Residential Range Top Extinguisher Units.....	49
6-2.5	Continuity.....	49
6-2.6	Off-Base Housing Requirements.....	49
6-2.7	Overseas Housing Requirements.....	50
6-2.8	Leased Family Housing.....	50
6-3	<b>FOOD PREPARATION IN FACILITIES.....</b>	50
6-3.1	Cooking Facilities for Other than Dwelling Units.....	50
6-3.2	Cooking Equipment in Facilities.....	50
6-4	<b>MEDICAL FACILITIES.....</b>	51
6-5	<b>DETENTION AND CORRECTIONAL FACILITIES.....</b>	51
6-5.1	Requirements.....	51
6-5.2	Locking Devices.....	51
6-5.3	Interior Finish.....	52
6-6	<b>LIBRARIES.....</b>	52
6-6.1	Facilities with Sprinkler Protection.....	52
6-6.2	Facilities without Sprinkler Protection.....	52
6-7	<b>CHILD DEVELOPMENT FACILITIES (CDC).....</b>	52
6-7.1	Other Child Development Facilities.....	52
6-8	<b>ELECTRONIC EQUIPMENT INSTALLATIONS.....</b>	53
6-8.1	Requirements.....	53
6-8.2	Existing Facilities.....	54
6-9	<b>TELECOMMUNICATIONS (TELECOM) ROOMS AND BUILDINGS.....</b>	54
6-9.1	Requirements.....	54
6-9.2	Construction.....	54
6-9.3	Detection.....	54
6-9.4	Multiple Tenant Facility.....	54
6-9.5	Stand-alone Telecom Buildings.....	54
6-10	<b>ORDNANCE.....</b>	55
6-10.1	Ordnance Production Facilities.....	55



6-10.2	<b>Ultra High-Speed Deluge Systems</b> .....	56
6-10.3	<b>Magazines and Bunkers</b> .....	58
6-10.4	<b>Stored Missile Assemblies</b> .....	59
6-10.5	<b>Other Ordnance Facilities</b> .....	59
6-11	<b>WAREHOUSES AND STORAGE FACILITIES</b> .....	59
6-11.1	<b>Sprinkler Protection</b> .....	59
6-11.2	<b>Bin Storage</b> .....	60
6-11.3	<b>Column Protection</b> .....	60
6-11.4	<b>Fire Area Limitation and Separation</b> .....	60
6-11.5	<b>Fire Walls</b> .....	61
6-11.6	<b>Rubber Tire Storage</b> .....	61
6-12	<b>STORAGE OF FLAMMABLE AND HAZARDOUS MATERIALS AND HAZARDOUS WASTE</b> .....	62
6-12.1	<b>Flammable/Hazardous (Flam/Haz) Storage</b> .....	62
6-12.2	<b>Flammable and Combustible Liquid Storage Areas</b> .....	62
6-12.3	<b>Hazardous Materials Storage Areas</b> .....	63
6-12.4	<b>Hazardous Waste Storage Facilities</b> .....	63
6-12.5	<b>Spill Containment</b> .....	64
6-12.6	<b>Prefabricated Structures</b> .....	64
6-12.7	<b>Outdoor Storage Limitations and Separation</b> .....	64
6-12.8	<b>Electric Wiring and Equipment</b> .....	64
6-12.9	<b>Ventilation</b> .....	65
6-13	<b>WATERFRONT FACILITIES</b> .....	65
6-14	<b>PETROLEUM FUEL FACILITIES</b> .....	65
6-14.1	<b>Aboveground Vertical Tanks</b> .....	65
6-14.2	<b>Aboveground Vertical Tanks for Flammable Liquids</b> .....	65
6-14.3	<b>Aboveground Vertical Tanks for Combustible Liquids</b> .....	66
6-14.4	<b>Fuel Transfer Facilities</b> .....	66
6-14.5	<b>Aircraft Direct Fueling</b> .....	66
6-15	<b>HYDRAULIC SYSTEMS</b> .....	66
6-15.1	<b>Petroleum-Based Hydraulic Fluids</b> .....	66
6-15.2	<b>Hydraulic Test Systems</b> .....	66
6-16	<b>AIRCRAFT HANGARS</b> .....	67
6-16.1	<b>Tension Fabric Hangars</b> .....	68
6-17	<b>AIRCRAFT ACOUSTICAL ENCLOSURES</b> .....	68
6-17.1	<b>Complete Enclosures (Hush-House)</b> .....	68
6-17.2	<b>Out of Airframe Acoustical Enclosures (Test Cells)</b> .....	68
6-18	<b>HYPERBARIC AND HYPOBARIC CHAMBERS</b> .....	68
6-18.1	<b>Hyperbaric Chambers</b> .....	68
6-18.2	<b>Hypobaric Chambers</b> .....	69
6-19	<b>ANECHOIC CHAMBERS</b> .....	69
6-20	<b>LIQUID OXYGEN (LOX)</b> .....	69
6-20.1	<b>Fixed Liquid Oxygen Tanks</b> .....	69
6-20.2	<b>Oxygen Bulk Tanks</b> .....	69
6-20.3	<b>Separation Distances for LOX Tanks and Carts</b> .....	69
6-20.4	<b>Bulk Tank Vehicle Parking</b> .....	70
6-20.5	<b>LOX Storage for Propellant Applications</b> .....	70
6-21	<b>DEPARTMENT OF DEFENSE DEPENDENT SCHOOLS (DODDS)</b> .....	70

6-22	<b>VEHICLE PARKING, STORAGE, MAINTENANCE, AND REPAIR FACILITIES</b> .....	70
6-22.1	Vehicle Parking.....	70
6-22.2	Overhaul and Repair Shops.....	70
6-22.3	Refueler Vehicle Facilities.....	71
6-23	<b>PESTICIDE STORAGE AND HANDLING FACILITIES</b> .....	71
6-24	<b>WINDOWLESS (LIMITED ACCESS) STRUCTURES</b> .....	71
6-24.1	Sprinkler Protection.....	71
6-25	<b>UNDERGROUND STRUCTURES</b> .....	72
6-25.1	Sprinkler Protection.....	72
6-26	<b>GAS SERVICE</b> .....	72
6-27	<b>COAL</b> .....	72
6-27.1	Storage.....	72
6-27.2	Handling.....	73
6-27.3	Pulverizing Equipment.....	73
6-28	<b>POWER GENERATING AND UTILIZATION EQUIPMENT</b> .....	74
6-28.1	Stationary Combustion Engines, Gas Turbines, and Generators.....	74
6-28.2	Transformers.....	74
6-29	<b>TRASH COLLECTION AND DISPOSAL FACILITIES</b> .....	78
6-29.1	Central Trash Collection and Dumpsters.....	78
6-29.2	Collection, Baling, and Storage Rooms.....	79
6-29.3	Trash Chutes.....	79
6-30	<b>PROTECTION OF ELEVATOR MACHINE ROOMS AND HOISTWAYS</b> .....	79
6-30.1	Fire Resistant Construction.....	79
6-30.2	Detection System.....	79
6-30.3	Electric Traction Elevators.....	80
6-30.4	Hydraulic Elevators.....	82
6-30.5	Flow Switch Test Connection.....	83
6-30.6	Italy.....	84
6-31	<b>TENSION FABRIC STRUCTURES</b> .....	87
6-31.1	Separation of, and Basic Allowable Area.....	87
6-31.2	Definitions:.....	87
6-31.3	Other Requirements.....	88
6-31.4	Tension Fabric Hangars.....	88
6-32	<b>COMMISSARIES AND EXCHANGES</b> .....	88
6-33	<b>MORALE WELFARE AND RECREATION FACILITIES</b> .....	89
6-34	<b>MULTISTORY BUILDINGS</b> .....	89
6-34.1	Building Four Stories or Greater.....	89
6-35	<b>COMBUSTIBLE CONSTRUCTION</b> .....	89
6-35.1	Renovation.....	89
6-36	<b>MISSILE ALERT FACILITIES (MAF)</b> .....	89
6-36.1	Sprinkler Protection.....	89
6-36.2	Heat Detectors.....	89
6-36.3	Fire Hydrants.....	89
6-37	<b>EMERGENCY SERVICES COMMUNICATIONS CENTERS</b> .....	90
6-38	<b>HIGH RISE BUILDINGS</b> .....	90
	<b>APPENDIX A REFERENCES</b> .....	91

APPENDIX B OCCUPANCY HAZARD CLASSIFICATION FOR DETERMINING AUTOMATIC SPRINKLER DENSITIES AND HOSE STREAM DEMANDS.....	99
<b>B-1 CLASSIFICATION OF OCCUPANCIES.....</b>	<b>99</b>
B-1.1 <b>Light Hazard Occupancies.....</b>	<b>99</b>
B-1.2 <b>Ordinary Hazard Group 1 Occupancies.....</b>	<b>99</b>
B-1.3 <b>Ordinary Hazard Group 2 Occupancies.....</b>	<b>100</b>
B-1.4 <b>Special Occupancies.....</b>	<b>101</b>
APPENDIX C PROCEDURE FOR DETERMINING FIRE FLOW DEMAND FOR UNSPRINKLERED FACILITIES.....	102
<b>C-1 PROCEDURES.....</b>	<b>102</b>
C-1.1 <b>Step One - Determine the Classification of Occupancy.....</b>	<b>102</b>
C-1.2 <b>Step Two - Determine the Water Demand Weighted Factors.....</b>	<b>102</b>
C-1.4 <b>Examples Calculations.....</b>	<b>105</b>
APPENDIX D PROCEDURE FOR PERFORMANCE BASED FIRE SAFETY DESIGN .....	108
<b>D-1 EQUIVALENT LEVEL OF SAFETY AND PROTECTION.....</b>	<b>108</b>
<b>D-2 DEFINITIONS.....</b>	<b>108</b>
D-2.1 <b>Stakeholders.....</b>	<b>108</b>
<b>D-3 FIRE SAFETY DESIGN DOCUMENTATION.....</b>	<b>108</b>
D-3.1 <b>Fire Protection Engineering Design Brief.....</b>	<b>108</b>
D-3.2 <b>Performance-Based Fire Safety Design Report.....</b>	<b>111</b>
D-3.3 <b>Building O&amp;M Documentation.....</b>	<b>111</b>
D-3.4 <b>Warrant of Fitness.....</b>	<b>112</b>
<b>D-4 REVIEW OF TRIAL DESIGNS.....</b>	<b>112</b>
D-4.1 <b>Third Party Review.....</b>	<b>112</b>
D-4.2 <b>Compliant Fire Safety Design.....</b>	<b>112</b>
D-4.3 <b>Review Brief.....</b>	<b>113</b>
APPENDIX E INTERNATIONAL BUILDING CODE, UNIFORM BUILDING CODE, AND NFPA 220 EQUIVALENTS.....	114
ACRONYMS .....	115

## FIGURES

Figure 4-1 Floor Control Valve Assembly.....	33
Figure 6-1 Garden Style Apartments.....	44
Figure 6-2 Townhouse Style Apartment Units (Alternative 1).....	45
Figure 6-3 Townhouse Style Apartment Units (Alternative 2).....	45
Figure 6-4 Attached Duplexes.....	46
Figure 6-5 Townhouse (Attached Single-Family Dwellings).....	47
Figure 6-6 Duplex.....	47
Figure 6-7 Electric Traction Elevator.....	81
Figure 6-8 Direct Plunger Hydraulic Elevator.....	85
Figure 6-9 Direct Plunger Hydraulic Elevator – Hydraulic Supply Piping Extending above the Second Finished Floor Elevation.....	85

Figure 6-9 Direct Plunger Hydraulic Elevator – Hydraulic Supply Piping Extending above the Second Finished Floor Elevation .....	86
Figure 6-10 Holeless Hydraulic Elevator .....	86
Figure 6-10 Holeless Hydraulic Elevator .....	87

## TABLES

Table 3-1 Atmospheric POL Tank Cooling Water .....	20
Table 3-2 Pressurized POL Tank Cooling Water .....	21
Table 4-1 Sprinkler System and Water Supply Design Requirements for Sprinklered Facilities .....	31
Table 6-1 (Navy and Air Force) Separation distance between outdoor insulated transformers and buildings .....	75
Table 6-2 (Army) Separation distance between outdoor insulated transformers and buildings.....	76
Table 6-3 (Navy and Air Force) separation distance between outdoor fluid insulated transformers and equipment (including other transformers).....	77
Table 6-4 (Army) separation distance between outdoor fluid insulated transformers and equipment (including other transformers).....	77
Table 6-5 ELECTRIC TRACTION ELEVATOR .....	80
Table 6-8 BASIC ALLOWABLE AREA for TENSION MEMBRANE/FABRIC STRUCTURES.....	88
Table C-1 Water Demands for Unsprinklered Facilities.....	105

**CHAPTER 1 INTRODUCTION****1-1 SCOPE.**

This UFC establishes fire protection engineering policy and criteria for Department of Defense (DOD) components. The provisions of this UFC are applicable to all new and existing DOD facilities located on or outside of DOD installations, whether acquired or leased, by appropriated or non-appropriated funds, or third party financed and constructed. Facilities covered by this document include all types of buildings and their contents, structures, whether considered temporary or permanent, mobile and stationary equipment, waterfront facilities, outside storage, and shore protection for ships and aircraft. Matters relating to fire department operations, staffing, and equipment are not covered by this UFC.

**1-2 PURPOSE**

The purpose of this UFC is to establish minimum protection requirements for DOD facilities. These criteria are based on commercial requirements set forth by national insurance underwriters and may exceed minimum national code requirements. The requirements in this UFC reflect the need for the protection of life, mission, and property (building or contents) while taking into account the costs of implementing the criterion and risks associated with the facility. These criteria have been established in the best interest of DOD.

**1-2.1 Document Development**

This document is intended to be used as a basis for the development of detailed design documents (including scope, basis of design, technical requirements, plans, drawings, specifications, cost estimates, request for proposals, and invitations for bids) used for the procurement of facilities, facility similar equipment, and other shore/land based infrastructure systems. It must be used as a reference document and requirement in the procurement of architectural and engineering services (A&E) and other consulting services to prepare detailed design documents including those for design/build projects. It is not intended to be used in lieu of detailed design documents in the procurement of facility construction.

**1-3 CRITERIA**

This UFC implements the following public laws:

- a. UNITED STATES CODE  
<http://www.gpoaccess.gov/uscode/index.html>
- USC Title 10, Section 1794      *Military Child Care*

**UFC 3-600-01**  
**26 September 2006**

- USC Title 15, Section 272            *Utilization of Consensus Technical Standards by Federal Agencies*
- USC Title 15, Section 2227        *Fire Administration Authorization Act (also referred to as the Fire Safety Act)*
- USC Title 15, Section 2225        *Hotel-Motel Fire Safety*

USC, Title 15, Section 272, identifies the necessary consensus technical standards required to implement policy objectives and activities within the area of fire protection engineering for the DOD. Compliance with criteria issued in accordance with this UFC does not constitute an exception to the public laws. Fire protection criteria must conform to the requirements of this UFC, the *National Fire Codes*, published by the National Fire Protection Association (NFPA), except as modified by this UFC, and portions of the *International Building Code (IBC)*, published by the International Code Council, as specifically referenced by this UFC. Additional criteria include portions of the *Factory Mutual Global Property Loss Prevention Data Sheets (FM Global Data Sheets)*, as specifically referenced by this UFC. Buildings required to be accessible must meet the provisions of Federal Standard FED-STD-795, *Uniform Federal Accessibility Standard (UFAS)* at <http://www.access-board.gov/ufas/ufas-html/ufas.htm>, and the *Americans With Disabilities Act Accessibility Guidelines (ADAAG)* at <http://www.access-board.gov/adaag/html/adaag.htm>.

**Note 1:** UFC 1-200-01 identifies the base line building code as the *International Building Code* to be used for all DoD construction. NFPA 5000 *Building Construction and Safety Code*, State or Local building codes will not be used.

**Note 2:** Projects that have significant time delays between the award for design and the beginning of construction must be re-evaluated and corrected to comply with any new editions of criteria (including codes and standards) that have been published.

### 1-3.1            **Existing Facilities.**

Existing facilities must meet the requirements of NFPA 101, *Life Safety Code*, for existing occupancies.

1-3.1.1        Facilities that do not meet the requirements of NFPA 101 for existing facilities must be brought up to, at least the minimum requirements for existing facilities. If the facility cannot be brought up to the minimum requirements for existing facilities without initiating a renovation, modernization, or rehabilitation project, that project must meet the requirements for new construction as specified in this UFC.

1-3.1.2 Any changes in occupancy require the facility to meet the requirements for new construction for the new occupancy as specified in this UFC.

### 1-3.2 **Application/Types of Work Efforts.**

This UFC applies to all work necessary to build, maintain, or change DoD facilities/structures/systems. The services and agencies within DoD use various terms to classify these work efforts.

#### 1-3.2.1 **Construction.**

Construction projects provide new facilities/structures/systems and must comply with the criteria in this UFC. Additions to existing buildings must comply with the criteria for new buildings. If the addition is 50% or more of the existing building's gross floor area, the existing building must comply with the criteria for new buildings, to the maximum extent possible.

#### 1-3.2.2 **Modernization/Major Investments.**

1-3.2.2.1 Buildings that have alteration, modernization, modification, rehabilitation, and renovation costs equal to or exceeding 50% of the replacement cost of the building, must bring the entire building into compliance with new construction requirements. The 50% cost is exclusive of the costs to bring the building into full compliance.

1-3.2.2.2 Facilities in which alteration, modernization, rehabilitation, and renovation work is less than 50% of the replacement value of the building, the building must comply with the criteria in this UFC for new construction, to the maximum extent practical. All new work accomplished as part of alteration, modernization, modification, rehabilitation, and renovation actions/projects must meet the requirements for new construction.

#### 1-3.2.3 **Sustainment and Restoration.**

New work accomplished in facilities as part of repair, restoration, and sustainment actions/projects must meet the requirements for new construction in this UFC.

**Note:** Sustainment and restoration efforts should look beyond the scope of work to ensure that the fire protection (including life safety) features are not being compromised or designed only for the portion of the building that is being repaired. The repair project, if possible, should include a basis to support the entire building, i.e., if considering providing a fire alarm extender panel to the existing antiquated fire alarm control panel, ensure the panel being provided has the capability to support the entire building so any additional projects can utilize the new panel without having to remove what was just installed.

#### 1-3.2.4 **Conversion of Use/Change of Occupancy.**

1-3.2.4.1 When any portion of an uninhabited building is modified from its current use to that of an inhabited building, billeting, or a primary gathering building, as defined by UFC 4-010-01, for one year or more, the building must meet the requirements for new construction.

**Note:** Examples would include a warehouse (uninhabited) being converted to administrative (inhabited) use; an inhabited administrative building being converted to a primary gathering building or billeting; or a non-compliant primary gathering building/billeting being altered, modernized, modified, rehabilitated, or renovated and converted to billeting/primary gathering building. Definitions of inhabited, uninhabited, primary gather building and billeting are found in UFC 4-010-01 *DoD Minimum Antiterrorism Standards For Buildings*.

1-3.2.4.2 When any portion of a building is modified from its current use to that of a mission essential building for one year or more, the building must meet the requirements for new construction.

**Note:** Examples would include a warehouse being converted to an aircraft hangar.

1-3.2.4.3 When any portion of a building is modified from its current use to any other occupancy use for two years or more, the building must meet the requirements for new construction. Changing groups of occupants within the occupancy classification does not constitute an occupancy change.

**Note:** An example of modifying from one occupancy to another would include an office building converted to mercantile. An example of changing groups of occupants would include an installation personnel function occupying the office space formally used by an installation contracting function.

#### 1-3.3 **Absence of Criteria**

When a specific application is not covered by the criteria cited in this UFC, follow national building codes, recognized industry standards, and standard engineering practices. In the absence of such technical information, contact the DOD component authority having jurisdiction (refer to paragraph 1-4.6).

#### 1-3.4 **Performance-Based Fire Safety Design.**

It is permissible that performance-based fire safety design methods be applied to the renovation, restoration, remodeling or modernization of existing facilities to address the evaluation of a subsystem, system, or complete building when it is not possible to meet the provided prescriptive requirements for new construction. New facilities for which established prescriptive criteria exist, must not be permitted to use performance-based fire and life safety design methods. The use of performance-based fire safety design methods must only be permitted



upon authorization by the DOD component authority having jurisdiction (AHJ) for new mission critical or unique facilities, where the user mandates requirements and objectives that are not addressed by established prescriptive requirements of national codes or this UFC. Performance-based fire safety design methods must not be used to eliminate required exiting requirements of NFPA 101, nor must it be used to eliminate automatic sprinkler systems required by DOD criteria.

#### **1-3.4.1 Application and Use of Performance-Based Fire Safety Design Methods.**

If performance-based fire safety design is used or permitted by the DOD component AHJ, Appendix D describes the provisions and applicable requirements associated with the fire safety design of DOD facilities. Appendix D is in accordance with the performance-based option of NFPA 101, *Life Safety Code*, and the performance-based fire safety design approach of the Society of Fire Protection Engineers (SFPE), *Introduction to Performance-Based Fire Safety*. A fire protection engineer that meets the requirements of paragraph 1-6 below must perform the performance-based fire safety design.

#### **1-3.5 Conflicts in Criteria.**

If a conflict exists between this UFC and any other DOD document, referenced code, standard, or publication, this UFC must take precedence. The individual DOD components may issue specific technical guidance that expands the requirements of this UFC. The Army and Air Force issue engineering technical letters (ETLs); the Navy issues interim technical guidance (ITG); and the DLA issues technical policies. For **Army**, see <http://www.hnd.usace.army.mil/techinfo/engpubs.htm>. For **Air Force**, see [www.afcesa.af.mil/Directorate/CES/Mechanical/FireEngr/default.htm](http://www.afcesa.af.mil/Directorate/CES/Mechanical/FireEngr/default.htm). For **Navy**, see <http://dod.wbdg.org/>.

#### **1-3.6 Authority Having Jurisdiction (AHJ).**

The term "AHJ" as used in the codes and standards referenced in this UFC must mean the component office of responsibility, i.e., U.S. Army, HQ USACE/CECW-CE; U.S. Navy, NAVFACENCOM HQ Code CHE; U.S. Marine Corps, HQMC Code LFF-1; U.S. Air Force, HQ AFCESA/CES; Defense Logistics Agency (DLA), DES-SE; National Geospatial-Intelligence Agency (NGA), Security and Installations; and all other DOD components, Deputy Under Secretary of Defense for Installations via the DOD Committee on Fire Protection Engineering.

#### **1-3.7 Equivalencies.**

Equivalencies to established criteria may be approved by the AHJ, if the alternate fire protection engineering design provides an equivalent level of fire protection and life safety. Requests for approval must include written justification, hazard analysis, cost comparisons, criteria used, and other pertinent data. Lack of funds is not considered sufficient justification for deviation from established criteria.

Approved equivalencies and alternatives must only apply to the specific facility involved and do not constitute blanket approval for similar cases.

#### 1-3.8 **Waivers.**

Waivers to established criteria must be submitted to the AHJ for determination. The waiver must demonstrate that the criteria cannot be technically executed, or execution of the criteria will increase a hazard or create a new hazard and no technical alternatives exist. Written request for waivers must include justification, hazards analysis, cost comparison, alternatives considered, and other pertinent data. Lack of funds or cost savings are not considered sufficient justification for deviation from established criteria. Waivers must only apply to the specific facility or project involved and do not constitute blanket approval for similar cases.

#### 1-3.9 **Antiterrorism Standards.**

Design the facility to comply with UFC 4-010-01, *DoD Minimum Antiterrorism Standards for Buildings* and UFC 4-020-01, *DoD Security Engineering Facilities Planning Manual*. Antiterrorism requirements must not preclude any fire protection requirements.

#### 1-4 **DESIGN ANALYSIS.**

A fire protection design analysis is required for all designs and must address the fire protection requirements of the project as required by this UFC. Summarize the fire protection design analysis and submit with the first design submission separate from other disciplines. Where applicable, discuss the following minimum fire protection provisions (include required vs. provided):

- a. Building code analysis (i.e., type of construction, height and area limitations, and building separation or exposure protection)
- b. Classification of occupancy,
- c. Compliance with UFC 3-600-01 and *National Fire Codes*,
- d. Requirements for fire-rated walls, fire-rated doors, fire dampers with their fire-resistive ratings, smoke compartmentation, smoke barriers
- e. NFPA 101, Life Safety Code
- f. Analysis of automatic sprinkler systems and suppression systems and protected areas, including hydraulic analysis of required water demand,
- g. Water supplies, water distribution, location of fire hydrants,

- h. Smoke control methods and smoke control systems,
- i. Fire alarm system (the type of alarm system and location of the fire alarm equipment),
- j. Fire detection system (the type of detection system and location of detectors),
- k. Standpipe systems and fire extinguishers,
- l. Interior finish ratings,
- m. Connection to and description of base fire alarm reporting system.
- n. Identify the various occupancies and hazardous areas associated with the facility,
- o. Coordination with security and antiterrorism requirements,
- p. Fire Department access.

**Note:** When directed by the cognizant fire protection engineer (FPE), projects with little or no fire protection considerations may not require a fire protection design analysis.

#### 1-4.1 **100% Design Submission.**

The project FPE must review the 100% design submission of plans and specifications and certify in writing that the design is in compliance with this UFC and all applicable criteria. This certification letter must be submitted with the 100% submission.

#### 1-5 **SERVICES AND QUALIFICATIONS OF FIRE PROTECTION ENGINEERS.**

Major projects require the design services and review of a qualified fire protection engineer. Projects involving design or modification of, fire rated construction, fire detection, fire suppression, or life safety systems require the services and review of a qualified fire protection engineer. A qualified fire protection engineer is an integral part of the design team, and must be involved in every aspect of the design as it relates to fire protection. This includes, but is not limited to, building code analysis, life safety code analysis, design of automatic detection and suppression systems, water supply analysis, and a multi-discipline review of the entire project. For the purposes of meeting this requirement, a qualified fire protection engineer is defined as an individual meeting one of the following conditions:

**UFC 3-600-01**  
**26 September 2006**

- A registered professional engineer (P.E.) who has passed the fire protection engineering written examination administered by the National Council of Examiners for Engineering and Surveys (NCEES).
- A registered P.E. in a related engineering discipline with a minimum of 5 years experience, dedicated to fire protection engineering that can be verified with documentation.

**Exception:** For **Navy**, a qualified fire protection engineer is defined as a registered professional engineer (P.E.) who has passed the fire protection engineering written examination administered by the National Council of Examiners for Engineering and Surveys (NCEES).

#### 1-6 **FIRE PROTECTION DURING CONSTRUCTION.**

Contract specifications must reference the Army Corps of Engineering Manual (EM), EM 385-1-1, *Safety and Health Requirements Manual*, and *NFPA 241, Safeguarding Construction, Alteration, and Demolition Operations*, and must contain the requirement that the activity's fire regulations be followed.

**Note:** For **Navy** projects, Unified Facilities Guide Specification (UFGS) 01525, *Safety and Occupational Health Requirements*, must be used.

**CHAPTER 2 BUILDING CONSTRUCTION****2-1 BASIC CRITERIA.**

Conform building construction to fire resistance requirements, allowable floor area, building height limitations, and building separation distance requirements of the IBC, except as modified by this UFC.

**2-1.1 Egress and Safety to Life.**

Comply with NFPA 101 for building construction related to egress and safety to life. For conflicts between the IBC and NFPA 101 related to fire resistance rating, conform to NFPA 101 and applicable criteria contained in this UFC. Appendix E provides a cross reference between the construction types referenced in NFPA 220, *Types of Building Construction* and the IBC.

**2-1.2 Partitions.**

The IBC fire resistance requirements for permanent partitions do not apply to non-bearing partitions. For fire resistance ratings of non-bearing partitions, comply with NFPA 101. Occupancy separation must comply with the "Required Separation of Occupancies" table in the IBC.

**2-1.3 Type of Construction.**

Follow the requirements of the IBC to determine the permitted types of construction.

**Exception:** Type V (wood) roofs may be constructed on buildings of Type I or II construction, provided that they are separated from all other areas of the building by horizontal 2-hour concrete or masonry fire resistive construction. These roofs will not require sprinkler protection but will require draft stops to divide the spaces into areas not exceeding 280 m<sup>2</sup> (3,000 ft<sup>2</sup>). Provide self-closing and latching access doors of similar construction in the draft stop where there is no other means of access to the area.

**2-1.4 Separation Between Buildings.**

Use the IBC to determine required separation distances between buildings except as modified by this UFC.

**2-1.4.1 Manufactured Homes.**

Separate house trailers in accordance with NFPA 501A, *Fire Safety Criteria for Manufactured Home Installations, Sites, and Communities*.

**2-1.4.2 Relocatables.**

Relocatable facilities must have the same fire protection, construction and separation requirements as non-relocatable facilities.

2-1.4.2.2 Provide a minimum separation of 15.3 m (50 ft) between groups of extra hazard occupancy, and 4.6 m (15 ft) for all other groups.

## 2-2 FIRE AREAS.

Conform to the IBC, except as modified by this UFC. Exceptions for specific occupancies are listed in Chapter 6 of this UFC.

2-2.1 Do not group mission critical relocatable facilities such as electronic equipment vans to form areas greater than 557 m<sup>2</sup> (6,000 ft<sup>2</sup>) for unsprinklered facilities and 1115 m<sup>2</sup> (12,000 ft<sup>2</sup>) for sprinklered facilities.

2-2.2 Do not group relocatable facilities having extra hazard occupancies as defined by NFPA 13, *Installation of Sprinkler Systems*, to form areas greater than 372 m<sup>2</sup> (4,000 ft<sup>2</sup>) for unsprinklered facilities and 743 m<sup>2</sup> (8,000 ft<sup>2</sup>) for sprinklered facilities.

## 2-3 BUILDING HEIGHT LIMITATIONS.

Conform to the IBC, except as modified by this UFC.

## 2-4 LIMITING INTERIOR FIRE SPREAD

### 2-4.1 Door Openings.

Door openings, in fire resistive construction, must be protected in accordance with NFPA 80, *Fire Doors and Fire Windows*. Fire door assemblies are required on each side of the door opening in 4-hour fire walls when openings are fitted with 3-hour rolling or sliding fire doors. Use fire doors listed by Underwriters Laboratories Inc. (UL), FM, or a nationally recognized testing laboratory (NRTL). Do not modify approved fire doors in the field. Local fabrication of fire doors is not permitted.

### 2-4.2 Penetrations.

The protection of ducts at point of passage through firewalls must be in accordance with NFPA 90A, *Installation of Air-Conditioning and Ventilating Systems*, and/or NFPA 90B, *Installation of Warm Air Heating and Air-Conditioning Systems*. All other penetrations, such as piping, conduit, and wiring, through firewalls must be protected with a material or system of the same hourly rating that is listed by UL, FM, or a NRTL.

## 2-5 MEANS OF EGRESS

### 2-5.1 Requirements.

Comply with the requirements of NFPA 101, except as modified by this UFC.

## 2-5.2 **Means of Egress Marking.**

Mark means of egress in accordance with NFPA 101. Signs must have lettering on an opaque background. Internally illuminated signs must be light emitting diode (LED) type, electroluminescence (LEC), or cold cathode type. Incandescent fixtures are not permitted except existing fixtures, which may remain in use.

**Exception:** In overseas locations; additional markings may be required to remain consistent with local national standards; colors may be consistent with local national standards, and bilingual signs are permitted.

### 2-5.2.1 **Radioluminous Exit Signs.**

Radioluminous exit signs in DOD facilities are not permitted.

### 2-5.2.2 **Photoluminescent Exit Signs.**

Photoluminescent exit signs and egress path marking is permitted only where provided with a reliable external illumination (charging) source providing a minimum illumination of 54 lux (5 foot-candles) of unfiltered fluorescent light.

**Note:** External illumination source must be energized at all times during building occupancy. Such lighting must not be controlled by automatic timers, automatic sensors including area occupancy sensors, or accessible manual switches. Controls for such lighting must be accessible only to authorized personnel. Photoluminescent signs must only be installed indoors and must not be exposed to direct sunlight, liquid spray, or temperatures outside of the range of +10 to 40°C (50 to 104°F). The legible viewing distance must be limited to 15.3 m (50 ft).

## 2-6 **INTERIOR FINISH**

### 2-6.1 **Interior Wall and Ceiling Finish.**

Wall and ceiling finishes, and movable partitions must conform to the requirements of NFPA 101 for interior finishes.

2-6.1.1 Drop-out ceilings (foam-grid panels) are not permitted.

### 2-6.2 **Interior Floor Finish.**

Conform to the requirements of NFPA 101.

## 2-7 **INSULATION**

**2-7.1 Requirements.**

Use thermal and acoustical insulation with a flame spread (FS) rating not higher than 75, and a smoke developed (SD) rating not higher than 150 when tested in accordance with ASTM E84 (NFPA 255), *Standard Method of Test of Surface Burning Characteristics of Building Materials*. Test cellular plastic insulation in the same densities and thicknesses as the material that will be used in construction applications.

**2-7.2 Exceptions to Insulation Criteria.**

For certain types of insulation installation, the exceptions described in paragraphs 2-7.2.1 and 2-7.2.2 apply.

**2-7.2.1 Flame Spread - No Smoke Developed Rating Limitation.**

Compliance with the SD rating limitation is not required, and a FS rating up to 100 is permitted for insulation, including insulating sheathing installed within wall assemblies. In such installations, conform the interior finish materials to paragraph 2-6 with a minimum fire-resistance rating of 15 minutes when tested in accordance with ASTM E119, *Standard Test Methods for Fire Tests of Building Construction and Materials*.

**2-7.2.2 No Flame Spread or Smoke Limitation.**

Compliance with FS and SD limitations are not required for the following applications:

- Insulation installed above poured concrete or poured gypsum roof decks, nominal 50.8 mm (2-inch) thick tongue-and-groove wood plank roof decks, or precast roof deck panels or planks that are approved by a NRTL, as noncombustible roof deck construction.
- Insulation installed above roof decks where the entire roof construction assembly, including the insulation, is UL listed as Fire Classified, or FM approved for Class I roof deck construction or equal listing or classification by a NRTL.
- Insulation contained entirely within panels where the entire panel assembly used in the construction application meets the cited FS and SD limitations.
- Insulation isolated from the interior of the building by masonry walls, masonry cavity walls, insulation encased in masonry cores, or concrete floors.



- Insulation installed over concrete floor slabs and completely covered by wood tongue-and-groove flooring without creating air spaces within the flooring system.
- Insulation completely enclosed in hollow metal doors.
- Insulation installed between new exterior siding materials and existing exterior siding or wood board, plywood, fiberboard, or gypsum exterior wall sheathing.

**Note:** The exception to SD limitations described in this paragraph is not applicable to hospitals and correctional facilities.

## 2-8 **ROOF COVERINGS AND ROOF DECK ASSEMBLIES**

### 2-8.1 **Roof Coverings.**

Use roof coverings approved and listed by a NRTL. The UL Roofing Materials and Systems Directory lists three Classes (A, B, and C) of acceptable roof coverings based on compliance with UL 790, *Tests for Fire Resistance of Roof Covering Materials* and NFPA 256, *Fire Tests of Roof Coverings*. Restrict Class C roof coverings to housing and buildings under 744 m<sup>2</sup> (8,000 ft<sup>2</sup>) and that are not mission essential.

### 2-8.2 **Roof Deck Assemblies.**

Roof deck assemblies must be FM Class I approved, or UL listed as Fire Classified or equal listing or classification by an NRTL.

- Exception 1: Fully sprinklered buildings.
- Exception 2: Buildings less than 744 m<sup>2</sup> (8,000 ft<sup>2</sup>).

## 2-9 **ROOF ACCESS.**

All enclosed exit stairs that extend to the top floor in any building three or more stories in height must have, at the highest point of the stair tower, an approved hatch opening to the roof with an appropriate ladder that conforms to 29 CFR 1910.27, *Fixed Ladders*. The hatch must be not less than 1.5 m<sup>2</sup> (16 ft<sup>2</sup>) in area, with a minimum dimension of 610 mm (2 ft). At least one stairway must terminate at a standard door opening leading onto the roof surface, unless the roof has a slope greater than 4 in 12.

## 2-10 **FIRE DEPARTMENT (EMERGENCY) VEHICLE ACCESS.**

### 2-10.1 **All-Weather Ground Access.**

All buildings greater than 465 m (5,000 sq ft), or more than two stories in height must have at least one means of all-weather ground access to allow emergency vehicles unimpeded access to the building. All-weather ground access must be paved, start from the road, and terminate no farther than 10 m (33 ft) from the building.

**Exception:** An engineered all-weather surface that is not paved may be provided if approved by the AHJ.

#### 2-10.1.1 **Access to Residential Facilities.**

Residential facilities must be provided with all-weather ground access to 3 sides, with a minimum of 2 sides having access to sleeping rooms.

#### 2-10.2 **Vehicle Access.**

All force protection equipment, such as bollards or gates, must not require more than one person to remove or open. Access may require fire apparatus to drive over a curb. Any locking device controlling vehicle access must be under control of the Fire Department or 24-hour security personnel located at the specific facility. Dimensions of fire lanes and turnarounds must comply with NFPA 1, Uniform Fire Code.

#### 2-10.3 **Aerial Apparatus Access.**

New facilities four stories or more in height and all new warehouses must be provided with suitable all-weather ground access surface for aerial apparatus on a minimum of two sides of the perimeter of the structure.

#### 2-10.4 **Fire Department Connection.**

Facilities with fire department connections for sprinkler or standpipe systems must be provided with suitable all-weather ground access surface for pumper apparatus within 45 m (150 ft) of such fire department connections.

### 2-11 **AIR HANDLING**

#### 2-11.1 **Design Requirements**

Air handling, heating, ventilation, and exhaust systems must comply with the requirements of NFPA 90A, except as modified by this UFC.

#### 2-11.2 **Corridors.**

Egress corridors must not be used as a portion of a supply, return, or exhaust air system serving adjoining areas. Air transfer opening(s) must not be permitted in walls or in doors separating egress corridors from adjoining areas.

**Exception:** Toilet rooms, bathrooms, shower rooms, sink closets, and similar auxiliary spaces may have air transfer openings, unless prohibited by NFPA 101, such as in residential occupancies.

### 2-11.3 **Plenums.**

Plenums may be used as an integral part of an air handling system only if they conform to the requirements of NFPA 90A. Under no circumstances may combustible materials be located within the plenum space. Electrical wiring passing through the space, including telephone and communication wiring, must be plenum rated or must be in metal conduit. Rooms or areas that form a plenum space or that are used as a plenum must not be occupied for any purpose except during repairs or maintenance operations to the air handling equipment.

### 2-11.4 **Smoke and Heat Vents.**

Smoke and heat vents may be considered in buildings where a high rate of heat release is anticipated during a fire. In buildings without automatic sprinklers, smoke and heat vents must be arranged to operate automatically in accordance with NFPA 204, *Smoke and Heat Venting*. In buildings with automatic sprinkler protection, smoke and heat vents must be arranged to operate in the manual mode only. Skylights are the preferred method of providing manual smoke and heat vents.

## 2-12 **PLASTIC PIPE AND CONDUIT**

### 2-12.1 **Penetrations.**

Penetrations by plastic pipe or conduit through fire-rated walls, partitions, shafts, and floors must be fire-stopped by an approved or listed method in accordance with ASTM E814, *Standard Test Method for Fire Tests of Through-Penetration Fire Stops* or UL 1479, *Fire Tests of Through-Penetration Firestops*.

### 2-12.2 **Prohibited Locations.**

Plastic pipe and conduit must not be installed in exit stair enclosures, or in air plenum spaces unless specifically listed for that application.

## 2-13 **FIRE RETARDANT TREATED (FRT) PLYWOOD**

### 2-13.1 **New Construction.**

Use of FRT plywood is prohibited, except as permitted by the IBC. FRT plywood must not be used in any part of the roof or roofing system.

### 2-13.2 **Existing Construction.**

**UFC 3-600-01**  
**26 September 2006**

FRT plywood installations should be regularly inspected for structural integrity. Replacement of damaged FRT plywood may require additional fire protection measures if FRT plywood is replaced with more combustible materials.

**CHAPTER 3 WATER SUPPLY FOR FIRE PROTECTION****3-1 WATER DEMANDS FOR SPRINKLERED FACILITIES****3-1.1 Factors Influencing the Water Demand for Sprinklers.**

The water demand required for sprinkler protection depends upon occupancy, discharge density, design area, and type of sprinkler system (wet or dry), type of construction, and other building features.

**3-1.2 Water Demand for Sprinklers.**

The water demand required for sprinklers must be determined from Table 4-1.

**3-1.2.1 Design Densities.**

Design densities indicated in Table 4-1 are minimum densities, and each sprinkler in the design area must discharge at least the flow rate required to produce the stipulated density.

**3-1.2.2 Design Area.**

Design areas shown in Table 4-1 are the hydraulically most remote areas.

**3-1.3 Water Demand for Hose Streams.**

Hose streams are needed concurrently with sprinkler discharge in order to effect final extinguishment or to wet down adjacent structures. The hose stream demand for sprinklered occupancies must be determined from Table 4-1.

**3-1.4 Total Water Demand for Sprinklered Occupancies.**

The total water demand for sprinklered occupancies is equal to the sum of the domestic/industrial demand plus the sprinkler system(s) water demand and the hose stream(s) demand. The total demand must be available at the sprinkler system connection to the underground main, and at the pressure necessary to produce the required sprinkler density over the required hydraulically most remote area of sprinkler operation.

**3-1.5 Water Demand for Sprinklers (Special Facilities).**

Special requirements apply to some facilities, as indicated in paragraphs 3-1.5.1 through 3-1.5.7.

**3-1.5.1 Family Housing.**

Water demand for family housing must be the sprinkler water demand plus domestic demand and 950 L/m (250 gpm) for hose streams.

**3-1.5.2 Warehouses (Piled or Rack Storage).**

Water demands for warehouses containing rack storage or piled storage must comply with paragraph 6-11.

**3-1.5.3 Rubber Tire Storage.**

Water demands for rubber tire storage must comply with paragraph 6-11.

**3-1.5.4 Aircraft Hangars.**

Water demands for aircraft hangars must comply with paragraph 6-16.

**3-1.5.5 Aircraft Acoustical Enclosures.**

Water demands for these facilities must comply with paragraph 6-17.

**3-1.5.6 Ordnance Facilities.**

Water demands for ordnance facilities must comply with paragraph 6-10.

**3-1.5.7 Flammable and Combustible Liquid Storage.**

Water demands for flammable and combustible liquid storage facilities must conform to paragraph 6-12.

**3-2 WATER DEMANDS FOR UNSPRINKLERED FACILITIES.**

Water demands for buildings and facilities that are not fully sprinklered are based on fire department hose stream requirements.

**3-2.1 Hose Stream Demands for Unsprinklered Facilities.**

Hose stream demands and duration requirements for facilities that are not fully sprinklered are outlined in Appendix C. The following factors affect the water demand and duration and must be considered to determine the specific demand and duration within a given range in accordance with Appendix C:

- Occupancy classification,
- Response time by fire department,
- Type of construction,
- Number of stories,
- Separation distances,
- Building floor area, and

- Firefighting access.

#### 3-2.1.1 **Procedure.**

The procedure for determining specific fire flow demands and duration within a range is provided in Appendix C. This procedure must be followed to determine the minimum requirements for facilities that are not fully sprinklered.

#### 3-2.1.2 **High Demands.**

When the required fire flow demand exceeds 7,570 L/m (2,000 gpm), a cost and benefit analysis must be conducted to determine if additional fire protection systems, features, or design changes that provide more favorable factors, such as type of construction or sprinkler protection, are more cost effective than providing the required fire flow.

#### 3-2.2 **Hose Stream Demand for Unsprinklered Special Facilities.**

Special requirements may apply to certain facilities. Such facilities include ship berthing and drydock facilities, family housing, petroleum oil lubricant (POL) areas, aircraft parking and refueling areas, and vehicle and yard storage. See below.

##### 3-2.2.1 **Ship Berthing and Drydock Facilities.**

Refer to paragraph 6-13 for water demand requirements for ship berthing and drydock facilities.

##### 3-2.2.2 **Family Housing.**

The water demand for unsprinklered family housing must be as follows:

- One-story - 1,900 L/min (500 gpm) for 90 minutes.
- Two-story - 2,840 L/min (750 gpm) for 90 minutes.
- Three-story and above - 3,785 L/min (1,000 gpm) for 90 minutes.

##### 3-2.2.3 **Petroleum Oil Lubricant (POL) Areas.**

POL areas must conform to the following:

- Aboveground Atmospheric POL Tanks. Table 3-1 provides fire flow rates for non-pressurized POL tanks.
- Aboveground Pressurized POL Tanks. Table 3-2 provides fire flow rates for pressurized POL tanks.

**Table 3-1 Atmospheric POL Tank Cooling Water**

TANK DIAMETER		FIRE FLOW RATE	
FEET	METERS	GPM	L/MIN
0 - 64	0-19	500	1900
65 - 119	20 - 35	750	2840
120 - 154	36 - 46	1,000	3,785
155 - 199	47 - 61	1,250	4,740
200 or greater	61 or greater	1,500	5,680
Minimum duration: 240 minutes.			
Note: Provide an additional 1,900 L/min (500 gpm) for each exposed tank, pressure vessel or handling facility within 15.3 m (50 ft) or one tank diameter, whichever is greater, of the largest tank under consideration. The maximum water supply for storage tanks must not exceed 9,465 L/m (2,500 gpm).			



**Table 3-2 Pressurized POL Tank Cooling Water**

TANK GROUP SIZE	FIRE FLOW RATE L/MIN (GPM)
Single tank less than 113,550 L (30,000 gallon) capacity.	950 (250)
Single tank more than 113,550 L (30,000 gallon) capacity.	1900 (500)
2 to 6 tanks, one or more tanks greater than 113,550 L (30,000 gallon) capacity.	1900 (500)
2 to 6 tanks, each greater than 113,550 L (30,000 gallon) capacity.	3795 (1,000)
7 or more tanks, each tank less than 113,550 L (30,000 gallon) capacity.	3785 (1,000)
7 or more tanks, one or more tanks greater than 113,550 L (30,000 gallon) capacity.	5680 (1,500)
Minimum duration: 240 minutes	

### 3-2.3 Aircraft Parking and Refueling Facilities.

A minimum fire flow rate of 3,785 L/min (1,000 gpm) for a 2-hour duration is to be provided for all such facilities.

### 3-2.4 Yard and Outdoor Storage.

Yard and outdoor storage must be protected in accordance with NFPA 80A, *Protection of Buildings from Exterior Fire Exposures*, NFPA 13, and FM Global Data Sheet 1-20, *Protection Against Exterior Fire Exposure*. Aisle widths and separation distances must be maintained to limit the exposure to nearby buildings and to facilitate manual fire fighting operations.

### 3-2.5 Vehicle Parking Areas.

A minimum fire flow rate of 1900 L/m (500 gpm) for a 2-hour duration must be provided for all such facilities.

## 3-3 WATER SUPPLY PRESSURE REQUIREMENTS

### 3-3.1 Pressure Required.

Pressure required for sprinklered facilities must be the most demanding pressure of the domestic/industrial demand, sprinkler demand, or hose stream demand and must be determined by hydraulic calculations.

### **3-4 QUANTITIES OF WATER REQUIRED.**

Requirements for fire protection water storage are based on the assumption that there will be only one fire at a time. The quantity of water required is equal to the product of the fire protection water demand and the required duration. This quantity represents fire protection requirements only, and must be available at all times. Water supply for domestic, industrial, and other demands must be added to these requirements to determine the total amount of water that is necessary at a facility.

#### **3-4.1 Total Storage Capacity.**

The total supply stored for fire protection purposes must be sufficient to meet the maximum required fire flow demand for the durations specified in this UFC.

#### **3-4.2 Reduction in Storage Capacity.**

In computing the fire protection storage requirement, a reduction in storage capacity is acceptable if an adequate replenishment source is available. Factors that must be evaluated include the reliability of the makeup facility, its sustained flow capacity, its method of operation (automatic or manual), and flow limitations imposed by the capacity of treatment operations. These factors and calculations must be reviewed and approved by the cognizant Fire Protection Engineer.

#### **3-4.3 Replenishment of Storage.**

The water storage must be self-replenishing. It must reach required volume during normal consumption within 48 hours, and within 24 hours curtailing normal consumption.

### **3-5 WATER FOR FIRE PROTECTION.**

One or more of the following reliable means shall provide water to an installation for fire protection:

- Multiple connections to looped or gridded public water distribution system(s) arranged so that during any single-point failure, at least 50% of the maximum required fire flow demand plus 100% of domestic demand can still be supplied to the activity / facility.
- A single connection to a public water distribution system, plus on-site storage that is adequate to supply domestic demand for 24 hours plus the maximum required fire flow demand in the event the connection to the public system is lost.

- One or more on-site sources, such as wells or open bodies of water, with treated water storage capacity adequate to supply domestic demand for 24 hours plus the maximum required fire flow demand.
- For a small, non-mission-essential activity, such as a reserve training center, a single connection to a looped or gridded public water distribution system, capable of providing concurrent domestic and fire flow demands to the facility, is acceptable.

### 3-5.1 **On-Site Storage.**

Where on-site storage is part of a sole-source water supply, or is needed to provide the required fire flow, the storage facilities must be divided into two or more approximately equal capacity tanks or reservoir sections, arranged so that at least one-half of the water supply will always be available during tank or reservoir maintenance. The discharge or suction line(s) from each individual tank or reservoir section shall be sized to deliver the maximum required fire flow.

**Exception:** Existing water storage facilities deemed reliable by the AHJ may be acceptable.

### 3-5.2 **Monitoring**

Water level must be remotely monitored in accordance with NFPA 22 and NFPA 72 at a constantly attended location, preferably at the installation's fire and security dispatch center. In locales subject to freezing, water temperature of above-ground storage tanks must likewise be monitored at a constantly-attended location.

## 3-6 **FIRE PUMPS.**

### 3-6.1 **Requirements.**

Pumps for fire protection must have adequate capacity with reliable power and water supply. This equipment must conform to requirements of NFPA 20, *Standard for the Installation of Stationary Pumps for Fire Protection*. Fire pumps, drivers, and other equipment including automatic accessories must be listed by UL, approved by FM, or listed or classified by an NRTL.

3-6.1.1 Fire pumps must be located in a detached, noncombustible pump house or located in a fire rated room in accordance with NFPA 20 and must have direct access from the exterior.

3-6.1.2 For mission critical facilities, provide a reserve fire pump of the same size when the water supply cannot support 25% of the sprinklers in the hydraulically most remote design area with the primary fire pump out-of-service.

**Exception:** For **DLA**, a reserve fire pump of the same size must be provided whenever a fire pump is required.

### 3-6.2 **Pump Type.**

A fire pump may be either a horizontal or vertical shaft centrifugal pump or a vertical shaft turbine pump; whichever is most economical and appropriate for the intended use. A centrifugal pump in either the horizontal or vertical position must not be used where suction lift is required. A vertical shaft turbine pump must be used for suction lift.

### 3-6.3 **Pump Starting Arrangement.**

Fire pumps must be arranged to start automatically. Fire pumps may be arranged for manual starting when other available water supply sources are capable of providing demands for automatic sprinkler systems simultaneously with domestic and industrial demands.

#### 3-6.3.1 **Pump Shut Down.**

Once started, fire pumps must be arranged to run until shut down manually.

**Exception 1:** Operation by automatic periodic exercise timers used for the required preventive maintenance run times.

**Exception 2:** Automatic shut down upon total exhaustion of suction reservoir water may be permitted.

### 3-6.4 **Pump Drive.**

Electric power supply(ies) for pumps used in fire protection service must comply with NFPA 20. Where electric power is economically available from a reliable single source of adequate capacity or from two independent sources each of adequate capacity, pumps may be electric driven. When such electrical power supplies are not available, fire pumps must be diesel driven. Spark ignited internal combustion engines must not be used to drive fire pumps.

**Exception:** A diesel driven fire pump does not have to be provided when the fire pump is equipped with an automatic transfer switch and connected to an emergency generator.

**Note:** A reliable single power source is defined as a power source having an average forced down time, excluding scheduled repairs, which does not exceed 8 consecutive hours for any one incident nor more than 24 hours cumulatively over the last 3 years.

### 3-6.5 **Pump Bypass.**

Provide a bypass in accordance with NFPA 20 around all booster fire pumps (fire pumps which take suction from a pressurized source for the purpose of boosting pressure).

### 3-6.6 **Backflow Preventer.**

Where a backflow preventer is required for a fire pump installation, it should be located on the discharge side of the pump. The location of the backflow preventer needs to be coordinated with local environmental requirements.

## 3-7 **WATER DISTRIBUTION SYSTEMS.**

### 3-7.1 **Distribution Mains.**

The distribution system must be sized to accommodate fire flows plus domestic and industrial or flushing demands that cannot be restricted during fires. Distribution must be looped to provide at least 50 percent of the required fire flow in case of a single break. Dead-end mains must be avoided. Distribution systems must be designed in accordance with American Water Works Association Manual M31 *Distribution System Requirements for Fire Protection*, NFPA 24, *Installation of Private Fire Service Mains and Their Appurtenances*, and UFC 3-230-10A, Design: *Water Supply, Water Distribution*.

### 3-7.2 **Valves.**

Control valves must be provided in each source of water supply, such as tanks and pumps. Control valves must be either post-indicating or outside-stem-and-yoke types. A sufficient number of sectional valves must be provided so that not more than a combined total of five hydrants and sprinkler systems, or not more than three sprinkler systems must be out of service due to a single break. Sectional valves may be key-operated type. New valves must open by counter-clockwise rotation of the stem.

#### 3-7.2.1 **Drawings.**

Drawings must be provided showing control and sectional valve locations and valve sizes. Existing left-hand valves must be clearly indicated on drawings.

### 3-7.3 **Hydrants.**

Fire hydrants must be UL listed, FM approved, or listed or classified by an NRTL and must have two 65 mm (2-1/2-inch) hose outlets and one 115mm (4-1/2-inch) suction connection with national standard fire hose threads in accordance with NFPA 24 and NFPA 1963, *Fire Hose Connections*. Wet-barrel or California-type hydrants are preferable in areas where there is no danger of freezing. Dry barrel or traffic-type hydrants must be used in areas where there is a danger of freezing. Hydrants must be aboveground type. If local municipal departments use nonstandard connections, adapters must be made and supplied to engine

companies that respond to DOD installation fires. In DOD installations serviced by only local fire departments, hydrant hose threads must meet local requirements.

**Note 1:** Overseas bases with current below grade hydrants in accordance with local national policy are acceptable.

**Note 2:** For **Navy** projects, a 100 mm (4-inch) suction connection must be provided for facilities that have existing fire hydrants with 100 mm (4-inch) suction connection.

### 3-7.3.1 Hydrant Color Coding.

At facilities which have hydrants on both potable and non-potable water systems, fire hydrants must be color coded to avoid cross-connections during firefighting. Hydrant barrels shall be red for non-potable water and yellow for potable water. Regardless of water source, hydrant bonnet and cap color shall be in accordance with NFPA 291, *Fire Flow and Marking of Hydrants*, based on flow capacity.

**Exception:** Hydrants at DoD facilities serviced only by local civilian fire departments shall comply with the requirements of the local municipality.

### 3-7.3.2 Installation Requirements.

Hydrants must be installed adjacent to paved areas, accessible to fire department apparatus. Hydrants must not be closer than 1 m (3 ft) nor farther than 2.1 m (7 ft) from the roadway shoulder or curb line. Hydrants must be installed with not less than 150 mm (6-inch) connection to the supply main, and valved at the connection. Barrels must be long enough to permit at least 450 mm (18-inch) clearance between the center of the 115 mm (4-1/2-inch) suction connection and grade. The ground must be graded so that any surface drainage is away from the hydrant. Installation must be in accordance with NFPA 24, except as modified by this UFC. Suction connection should be perpendicular to the street to allow straight lined connection to the pumper. At airfields, the tops of the hydrants should not be installed more than 610 mm (24 inches) above the level of the adjacent airfield pavement but in no case must the tops of the hydrants be installed higher than 760 mm (30 inches) above the airfield pavement.

### 3-7.3.3 Spacing Requirements.

A sufficient number of hydrants must be provided so that hose stream demand can be met without taking more than 4,740 L/min (1,250 gpm) from any single hydrant. Hydrants must also be spaced in accordance with the following requirements:

- All parts of the building exterior must be within 106 m (350 ft) of a hydrant with consideration given to accessibility and obstructions.

Hydrants must be located with consideration given to emergency vehicle access.

- At least one hydrant must be located within 45 m (150 ft) of the fire department connection.
- Hydrants protecting warehouses must be spaced a maximum of 91 m (300 ft) apart.
- Hydrants protecting aircraft hangars must be located at 91 m (300 ft) maximum intervals, and there must be at least one hydrant at each corner of the hangar.
- Hydrants protecting POL storage and distribution facilities must be spaced at 91 m (300 ft) maximum intervals. Provide a minimum of two hydrants. Locate hydrants so that protected exposures can be reached by hose lays not exceeding 91 m (300 ft) in length.
- Hydrants protecting aircraft parking and servicing aprons must be spaced at 91 m (300 ft) maximum intervals along one side.
- Hydrants protecting exterior storage must be spaced at 91 m (300 ft) maximum intervals around the perimeter.
- Hydrant spacing must not exceed 182 m (600 ft) for housing developments without sprinkler protection. Hydrant spacing must not exceed 305 m (1,000 ft) for housing developments with sprinkler protection.

#### 3-7.3.4 **Hydrant Protection.**

Hydrants located adjacent to parking areas or other vehicle traffic areas, must be protected by bollards. The bollards must be located so they are not directly in front of an outlet.

#### 3-7.4 **Pressure-Regulating Valves (PRVs) .**

PRVs are restricted in use on fire protection water systems by NFPA 24. Where essential, PRVs must be installed on individual services rather than on the main piping. Where PRVs are provided in distribution mains supplying systems or portions of systems with fire hydrants, automatic sprinkler systems, or other installed fire protection, the following features must be provided to safeguard against failures and to facilitate maintenance:

- Control valves on each side of the PRVs.
- Bypasses around PRVs.

### 3-7.5 **Backflow Prevention and Cross Connection Control**

The installation of backflow prevention and cross connection control must comply with the AWWA Manual M14, *Recommended Practice for Backflow Prevention and Cross Connection Control*.

#### 3-7.5.1 **Fire Suppression Systems.**

When backflow preventers are provided on a fire suppression system, NFPA 13 requires backflow preventers that are approved or listed for fire protection use by acceptable testing agencies such as Underwriters Laboratories or Factory Mutual. Because pressure loss through a valve can degrade the effectiveness of a fire suppression system, design and submittal acceptance must ensure the rated working flow rate of the valve selected or installed meets the flow requirements of the system. Perform backflow prevention retrofit work when systems are down for major renovation unless the threat dictates otherwise.

##### 3-7.5.1.2 **For systems connected to a potable water supply:**

For new fire suppression system using water only as a fire suppressant, follow base requirements for backflow prevention.

Install a reduced pressure type backflow device where antifreeze or other chemicals are added into the system.

#### 3-7.5.2 **Retrofit on Fire Suppression Systems.**

When backflow preventers are installed in an existing sprinkler system, a thorough hydraulic analysis, including hydraulic calculations and flow test, must be performed on the sprinkler system to ensure that the water supply is still adequate for the system with the backflow preventer. If the backflow preventer causes the demand to exceed the water supply, the backflow preventer must not be installed until the water supply is corrected to support the new demand.

#### 3-7.5.3 **Test Connection.**

When backflow preventers are installed in fixed fire protection systems, test connection must be provided downstream of all backflow prevention valves for flow tests at system demand.

#### 3-7.6 **Meters.**

Where meters are installed on fire sprinkler and hose stream water distribution systems, they must be listed by an NRTL as fire flow meters.



**CHAPTER 4 FIRE EXTINGUISHING SYSTEMS****4-1 GENERAL****4-1.1 Connections to Fire Reporting Systems.**

Where fire suppression systems are installed in or at facilities on installations with station or base fire reporting systems, the fire suppression systems must be connected to the fire reporting system for transmission of fire alarms, trouble signals and supervisory signals.

**4-1.2 Plans and Calculations.**

For new systems or modified systems, construction (shop) drawings and calculations must be prepared by an individual that has obtained National Institute for Certification in Engineering Technologies, Automatic Sprinkler Systems, Level III certification or Special Hazards Suppression Systems, Level IV certification, in accordance with the applicable NFPA code. A registered professional engineer licensed to practice fire protection engineering must stamp the shop drawings prior to submitting the fire extinguishing system shop drawings to the appropriate components designated Fire Protection Engineer.

**4-1.3 Water Flow Testing.**

Conduct water flow tests, in accordance with the procedures contained in NFPA 291, to determine available water supply for the water-based fire extinguishing systems. The preparer of the contract documents (a fire protection engineer or an engineer experienced in water flow testing) must perform or witness the required flow testing prior to the first submission of the project. Advertisement of the project must not be permitted before water flow tests are accepted. Historical water supply information must not be accepted.

**4-2 AUTOMATIC SPRINKLER SYSTEMS.****4-2.1 Characteristics.**

Properly engineered and installed automatic sprinkler systems are designed to detect the presence of fire, activate both local and remote (fire department) alarms, and distribute water in sufficient quantity to either control or extinguish the fire. Sprinkler specifications must include provisions regarding sprinkler contractor qualifications.

**4-2.2 Application Requirements.**

Complete automatic sprinkler protection must be provided in all new or renovated DOD facilities.

**Exception:** Non-mission essential buildings of Type I or II construction less than 1,394 m<sup>2</sup> (15,000 ft<sup>2</sup>) gross floor area or Type III, Type IV and Type V construction less than 465 m<sup>2</sup> (5,000 ft<sup>2</sup>) do not require automatic sprinkler protection unless specified by Chapter 6.

4-2.2.1 For additions or partial renovations of existing buildings, the entire gross floor area of the building must determine if sprinkler protection needs to be included in the project. The addition or portion of the building being renovated must include sprinkler protection and be designed to support sprinklers for the remainder of the building when it is renovated.

#### 4-2.3 **Design Requirements.**

Sprinkler systems must use equipment and devices listed by a NRTL.

##### 4-2.3.1 **Sprinkler Density and Hose Stream Requirements.**

Building and structures requiring sprinkler protection must be provided with sprinkler systems that are designed using the Area/Density Method of NFPA 13, except that the design density, design area, hose stream allowance and duration of supply requirements must be in accordance with Table 4-1.

##### 4-2.3.2 **Piping.**

Installations must evaluate the water quality (pertaining to corrosion) to determine if Schedule 10 steel pipe can be used for sprinkler system piping greater than 50mm (2-inches). Water quality analysis must evaluate both micro-biological and galvanic corrosion. Evidence of either corrosion potential or past history of sprinkler system failure due to corrosion would prohibit the use of Schedule 10 pipe. For dry-pipe and preaction sprinkler systems, use Schedule 40 steel piping for all sizes without exception.

**Exception:** For **DLA**, use Schedule 40 steel piping for all sprinkler systems.

**Table 4-1 Sprinkler System and Water Supply Design Requirements for Sprinklered Facilities**

OCCUPANCY CLASSIFICATION <sup>a</sup>	SPRINKLER SYSTEM		HOSE STREAM ALLOWANCE L/Min (GPM)	DURATION OF SUPPLY Minutes
	DESIGN DENSITY L/min/m <sup>2</sup> (GPM/ft <sup>2</sup> )	DESIGN AREA m <sup>2</sup> (ft <sup>2</sup> ) <sup>b</sup>		
Light Hazard	4.1 (0.10)	280 (3000)	950 (250)	60
Ordinary Hazard Group 1	6.1 (0.15)	280 (3000)	1900 (500)	60
Ordinary Hazard Group 2	8.2 (0.20)	280 (3000)	1900 (500)	90
Extra Hazard Group 1	12.2 (0.30)	280 (3000)	2840 (750)	120
Extra Hazard Group 2	16.3 (0.40)	280 (3000)	2840 (750)	120
<sup>a</sup> Refer to Appendix B for occupancy hazard classification. <sup>b</sup> See paragraph 4-2.3.3.				
<p>Note: The protection requirements identified in Table 4-1 are based on standard commercial practices followed throughout civilian industry for highly protected risk (HPR) properties. Table 4-1 represents the minimum requirements necessary to establish minimum comprehensive life, mission, and property loss prevention. Table 4-1 was adapted as a result from detailed studies by Factory Mutual of loss experience from 1956 to 1965, loss experience in selected occupancies from 1966 to 1977 and from 1981-1990, and fire test data.</p>				

#### 4-2.3.3 Sprinkler Design Area Adjustments.

4-2.3.3.1 For dry pipe systems, the design area of sprinkler operation in Table 4-1 must be increased by 30 percent as required by NFPA 13.

4-2.3.3.2 The design areas in Table 4-1 must be increased by 30 percent for sloped ceilings that exceed a pitch of one in six, as required by NFPA 13.

4-2.3.3.3 When NRTL listed quick-response sprinklers are used throughout the system, the design area in Table 4-1 may be reduced as permitted in NFPA 13, without revising the density in Table 4-1.

#### 4-2.3.4 Quick Response Automatic Sprinklers.

The use of quick response automatic sprinklers (QRAS) is limited to wet pipe systems.

#### 4-2.3.5 Hydraulic Calculations.

New sprinkler systems protecting areas of 139 m<sup>2</sup> (1,500 ft<sup>2</sup>) and greater must be designed using hydraulic calculations. Use of pipe schedule designs is strongly discouraged for any sprinkler system. Required discharge densities and areas of discharge operation are given in Table 4-1. Calculations must follow the format of NFPA 13. Pipe friction losses and equivalent lengths of pipe for fittings and valves must be in accordance with NFPA 13.

**Note:** Additions to existing pipe schedule systems may be designed using the pipe schedule method, except for **Navy** projects.

4-2.3.5.1 The designer (a fire protection engineer) must provide hydraulic calculations demonstrating that the design will provide an adequate water supply for the fire extinguishing systems. Hydraulic calculations must be submitted no later than the 35 percent design submission. Calculations must be based on recent water flow test data.

#### 4-2.3.6 **Sprinkler Coverage.**

In buildings protected by automatic sprinklers, sprinklers must provide coverage throughout 100 percent of the building except as permitted by NFPA 13. This includes, but is not limited to, telephone rooms, electrical equipment rooms, boiler rooms, switchgear rooms, transformer rooms, and other electrical and mechanical spaces. Coverage per sprinkler must be in accordance with NFPA 13, except that it must not exceed 21 square meters (225 square feet) for light hazard occupancies or 12.1 square meters (130 square feet) for ordinary hazard.

**Exception 1:** Facilities that are designed in accordance with NFPA 13R, *Installation of Sprinkler Systems in Residential Occupancies up to and Including Four Stories in Height* and NFPA 13D, *Installation of Sprinkler Systems in One- and Two-Family Dwellings and Manufactured Homes*.

**Exception 2:** Sprinklers may be omitted from small rooms in specific occupancies in accordance with NFPA 101.

#### 4-2.3.7 **Strainers.**

Strainers must be installed where water conditions warrant, or systems with underground distribution piping flow velocities greater than 2.4 m/s (8 ft/sec).

#### 4-2.3.8 **Interconnection of Risers.**

For facilities four (4) stories and taller, there must be a combination sprinkler/standpipe riser in at least two stairwells that are interconnected on each floor. Each floor control valve assembly for the sprinkler connection must include a check valve. See Figure 4-1. The sprinkler system must be hydraulically calculated using the most hydraulically demanding riser. The calculations must not assume the use of both risers simultaneously.

**Exception:** For **Army** projects, sprinkler systems are not required to be interconnected.

**Figure 4-1 Floor Control Valve Assembly**

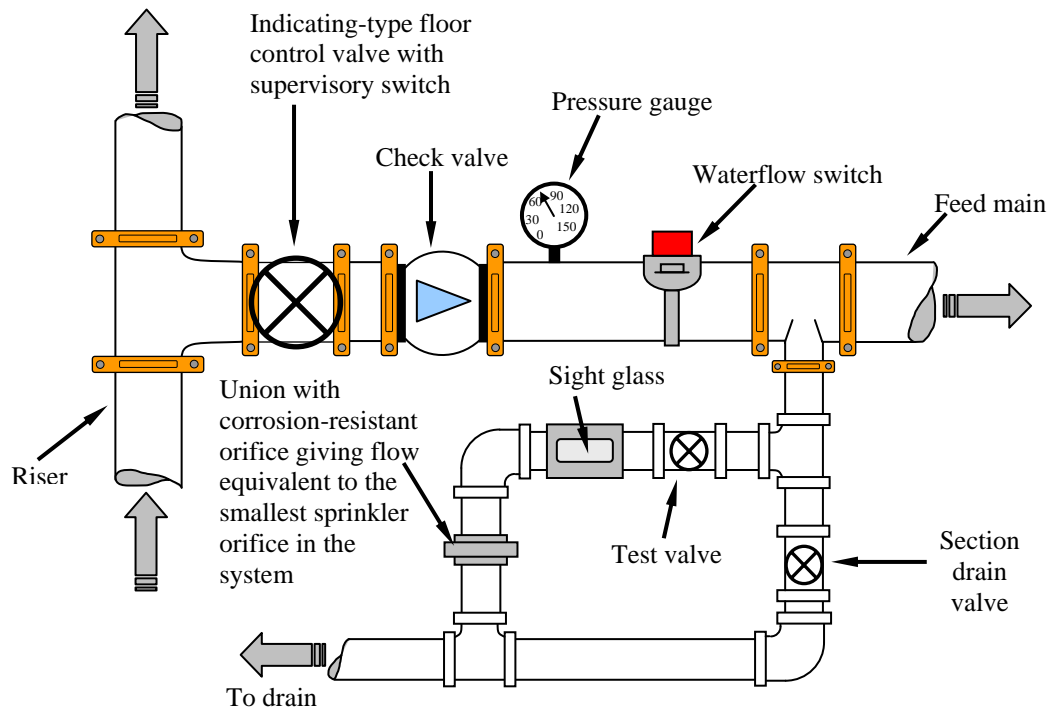

#### 4-3 WATER SPRAY SYSTEMS.

##### 4-3.1 Requirements.

Design requirements for water spray systems must conform to NFPA 15, *Water Spray Fixed Systems for Fire Protection*.

#### 4-4 FOAM SYSTEMS.

##### 4-4.1 Requirements.

Foam installations must be in accordance with NFPA 11, *Low-, Medium-, and High-Expansion Foam*, and NFPA 16, *Installation of Foam-Water Sprinkler and Foam-Water Spray Systems*. For additional information, the NFPA *Fire Protection Handbook* and FM Global Data Sheets contain data and information

concerning installation and arrangement of foam systems for various types of flammable and combustible liquids hazards.

#### 4-4.1.1 **Piping.**

The foam solution piping must use Schedule 40 steel pipe. The foam concentrate piping must use stainless steel pipe with roll grooved fittings, welded joints and fittings, or flanged joints and fittings. If using welded joints and fittings, consideration must be given to the maintenance of the system and provide flanged joints at certain locations to allow for the ease of maintenance. The trim piping on all deluge valves, flow control valves, and alarm check valves must utilize brass piping. Any concealed concentrate piping must use welded or flanged fittings

#### 4-4.2 **AFFF.**

Foam Systems that utilize AFFF must only use AFFF concentrate meeting Military Specification MIL-F-24385F, *Fire Extinguishing Agent, Aqueous Film-Forming Foam (AFFF) Liquid Concentrate, for Fresh and Seawater.*

4-4.2.1 New AFFF systems must use potable water or a water source that is supplied from a potable water system (i.e., a water storage tank that is filled from a potable water system). The use of saltwater or untreated fresh water must be approved by the AHJ.

#### 4-5 **STANDPIPE SYSTEMS.**

When required, standpipe systems must be installed in accordance with NFPA 14, *Installation of Standpipe and Hose Systems.*

**Exception:** Residual pressure requirements specified in NFPA 14 may be omitted for buildings under 45 m (150 ft) in height where fire department apparatus are expected to boost pressure in standpipe systems.

##### 4-5.1 **Class I Standpipe Systems**

Class I standpipe systems must be provided in exit stairways of buildings four stories or more in height. These systems must not include hose.

Class I standpipe systems must also be provided in facilities where it is not practical to reach major portions of the building with fire fighting hose lines extended from the exterior of the building, regardless of building height.

##### 4-5.2 **Class II and Class III Standpipes.**

Class II and Class III standpipes are not permitted.

#### 4-6 **DRY CHEMICAL EXTINGUISHING SYSTEMS.**

#### 4-6.1 **Application.**

Fixed dry chemical extinguishing systems are appropriate for the protection of certain types of special occupancies, hazards, and facilities such as dip tanks, and other operations involving flammable liquids.

#### 4-6.2 **Design Requirements.**

Dry chemical extinguishing systems must conform to NFPA 17, *Dry Chemical Extinguishing Systems*.

#### 4-6.3 **Limitations.**

Dry chemical agents should not be used to protect sensitive electronics. Dry chemical extinguishing systems are no longer UL listed or FM approved for the protection of cooking equipment.

### 4-7 **CARBON DIOXIDE SYSTEMS.**

#### 4-7.1 **Application.**

Carbon dioxide (CO<sub>2</sub>) systems are normally effective against flammable liquid (Class B) and electrical (Class C) fires. New total flooding systems are not authorized in normally occupied areas.

#### 4-7.2 **Design Requirements.**

Carbon dioxide systems must conform to NFPA 12, *Carbon Dioxide Extinguishing Systems*.

4-7.2.1 Do not locate CO<sub>2</sub> piping in any area where a pipe break or leak could make a normally occupied area untenable.

4-7.2.2 Provide a stand-alone (not dependent upon the building fire alarm system for operation) control panel that is listed for releasing device service. The building fire alarm control panel or fire alarm reporting system must monitor this releasing panel.

4-7.2.3 Careful consideration must be given to compartment under/over-pressurization during the discharge of total flooding CO<sub>2</sub> systems. Comply with NFPA 12 and the manufacturer's recommended procedures relative to enclosure venting.

4-7.2.4 Provide a manually activated exhaust system to facilitate the extraction of any remaining CO<sub>2</sub> after the required hold time of the total flooding CO<sub>2</sub> system. The exhaust system can be integrated into the HVAC system for the enclosure.

**4-8 HALON 1301 SYSTEMS.****4-8.1 Application.**

Installation of new Halon 1301 systems is prohibited except by special approval of the AHJ in the component office listed in paragraph 1-3.6.

**4-9 PORTABLE FIRE EXTINGUISHERS.**

Portable fire extinguishers must be provided where required by NFPA 101, *Life Safety Code*. Portable fire extinguishers must be located and installed in accordance with NFPA 10, *Portable Fire Extinguishers*.

**Exception:** For Industrial and Storage occupancies, provide and install extinguishers in accordance with NFPA 10.

**4-9.1 Extinguisher Cabinets.**

Recessed or semi-recessed enclosed cabinets must be provided in new or renovated facilities, except storage and industrial occupancies.

**4-10 WET CHEMICAL EXTINGUISHING SYSTEMS.****4-10.1 Application.**

Fixed wet chemical systems are suitable for protection of certain types of special occupancies, hazards, and facilities, such as cooking surfaces, cooking exhaust systems, and dip tanks.

**4-10.2 Design Requirements.**

Wet chemical systems must conform to NFPA 17A, *Wet Chemical Extinguishing Systems*.

**4-11 CLEAN AGENT FIRE EXTINGUISHING SYSTEMS.****4-11.1 Application.**

Clean agent fire extinguishing systems are suitable for protection of certain types of special occupancies, hazards, and facilities. Clean agent fire extinguishing systems are not a substitute for required automatic sprinkler systems.

**4-11.2 Design Requirements.**

Clean agent fire extinguishing systems must conform to NFPA 2001, *Clean Agent Fire Extinguishing Systems*.



4-11.2.1 Provide stand-alone (not dependent upon the building fire alarm system for operation) control panels that are listed for releasing device service and monitored by the building fire alarm system.

4-11.2.2 Careful consideration must be given to compartment under/over-pressurization during the discharge of total flooding clean agent systems. Pressure relieving vents, located near the finished ceiling, may be necessary to regulate rapid pressure changes during discharge. Comply with the manufacturer's recommended procedures relative to enclosure venting.

4-11.2.3 Provide a manually activated exhaust system to facilitate the extraction of any remaining clean agent after the required hold time of the total flooding clean agent system. The exhaust system can be integrated into the HVAC system for the enclosure.

#### 4-12 **WATER MIST FIRE PROTECTION SYSTEMS.**

##### 4-12.1 **Application.**

Water mist fire protection systems are suitable for protection of certain types of special occupancies, hazards, and facilities. Water mist fire protection systems are not a substitute for required automatic sprinkler systems.

##### 4-12.2 **Design Requirements.**

Water mist fire protection systems must conform to NFPA 750, *Water Mist Fire Protection Systems*.

4-12.2.1 Provide stand-alone (not dependent upon the building fire alarm system for operation) control panels that are listed for releasing device service and monitored by the building fire alarm system.

## CHAPTER 5 FIRE ALARM SYSTEMS

### 5-1 PLANS AND CALCULATIONS.

System working plans and calculations must be prepared and submitted for approval by a registered professional fire protection engineer or an individual that has obtained National Institute for Certification in Engineering Technologies, Fire Alarm Systems, Level III certification (minimum) in accordance with NFPA 72. Submit the fire alarm reporting system, fire alarm evacuation system, and automatic fire detection system construction (shop) drawings to the appropriate components designated Fire Protection Engineer.

### 5-2 FIRE ALARM REPORTING SYSTEMS.

#### 5-2.1 Applications.

Fire alarm reporting systems are the base-wide reporting systems that connect the building fire alarm control panel(s) to the base fire department. Required systems are to be digital, telephonic, radio, or supervised conductor types. Consider compatibility of extensions of fire reporting systems with existing equipment.

5-2.1.1 The building fire alarm systems must be connected to the fire alarm reporting system as a means for automatically and manually reporting fires to station or base fire departments or to other central alarm locations as required to implement firefighting operations and emergency action.

5-2.1.2 Do not provide fire reporting systems at isolated small areas, ammunition and ordnance storage, and similar restricted areas.

5-2.1.3 Reporting systems are not required in family housing areas, i.e., street boxes are not required.

#### 5-2.2 Exterior Fire Alarm Reporting Systems.

New exterior fire alarm boxes are not required at DOD installations, nor is it required to replace existing boxes that are not needed for the transmission of automatic alarms.

#### 5-2.3 Requirements.

Alarm reporting systems must conform to NFPA 72, *National Fire Alarm Code*, NFPA 70, *National Electric Code* and must provide the following where applicable:

- Transmission of coded signals to fire department headquarters and/or other central locations;

- Permanent record of alarm signal, time, and date;
- Automatic supervision of alarm initiating circuits;
- Signaling line circuits must be designated as Style 4 (Class B), 4.5 (Class B), 5 (Class A), 6 (Class A), or 7 (Class A) as defined by NFPA 72;
- Notification appliance circuits must be Style: W (Class B), X (Class B), Y (Class B), or Z (Class A);
- Initiating device circuits must be Style: B (Class B), C (Class B), D (Class A), or E (Class A);
- Automatic testing of radio signaling devices;
- A dedicated transmitter that will transmit alarm and trouble signals for each essential building; and
- Transmitters must be listed or approved for use with the existing base reporting system.

### 5-3 **FIRE ALARM EVACUATION SYSTEMS**

#### 5-3.1 **Applications.**

Fire alarm evacuation systems must be provided in the following locations:

- Buildings required by NFPA 101.
- Buildings requiring automatic detection or suppression systems.

#### 5-3.2 **Requirements.**

These systems consist primarily of initiating devices and notification appliances. Manual pull stations must be provided where fire alarm evacuation systems are required. Automatic alarm initiating devices such as detectors and water flow alarms must be connected to these systems when provided. Fire alarm systems must be connected to a central alarm location, fire department, or alarm monitoring location. Building fire alarm evacuation systems must be installed in accordance with NFPA 72. Fire alarm systems must be independent, stand-alone systems that are not an integral part of a security, an energy monitoring and control system (EMCS), or other system, except that a fire alarm system may be combined with a building mass notification system or with a combination building mass notification and public address system. Fire alarm systems may be connected to security systems or an EMCS for monitoring purposes only, but must in no way rely on any components of those other systems for operation. Wireless interior fire alarms are not permitted.

**Exception:** Existing fire alarm systems controlled by an EMCS.

#### 5-3.2.1 **Requirements of the Uniform Federal Accessibility Standard (UFAS) and Americans With Disabilities Act (ADA).**

Placement and installation of audiovisual warning devices must be in accordance with the *UFAS* and the *ADAAG (ADA)*.

#### 5-3.3 **Mass Notification System (MNS).**

Refer to UFC 4-021-01, *Mass Notification Systems*.

### 5-4 **AUTOMATIC FIRE DETECTION SYSTEMS.**

#### 5-4.1 **Applications.**

Fire detection systems must be provided in areas required by this UFC and should be limited to these applications. Detection systems must be provided in areas requiring fire detection by NFPA standards and specific criteria contained in this UFC.

**Note 1:** For **Air Force** projects, unless automatic suppression systems are required by this UFC or by other guidance, complete automatic fire detection systems constitute the minimum level of active fire protection for new construction. Smoke detectors alone in return air plenums do not meet this minimum level.

**Note 2:** For **Air Force** projects, when a system is divided into four or more zones, a graphic annunciator or an alphanumeric annunciator must be installed at a location determined by the host fire department.

#### 5-4.2 **Requirements.**

Fire detection systems must conform to the applicable provisions of NFPA 72, the *UFAS* and the *ADA*. Detection systems must be arranged to alert building occupants and to transmit a signal to a constantly attended location. Fire detection systems must be independent, stand-alone systems that are not an integral part of a security system, or other building management, energy/utility management systems. Fire detection systems may be connected to security systems or building management, energy/utility management systems for monitoring purposes only, but must in no way rely on any components of those other systems for operation.

**Exception:** Existing fire detection systems which are controlled by building management, energy/utility management systems.

#### 5-4.3 **Detection Systems.**

Detection systems, especially smoke detection systems, require significant maintenance. It is critical that the required detectors are properly installed and maintained. Providing detectors in locations that are not required increases the already high maintenance costs of alarm systems and strains the maintenance program for critical detection systems. If a facility warrants protection and criteria does not require detection, protection should be accomplished by a wet pipe sprinkler system. Wet pipe sprinklers provide superior protection with little maintenance.

**5-4.3.1 Smoke Detection and Destratification Fans (Ceiling Fans).**

The area of protection for smoke detection devices permitted by NFPA 72 must be reduced by 50 percent where destratification (ceiling) fans are used (i.e., this may require additional smoke detectors for that area being protected).

**Exception:** This restriction does not apply to thermal or flame detection devices or to residential occupancies.

**CHAPTER 6 SPECIAL OCCUPANCIES AND HAZARDS****6-1 PERSONNEL HOUSING AND SIMILAR LODGING FACILITIES.**

These facilities include barracks, dormitories, lodges, temporary or transient living facilities, and sleeping quarters for over 10 persons.

**6-1.1 Automatic Sprinkler Protection**

Complete automatic sprinkler protection must be provided for buildings that include personnel housing and lodging. NFPA 13 or NFPA 13R, *Sprinkler Systems in Residential Occupancies up to and Including Four Stories in Height*, sprinkler systems are permitted when listed for the specific use.

**6-1.2 Smoke Detection**

Provide smoke detectors in accordance with NFPA 101, *Life Safety Code*. A smoke detector must be provided for each sleeping room regardless of occupancy or the presence of other detection or protection systems in the building. When activated, the affected detector must generate an audible signal in the room. Primary power for the smoke detectors can be either 120 Vac or 24 Vdc. Detectors with a battery as the primary power source are not permitted.

**Exception:** **Air Force** designs must not have individual secondary power supplies for each hard-wired smoke detector.

**Note:** For existing **Air Force** unsprinklered facilities, a heat detector is provided in each sleeping room that sounds a general building alarm and transmits a signal to the fire department or to a constantly monitored central location.

**6-1.3 Open Bay Personnel Housing.**

Provide a supervised smoke detection system in accordance with NFPA 72. Locate smoke detectors in open bay sleeping areas and exit access corridors. Install units that sound a general building alarm and transmit a signal to the fire department or to a constantly monitored central location. Corridor detectors are not required if the building is protected with complete automatic sprinkler protection.

**6-1.4 Apartment-Style Personnel Housing Quarters**

Provide hard-wired smoke detectors in accordance with NFPA 101.

**6-1.5 Common Areas.**

Common areas that are provided with residential type range top cooking surfaces (i.e., not in individual living units) must be equipped with an approved residential range top extinguishing system. The range top extinguishing system must be

connected to the building fire alarm system to sound a general building fire alarm.

#### **6-1.6 Storage Areas, Shops, and Laundry Areas.**

Protect storage areas, shops, laundry areas, and other hazardous areas as required by NFPA 101. In many cases, this will require both automatic sprinklers and fire rated construction. Where these areas are required to be sprinklered in buildings without complete automatic sprinkler protection, connect to domestic plumbing (with a maximum of 6 sprinklers) in accordance with NFPA 13. Provide automatic heat detectors connected to the building fire alarm system where these areas are not protected by automatic sprinklers.

### **6-2 FAMILY HOUSING.**

This section includes one-family, two-family, and multi-family dwellings. All family housing must conform to NFPA 101. The NFPA 101 (2006 edition) requirement of sprinkler protection in new one- and two-family dwellings is currently being reviewed by DoD. Until a final decision is made, current criteria will be met.

#### **6-2.1 Definitions.**

For the purpose of this document, the following definitions apply to new family housing.

##### **6-2.1.1 Multi-Family Housing.**

Multi-family housing is defined as more than two dwelling units under one roof. Each unit is separated from other units by a minimum of 1-hour fire resistive construction. Paragraphs 6-2.1.1.1 through 6-2.1.1.4 and Figures 6-1 through 6-4 define multi-family housing.

##### **6-2.1.1.1 Garden Style Apartments.**

Garden style apartments are multi-story structures having separate dwelling entrances at various elevations and having minimum one-hour fire resistive partitions between adjacent units. In addition, the floor/ceiling assemblies between units have a minimum fire resistance rating of one-hour. See Figure 6-1.

**Figure 6-1 Garden Style Apartments**

Sprinkler Protection Required

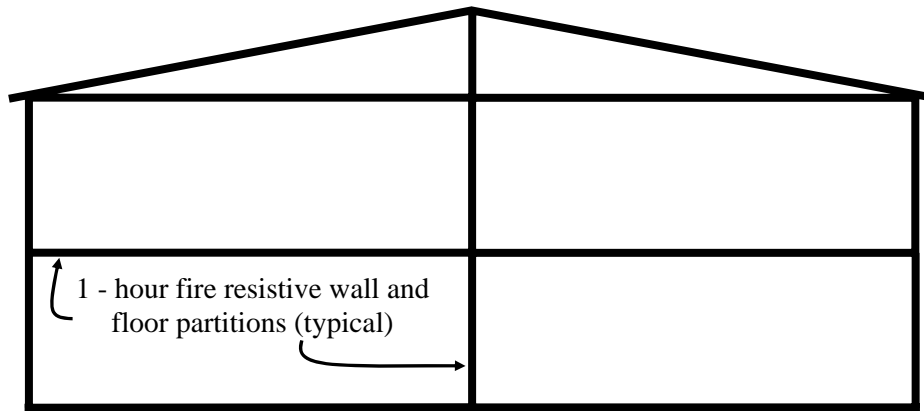



#### 6-2.1.1.2 Townhouse Style Apartment Units (Alternative 1).

Townhouse style apartment units consist of three or more attached dwelling units having separate dwelling entrances with the dwelling units separated by 1-hour fire resistive partitions. See Figure 6-2.

**Figure 6-2 Townhouse Style Apartment Units (Alternative 1)**

Sprinkler Protection Required

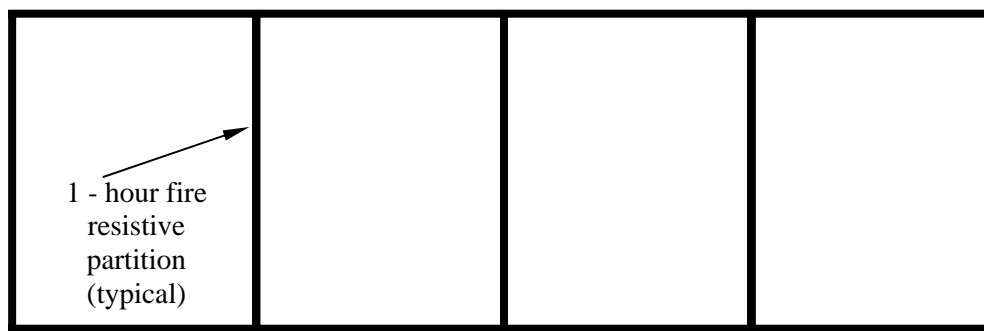

#### 6-2.1.1.3 Townhouse Style Apartment Units (Alternative 2).

Townhouse style apartment units consist of three or more attached dwelling units having separate dwelling entrances with the dwelling units alternating 1-hour and 2-hour fire resistive partitions between dwelling units in the building. See Figure 6-3.

**Figure 6-3 Townhouse Style Apartment Units (Alternative 2)**

Sprinkler Protection Required

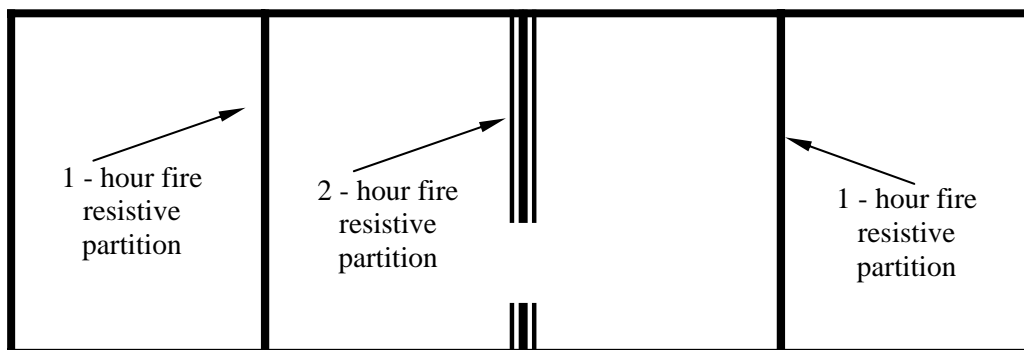

#### 6-2.1.1.4 Attached Duplexes.

Attached duplexes are multi-family housing units, having separate dwelling entrances, with the dwelling units alternating 1-hour fire resistive partition and 2-hour fire area separation walls (party/firewalls) such that each unit is considered

a separate building. These wall systems are specially developed to protect the occupants of the attached residences. These walls are structurally independent, continuous from the foundation to the underside of the roof sheathing (or continue through the roof to form a parapet) and the wall must be designed to allow collapse of the construction on the fire side without collapse of the adjacent separation wall between dwelling units in the building. See Figure 6-4.

**Figure 6-4 Attached Duplexes**

Sprinkler Protection Required

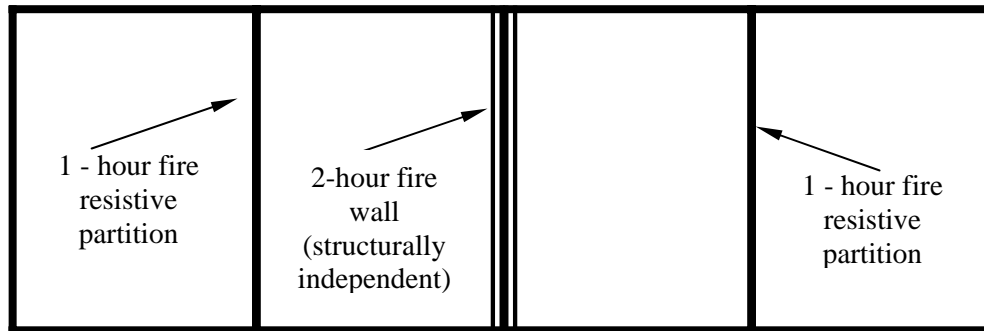

#### 6-2.1.2 Townhouse (Attached Single-Family Dwellings).

Townhouses consist of three or more attached dwelling units having separate dwelling entrances, with the dwelling units separated by 2-hour fire area separation walls (party/firewalls) such that each unit is considered a separate building. These wall systems are specially developed to protect the occupants of the attached residences. These walls are structurally independent, continuous from the foundation to the underside of the roof sheathing (or continue through the roof to form a parapet) and the wall must be designed to allow collapse of the construction on the fire side without collapse of the adjacent separation wall. The fire walls are designed and constructed to maintain its structural integrity independent of the unit on the opposite side of the wall. See Figure 6-5.

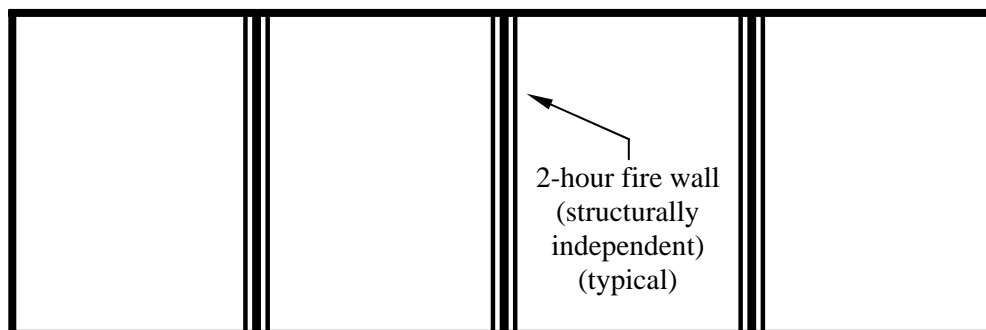
**Figure 6-5 Townhouse (Attached Single-Family Dwellings)****6-2.1.3 Duplex.**

A duplex is a stand-alone structure that contains only two (2) dwelling units that are separated by 1-hour fire resistive construction. See Figure 6-6.

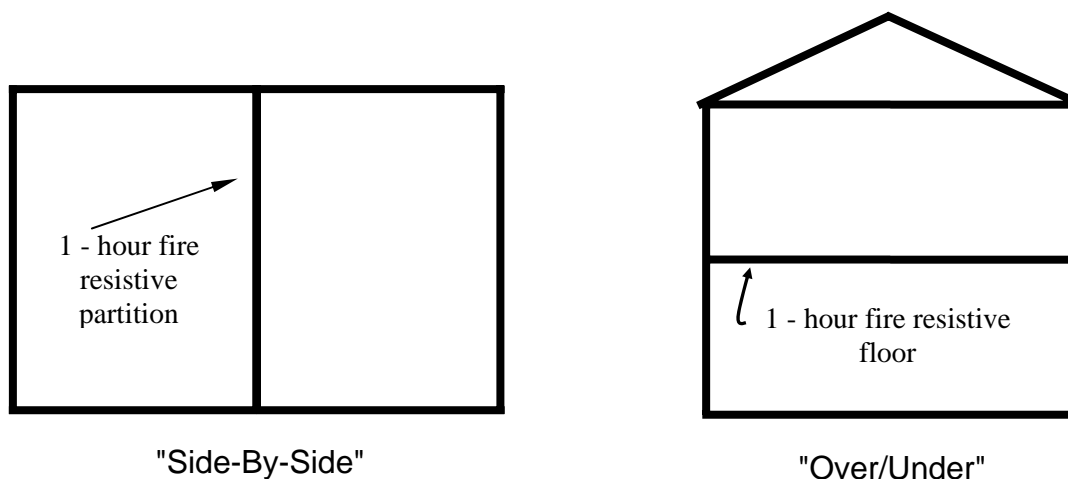
**Figure 6-6 Duplex****6-2.1.4 Single-Family Detached House.**

A single-family detached house is a stand-alone structure that contains one dwelling unit for a single family.

**6-2.2 New Family Housing.****6-2.2.1 Smoke Alarms.**

Install hard-wired smoke alarms for all single family and multi-family housing projects. Smoke alarms must be located in the hallway between the bedroom areas and the rest of the dwelling unit, and on each additional story of the family

living unit, including the basement. For housing projects that are not provided with sprinkler protection, provide smoke alarms in each bedroom. The smoke alarms must comply with the requirements of NFPA 72 and NFPA 101.

**Exception:** **Air Force** designs must not have a secondary power supply (neither internal battery nor connection to the alarm system battery back-up power) for the hard wired smoke detectors.

#### 6-2.2.2 **Sprinkler Protection.**

##### 6-2.2.2.1 **New Multi-Family Housing.**

As required by the Fire Safety Act, provide sprinkler protection in accordance with NFPA 13 or NFPA 13R in all garden style apartments, townhouse style apartment units (Alternatives 1 and 2), and attached duplex multi-family dwellings (refer to paragraphs 6-2.1.1.1 through 6-2.1.1.4). For multi-family dwellings greater than 4 stories in height, provide sprinkler protection in accordance with NFPA 13.

**Exception:** For Attached duplex multi-family dwellings, sprinkler protection can be provide in accordance with NFPA 13D.

##### 6-2.2.2.2 **New Townhouse, Duplex and Single Family Housing.**

Sprinkler protection is not required for townhouse (attached single-family dwellings), duplex, and single family detached family housing. See paragraphs 6-2.1.2 through 6-2.1.4.

#### 6-2.3 **Existing Multi-Family Housing.**

Existing housing must be considered multi-family housing unless it meets one of the definitions in paragraphs 6-2.1.2, 6-2.1.3, or 6-2.1.4. In accordance with Office of Under Secretary of Defense memorandum dated 14 January 2002, all windows in existing housing must comply with NFPA 101 as a secondary means of escape by 2007, unless a waiver is obtained from the component's AHJ.

##### 6-2.3.1 **Whole House Improvement Projects.**

These requirements apply to the following projects.

###### 6-2.3.1.1 **Projects That Exceed 50% of the Replacement Cost.**

Ensure that a minimum of 1-hour fire resistive construction is provided between dwelling units, and between the dwelling unit and attached parking. Provide sprinkler protection in accordance with requirements specified in paragraph 6-2.2.2. Provide smoke alarms in accordance with paragraph 6-2.2.1.

###### 6-2.3.1.2 **Projects That are Less Than 50% of the Replacement Cost.**

Provide hard-wired smoke alarms in the hallway between the bedroom areas and the rest of the dwelling unit, and on each additional story of the family living unit, including the basement. The smoke alarms should be interconnected so that when one goes into alarm, they all will go into alarm. The smoke alarms must comply with the requirements of NFPA 72 and NFPA 101.

#### **6-2.3.2 Minor Improvement and Repair Projects.**

For minor improvement and repair projects, depending on the scope of the project, sprinkler protection should be considered for installation. At a minimum, smoke alarms must obtain power that uses the commercial light and power source, and must be located on every level of the dwelling unit.

**Note:** For projects that are cutting into a third of the walls, sprinkler protection can be provided with minimal cost impact to the project.

#### **6-2.3.3 Kitchen Improvements.**

For all improvement or repair projects involving major kitchen renovation, it is recommended to provide sprinkler protection in the kitchen if sprinkler protection is not included in the project. The installation of sprinklers must comply with the requirements of NFPA 13, NFPA 13D or NFPA 13R.

#### **6-2.4 Residential Range Top Extinguisher Units.**

Residential range top extinguisher units are not required in new, revitalized or existing housing. If residential range top extinguisher units are installed, the units, upon activation, must automatically shut off all sources of fuel and electric power that produce heat to the equipment being protected by that unit.

#### **6-2.5 Continuity.**

The common fire wall or fire resistive partition for townhouses, duplexes, attached duplexes, or townhouse style apartments must be continuous from the foundation to the underside of the roof deck and must extend the full length of the common wall.

**6-2.5.1** The roof sheathing, for not less than a 1220 mm (4-ft) width on each side of the wall, must be of noncombustible material or one layer of 16 mm (5/8-inch) Type X gypsum wallboard attached to the underside of the roof decking. Parapets are prohibited.

#### **6-2.6 Off-Base Housing Requirements.**

Family housing located outside military installations or bases must comply with provisions of paragraphs 6-2.2 through 6-2.5 above, and must comply with applicable local fire and building codes when the local fire department has "first due" responsibility.

**6-2.7 Overseas Housing Requirements.**

Overseas family housing, constructed or leased- constructed, must comply with provisions of paragraphs 6-2.2 through 6-2.5 and the host nation fire protection requirements or NFPA 101 whichever is more stringent.

**6-2.8 Leased Family Housing.**

DoD personnel occupying leased housing deserve the same level of protection as those in DoD-owned housing. Implementation of these standards is therefore mandatory for all housing leased for DoD use. This requirement is intended to cover all situations, including privatized buildings, and host-nation and other foreign government buildings. This requirement is applicable for all new leases executed on or after 1 October 2006 and to renewal or extension of any existing lease on or after 1 October 2007. Leases executed prior to the above fiscal years will comply with these requirements where possible.

**6.2.8.1 New Buildings.**

Buildings that are built to lease to DoD as of the effective date established above must comply with the standards for new construction.

**6.2.8.2 Existing Buildings.**

New leases or renewals of leases of existing buildings will trigger the aforementioned requirements in accordance with the effective dates established above.

**6-3 FOOD PREPARATION IN FACILITIES****6-3.1 Cooking Facilities for Other than Dwelling Units.**

Hood and duct systems for commercial cooking equipment that produces smoke or grease-laden vapors must comply with NFPA 96, *Ventilation Control and Fire Protection of Commercial Cooking Operations*. Limit kitchen-extinguishing systems to wet chemical or automatic sprinklers installed in accordance with NFPA 96. Install fire suppression systems that sound a general building fire alarm and transmit a signal to the fire department or to a constantly monitored location.

**6-3.2 Cooking Equipment in Facilities.**

Areas, other than dwelling units, that are provided with residential type range top cooking surfaces must be equipped with an approved residential range top extinguishing system. The range top extinguishing system must be connected to the building fire alarm system to sound a general building fire alarm and must automatically shut off all sources of fuel and electric power that produce heat to the equipment being protected by that unit.

**6-4 MEDICAL FACILITIES.**

This section includes hospitals, composite medical facilities, ambulatory health care centers, occupational health clinics, outpatient clinics, dental clinics, flight medicine clinics, medical logistics facilities, biological safety and medical laboratories, and similar facilities. These facilities must conform to UFC 4-510-01, *Design: Medical Military Facilities*.

**6-5 DETENTION AND CORRECTIONAL FACILITIES.****6-5.1 Requirements.**

Comply with NFPA 101 and the following:

- Individual fire areas must not exceed 4647 m<sup>2</sup> (50,000 ft<sup>2</sup>).
- Construction type must not be less than Type I - A, as defined in the *IBC*.
- Provide a minimum separation from other structures and public ways of 6.1 m (20 ft).
- Provide complete automatic sprinkler protection. Design must utilize institutional (breakaway) type sprinklers. Sprinkler piping in inmate areas must be concealed.
- Provide smoke detection in all areas as required by NFPA 101 and American Correctional Association's (ACA) *Planning and Design Guide for Secure Adult and Juvenile Facilities*.
- Provide an automatic smoke removal system in cell areas. In addition, provide manual system activation controls at a continuously manned position outside of the cell area.
- Provide for constant visual supervision of cell areas. If this supervision is by direct line of sight, it must be separated by not less than one-hour fire rated construction.

**Note:** Navy facilities must also comply with the ACA's *Planning and Design Guide for Secure Adult and Juvenile Facilities*.

**6-5.2 Locking Devices.**

Provide mechanical or closed circuit electrical gang release devices whenever 10 or more locks must be operated to release prisoners confined in cells. Require gang release devices to open doors necessary to evacuate prisoners to an area of refuge. Require heavy, identically keyed, prison-type locks for exit and

corridor doors not requiring gang release devices that must be opened for evacuation in the event of fire.

**Exception:** Dormitory-style confinement facilities.

### 6-5.3 **Interior Finish.**

Interior finish including padded cells must be Class A flame spread (i.e., 25 or less) and must have a SD rating not exceeding 50 when tested in accordance with ASTM E 84.

## 6-6 **LIBRARIES.**

Eliminate combustible shelving, stacks, cases, cabinets, fixtures, furniture, and furnishings to the maximum practical extent. Use noncombustible wall and ceiling finish materials.

### 6-6.1 **Facilities with Sprinkler Protection.**

In buildings equipped with automatic sprinklers, protect libraries with automatic sprinklers.

### 6-6.2 **Facilities without Sprinkler Protection.**

In buildings not equipped with sprinkler protection, provide the following protection features for those libraries containing materials that are rare, irreplaceable, or important to the activity mission:

For buildings of fire resistive or noncombustible construction, install smoke detection systems throughout the library area and provide a fire cutoff having a fire resistance rating of at least 1 hour to separate the library from other occupancies.

Provide complete automatic sprinkler protection for libraries in buildings of combustible construction. Separate the library from the remainder of the building by firewalls having a fire resistance rating of at least 2 hours.

## 6-7 **CHILD DEVELOPMENT FACILITIES (CDC).**

CDCs must conform to the requirements of NFPA 101 for day care centers and UFC 4-740-14, *Child Development Centers*.

**Exception:** **Army** child development centers must comply with the U.S. Army Corps of Engineers Technical Instruction, TI 800-01, *Design Criteria, Appendix G*.

### 6-7.1 **Other Child Development Facilities.**



Other child development facilities include part-day, preschool, kindergarten, before and after school programs, school-age facilities, etc. Comply with the provisions of educational occupancies in NFPA 101.

## **6-8 ELECTRONIC EQUIPMENT INSTALLATIONS.**

These areas include major automatic data processing (ADP) areas, communication centers, command and control systems, and other mission critical systems. Incidental electronic equipment such as word processing stations, printers, and systems; desk top computers; office automation systems; individual data output stations (e.g., printers, etc.); individual computer work stations; telephones; video conference centers; administrative telephone rooms; reproduction equipment; and similar equipment do not require protection under this section.

### **6-8.1 Requirements.**

Construct and protect electronic equipment installations in accordance with NFPA 75, *Protection of Information Technology Equipment* except as modified by this UFC.

#### **6-8.1.1 Automatic Sprinkler Protection.**

Electronic equipment installations must be located in buildings protected by wet-pipe automatic sprinklers. Provide complete coverage throughout the building including electronic equipment areas. Protect electrical equipment installations by disconnecting the power upon activation of the fire protection system.

#### **6-8.1.2 Use of a Clean Agent Fire Extinguishing System.**

Consideration may be given to the use of a supplementary clean agent fire extinguishing system inside the electronic equipment units or a total flooding system for the room and raised floor. Supplementary clean agent fire extinguishing systems will augment the wet-pipe automatic sprinkler system and will not be considered as a substitute. Air sampling and Very Early Smoke Detection devices will be allowed to activate a clean agent fire extinguishing system provided approval from the AHJ is obtained.

#### **6-8.1.3 Power and Communication Cabling.**

Power and communication (data) cabling installed in spaces above ceilings or below raised floors must be plenum rated or installed in metallic conduit. If this cannot be achieved, the spaces must be protected by an automatic fire suppression system as listed in 6-8.2(2).

#### **6-8.1.4 Area Below Raised Floors.**

The NFPA 75 fire suppression system is not required under the raised floor if paragraph 6-8.1.3 is met.

#### **6-8.2 Existing Facilities.**

For existing facilities that contain non-plenum rated cables under the raised floor and do not have an automatic fire extinguishing system under the raised floor provide one of the following :

- 1) Develop a plan to replace all non-plenum rated cable with plenum rated cable within a 5 year period.
- 2) Provide a non-halocarbon clean agent fire extinguishing or automatic sprinkler system for under the raised floor. If a halocarbon agent is desired, the entire occupiable space and area under the raised floor must be protected with the halocarbon agent.

#### **6-9 TELECOMMUNICATIONS (TELECOM) ROOMS AND BUILDINGS.**

Telecom rooms and buildings contain equipment that serves a base or portion of a base. This section does not apply to the room of a building that contains the incoming telecommunications service for that specific building.

##### **6-9.1 Requirements.**

Telecom rooms and buildings must comply with NFPA 76, *Fire Protection of Telecommunications Facilities*. The advisory provisions of NFPA 76 shall be mandatory, as though the word "shall" had been substituted for "should" wherever it appears.

##### **6-9.2 Construction.**

Telecom rooms must only be located in buildings of Type I or Type II-A construction. Single story buildings may be of Type II-B construction.

##### **6-9.3 Detection.**

Provide an air sampling system, very early smoke detection system, or laser spot smoke detectors that report to a constantly attended location.

##### **6-9.4 Multiple Tenant Facility.**

For buildings that house a Telecom Room, the entire building must be provided with sprinkler protection, including the Telecom Room.

##### **6-9.5 Stand-alone Telecom Buildings.**

For a stand-alone Telecom building greater than 232 m<sup>2</sup> (2,500 ft<sup>2</sup>) provide a fire extinguishing system (i.e., clean agent fire extinguishing system or automatic sprinkler system).

**6-10           ORDNANCE**

**6-10.1         Ordnance Production Facilities.**

Ordnance facilities used for manufacturing, maintaining, demilitarizing, handling, processing, testing, servicing, and inspection of ammunition, explosives, propellants and oxidizers or related devices containing these materials must have complete automatic sprinkler protection and comply with DOD 6055.9-STD, *DOD Ammunition and Explosives Safety Standards*. Requirements for IBC Group H occupancies must be followed in the absence of specific guidance in DOD 6055.9-STD and the individual service regulations based directly on DOD 6055.9-STD. The service regulations include:

For **Navy** projects, NAVSEA OP-5, *Ammunition and Explosives Ashore Safety Regulations for Handling, Storing, Production, Renovation, and Shipping*.

For **Army** projects, Army AR 385-64, *U.S Army Explosives Safety Program*; Army Pamphlet 385-64, *U.S. Army Ammunition and Explosives Safety Standards*; and the Army Material Command Regulation 385-100, *Safety Manual*.

For **Air Force** projects, Air Force AFMAN 91-201, *Explosives Safety Standard*.

**6-10.1.1       Sprinkler Protection.**

Automatic sprinkler systems in ordnance facilities must be provided with flexible couplings and sway bracing similar to that provided for buildings in earthquake zones. Complete automatic sprinkler protection is required for ordnance facilities used for manufacturing, maintaining, demilitarizing, handling, processing, testing, servicing, and inspection of ammunition, explosives, pyrotechnics, propellants, and oxidizers or related devices containing these materials, unless such a system will aggravate the hazard. The following guidelines for automatic sprinkler protection must apply:

6-10.1.1.1   Where exposed thermally energetic materials are handled that have a high probability of ignition, a large thermal output and a high probability of causing personnel injury, operations must be protected using ultra high-speed deluge systems. Ultra high-speed deluge systems have a response time of 100 milliseconds (ms) or less. Response time is measured from the time that an energy source is presented to the detector to the time of initial water flow from the critical nozzle, which is normally the nozzle closest to the hazard. Ultra high-speed detectors usually consist of preprimed water delivery system, optical flame detectors, and electronic controller. Paragraph 6-10.2 provides guidance on ultra high-speed deluge systems. NFPA 15, *Water Spray Fixed Systems for Fire*

*Protection*, and the NFPA Handbook provide additional information on ultra high-speed deluge systems.

6-10.1.1.2 Provide high-speed (operation of 500 milliseconds or less), preprimed deluge systems wherever exposed explosives, pyrotechnics, or propellants are processed or stored in ordnance production facilities. Complete protection of such locations is essential.

6-10.1.1.3 Provide ordinary deluge systems, wet-pipe systems, or preaction systems in other areas or auxiliary sections of buildings in which processing of explosives, pyrotechnics, or propellants takes place.

6-10.1.1.4 Provide ordinary deluge systems, wet-pipe systems, or pre-action systems in other areas or auxiliary sections of buildings in which storage of explosives or propellants takes place.

6-10.1.1.5 Provide wet-pipe sprinkler systems in other areas or auxiliary sections of buildings if separated by fire partitions.

6-10.1.1.6 Provide wet-pipe or pre-action sprinkler systems where missile assembly inspection or storage is carried on and where the propellant is confined within the missile, or warheads are present. Similar protection must be provided for torpedo and air underwater weapons shops.

6-10.1.1.7 Heat detection equipment of any type is acceptable if equipment meets the operating time limitations and is suitable in other respects, such as complying with explosion-proof requirements. When pneumatic-type detection equipment is used, not more than three detectors, and preferably only one, must be on a single circuit. The detectors must be in the same heat influence area.

6-10.1.1.8 All fire protection systems protecting ordnance operations must have complete supervision so that any deficiency that develops that would affect the speed or reliability of operation will give a distinct alarm separate from the water flow alarm.

#### 6-10.1.2 **Water Demands for Ultra High-Speed Deluge Systems.**

Water supplies for ultra high-speed deluge systems must be adequate to supply the total demand of the largest fire area at the specific residual pressure required by the system for a period of at least 15 minutes unless a hazard analysis indicates a longer flow time is needed. Provide a flow rate of at least 20.4 L/m/m<sup>2</sup> (0.50 gpm/ft<sup>2</sup>) over the entire area protected by the ultra high-speed deluge system unless a hazard analysis indicates a higher flow rate is needed.

#### 6-10.2 **Ultra High-Speed Deluge Systems.**

Comply with the requirements of NFPA 15, except as noted in this standard.

**6-10.2.1 Response Time**

- Response time must be the time for system operation from the presentation of an energy source to the detector to flow of water from the water spray nozzle being tested.
- Ultra high-speed deluge systems must be designed to have a response time of not more than 100 milliseconds, unless a risk assessment or other data indicates a need for a faster response time.

**6-10.2.2 Timers.**

- Timers or similar devices to stop water flow after a predetermined time are permitted if they are fail-safe (i.e., water continues to flow in the event of a timer failure).
- Timers or similar devices that shut off the water flow after a predetermined time (typically 1 to 2 minutes) when the optical fire detectors no longer detect a fire are permitted. In case of a failure, it must fail in the on (water flowing) position.

**6-10.2.3 Design.**

Due to the speed of water coming from all the nozzles, ultra high-speed deluge systems depend on the detection system, piping network, nozzles and water supply characteristics. Only experienced designers, engineers, and installers who understand the system's limitations and capabilities should provide the design, specification, and installation of the deluge system.

**6-10.2.4 Risk Assessment.**

All munitions production, maintenance, renovation, quality assurance and demilitarization operations will receive a risk assessment to identify potential fire and thermal threats and to assess the level of risk. The hazard must be accurately defined. A potential fire and or thermal hazard whose level of risk is high or extremely high is unacceptable. The risk assessment will consider factors such as:

- Initiation sensitivity
- Quantity of material
- Heat output
- Burning rate
- Potential ignition and initiation sources

- Protection capabilities
- Personnel exposure
- Munitions configuration
- Process equipment
- Process layout
- The building layout.

#### 6-10.2.5 **Small Self-Contained Deluge Systems.**

Currently, two types of small self-contained deluge systems are in use in military ordnance facilities. They may be used with the ultra high-speed deluge systems discussed in this section, or alone if an adequate water supply is not available for the facility. These small self-contained deluge systems are primarily intended for personnel protection, although they provide some building/equipment protection. When used, these systems should be connected to the existing water supply if the water supply can be of some benefit.

6-10.2.5.1 The portable deluge system is a transportable self-contained ultra high-speed deluge system. The system uses multiple optical fire detectors, multiple nozzles, and a pressurized water tank (typically 380 L (100 gallons) of water). Response time does not exceed 100 ms (detection to water at the nozzle). The portable system is intended to protect short-term operations. When possible, connect the portable deluge system to the building water supply for backup water.

6-10.2.5.2 The pressurized sphere ultra high-speed deluge system is a small self-contained system. The system uses one or more optical fire detectors, at least one pressurized (typically 3,447 kPa (500 psi)) water sphere (typically 10 to 30 liters (2.6 to 7.9 gallons)) with a rupture disc and internal squib, and an electronic controller. Response time is less than 10 ms (detection to water at the nozzle). The sphere discharges water when the squib fires, opening the rupture disc. A screen breaks the water into small-atomized particles and collects the residual squib fragments.

#### 6-10.3 **Magazines and Bunkers.**

Magazines, storage facilities, and bunkers must be constructed and located in accordance with DOD 6055.9-STD. Storage facilities, magazines, and bunkers not located under the same roof as facilities used for handling, processing, testing, servicing, and inspection of ammunition, explosives, propellants, and oxidizers must be constructed and located in accordance with DOD 6055.9-STD. Automatic sprinklers and hydrant protection are not required for magazines, bunkers, and storage facilities similarly constructed and located.

**6-10.4 Stored Missile Assemblies.**

Missile assemblies are considered to be large rocket type, Cruise missiles without their ordnance, Intercontinental Ballistic Missiles, or Poseidon missiles.

6-10.4.1 Provide sprinkler protection for all stored missile assemblies.

**Exception:** Munitions storage igloos that are in accordance with DOD explosive safety standards.

6-10.4.2 Water demand for stored missile assemblies and all other ordnance facilities requiring sprinkler protection must meet or exceed the design requirements in Table 4-1 for ordinary hazard group 2. For Air Force projects, refer to AFMAN 91-201, *Explosives Safety Standards*.

**6-10.5 Other Ordnance Facilities.**

6-10.5.1 All other ordnance facilities including munitions, weapons, and missile maintenance facilities require sprinkler protection.

6-10.5.2 Water demand for other ordnance facilities must meet or exceed the design requirements in Table 4-1 for ordinary hazard group 2. For Air Force projects, refer to AFMAN 91-201, *Explosives Safety Standards*.

**6-11 WAREHOUSES AND STORAGE FACILITIES.**

These criteria apply to facilities (except ordnance) used for storage, shipping, receiving, packing, and processing of materials.

**6-11.1 Sprinkler Protection.**

Complete automatic sprinkler protection must be provided for warehouses and storage facilities 465 m<sup>2</sup> (5,000 ft<sup>2</sup>) or greater. Sprinklers must be provided for smaller facilities containing materials, equipment and supplies that are mission essential, pose a severe fire hazard, are of high monetary value, pose a safety or environmental health risk, or expose an important structure. Sprinkler protection must include covered loading docks.

- Sprinkler protection must be based on Class IV commodities, as defined by NFPA 13, unless a more severe class of storage is anticipated, and must be based on the maximum potential height of storage.
- In-rack sprinklers must be supplied from risers which are separate from the ceiling sprinklers, except in existing facilities.
- Racks with solid shelves over 3.7 m (12 ft) in height must be protected with in-rack sprinklers at every tier or shelf level.

- Sprinkler riser control valves must be readily accessible to the fire department from the exterior.

**Exception:** For DLA projects, sprinkler riser control valves must be in separate exterior riser room (s) and readily accessible to the fire department.

#### 6-11.1.1 **Duration.**

The minimum duration for warehouse facilities must be 120 minutes.

#### 6-11.1.2 **Hose Stream Allowance.**

Provide a hose stream allowance of 1900 Lpm (500 gpm).

#### 6-11.2 **Bin Storage.**

Bin storage consists of five-sided, open from top or side storage containers, stacked in rack structures. They are commonly used in automatic storage and retrieval systems. Bin storage requires unique considerations for fire protection. Bin storage configurations do not limit oxygen supply. Horizontal flame spread can be rapid. The narrower the aisles and the higher the storage, the less ceiling sprinkler water penetration is delivered to control the fire.

##### 6-11.2.1 **Requirements.**

Protection of bin storage stacked in rack configuration must be in accordance with NFPA 13. Combustible bins in racks present a greater fire hazard and require a 10 percent increase in ceiling density or one additional level of in-rack sprinklers. Bin storage not stacked in a rack configuration must be protected in accordance with NFPA 13. Mini-storage and retrieval systems and carousel storage must be protected in accordance with FM Global Data Sheet 8-33, *Carousel Storage and Retrieval Systems*.

##### 6-11.3 **Column Protection.**

Steel columns located within rack storage areas (actually surrounded by racks) over 929 m<sup>2</sup> (10,000 ft<sup>2</sup>) must be protected by 2-hour fire rated construction, or applied fireproofing, or by sidewall sprinklers at 3 m (10 ft) elevation intervals pointing directly at the column and in accordance with NFPA 15.

##### 6-11.4 **Fire Area Limitation and Separation.**

Warehouse fire areas must not exceed 5,574 m<sup>2</sup> (60,000 ft<sup>2</sup>). Warehouse fire areas may be increased to 11,148 m<sup>2</sup> (120,000 ft<sup>2</sup>) with the following provisions:

- Ceiling sprinkler design area must be increased by 10 percent. ESFR sprinklers must increase the required number to be calculated by 10 percent.



- Dedicated looped fire water mains must be provided with enough sectional valves to isolate each sprinkler lateral around the warehouse.
- A secondary fire pump must be provided when a fire pump is provided.

**6-11.5 Fire Walls.**

Fire walls separating warehouse and storage fire areas must be of 4-hour fire rated construction. Other occupancies such as offices and shops must be separated from the warehouse and storage area by a minimum of one-hour fire rated construction.

**6-11.5.1 Openings in 4-Hour Rated Fire Walls.**

Openings in 4-hour rated fire walls must be protected by 3-hour Class A fire doors in accordance with NFPA 80, on both sides of the wall. Personnel doors may be protected by a single Class A fire door. Fire doors must be labeled by an NRTL, refer to paragraph 2-4.

**6-11.5.2 Conveyor and Mechanical Handling System Penetrations.**

When mechanical handling systems such as conveyors are required to penetrate fire walls, and fire doors are not feasible, the opening must be protected on both sides of the wall by a deluge water spray tunnel system in accordance with FM Global Data Sheet 1-23, *Protection of Openings in Fire Subdivisions*. The deluge water spray tunnel system must consist of a separate water spray system for both sides of the opening, and a metal or masonry enclosure around the opening extending a minimum of 1.5 m (5 ft) from both sides of the wall. The spray system must consist of open spray nozzles that provide a minimum of 1.356 L/s per m<sup>2</sup> (2.0 gpm/ft<sup>2</sup>) of opening and must be activated by heat detectors. Any detector must activate both systems simultaneously. The systems must be supplied from a separate riser independent of the overhead sprinkler system. Each system must be equipped with a control valve. The water supply must be capable of supplying the deluge systems in addition to other required fire protection demands. Operation of any deluge system or sprinkler system protecting the area of the handling system must automatically shut down the handling system.

**6-11.6 Rubber Tire Storage.**

Rubber tire storage must comply with NFPA 230, *Standard for the Fire Protection of Storage*, and NFPA 13.

**6-11.6.1 Hose Stream Allowance.**

Provide a hose stream allowance of 1900 Lpm (500 gpm).

## 6-12 STORAGE OF FLAMMABLE AND HAZARDOUS MATERIALS AND HAZARDOUS WASTE.

### 6-12.1 Flammable/Hazardous (Flam/Haz) Storage.

Flam/Haz storage includes storage of flammable and combustible liquids as well as storage of materials that are classified as hazardous materials. Provide protection for facilities storing flammable and combustible liquids and other petroleum oil lubricant (POL) products in accordance with NFPA 30, *Flammable and Combustible Liquids Code*. Class IIIB combustible liquids must be protected in the same manner as Class IIIA combustible liquids in accordance with NFPA 30. A single building is often used for storage of both flammable and combustible liquids and hazardous materials. Requirements for the storage of hazardous waste are separate and distinct from the storage of hazardous materials.

**Note:** For **Navy** facilities used to store hazardous materials, also refer to UFC 4-442-01N, *Covered Storage*. For **Navy** and **Air Force** facilities used to store hazardous waste, also refer to UFC 4-451-10N, *Hazardous Waste Storage*.

#### 6-12.1.1 Warehouse Areas for Storage of Flammable Liquids, Solids, and Hazardous Materials.

Warehouse areas for storage of flammable liquids, solids, and hazardous materials and chemicals must not exceed 1,858 m<sup>2</sup> (20,000 ft<sup>2</sup>) between fire walls and travel distance must not be more than 23 m (75 ft) (30.5 m (100 ft) if sprinklered) to the nearest fire exit. Fire walls must have a minimum 4-hour rating. Ceiling height must not exceed 9.1 m (30 ft).

#### 6-12.2 Flammable and Combustible Liquid Storage Areas.

Provide automatic sprinkler protection. Ceiling and in-rack sprinklers must be designed in accordance with and NFPA 30 and installed in accordance with NFPA 13. Aqueous film-forming foam (AFFF) systems may be used where permitted by NFPA 30. The following minimum criteria must apply:

- Provide a minimum longitudinal flue space of 305 mm (12 in) between double row racks and 230 mm (9 in) between single row racks and the wall.
- Provide ceiling level sprinklers and in-rack sprinklers. The in-rack sprinklers must protect the longitudinal flue space and must be located at every level of rack storage.

**Exception:** Where multiple levels of rack storage are used below the 1.83 m (6 ft) level for hand picking operations, provide one extra row of in-rack sprinklers in the longitudinal flue space at the 0.914 m (3 ft) level. The first level of storage

must not be a minimum of 305 mm (1 ft) above the finished floor level to facilitate easier cleanup of spills.

#### **6-12.3 Hazardous Materials Storage Areas.**

Provide a minimum of 2-hour fire rated construction between hazardous materials storage areas and those used for storage of flammable and combustible liquids. These areas must be labeled as "Hazardous Materials Only," and must also be labeled as to the type of sprinkler protection present in each room. Provide automatic sprinklers at the ceiling level as well as one mandatory level of in-rack sprinklers (i.e., in the flue space between the rack and the wall) located at or slightly above the midpoint with respect to overall storage height. In hazardous material storage areas not containing flammable or combustible liquids, design ceiling sprinkler densities based on the storage of Class IV commodities in NFPA 13. In water reactive areas, provide automatic sprinklers with an indicating valve to be locked in the closed position. Provide a metal sign stating the indicating valve is to remain locked in the closed position unless non-water reactive material is stored in the room. The sign can be attached to a chain and connected to the indicating valve or fastened permanently to the wall provided it does not interfere with the operation of the valve. Locate the indicating valve outside the water reactive storage area.

#### **6-12.4 Hazardous Waste Storage Facilities.**

For hazardous waste storage facility requirements, refer to the following:

- NFPA 30, Flammable and Combustible Liquids Code
- NFPA 430, Storage of Liquid and Solid Oxidizers
- NFPA 434, Storage of Pesticides
- NFPA 490, Storage of Ammonium Nitrate

##### **6-12.4.1 Fire Protection for Hazardous Waste Storage Facilities.**

The following minimum criteria must be provided:

###### **6-12.4.1.1 Exterior Fire Walls**

- Exterior walls must consist of 4-hour fire resistive construction when the facility is attached to a structure or it is located within 3 m (10 ft) of another building or property line.
- Exterior walls must consist of 2-hour fire resistive construction when the facility is located more than 3 m (10 ft) but less than 15.3 m (50 ft) from an important building or property line.

- Exterior walls must be of noncombustible construction when the facility is more than 15.3 m (50 ft) from another building or property line.

#### 6-12.4.1.2 **Interior Fire Walls.**

- Interior fire walls must have a 4-hour fire rating if the facility is located within a structure that houses other occupancies.
- Interior fire walls must have a 2-hour fire rating when the area of the room is greater than 28 m<sup>2</sup> (300 ft<sup>2</sup>).
- Interior fire walls must have a one-hour rating when the area of the room is 28 m<sup>2</sup> (300 ft<sup>2</sup>) or less.

#### 6-12.4.1.3 **Sprinkler Protection.**

Install sprinkler systems suitable for a corrosive environment, in accordance with NFPA 13.

#### 6-12.5 **Spill Containment.**

Provide spill containment for flammable and combustible liquids, hazardous materials, and hazardous waste in accordance with NFPA 30.

#### 6-12.6 **Prefabricated Structures.**

Prefabricated structures (which may be portable) are an acceptable means of storing flammable and hazardous materials and hazardous waste provided they meet the requirements of NFPA 30, section entitled "Hazardous Materials Storage Lockers" (paragraph 6.6 of the 2003 edition to provide a reference).

#### 6-12.7 **Outdoor Storage Limitations and Separation.**

Flammable and combustible liquid outdoor storage includes any storage that is covered by a roof to provide weather protection for containers. The same area may have one or two (but no more than two) walls. Flammable and combustible liquid outdoor storage area must not be more than 122 m (400 ft) long or wide and each area must be separated by 30.5 m (100 ft). No container or portable tank in a pile must be more than 61 m (200 ft) from a 12.2 m (40-ft) wide minimum fire lane to permit approach of fire control apparatus under all weather and ground surface conditions. Fire hydrants must be located in accordance with NFPA 24, but must not be more than 91 m (300 ft) apart.

#### 6-12.8 **Electric Wiring and Equipment.**

Where flammable liquids are dispensed or transferred between containers, electric wiring and equipment must be suitable for classified locations in

accordance with NFPA 70. Where flammable liquids are not dispensed or transferred between containers, unclassified locations for electrical equipment may be provided.

**6-12.9 Ventilation.**

To maintain a continuous low level flammable vapor concentration, design and install mechanical ventilation system with 0.3 cu m/min/m<sup>2</sup> (1 cfm/ft<sup>2</sup>) airflow of floor area. The ventilation fan motors should be classified for ordinary locations.

**Note:** The low-level ventilation system will prevent accumulation of significant quantities of vapor-air mixture, in the event of a spill.

**6-13 WATERFRONT FACILITIES.**

Naval waterfront and harbor facilities must comply with all of the following:

- NFPA 307, *Construction and Fire Protection of Marine Terminals, Piers, and Wharves.*
- NFPA 312, *Fire Protection of Vessels During Construction, Repair, and Lay-Up.*
- NFPA 303, *Fire Protection Standard for Marinas and Boatyards.*
- UFC 4-152-01, *Piers and Wharves.*
- UFC 4-150-02, *Dockside Utilities.*
- UFC 4-151-10, *General Criteria for Waterfront Construction.*
- UFC 4-213-10, *Graving Drydocks.*
- UFC 4-213-12, *Drydocking Facilities Characteristics.*

**6-14 PETROLEUM FUEL FACILITIES.**

Petroleum fuel facilities must comply with UFC 3-460-01, *Petroleum Fuel Facilities.*

**6-14.1 Aboveground Vertical Tanks.**

Construction, separation and diking requirements for above ground vertical tanks storing flammable or combustible liquids are contained in UFC 3-460-01.

**6-14.2 Aboveground Vertical Tanks for Flammable Liquids.**

Aboveground vertical tanks storing Class I flammable liquids must be equipped with internal full contact, aluminum honeycomb floating pans. Only aluminum pans providing closed cells and full fuel contact will be permitted in new construction. Foam fire extinguishing systems are not required where internal honeycomb floating pans are installed.

#### **6-14.3 Aboveground Vertical Tanks for Combustible Liquids.**

Aboveground vertical tanks storing mission critical Class II combustible liquids (i.e., JP-5, JP-8, and diesel fuel used for shipboard fueling) must be equipped with internal honeycomb floating pans constructed of aluminum. Only aluminum pans providing closed cells and full fuel contact will be permitted in new construction. Foam fire extinguishing systems are not required where internal honeycomb floating pans are installed. Tanks containing other Class II or Class III combustible liquids do not require internal honeycomb pans or foam extinguishing systems.

#### **6-14.4 Fuel Transfer Facilities.**

Fuel transfer facilities include truck, rail, car and marine transport vessels. Fire protection for these facilities must be in accordance with UFC 3-460-01.

#### **6-14.5 Aircraft Direct Fueling.**

Fire protection for these facilities must be in accordance with UFC 3-460-01.

### **6-15 HYDRAULIC SYSTEMS.**

Any combustible liquids under pressure must be treated as a flammable liquid.

#### **6-15.1 Petroleum-Based Hydraulic Fluids.**

The following requirements must apply:

6-15.1.1 Provide automatic sprinklers directly over, and at least 6.1 m (20 ft) beyond, the hydraulic equipment. Complete sprinkler protection is required if the structure is of combustible construction. Sprinklers may be omitted near a single small system or multiple adjacent small systems not exceeding 380 L (100 gal) aggregate capacity, and if the construction is noncombustible and ignition sources are not normally present, and provisions exist for automatic or manual shutdown of the system(s).

6-15.1.2 An automatic switch, activated by sprinkler water flow alarm, fusible link, or other fire detector, must be provided to shut down the system if there is 380 L (100 gal) or more of hydraulic fluid.

#### **6-15.2 Hydraulic Test Systems.**

Hydraulic test systems must comply with the following:

6-15.2.1 For hydraulic systems that use pressures exceeding 1380 kPa (200 psi), SAE 1010 dead-soft, cold-drawn, seamless-steel tubing (or equivalent) must be used. A factor of safety of eight over normal working pressure must be used. For systems with working pressures in excess of 17,240 kPa (2,500 psi), a factor of safety of four over normal working pressure is acceptable. Tubing is preferable to pipe. Tubing can be bent to fit in restricted spaces with a minimum number of fittings, reducing the number of possible leakage points. Solderless, steel fittings of the flareless "locking-sleeve" type or flare type must be used.

6-15.2.2 Use of threaded pipe should be avoided. Where threaded connections are used, requirements of ANSI B1.20.1 *Pipe Thread* must be met. A safety factor of eight over maximum normal pressure must be used.

6-15.2.3 Tubing runs must have as few bends as possible, but should have at least one bend to provide for thermal expansion and contraction. The minimum radius of tube bend must be three tube diameters.

6-15.2.4 Where hose must be used for flexible connections, it must be steel reinforced, designed for the hydraulic fluid being used, and capable of withstanding five times the actual operating pressure. Hose couplings and fittings and minimum bending radius must be in accordance with the hose manufacturer's instructions. Hose must be installed so as not to rub against objects as a result of machine movement, vibration, or pressure surges.

6-15.2.5 Piping and tubing must be anchored or secured to minimize failure due to vibration. Pipe supports must not prevent normal thermal expansion.

6-15.2.6 There must be an accessible, well-marked, emergency shutoff switch for each pump.

6-15.2.7 Provide automatic shutoff switch to deactivate hydraulic pump upon loss of pressure.

## 6-16 **AIRCRAFT HANGARS.**

Requirements listed in this section are applicable to both fixed wing and rotary wing aircraft for fuel cell maintenance facilities, corrosion control and protective coating, and general-purpose maintenance hangars. These criteria apply to new hangars, the renovation or modernization of existing hangars, and permanent Tension Fabric Hangars. The passive fire protection and life safety requirements must comply with NFPA 101 and NFPA 409, *Standard on Aircraft Hangars*.

**Note 1:** For **Air Force** projects, refer to Air Force ETLs for requirements.

**Note 2:** For **Navy / Marine Corps** projects, refer to NAVFAC Interim Technical Guidance FY05-01, *Fire Protection for Navy and Marine Corps Aircraft Hangars*, dated 6 January 2005 for requirements.

**Note 3:** For **Army** helicopter hangar projects, refer to Army ETLs for requirements.

#### 6-16.1 **Tension Fabric Hangars.**

The minimum separation between tension fabric hangars and all other structures will be 30.5 m (100 ft), with a clear zone of 15.3 m (50 ft) immediately adjacent to the tension fabric structure. The clear zone cannot be used for storage and must be clear of vegetation (maintained lawn is permitted). The clear zone may be used as a street or driveway, but not for vehicle parking.

#### 6-17 **AIRCRAFT ACOUSTICAL ENCLOSURES.**

##### 6-17.1 **Complete Enclosures (Hush-House).**

Requirements are the same as those listed in paragraph 6-16, separate manual controls for actuation of each foam system provided in the control room.

**Exception:** **Air Force** installations containing approved gaseous fire extinguishing systems and high-expansion foam systems.

##### 6-17.2 **Out of Airframe Acoustical Enclosures (Test Cells).**

Provide the requirements for complete acoustical enclosures listed in paragraph 6-17.1. In lieu of an overhead AFFF system, the following may be provided:

6-17.2.1 An overhead water deluge system having a density of 14.3 L/min/m<sup>2</sup> (0.35 gpm/ft<sup>2</sup>) over the entire floor area; and a water spray system for the engine having a density of 20.4 L/min/m<sup>2</sup> (0.50 gpm/ft<sup>2</sup>) of engine surface area; and a water spray system for the floor area beneath the engine having a density of 20.4 L/min/m<sup>2</sup> (0.50 gpm/ft<sup>2</sup>) of floor area.

**Note 1:** The overhead deluge system need not extend into the area where the water spray systems for the engine and floor are present.

**Note 2:** For **Air Force** projects, the required density for the water deluge system is 0.01579 L/s (0.25 gpm) per square foot over the entire floor area, and no floor level water spray is required.

#### 6-18 **HYPERBARIC AND HYPOBARIC CHAMBERS.**

##### 6-18.1 **Hyperbaric Chambers.**



Conform hyperbaric chambers to NFPA 99, Chapter 20. Incorporate criteria contained in the following documents into the design of hyperbaric chambers.

- UFC 4-159-01N, *Hyperbaric Facilities*.
- SS 521-AA-MAN-010, *U.S. Navy, Diving and Manned Hyperbaric Systems Safety Certification Manual*.

#### 6-18.2      **Hypobaric Chambers .**

Conform hypobaric chambers to NFPA 99B, *Hypobaric Facilities*.

#### 6-19            **ANECHOIC CHAMBERS.**

Protect anechoic chambers in accordance with FM Global Data Sheet 1-53, *Anechoic Chambers*.

#### 6-20            **LIQUID OXYGEN (LOX).**

##### 6-20.1        **Fixed Liquid Oxygen Tanks.**

Use fixed tanks having combined capacity of 380 L (100 gal) or less and portable tanks conforming to NFPA 51, *Design and Installation of Oxygen-Fuel Gas Systems for Welding, Cutting, and Allied Processes*, and NFPA 99.

**Exception:** As modified in paragraph 6-20.2.

##### 6-20.2        **Oxygen Bulk Tanks.**

Use fixed bulk tanks having a single or combined capacity of more than 380 L (100 gal) that conform to NFPA 55, *Standard for the Storage, Use, and Handling of Compressed Gases and Cryogenic Fluids in Portable and Stationary Containers, Cylinders, and Tanks* and NFPA 99.

**Exception:** As modified in paragraph 6-20.3.

##### 6-20.3        **Separation Distances for LOX Tanks and Carts.**

Separation distances for LOX tanks and carts are as follows:

- A minimum of 30.5 m (100 ft) from aircraft parking, fueling, or servicing areas.
- A minimum of 30.5 m (100 ft) from any flammable or combustible liquids handling, servicing, processing, or storage area.
- A minimum of 15.3 m (50 ft) from any buildings of Type III, IV, or V construction.

- A minimum of 7.6 m (25 ft) from any buildings of Type I or Type II construction.

**6-20.4 Bulk Tank Vehicle Parking.**

Design parking for bulk tank vehicles servicing fixed tanks that meet the separation requirements of NFPA 55, for the fixed bulk tank.

**Exception:** As modified in paragraph 6-20.3.

**6-20.5 LOX Storage for Propellant Applications.**

Use liquid oxygen storage for propellant applications that comply with 29 CFR 1910.109, *Explosives and Blasting Agents*.

**Exception:** As modified in paragraph 6-20.3.

**6-21 DEPARTMENT OF DEFENSE DEPENDENT SCHOOLS (DODDS).**

DoDDS facilities must comply with paragraph 4-2.2 and with the educational occupancy in NFPA 101.

**6-22 VEHICLE PARKING, STORAGE, MAINTENANCE, AND REPAIR FACILITIES.**

Design facilities utilized for the parking, storage, maintenance, and repair of general and special purpose motor vehicles to comply with NFPA 88A, *Parking Structures* and/or NFPA 30A, *Code for Motor Fuel Dispensing Facilities and Repair Garages*.

**6-22.1 Vehicle Parking.**

Protect enclosed buildings used for vehicle parking and storage of 10 or more vehicles with an automatic sprinkler system.

**6-22.2 Overhaul and Repair Shops.**

Facilities falling within this category are those in which major overhaul and repairs are made to various types of equipment or their component parts. Disassembly and testing may also be performed in such facilities, which include aircraft shops, automotive garages and repair shops, and ship repair shops.

**6-22.2.1 Requirements.**

Design automotive garages to conform to NFPA30A. Design ship repair facilities to conform to NFPA 303 and NFPA 312. Design major aircraft overhaul and repair shops to conform to paragraph 6-16.

**6-22.3 Refueler Vehicle Facilities.**

Facilities that are covered and enclosed on at least three sides and that are used for the parking, storage, maintenance, and repair of aircraft refueler vehicles must:

6-22.3.1 Be protected by an automatic sprinkler system or a closed-head foam-water AFFF sprinkler system, and

6-22.3.2 Utilize Class I Division 2 electrical equipment and wiring as defined by NFPA 70.

**6-23 PESTICIDE STORAGE AND HANDLING FACILITIES.**

Locate facilities or operations involving the storage, mixing, or handling of non-flammable pesticides a minimum of 30.5 m (100 ft) from the nearest building or occupied structure.

**Exception 1:** Facilities of Type I construction as defined by the IBC, may be located less than 30.5 m (100 ft) from the nearest building or occupied structure, but not less than 9.1 m (30 ft) in any case.

**Exception 2:** Facilities protected by an automatic sprinkler system may be located less than 30.5 m (100 ft) from the nearest building or occupied structure, but not less than 9.1 m (30 ft) in any case.

**Exception 3:** Existing facilities involving the storage, mixing, or handling of non-flammable pesticides are permitted in a building when all the following are provided:

- The building is completely protected, including the pesticide area, by an automatic sprinkler system.
- The pesticide area is separated by not less than one-hour fire rated construction from the remainder of the building.
- Duct work that penetrates fire rated partitions and wall assemblies is provided with smoke and fire dampers.

**6-24 WINDOWLESS (LIMITED ACCESS) STRUCTURES.**

Windowless (limited access) structures are defined in and must conform to the requirements in NFPA 101. Provide windowless (limited access) structures three stories or more in height with a manually activated smoke exhaust system.

**6-24.1 Sprinkler Protection.**

Provide complete automatic sprinkler protection for all windowless (limited access) structures.

## **6-25 UNDERGROUND STRUCTURES.**

Underground structures are defined in and must conform to the requirements in NFPA 101. Provide underground structures that consist of two occupied levels or more, or that has an occupied level that is greater than 7.6 m (25 ft) below grade level, with a manually activated smoke exhaust system.

### **6-25.1 Sprinkler Protection.**

Provide complete automatic sprinkler protection for all occupiable underground structures.

## **6-26 GAS SERVICE.**

Install gas service mains in accordance with NFPA 54, *National Fuel Gas Code*, and NFPA 58, *Liquefied Petroleum Gas Code*. Gas service mains are not permitted within the perimeter of foundation lines. Provide natural draft cross ventilation for building crawl spaces containing gas service piping. Raise supply connections from the gas service mains above grade outside the foundation wall and pass through a full swing joint or loop of metallic tubing before entering the building. This will avoid pipe rupture in the event of differential settlement or earthquake. Locate pressure regulators outside of buildings or vent to the outside. Standards for heating system components common to all fuel systems are provided in NFPA 211, *Chimneys, Fireplaces, Vents, and Solid Fuel-Burning Appliances*. Related information is also available in the IBC. Use heating system devices listed by an NRTL.

## **6-27 COAL.**

### **6-27.1 Storage.**

Locate coal storage to comply with the following restrictions:

6-27.1.1 Do not locate coal storage in an area where contact with an external heat source is possible. Avoid locating storage near piping, flues, boiler walls, and over steam mains, even if buried. Coal must not be stored over or under fire service mains. Maintain a separation distance of at least 6.1 m (20 ft) from any fire service main.

6-27.1.2 Do not pile coal over manhole covers or covered pipe trenches that might allow air to find its way into the pile. Do not arrange piles of coal around or in contact with timbers, columns, or large pipes, as air may pass along these surfaces and produce a flue effect. Do not vent coal piles with pipes or flues.

6-27.1.3 Do not pile low-grade coal higher than 3 m (10 ft) and best grade coal not higher than 4.6 m (15 ft), unless they are piled by roll-packing method. Locate yard piles at least 15.3 m (50 ft) from other combustibles and important structures.

6-27.1.4 Construct coal bins, silos, or bunkers entirely of noncombustible material, preferably concrete. The structure should be roofed over to keep out rain and snow, and the space above the coal sufficiently ventilated to prevent the accumulation of gases given off by the coal. An elevated cone-shaped bin in which the coal is fed at the top and removed at the bottom is recommended. This arrangement prevents fine materials from collecting and remaining in the bin for long periods. The coal at the bottom, which is most likely to be troublesome, is the first to be removed. Coal bins, and when possible, bunkers and silos, should be emptied during the summer shutdowns and other prolonged idle periods. Provide automatic sprinkler protection if the existing storage facility has combustible construction or occupancy other than coal. Provide access openings for manual fire fighting operations.

6-27.1.5 Compact inactive coal piles, regardless of height to prevent spontaneous heating.

#### 6-27.2 **Handling.**

Provide the following where combustible conveyor belts are used to transport coal:

6-27.2.1 An automatic sprinkler system. Hydraulically design the system to operate 10 automatic sprinklers and 2 hand-held hose lines (e.g., two 35-mm (1-1/2-in) hose lines). Sprinkler coverage cannot exceed 9.3 m<sup>2</sup> (100 ft<sup>2</sup>) per sprinkler. The system must be designed using a pressure of 70 kPa (10 psi) on the end sprinkler. Water supply should be adequate for at least one-hour duration. Interlock systems with the belt drive to shut down on sprinkler water flow. In a conveyor enclosure less than 4.6 m (15 ft) wide, install a single line of sprinklers.

6-27.2.2 Provide either 35-mm (1-1/2-in) hose lines or hydrants at suitable intervals such that the entire belt is accessible for fire fighting.

6-27.2.3 Provide each conveyor belt system with tamperproof devices arranged to automatically shut off driving power in the event of greater than 20 percent belt slow down or misalignment of belts. Use interlocking devices to shut off power to contributing conveyors.

#### 6-27.3 **Pulverizing Equipment.**

In a pulverized fuel system, use components designed and constructed in accordance with requirements of NFPA 85, *Boiler and Combustion Systems Hazards Code*.

**6-28 POWER GENERATING AND UTILIZATION EQUIPMENT.**

In general, conform electrical installations NFPA 70, *National Electrical Code*. Specific details on the hazards of internal combustion engines, gas turbines, generators, and transformers are covered in the NFPA *Fire Protection Handbook* and the FM Global Data Sheets.

**6-28.1 Stationary Combustion Engines, Gas Turbines, and Generators.**

Install internal combustion engines, gas turbines, and generators following the requirements of NFPA 37, *Installation and Use of Stationary Combustion Engines and Gas Turbines*, except as modified by this UFC.

**6-28.1.1 Units Under 18.65 MW (25,000 Horsepower).**

In buildings without automatic sprinkler protection, enclose these units with 2-hour fire resistive construction or protect locally with automatic sprinklers. Automatic sprinklers connected to domestic water supplies are acceptable in accordance with NFPA 13.

**6-28.1.2 Units 18.65 MW (25,000 Horsepower) and Larger.**

In buildings without automatic sprinkler protection, enclose with 2-hour fire resistive construction and protect locally with automatic sprinklers. Automatic sprinklers connected to domestic water supplies are acceptable in accordance with NFPA 13.

**6-28.2 Transformers.****6-28.2.1 Indoor Transformers.**

Indoor transformers must be installed and located in accordance with NFPA 70, *National Electrical Code*.

**6-28.2.2 Outdoor Transformers.**

Outdoor Transformers must be installed and located in accordance with NFPA 70; ANSI/IEEE C2 *National Electrical Safety Code*; ANSI/IEEE 979, *Guide for Substation Fire Protection*; and ANSI/IEEE C57.12 series standards for transformers except as modified by this UFC:

- Where transformers are located on or above noncombustible roofs, suitable curbed and drained concrete mats or welded steel plates must be underneath units and located so as not to expose roof structures.
- Oil Filled transformers must no be installed on combustible roofs.

### 6-28.2.2.1 Outdoor Transformers Greater than 10,000KVA.

For transformers 10,000KVA and greater see FM Global Data Sheet 5-4, *Transformers*; NFPA 850, *Fire Protection for Electric Generating Plants and High Voltage Direct Current Converter Stations*; and ANSI/IEEE 979, for additional guidance.

### 6-28.2.2.2 Outdoor Liquid-Insulated Transformers.

Buildings or equipment exposed by outdoor transformers must be protected by separation, a fire barrier, or a water spray system on the transformers.

**Note:** The potential exposures from the insulating fluid pose the greatest risk for buildings and adjacent transformers.

#### 6-28.2.2.2.1 Building Separation Distance.

The separation distance between buildings and transformers must be as indicated in Table 6-1 (for **Navy** and **Air Force**) or Table 6-2 (for **Army**). The horizontal distance is measured from the transformer to the building.

**Table 6-1 (Navy and Air Force) Separation distance between outdoor insulated transformers and buildings**

Liquid	Liquid Volume gal (m <sup>3</sup> )	Horizontal Distance <sup>a</sup>			Vertical Distance <sup>1</sup> ft (m)
		Fire Resistant Construction ft (m)	Non- Combustible Construction ft (m)	Combustible Construction ft (m)	
Less Flammable	≤1,000 (3.8)	5 (1.5)	5 (1.5)	25 (7.6)	25 (7.6)
	>1,000 (3.8)	15 (4.6)	15 (4.6)	50 (15.2)	50 (15.2)
Mineral Oil	<500 (1.9)	5 (1.5)	15 (4.6)	25 (7.6)	25 (7.6)
	500 – 5,000 (1.9 – 19)	15 (4.6)	25 (7.6)	50 (15.2)	50 (15.2)
	>5,000 (19)	25 (7.6)	50 (15.2)	100 (30.5)	100 (30.5)

<sup>a</sup> If FM Approved transformers are used, the separation distances must follow the requirements of FM Global Loss Prevention Data Sheet 5-4, *Transformers*, which allows for reduced separation distances.

**Table 6-2 (Army) Separation distance between outdoor insulated transformers and buildings**

Liquid	Transformer Rating kVA	Horizontal Distance <sup>a</sup>			Vertical Distance <sup>1</sup> ft (m)
		Fire Resistant Construction ft (m)	Non-Combustible Construction ft (m)	Combustible Construction ft (m)	
Less Flammable	≤2000	5 (1.5)	5 (1.5)	25 (7.6)	25 (7.6)
	>2000	15 (4.6)	15 (4.6)	50 (15.2)	50 (15.2)
Mineral Oil (transformers made after 1970 except zigzag-type)	≤1000	5 (1.5)	15 (4.6)	25 (7.6)	25 (7.6)
	>1000	15 (4.6)	25 (7.6)	50 (15.2)	50 (15.2)
Mineral Oil (transformers made before 1970 & zigzag-type)	<650	5 (1.5)	15 (4.6)	25 (7.6)	25 (7.6)
	650 – 6500	15 (4.6)	25 (7.6)	50 (15.2)	50 (15.2)
	>6500	25 (7.6)	50 (15.2)	100 (30.5)	100 (30.5)

<sup>a</sup> If FM Approved transformers are used, the separation distances must follow the requirements of FM Global Loss Prevention Data Sheet 5-4, *Transformers*, which allows for reduced separation distances.

6-28.2.2.2.1.1 When the separation distance in Table 6-1 or Table 6-2 cannot be met, the following applies:

- There must be no window openings in first story walls within a horizontal distance of 3 m (10 feet) from the transformers. Existing window openings must be closed using brick or concrete block.
- Window openings in the first story beyond 3 m (10 ft) and up to the distance required in Table 6-1 or Table 6-2 horizontally from the transformers must be protected, using either wired glass in steel sash or glass block.
- Window openings in second and third story walls directly above the transformers must be protected using either wired glass in steel sash or glass block.
- Overhanging eaves, where they exist, must be noncombustible.

6-28.2.2.2.1.2 **Equipment Separation Distance.**

The separation distance between other equipment (including adjacent transformers) must be as indicated in Table 6-3 (For **Navy** and **Air Force**) or Table 6-4 (for **Army**)



**Table 6-3 (Navy and Air Force) separation distance between outdoor fluid insulated transformers and equipment (including other transformers)**

Liquid	Fluid Volume gal (m <sup>3</sup> )	Distance ft (m)
Less Flammable	≤1,000 (3.8)	5 (1.5)
	>1,000 (3.8)	25 (7.6)
Mineral Oil	<500 (1.9)	5 (1.5)
	500 – 5,000 (1.9 – 19)	25 (7.6)
	>5,000 (19)	50 (15.2)

**Table 6-4 (Army) separation distance between outdoor fluid insulated transformers and equipment (including other transformers)**

Liquid	Transformer Rating kVA	Distance ft (m)
Less Flammable	≤2000	5 (1.5)
	>2000	25 (7.6)
Mineral Oil (transformers made after 1970, except zigzag-type)	≤1,000	5 (1.5)
	>1000	25 (7.6)
Mineral Oil (transformers made before 1970 & zigzag-type)	<650	5 (1.5)
	650 – 6500	25 (7.6)
	>6500	50 (15.2)

**6-28.2.2.2.2 Fire Barriers.**

Fire barriers must be of concrete block or reinforced concrete construction adequate for 2-hour fire resistance.

**6-28.2.2.2.2.1 Buildings.**

6-28.2.2.2.2.1.1 When building walls are used for protection, the exposed wall must extend the horizontal and vertical distances from the transformer specified in Table 6-1 or Table 6-2.

6-28.2.2.2.2.1.2 Roofs exposed to mineral oil insulated transformers must be Class A rated for the exposed area. The exposed area is considered to be the following:

- 4.6 m (15 ft) from a transformer containing 3.8 to 19 m<sup>3</sup> (1,000 to 5,000 gallons) of mineral oil where roofs are less than 7.76 m (25 ft) high.

- 7.6 m (25 ft) from a transformer containing more than 19 m<sup>3</sup> (5,000 gallons) where roofs are less than 15 m (50 ft) high.

#### 6-28.2.2.2.2.2 **Equipment.**

For equipment, barriers must extend 0.3m (1 ft) vertically and 0.6m (2 ft) horizontally beyond transformer components that could be pressurized as the result of an electrical fault. This will typically include bushings, pressure relief vents, radiators, tap changer enclosures, and other similar devices.

#### 6-28.2.2.2.3 **Water Spray Exposure Protection.**

##### 6-28.2.2.2.3.1 **Buildings.**

6-28.2.2.2.3.1.1 If water spray or automatic sprinkler protection is used for building protection, a discharge density of 8.2 L/min/m<sup>2</sup> (0.20 gpm/ft<sup>2</sup>) must be used over the exposed surface.

6-28.2.2.2.3.1.2 The water supply must be adequate for 2 hours and must include a hose stream demand of 1900 L/min (500 gpm).

##### 6-28.2.2.2.3.2 **Equipment.**

6-28.2.2.2.3.2.1 For multiple transformer installations the water spray system must be designed based on simultaneous operation of the water spray systems for the adjacent transformers.

6-28.2.2.2.3.2.2 Design the water spray system to provide a density of 10.2 L/min/m<sup>2</sup> (0.25 gpm/ft<sup>2</sup>) over transformer surfaces, except areas under the transformer in accordance with FM Global Data Sheet 4-1N, *Water Spray Fixed Systems*.

6-28.2.2.2.3.2.3 When the ground around the transformer is non-absorbing, water spray must be provided at a density of 6.1 L/min/m<sup>2</sup> (0.15 gpm/ft<sup>2</sup>) for the diked area or for a distance of 3 m (10 ft) from the transformer in all directions.

6-28.2.2.2.3.2.4 Components of the water spray system, such as piping, spray nozzles, and other components must be a minimum of 45.7 cm (18 in) from the transformer.

6-28.2.2.2.3.2.5 Piping must not pass over the top of the transformer or be exposed by tank relief vents.

6-28.2.2.2.3.2.6 Do not direct water spray nozzles at bushings.

#### 6-29 **TRASH COLLECTION AND DISPOSAL FACILITIES.**

##### 6-29.1 **Central Trash Collection and Dumpsters.**

Place central trash collection units and dumpsters 15 feet (4.6 m) or more away from wood frame or metal buildings or from openings in masonry-walled buildings.

#### 6-29.2 **Collection, Baling, and Storage Rooms.**

For mixed occupancy facilities, provide 2-hour fire resistive construction for collection, baling, and storage rooms and protect with automatic sprinklers.

#### 6-29.3 **Trash Chutes.**

Equip trash chutes in buildings with automatic sprinklers. In non-sprinklered buildings, trash chute sprinkler systems may be connected to the domestic water system.

### 6-30 **PROTECTION OF ELEVATOR MACHINE ROOMS AND HOISTWAYS.**

#### 6-30.1 **Fire Resistant Construction.**

For **Navy** and **DLA** projects, provide 2-hour fire resistant construction for all elevator hoistways.

**Exception:** Existing buildings that are being renovated, with existing elevator shafts not being modified and that do not require 2-hour rated fire resistant construction in accordance with the *IBC*.

#### 6-30.2 **Detection System.**

Provide smoke detectors at:

- All elevator lobbies.
- All elevator machine rooms.
- Top of the hoistway. (Only if sprinklers are provided at the top of the hoistway.)

6-30.2.1 Provide listed control relays within 0.91 m (3 ft) of the elevator controller to provide a supervised interface between the fire alarm system and the elevator controller as required by NFPA 72. The wiring between the control relays and the fire alarm control unit shall be monitored for integrity as required by NFPA 72.

6-30.2.2 Activation of any elevator machine room, hoistway, or lobby smoke detector must activate the building fire alarm system and send the affected elevators to the designated floor.

6-30.2.3 Activation of a lobby smoke detector must cause the Firefighter's Service visual signal to constantly illuminate in any elevator cab that serves the affected lobby. Activation of an elevator machine room or hoistway smoke detector must cause the Firefighter's Service visual signal to illuminate intermittently (flash) in any elevator cab which has equipment located in the affected machine room or hoistway, as required by ASME A17.1.

**6-30.3 Electric Traction Elevators.**

For buildings protected with an automatic sprinkler system, provide sprinkler(s) with sprinkler guard(s) in the machine room(s). Provide a supervised shut-off valve, check valve, flow switch, and test valve in the sprinkler line supplying the machine room(s). These items must be located outside of and adjacent to the machine room(s). Actuation of the flow switch must remove power to the elevator(s), served by that machine room, by shunt trip breaker operation. The flow switch must have no time delay. See Table 6-5 and Figure 6-7.

**Table 6-5 ELECTRIC TRACTION ELEVATOR**

ROOM / AREA	PROVIDE SPRINKLER (Not Applicable for Buildings Without Sprinkler Protection)	PROVIDE SMOKE DETECTOR to INITIATE ELEVATOR FIREFIGHTERS SERVICE and BUILDING FIRE ALARM SYSTEM
PENTHOUSE MACHINE ROOM	YES	YES
ELEVATOR LOBBIES	YES	YES
PIT AREA	NO	NO
TOP of HOISTWAY	NO *	NO *
* Provide sprinklers and smoke detector where existing hoistway walls are not 2 hour rated, and existing elevator cab does not meet flame spread or smoke development requirements of ASME A 17.1. These sprinklers must follow the requirements of paragraphs 6-29.4.3 and 6-29.5.		

Figure 6-7 Electric Traction Elevator

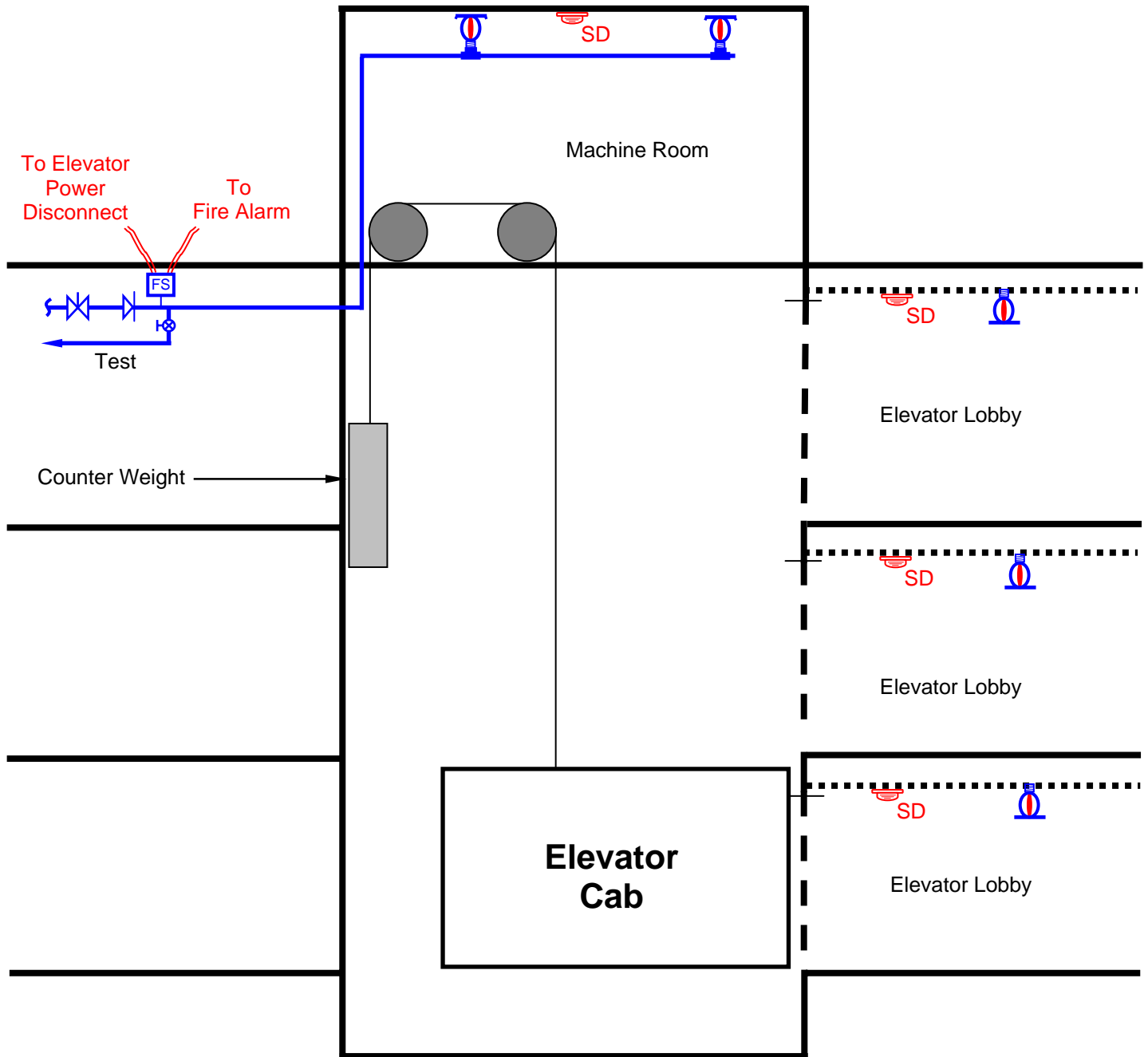

**6-30.4 Hydraulic Elevators.**

In buildings protected with an automatic sprinkler system, provide the following (see Tables 6-6 and 6-7, and Figures 6-8, 6-9, and 6-10):

**6-30.4.1 Machine Room:**

Provide sprinkler(s) with sprinkler guard(s) in the machine room(s). Provide a supervised shut-off valve, check valve, flow switch, and test valve in the sprinkler line supplying the machine room(s). These items must be located outside of and adjacent to the machine room(s). Actuation of the flow switch must remove power to the elevator(s), served by that machine room, by shunt trip breaker operation. The flow switch must have no time delay.

**6-30.4.2 Elevator Pit:**

Provide a sidewall sprinkler(s) with sprinkler guards in the pit for hydraulic elevators. Locate the sprinkler no more than 610 mm (2 ft) above the pit floor. Provide a supervised shut-off valve in the sprinkler line supplying the pit. Locate the valve outside of and adjacent to the pit. Actuation of the pit sprinkler must not disconnect power to the elevator.

**6-30.4.3 Top of Elevator Hoistway:**

When a sprinkler is provided at the top of the hoistway, provide a supervised shut-off valve, check valve, flow switch, and test valve in the sprinkler line supplying the hoistway. These items must be located outside of and adjacent to the hoistway. Actuation of the flow switch must disconnect power to the elevator by shunt trip breaker operation. Flow switch must have no time delay.

Table 6-6 DIRECT PLUNGER HYDRAULIC ELEVATOR

ROOM / AREA	PROVIDE SPRINKLER (Not Applicable for Buildings Without Sprinkler Protection)	PROVIDE SMOKE DETECTOR to INITIATE ELEVATOR FIREFIGHTERS SERVICE and BUILDING FIRE ALARM SYSTEM
MACHINE ROOM	YES	YES
ELEVATOR LOBBIES	YES	YES
PIT AREA	YES	NO
TOP of HOISTWAY	NO *	NO *
* Provide sprinklers and smoke detector where existing hoistway walls are not 2 hour rated, and existing elevator cab does not meet flame spread or smoke development requirements of ASME A 17.1. These sprinklers must follow the requirements of paragraphs 6-29.4.3 and 6-29.5.		

Table 6-7 HOLELESS HYDRAULIC and ROPED HYDRAULIC ELEVATOR

ROOM / AREA	PROVIDE SPRINKLER (Not Applicable for Buildings Without Sprinkler Protection)	PROVIDE SMOKE DETECTOR to INITIATE ELEVATOR FIREFIGHTERS SERVICE and BUILDING FIRE ALARM SYSTEM
MACHINE ROOM	YES	YES
ELEVATOR LOBBIES	YES	YES
PIT AREA	YES	NO
TOP of HOISTWAY	YES	YES

### 6-30.5 Flow Switch Test Connection.

Provide inspector's test connection for each water flow switch associated with the elevator machine room and/or elevator hoistway sprinklers. Locate the test connection outside the rated enclosure. Route test connection piping to a floor drain location that can accept full flow or where water may be discharged without property damage. Discharge to a floor drain may be permitted only if the drain is

**UFC 3-600-01**  
**26 September 2006**

sized to accommodate full flow. Discharge to janitor sinks or similar plumbing fixtures is not permitted.

**6-30.6 Italy.**

For Italian construction projects, sprinkler protection must not be provided in the elevator hoistway, pit, or machine room. Italian law prohibits sprinklers in these locations.



Figure 6-8 Direct Plunger Hydraulic Elevator

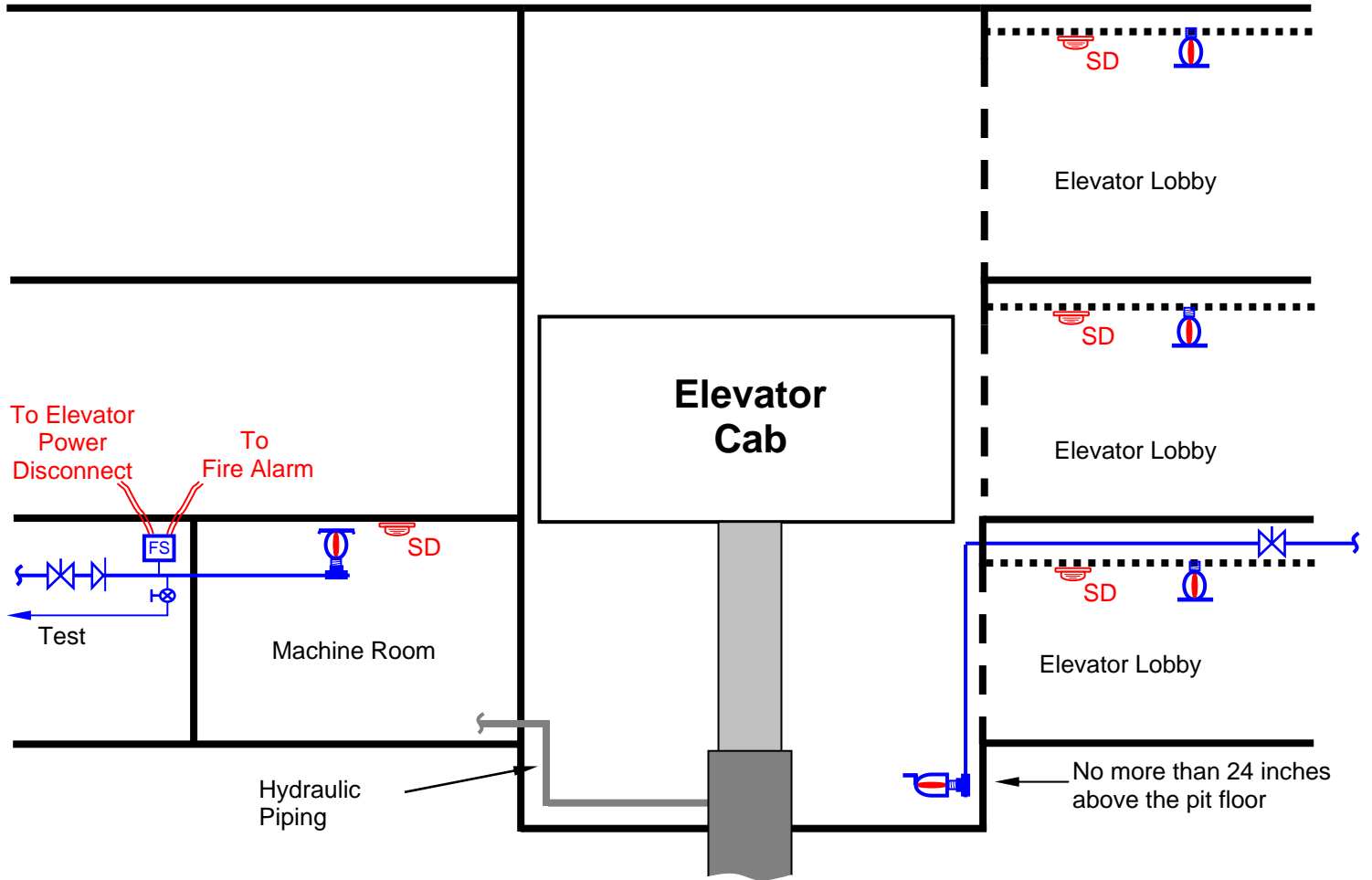

Figure 6-9 Direct Plunger Hydraulic Elevator – Hydraulic Supply Piping Extending above the Second Finished Floor Elevation

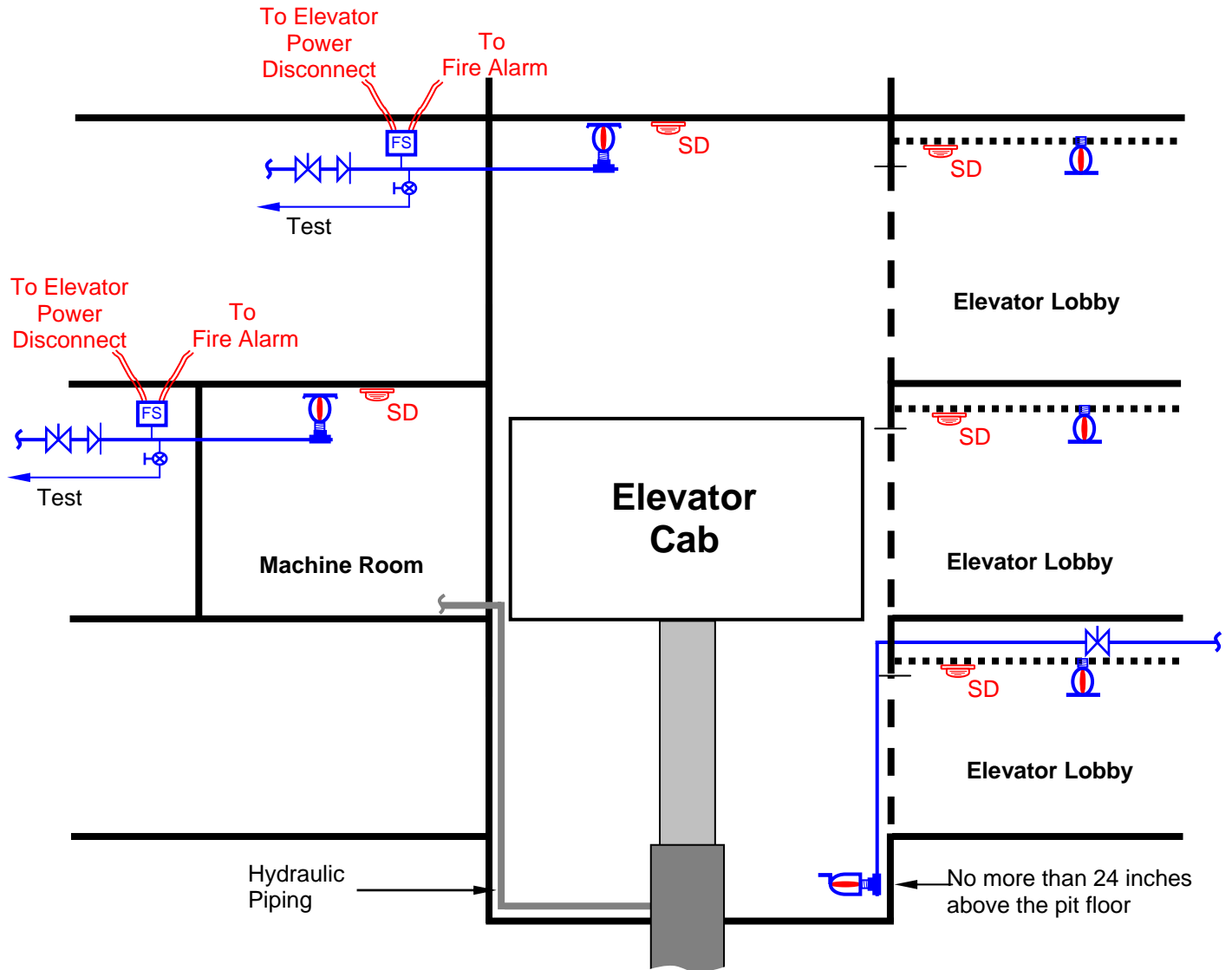
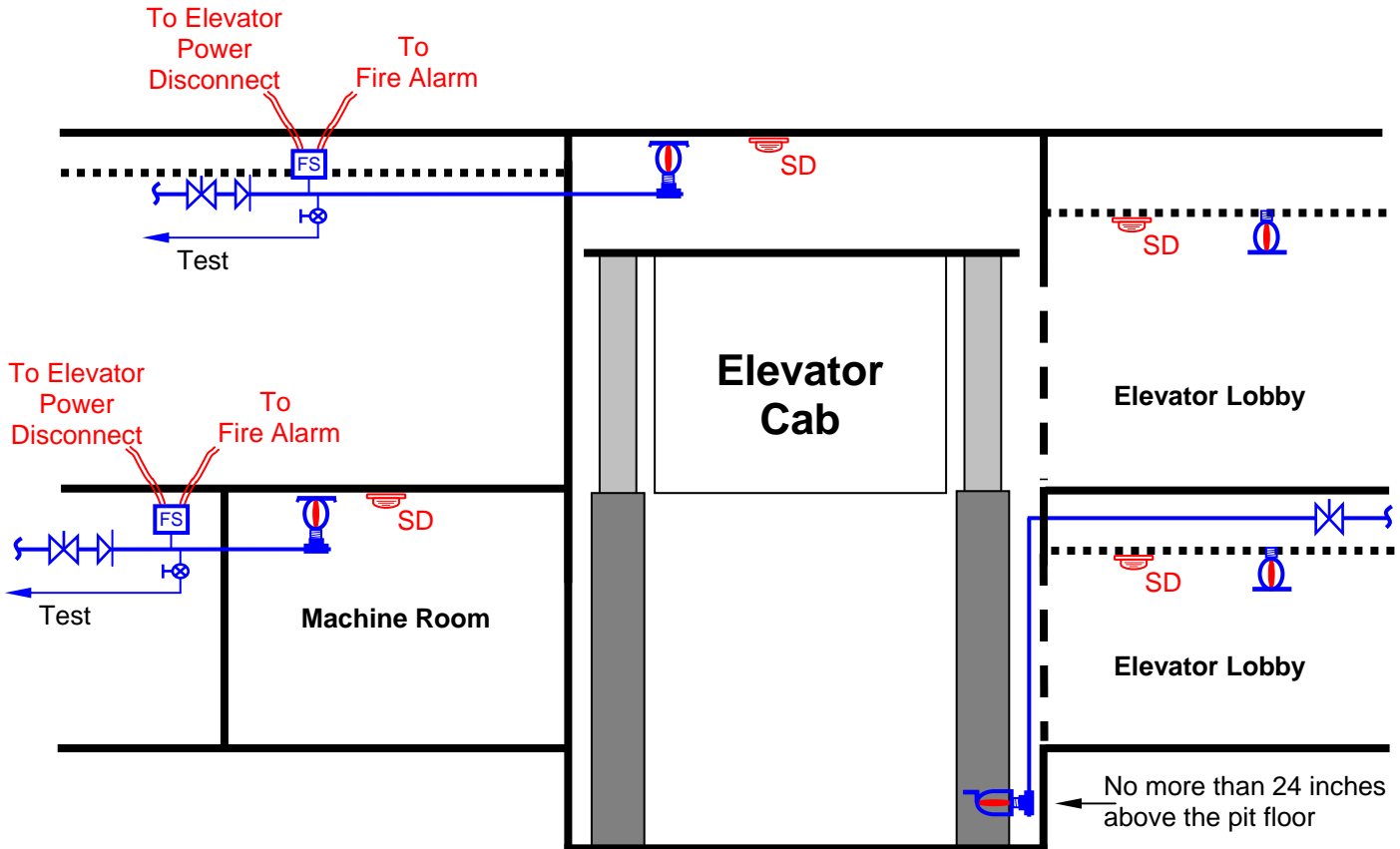

Figure 6-10 Holeless Hydraulic Elevator



## 6-31 TENSION FABRIC STRUCTURES

### 6-31.1 Separation of, and Basic Allowable Area.

To determine the allowable area and separation requirements for all permanent tension fabric structures, follow the requirements of Table 6-8. The separation area will be a clear zone adjacent to the tension fabric structure. The clear zone cannot be used for storage and must be clear of vegetation (maintained lawn is permitted). The clear zone may be used as a street or driveway, but not for vehicle parking.

### 6-31.2 Definitions:

6-31.2.1 Tension Membrane Structure (from NFPA 102, *Grandstands, Folding and Telescopic Seating, Tents, and Membrane Structures*): A membrane structure incorporating a membrane and a structural support system such as arches, columns, and cables, or beams wherein the stresses developed

in the tension membrane interact with those in the structural support so that the entire assembly acts together to resist the applied loads.

6-31.2.2 Permanent Building (from NFPA 102): A building that is intended to remain in place for a period of 180 days or more.

6-31.2.3 Temporary Building (from NFPA 102): A building that is intended to remain in place for less than 180 consecutive calendar days.

6-31.2.4 Noncombustible Material (from NFPA 102): A material that, in the form in which it is used and under the conditions anticipated, will not ignite, burn, support combustion, or release flammable vapors, when subjected to fire or heat. Materials that are reported as passing ASTM E 136, *Standard Test Method for Behavior of Materials in a Vertical Tube Furnace at 750°C*, must be considered noncombustible materials.

**Table 6-8 BASIC ALLOWABLE AREA for TENSION MEMBRANE/FABRIC STRUCTURES**

in Square Meters (Square Feet)

SEPARATION DISTANCES	TYPE of CONSTRUCTION			
	II - B <sup>a</sup>		V - B	
	Sprinkler Protection	No Sprinkler Protection	Sprinkler Protection	No Sprinkler Protection
6 m (20 ft)	3,344 (36,000)	1,114 (12,000)	2,229 (24,000)	743 (8,000)
12 m (40 ft)	6,689 (72,000)	2,229 (24,000)	4,459 (48,000)	1,486 (16,000)
18 m (60 ft)	UNLIMITED	UNLIMITED	UNLIMITED	UNLIMITED
<sup>a</sup> As defined in paragraph 6-31.2.4				

### 6-31.3 Other Requirements.

Tension membrane/fabric structures must meet the life safety, fire protection, and allowable area requirements for the specific occupancy, in accordance with the other provisions of this UFC.

### 6-31.4 Tension Fabric Hangars.

Tension Fabric Hangars must comply with paragraph 6-16.

## 6-32 COMMISSARIES AND EXCHANGES.

Commissaries and exchanges greater than 464.5m<sup>2</sup> (5,000 ft<sup>2</sup>) gross floor area must be provided with automatic sprinkler protection.

**6-33 MORALE WELFARE AND RECREATION FACILITIES.**

Clubs including officer, non-commissioned officer, and enlisted; bowling centers, craft shops including hobby shops, woodworking, auto centers, and similar facilities must be protected with automatic sprinkler systems.

**6-34 MULTISTORY BUILDINGS.**

Building two stories or greater, measured from the lowest grade, accessible to people with severe mobility impairment must be protected with automatic sprinklers.

**6-34.1 Building Four Stories or Greater.**

Building four stories or greater, measured from the lowest grade, regardless of occupancy must be protected with automatic sprinklers.

**6-35 COMBUSTIBLE CONSTRUCTION.**

Facilities of Type III, Type IV and Type V construction three or more stories in height must be protected with automatic sprinklers systems.

**6-35.1 Renovation.**

Any renovation of existing building of Type III, Type IV and Type V construction over 465 m<sup>2</sup> (5,000 ft<sup>2</sup>) must include automatic sprinkler protection.

**6-36 MISSILE ALERT FACILITIES (MAF).**

MAFs are the aboveground facilities that support underground ballistic missile launch control centers.

**6-36.1 Sprinkler Protection.**

Protect all missile alert facilities with a sprinkler system designed and installed in accordance with National Fire Protection Association 13R, *Standard for the Installation of Sprinkler Systems in Residential Occupancies up to and Including Four Stories in Height*. Systems must be supplied from the existing domestic water storage tank. Use dry-pendant or dry-sidewall heads or anti-freeze runs for rooms/spaces exposed to freezing temperatures.

**6-36.2 Heat Detectors.**

Thermal detection devices must be provided in rooms, areas and spaces that are not protected by automatic sprinkler protection in accordance with NFPA 13R.

**6-36.3 Fire Hydrants.**

Provide a dry fire hydrant installed on the domestic water tank to allow local fire departments the ability to draft firefighting water during emergencies.

**6-37            EMERGENCY SERVICES COMMUNICATIONS CENTERS.**

Facilities and equipment which are used for the receipt of alarm signals and telephone calls for assistance, and dispatching of fire, police, or emergency medical services personnel and equipment shall comply with NFPA 1221, *Installation Maintenance, and Use of Emergency Services Communications Systems*.

**6-38            HIGH RISE BUILDINGS.**

High rise buildings must comply with NFPA 101 and:

- The central control station must have exterior and interior access, a 1-hour fire rated barrier, and must be a minimum of 9 m<sup>2</sup> (96 ft<sup>2</sup>) with a minimum dimension of 2.4 m (8 ft),
- The central control station must also include air-handling system status indicators and controls, a fire department control panel for smoke control systems (includes visual status indicators and controls), and schematic building plans indicating the typical floor plan and detailing the building core, means of egress, fire protection systems, fire-fighting equipment and fire department access.
- Provide smoke proof enclosures.

## **APPENDIX A REFERENCES**

- 29 CFR 1910.27, *Fixed Ladders*, National Archives and Records Administration (NARA), <http://www.gpoaccess.gov/cfr/index.html>
- 29 CFR 1910.109, *Explosives and Blasting Agents*, National Archives and Records Administration (NARA), <http://www.gpoaccess.gov/cfr/index.html>
- 385-100, *Safety Manual*, Department of the Army, Standardization Documents Order Desk, 700 Robbins Avenue, Bldg 4D, Philadelphia, PA, 19111-5094
- A17.1, *Safety Code for Elevators and Escalators*, ASME International, Three Park Ave. New York, NY, 10016-5990, 1-800-843-2763
- ADAAG, *Americans with Disabilities Act Accessibility Guidelines*, United States Access Board, <http://www.access-board.gov/adaag/html/adaag.htm>
- AFMAN 91-201, *Explosives Safety Standard*, Department of the Air Force, <http://www.e-publishing.af.mil/>
- AR 385-64, *Explosives Safety Program*, Department of the Army, Standardization Documents Order Desk, 700 Robbins Avenue, Bldg 4D, Philadelphia, PA, 19111-5094
- ASTM E 84, *Standard Method of Test of Surface Burning Characteristics of Building Materials*, American Society for Testing and Materials (ASTM), 100 Barr Harbor Dr., West Conshohocken, PA, 19428, [www.astm.org](http://www.astm.org)
- ASTM E 119, *Standard Test Methods for Fire Tests of Building Construction and Materials*, American Society for Testing and Materials (ASTM), 100 Barr Harbor Dr., West Conshohocken, PA, 19428, [www.astm.org](http://www.astm.org)
- ASTM E 136, *Standard Test Method for Behavior of Materials in a Vertical Tube Furnace at 750°C*, American Society for Testing and Materials (ASTM), 100 Barr Harbor Dr., West Conshohocken, PA, 19428, [www.astm.org](http://www.astm.org)
- ASTM E 814, *Standard Test Method for Fire Tests of Through-Penetration Fire Stops*, American Society for Testing and Materials (ASTM), 100 Barr Harbor Dr., West Conshohocken, PA, 19428, [www.astm.org](http://www.astm.org)
- B1.20.1, *Pipe Thread*, American National Standards Institute (ANSI), 1819 L Street, NW, 6th Floor, Washington, DC, 20036, [www.ansi.org](http://www.ansi.org)
- DOD 6055.9-STD, *DOD Ammunition and Explosives Safety Standards*, Department of Defense, Washington Headquarters Service, <http://www.dtic.mil/whs/directives/>

**UFC 3-600-01**  
**26 September 2006**

EM-385-1-1, *Safety and Health Requirements Manual*, Department of the Army, Standardization Documents Order Desk, 700 Robbins Avenue, Bldg 4D, Philadelphia, PA, 19111-5094

FED-STD-795, *Uniform Federal Accessibility Act*, United States Access Board, <http://www.access-board.gov/ufas/ufas-html/ufas.htm>

FMDS 1-20, *Protection Against Exterior Fire Exposure*, Factory Mutual Global (FM), 1301 Atwood Ave., PO Box 7500, Johnston, RI, 02919

FMDS 1-23, *Protection of Openings in Fire Subdivisions*, Factory Mutual Global (FM), 1301 Atwood Ave., PO Box 7500, Johnston, RI, 02919

FMDS 1-53, *Anechoic Chambers*, Factory Mutual Global (FM), 1301 Atwood Ave., PO Box 7500, Johnston, RI, 02919

FMDS 5-4, *Transformers*, Factory Mutual Global (FM), 1301 Atwood Ave., PO Box 7500, Johnston, RI, 02919

FMDS 8-33, *Carousel Storage and Retrieval Systems*, Factory Mutual Global (FM), 1301 Atwood Ave., PO Box 7500, Johnston, RI, 02919

*Guidance for Family Housing Master Plans*, (memorandum) 14 January 2002, Office of the Under Secretary of Defense,

*International Building Code* (IBC), International Code Council (ICC), 5203 Leesburg Pike, Suite 600, Falls Church, VA, 22041, [www.icc-safe.org](http://www.icc-safe.org)

Manual M 14, *Recommended Practice for Backflow Prevention and Cross Connection Control*, American Water Works Association (AWWA), 6666 W. Quincy Ave., Denver, CO, 80235

Manual M31, *Distribution System Requirements for Fire Protection*, American Water Works Association (AWWA), 6666 W. Quincy Ave., Denver, CO, 80235

MIL-F-24385F, *Fire Extinguishing Agent, Aqueous Film-forming Foam (AFFF) Liquid Concentrate, for Fresh and Seawater*, Department of the Navy, Standardization Documents Order Desk, 700 Robbins Ave, Bldg 4D, Philadelphia, PA, 19111-5094

NAVSEA OP-5, *Ammunition and Explosives Ashore Safety Regulations for Handling, Storing, Production, Renovation, and Shipping*,

NFPA 1, *Fire Prevention Code*, National Fire Protection Association (NFPA), 1 Batterymarch Park, Quincy, MA, 02269-9101, [www.nfpa.org](http://www.nfpa.org)

NFPA 10, *Portable Fire Extinguishers*, National Fire Protection Association (NFPA), 1 Batterymarch Park, Quincy, MA, 02269-9101, [www.nfpa.org](http://www.nfpa.org)



**UFC 3-600-01**  
**26 September 2006**

NFPA 11, *Low-Expansion Foam*, National Fire Protection Association (NFPA), 1 Batterymarch Park, Quincy, MA, 02269-9101, [www.nfpa.org](http://www.nfpa.org)

NFPA 11A, *Medium- and High-Expansion Foam Systems*, National Fire Protection Association (NFPA), 1 Batterymarch Park, Quincy, MA, 02269-9101, [www.nfpa.org](http://www.nfpa.org)

NFPA 12, *Carbon Dioxide Extinguishing Systems*, National Fire Protection Association (NFPA), 1 Batterymarch Park, Quincy, MA, 02269-9101, [www.nfpa.org](http://www.nfpa.org)

NFPA 13, *Installation of Sprinkler Systems*, National Fire Protection Association (NFPA), 1 Batterymarch Park, Quincy, MA, 02269-9101, [www.nfpa.org](http://www.nfpa.org)

NFPA 13R, *Sprinkler Systems in Residential Occupancies up to and Including Four Stories in Height*, National Fire Protection Association (NFPA), 1 Batterymarch Park, Quincy, MA, 02269-9101, [www.nfpa.org](http://www.nfpa.org)

NFPA 13D, *Installation of Sprinkler Systems in One- and Two-Family Dwellings and Manufactured Homes*, National Fire Protection Association (NFPA), 1 Batterymarch Park, Quincy, MA, 02269-9101, [www.nfpa.org](http://www.nfpa.org)

NFPA 14, *Installation of Standpipe, Private Hydrant, and Hose Systems*, National Fire Protection Association (NFPA), 1 Batterymarch Park, Quincy, MA, 02269-9101, [www.nfpa.org](http://www.nfpa.org)

NFPA 15, *Water Spray Fixed Systems for Fire Protection*, National Fire Protection Association (NFPA), 1 Batterymarch Park, Quincy, MA, 02269-9101, [www.nfpa.org](http://www.nfpa.org)

NFPA 16, *Installation of Foam-Water Sprinkler and Foam-Water Spray Systems*, National Fire Protection Association (NFPA), 1 Batterymarch Park, Quincy, MA, 02269-9101, [www.nfpa.org](http://www.nfpa.org)

NFPA 17, *Dry Chemical Extinguishing Systems*, National Fire Protection Association (NFPA), 1 Batterymarch Park, Quincy, MA, 02269-9101, [www.nfpa.org](http://www.nfpa.org)

NFPA 17A, *Wet Chemical Extinguishing Systems*, National Fire Protection Association (NFPA), 1 Batterymarch Park, Quincy, MA, 02269-9101, [www.nfpa.org](http://www.nfpa.org)

NFPA 20, *Standard for the Installation of Stationary Pumps for Fire Protection*, National Fire Protection Association (NFPA), 1 Batterymarch Park, Quincy, MA, 02269-9101, [www.nfpa.org](http://www.nfpa.org)

NFPA 24, *Installation of Private Fire Service Mains and Their Appurtenances*, National Fire Protection Association (NFPA), 1 Batterymarch Park, Quincy, MA, 02269-9101, [www.nfpa.org](http://www.nfpa.org)

- NFPA 30, *Flammable and Combustible Liquids Code*, National Fire Protection Association (NFPA), 1 Batterymarch Park, Quincy, MA, 02269-9101, [www.nfpa.org](http://www.nfpa.org)
- NFPA 30A, *Code for Motor Fuel Dispensing Facilities and Repair Garages*, National Fire Protection Association (NFPA), 1 Batterymarch Park, Quincy, MA, 02269-9101, [www.nfpa.org](http://www.nfpa.org)
- NFPA 37, *Installation and Use of Stationary Combustion Engines and Gas Turbines*, National Fire Protection Association (NFPA), 1 Batterymarch Park, Quincy, MA, 02269-9101, [www.nfpa.org](http://www.nfpa.org)
- NFPA 51, *Design and Installation of Oxygen-Fuel Gas Systems for Welding, Cutting, and Allied Processes*, National Fire Protection Association (NFPA), 1 Batterymarch Park, Quincy, MA, 02269-9101, [www.nfpa.org](http://www.nfpa.org)
- NFPA 54, *National Fuel Gas Code*, National Fire Protection Association (NFPA), 1 Batterymarch Park, Quincy, MA, 02269-9101, [www.nfpa.org](http://www.nfpa.org)
- NFPA 55, *Standard for the Storage, Use, and Handling of Compressed Gases and Cryogenic Fluids in Portable and Stationary Containers, cylinders, and Tanks*, National Fire Protection Association (NFPA), 1 Batterymarch Park, Quincy, MA, 02269-9101, [www.nfpa.org](http://www.nfpa.org)
- NFPA 58, *Liquefied Petroleum Gas Code*, National Fire Protection Association (NFPA), 1 Batterymarch Park, Quincy, MA, 02269-9101, [www.nfpa.org](http://www.nfpa.org)
- NFPA 70, *National Electric Code*, National Fire Protection Association (NFPA), 1 Batterymarch Park, Quincy, MA, 02269-9101, [www.nfpa.org](http://www.nfpa.org)
- NFPA 72, *National Fire Alarm Code*, National Fire Protection Association (NFPA), 1 Batterymarch Park, Quincy, MA, 02269-9101, [www.nfpa.org](http://www.nfpa.org)
- NFPA 75, *Protection of Electronic Computer/Data Processing Equipment*, National Fire Protection Association (NFPA), 1 Batterymarch Park, Quincy, MA, 02269-9101, [www.nfpa.org](http://www.nfpa.org)
- NFPA 80, *Fire Doors and Fire Windows*, National Fire Protection Association (NFPA), 1 Batterymarch Park, Quincy, MA, 02269-9101, [www.nfpa.org](http://www.nfpa.org)
- NFPA 80A, *Protection of Buildings From Exterior Fire Exposures*, National Fire Protection Association (NFPA), 1 Batterymarch Park, Quincy, MA, 02269-9101, [www.nfpa.org](http://www.nfpa.org)
- NFPA 88A, *Parking Structures*, National Fire Protection Association (NFPA), 1 Batterymarch Park, Quincy, MA, 02269-9101, [www.nfpa.org](http://www.nfpa.org)

**UFC 3-600-01**  
**26 September 2006**

NFPA 90A, *Installation of Air-Conditioning and Ventilating Systems*, National Fire Protection Association (NFPA), 1 Batterymarch Park, Quincy, MA, 02269-9101, [www.nfpa.org](http://www.nfpa.org)

NFPA 90B, *Installation of Warm Air Heating and Air-Conditioning Systems*, National Fire Protection Association (NFPA), 1 Batterymarch Park, Quincy, MA, 02269-9101, [www.nfpa.org](http://www.nfpa.org)

NFPA 96, *Ventilation control and Fire Protection of Commercial Cooking Operations*, National Fire Protection Association (NFPA), 1 Batterymarch Park, Quincy, MA, 02269-9101, [www.nfpa.org](http://www.nfpa.org)

NFPA 99, *Health Care Facilities*, National Fire Protection Association (NFPA), 1 Batterymarch Park, Quincy, MA, 02269-9101, [www.nfpa.org](http://www.nfpa.org)

NFPA 99B, *Hypobaric Facilities*, National Fire Protection Association (NFPA), 1 Batterymarch Park, Quincy, MA, 02269-9101, [www.nfpa.org](http://www.nfpa.org)

NFPA 101, *Life Safety Code*, National Fire Protection Association (NFPA), 1 Batterymarch Park, Quincy, MA, 02269-9101, [www.nfpa.org](http://www.nfpa.org)

NFPA 102, *Grandstands, Folding and Telescopic Seating, Tents, and Membrane Structures*, National Fire Protection Association (NFPA), 1 Batterymarch Park, Quincy, MA, 02269-9101, [www.nfpa.org](http://www.nfpa.org)

NFPA 211, *Chimneys, fireplaces, Vents, and Solid Fuel-Burning Appliances*, National Fire Protection Association (NFPA), 1 Batterymarch Park, Quincy, MA, 02269-9101, [www.nfpa.org](http://www.nfpa.org)

NFPA 220, *Types of Building Construction*, National Fire Protection Association (NFPA), 1 Batterymarch Park, Quincy, MA, 02269-9101, [www.nfpa.org](http://www.nfpa.org)

NFPA 230, *Standards for the Fire Protection of Storage*, National Fire Protection Association (NFPA), 1 Batterymarch Park, Quincy, MA, 02269-9101, [www.nfpa.org](http://www.nfpa.org)

NFPA 241, *Safeguarding Construction, Alteration, and Demolition Operations*, National Fire Protection Association (NFPA), 1 Batterymarch Park, Quincy, MA, 02269-9101, [www.nfpa.org](http://www.nfpa.org)

NFPA 255, *Standard Method of Test of Surface Burning Characteristics of Building Materials*, National Fire Protection Association (NFPA), 1 Batterymarch Park, Quincy, MA, 02269-9101, [www.nfpa.org](http://www.nfpa.org)

NFPA 256, *Fire Test of Roof Coverings*, National Fire Protection Association (NFPA), 1 Batterymarch Park, Quincy, MA, 02269-9101, [www.nfpa.org](http://www.nfpa.org)

**UFC 3-600-01**  
**26 September 2006**

- NFPA 303, *Fire Protection Standard for Marinas and Boatyards*, National Fire Protection Association (NFPA), 1 Batterymarch Park, Quincy, MA, 02269-9101, [www.nfpa.org](http://www.nfpa.org)
- NFPA 307, *Construction and Fire Protection of Marine Terminals, Piers, and Wharves*, National Fire Protection Association (NFPA), 1 Batterymarch Park, Quincy, MA, 02269-9101, [www.nfpa.org](http://www.nfpa.org)
- NFPA 312, *Fire Protection of Vessels During Construction, Repair, and Lay-Up*, National Fire Protection Association (NFPA), 1 Batterymarch Park, Quincy, MA, 02269-9101, [www.nfpa.org](http://www.nfpa.org)
- NFPA 409, *Standard on Aircraft Hangars*, National Fire Protection Association (NFPA), 1 Batterymarch Park, Quincy, MA, 02269-9101, [www.nfpa.org](http://www.nfpa.org)
- NFPA 430, *Storage of Liquid and Solid Oxidizers*, National Fire Protection Association (NFPA), 1 Batterymarch Park, Quincy, MA, 02269-9101, [www.nfpa.org](http://www.nfpa.org)
- NFPA 434, *Storage of Pesticides*, National Fire Protection Association (NFPA), 1 Batterymarch Park, Quincy, MA, 02269-9101, [www.nfpa.org](http://www.nfpa.org)
- NFPA 490, *Storage of Ammonium Nitrate*, National Fire Protection Association (NFPA), 1 Batterymarch Park, Quincy, MA, 02269-9101, [www.nfpa.org](http://www.nfpa.org)
- NFPA 501A, *Fire Safety Criteria for Manufactured Home Installations, Site and Communities*, National Fire Protection Association (NFPA), 1 Batterymarch Park, Quincy, MA, 02269-9101, [www.nfpa.org](http://www.nfpa.org)
- NFPA 750, *Standard on Water Mist fire Protection Systems*, National Fire Protection Association (NFPA), 1 Batterymarch Park, Quincy, MA, 02269-9101, [www.nfpa.org](http://www.nfpa.org)
- NFPA 1963, *Fire Hose Connections*, National Fire Protection Association (NFPA), 1 Batterymarch Park, Quincy, MA, 02269-9101, [www.nfpa.org](http://www.nfpa.org)
- NFPA 2001, *Clean Agent Fire Extinguishing Systems*, National Fire Protection Association (NFPA), 1 Batterymarch Park, Quincy, MA, 02269-9101, [www.nfpa.org](http://www.nfpa.org)
- NFPA 8503, *Pulverized Fuel Systems*, National Fire Protection Association (NFPA), 1 Batterymarch Park, Quincy, MA, 02269-9101, [www.nfpa.org](http://www.nfpa.org)
- NFPA Handbook*, National Fire Protection Association (NFPA), 1 Batterymarch Park, Quincy, MA, 02269-9101, [www.nfpa.org](http://www.nfpa.org)
- Planning and Design Guide for Secure Adult and Juvenile Facilities*, 1999, American Correctional Association (ACA), 4380 Forbes Blvd, Lanham, MD, 20706-4322, 1-800-222-5646

**UFC 3-600-01**  
**26 September 2006**

SS 521-AA-MAN-010, *U.S. Navy, diving and Manned Hyperbaric Systems Safety Certification Manual*,

TI 800-01, *Design Criteria, Appendix G*, Department of the Army, Standardization Documents Order Desk, 700 Robbins Avenue, Bldg 4D, Philadelphia, PA, 19111-5094

UFC 3-230-10A, *Water Supply: Water Distribution*, Unified Facilities Criteria Program, <http://dod.wbdg.org>

UFC 3-230-02, *Water Supply Systems*, Unified Facilities Criteria Program, <http://dod.wbdg.org>

UFC 3-460-01, *Petroleum Fuel Facilities*, Unified Facilities Criteria Program, <http://dod.wbdg.org>

UFC 4-010-01, *DOD Minimum Antiterrorism Standards for Buildings*, Unified Facilities Criteria Program, <http://dod.wbdg.org>

UFC 4-150-02, *Dockside Utilities*, Unified Facilities Criteria Program, <http://dod.wbdg.org>

UFC 4-151-10, *Waterfront Construction*, Unified Facilities Criteria Program, <http://dod.wbdg.org>

UFC 4-152-01, *Piers and Wharves*, Unified Facilities Criteria Program, <http://dod.wbdg.org>

UFC 4-159-01N, *Hyperbaric Facilities*, Unified Facilities Criteria Program, <http://dod.wbdg.org>

UFC 4-213-10, *Graving Drydocks*, Unified Facilities Criteria Program, <http://dod.wbdg.org>

UFC 4-213-12, *Drydocking Facilities Characteristics*, Unified Facilities Criteria Program, <http://dod.wbdg.org>

UFC 4-442-01N, *Covered Storage*, Unified Facilities Criteria Program, <http://dod.wbdg.org>

UFC 4-451-10N, *Hazardous Waste Storage*, Unified Facilities Criteria Program, <http://dod.wbdg.org>

UFC 4-510-01, *Medical Military Facilities*, Unified Facilities Criteria Program, <http://dod.wbdg.org>

UFC 4-740-14, *Child Development Centers*, Unified Facilities Criteria Program, <http://dod.wbdg.org>

**UFC 3-600-01**  
**26 September 2006**

UL 790, *Safety Tests for Fire Resistance of Roof Covering Materials*,  
Underwriters Laboratory (UL), 333 Pfingsten Rd., Northbrook, IL, 30062-2096

UL 1479, *Fire Tests of Through-Penetration Firestops*, Underwriters Laboratory  
(UL), 333 Pfingsten Rd., Northbrook, IL, 30062-2096

USC Title 10, Section 1794, *Military Child Care*, Office of the Law Revision  
Counsel, <http://uscode.house.gov/>

USC Title 15, Section 272, *Utilization of Consensus Technical Standards by  
Federal Agencies*, Office of the Law Revision Counsel,  
<http://uscode.house.gov/>

USC Title 15, Section 2225, *Hotel-Motel Fire Safety*, Office of the Law Revision  
Counsel, <http://uscode.house.gov/>

USC Title 15, Section 2227, *Fire Administration Authorization Act*, (also referred  
to as the "Fire Safety Act,") Office of the Law Revision Counsel,  
<http://uscode.house.gov/>

**APPENDIX B OCCUPANCY HAZARD CLASSIFICATION FOR DETERMINING  
AUTOMATIC SPRINKLER DENSITIES AND HOSE STREAM DEMANDS****B-1 CLASSIFICATION OF OCCUPANCIES.**

The principal occupancy classifications are light hazard, ordinary hazard, and extra hazard. Listed below are the classifications with examples of common occupancies listed under each. The basic hazard classification of an occupancy does not define the fire hazard present in all areas of that occupancy. If more hazardous processes or areas exist within a given occupancy, protect these areas in accordance with the fire protection requirements pertaining to the hazard classification of that area. Determine the classification for unlisted occupancies from the definitions or by comparison with one of the listed occupancies.

**B-1.1 Light Hazard Occupancies.**

Occupancies or portions of occupancies where the quantity and combustibility of the contents are low and fires with relatively low rates of heat release are expected. Small, scattered amounts of flammable liquids in closed containers are allowable in quantities not exceeding 20 L (5 gal) per fire area. This classification includes but is not limited to the following occupancies:

- Churches and chapels
- Gymnasiums
- Clinics (dental, outpatient, patient areas only)
- Hospitals
- Data processing areas
- Mess areas
- Dispensaries (patient areas only)
- Drill halls (not used for storage or exhibition)
- Disciplinary barracks
- Offices
- Child development centers

**B-1.2 Ordinary Hazard Group 1 Occupancies.**

Occupancies or portions of occupancies where combustibility is low, quantity of combustibles is moderate, stockpiles of combustibles do not exceed 2.5 m (8 ft), and fires with moderate rates of heat release are expected. Modest, scattered

amounts of flammable liquid, in closed containers are allowable in quantities not to exceed 75 L (20 gal) per fire area. This classification includes but is not limited to the following occupancies:

- Armories
- Sheet metal shops
- Bowling alleys
- Ship fitting shops
- Clubs (officer, enlisted personnel, etc.)
- Kitchens and bakery
- Small stores
- Theaters and auditoriums
- Welding shops
- Forge shops
- Laundries
- Automobile parking garage
- Electronics assembly and repair

**B-1.3 Ordinary Hazard Group 2 Occupancies.**

Occupancies or portion of occupancies where quantity and combustibility of contents is moderate, stockpiles do not exceed 3.7 m (12 ft), and fires with moderate rate of heat release are expected. Moderate, scattered amounts of flammable liquids in closed containers are allowable in quantities not to exceed 200 L (50 gal) per fire area. Small amounts of flammable liquids may be exposed as required by normal operations. This classification includes but is not limited to the following occupancies:

- Commissaries
- Exchanges
- Aviation Depots
- Boiler rooms
- Electrical maintenance shops



- Engine and generator rooms
- Laboratories
- Refrigeration and air compressor rooms
- Switchgear rooms
- Machine rooms
- Printing shops (using inks having flash points above 44 °C (110 °F))
- Libraries
- Piers and wharves
- Vehicle repair garages
- Woodworking shops

**B-1.4 Special Occupancies.**

Special occupancies are facilities or areas that cannot be assigned a specific classification because of special protection requirements. This classification includes but is not limited to the following occupancies:

- Flammable and combustible liquids
- Aircraft hangars
- Engine test cells
- Missile assembly
- Ordnance plants
- Rubber tire storage
- Warehouses (piled or rack storage)
- Foam rubber or plastic storage

**Note:** Refer to Chapter 6 and the appropriate NFPA codes and standards.

## **APPENDIX C PROCEDURE FOR DETERMINING FIRE FLOW DEMAND FOR UNSPRINKLERED FACILITIES**

### **C-1 PROCEDURES.**

Use the following procedures to determine the required fire flow demand and duration for buildings that are not fully sprinklered.

#### **C-1.1 Step One - Determine the Classification of Occupancy.**

Appendix B lists the classifications of occupancy hazard as Light, Ordinary Group 1, Ordinary Group 2, and Extra.

#### **C-1.2 Step Two - Determine the Water Demand Weighted Factors.**

The table is divided into three weighted value categories for fire flow and duration in each occupancy classification. These categories are determined from the values established in the six factors discussed below. The final value is determined by adding the values obtained from all six factors. See sample calculations in Appendix C, par. 1-d.

##### **C-1.2.1 Weighted Factors.**

The six factors to be assigned weighted values are as follows:

##### **C-1.2.1.1 Response Time by Fire Department.**

Most installations have on-site fire departments that are familiar with hazards of buildings within the facility. The longer the response time for manual firefighting, the greater the water demand and duration. Traffic flow is a factor and traffic congestion is equivalent to a longer response distance. The fire department response weighing factors are as follows:

<u>Type Of Fire Department Response</u>	<u>Value</u>
On-Site (within 1.6 km (1 mile))	1
On-Site (over 1.6 km (1 mile) but less than 4.8 km (3 miles))	2
On-Site (4.8 km (3 miles) or greater)	3
Off-Site (less than 3.2 km (2 miles))	2
Off-Site (3.2 km (2 miles) or greater)	3

##### **C-1.2.1.2 Type of Construction.**

Paragraph 2-1.3 requires that type of construction comply with the IBC. As structural fire integrity is reduced, water demand and duration will become

greater. In addition, the combustibility of construction will add to the water demand for an unsprinklered building. The types of construction weighted values are as follows:

<u>Type of Construction</u>	<u>Value</u>
Type I	1
Type II	2
Type III	3
Type IV	2
Type V	5

**C-1.2.1.3 Number of Stories.**

Firefighting is more difficult for multi-story buildings. Furthermore, fire spreads faster vertically than horizontally. Fire in multi-story buildings is more difficult to contain and has higher water demands. Consider one-story buildings with high ceiling heights (6.1 m (20 ft) or greater) multi-story. The weighted values for number of stories of a facility are as follows:

<u>Number of Stories</u>	<u>Value</u>
Single Story	1
Two or more stories	2

(plus 1 point for each additional floor greater than two floors; maximum 6 points)

**C-1.2.1.4 Separation Distances.**

The model building codes and NFPA 80A provide that a separation distance of 18.3 m (60 ft) or more does not require protection of exterior wall from exposure. The codes indicate that a separation distance of 6.1 m (20 ft) or less requires one hour or more fire resistance construction. Water demand for protecting exposed facilities increases as separation distance decrease. In addition, exterior firefighting is hampered as building separation distances are reduced. The weighted values for the building separation distances are as follows:

<u>Separation Distance</u>	<u>Value</u>
<u>meter (feet)</u>	
18.3 (60) or more	1

6.4 (21) to 18 (59)                      2

6.1 (20) or less                              4

**C-1.2.1.5 Building Floor Area.**

Firefighting water demands are higher for larger unsprinklered buildings. The weighted values for the building floor area factor are as follows:

<u>Area (square meter) (square feet)</u>	<u>Value</u>
697 (7500) or less	1
697.1 (7501) to 1394 (15,000)	2
1394.1 (15,001) to 2323 (25,000)	3
2323.1 (25,001) to 3716 (40,000)	4
Greater than 3716 (40,000)	5

**C-1.2.1.6 Firefighting Access.**

Studies conducted by fire departments have demonstrated that a responding engine company needs to be within 55 m (180 ft) of a fire to effectively control it. This distance is based on the use of a 9.2 m (30-ft) stream of water and 45 m (150 ft) of fire hose. The fire hose distance must be measured, as the hose would lie over the terrain from the fire apparatus. Ideally, this distance should be to any part of the first three stories of a building, either by use of ground ladders through windows or by use of windows. The efficiency of the manual approach is reduced as more hose connections are required. The weighted values for firefighting access based on hose layout distances are as follows:

<u>Maximum Hose Layout (meter) (feet)</u>	<u>Value</u>
(first three stories)	
55 (180) or less	1
55.1 (181) to 70 (230)	2
Greater than 70 (230)	4

**C-1.3 Step Three - Determine Fire Flow and Duration.**

Using the occupancy classification and summation of weighted values of the six factors; select the required water demand for fire flow and duration from Table C-1.

**Table C-1 Water Demands for Unsprinklered Facilities**

<b>TOTAL WEIGHTED VALUE</b>						
Occupancy Hazard Classification	Fire Flows (L/m (gpm) at 137 kPa (20 psi) residual pressure)			Duration (minutes)		
	6-10	11-15	16+	6-10	11-15	16+
Light	2840 (750)	4260 (1125)	5680 (1500)	60	90	120
Ordinary Group 1	3785 (1000)	5680 (1500)	7570 (2000)	90	120	150
Ordinary Group 2	5680 (1500)	8520 (2250)	11,360 (3000)	90	120	150
Extra	9465 (2500)	14,195 (3750)	18,930 (5000)	150	195	240

#### C-1.4 Examples Calculations

##### (1) Example 1 - Administration Office Building (Light Hazard)

<u>Factors</u>	<u>Values</u>
1. Fire Department response	
On-site (within 1.6 km (1 mile))	1
2. Type of construction	
Type II	2
3. Number of Stories	
Two stories	2
4. Separation Distance	
9.1 m (30 ft)	2
5. Building Floor Area	

2044 m <sup>2</sup> (22,000 ft <sup>2</sup> )	3
6. Firefighting access	
51.8 m (170 ft)	2
<b>Total Weighing Value</b>	<b>12</b>

**Per Table C-1: 4260 L/m (1125 gpm ) for 90 minutes**

**(2) Example 2 - Welding Shop (Ordinary Group 1)**

<u>Factors</u>	<u>Values</u>
1. Fire Department response	
Off-site (within 3.2 km (2 miles))	2
2. Type of construction	
Type II	3
3. Number of Stories	
Single story	1
4. Separation Distance	
6.1 m (20 ft)	4
5. Building Floor Area	
2044 m <sup>2</sup> (22,000 ft <sup>2</sup> )	3
6. Firefighting access	
76.2 m (250 ft)	4
<b>Total Weighing Value</b>	<b>17</b>

**Per Table C-1: 7570 L/m (2000 gpm) for 150 minutes**

**(1) Example 3 - Barracks (Light Hazard)**

<u>Factors</u>	<u>Values</u>
1. Fire Department response	
Off-site (more than 4.8 km (3 miles))	3

**UFC 3-600-01**  
**26 September 2006**

2. Type of construction	
Type II	2
3. Number of Stories	
Three stories	3
4. Separation Distance	
12.2 m (40 ft)	2
5. Building Floor Area	
836 m <sup>2</sup> (9,000 ft <sup>2</sup> )	2
6. Firefighting access	
61 m (200 ft)	2
<b>Total Weighing Value</b>	<b>14</b>

**Per Table C-1: 4260 L/m (1125 gpm) for 90 minutes**

**APPENDIX D PROCEDURE FOR PERFORMANCE BASED FIRE SAFETY DESIGN****D-1 EQUIVALENT LEVEL OF SAFETY AND PROTECTION.**

Any proposed performance-based fire safety design must demonstrate to the satisfaction of the authority having jurisdiction, a level of safety equivalent to the minimum applicable prescriptive requirements of this UFC.

**D-2 DEFINITIONS.****D-2.1 Stakeholders.**

The stakeholders are a group of identified individuals or representatives, typically having authoritative control or input, having a share or interest in the successful completion of a project. A project's identified stakeholders should include the building's design and construction team members, security, the authority having jurisdiction, accreditation agencies, tenants, and emergency responders. The representative of the component AHJ's office must be the stakeholder responsible for ultimate approval of any performance-based fire safety design.

**D-3 FIRE SAFETY DESIGN DOCUMENTATION.**

Any facility designed using performance-based fire safety design methods must have supporting documentation, including a Fire Protection Engineering Design Brief, Performance-Based Design Report, Specifications, Drawings, Building Operation & Maintenance Manuals, and Warrant of Fitness.

**D-3.1 Fire Protection Engineering Design Brief.**

This is a separate document from the project Basis of Design, prepared by the design team's responsible fire protection engineer and containing general qualitative project information that has been agreed upon by the stakeholders. As a minimum, the design brief includes the project scope, facility and occupant characteristics, project goals and objectives, performance criteria, design fire scenarios, technical references and resources, two trial designs, documentation of project design engineers and their qualifications, and a record of agreement on the aforementioned components.

**D-3.1.1 General Project Information.**

This section describes the boundaries of the performance-based design as agreed upon by all stakeholders, and includes realistic and sustainable design information regarding building use, design purpose and approach, project constraints, and applicable regulations. The project budget should be clearly defined, so that the limitations and available budget for the proposed solutions can be known.



**D-3.1.2 Facility and Occupant Characteristics.**

The facility characteristics include an accurate and complete description of the building construction, operations, systems, physical contents and occupants. The occupant characteristic description includes the number, age, facility familiarity, gender, occupant loading, and potential for self-preservation of a facility's occupants. Accurately identify any necessary occupant response and interaction needed to provide hazard mitigation or securing of specific process or operational equipment. The occupant load is the maximum number of people realistically expected to occupy an area, as agreed upon by the stakeholders, but not less than the prescriptive occupant load densities of NFPA 101.

**D-3.1.3 Goals.**

Detail and document the goals of life safety, property protection, continuity of operations, and the limitation of the environmental impact of the fire, as defined by NFPA 101, and as additionally defined by the stakeholders. Adequately address the allied fire safety goals of historic preservation and environmental protection from fire protection measures. Identify each goal - realistically, quantifiably, and remaining constant throughout the design process. Address each goal by each proposed trial design, regardless of the goal's individual importance.

**D-3.1.4 Objectives and Acceptable Levels of Risk.**

Clearly identify stakeholder and design objectives associated with each of the required and user-defined goals.

D-3.1.4.1 Stakeholder objectives are the specific project objectives based upon agreed fire safety goals and should be stated in terms of objectives, functional statements, or performance objectives. Stakeholders' objectives may be defined in terms of acceptable or sustainable loss or in terms of an acceptable level of risk. Where a design requires the determination of an acceptable level of risk, the authority having jurisdiction must ensure that the appropriate stakeholders make the determination. The level of risk may affect an entire base/community/command; therefore it is essential to ensure the person determining the level of risk is authorized to do so.

D-3.1.4.2 Design objectives are developed by the design engineer based on the stakeholder objectives, and is stated in engineering terms. Use design objectives as the basis for the development of performance criteria, against which the predicted performance of a trial design will be evaluated.

**D-3.1.5 Performance Criteria.**

Develop quantitative performance criteria to represent the intent of each design objective and retained prescriptive requirement. Completely describe and document these criteria. The performance criteria reflect the event

consequences that need to be avoided to fulfill the design objectives, and include realistic values that are capable of being evaluated or measured using existing engineering tools and methods.

D-3.1.5.1 The performance criteria must be a combination of the life safety and property protection criterion, along with criteria developed from stakeholder objectives.

**Note:** NFPA 101, *Life Safety Code* and the SFPE *Engineering Guide to Performance-Based Fire Protection Analysis and Design of Buildings* provide guidance regarding the development and evaluation of appropriate performance criteria.

#### D-3.1.6 **Design Fire Scenarios.**

Document complete descriptions of the reasoning, intent, and details of all required and stakeholder defined fire scenarios. Use realistic and accurate fire scenarios, with respect to all fire elements, including initial fire location, early rate of growth in fire severity, and smoke generation. Indicate in the description of the fire scenarios all applicable data, characteristics and assumptions, which must remain consistent between all fire scenarios. Ensure the omission of certain details will not reduce the reality of the proposed design fire scenario. The design engineer must justify any design fire scenario data that is omitted or cannot be considered by available evaluation methods, and this justification must be noted and approved by the authority having jurisdiction.

#### D-3.1.7 **Technical References and Resources [Methods of Evaluation].**

Thoroughly document all technical references, including methodologies, data and sources. Identify the scientific basis of each engineering calculation method or model. Develop, review and validate these methods using a consensus, peer-review process, or obtain from resource publications. Where the chosen methods do not permit the incorporation of all data or do not accurately address the incorporation of the data, perform a sensitivity analysis for any design, performance criteria, or fire scenario data that cannot be included or used in the chosen methods. Address all degrees of conservatism and factors of safety, and clearly identify the limitations of the calculation methods. Any method whose outcome is significantly altered by the omission of trial design or fire scenario details will not be approved, and the omission of critical data is prohibited. The use of proprietary and non-peer reviewed data or source is not permitted. The authority having jurisdiction must approve the assessment methods, data, and sources, and confirm the validity of all technical references and resources prior to the design evaluation. Provide the technical reviewer, upon request, any technical references or resources.

D-3.1.7.1 The performance criteria must be capable of being proved or measured using existing engineering tools and methods.

**D-3.1.8 Trial Designs.**

Identify and document the general details, including the proposed construction, systems, and protection methods. Include in the documentation the safety factors associated with each trial design, as agreed upon by the stakeholders. Clearly identify the impact of the safety factors so that a reasonable decision can be made as to whether their level is appropriate and sufficient. State any retained prescriptive requirements. Where the interaction of emergency response personnel is a designed protection method, accurately identify and confirm the impact and responsibility of the emergency personnel.

D-3.1.8.1 The performance criteria must be equally considered and addressed by each trial design against each fire scenario

D-3.1.8.2 Evaluate each trial design in each fire scenario using the agreed upon performance criteria.

**D-3.1.9 Project Team and Qualifications.**

Provide the qualifications and contact information for the entire design team, including the responsible fire protection engineer as part of the required documentation. A performance-based, fire-safety design must be prepared by a registered fire protection engineer with experience in performance-based fire safety design and specific experience with the engineering tools and methodologies that are anticipated for a particular project.

**D-3.2 Performance-Based Fire Safety Design Report.**

This documentation must be prepared by the responsible fire protection engineer, and used for general guidance. Indicate the building was designed using a performance-based fire safety design approach, and should convey the expected hazards, risks, and system performance over the entire building life-cycle. Include the project scope, design goals and objectives, performance criteria, design fire scenarios, critical design assumptions, critical design features, final design, cost benefit analysis, design engineer's qualifications and capabilities, and data and evaluation method references.

**D-3.2.1 Cost Benefit.**

The performance-based fire safety design report must indicate how the performance-based design maximizes the benefits/cost ratio while maintaining a level of safety equivalent to the established prescriptive requirements. A performance-based design must not be undertaken where the prescriptive requirements provide the same level of safety for a lesser cost. When there exists multiple acceptable proposed design scenarios, the cost benefit analysis should aid in the identification and determination of the best solution.

**D-3.3 Building O&M Documentation.**

The responsible fire protection engineer must produce Building Operation and Maintenance documentation for the facility based on the objectives, performance criteria, limitations, and final design. Include all associated specifications and design drawings, and a description of the required maintenance procedures that need to be performed to ensure continued compliance with performance-based fire safety design.

#### **D-3.4 Warrant of Fitness.**

The host-tenant agreement must require that an annual warrant of fitness be prepared for any subsystem, system, or facility that has been designed using performance-based fire safety design methods. Submit this warrant to the authority having jurisdiction for review and assurance that the current facility characteristics comply with the requirements of the approved performance design. This warrant should reflect any existing or proposed changes in building occupancy, operation, features, systems, or emergency personnel response. Where emergency response is a critical element in the accepted fire safety design, reevaluate the design when changes are made to the operational procedures, location, or structure of the emergency response personnel.

#### **D-4 REVIEW OF TRIAL DESIGNS.**

Provide every performance-based fire safety design with a technical review, and develop a Review Brief. Analyze each trial design to determine the compliance with the required performance criteria. The reviewer must be an individual capable of providing a thorough evaluation of the proposed design, and must have the same minimum qualifications as the design fire protection engineer. If the authority responsible for the review of the performance-based fire safety design does not have the required qualifications, they must direct the designer to submit the design to a qualified third party for review.

##### **D-4.1 Third Party Review.**

When required, an assigned third party must provide an objective review of the project, and must not provide the actual fire safety design. When a third party is reviewing the design, the authority having jurisdiction remains a stakeholder and ultimately is responsible for the approval of the final design. When a review is assigned to a third party, provide the authority having jurisdiction with a Review Brief.

##### **D-4.2 Compliant Fire Safety Design.**

A compliant fire safety design must meet the stated performance criteria when subjected to each design fire scenario. A subsystem, system or facility design that complies with all requirements of the applicable prescriptive criteria is deemed as satisfying the minimum fire safety goals and objectives, and does not need to be evaluated against the design fire scenarios. Completely evaluate a performance-based fire safety design that incorporates only portions of

applicable prescriptive criteria, as it is not considered to provide the minimum levels of protection.

D-4.2.1 Where a design does not meet the performance criteria, it may be revised and reevaluated. The revision must not reduce any agreed upon goals, objectives, performance criteria, or level of performance to ensure a proposed design complies with the stated requirements. Criteria may be changed based on additional analysis and the consideration of additional data.

D-4.3 **Review Brief.**

The Review Brief details how each proposed design compares with the required fire safety goals, objectives and performance criteria. The Brief provides a brief description of the details of each trial design, the technical resources and references, any concerns about steps in the design process and general concerns about the designer's performance-based fire safety design approach. The Brief indicates the acceptability of each design, the reasoning for each acceptance or rejection, and which design is recommended for final acceptance. It should also discuss levels of confidence over validation. The Brief should indicate how personnel and property protection are considered, which objectives the design stresses, a statement of what has been checked, the design solution, and the entire design approach and process.

**APPENDIX E INTERNATIONAL BUILDING CODE, UNIFORM BUILDING CODE, AND NFPA 220 EQUIVALENTS**

This table provides the corresponding types of construction from the various codes. This table is for information only.

IBC	UBC	NFPA 220
	Type I - FR	Type I (443)
Type I-A	Type II - FR	Type I (332)
Type I-B		Type II (222)
Type II-A	Type II - 1 Hour	Type II (111)
Type II-B	Type II - N	Type II (000)
Type III-A	Type III - 1 Hour	Type III (211)
Type III-B	Type III - N	Type III (200)
Type IV (HT)	Type IV (HT)	Type IV (2HH)
Type V-A	Type V-1 hour	Type V (111)
Type V-B	Type V-N	Type V (000)

**ACRONYMS**

<b>ADA</b>	Americans With Disabilities Act
<b>ADAAG</b>	Americans With Disabilities Act Accessibility Guidelines
<b>ADP</b>	Automatic Data Processing
<b>AFFF</b>	Aqueous Film-Forming Foam
<b>AHJ</b>	Authority Having Jurisdiction
<b>ASTM</b>	American Society for Testing and Materials
<b>A&amp;E</b>	Architectural and Engineering Services
<b>AWWA</b>	American Water Works Association
<b>CDC</b>	Child Development Center
<b>DLA</b>	Defense Logistics Agency
<b>DOD</b>	Department of Defense
<b>DODI</b>	Department of Defense Instruction
<b>EM</b>	Engineering Manual
<b>EMCS</b>	Energy Monitoring and Control System
<b>ESFR</b>	Early Suppression Fast-Response Sprinklers
<b>ETL</b>	Engineering Technical Letters
<b>FAAA</b>	Fire Administration Authorization Act
<b>FM</b>	Factory Mutual Global
<b>FPE</b>	Fire Protection Engineer

<b>FRT</b>	Fire Retardant Treated Plywood
<b>FS</b>	Flame Spread Rating
<b>IBC</b>	International Building Code
<b>ITG</b>	Interim Technical Guidance
<b>LED</b>	Light Emitting Diode
<b>LOX</b>	Liquid Oxygen
<b>MIL-HDBK</b>	Military Handbook
<b>NFPA</b>	National Fire Protection Association
<b>NIMA</b>	National Imagery and Mapping Agency
<b>NRTL</b>	Nationally Recognized Testing Laboratory
<b>P.E.</b>	Registered Professional Engineer
<b>POL</b>	Petroleum Oil Lubricant
<b>PRVs</b>	Pressure-Regulating Valves
<b>SD</b>	Smoke Developed Rating
<b>SFPE</b>	Society of Fire Protection Engineers
<b>UFAS</b>	Uniform Federal Accessibility Standard
<b>UFC</b>	Unified Facilities Criteria
<b>UL</b>	Underwriters Laboratories Inc.



**UFC 3-600-01**  
**26 September 2006**

**USC**      United States Code