

UFC 3-260-05A
16 January 2004

UNIFIED FACILITIES CRITERIA (UFC)

MARKING OF ARMY AIRFIELD HELIPORT OPERATIONAL AND MAINTENANCE FACILITIES



APPROVED FOR PUBLIC RELEASE; DISTRIBUTION UNLIMITED

UFC 3-260-05A
16 January 2004

UNIFIED FACILITIES CRITERIA (UFC)

MARKING OF ARMY AIRFIELD HELIPORT OPERATIONAL AND MAINTENANCE FACILITIES

Any copyrighted material included in this UFC is identified at its point of use. Use of the copyrighted material apart from this UFC must have the permission of the copyright holder.

U.S. ARMY CORPS OF ENGINEERS (Preparing Activity)

NAVAL FACILITIES ENGINEERING COMMAND

AIR FORCE CIVIL ENGINEER SUPPORT AGENCY

Record of Changes (changes are indicated by \1\ ... /1/)

Change No.	Date	Location

This UFC supersedes TM 5-823-4, dated 7 July 1987. The format of this UFC does not conform to UFC 1-300-01; however, the format will be adjusted to conform at the next revision. The body of this UFC is the previous TM 5-823-4, dated 7 July 1987.

FOREWORD

vii

The Unified Facilities Criteria (UFC) system is prescribed by MIL-STD 3007 and provides planning, design, construction, sustainment, restoration, and modernization criteria, and applies to the Military Departments, the Defense Agencies, and the DoD Field Activities in accordance with [USD\(AT&L\) Memorandum](#) dated 29 May 2002. UFC will be used for all DoD projects and work for other customers where appropriate. All construction outside of the United States is also governed by Status of forces Agreements (SOFA), Host Nation Funded Construction Agreements (HNFA), and in some instances, Bilateral Infrastructure Agreements (BIA.) Therefore, the acquisition team must ensure compliance with the more stringent of the UFC, the SOFA, the HNFA, and the BIA, as applicable.

UFC are living documents and will be periodically reviewed, updated, and made available to users as part of the Services' responsibility for providing technical criteria for military construction. Headquarters, U.S. Army Corps of Engineers (HQUSACE), Naval Facilities Engineering Command (NAVFAC), and Air Force Civil Engineer Support Agency (AFCESA) are responsible for administration of the UFC system. Defense agencies should contact the preparing service for document interpretation and improvements. Technical content of UFC is the responsibility of the cognizant DoD working group. Recommended changes with supporting rationale should be sent to the respective service proponent office by the following electronic form: [Criteria Change Request \(CCR\)](#). The form is also accessible from the Internet sites listed below.

UFC are effective upon issuance and are distributed only in electronic media from the following source:

- Whole Building Design Guide web site <http://dod.wbdg.org/>.

Hard copies of UFC printed from electronic media should be checked against the current electronic version prior to use to ensure that they are current.

AUTHORIZED BY:



DONALD L. BASHAM, P.E.
 Chief, Engineering and Construction
 U.S. Army Corps of Engineers



DR. JAMES W. WRIGHT, P.E.
 Chief Engineer
 Naval Facilities Engineering Command

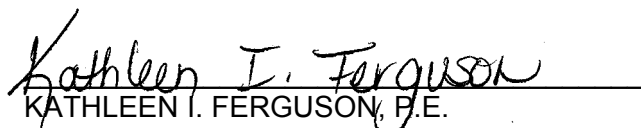

KATHLEEN I. FERGUSON, P.E.
 The Deputy Civil Engineer
 DCS/Installations & Logistics
 Department of the Air Force

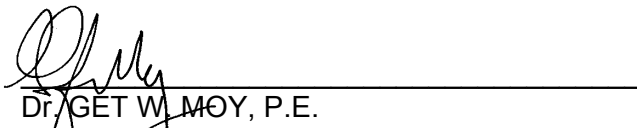

Dr. GET W. MOY, P.E.
 Director, Installations Requirements and
 Management
 Office of the Deputy Under Secretary of Defense
 (Installations and Environment)

TECHNICAL MANUAL

**MARKING OF
ARMY AIRFIELD-HELIPORT
OPERATIONAL AND MAINTENANCE
FACILITIES**

This copy is a reprint which includes current pages from Change 1.

HEADQUARTERS, DEPARTMENT OF THE ARMY

JULY 1987

CHANGE }
NO. 1 }HEADQUARTERS
DEPARTMENT OF THE ARMY
WASHINGTON, DC, 25 April 1988**MARKING OF ARMY AIRFIELD-HELIPORT
OPERATIONAL AND MAINTENANCE FACILITIES**

This change updates referenced publications and adds a new chapter for marking and painting of ground receiver checkpoints.

TM 5-823-4, 7 July 1987, is changed as follows:

1. New or revised material is indicated by a vertical bar in the margin. Where an entire chapter, section, or illustration is added or revised, the vertical bar is placed opposite the identification number and title.
2. Remove old pages and insert new pages as follows:

Remove pages	Insert pages
i and ii	i and ii
2-1 and 2-2	2-1 and 2-2
7-1 and 7-2	7-1 and 7-2
.....	8-1
A-1.....	A-1

3. File this transmittal sheet in front of the publication.

The proponent agency of this publication is the Office of the Chief of Engineers, United States Army. Users are invited to send comments and suggested improvements on DA Form 2028 (Recommended Changes to Publications and Blank Forms) direct to HQDA (DAEN-ECE-G), WASH DC 20314-1000.

By Order of the Secretary of the Army:

Carl E. Vuono
General, United States Army
Chief of Staff

Official:

R.L. DILWORTH
Brigadier General, United States Army
The Adjutant General

DISTRIBUTION:

To be distributed in accordance with DA Form 12-34B, requirements for Army Airfield Pavements.

TECHNICAL MANUAL

No. 5-823-4

HEADQUARTERS
DEPARTMENT OF THE ARMY
WASHINGTON, D. C., 7 July 1987**MARKING OF ARMY AIRFIELD-HELIPORT
OPERATIONAL AND MAINTENANCE FACILITIES**

		Paragraph	Page
CHAPTER	1. GENERAL		
	Purpose	1-1	1-1
	Scope	1-2	1-1
	Exceptions.....	1-3	1-1
	Definitions	1-4	1-1
CHAPTER	2. MARKING OF SERVICEABLE RUNWAYS AND TAXIWAYS AT AIRFIELDS		
	General	2-1	2-1
	Marking with paint	2-2	2-1
	Application.....	2-3	2-1
	Marking practices	2-4	2-5
	Runway markings.....	2-5	2-5
	Taxiway markings	2-6	2-8
	Stabilized areas.....	2-7	2-14
	Runway shoulder marking.....	2-8	2-14
	Aircraft parking ramps, tie down and mooring areas	2-9	2-14
CHAPTER	3. MARKING OF SERVICEABLE RUNWAYS AND TAXIWAYS AT HELIPORTS		
	General	3-1	3-1
	Marking with paint	3-2	3-1
	Runway marking	3-3	3-1
	Taxiway marking requirements	3-4	3-1
	Heliport identification marker requirements	3-5	3-1
CHAPTER	4. MARKING OF OVERRUN AND SHOULDER AREAS AT HELIPORTS		
	General	4-1	4-1
	Overrun areas	4-2	4-1
	Runway-shoulder areas	4-4	4-1
	Taxiway, taxilane, apron, hardstand, and engine run-up shoulder areas ...	4-4	4-1
	Detail requirements	4-5	4-1
CHAPTER	5. MARKING AND LIGHTING OF CLOSED OR HAZARDOUS AREAS ON AIRFIELDS OR HELIPORTS		
	Permanently closed runways and taxiways.....	5-1	5-1
	Temporarily closed runways and taxiways.....	5-2	5-1
	Closed airfields and heliports	5-3	5-1
	Hazardous areas.....	5-4	5-1
	Stabilized areas.....	5-5	5-1
	Runway shoulder areas	5-6	5-1
CHAPTER	6. MARKING OF COMPASS SWINGING BASES		
	General	6-1	6-1
	Magnetic effects	6-2	6-1
	Pavement grade.....	6-3	6-1
	Alinement markings	6-4	6-1
	Clearances	6-5	6-1
	Marking with paint	6-6	6-1
	Application of paint.....	6-7	6-1
CHAPTER	7. MARKING OF OBSTRUCTIONS TO AIR NAVIGATION		
	General	7-1	7-1

*This manual supersedes TM 5-823-4, dated January 1977, including all changes.

		Paragraph	Page
	Detail requirements	7-2	7-1
	Lighting of airfields, heliports, and obstructions	7-3	7-1
	Purpose of marking	7-4	7-1
	Omission of standard marking	7-5	7-1
	Colors	7-6	7-1
	Painting	7-7	7-1
	Patterns	7-8	7-2
	Markers	7-9	7-6
	Special markings	7-10	7-6
CHAPTER	8. GROUND RECEIVER CHECKPOINTS		
	Location	8-1	8-1
	Painting	8-2	8-1
APPENDIX	A. REFERENCES		A-1

LIST OF FIGURES

Figure	2-1.	Runway markings.
(2)	2-2.	Precision instrument runway marking.
	2-3.	Visual and nonprecision marking.
	2-4.	Runway numbers and letters.
	2-5.	Marking for displaced thresholds, blast pads and stopways.
(2)	2-6.	Taxiway/runway intersection marking.
	2-7.	Runway shoulder markings.
	2-8.	Holding position markings.
	3-1.	Guidelines for marking runways and taxiways at heliports.
	3-2.	Helipad marking pattern.
	4-1.	Marking of heliport overrun and shoulder area.
	4-2.	Marking of shoulders for heliport parking and maintenance aprons and taxiways.
	5-1.	Closed runway and taxiway markings.
	6-1.	Army airfield-heliport compass swinging base.
	7-1.	Painting and lighting of chimneys, poles, towers and similar obstructions.
	7-2.	Painting and lighting of water towers, storage tanks and similar obstructions.
	7-3.	Painting and lighting of water towers and similar obstructions.
	7-4.	Painting of single pedestal water tower by teardrop pattern.
	8-1.	Ground receiver checkpoint markings.

CHAPTER 1 GENERAL

1-1. Purpose. Runway and taxiway markings are essential for the safe and efficient use of airfields and heliports, and their effectiveness is dependent upon proper markings and maintenance to maintain an acceptable level of conspicuity. This manual provides criteria for marking of Army airfields, heliports, and obstructions to air navigation at Army installations within the United States. For marking of Army airfields, heliports, and obstructions to air navigation located in foreign countries, this manual will serve as the basic reference consistent with host country criteria.

1-2. Scope. The criteria contained herein is applicable to all new construction and alteration to existing facilities. Existing facilities will not be re-marked for the sole purpose of compliance with the criteria contained herein, but will conform to the prescribed criteria when remarked for scheduled maintenance or repair. Those facilities requiring higher standards because of special functions, mission, structural requirement, or importance of strategic value, are not covered in this manual. Criteria for these and further exceptions are normally contained in the design directive.

1-3. Exceptions. Exceptions to criteria prescribed and defined herein will not be made without prior approval of HQDA (DAEN-ECEG) WASH DC 20314-1000.

1-4. Definitions. The following definitions apply to terms used in this manual.

a. Airfield. A facility designed and used for the express purpose of operation, maintenance

and basing of either or both, fixed and rotarywing aircraft.

b. Heliport. A facility designed and used for the express purpose of operation, maintenance and basing of rotary-wing aircraft only.

c. Helipad. A facility designed and used for the express purpose of operation of rotary-wing aircraft.

d. Visual runway. A runway having no straight-in instrument approach procedure and intended solely for the operation of aircraft using visual approach procedure.

e. Nonprecision instrument runway. A runway having an existing instrument approach procedure utilizing air navigation facilities with only horizontal guidance for which a straightin nonprecision approach procedure has been approved.

f. Precision instrument runway. A runway having an existing instrument approach procedure utilizing a precision instrument landing system.

g. Runway threshold. The designated beginning of the runway that is available and suitable for the landing of aircraft.

h. Displaced threshold. A threshold that is located at a point on the runway other than the beginning of the full strength pavement and the paved area between the beginning of the full strength pavement and the displaced threshold is used for takeoff or rollout of aircraft.

i. Relocated threshold. A threshold that is located at a point on the runway other than the beginning of the full strength pavement and the paved area between the former threshold and the relocated threshold is no longer used for landing or takeoff of aircraft.

CHAPTER 2

MARKING OF SERVICEABLE RUNWAYS AND TAXIWAYS AT AIRFIELDS

2-1. General. The criteria contained within this chapter conforms to Federal Aviation Administration (FAA) Advisory Circular (AC) No. 150-5340-1E with minor exceptions. Where the criteria stated herein is in conflict with the AC 150/5340-1E, this manual will prevail.

2-2. Marking with paint. Initial marking of runways and taxiways at airfields should be done as soon as possible, subsequent to the required curing period. Re-marking or revising existing marks should be accomplished as often as necessary. The effectiveness of markings is heavily dependent upon their proper maintenance to provide maximum contrast with backgrounds.

a. Color marking. All runways will be marked with white reflective paint. Taxiways will be marked with yellow nonreflective paint.

(1) *Runways.* Reflective paints used to mark or re-mark runways will conform to Federal Specifications (Fed. Spec.) TT-P45E or TT-P-1952.

(2) *Taxiways.* Nonreflective paints used to mark or re-mark taxiways will conform to Federal Specifications (Fed. Spec.) TT-P-85E or TT-B-1325.

b. Application of paint. Painted markings will be applied to paved areas only after the pavements have been allowed to cure thoroughly. New pavement surfaces will be allowed to cure for a minimum of 30 days before application of marking materials. Care will be taken to insure that the pavement surface is dry and clean prior to painting.

(1) *Rigid pavements.* When painted markings are to be applied to rigid pavements that have been cured with a membrane-type curing compound, the surface to be painted will be cleaned thoroughly and the curing compound removed by sandblasting prior to painting.

(2) *Flexible pavements.* Flexible pavements will be allowed to cure as long as possible before painting (see paragraph 2-2b. above also). To prevent undue softening of the bitumen by the paint, and pickup, displacement, or discoloration by tires of traffic, the maximum drying time as prescribed by the paint

manufacturer or contract specifications will be enforced.

2-3. Application. The marking elements used for the various runway classifications are illustrated in figure 2-1. Markings for precision instrument runways are shown in figure 2-2, and markings for nonprecision instrument and visual runways are shown in figure 2-3. A runway should be marked in accordance with its present usage (visual, nonprecision instrument, or precision instrument) unless upgrading to a higher classification is imminent. The marking elements for each runway classification, which should never be less but which may contain additional elements normally used on higher runway classification, are as follows:

a. Visual runway.

- (1) Centerline marking.
- (2) Designation marking.
- (3) Threshold marking (on runways used or intended to be used by international commercial air transport).

(4) Fixed distance marking (on runways 4,000 feet or longer used by jet aircraft).

(5) Holding position markings (for taxiway/runway intersections).

b. Nonprecision instrument runway.

- (1) Centerline marking.
- (2) Designation marking.
- (3) Threshold marking.
- (4) Fixed distance marking (on runways 4,000 feet or longer used by jet aircraft).

(5) Holding position markings (for taxiway/runway intersections and instrument landing system (ILS) critical areas).

c. Precision instrument runway.

- (1) Centerline marking.
- (2) Designation marking.
- (3) Threshold marking.
- (4) Fixed distance marking.
- (5) Touchdown zone marking.
- (6) Side stripes.
- (7) Holding position markings (for taxiway/runway intersections and ILS critical areas).

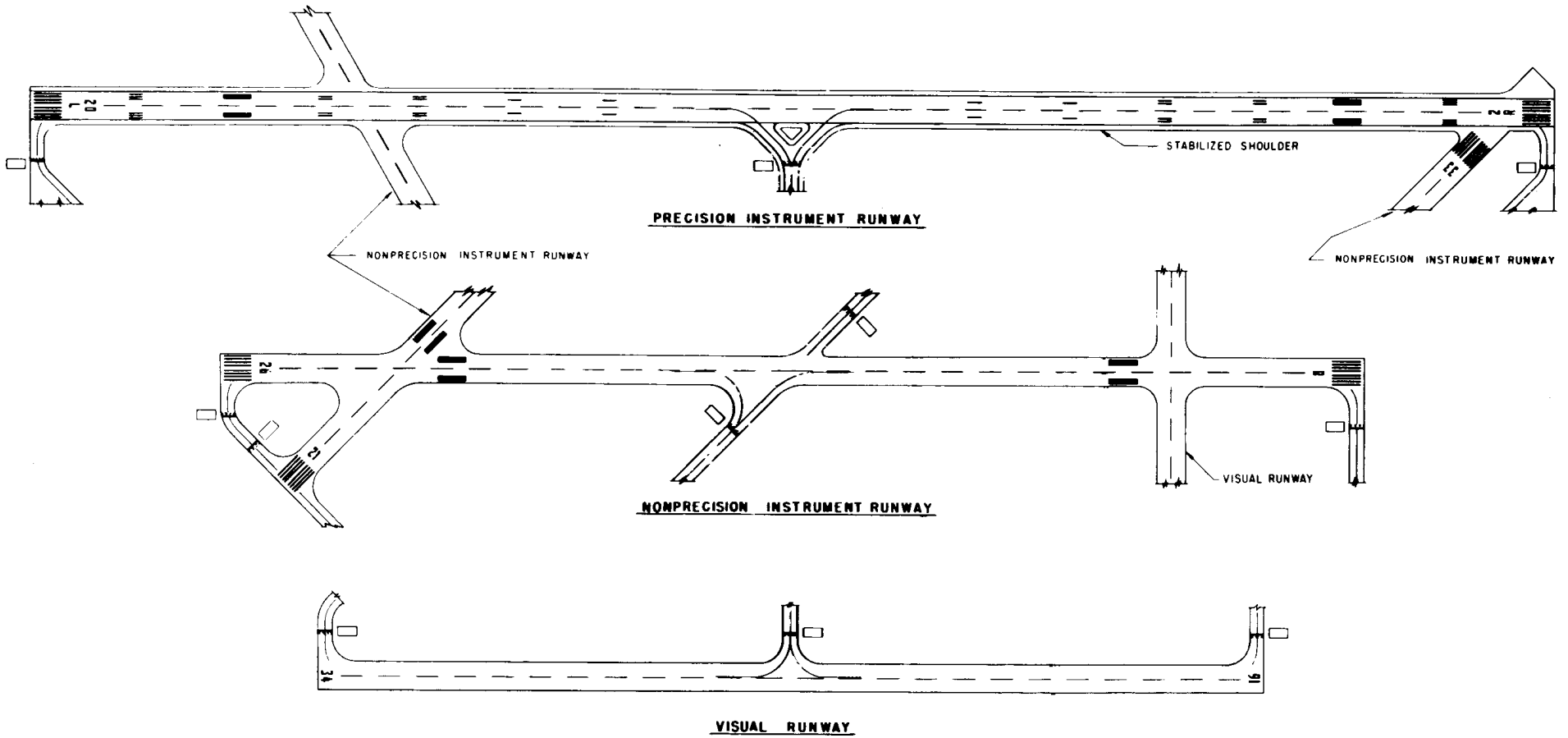

NOTE
□ RUNWAY IDENTIFICATION SIGN

Figure 2-1. Runway markings.

Change 1 2-2

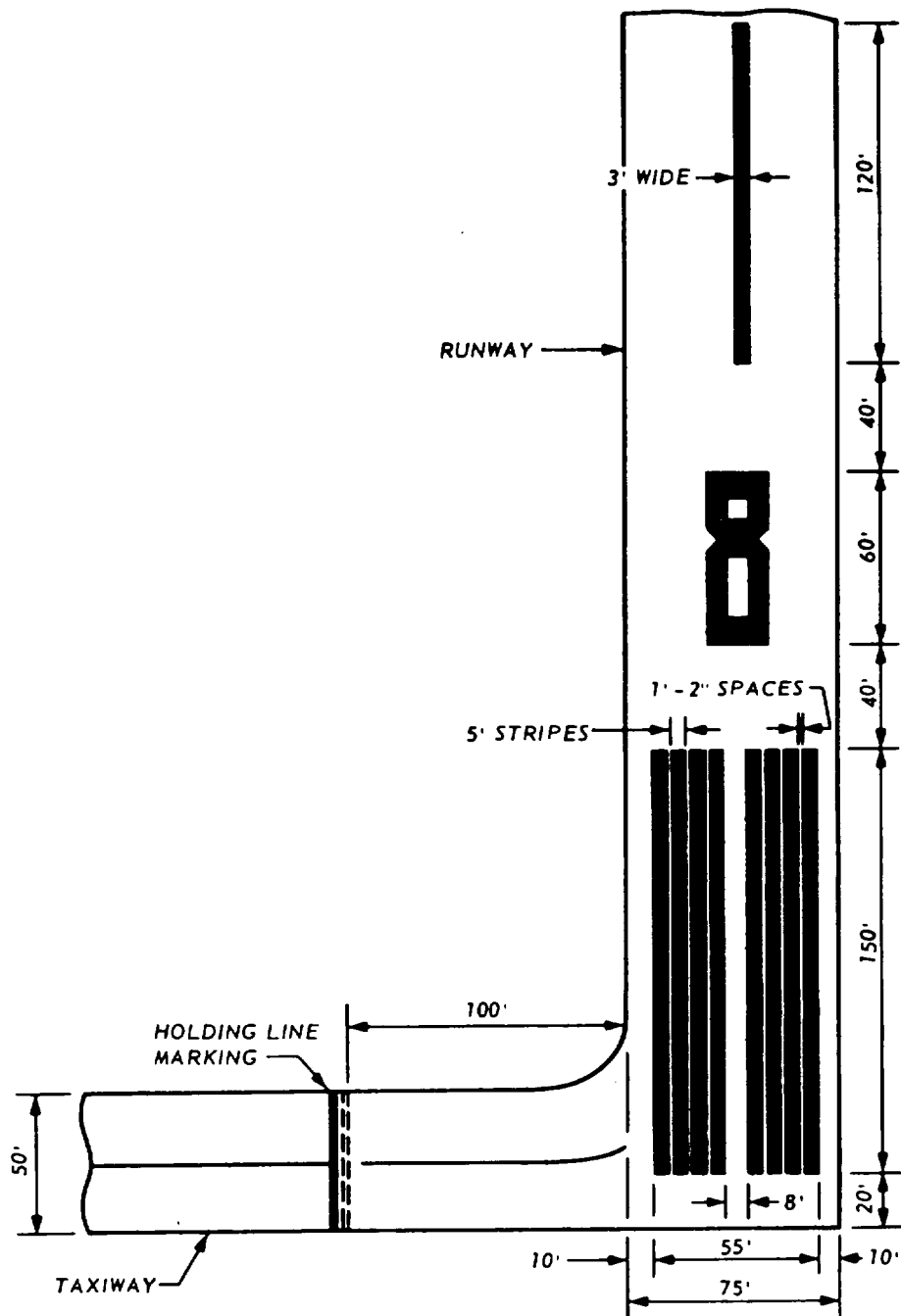

Figure 2-2. Precision instrument runway marking. (Sheet 2 of 2).

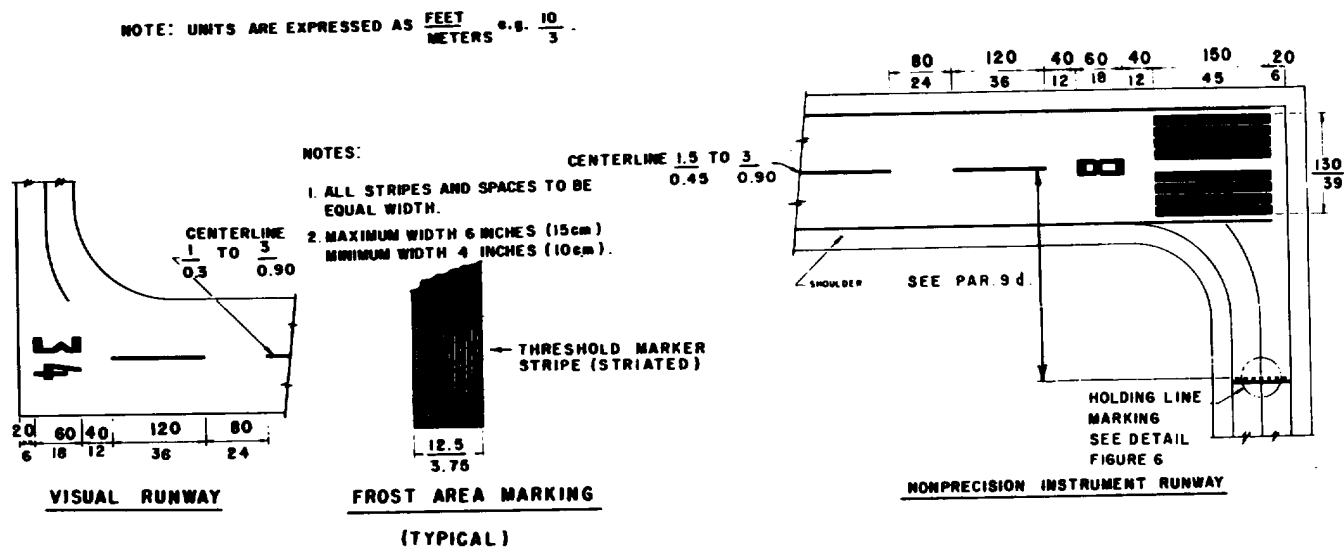

Figure 2-3. Visual and nonprecision marking.

2-4. Marking practices. The color of markings used on runways is white, while that used on taxiways or for marking deceptive, closed, or hazardous areas is yellow. On light-colored runway pavements, the contrast of the markings can be increased by outlining with a black border at least 6 inches in width. In some locations the use of striated marking, consisting of painted stripes 4 inches to 6 inches wide with equal width of unpainted area, has been effective in reducing frost heave of the pavement. This method also increases the coefficient of friction over the marking area. However, since this method results in reduced marking conspicuity, frequent maintenance is required to provide an acceptable marking system. Due to the reduced conspicuity, striated marking is not used on Category II or III runways.

2-5. Runway markings.

a. Marking precedence. Where runways intersect, the markings on the runway of the higher precedence continue through the intersection, while the markings of the runway of the lower precedence are interrupted except that the runway threshold marking, designation marking, and touchdown zone markings are relocated along the lower precedence runway to avoid the intersection area. For intersection of runways of the same precedence order, the preferred runway (lowest approach minimums or most often used) is considered to be of a higher precedence order. For marking purposes, the order precedence, in descending order, is as follows:

- (1) Precision instrument runway, Category III.

- (2) Precision instrument runway, Category II.
- (3) Precision instrument runway, Category I.
- (4) Nonprecision instrument runway.
- (5) Visual runway.

b. Runway designation marking. Runways are identified by the whole number nearest one-tenth (1/10) the magnetic azimuth of the runway centerline. The magnetic azimuth of the runway centerline is measured clockwise from the magnetic north when viewed from the direction of approach. For example, where the magnetic azimuth is 183 degrees, the runway designation marking would be 18; and for a magnetic azimuth of 87 degrees, the runway designation marking would be 9. For a magnetic azimuth ending in the number "5," such as 185 degrees, the runway designation marking can be either 18 or 19. Numbers and supplemental letters; where required for parallel runways, are shown in figure 2-4. The supplemental letter is placed between the designation numbers and the threshold or threshold marking as shown in figure 2-2. Single digits are not preceded by a zero. The size and spacing of the numbers and letters are reduced only when necessary due to space limitations on narrow runways and should be no closer than 2 feet from the runway edge (or runway edge stripes if used). For parallel runways, the supplemental letter is determined as follows, in the order shown from left to right when viewed from the direction of approach:

- (1) For two parallel runways: "L", "R".
- (2) For three parallel runways: "L", "C", "R".

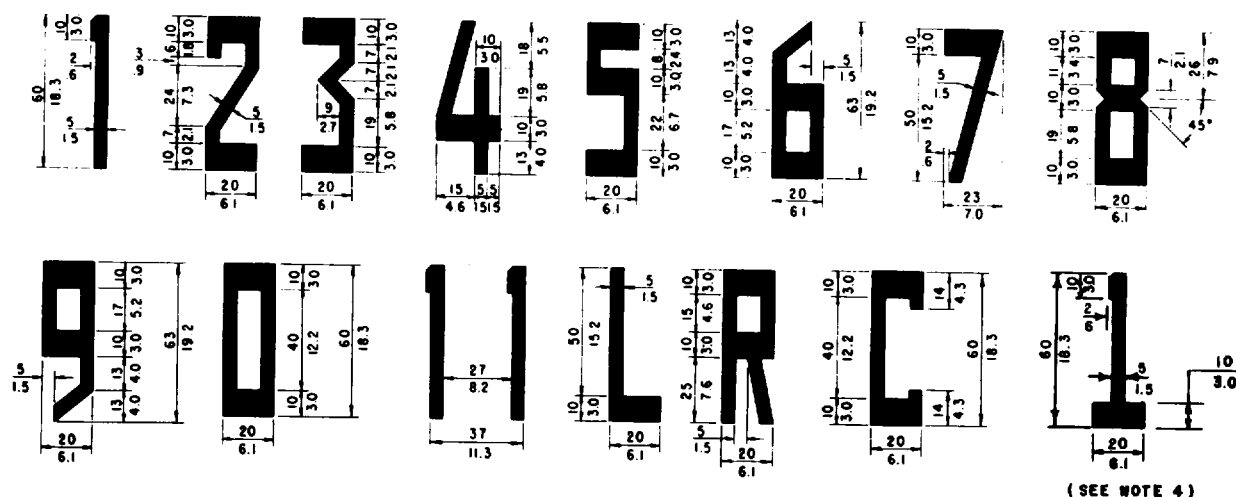
**NOTES:**

1. ALL LETTERS AND NUMERALS EXCEPT THE NUMBER ELEVEN AS SHOWN ARE HORIZONTALLY SPACED 15 FEET (4.6 METERS) APART.
2. FIGURES ARE TO SCALE.
3. DIMENSIONS ARE EXPRESSED THUS: $\frac{\text{FEET}}{\text{METERS}} \pm 0.30$
4. THE NUMERAL 1, WHEN USED ALONE, CONTAINS A HORIZONTAL BAR TO DIFFERENTIATE IT FROM THE RUNWAY CENTERLINE MARKING

Figure 2-4. Runway numbers and letters.

c. *Runway threshold marking.* The runway threshold marking consists of eight longitudinal stripes of uniform dimensions arranged symmetrically about the runway centerline as shown in figure 2-2. The stripes are 150 feet long and 5 feet wide and are spaced 14 inches apart except for the center space which is 8 feet.

d. *Runway centerline markings.* The runway centerline markings are located on the centerline of the runway and consist of a line of uniformly spaced stripes and gaps. The stripes are 120 feet in length, and the gaps are 80 feet in length as shown in figure 2-2. Adjustments to the length of the stripes and gaps, where necessary to accommodate the runway length, are made near the runway midpoint. The minimum width of the stripes is 12 inches for visual runways, 18 inches for nonprecision instrument runways, and 36 inches for precision instrument runways.

e. *Runway touchdown zone marking.* Touchdown zone markings consist of groups of one, two, and three rectangular bars symmetrically arranged in pairs about the runway centerline as shown in figure 2-2. For runways less than 150 feet in width, the markings and spaces are reduced proportionally, but the lengths remain the same. On shorter runways, those pairs of markings which would extend to within 900 feet of the runway midpoint are eliminated. The

fixed distance markings are a part of the touchdown zone markings but are used alone on certain nonprecision instrument runways and visual runways as indicated in paragraphs 2-3a and 2-3b.

f. *Runwayside stripe marking.* Runway side stripes consist of continuous stripes located along each side of the runway to provide contrast with the surrounding terrain or to delineate the full strength runway pavement area. The maximum distance between the outer edges of the stripes is 200 feet. The stripes have a minimum width of 36 inches for precision instrument runways and are at least equal to the width of the runway centerline stripes on other runways.

g. *Displaced threshold marking.* Displaced threshold areas which are used for takeoffs or rollouts are marked as shown in figure 2-5a. Runway edge stripes, where used on the runway, are continued along the edges of the displaced threshold area. Taxiway centerline markings may extend into the displaced area.

h. *Relocated threshold marking.* Relocated threshold areas where the abandoned runway area is not used for taxiing are marked as shown in figure 2-5b and where used as a taxiway are marked as shown in figure 2-5c.

i. *Markings for blast pads and stopway.* Markings for these areas are shown in figure 2-5b.

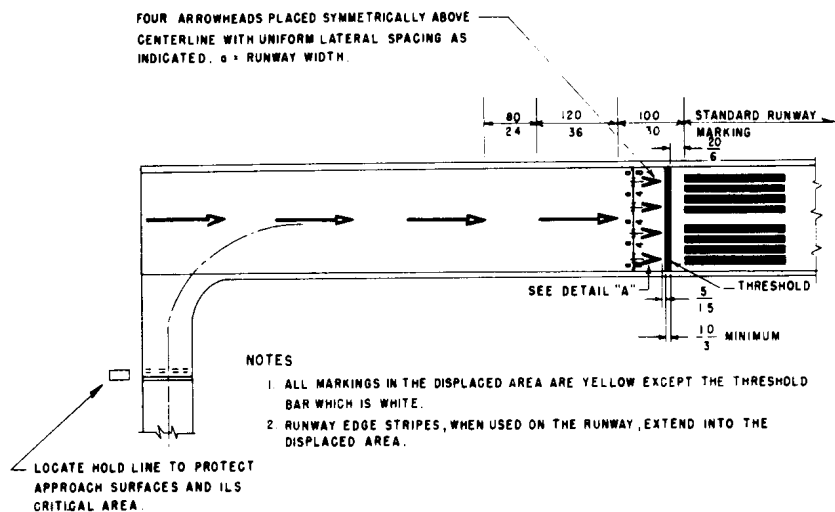

(a) DISPLACED THRESHOLD MARKINGS

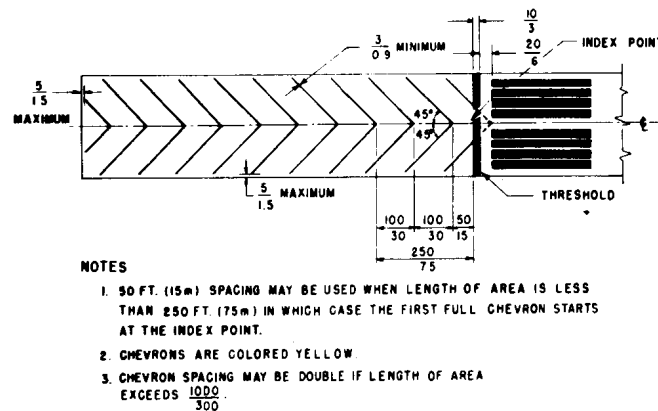

(b) MARKINGS FOR BLAST PADS AND STOPWAYS

NOTE
DIMENSIONS EXPRESSED THUS $\frac{50}{15}$ FEET
IS METERS

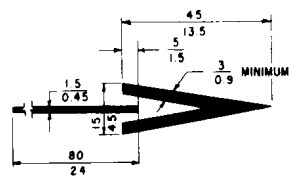

DETAIL "A"

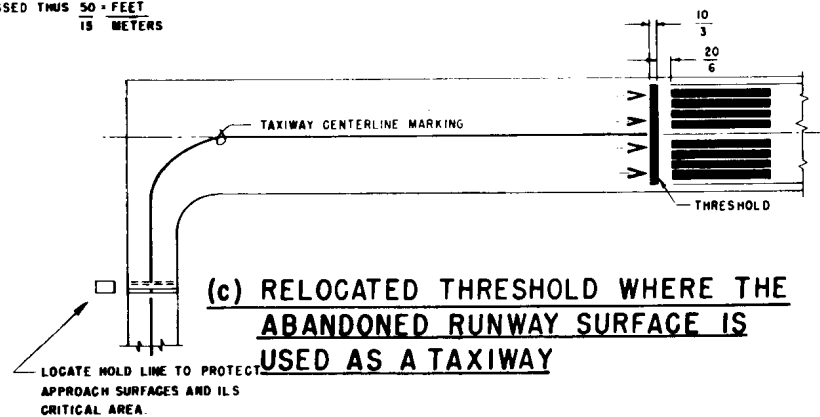

(c) RELOCATED THRESHOLD WHERE THE ABANDONED RUNWAY SURFACE IS USED AS A TAXIWAY

Figure 2-5. Marking for displaced thresholds, blast pads and stopways.

2-6. Taxiway markings.

a. Taxiway centerline marking. The taxiway centerline marking is a continuous yellow line of 6-inch minimum width.

(1) On a taxiway curve, the taxiway centerline marking continues from the straight portion of the taxiway at a constant distance from the outside edge of the curve. For taxiway intersections designed for the straight-through method of taxiing, the centerline markings continue straight through the intersection.

(2) At taxiway intersections with a runway end, the taxiway centerline marking is terminated at the runway edge (with exception of the situation where there is a displaced threshold, in which case the taxiway

centerline may be extended onto the runway displaced area). For intersections of taxiways with runways where the taxiway serves as an exit from the runway, the taxiway centerline marking may be extended onto the runway as shown in figure 2-6. The taxiway centerline marking is extended parallel to the runway centerline marking for a distance of 200 feet beyond the point of tangency. The curve radius should be large enough to provide a clearance to the taxiway or runway edge of at least 1/2 the width of the taxiway. For taxiways crossing a runway, the taxiway centerline marking may continue across the runway but must be interrupted for the runway markings.

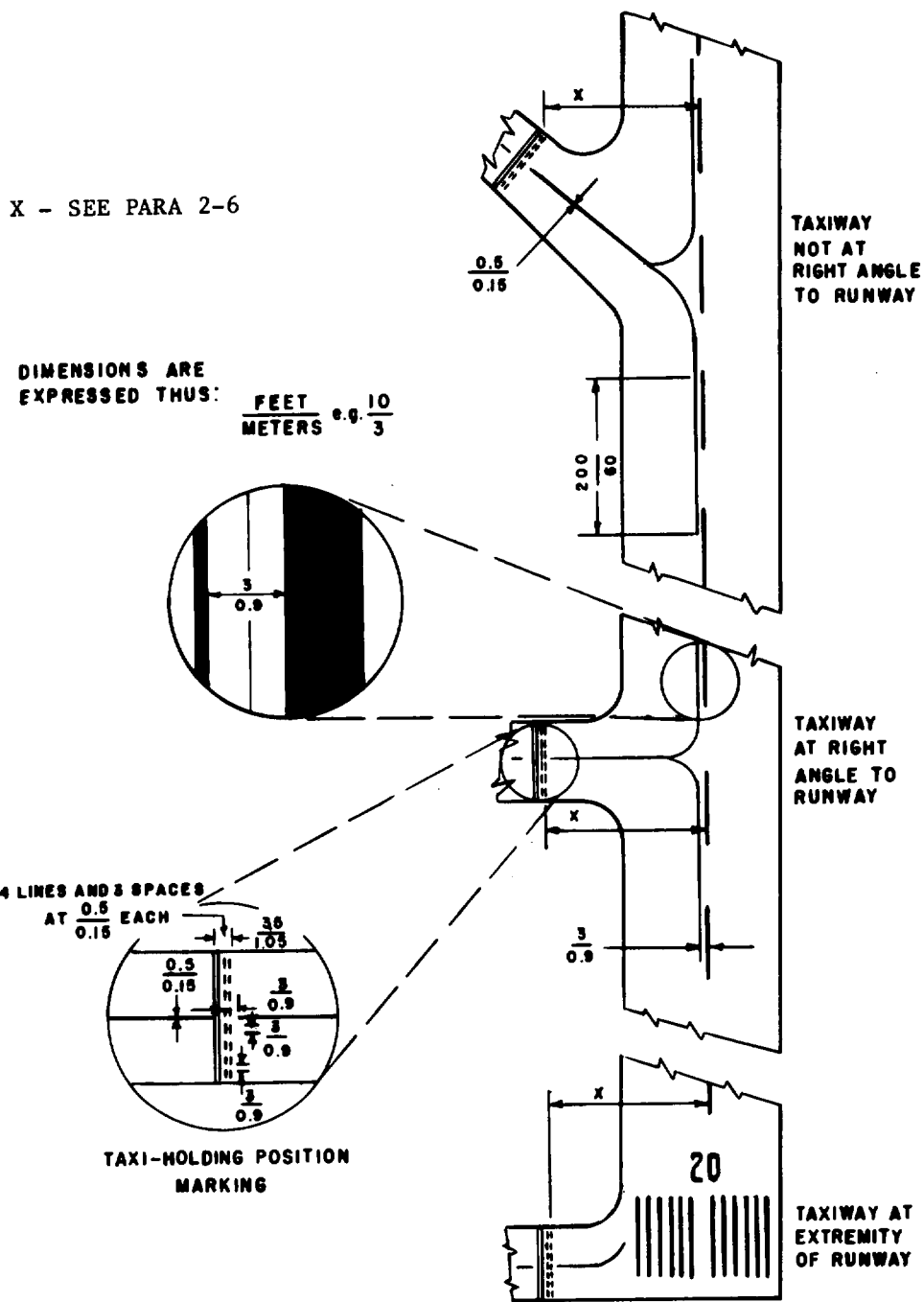

Figure 2-6. Taxiway/runway intersection marking. (Sheet 1 of 2).

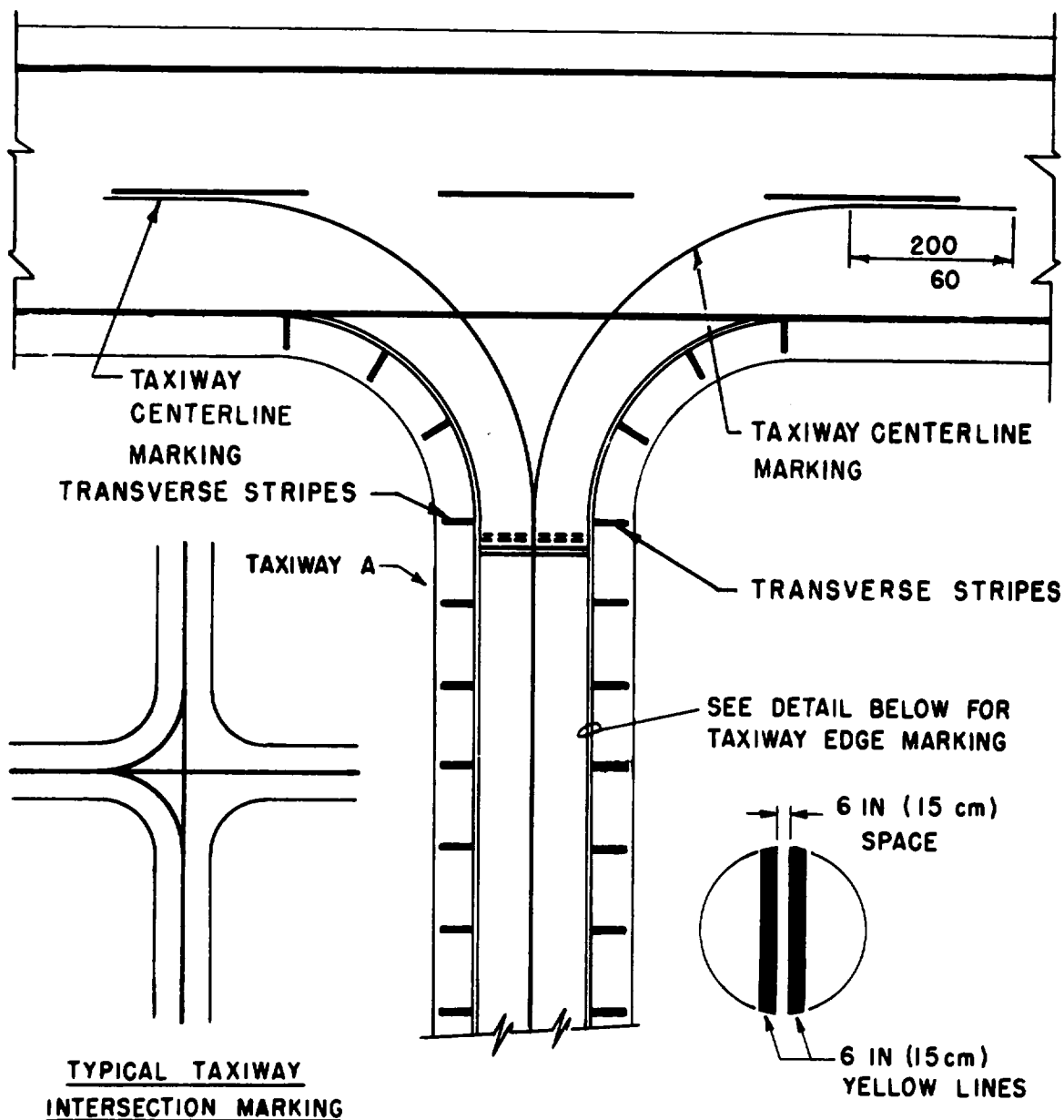

Figure 2-6. Taxiway/runway intersection marking. (Sheet 2 of 2).

b. *Taxiway edge marking.* The edge markings are used where the edge of the full strength pavement of the taxiway is not readily discernible or where a taxiway must be outlined when established on a large paved area such as an apron. These markings consist of continuous

double yellow lines with the line being 6 inches in width and spaced 6 inches apart as shown in figure 2-6 (sheet 2). If only one edge is not discernible, both pavement edges will be marked.

Where used, locate the taxiway holding line on taxiway intersections 100 feet from the structural pavement edge. When the taxiway is associated with a holding bay, the marking may be parallel to the centerline of the runway or intersecting taxiway. Details of the taxiway holding line are shown in figures 2-2 and 2-6. The markings are not required on taxiways which are never used for crossing or access to the runway. The inscription on the associated sign is the runway number. For intersections where takeoffs are conducted, the inscription denotes only that particular runway such as "18." For other intersections, the inscription denotes both runways such as "18-36." In this example runway 18 is to the left and runway 36 is to the right.

(2) *ILS holding position markings.* ILS (instrument landing system) holding position markings

are used to protect ILS localizer and glide slope critical areas as shown in figure 2-8. Pending completion of tests and issuance of criteria for critical areas, the ILS critical areas should be used for microwave landing system (MLS) and interim standard MLS (ISMLS) facilities to insure signal protection. Where the normal location of the ILS holding position marking and the taxiway holding position marking falls within 25 feet of each other, the ILS holding position marking may be omitted provided that the taxiway holding position marking is located to protect both the runway and the ILS critical area. An ILS holding position marking should never be installed between a taxiway holding position marking and a runway. The sign inscription for ILS holding position markings is "ILS."

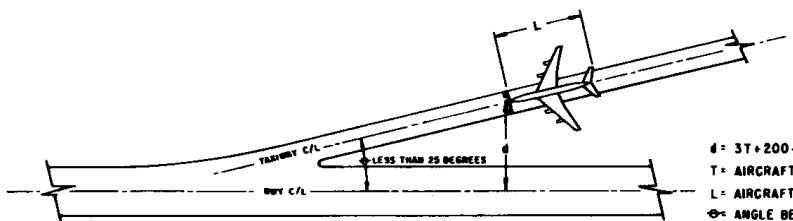

(c) LOCATING HOLDING POSITION LINE FOR TAXIWAY INTERSECTING RUNWAY AT AN ANGLE LESS THAN 25 DEGREES

$3T + 200 - L \sin \phi$
 T = AIRCRAFT TAIL HEIGHT
 L = AIRCRAFT LENGTH
 ϕ = ANGLE BETWEEN RUNWAY AND TAXIWAY CENTERLINES

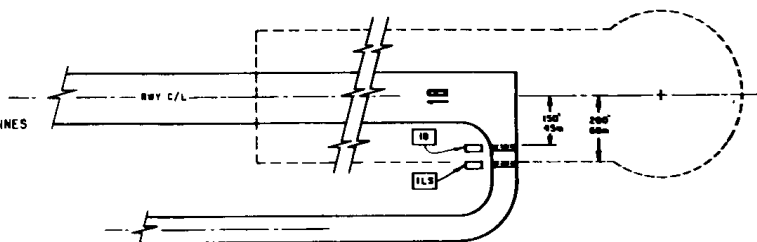

(b) EXAMPLE FOR A NONPRECISION (LOCALIZER APPROACH) RUNWAY USED BY TURBOJETS LESS THAN 60,000 LBS (27 200 kg).

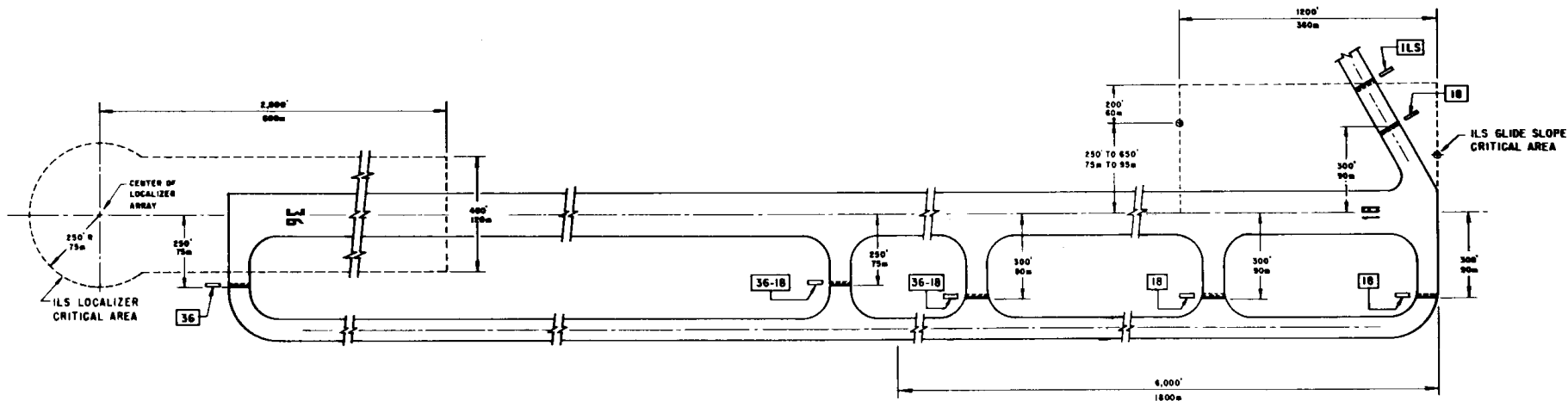

(a) EXAMPLE FOR A PRECISION APPROACH RUNWAY FOR LARGE AIRCRAFT

Figure 2-8. Holding position markings.

2-7. Stabilized areas. Holding bays, aprons, and taxiways are sometimes provided with shoulder stabilization to prevent blast and water erosion. This stabilization may have the appearance of a full strength pavement but is not intended for use by aircraft. Usually the taxiway edge marking will define this area, but conditions may exist such as stabilized islands or taxiway curves where confusion may exist as to which side of the edge stripe is the full strength pavement. Where such a condition exists, the stabilized area is marked with 3-foot wide yellow lines perpendicular to the edge stripes as shown in figure 2-6 (sheet 2). On straight sections, the marks are placed at a maximum of 100-foot spacing. On curves, the marks are placed a maximum of 50 feet apart between the curve tangents. The stripes are extended to 5 feet from the edge of

the stabilized area or to 25 feet in length, whichever is less.

2-8. Runway shoulder marking. Usually the runway side stripes will indicate the edges of the full strength pavement. However, conditions may exist, such as exceptionally wide runways, where there is a need to indicate the area not intended for use by aircraft. In such cases, chevrons, as shown in figure 2-7, are used.

2-9. Aircraft parking ramps, tiedown and mooring areas. Tie-down points at parking ramps and tie-down or mooring areas are usually marked in the shape of a ball with yellow nonreflective paint. Dimensions of the area to be painted are at the discretion of the airfield or heliport commander.

CHAPTER 3 MARKING OR SERVICEABLE RUNWAYS AND TAXIWAYS AT HELIPORTS

3-1. General. Marking of heliports will conform to the requirements as set forth below and govern the initial marking and re-marking of serviceable runways, taxiways, landing pads, and other areas designated for heliport and helipad operations.

3-2. Marking with paint. Initial marking of runways and taxiways should be done as soon as possible, subsequent to the required curing period. Re-marking or revising existing markings should be accomplished as often as necessary. The effectiveness of markings is heavily dependent upon their proper maintenance to provide maximum contrast with backgrounds.

a. Color marking. All runways will be marked with white reflective paint. Identification markers, landing pads and hoverpoints will be marked with white nonreflective paint. All taxiways will be painted with yellow nonreflective paint.

b. Application of paint. Painted marking will be applied to paved areas only after the pavements have been allowed to cure thoroughly. New pavement surfaces will be allowed to cure for a minimum of 30 days before application of marking materials. Care will be taken to insure that the pavement surface is dry and clean prior to painting.

(1) When painted markings are to be applied to rigid pavements that have been cured with a membrane-type curing compound, the surface to be painted must be cleaned thoroughly and the curing compound must be removed by sandblasting.

(2) Flexible pavements will be allowed to cure as long as practicable before painting, and, to prevent undue softening of the bitumen by the paint, the maximum drying-time requirements of the paint specifications will be strictly enforced.

3-3. Runway marking. Markings on serviceable runways will consist of centerline marking and runway-direction numbers.

a. Runway-centerline marking. The runway-centerline marking will be a solid white line 1 foot in width. The centerline stripe of each runway will terminate 20 feet from the runway-direction numbers as shown in figure 3-1.

b. Runway-direction number. Each runway

end will be designated by number and, where required, by letter. Numbers and letters assigned will be determined from the approach direction and will conform to the form and dimensions shown in figure 3-1. The number assigned will be the whole number nearest one-tenth of the magnetic azimuth of the centerline of the runway, measured clockwise from the magnetic North. Single digits will not be preceded by a zero. Where required, the letters used to differentiate between parallel runways will be as follows in the order shown from left to right, for two parallel runways-"L", "R".

c. Intersection of runway ends. Where runway ends have a common intersection, preference in location of the marking will be given to the more important runway.

3-4. Taxiway marking requirements. Marking on serviceable taxiways will consist of a centerline stripe and a holding line. The centerline stripe will be a solid yellow line 6 inches in width. Where a taxiway and a runway have a common intersection, the centerline marking of the taxiway will terminate at a point in line with the inside edge of the runway as shown in figure 3-1. The holding-line marking will be as shown in detail "A" of figure 3-1 and will be located 100 feet from the inside edge of the adjacent runway.

3-5. Heliport identification marker requirements. Heliport identification marking patterns will be in accordance with the dimensional criteria in figure 3-2.

a. Application. The marking pattern will be used as an identification marker at all heliports at ground level or elevated, and at helicopter takeoff and landing areas at any other location. All helicopter landing areas bearing the outdated day marker or nonstandard identification marking will be re-marked with the proper identification marking as soon as practicable.

b. Location. The marker will be placed in the approximate center of the touchdown area of all helicopter landing pads and at the ends of all helicopter runways.

c. Special requirements.

(1) *Existing construction.* On all existing facilities where the color of the touchdown surface is lighter than color chip 36440 of Federal Standard 595, the marking pattern will be outlined with black paint as shown in figure 3-2.

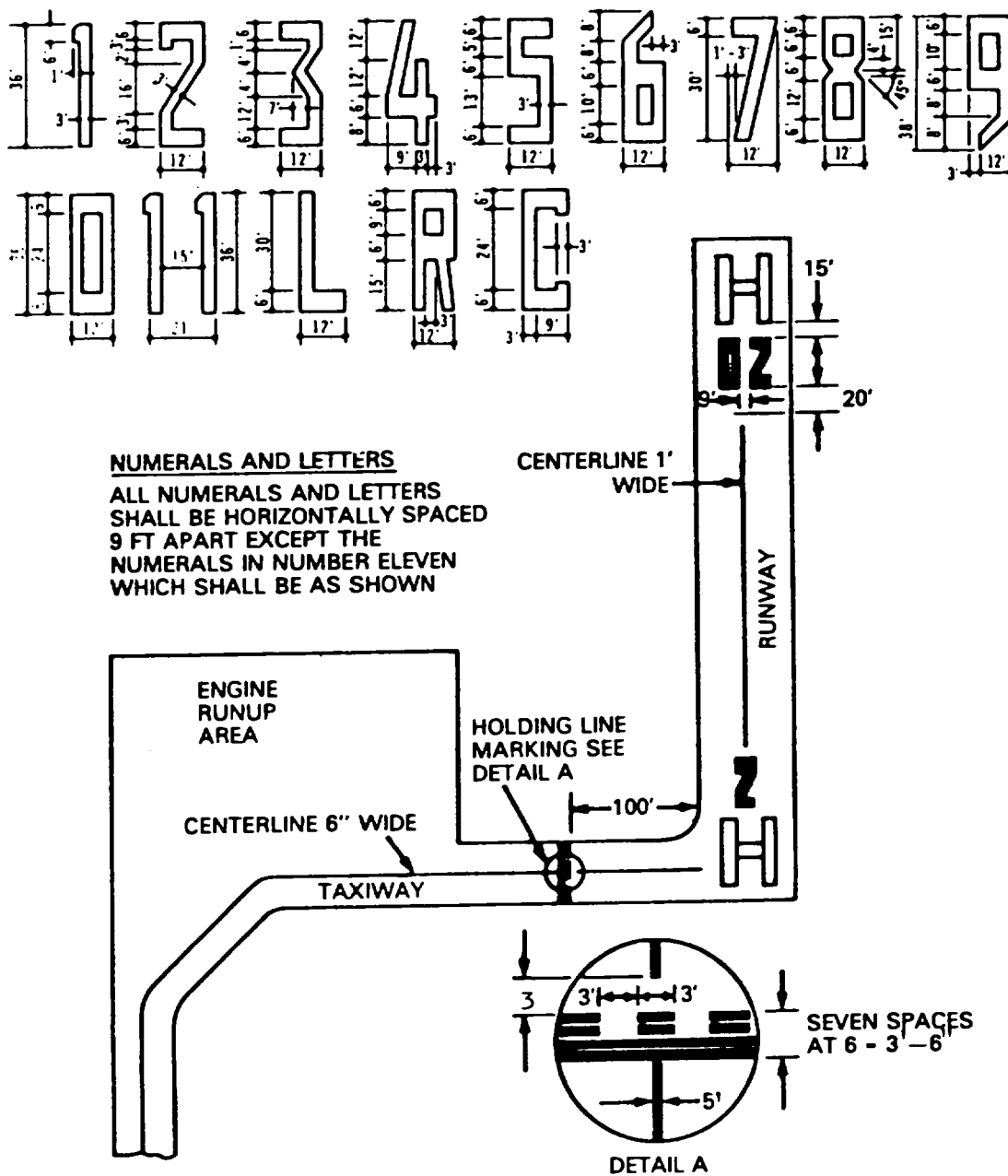
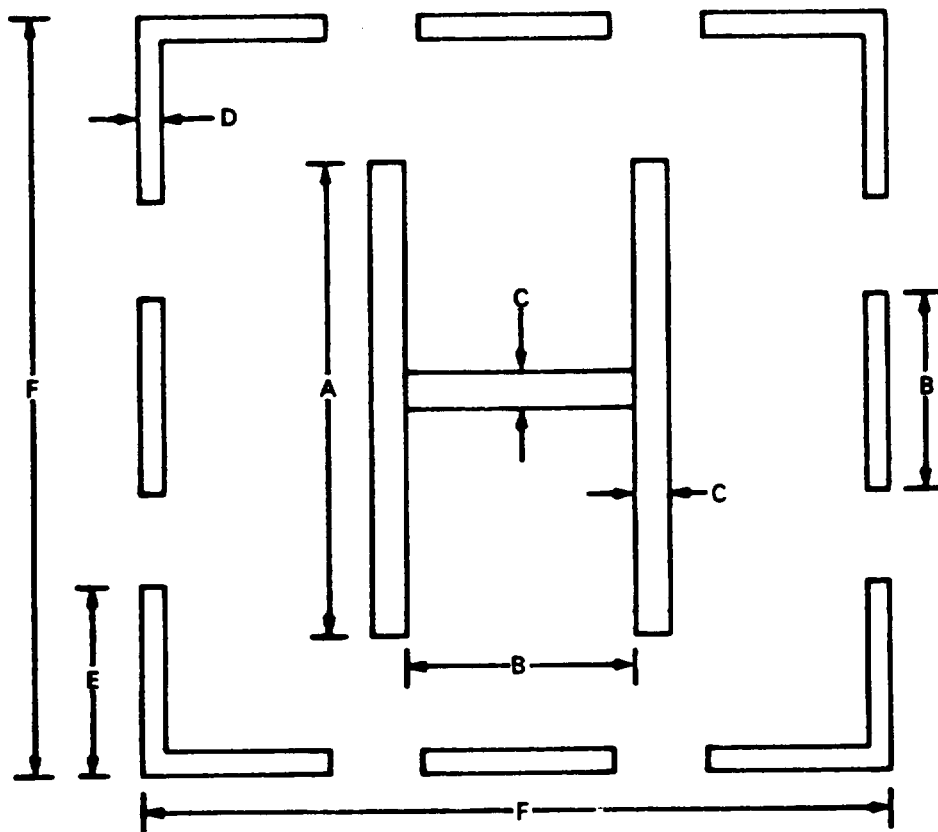

Figure 3-1. Guidelines for marking runways and taxiways at heliports.

The width of the pattern outline is referenced as dimension "D" in figure 3-2 and is the same for both the inner and outer outline. If the color of the touchdown area is equal to or darker than the referenced color, the black outline will not be included in the marking pattern.

(2) *New construction.* The touchdown area on which the marking pattern will be placed will be

constructed in a manner so that the surface will be equal to or darker than color chip 36440 of Federal Standard 595. The black pattern outline will not be included in the marking pattern. When the touchdown facility is constructed of rigid pavement the referenced color will be provided for a minimum thickness of 2 inches from the top surface.



DIMENSIONS

A : 0.6 F (maximum of 20 metres)
 B : 0.5 A

HELIPAD SIZE (F)	PATTERN LINE WIDTH (C)	BORDER EDGE WIDTH (D)	CORNER EDGE LENGTH (E)
13.0 - 18.0 m	1.0 m	0.4 m	1.5 m
18.3 - 24.0 m	1.3 m	0.6 m	2.2 m
24.3 - 30.0 m	1.5 m	0.6 m	3.0 m
30.2 - 45.0 m	2.0 m	0.75 m	3.5 m

Figure 3-2. Helipad marking pattern.

CHAPTER 4

MARKING OF OVERRUN AND SHOULDER AREAS AT HELIPORTS

4-1. General. Double-bituminous-surface-treatment overrun and shoulder areas that are not intended for aircraft traffic will be marked with yellow lines 18 inches wide in accordance with the requirements below. Configurations complying with these requirements are detailed in figures 4-1 and 4-2.

4-2. Overrun areas. Overrun areas will be marked with a chevron layout as shown in figure 4-1. The index point for the layout of the chevron marking will be the point of intersection of the runway centerline and the runway threshold line. The apex of the initial chevron on the approach side of the threshold will be at a point 25 feet outward from the index point. Subsequent chevrons will be placed on 50-foot centers as shown in figure 4-1. Partial chevrons will be placed as indicated in figure 4-1. The apex of each chevron will be on the centerline with each leg making an angle of 45 degrees with the runway centerline. The chevrons will terminate at a point 5 feet inside the outer edge of the shoulder area.

4-3. Runway-shoulder areas. All runway-shoulder areas will be marked as shown in figure 4-1. These partial chevrons are a continuation of the chevrons used in marking overrun areas as indicated in paragraph 4-2 above and as shown in figure 4-1. The chevrons used in marking the runway-shoulder areas will have the same index point as the chevrons marking the overrun areas. Chevrons will be laid out uniformly from both ends of the runway as shown in figure 4-1. The partial chevrons will terminate at a point 5 feet inside the outer edge of the shoulder area.

4-4. Taxiway, taxilane, apron, hardstand, and engine-runup shoulder areas.

a. Straight sections. Straight sections of taxiways will be marked by yellow lines 18 inches wide beginning at the runway-shoulder edge and spaced at intervals not exceeding 50 feet as shown in figure 4-1. The lines will be perpendicular to the centerline of the

taxiway, beginning at the edge of the taxiway and extending outward to a point 5 feet inside the outer edge of the shoulder area. Straight sections of taxilane, apron, hardstand, and engine-runup shoulder areas will be marked by lines beginning at points not exceeding 50 feet from all points of tangency of curves and will be perpendicular to the paved area edges as shown in figures 4-1 and 4-2. Lines will terminate 5 feet inside the outer edge of the shoulder areas.

b. Curved sections. Curved sections of all shoulder areas will be marked by one line beginning at the edge of the paved areas and extending outward to a point 5 feet inside the outer edge of the shoulder area. The marking will be placed radially beginning at the center of the curve as shown in figures 4-1 and 4-2.

4-5. Detail requirements.

a. Color marking. All heliport overrun and shoulder areas will be marked with nonreflective yellow paint.

b. Marking materials. Nonreflective paint used in marking or re-marking overrun and shoulder areas will consist of the pigmented binder (paint) stated in paragraph 2-2a(2) above.

c. Application of paint. Painted markings will be applied to overrun and shoulder areas only after the double bituminous surface treatment has been allowed to cure as long as practicable. Care will be taken to insure that the surface to be painted is clean and dry prior to painting. To prevent undue softening of the bitumen by the paint, the maximum drying-time requirements of the paint specifications will be strictly enforced.

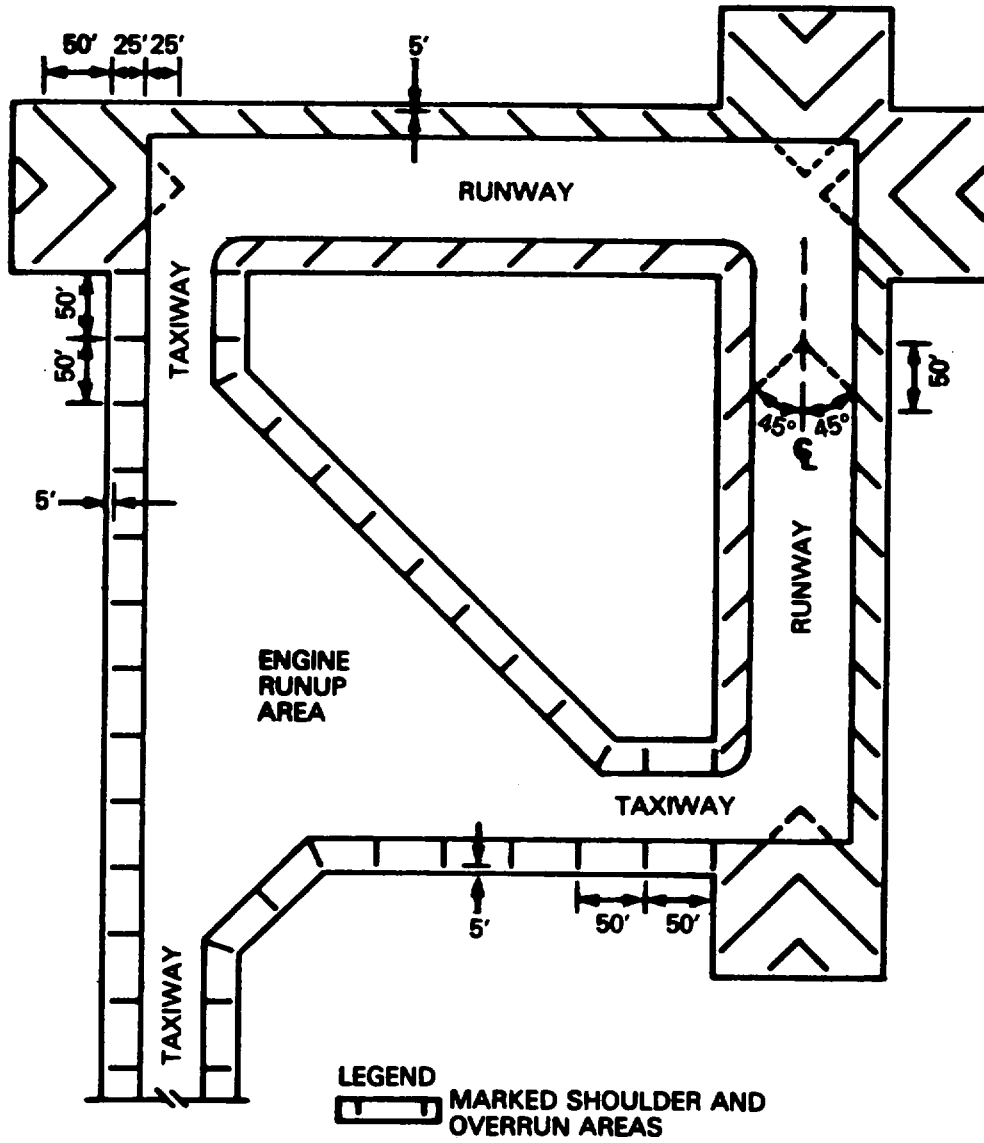

Figure 4-1. Marking of heliport overrun and shoulder area.

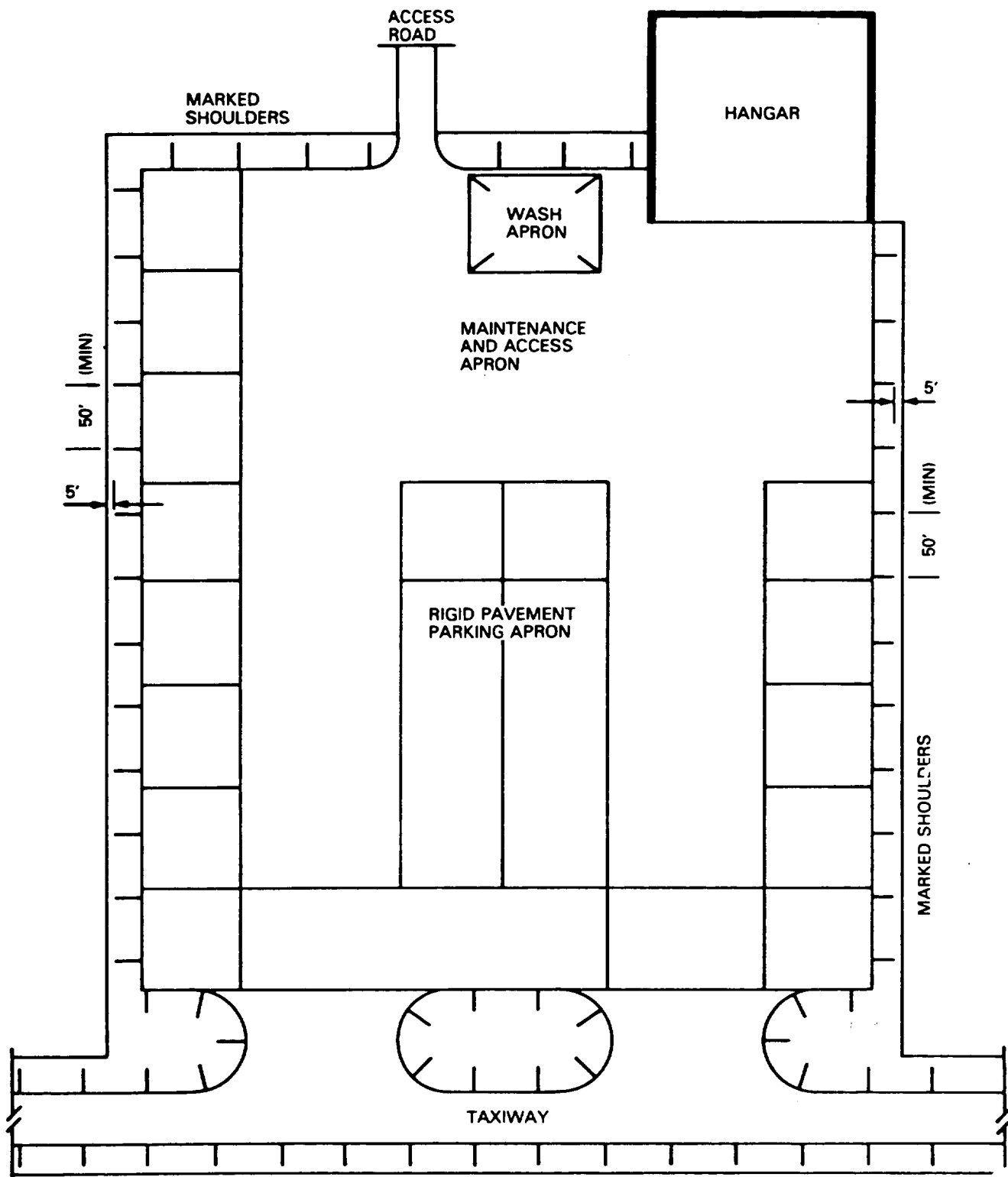

Figure 4-2. Marking of shoulders for heliport parking and maintenance aprons and taxiways.

CHAPTER 5

MARKING AND LIGHTING OF CLOSED OR HAZARDOUS AREAS ON AIRFIELDS OR HELIPORTS

5-1. Permanently closed runways and taxiways.

For runways and taxiways which have been permanently closed, the lighting circuits will be disconnected. For runways, the threshold markings, runway designation marking, and touchdown zone markings will be obliterated, and crosses will be placed at each end and at 1,000-foot intervals. For taxiways, a cross will be placed on the closed taxiway at each entrance. The crosses shown in figures 5-1*a* and 5-1*c* are normally used, but the crosses shown in figures 5-1*b* and 5-1*d* are more readily seen from aircraft on final approach and may be used where desired.

5-2. Temporarily closed runways and taxiways.

Temporarily closed runways are treated in the same manner as in paragraph 5-1 except runway and taxiway lights will be turned off and runway markings are not obliterated, crosses are usually of the temporary type (constructed of material such as fabric or plywood), and crosses are required only at runway ends. The crosses are located on top of the runway numerals. For temporary marking, the dimensions of the crosses shown in figures 5-1*a* and 5-1*c* may be reduced to permit use of standard sheets of 4 by 8-foot plywood. Temporarily closed taxiways are usually treated as an unusable area as explained in paragraph 5-4 below.

5-3. Closed airfields and heliports. When all runways are closed temporarily, the runways are marked as in paragraph 5-2 above and the airport beacon is turned off. When all runways are closed permanently, the runways are marked as in paragraph 5-1 above, the airport beacon is disconnected, and a cross is placed in

the segmented circle or at a central location if no segmented circle exists.

5-4. Hazardous areas. Hazardous areas, in which no part of an aircraft may enter, are indicated by use of barricades with alternate orange and white markings. The barricades are supplemented with orange flags a minimum of 20 by 20 inches square and made and installed so that they are always in the extended position and properly oriented. For nighttime use the barricades are supplemented with flashing red lights. The intensity of the lights and spacings for barricades, flags, and lights must be such to adequately define and delineate the hazardous area.

5-5. Stabilized areas. For marking requirements of holding bays, aprons and taxiways of closed or hazardous areas at airfields and heliports, the criteria stated in paragraph 2-7 will apply.

5-6. Runway shoulder areas. For marking requirements of runway shoulder areas of closed or hazardous areas at airfields and heliports, the criteria stated in paragraph 2-8 will apply.

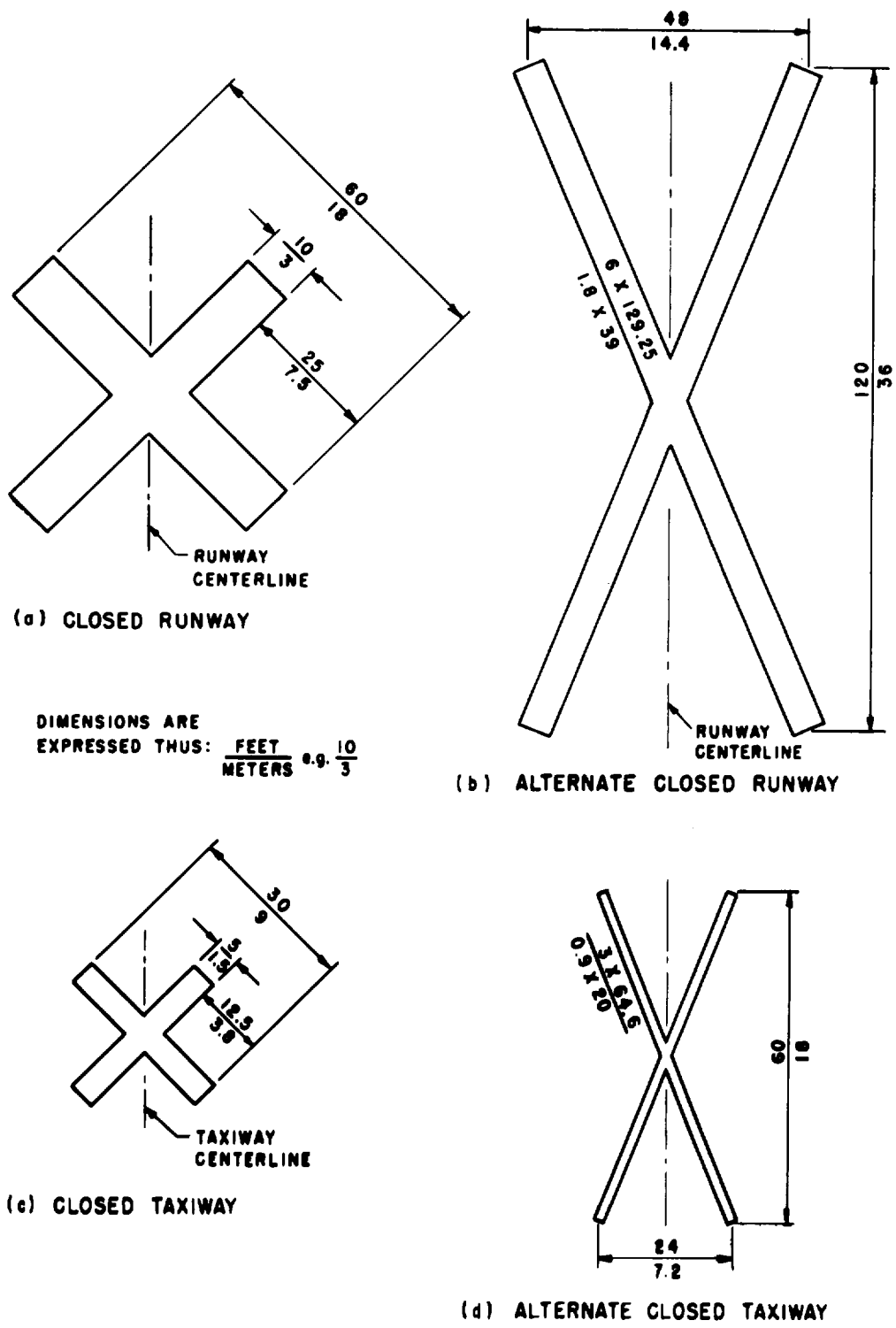

Figure 5-1. Closed runway and taxiway markings.

CHAPTER 6

MARKING OF COMPASS SWINGING BASES

6-1. General. Compass swinging bases for alining aircraft for the precise calibration of all types of air navigation equipment will be marked as shown in figure 11.

6-2. Magnetic effects. Because of the calibration operation involved, the compass-swinging base will be located in an area of the airfield or heliport where local magnetic influence is at a minimum to preclude inherent deviations that would destroy the accuracy of the calibration. To realize this objective, the compass-swinging base will not be placed in proximity to power transmission lines or concentrations of underground conduits or pipe, railroads, or rail sidings, automobile or aircraft traffic, buildings containing ferrous metals, or in areas containing natural magnetic disturbances. Each location for a compass-swinging base must be checked by a magnetometer to insure that the area has negligible magnetic characteristics regardless of adherence to the above criteria and magnetic limitations specified in Military Standard MIL-STD-765.

6-3. Pavement grade. The compass-swinging-base pad will be level in all directions. The grade of the connecting taxiway and shoulder areas associated with this facility will be in accordance with criteria given in TM 58034.

6-4. Alinement markings. The compass-swinging-base pad will be marked with precision alinement indicators accurate to within 0.25 percent of 1 degree.

6-5. Clearances.

a. A minimum distance of 275 feet will be provided from the center of the compass-swinging-base pad to the nearest :

-Significant quantity of iron.

-Parking area or hardstand for aircraft, vehicles, or equipment.

-Taxiway, or engine runup.

b. A minimum distance of 100 feet will be provided from the center of the compass-swinging base to a 67 kilovolt or less power transmission line. Consideration will be given to the necessity for greater separation in order to avoid adverse influence from power transmission lines in excess of 67 kilovolt.

6-6. Marking with paint. Initial marking and re-marking of compass swinging bases should be done as soon as possible, subsequent to the required curing period. Re-marking existing marks should be accomplished as often as necessary. The effectiveness of markings is heavily dependent upon their proper maintenance to provide maximum contrast with backgrounds. Compass-swinging bases will be painted with white nonreflective paint that conforms to paragraph 2-2a(2).

6-7. Application of paint. For application of paint see paragraph 2-2b.

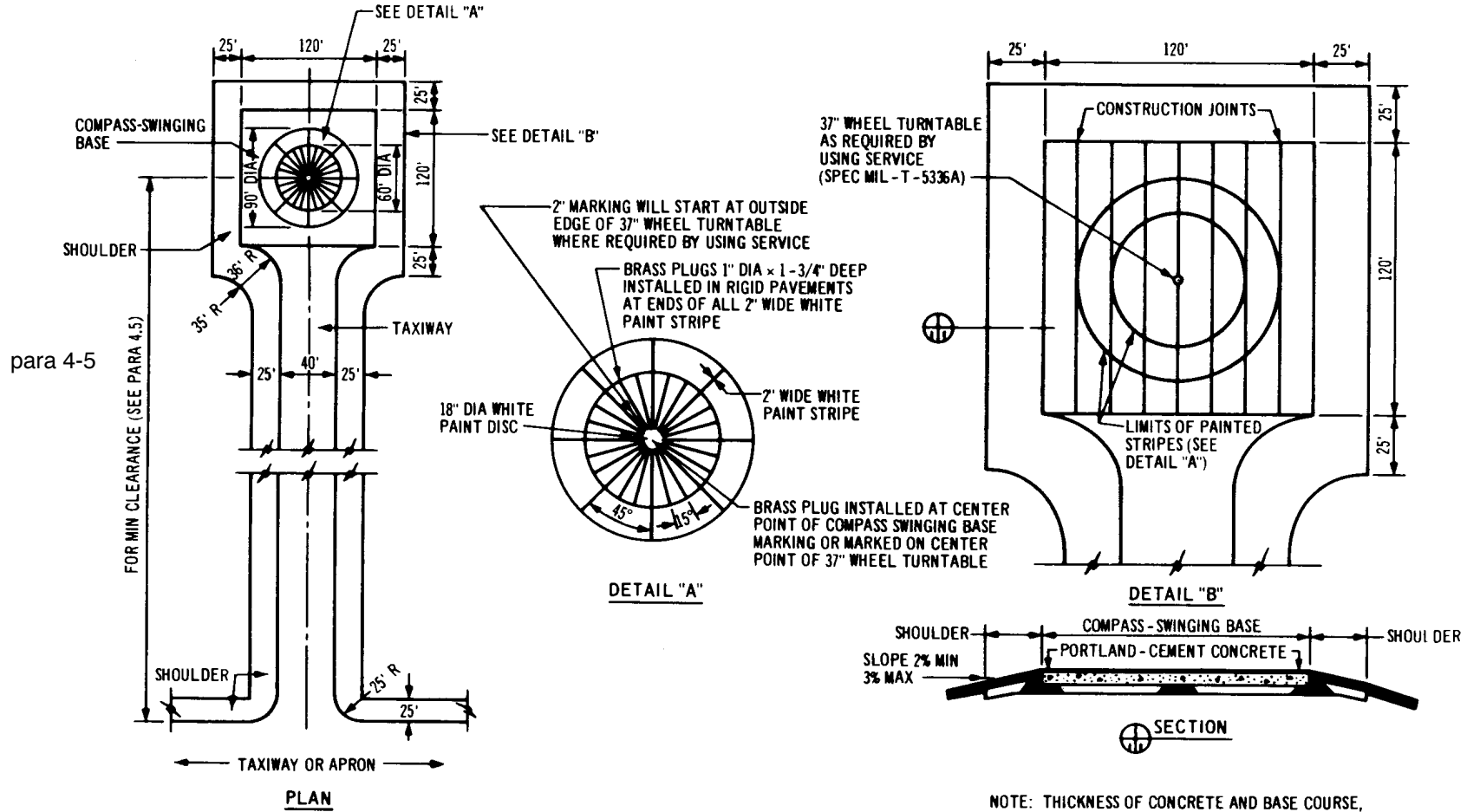

EACH PROPOSED LOCATION FOR A COMPASS-SWINGING ABASE MUST BE CHECKED BY A MAGNETOMETER TO INSURE THAT THE AREA HAS NEGLIGIBLE MAGNETIC CHARACTERISTICS REGARDLESS OF ADHERENCE TO PARA 4-5.

Figure 6-1. Army airfield-heliport compass swinging base.

REPRODUCTION AUTHORIZATION/RESTRICTIONS

This manual has been prepared by or for the Government and is public property and not subject to copyright. Reprints or republications of this manual should include a credit substantially as follows: "Department of the Army and Technical Manual TM 5-823-4, Marking of Army Airfield-Heliport Operational and Maintenance Facilities."

CHAPTER 7

MARKING OF OBSTRUCTIONS TO AIR NAVIGATION

7-1. General. Obstructions to air navigation at all airfields and heliports at Army installations will be marked in accordance with FAA AC No. 70/7460-1G. Obstruction marking will be limited to those objects that penetrate the clearance planes, and surfaces set forth in TM 5-8034 and to those objects that, by their nature and position constitute a hazard to air navigation. These markings should be held to the minimum commensurate with essential operational requirements. Obstruction markings on objects that are not, in fact, obstructions, present false and misleading information and should be eliminated.

7-2. Detail requirements. Only those paint materials will be used that meet the minimum standards established by the FAA.

a. Color marking. Obstruction marking will be made with aviation surface orange, or a combination of aviation surface orange and aviation surface white.

b. Marking materials. Obstructions will be marked by the use of surface colors wherever practicable. Surface colors will consist of paint conforming to the Federal Specification, Military Specification, or Department of the Army, Corps of Engineers, Guide Specifications for Military Construction covering paint appropriate for the material being painted, or reflective tape conforming to Federal Specification LS300. Where marking by surface color is impracticable, the general definition and location of the obstructions will be indicated by suitable markers or flag. Aviation surface orange is defined as a color not darker than color chip No. 12197 nor lighter than color chip No. 12246, as contained in Federal Standard No. 595.

c. Application.

(1) Painted markings will be applied to obstruction surfaces only after care has been taken to insure that such surfaces are dry and clean.

(2) Reflective tape will be applied according to the manufacturer's instructions.

(3) When impracticable to apply the marking material directly to the top 5 feet of poles or towers, supporting overhead or guy wires, the marking material may be placed on a backlog surface, longitudinally split tube or other mountable device and this may be attached directly to the poles or towers.

7-3. Lighting of airfields, heliports and obstructions. For criteria on lighting of airfields, heliports and obstructions, see TM 5-811-5.

7-4. Purpose of marking. The purpose of marking a structure is to warn airmen of its presence during daylight hours. To accomplish this objective, it may be

necessary to color the structure or indicate its presence by use of suitable markers, flags or lights.

7-5. Omission of standard marking. When high intensity lighting systems are employed in accordance with the standards contained herein, the marking of structures with standard aviation surface orange and white paint and red obstruction lights may be omitted. The high intensity lighting systems are considered to be far more effective than the aviation surface orange and white paint and may therefore be recommended in lieu of standard marking. This is particularly true under certain ambient light conditions and position of the sun relative to direction of flight.

7-6. Colors. Maximum visibility of an obstruction by contrast in colors can best be obtained by the use of aviation surface orange and white paint. Orange or white enamel paint may be used for marking, provided its chromaticity and luminance factors satisfy Federal Standard, color, as follows:

a. Orange. Number 12197 (aviation surface orange).

b. White. Number 17875 (aviation white).

7-7. Painting. The specifications of surface colors apply only to freshly painted surfaces. Paints used for surface markings usually change with time. While it is not feasible to require strict maintenance, surfaces should be repainted whenever the color changes noticeably or its effectiveness is impaired by scaling or chipping. A color tolerance chart is available for determining when repainting is necessary. The lower portion of structures situated in wooded or sheltered areas are protected to some extent from direct sunshine, blowing sand and sleet, and other atmospheric and environmental elements that tend to deteriorate painted surfaces. Therefore, examination of the ground or bottom band of aviation surface orange paint is not a good indication and should not be used as a criteria for determining when repainting is necessary.

a. Materials and application. Quality paint materials should be selected to be compatible with the surfaces to be painted, including previous coatings on the surfaces if any, as well as suitable for the environmental service conditions to which it will be subjected. Surface preparation and paint application should be accomplished in accordance with the manufacturer's recommendations as appropriate for the paint to be used and surface to be coated.

b. Surfaces not requiring paint. If the smooth surface of paint on the ladders, decks and walkways of certain types of steel towers and similar structures presents a potential danger to maintenance personnel, such surfaces need not be painted. Care should be taken so the overall marking effect of the painting is not reduced. Where the painting or the act of painting certain precision or critical surfaces would have an adverse effect on the desired transmission or radiation characteristics of a radio frequency signal, such painting may be omitted.

c. Skeletal structures. Paint should be applied to all surfaces both inner and outer, of the framework in order to be effective. This applies to the supporting structures of overhead transmission lines as well as radio, television and similar skeletal structures.

7-8. Patterns. Patterns of various types are used to mark obstructions to air navigation. Normally, the size and shape of the obstruction will determine the pattern to be used.

a. Solid pattern. An obstruction the projection of which on any vertical plane has both dimensions less than 10.5 feet, should be colored aviation surface orange.

b. Alternate bands of orange and white (figure 7-1). Alternate bands of aviation surface orange and white are normally displayed on the following structures:

(1) Radio and television towers and supporting structures of overhead transmission lines (see paragraph 7-9a).

(2) Poles.

(3) Smokestacks.

(4) Skeletal framework of storage tanks and similar structures.

(5) Structures which appear narrow from a side view.

(a) Width of bands. The width of bands for structures of any height should be equal, provided that each band has a width of not more than 100 feet nor less than 1½ feet. The bands should be perpendicular to the vertical axis of the obstruction with the bands at each

end colored orange. The width of each band for structures as high as 700 feet above ground level (AGL) should be approximately one-seventh of the height of the structure. Higher structures should be painted an additional orange and white band for each additional 200 feet of height, or fraction thereof, with the width of all bands equal and in proportion to the structure's height above ground level. For example, if a structure is:

<i>Greater Than</i>	<i>But Not Exceeding</i>	<i>Band Width</i>
10.5 feet	700 feet	1/7 of height of structure
700 feet	900 feet	1/9 of height of structure
900 feet	1,100 feet	1/11 of height of structure
1,100 feet	1,300 feet	1/13 of height of structure

If the top of the structure has a cover or roof, the top orange band should be continued to cover the entire top of the structure. If the object under study is a flagpole, skeletal structure or similar object erected on top of a building, the combined height of the object and building will determine whether marking is recommended; however, only the height of the object under study determines the width of the color bands.

(b) Partial marking. If marking is recommended on only a portion of a structure because of shielding by other objects or terrain, the width of the bands should be determined by the overall height of the structure. A minimum of three bands should be displayed on the upper portion of the structure.

c. Checkerboard pattern (figures 7-2 and 7-3). Checkerboard patterns of alternate rectangles of aviation surface orange and white are normally displayed on:

(1) Water, gas and grain storage tanks, excluding skeletal framework.

(2) Buildings.

(3) Structures which appear broad from a side view, such as structures having a horizontal dimension 10.5 feet or greater and this horizontal dimension is equal to or greater than the vertical dimension.

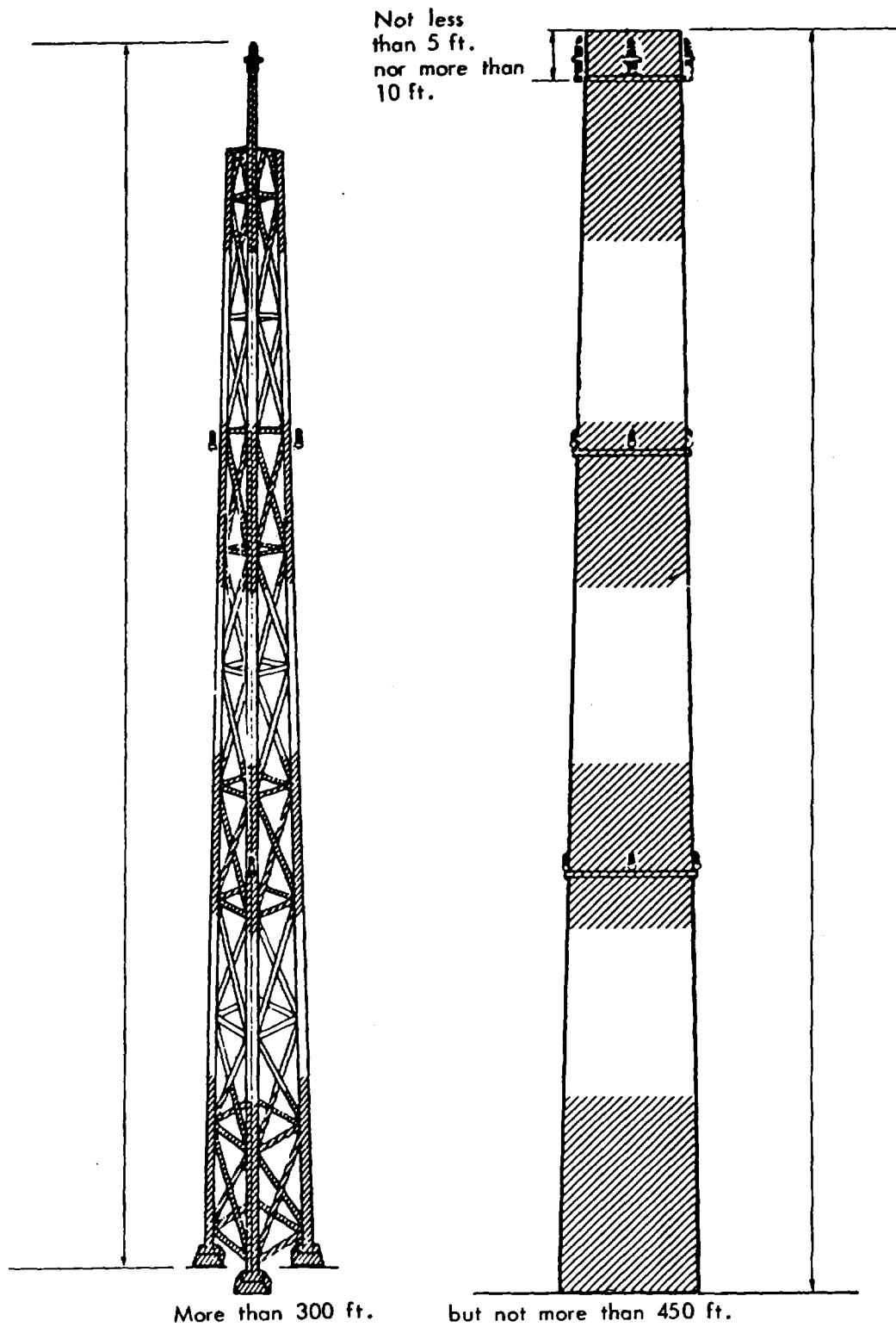

Figure 7-1. Painting and lighting of chimneys, poles, towers and similar obstructions.

TM 5-823-4

(a) *Size of rectangles.* The sides of the checkerboard rectangles should measure not less than 5 feet nor more than 20 feet. However, if it is impracticable because of the size or shape of a structure the rectangle may have sides less than 5 feet provided their dimensions remain as close as practicable to the 5-foot minimum. When possible, corner surfaces should be colored orange. If it is technically impracticable to color the roof of a structure in a checkerboard pattern, such roof may be colored orange. If part or all of a spherical shaped structure does not permit the exact application of

a checkerboard pattern, then the shape of the new rectangles may be modified to fit the shape of the spherical surface.

(b) *Exceptions.* If the type construction of storage tanks does not permit coloring by a checkerboard pattern, then such obstructions should be colored by alternate bands of orange and white, or a limited checkerboard pattern applied to the upper one-third of the structure, provided an aeronautical study indicates that the modified marking will provide adequate protection for air navigation.

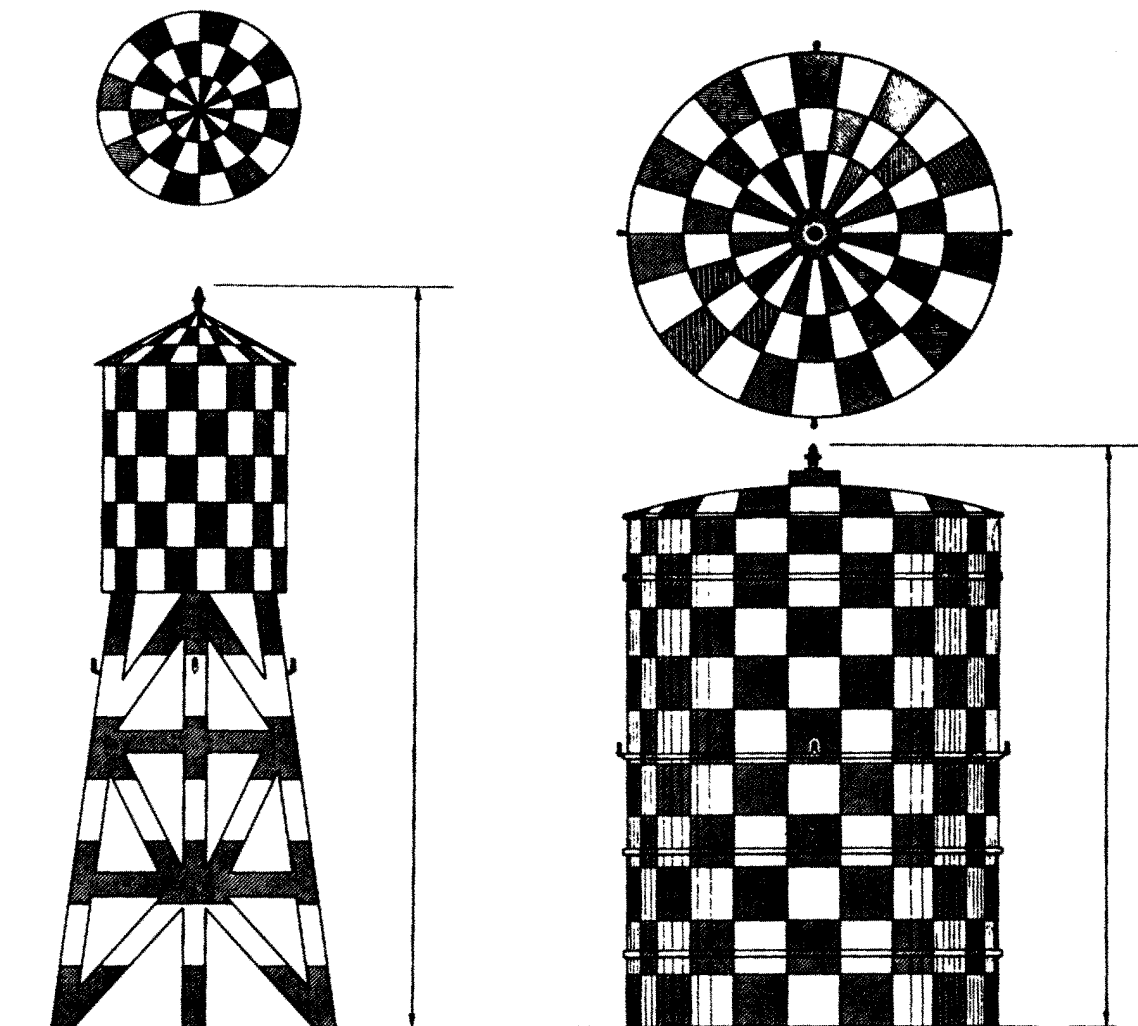

LIGHTING
More than 150 ft. but
not more than 300 ft.

LIGHTING
More than 150 ft. but
not more than 300 ft.

Figure 7-2. Painting and lighting of water towers, storage tanks and similar obstructions.

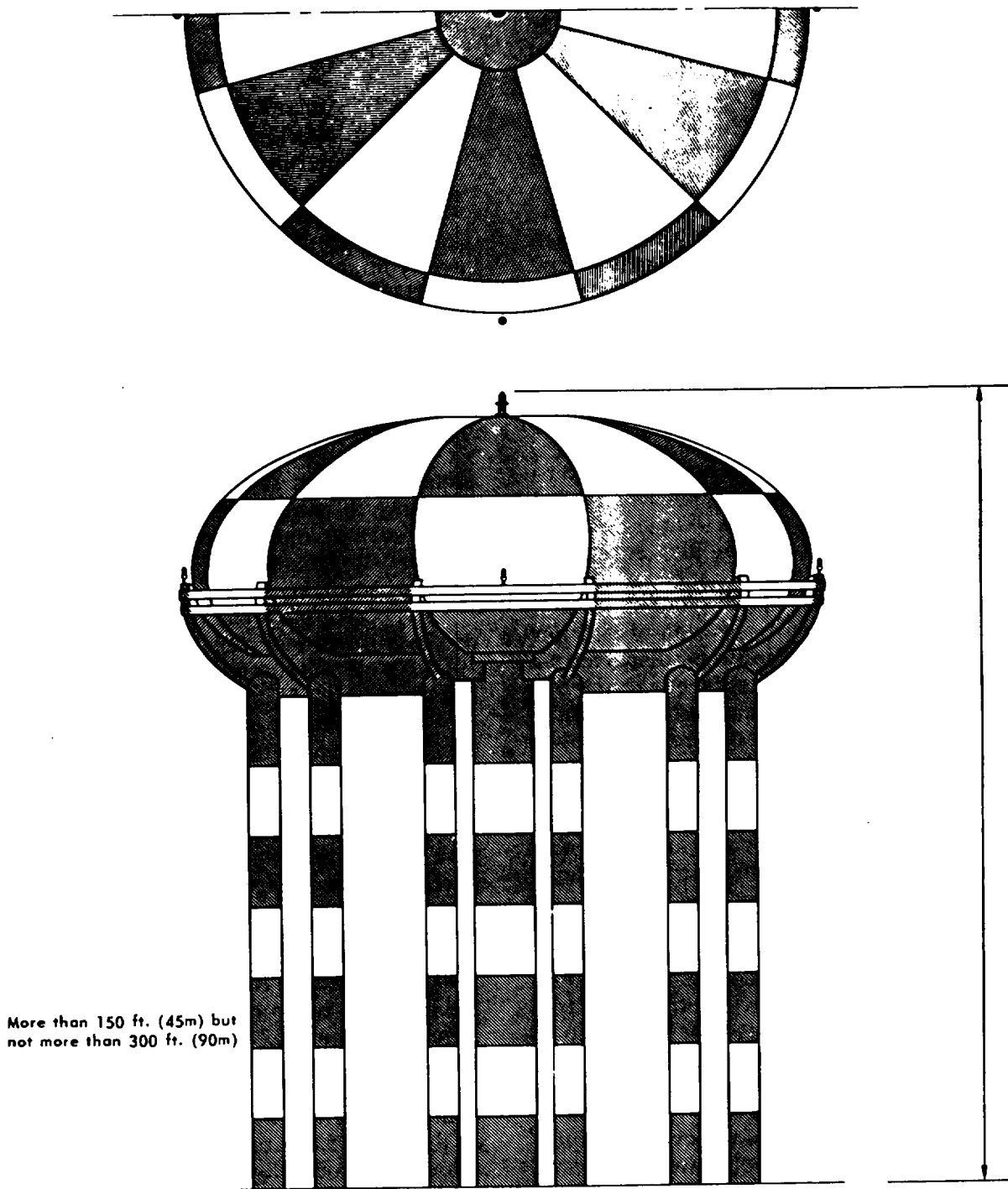

Figure 7-3. Painting and lighting of water towers and similar obstructions.

d. Teardrop pattern. Spherical shaped water storage tanks with a single circular standpipe support may be colored in a teardrop striped pattern, as shown in figure 7-4. The tank should be colored to show alternate stripes of aviation surface orange and white. The stripes should extend from the top center of the tank to its supporting standpipe.

(1) *Width of stripes.* The width of the stripes should be equal and the width of each stripe at the greatest girth of the tank should not be less than 5 feet nor more than 15 feet.

(2) *Community name.* If it is desirable to paint the name of the community on the side of the tank, the stripe pattern may be broken to serve this purpose. This open area should have a maximum height of 3 feet.

7-9. Markers. Markers should be used to mark obstructions when it has been determined that it is impracticable to mark such obstructions by painting. Markers may also be used in addition to aviation surface orange and white colors when it has been determined that such markings should be used to provide protection for air commerce. They should be displayed in conspicuous positions on or adjacent to the obstructions so as to retain the general definition of the obstruction. They should be recognizable in clear air from a distance of at least 1,000 feet in all directions from which an aircraft is likely to approach. They should be distinctively shaped so they are not mistaken for markers that are used to convey other information. The shape should be such that the hazard they mark is not increased.

a. Spherical markers. Spherical markers are normally displayed on overhead wires. Markers may be of another shape, provided the projected area of such markers will not be less than that presented by a spherical marker.

(1) *Display.* At least one such marker should be displayed at equal intervals for each 150 feet or fraction thereof, of the overall length of the overhead line and not lower than the highest wire. The top 5 feet of the poles and towers to which overhead wires or guy wires are attached will be marked. The distance between markers may be increased to not more than 600 feet when the overhead wires are located more than 15,000 feet from the nearest landing area. Where there is more than one overhead wire on which the spheres can be installed, the spheres may be installed alternately along each wire as long as the distance between adjacent spheres meets the spacing standard. This

allows the weight and wind loading factors to be distributed.

(2) *Size and color.* The diameter of the markers should not be less than 20 inches and should be colored aviation orange.

b. Flag markers. Flags may be used to mark obstructions when it has been determined that the use of coloring or spherical markers is technically impracticable.

(1) *Display.* Flag markers should be displayed around, on top of the obstruction or around its highest edge. When flags are used to mark extensive obstructions or closely grouped obstructions, they should be displayed approximately 50 feet apart.

(2) *Shape.* Flags should be rectangular in shape and have stiffeners to keep them from drooping in calm wind. The flag stakes should be of such strength and height that they will support the flags free of the ground, vegetation or nearby surfaces.

(3) *Color patterns.* Flags should be in one of the following patterns:

(a) *Solid color.* Aviation surface orange not less than 2 feet on a side.

(b) *Orange and white.* Two triangular sections, one of aviation surface orange and the other of aviation surface white, combined to form a rectangle not less than 2 feet on a side.

(c) *Checkerboard.* A checkerboard pattern of aviation surface orange and aviation surface white squares, each 1 foot plus or minus 10 percent on a side, combined to form a rectangle not less than 3 feet on a side.

7-10. Special markings. In addition to the marking recommendations included herein other documents contain appropriate guidelines.

a. Vehicles. Advisory Circular 150/5210-5, Painting, Marking and Lighting of Vehicles Used on an Airport, contains provisions for marking vehicles customarily used on landing areas.

b. FAA facilities. Obstruction marking for FAA facilities shall conform to FAA Drawing Number D-5480, referenced in Federal Aviation Agency Standard, FAA-STD-003, Paint Systems for Structures.

c. Unusual complexities. The FAA may also recommend appropriate marking in an area where obstructions are so grouped as to present a common hazard to air commerce.

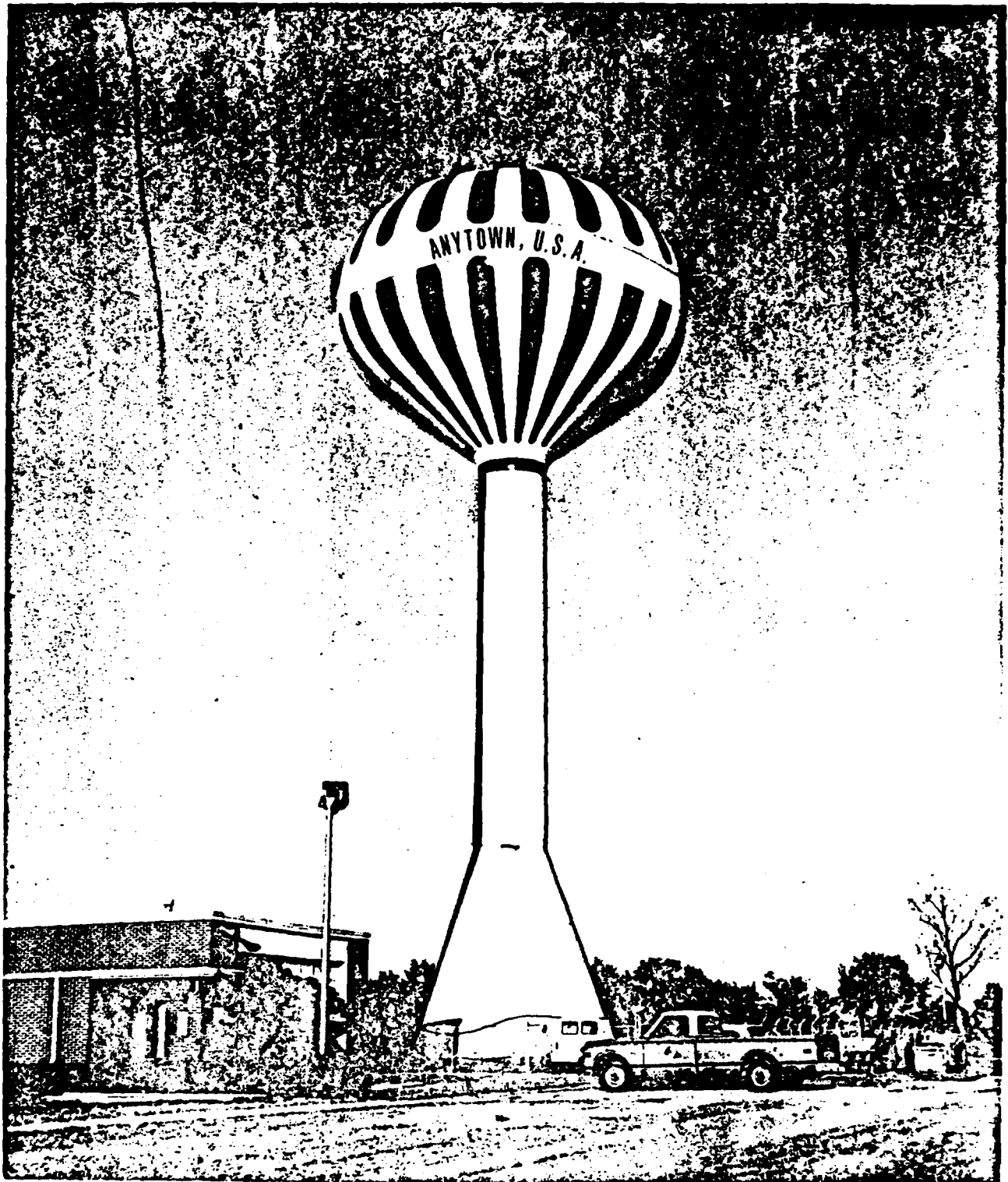

Figure 7-4. Painting of single pedestal water tower by teardrop pattern.

CHAPTER 8 GROUND RECEIVER CHECKPOINTS

8-1. Location. Ground receiver checkpoints will be established in accordance with FAA Order 6790.4A and will be on the airfield or heliport ramp or taxiways (preferably the runup area) at points selected for easy access by aircraft, but where other airfield or heliport traffic will not be unduly obstructed.

Ground checkpoints normally will not be established at distances less than one-half mile from the facility nor should they be established on non-paved areas.

8-2. Markings. Painting of surface markings will be as described in figure 8-1 below.

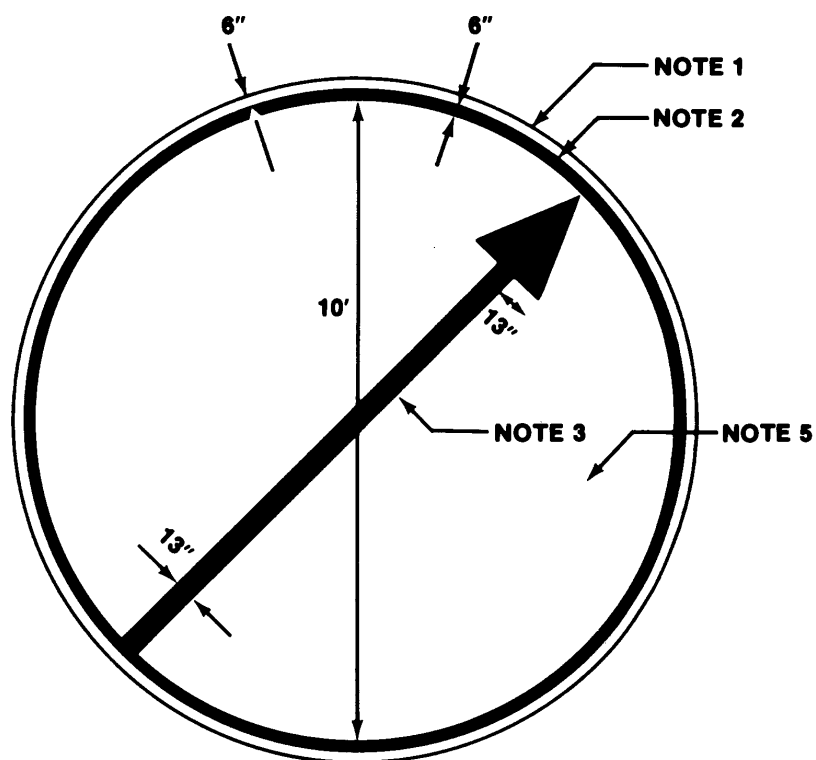

NOTES:

- 1. PAINT WHITE.**
- 2. PAINT YELLOW (CHROME YELLOW TAXIWAY AVIATION YELLOW).**
- 3. PAINT YELLOW ARROW TO BE ALIGNED IN THE DIRECTION IN WHICH IT IS PREFERABLE FOR AIRCRAFT TO OCCUPY THE CIRCLE.**
- 4. CIRCLE MAY BE BORDERED ON INSIDE AND OUTSIDE WITH 6" BLACK BAND IF NECESSARY FOR CONTRAST.**
- 5. PAINT INTERIOR OF CIRCLE BLACK — CONCRETE SURFACES ONLY.**

Figure 8-1. Ground receiver checkpoint markings.

The proponent agency of this publication is the Office of the Chief of Engineers, United States Army. Users are invited to send comments and suggested improvements on DA Form 2028 (Recommended Changes to Publications and Blank Forms) direct to HQDA (DAEN-ECE-G), WASH DC 20314-1000.

By Order of the Secretary of the Army:

Official:

Carl E. Vuono
General, United States Army
Chief of Staff

R. L. DILWORTH
Brigadier General, United States Army
The Adjutant General

DISTRIBUTION:

To be distributed in accordance with DA Form 12-34B, requirements for Airfield Pavements.

* U.S. GOVERNMENT PRINTING OFFICE : 1993 O - 342-421 (80004)

RECOMMENDED CHANGES TO EQUIPMENT TECHNICAL PUBLICATIONS



THEN... JOT DOWN THE DOPE ABOUT IT ON THIS FORM, CAREFULLY TEAR IT OUT, FOLD IT AND DROP IT IN THE MAIL!

SOMETHING WRONG WITH THIS PUBLICATION?

FROM: (PRINT YOUR UNIT'S COMPLETE ADDRESS)

DATE SENT

PUBLICATION NUMBER

PUBLICATION DATE

PUBLICATION TITLE

BE EXACT... PIN-POINT WHERE IT IS

PAGE NO.

PARA-GRAPH

FIGURE NO.

TABLE NO.

IN THIS SPACE TELL WHAT IS WRONG AND WHAT SHOULD BE DONE ABOUT IT:

TEAR ALONG PERFORATED LINE

PRINTED NAME, GRADE OR TITLE, AND TELEPHONE NUMBER

SIGN HERE:

DA FORM 2028-2
JUL 79

PREVIOUS EDITIONS ARE OBSOLETE.

P.S.—IF YOUR OUTFIT WANTS TO KNOW ABOUT YOUR RECOMMENDATION MAKE A CARBON COPY OF THIS AND GIVE IT TO YOUR HEADQUARTERS.

