

ARMY, MARINE CORPS, NAVY, AIR FORCE



MULTISERVICE TACTICS, TECHNIQUES, AND PROCEDURES FOR CHEMICAL, BIOLOGICAL, RADIOLOGICAL, AND NUCLEAR CONTAMINATION AVOIDANCE

**FM 3-11.3
MCWP 3-37.2A
NTTP 3-11.25
AFTTP(I) 3-2.56**

FEBRUARY 2006

DISTRIBUTION RESTRICTION:
Approved for public release; distribution is unlimited.

MULTISERVICE TACTICS, TECHNIQUES, AND PROCEDURES

FOREWORD

This publication has been prepared under our direction for use by our respective commands and other commands as appropriate.



STANLEY H. LILLIE
Brigadier General, USA
Commandant
US Army Chemical School

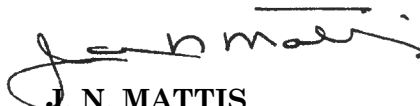

J. N. MATTIS
Lieutenant General, USMC
Deputy Commandant for
Combat Development



JOHN M. KELLY
Rear Admiral, USN
Commander
Navy Warfare Development Command



BENTLEY B. RAYBURN
Major General, USAF
Commander
Headquarters Air Force Doctrine Center

This publication is available at Army Knowledge Online <www.us.army.mil>
and General Dennis J. Reimer Training and Doctrine Digital Library at
<www.train.army.mil>.

PREFACE

1. Scope

This multiservice operations publication provides tactics, techniques, and procedures (TTP) for conducting chemical, biological, radiological, and nuclear (CBRN) avoidance. This document presents comprehensive TTP for passive and active avoidance measures. Users of this manual will be CBRN staff officers, CBRN noncommissioned officers (NCOs), non-CBRN personnel performing collateral duties as an additional duty CBRN officer or NCO, commanders and staff at the tactical through strategic levels, and civilian agencies.

2. Purpose

The purpose of this publication is to provide commanders, staffs, key agencies, and service members with a key reference for planning and conducting CBRN avoidance. It provides the tools for CBRN defense personnel to implement active and passive CBRN avoidance measures and supports the decision-making process. It also serves as a key source document for refining existing training support packages, training center exercises, and service school curricula.

3. Application

This publication is designed for use at the operational and tactical levels but has implications at the strategic level in the implementation of Standardization Agreement (STANAG) 2103. It will support command staff planning in preparing for and conducting CBRN avoidance operations. It also provides guidance to unit leaders and personnel for implementing CBRN avoidance TTP.

4. Implementation Plan

Participating service command offices of primary responsibility (OPRs) will review this publication, validate the information, and reference and incorporate it into service and command manuals, regulations, and curricula as follows:

Army. The United States Army (USA) will incorporate the procedures in this publication in USA training and doctrinal publications as directed by the commander, United States Army Training and Doctrine Command (TRADOC). Distribution is according to Department of the Army (DA) Form 12-99-R (*Initial Distribution Requirements for Publications*).

Marine Corps. The United States Marine Corps (USMC) will incorporate the procedures in this publication in training and doctrinal publications as directed by the Commanding General (CG), United States (US) Marine Corps Combat Development Command (MCCDC). Distribution is according to the USMC publications distribution system.

Navy. The United States Navy (USN) will incorporate the procedures in this publication in training and doctrinal publications as directed by the Commander, Navy Warfare Development Command (NWDC).

Air Force. The United States Air Force (USAF) will validate and incorporate appropriate procedures according to applicable governing directives. It will develop and implement this and other nuclear, biological, and chemical (NBC) multiservice tactics,

techniques, and procedures (MTTP) publications through a series of USAF manuals providing service-specific TTP. Distribution is according to the USAF publication distribution system.

5. User Information

a. The United States Army Chemical School (USACMLS) developed this publication with the joint participation of the approving service commands.

b. We encourage recommended changes for improving this publication. Please reference the specific page and paragraph, and provide a rationale for each recommendation. Send comments and recommendations directly to—

Army

Commandant
US Army Chemical School
ATTN: ATSN-TD
464 MANSCEN Loop, Suite 2617
Fort Leonard Wood, MO 65473-8926
COMM (573) 596-0131, extension 3-7364
Web Site: <https://www.us.army.mil/>

Marine Corps

Commanding General
US Marine Corps Combat Development Command
ATTN: C42 (Director)
3300 Russell Road
Quantico, VA 22134-5001
DSN 278-6234; COMM (703) 784-6234
Web Site: <https://www.doctrine.usmc.mil/>

Navy

Commander
Navy Warfare Development Command
ATTN: N5
686 Cushing Road
Newport, RI 02841-1207
DSN 948-4201; COMM (401) 841-4201
Web Site: <https://www.nko.navy.mil/>

Air Force

Headquarters Air Force Doctrine Center
ATTN: DJ
155 North Twining Street
Maxwell AFB, AL 36112-6112
DSN 493-7442; COMM (334) 953-7442
Web Site: <https://www.doctrine.af.mil/>

Unless this publication states otherwise, masculine nouns and pronouns do not refer exclusively to men.

This publication implements STANAG 2103, *Reporting Nuclear Detonations, Biological and Chemical Attacks, and Predicting and Warning of Associated Hazards and Hazards Areas-Allied Tactical Publication (ATP)45(B)*, Edition 8, 1 July 2001.

*FM 3-11.3
 MCWP 3-37.2A
 NTTP 3-11.25
 AFTTP(I) 3-2.56

| | |
|------------------------|---|
| FM 3-11.3 | US Army Training and Doctrine Command Fort Monroe, Virginia |
| MCWP 3-37.2A | Marine Corps Combat Development Command Quantico, Virginia |
| NTTP 3-11.25 | Navy Warfare Development Command Newport, Rhode Island |
| AFTTP(I) 3-2.56 | Headquarters Air Force Doctrine Center Maxwell Air Force Base, Alabama |

2 February 2006

Multiservice Tactics, Techniques, and Procedures for Chemical, Biological, Radiological, and Nuclear Contamination Avoidance

TABLE OF CONTENTS

| | Page |
|---|-----------|
| EXECUTIVE SUMMARY | xx |
| CHAPTER I INTRODUCTION | |
| Background | I-1 |
| Sense, Shape, Shield, and Sustain | I-1 |
| Sense | I-1 |
| Shape..... | I-1 |
| Shield | I-2 |
| Sustain | I-2 |
| Fundamentals and Principles | I-2 |
| Fundamentals of CBRN Defense..... | I-2 |
| Contamination Avoidance..... | I-3 |
| Tenets of Contamination Avoidance | I-4 |
| Fixed and Mobile Operations..... | I-4 |
| Knowledge of Hazards | I-4 |
| Principles of Avoidance | I-4 |

DISTRIBUTION RESTRICTION: Approved for public release; distribution is unlimited.

*This manual supersedes FM 3-3/FMFM 11-17, 16 November 1992, and FM 3-3-1/FMFM 11-18, 9 September 1994.

| | | |
|--------------------|---|-------|
| | Vulnerability Reduction..... | I-5 |
| | Active Measures | I-5 |
| | Passive Measures | I-6 |
| | Chemical, Biological, Radiological, and Nuclear Battle | |
| | Management..... | I-7 |
| | CBRNWRS..... | I-7 |
| | CBRN IM | I-7 |
| | Commander and Staff Interactions in Meeting Chemical, | |
| | Biological, Radiological, and Nuclear Defense Challenges | I-9 |
| | Chemical, Biological, Radiological and Nuclear Operations | I-10 |
| | CBRN Defense Planning and Considerations | I-10 |
| | Chemical Defense Planning and Considerations | I-11 |
| | Biological Defense Planning and Considerations | I-12 |
| | Nuclear and Radiological Defense Planning and | |
| | Considerations..... | I-13 |
| | Radiological Weapons Defense Planning and | |
| | Considerations..... | I-13 |
| | ROTA and TIM Defense Planning and Considerations ... | I-14 |
| CHAPTER II | DEVELOPING THE CHEMICAL, BIOLOGICAL, RADIOLOGICAL, | |
| | AND NUCLEAR COMMON OPERATIONAL PICTURE | |
| | Background..... | II-1 |
| | Chemical, Biological, Radiological, and Nuclear Common | |
| | Operational Picture Functions | II-1 |
| | Detection | II-1 |
| | Identification | II-1 |
| | Contamination Marking | II-1 |
| | Warning and Reporting..... | II-1 |
| | Chemical, Biological, Radiological, and Nuclear Information | |
| | Management..... | II-2 |
| | CBRN Processes | II-2 |
| | CBRN IM Activities | II-3 |
| | CBRN IM Capabilities | II-3 |
| | Chemical, Biological, Radiological, and Nuclear Information | |
| | Flow Strategy | II-4 |
| | Common Operational Picture Management | II-6 |
| | Information Inputs..... | II-6 |
| | Standardization..... | II-6 |
| | CBRN Information Network Applications | II-8 |
| CHAPTER III | CHEMICAL, BIOLOGICAL, RADIOLOGICAL, AND NUCLEAR | |
| | WARNING AND REPORTING SYSTEM | |
| | Background..... | III-1 |
| | Organization..... | III-1 |
| | CBRN Warning and Reporting Areas | III-1 |
| | CBRN Warning and Reporting Centers and Cells | III-1 |
| | Information Management..... | III-1 |
| | Gathering Information..... | III-2 |
| | Evaluating Information | III-3 |

| | | |
|-------------------|--|------------|
| | Transmitting Information..... | III-3 |
| | Types of Reports..... | III-4 |
| | Standard CBRN Reports..... | III-4 |
| | The Merchant Warning System (MERWARN)..... | III-6 |
| | Strike Warning (STRIKWARN) | III-7 |
| | MET and Weather Reports | III-7 |
| | Mandatory Entries in Nuclear, Biological, and Chemical Reports | III-7 |
| | Classification and Precedence | III-15 |
| | Classification | III-15 |
| | Precedence | III-15 |
| | Decision Support Tools | III-15 |
| | Technical Reach-Back Capabilities..... | III-16 |
| | General..... | III-16 |
| | Technical Reach-Back Capabilities | III-16 |
| | Avoidance Tools..... | III-19 |
| APPENDIX A | SAMPLE CHEMICAL, BIOLOGICAL, RADIOLOGICAL, AND NUCLEAR CONTAMINATION AVOIDANCE CHECKLISTS | A-1 |
| | Background..... | A-1 |
| | Chemical, Biological, Radiological, and Nuclear Preattack Checklist..... | A-1 |
| | Chemical, Biological, Radiological, and Nuclear During-Attack Checklist..... | A-3 |
| | Chemical, Biological, Radiological, and Nuclear Postattack Checklist..... | A-4 |
| | Chemical, Biological, Radiological, and Nuclear Recovery Checklist..... | A-5 |
| APPENDIX B | CHEMICAL, BIOLOGICAL, RADIOLOGICAL, AND NUCLEAR CENTER AND CELL OPERATIONS | B-1 |
| | Background..... | B-1 |
| | Responsibilities | B-1 |
| | Theater, Corps, Air Force, and Fleet Levels of Command | B-1 |
| | Area and Maritime HQ | B-2 |
| | Fixed-Site, Division, Regiment, Brigade, and Designated Shipboard and Wing Levels of Command .. | B-2 |
| | Unit Level of Command and Designated Observers | B-3 |
| | Coordination | B-4 |
| | Responsibilities..... | B-4 |
| | Overlap and Duplication..... | B-6 |
| | Correlation of Nuclear, Biological, and Chemical Reports | B-6 |

| | | |
|-------------------|---|-------------|
| APPENDIX C | MANAGEMENT OF EXPOSURE TO RADIOLOGICAL HAZARDS | C-1 |
| | Background..... | C-1 |
| | Exposure Control..... | C-1 |
| | Data Recording..... | C-1 |
| | Rotation of Assets..... | C-1 |
| | Information Management—Operational Exposure Guide..... | C-2 |
| | Nuclear and Radiological Exposure Control..... | C-2 |
| | Radiation Exposure Control..... | C-2 |
| | Low-Level Radiation (LLR)..... | C-3 |
| | Medical Effects of LLR..... | C-4 |
| | Command Radiation Exposure Guidance..... | C-4 |
| | Personnel Evacuation From a Radiological Area..... | C-5 |
| | RDD..... | C-5 |
| | Radiological Exposure..... | C-5 |
| | Radiation Exposure During War..... | C-5 |
| | RES..... | C-7 |
| | Nuclear Risk Criteria..... | C-8 |
| | Radiation Exposure During Military Support to Civil Authorities..... | C-13 |
| | Radioactive Materials of Military Significance..... | C-14 |
| | Americium..... | C-14 |
| | Cesium..... | C-14 |
| | Cobalt..... | C-15 |
| | DU..... | C-15 |
| | Iodine..... | C-15 |
| | Nickel-63..... | C-16 |
| | Phosphorus..... | C-16 |
| | Plutonium..... | C-16 |
| | Radium..... | C-16 |
| | Strontium..... | C-17 |
| | Thorium-232..... | C-17 |
| | Tritium..... | C-17 |
| | Uranium..... | C-17 |
| APPENDIX D | WEATHER EFFECTS ON NUCLEAR, BIOLOGICAL, AND CHEMICAL AGENTS AND METEOROLOGICAL REPORTS | D-1 |
| | Background..... | D-1 |
| | MET Operations..... | D-1 |
| | USN..... | D-1 |
| | Weather Effects on Chemical, Biological, Radiological, and Nuclear Agents..... | D-1 |
| | Nuclear..... | D-1 |
| | Biological..... | D-3 |
| | Chemical..... | D-5 |
| | Overview of Meteorological Reports..... | D-8 |
| | BWR..... | D-8 |
| | EDR..... | D-8 |

| | | |
|-------------------|---|------------|
| | CDR..... | D-9 |
| | MET Report Fields..... | D-9 |
| | Common Report (ADP) Field Explanations..... | D-10 |
| | MET Report (ADP) Field Explanations..... | D-15 |
| Basic | Wind Reports (Details and Examples)..... | D-21 |
| | BWRs..... | D-21 |
| | Wind Vector Plot..... | D-21 |
| | Effective Downwind Reports (Details and Examples)..... | D-27 |
| | Chemical Downwind Reports (Details and Example)..... | D-31 |
| | General Preparation..... | D-31 |
| | CDM Preparations Without Weather Service Support ... | D-32 |
| | Naval CDM..... | D-34 |
| APPENDIX E | CHEMICAL-CONTAMINATION AVOIDANCE TACTICS, TECHNIQUES, AND PROCEDURES | E-1 |
| | Background..... | E-1 |
| | Chemical-Contamination Avoidance Procedures..... | E-1 |
| | Before the Attack..... | E-1 |
| | During the Attack..... | E-2 |
| | After the Attack..... | E-2 |
| | NBC1 CHEM Report..... | E-3 |
| | Precedence..... | E-3 |
| | Report Preparation..... | E-3 |
| | Sample..... | E-3 |
| | NBC2 CHEM Report..... | E-4 |
| | NBC3 CHEM Report..... | E-5 |
| | Chemical Contamination Prediction and Plotting..... | E-6 |
| | Definitions Used in Chemical Hazard Predictions..... | E-6 |
| | Types of Chemical Attacks..... | E-6 |
| | Means of Delivery..... | E-6 |
| | Prediction of the Downwind Hazard..... | E-6 |
| | Attack Chronology..... | E-8 |
| | Principles of Chemical Predictions and Limitations..... | E-8 |
| | Simplified Hazard Prediction (Land)..... | E-9 |
| | Detailed Type A Attack Downwind Hazard Prediction (Land)..... | E-11 |
| | Detailed Type B Attack Downwind Hazard Prediction (Land)..... | E-15 |
| | Type C Attack Downwind Hazard Prediction (Land)..... | E-26 |
| | Adjusted Hazard Prediction (Land)..... | E-27 |
| | MERWARN..... | E-39 |
| | MERWARN Plotting..... | E-40 |
| | Simplified Procedure Requirements (Sea)..... | E-41 |
| | Detailed Procedure Requirements (Sea)..... | E-44 |
| | Determination of the Downwind Hazard Area..... | E-46 |
| | Change in MET Conditions..... | E-49 |
| | NBC4 CHEM Report..... | E-52 |
| | NBC5 CHEM Report..... | E-53 |
| | NBC6 CHEM Report..... | E-53 |

| | | |
|-------------------|---|------------|
| APPENDIX F | BIOLOGICAL-CONTAMINATION AVOIDANCE TACTICS, TECHNIQUES, AND PROCEDURES | F-1 |
| | Background..... | F-1 |
| | Biological-Agent Dissemination Methods..... | F-1 |
| | Aerosol Dissemination | F-1 |
| | Vector Dissemination..... | F-2 |
| | Covert Dissemination..... | F-2 |
| | Avoidance Procedures | F-3 |
| | Aerosol Avoidance Procedures..... | F-3 |
| | Vector Avoidance Procedures | F-4 |
| | Covert Avoidance Procedures | F-5 |
| | Biological-Contamination Reporting, Predicting, and Plotting.... | F-6 |
| | NBC1 BIO Report | F-6 |
| | Precedence | F-6 |
| | Preparation..... | F-6 |
| | Sample | F-6 |
| | NBC2 BIO Report | F-7 |
| | NBC3 BIO Report | F-8 |
| | Definitions | F-9 |
| | Types of Biological Attacks..... | F-10 |
| | Hazard Prediction | F-12 |
| | Downwind Travel Distances | F-12 |
| | Determining Initial Hazard Areas | F-14 |
| | Prediction of the Initial Hazard..... | F-15 |
| | Adjusted Hazard Prediction..... | F-23 |
| | Hazards Spanning Multiple CDM Messages..... | F-25 |
| | Termination of Biological Hazard Assessment..... | F-25 |
| | Hazard Duration | F-26 |
| | NBC4 BIO Report | F-26 |
| | NBC5 BIO Report | F-27 |
| | NBC6 BIO Report | F-28 |
| APPENDIX G | NUCLEAR-CONTAMINATION AVOIDANCE TACTICS, TECHNIQUES, AND PROCEDURES | G-1 |
| | Background..... | G-1 |
| | Nuclear-Contamination Avoidance Procedures..... | G-2 |
| | Preattack..... | G-2 |
| | During Attack | G-3 |
| | Postattack | G-4 |
| | Nuclear Information Management..... | G-5 |
| | Collection of Nuclear Information | G-6 |
| | Monitoring, Survey, and Reconnaissance Data | G-6 |
| | Evaluation of Nuclear Information | G-6 |
| | Transmission of Nuclear Information | G-6 |
| | Designated Observer System..... | G-6 |
| | Nondesignated Observers | G-8 |
| | Determination That a Nuclear Attack has Occurred | G-8 |
| | NBC1 NUC Report..... | G-9 |

| | |
|--|------|
| Introduction | G-9 |
| Observer Position | G-10 |
| DTG of the Attack | G-10 |
| Attack Location or GZ | G-11 |
| Type of Burst | G-11 |
| Flash-to-Bang Time | G-11 |
| Angular Cloud Width | G-11 |
| Cloud Top or Cloud Bottom Height | G-12 |
| Stabilized Cloud Top Angle | G-12 |
| Stabilized Cloud Bottom Angle | G-13 |
| NBC2 NUC Report | G-13 |
| Introduction | G-13 |
| Strike Serial Number | G-13 |
| Location of GZ (Line FOXTROT) | G-14 |
| Methods of Determining the Yield (Line NOVEMBER) | G-16 |
| NBC3 NUC Calculation Procedures | G-22 |
| Fallout Prediction | G-22 |
| Fallout Area Zones | G-23 |
| Significance of the Fallout Ashore Versus at Sea | G-23 |
| Multiple-Burst Fallout | G-24 |
| Simplified Fallout Prediction | G-24 |
| Ship Fallout Template | G-33 |
| Detailed Fallout Prediction | G-38 |
| NBC3 NUC Report | G-46 |
| General | G-46 |
| Plotting Detailed Fallout Predictions (NBC3 NUC) | G-47 |
| Contamination Prediction System for Merchant Ships at Sea | G-50 |
| Time of Completion of Fallout | G-53 |
| NBC4 NUC Report | G-53 |
| Locating and Reporting Nuclear Contamination | G-53 |
| Message Precedence | G-54 |
| Shielding | G-55 |
| Measuring Nuclear Data | G-56 |
| Surveys | G-58 |
| Reporting Instructions | G-58 |
| Evaluation of Nuclear Information | G-60 |
| Calculation of H hour or Time of Burst (TOB) | G-60 |
| Fallout Determination of Decay | G-60 |
| Determination of the Decay Rate | G-61 |
| Period of Validity for the Decay Rate (n) | G-62 |
| Normalizing Factor (NF) | G-63 |
| Outside Correlation Factor (OCF) | G-64 |
| NBC5 NUC Report | G-64 |
| Purpose | G-64 |
| Message Precedence | G-65 |
| Plotting Data and Producing an NBC5 NUC Report | G-65 |
| Reporting Data | G-68 |
| Determining the Dose Rate for an Arbitrary Time | G-69 |

| | | |
|-------------------|---|------------|
| | Determining the Time That Given Dose Rate is | |
| | Expected..... | G-72 |
| | Total Dose Reduction | G-72 |
| | Total Dose Procedures..... | G-73 |
| | Crossing a Fallout Area | G-76 |
| | Optimum Time of Exit from Fallout Areas..... | G-76 |
| | Neutron-Induced Radiation Areas | G-79 |
| | NBC6 NUC Report..... | G-88 |
| | Purpose | G-88 |
| | Message Precedence..... | G-88 |
| APPENDIX H | RELEASE-OTHER-THAN-ATTACK CONTAMINATION | |
| | AVOIDANCE TACTICS, TECHNIQUES, AND PROCEDURES..... | H-1 |
| | Background..... | H-1 |
| | General..... | H-1 |
| | Characteristics | H-1 |
| | Release-Other-Than-Attack Contamination Avoidance | |
| | Procedures | H-2 |
| | Preattack..... | H-2 |
| | During Attack..... | H-2 |
| | Postattack | H-3 |
| | Release-Other-Than-Attack Information Management..... | H-4 |
| | Collecting ROTA Information..... | H-4 |
| | Consolidating ROTA Data | H-4 |
| | Evaluating ROTA Information..... | H-5 |
| | Transmitting ROTA Information | H-5 |
| | NBC1 ROTA Report..... | H-5 |
| | Purpose | H-5 |
| | Precedence | H-5 |
| | Information Included | H-5 |
| | Preparation..... | H-5 |
| | NBC2 ROTA Report..... | H-6 |
| | Purpose | H-6 |
| | Precedence | H-6 |
| | Preparation..... | H-6 |
| | Subsequent Data | H-6 |
| | NBC3 ROTA Report..... | H-7 |
| | Purpose | H-7 |
| | Precedence | H-7 |
| | Preparation..... | H-7 |
| | Types of Releases..... | H-8 |
| | Procedures and Constraints | H-9 |
| | ROTA Types and Cases..... | H-10 |
| | Hazard Prediction Methods | H-11 |
| | NBC4 ROTA Report..... | H-17 |
| | Purpose | H-17 |
| | Precedence | H-17 |
| | Preparation..... | H-18 |
| | NBC5 ROTA Report..... | H-18 |

| | | |
|-------------------|---|---------------------|
| | Purpose | H-18 |
| | Precedence | H-18 |
| | Preparation | H-19 |
| | Reporting Data | H-20 |
| | NBC6 ROTA Report | H-20 |
| | Purpose | H-21 |
| | Precedence | H-21 |
| | Preparation | H-21 |
| | Submission | H-21 |
| APPENDIX I | STRIKE WARNING | I-1 |
| | Background | I-1 |
| | Friendly Nuclear-Attack Warning | I-1 |
| | Nuclear STRIKWARN | I-1 |
| | Responsibilities | I-1 |
| | Recipients | I-1 |
| | Warnings | I-1 |
| | NBC3 Reports | I-2 |
| | Units of Measurement | I-2 |
| | Line Items Used in STRIKWARN Messages | I-2 |
| | Zones of Warning and Protection Requirements | I-3 |
| | Plotting a STRIKWARN Message | I-4 |
| | Single Burst | I-4 |
| | Multiple Bursts | I-4 |
| APPENDIX J | NOMOGRAMS, TABLES, AND GRAPHS | J-1 |
| APPENDIX K | CALCULATIONS | K-1 |
| APPENDIX L | REPRODUCIBLE EXAMPLE FORMS | L-1 |
| REFERENCES | | References-1 |
| GLOSSARY | | Glossary-1 |
| INDEX | | Index-1 |
| FIGURES | | |
| I-1 | CBRN Operational Elements | I-2 |
| I-2 | Fundamentals of CBRN Defense | I-3 |
| I-3 | Excerpt From Joint Vision 2020 | I-7 |
| I-4 | CBRN IM | I-8 |
| II-1 | IM Cycle | II-2 |
| III-1 | Flow of NBC Reports | III-4 |
| C-1 | LLR Decision Making | C-3 |
| D-1 | Example Wind Vector Plot | D-26 |
| D-2 | EDM Work Sheet | D-28 |
| D-3 | Wind Vector Plot with Cloud and Stem Radial Lines (2 KT) | D-29 |
| D-4 | Naval Air Stability | D-35 |

| | | |
|-------------|---|-------------|
| E-1 | Sample NBC1 CHEM Report | E-4 |
| E-2 | Sample NBC2 CHEM Report | E-5 |
| E-3 | Sample NBC3 CHEM Report | E-5 |
| E-4 | Simplified Type A Chemical Predictor..... | E-10 |
| E-5 | Hazard Area From Type A Attack, Case 1 (Wind Speed ≤10 kph) | E-12 |
| E-6 | Hazard Area From Type A Attack, Case 2 (Wind Speed >10 kph) | E-14 |
| E-7 | Hazard Area From Type B Attack, Case 1 (Wind Speed ≤10 kph) | E-17 |
| E-8 | Hazard Area From Type B Attack, Case 2 (Radius of Attack Area ≤1 km, Wind Speed >10 kph)..... | E-18 |
| E-9 | Hazard Area From Type B Attack, Case 3 Attack Area (Radius >1 km but ≤2 km, Wind Speed <10 kph)..... | E-20 |
| E-10 | Hazard Area From Type B Attack, Case 4 Attack Area (Radius >1 km but ≤2 km, Wind Speed >10 kph)..... | E-21 |
| E-11 | Hazard Area From Type B, Case 5 (Any Dimension of Attack Area >2 km, Wind Speed ≤10 kph)..... | E-23 |
| E-12 | Hazard Area From Type B Attack, Case 6 (Any Dimension of Attack Area >2 km, Wind Speed >10 kph) | E-24 |
| E-13 | Type C Attack..... | E-26 |
| E-14 | Recalculation of Downwind Hazard Area Type A Attack (Change in Wind Speed From ≤10 kph to >10 kph) | E-29 |
| E-15 | Recalculation of Downwind Hazard Area Type A Attack (Change in Wind Speed From >10 kph to ≤10 kph) (Example 1)..... | E-31 |
| E-16 | Recalculation of Downwind Hazard Area Type A Attack (Change in Wind Speed From >10 kph to ≤10 kph) (Example 2)..... | E-32 |
| E-17 | Recalculation of Downwind Hazard Area Type A Attack (Change In Wind Speed From >10 kph to ≤10 kph) (Example 3)..... | E-33 |
| E-18 | Recalculation of Downwind Hazard Area Type A, Case 2 Attack (Change in Downwind Direction by ≥30°) | E-34 |
| E-19 | Recalculation of Downwind Hazard Area Type A, Case 2 Attack (Change in Stability Category and/or Downwind Speed)..... | E-35 |
| E-20 | Recalculation of Downwind Hazard Area Type B, Case 6 Attack (Change in Downwind Direction) | E-38 |
| E-21 | Air Stability Category (Sea) | E-41 |
| E-22 | Ship Chemical Template (Example) | E-44 |

| | | |
|-------------|--|-------------|
| E-23 | Sample CDM and CPDS | E-45 |
| E-24 | Chemical Downwind Hazard Area Plot | E-47 |
| E-25 | Downwind Hazard Area, Type A Attack, Wind Speed ≥10 Knots | E-48 |
| E-26 | Downwind Hazard Area, Type A Attack, Wind Speed ≤5 Knots or Variable | E-49 |
| E-27 | Recalculation of Downwind Hazard Area, Type A Attack After Change in Downwind Direction at Point B..... | E-51 |
| E-28 | Sample NBC4 CHEM Report | E-52 |
| E-29 | Sample NBC5 CHEM Report | E-53 |
| E-30 | Sample NBC6 CHEM Report | E-54 |
| F-1 | Sample NBC1 BIO Report..... | F-7 |
| F-2 | Sample NBC2 BIO Report..... | F-8 |
| F-3 | Sample NBC3 BIO Report..... | F-9 |
| F-4 | Type P, Case 1, Attack..... | F-15 |
| F-5 | Type P, Case 2, Attack..... | F-16 |
| F-6 | Type Q, Case 1, Attack | F-17 |
| F-7 | Type Q, Case 2, Attack | F-18 |
| F-8 | Type R, Case 1, Attack..... | F-20 |
| F-9 | Type R, Case 2, Attack..... | F-21 |
| F-10 | Type S, Cases 1 and 2, Attacks | F-22 |
| F-11 | Type Q, Case 2, Attack With Constant Wind Speed | F-23 |
| F-12 | Type Q, Case 2, Attack, (1 Hour Into CDR, Changing Downwind Direction) | F-24 |
| F-13 | Sample NBC4 BIO Report..... | F-27 |
| F-14 | Sample NBC5 BIO Report..... | F-28 |
| G-1 | Unit Organic Optical Equipment Ideal for Sighting Measurements..... | G-7 |
| G-2 | Growth of a Nuclear Cloud..... | G-9 |
| G-3 | Sample NBC1 NUC Report | G-10 |
| G-4 | Angular Cloud Width..... | G-12 |
| G-5 | Stabilized Cloud Top and Cloud Bottom Angle and Height Measurements..... | G-12 |
| G-6 | NBC2 NUC Report..... | G-14 |
| G-7 | Polar Plot Method | G-16 |
| G-8 | Yield Estimation, Cloud Width and Flash-to-Bang Time/ Distance to GZ (Example) | G-17 |
| G-9 | Stabilized Cloud and Stem Parameters—Cloud Top/ Bottom Height (Example) | G-18 |
| G-10 | Yield Estimation, Angle to Top/Bottom of Cloud and Flash-to-Bang Time/Distance to GZ (Example)..... | G-20 |

| | | |
|-------------|--|-------------|
| G-11 | M4A1 Nuclear Yield Calculator | G-21 |
| G-12 | Multiple-Burst Detailed Fallout Prediction (Example) | G-25 |
| G-13 | Simplified Fallout Template With Fallout Prediction | G-26 |
| G-14 | Simplified Fallout Template, M5A2 (Example)..... | G-27 |
| G-15 | EDM Work Sheet | G-29 |
| G-16 | Determination of Zone I, Downwind Distance (Example)..... | G-32 |
| G-17 | Ship Fallout Template (Example)..... | G-34 |
| G-18 | Ship Fallout Template | G-35 |
| G-19 | Wind Vector Plot with Cloud and Stem Radial Lines (50 KT) (Example)..... | G-37 |
| G-20 | Detailed Fallout Prediction Work Sheet (Example)..... | G-39 |
| G-21 | Stabilized Cloud and Stem Parameters for Detailed Fallout Prediction (Example)..... | G-40 |
| G-22 | Determination of Zone I, Downwind Distance (Example)..... | G-42 |
| G-23 | FY/TY Adjustment Factor (Example) | G-43 |
| G-24 | HOB (Kiloton) Adjustment Factor (Example) | G-44 |
| G-25 | HOB (Megaton) Adjustment Factor (Example)..... | G-45 |
| G-26 | Sample NBC3 NUC Report | G-47 |
| G-27 | Detailed Fallout Prediction | G-48 |
| G-28 | Example Detailed Fallout Prediction With Wind Speed Less Than 8 kph | G-49 |
| G-29 | Shipboard Fallout Template (Example)..... | G-52 |
| G-30 | Sample NBC4 NUC Report | G-54 |
| G-31 | Sample NBC4 NUC Reports..... | G-58 |
| G-32 | Sample NBC5 NUC Report | G-65 |
| G-33 | Example Fallout Pattern Plotted From Survey Data | G-67 |
| G-34 | Sample NBC5 NUC Contamination Overlay | G-68 |
| G-35 | Determining a Dose Rate at an Arbitrary Time (Example)..... | G-71 |
| G-36 | Total Dose Fallout (n=1.2) (Example)..... | G-75 |
| G-37 | MF (Example)..... | G-78 |
| G-38 | Keller Nomogram for Neutron-Induced Areas From 10-100 Kilotons..... | G-80 |
| G-39 | Keller Nomogram for Neutron-Induced Areas From 0.1 to 10 Kilotons..... | G-81 |
| G-40 | Example of Plotted Neutron Induced Area..... | G-82 |
| G-41 | Total Dose-Induced Radiation (Example)..... | G-86 |
| G-42 | Sample NBC6 NUC Report | G-88 |
| H-1 | Sample NBC1 ROTA Report | H-6 |

| | | |
|-------------|---|-------------|
| H-2 | Sample NBC2 ROTA Report | H-7 |
| H-3 | Sample NBC3 ROTA Report | H-8 |
| H-4 | Sample Decision Flowchart for ROTA Types and Cases | H-12 |
| H-5 | Type T, Case 4: Small Methyl Isocyanate (UN/NA ID #2480) Spill at Night | H-15 |
| H-6 | Type T, Case 5 | H-16 |
| H-7 | Type T, Case 4: GB Rocket Stockpile Fire During the Day | H-17 |
| H-8 | Sample NBC4 ROTA Report | H-18 |
| H-9 | Sample NBC5 ROTA Report | H-19 |
| H-10 | Sample NBC5 ROTA Report Overlay (Without Marginal Data) | H-20 |
| H-11 | Sample NBC6 ROTA Report | H-21 |
| I-1 | STRIKWARN Plot Showing MSD 1 and MSD 2, Single- Burst | I-4 |
| I-2 | STRIKWARN Plot Showing Multiple Bursts | I-5 |
| J-1 | Map Scales | J-10 |
| J-2 | Hairline | J-11 |
| J-3 | Radioactive Cloud and Stem Parameters Nomogram (Stabilized at H+10 Minutes) | J-12 |
| J-4 | Radioactive Cloud and Stem Parameters (Graph) | J-13 |
| J-5 | Safety Distance as a Function of Weapon Yield | J-13 |
| J-6 | Yield Estimation, Angular Cloud Width and Flash-to-Bang Time/Distance to GZ | J-14 |
| J-7 | Yield Estimation, Angle to Top/Bottom of Cloud and Flash-to-Bang Time/Distance to GZ | J-15 |
| J-8 | Determination of Zone I, Downwind Distance | J-16 |
| J-9 | Fallout Decay Nomogram (n=0.2) | J-17 |
| J-10 | Fallout Decay Nomogram (n=0.3) | J-18 |
| J-11 | Fallout Decay Nomogram (n=0.4) | J-19 |
| J-12 | Fallout Decay Nomogram (n=0.5) | J-20 |
| J-13 | Fallout Decay Nomogram (n=0.6) | J-21 |
| J-14 | Fallout Decay Nomogram (n=0.7) | J-22 |
| J-15 | Fallout Decay Nomogram (n=0.8) | J-23 |
| J-16 | Fallout Decay Nomogram (n=0.9) | J-24 |
| J-17 | Fallout Decay Nomogram (n=1.0) | J-25 |
| J-18 | Fallout Decay Nomogram (n=1.1) | J-26 |
| J-19 | Fallout Decay Nomogram (n=1.2) | J-27 |
| J-20 | Fallout Decay Nomogram (n=1.3) | J-28 |
| J-21 | Fallout Decay Nomogram (n=1.4) | J-29 |

| | | |
|-------------|---|-------------|
| J-22 | Fallout Decay Nomogram (n=1.5) | J-30 |
| J-23 | Fallout Decay Nomogram (n=1.6) | J-31 |
| J-24 | Fallout Decay Nomogram (n=1.7) | J-32 |
| J-25 | Fallout Decay Nomogram (n=1.8) | J-33 |
| J-26 | Fallout Decay Nomogram (n=1.9) | J-34 |
| J-27 | Fallout Decay Nomogram (n=2.0) | J-35 |
| J-28 | Total Dose (Fallout) (n=0.2)..... | J-36 |
| J-29 | Total Dose (Fallout) (n=0.3)..... | J-37 |
| J-30 | Total Dose (Fallout) (n=0.4)..... | J-38 |
| J-31 | Total Dose (Fallout) (n=0.5)..... | J-39 |
| J-32 | Total Dose (Fallout) (n=0.6)..... | J-40 |
| J-33 | Total Dose (Fallout) (n=0.7)..... | J-41 |
| J-34 | Total Dose (Fallout) (n=0.8)..... | J-42 |
| J-35 | Total Dose (Fallout) (n=0.9)..... | J-43 |
| J-36 | Total Dose (Fallout) (n=1.0)..... | J-44 |
| J-37 | Total Dose (Fallout) (n=1.1)..... | J-45 |
| J-38 | Total Dose (Fallout) (n=1.2)..... | J-46 |
| J-39 | Total Dose (Fallout) (n=1.3)..... | J-47 |
| J-40 | Total Dose (Fallout) (n=1.4)..... | J-48 |
| J-41 | Total Dose (Fallout) (n=1.5)..... | J-49 |
| J-42 | Total Dose (Fallout) (n=1.6)..... | J-50 |
| J-43 | Total Dose (Fallout) (n=1.7)..... | J-51 |
| J-44 | Total Dose (Fallout) (n=1.8)..... | J-52 |
| J-45 | Total Dose (Fallout) (n=1.9)..... | J-53 |
| J-46 | Total Dose (Fallout) (n=2.0)..... | J-54 |
| J-47 | Graphical Method for Determining Normalization Factor (H+1) | J-55 |
| J-48 | Graphical Method for Determining Normalization Factor (H+48) | J-56 |
| J-49 | Multiplication Factor | J-57 |
| J-50 | Decay of Induced Radiation (Soil Type I) | J-58 |
| J-51 | Decay of Induced Radiation (Soil Type II) | J-59 |
| J-52 | Decay of Induced Radiation (Soil Type III)..... | J-60 |
| J-53 | Decay of Induced Radiation (Soil Type IV)..... | J-61 |
| J-54 | Total Dose (Induced Radiation)..... | J-62 |

TABLES

| | | |
|--------------|--|---------------|
| II-1 | Reports Matrix (Sample) | II-7 |
| II-2 | Shared Message Folders (Sample) | II-9 |
| III-1 | Standard Format and Line Items | III-5 |
| III-2 | Required Information by Line | III-8 |
| III-3 | Types of Agents | III-14 |
| III-4 | Agent Name | III-15 |
| III-5 | Technical Reach-Back Points of Contact | III-16 |
| A-1 | Preattack Checklist for CBRN Attacks (Sample) | A-1 |
| A-2 | During-Attack Checklist for CBRN Attacks (Sample) | A-3 |
| A-3 | Postattack Checklist for CBRN Attacks (Sample) | A-4 |
| A-4 | Recovery Checklist for CBRN Attacks (Sample) | A-5 |
| B-1 | CBRN Cell at Theater, Corps, Air Force, or Fleet Level (Sample) | B-1 |
| C-1 | Projected Radiation Intensities After a Nuclear Attack (cGy per hour) | C-6 |
| C-2 | Effects by Nuclear Weapon Yield in Kilometers From GZ | C-6 |
| C-3 | Radiation Injuries and Effects of Radiation Exposure to Personnel | C-7 |
| C-4 | Nuclear Radiation cGy Exposure Status and Degree of Risk Exposure | C-9 |
| C-5 | Physiological Effects of Radiation | C-10 |
| C-6 | First-Responder Exposure Limits | C-14 |
| C-7 | International System of Units—Conversions | C-18 |
| C-8 | Radiation Type/Quality Factor | C-18 |
| D-1 | Weather Effects on Biological Dissemination | D-4 |
| D-2 | Weather Effects on Aerosol Chemical Agents | D-5 |
| D-3 | Common Message Headings for MET Reports | D-9 |
| D-4 | NBC MET Reports | D-10 |
| D-5 | Map Distance for Wind Speed (Map Scale 1:50,000) | D-22 |
| D-6 | Map Distance for Wind Speed (Map Scale 1:100,000) | D-22 |
| D-7 | Map Distance for Wind Speed (Map Scale 1:250,000) | D-23 |
| D-8 | Map Distance for Wind Speed (Map Scale 1:50,000) | D-23 |
| D-9 | Map Distance for Wind Speed (Map Scale 1:100,000) | D-24 |
| D-10 | Map Distance for Wind Speed (Map Scale 1:250,000) | D-24 |
| D-11 | Weighting Factor Table | D-27 |
| D-12 | Wind Vector Lengths | D-27 |
| D-13 | Air Stability Category Basic Chart | D-33 |
| D-14 | Air Stability Category Adjustment Chart | D-34 |
| E-1 | Types and Cases of Chemical Attacks | E-7 |

| | | |
|-------------|---|-------------|
| E-2 | DHD Versus Wind Speed (kph) and Air Stability, Land | E-10 |
| E-3 | Type A Case 2 Attack Downwind Distance of Hazard Area..... | E-11 |
| E-4 | Type B Attack, Probable Time After Ground Contamination at Which Personnel May Safely Remove Protective Masks | E-16 |
| E-5 | Cases and Types of Attacks | E-27 |
| E-6 | DHD Versus Wind Speed (Knots) and Air Stability (Sea) | E-42 |
| F-1 | Types and Cases of Attacks | F-11 |
| G-1 | Preselected Yield Groups | G-28 |
| G-2 | Half-Thicknesses (X ½) of Certain Materials | G-55 |
| G-3 | TFs/CFs..... | G-57 |
| G-4 | Radii of Neutron-Induced Contamination | G-79 |
| G-5 | Soil Types for Induced Radiation Calculations | G-83 |
| G-6 | TFs for Common Structures | G-83 |
| H-1 | ROTA Types and Cases | H-11 |
| I-1 | Line Items for STRIKWARN Messages..... | I-3 |
| J-1 | Map Distance, in cm, Map Scale 1:50,000, Wind Speed in KM/H | J-1 |
| J-2 | Map Distance, in cm, Map Scale 1:50,000, Wind Speed in Knots | J-1 |
| J-3 | Map Distance, in cm, Map Scale 1:100,000, Wind Speed in KM/H..... | J-2 |
| J-4 | Map Distance, in cm, Map Scale 1:100,000, Wind Speed in Knots..... | J-2 |
| J-5 | Map Distance, in cm, Map Scale 1:250,000, Wind Speed in KM/H..... | J-3 |
| J-6 | Map Distance, in cm, Map Scale 1:250,000, Wind Speed in Knots..... | J-3 |
| J-7 | Conversion Table, Degrees to Mils..... | J-4 |
| J-8 | Conversion Table and Distance Conversion Factors..... | J-5 |
| J-9 | TFs/PFs..... | J-6 |
| J-10 | Normalizing Factors (Correction to H+1 Hour)..... | J-7 |
| J-11 | Determination of Stability Category..... | J-8 |
| J-12 | Stability Category Adjustment..... | J-8 |
| J-13 | Radioactive Cloud and Stem Parameters (Stabilized at H+10 Minutes)..... | J-9 |

EXECUTIVE SUMMARY

Multiservice Tactics, Techniques, and Procedures for Chemical, Biological, Radiological, and Nuclear Contamination Avoidance

Chapter I Introduction

Chapter I introduces new emerging terms and the joint structure of CBRN defense. The terms are outlined in the Joint Requirements Office (JRO) concept for CBRN defense. This chapter also provides information on the overall structure for how CBRN contamination avoidance operations are managed, controlled, and executed. This chapter stresses the importance of preparedness and addresses key education and training considerations for CBRN contamination avoidance.

Chapter II Developing the Chemical, Biological, Radiological, and Nuclear Common Operational Picture

Chapter II provides the functions of the CBRN common operational picture (COP). It also describes CBRN information management (IM) processes, activities, and capabilities. The chapter provides CBRN information flow strategy and COP management procedures.

Chapter III Chemical, Biological, Radiological, and Nuclear Warning and Reporting System

Chapter III provides an overview of the Chemical, Biological, Radiological, and Nuclear Warning and Reporting System (CBRNWRS); organizations; and responsibilities. It also describes how the CBRNWRS provides and integrates IM, decision support tools (DST), and reach-back capabilities.

PROGRAM PARTICIPANTS

The following commands and agencies participated in the development of this publication:

Joint

Joint Requirements Office, 401 MANSCEN Loop, Suite 1309, Fort Leonard Wood, MO 65473

Army

United States Army Chemical School, 464 MANSCEN Loop, Suite 2617, Fort Leonard Wood, MO 65473

United States Army Medical Department Center and School, 1400 E. Grayson Street, Fort Sam Houston, TX 78234

United States Army Edgewood Chemical and Biological Center, Aberdeen Proving Ground, MD 21040

Marine Corps

United States Marine Corps Combat Development Command, 3300 Russell Road, Suite 318A, Quantico, VA 22134-5021

Navy

United States Navy Warfare Development Command, 686 Cushing Road, Sims Hall, Newport, RI 02841

Air Force

HQ Air Force Doctrine Center, ATTN: DJ, 155 North Twining Street, Maxwell AFB, AL 36112-6112

United States Air Force Civil Engineer Support Agency, 139 Barnes Drive, Suite 1, Tyndall AFB, FL 32403

THIS PAGE IS INTENTIONALLY LEFT BLANK.

Chapter I

INTRODUCTION

1. Background

a. The best defense against CBRN weapons is using the fundamental principles of contamination avoidance. Avoid the hazard by deterring or preventing it from being released in the first place; or know exactly where, what, and how much CBRN hazard is present in the area of operations (AO) and do not enter that area unless it is vital to mission success.

b. Successful contamination avoidance prevents disruption to operations and organizations by minimizing unnecessary time in cumbersome protective postures and by minimizing decontamination requirements. Successful avoidance may be achieved by bypassing contamination or calculating the best time to cross contaminated areas using the procedures described in this manual. Avoiding contamination requires the ability to recognize the presence or absence of CBRN hazards in the air; on water, land, personnel, equipment, and facilities; and at short and long ranges.

c. Surveillance and detection capabilities enable forces to recognize CBRN hazards. The fusion of these capabilities with information from other sources yields an overall COP, supporting decisions for specific avoidance, protection, and decontamination actions.

d. These surveillance and detection results also establish requirements for other avoidance measures, such as sounding alarms, marking hazards, and warning forces. To support commanders' decisions on contamination avoidance implementation measures are executed to avoid or limit exposure, such as increasing the use of shelters during CBRN employment windows and providing key information for movement before, during, and after CBRN attacks.

2. Sense, Shape, Shield, and Sustain

CBRN defense has four operational elements that serve as key capability categories. Figure I-1, page I-2, displays the interrelationship between these four operational elements—sense, shape, shield, and sustain. The elements interrelate to varying extents, with shape having the most influence on the other operational elements.

a. **Sense.** Sense is the capability to continually provide updated and accurate information about the CBRN situation at a specific time and place. Contamination avoidance implements this element by detecting, identifying, and quantifying those CBRN hazards in all physical states (solid, liquid, gas) with sensors, arrays, and detectors.

b. **Shape.** Shape provides the ability to characterize the CBRN hazard. The force commander's staff collects and assimilates information from sensors, intelligence, and medical assets in near-real time to provide actual and potential impacts of CBRN hazards. This information allows the commander to develop a clear understanding of the current and predicted CBRN situation.

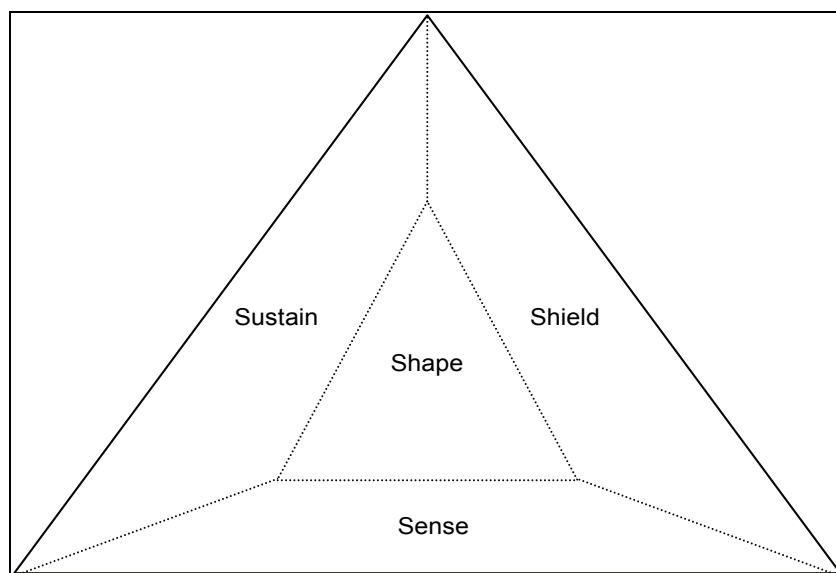

Figure I-1. CBRN Operational Elements

c. **Shield.** Shield provides the capability to shield the force from harm caused by CBRN hazards by preventing or reducing individual and collective exposures, applying prophylaxis to prevent or mitigate negative physiological effects, and protecting critical equipment. Avoidance, mitigation, and active- and passive-defense measures assist the commander with the shield of personnel and equipment.

d. **Sustain.** Sustain is the ability to conduct decontamination and medical actions that enable the quick restoration of combat power, maintain or recover essential functions that are free of the effects of CBRN hazards, and facilitate the return to preincident operational capability as soon as possible.

3. Fundamentals and Principles

The possibility that an adversary will use CBRN weapons against the United States and its allies continues to increase daily. If these weapons are used, our forces must be ready to implement the principles of CBRN defense. The first of these is contamination avoidance, which if successful, may limit the need for individual and collective protective equipment or the need to conduct time- and labor-intensive decontamination activities. In addition to the current arsenals of CBRN weapons systems, almost all areas of the world have various types of factories, research facilities, pharmaceutical production lines, and power plants that contain large quantities of materials which may be hazardous when released into the atmosphere. Experiences with the chemical release at Bhopal, India, and the nuclear contamination release at Chernobyl, Ukraine, demonstrate that toxic industrial material (TIM) can be just as hazardous as military weapons. A release other than attack (ROTA), whether intentional or due to collateral damage, presents a potential challenge for our forces.

a. **Fundamentals of CBRN Defense.** The three fundamentals of CBRN defense are contamination avoidance, protection, and decontamination (see Figure I-2). Executed at all levels and coupled with an effective retaliatory response, these fundamentals will increase the likelihood of a US victory. While avoiding contamination is always desirable, the mission may force individuals and units to occupy or cross a contaminated area. Units can

minimize their performance degradation and limit exposure to contamination by following the principles and procedures outlined in this manual.

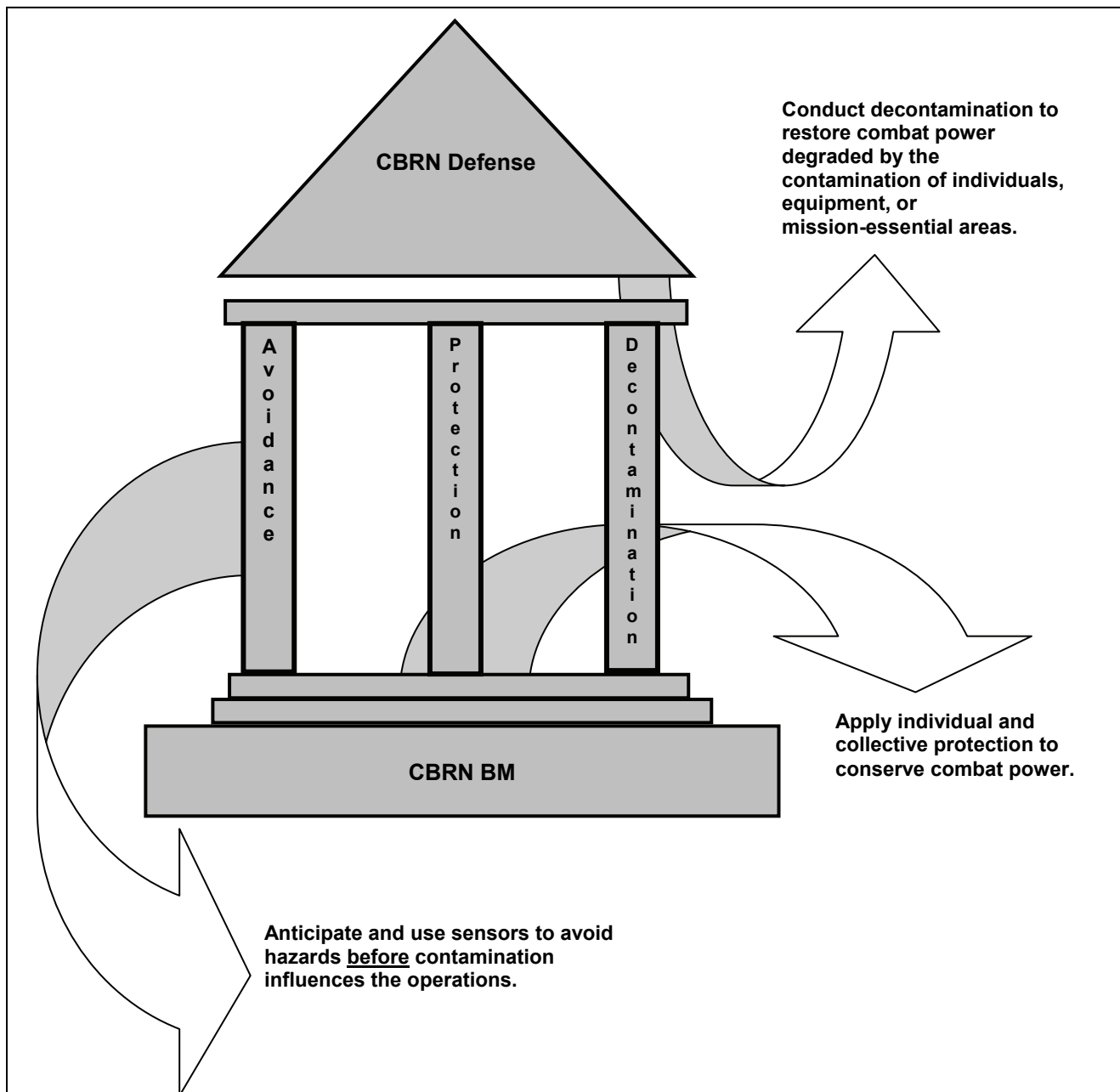

Figure I-2. Fundamentals of CBRN Defense

b. Contamination Avoidance. Contamination avoidance is defined as taking actions to avoid or reduce the effects of a CBRN attack and to minimize the effects of CBRN or TIM contamination hazards. There are active and passive measures that can be taken to avoid contamination. Passive-defense measures include those measures taken to avoid being targeted and hit by a weapons system. These include operational security, camouflage and concealment, hardening positions, and the dispersion of service members and equipment. Contamination avoidance includes the following four CBRN-specific steps:

- (1) Implement passive-defense measures.
- (2) Warn and report CBRN or TIM events.
- (3) Locate, identify, track, and predict CBRN or TIM hazards.
- (4) Limit exposure to CBRN or TIM hazards.

c. **Tenets of Contamination Avoidance.** The doctrinal tenets of contamination avoidance are sound and can be applied to all situations at all levels. The TTP of applying contamination avoidance will vary according to mission, the type of agent encountered, and the environmental conditions. Some TIM are not detected by standard military detectors. For example, the TTP applied to a large, fixed facility, such as an airfield, will differ from those selected for a mobile unit. The following list outlines some of the skills and procedures necessary to implement contamination avoidance:

- (1) Knowledge of potential hazards.
- (2) Intelligence preparation of the battlespace (IPB).
- (3) Vulnerability analysis.
- (4) Situational awareness (SA) (based on the three items listed above and the actual data from the location of the contamination).

d. **Fixed and Mobile Operations.** Units and activities can generally be characterized as fixed or mobile. In a similar manner, contamination within the battlespace is confined to a specific location or is being carried across the terrain by wind. Since the services currently have a very limited capability to perform standoff detection, most detection will occur in close proximity to, or in the midst of, a unit. In many cases, the warning to a unit of a potential hazard will come from another unit that has become contaminated. At higher echelons, specialized units (CBRN reconnaissance, biological detection) provide attack indications through the CBRNWRS. Each unit provides CBRN information commensurate with its detection capability. The fusion of data from many sources provides the commander with SA of CBRN contamination and its potential effect on his scheme of maneuver.

e. **Knowledge of Hazards.** Contamination avoidance begins with the knowledge of hazards that may be encountered. This includes the physical characteristics, field behavior, and employment techniques that may be used. A thorough IPB is also essential to avoidance. Understanding the threat's CBRN capabilities and delivery systems allows the joint force commander (JFC) to employ the assets necessary to protect the force. Because the detectors have technical and practical limitations, they should be integrated and networked throughout the battlespace in order to provide maximum coverage against threats.

f. **Principles of Avoidance.** The principles of avoidance include the elements of detecting, identifying, predicting, warning, reporting, marking, relocating, and rerouting.

(1) **Detecting.** In CBRN environments, detection is the act of locating CBRN hazards by using detectors or monitoring and survey teams. The implications of detection include the following:

(a) **Warning.** Standoff detection provides the warning of an approaching cloud (not a specific chemical-biological [CB] agent) in sufficient time to implement protective measures before an agent contamination occurs.

(b) Treatment (Medical Surveillance [MEDSURV]). Detection for treatment focuses on identifying the type of agent dispersed in an attack so that the best possible treatment can be rendered as early as possible.

(c) Verification (Reconnoitering and Monitoring). Detection for verification provides critical information to support decisions regarding national strategic direction and integration.

(d) Surface Contamination (Monitoring). Detection for surface contamination assists the commander with their decision making process. The results of monitoring will allow them to make decisions, such as whether decontamination is necessary or whether bypass routes are needed.

(e) Unmasking (Dewarning). Detection for unmasking is a means of detecting the reduction of contamination to acceptable levels. A comparison of methods and results from the earlier detection of an agent will be an important aspect of determining when to unmask.

(2) Identifying. Identification allows commanders to take the measures required for protection and treatment. Follow-on surveys and sampling can then be used for the verification.

(3) Predicting. CBRN personnel prepare hazard predictions for CBRN attacks, as the attack is not confined to the area directly attacked. The resulting aerosol or fallout travels with the wind and can cover a large area downwind of the attack area. To prevent casualties, units quickly estimate the possible hazard area and warn units within that area. The estimates of the hazard areas are only approximations. Terrain, weather, and delivery system variations modify the hazard area. In addition, the methods used to predict the downwind hazard are “safe-sided” for personnel safety. This ensures that the hazard should be within the predicted area, giving units in the area time to take appropriate precautions.

(4) Warning and Reporting. Warning and reporting informs US forces, allies, and friendly forces of the impending or actual use of CBRN weapons.

(5) Marking. Contamination is marked to warn friendly personnel. Units or CBRN reconnaissance teams mark all likely entry points into the area and report contamination to higher headquarters (HQ).

(6) Relocating and Rerouting. Relocation may be an option, depending on the tactical situation and the mission. This is a viable option for units that are mobile, but is not valid for fixed sites, ports, and airfields.

4. Vulnerability Reduction

Active measures prevent the enemy from using CBRN weapons; passive measures increase survivability. Individual and unit collective measures are only discussed briefly here. See *Multiservice Tactics, Techniques, and Procedures for Nuclear, Biological, and Chemical (NBC) Protection* for detailed information.

a. Active Measures. Active measures are those measures taken to find and destroy munitions and delivery systems. The destruction of the delivery systems and munitions is the best method of reducing the chances of being attacked. The destruction of stockpiles of CBRN munitions and production facilities is usually beyond the capabilities of lower-level

commanders. Strategic levels of command will have the responsibility and the assets to find and destroy these targets. Operational and tactical level commanders do not have the capability to locate and destroy stockpiles or production facilities, but they do have the capability to find and destroy delivery systems.

b. **Passive Measures.** It may not be possible to destroy all threat CBRN munitions and delivery systems; units must always take precautions to avoid being targeted and to reduce the effects of an attack if one does occur. These are passive measures. All units must use passive measures as part of normal operations to reduce the effects of operating under CBRN conditions. These measures include—

(1) **Planning Ahead.** Commanders must take the time to carefully plan courses of action (COAs) and allow for the additional time requirement. This is commonly referred to as war-gaming. A bad decision could cause the unit to become contaminated or suffer casualties. See Appendix A for preattack checklists.

(2) **Avoiding Detection.** Avoiding detection is the best way to prevent CB attacks. Do this by employing operations security (OPSEC) measures. These include camouflage, light discipline and, especially, signal security. Active and passive measures must be used to prevent the enemy from gaining target information.

(3) **Providing Warning.** If the unit is unable to avoid CBRN attacks, the early warning of battlefield hazards is very important. The CBRNWRS notifies units that adjacent units have been attacked or that a downwind hazard is present.

(4) **Seeking Protection.** Seek protection in hardened facilities or bunkers. If they are not available, natural terrain may provide shelter from some effects of CBRN weapons. However, ditches, ravines, and natural depressions allow the accumulation of chemical agents. Heavy forests and jungles protect against liquid chemical agents, but vapor hazards will increase.

(5) **Dispersing Assets.** Dispersion must reduce vulnerability, but not hinder operations or prevent the unit from concentrating when necessary. Supplies (especially food; petroleum, oil, and lubricants [POL]; and ammunition) must be dispersed so that they will not all be destroyed at once. The degree of acceptable dispersion will depend on the mission, enemy, terrain and weather, troops available and civilian (METT-TC) considerations.

NOTE: The USMC and joint doctrine use the term mission, enemy, terrain and weather, troops and support available—time available (METT-T). Civilian considerations are inherently measured within the context of this acronym.

(6) **Remaining Mobile.** Mobility gives the commander the best chance for avoidance. Constant movement prevents the enemy from pinpointing locations and accurately employing CBRN weapons.

(7) **Covering Supplies and Equipment.** Store supplies and equipment under cover to prevent contamination.

5. Chemical, Biological, Radiological, and Nuclear Battle Management

Future requirements for CBRN defense must contribute to the achievement of full force protection (FP) as envisioned by *Joint Vision 2020* (see Figure I-3). Currently, our ability allows us to incorporate existing sensors into a manual system with “man-in-the-loop.” Future artificial intelligence applications will reduce, but not eliminate, human judgment requirements. Combining service capabilities, coalition partners, and available civil defense assets into a standardized warning and reporting system provides the best opportunity to produce CBRN awareness. The sensors collect data, the data is turned into information by using the CBRN report formats, the information is processed into knowledge by experts who provide hazard predictions and contamination overlays, and the knowledge is used by commanders as the basis of understanding for subsequent planning and order development. CBRN battle management (BM) requires the consideration of risks associated with an adversary CBRN employment and the friendly CBRN defense actions. It includes the proper employment of the CBRNWRS and applies principles of IM to the CBRN defense challenges facing the command.

“The potential of such asymmetric approaches is perhaps the most serious danger the United States faces in the immediate future—and this danger includes long-range ballistic missiles and other direct threats to US citizens and territory. The asymmetric methods and objectives of an adversary are often far more important than the relative technological imbalance, and the psychological impact of an attack might far outweigh the actual physical damage inflicted. An adversary may pursue an asymmetric advantage on the tactical, operational, or strategic level by identifying key vulnerabilities and devising asymmetric concepts and capabilities to strike or exploit them. To complicate matters, our adversaries may pursue a combination of asymmetries, or the United States may face a number of adversaries who, in combination, create an asymmetric threat. These asymmetric threats are dynamic and subject to change, and the US Armed Forces must maintain the capabilities necessary to deter, defend against, and defeat any adversary who chooses such an approach. To meet the challenges of the strategic environment in 2020, the joint force must be able to achieve full spectrum dominance.”

Figure I-3. Excerpt From Joint Vision 2020

a. CBRNWRS. The CBRNWRS provides data and information to support the CBRN BM process. Input and output from the CBRNWRS provides a means to inform friendly units of possible contamination. For the CBRNWRS to be effective, units send information on first use by the fastest communications means available. For example, first-use reports require FLASH precedence. Units send subsequent information by any reliable communications means.

b. CBRN IM. CBRN IM (see Figure I-4, page I-8) refers to the processes a commander uses to obtain, manipulate, direct, and control information. IM includes all processes involved in the creation, collection, control, dissemination, storage, and retrieval of information. CBRN SA of the operations environment allows the commander to anticipate future conditions and accurately assesses risks. Graphic depictions of CBRN hazard estimates/plots with text files (e.g., messages, reports) are very useful versus sole reliance on map boards and overlays. The vertical and horizontal exchange of CBRN-related information keeps different commands and staff personnel informed. The CBRN staff determines the need for specific types of CBRN information (i.e., the when and where of the CBRN attack). Positioning the required information at its anticipated points of need speeds the flow and reduces demands on communications systems. The information received from sensor networks also helps to provide an assessment of the current situation by detecting and identifying CBRN hazards in air, on water, or on land. It detects and

identifies CBRN hazards affecting personnel, equipment, or facilities and the physical state of such hazards (gas, liquid, or solid). The detection of hazards is a key enabler and provides a visualization of the CBRN environment. This visualization helps to develop a clear understanding of the current and predicted CBRN situation, envision the end state (mission accomplishment without CBRN casualties and operating tempo [OPTEMPO] degradation), and anticipate the sequence that moves the force from its current state to the desired end state. The commander's SA and risk assessment leads to decisions to implement measures to protect the force and maintain an advantage in the OPTEMPO while preventing casualties under CBRN conditions by reducing the threat, reducing operational vulnerability, and avoiding contamination.

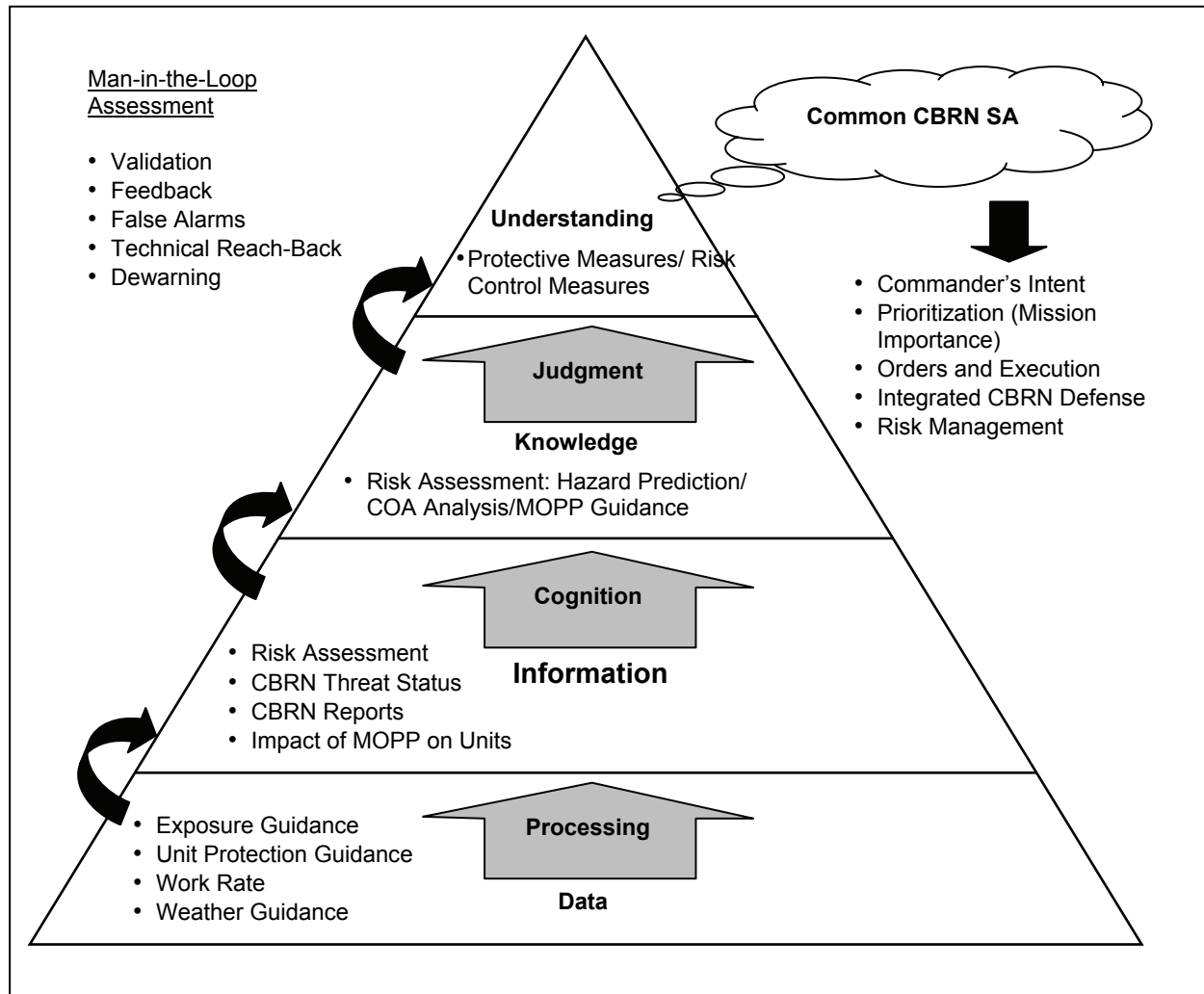

Figure I-4. CBRN IM

(1) Actions. The CBRN staff translates all source information into an understanding of the CBRN threat and the operational environment for CBRN defense actions. This process requires—

- Timely conduct to assess vulnerability.
- Specific COAs for reducing vulnerability and countering specific threats.

- CBRN warning and reporting on potential and actual CBRN attacks to facilitate risk assessments and actions and to minimize the short- and long-term health effects of toxic exposures.

(2) Enablers. To maintain SA, units conduct CBRN IM by—

- Obtaining the relevant battlespace data.
- Processing data into relevant information.
- Gaining knowledge by determining the impact of the information on operations.
- Developing a plan based on the knowledge of the situation (knowing what has occurred and what to do about it).
- Supporting CBRN defense execution through orders and risk management.
- Maintaining SA with man-in-the-loop assessment.

(3) Data. The CBRN staff focuses on knowing what data is relevant, determining what data can be collected prior to events, and developing a data collection plan to obtain other data.

(4) Information. The CBRN staff processes data into operationally significant information and develops a collection plan to obtain additional data if information is incomplete.

(5) Knowledge. The CBRN staff uses their military decision-making process to translate information into knowledge. It estimates and assesses hazards to develop possible COAs.

(6) Understanding. Understanding requires SA; the commander uses this awareness to communicate intent and issue orders that mitigate risk through the application of various CBRN defense measures.

6. Commander and Staff Interactions in Meeting Chemical, Biological, Radiological, and Nuclear Defense Challenges

a. CBRN defense challenges call for close commander and staff interactions. Operations in CBRN environments demand close attention to technical details by CBRN staff experts and the integration of CBRN defense knowledge into the organization plans and actions. Technical experts must be fully familiar with the organization mission and capabilities and the current situation so that their assessments and recommendations provide meaningful options for action by the commander.

b. In addition to applying the principles of CBRN defense and exercising CBRN BM capabilities in the most effective manner, CBRN staff experts must be aware of the military and civilian environments in which the organization operations are unfolding. While the primary responsibility of the commander and the military organization as a whole is to accomplish the mission and care for the lives and welfare of individuals in uniform, the military exists in an interdependent mode with its surrounding community. Therefore, due to consideration in risk assessments, other recommendations and plans must be given to the broader environment, including the civilian populace, in order to make militarily effective plans that are not frustrated by adversary damage inflicted on the civilian community. See Appendix B for information on CBRN cells.

7. Chemical, Biological, Radiological, and Nuclear Operations

CBRN operations require detailed planning to be successful.

a. CBRN Defense Planning and Considerations.

(1) Operational Implications. At the operational level, the analysis of the battlespace environment should concentrate on—

- The capability of transportation networks to support movement.
- Logistic support to CBRN weapons.
- Zones of entry into and through the operational area and area of interest.
- The impact of large geographic features (such as mountains, large forests, deserts, and archipelagos) on military operations.
- Seasonal climatic effects on CBRN weapons effects.

CBRN defense planning and analysis assists the commander and staff in visualizing and assessing the full spectrum of adversary offensive CBRN weapons capabilities across all dimensions of the battlespace. The following is a list of items to be considered when planning CBRN defense:

(a) Intelligence Collection, Analysis, and Production. Assessments should identify threat agents and weapons and industrial sites containing TIM that would present a hazard to deployed forces if sabotaged or destroyed.

(b) SA. Ensure that the CBRNWRS is operational as quickly as possible after entry into a theater. Assets such as the Biological Integrated Detection System (BIDS) should be deployed to monitor high-value assets. Detection systems for CBRN agents should be deployed and networked to provide a warning of attack.

(c) Common Planning, Training, and Equipment Standards. Gaps in the CBRN defense capabilities of multinational forces are identified to promote effectiveness in planning and operations.

(d) Medical CBRN Defense. Medical CBRN defense is integrated into the planning process to support unit readiness. See Appendix C for detailed information on radiological exposure

(e) Protection of the Joint Rear Area and Theater Sustainment Capabilities. A successful adversary CBRN attack on an essential port of debarkation or other critical logistics facility can degrade joint-force OPTEMPO and force generation capabilities.

(f) Logistics Burden of CBRN Attacks. The resupply of protective clothing, equipment, repair parts, medical supplies (antidotes and antibiotics), and other resources must be factored into computation of resource requirements.

(g) In-Theater, Active-Defense Systems. Planners should consider deployment configurations and concepts of operations that maximize the use of active-defense systems.

(h) Preplanning for Attack Operations. Attack operations are prioritized and may be a high strategic or national priority at any point in a crisis, during the

transition to war, or during hostilities as a means to deny an adversary the capability to produce, store, transport, or employ CBRN weapons.

(i) Effects of CBRN Attacks on Command, Control, Communications, Computers, and Intelligence (C4I). Limitations will result from the requirement to operate in CBRN protective equipment, from the contamination of equipment, and from the effects of electromagnetic pulse (EMP) on electrical and electronic equipment.

(j) Capabilities and Limitations of Multinational Forces. The planning process should consider the implications and feasibility of diverting US assets and capabilities to support host nations (HNs) and other multinational members in meeting common operational objectives.

(k) In-Theater Consequence Management (CM). Plans for in-theater CM include the mitigation and management of the effects of CBRN attacks within a theater of operations (see *Multiservice Tactics, Techniques, and Procedures for Nuclear, Biological, and Chemical Aspects of Consequence Management*).

(2) Tactical Implications. At the tactical level, the size and location of battlespace are influenced by the physical location of adversary land, air, naval, space, and other forces that could pose a direct threat to the security of the friendly force or the success of its mission. The extent to which the effects of the battlespace environment are analyzed at the tactical level is largely dependent on the mission and planning time available. At a minimum, tactical level forces should analyze the battlespace environment in terms of military objectives, avenues of approach, and the effects of a CBRN environment on personnel, military operations, weapons systems, and force mobility. CBRN defense at the tactical level will be based on, and result in, a higher degree of detail than would be necessary at higher levels of military operations.

(3) Homeland Defense Implications. A challenge for commanders conducting CM operations is the requirement to adequately protect personnel, and materiel from a CBRN incident. There is a need for a response capability to save lives, contain an incident, and recover to a point that permits operations to resume. Confronting this challenge requires a comprehensive and integrated approach from threat mitigation to incident response and recovery. Military units develop deliberate plans to respond to CBRN attacks within their assigned regions. Response plans should be updated regularly and coordinated with the appropriate response agencies in the region. Plans should focus on the unanticipated event and potential terrorist targets, such as special events, high-profile buildings, medical and scientific research centers, and air and rail transportation platforms. Response elements should also prioritize planning efforts in coordination with the other response agencies within their region. Planning efforts should be prioritized based on the most likely threats.

b. Chemical Defense Planning and Considerations. (See Appendixes D and E.)

(1) Operational Implications. Chemical warfare (CW) can be used to contaminate ground and resources with persistent chemical hazards. Nonpersistent vapor hazards and the vapor from persistent contamination can spread downwind and pose a hazard over a significant portion of the AOs given the right meteorological (MET) conditions. Commanders will need to consider the avoidance and evacuation of hazard areas. CW protection will be needed for forces that remain in the area. Operational capability and tempo are likely to be degraded because of the need for the force to adopt

CBRN defense detection, warning, protection, and control measures. Chemical detection, identification, protection, and decontamination will put a burden on the theater logistics system.

(2) **Tactical Implications.** Forces remaining in or near CW hazard areas will probably need to remain in CBRN protection until the commander determines that the personnel should reduce their mission-oriented protective posture (MOPP) level. This can cause some loss of OPTEMPO due to the fact that it may—

(a) Cause personnel to work in individual protective equipment (IPE), degrading performance, increasing fatigue, and possibly lowering force cohesion and morale.

(b) Reduce the overall speed, cohesion, and freedom of movement of forces in the local area because of contaminated areas and assets.

(c) Restrict the local use of ground and operational assets, cause resource-intensive decontamination of key assets, and distort the logistics chain.

(3) **Homeland Defense Implications.** The use of chemical agents can cause psychological and physiological effects and also cause contamination or damage that will restrict the use of facilities, equipment, or supplies. Fear and panic are the normal reactions to discussions of chemical agents, and most civilian authorities will need considerable assistance in locating, containing, and recovering from a chemical incident.

c. **Biological Defense Planning and Considerations.** (See Appendix F.)

(1) **Operational Implications.** The potential impact of biological warfare (BW) attacks at the operational level can be wide-ranging and significant, particularly if the detection and identification of an attack proves difficult and countermeasures are difficult to implement. Large numbers of casualties can reduce the operational capability of the joint force, reduce morale, and divert medical and logistics resources from current operations. When combined, these factors may reduce OPTEMPO.

(2) **Tactical Implications.** There will be some loss of operational capability by those forces remaining in or near BW hazard areas. The following factors may hinder personnel effectiveness:

(a) Remaining in CBRN protection for long periods of time.

(b) Maintaining frequent and regular health monitoring of personnel, increased standards of hygiene, and protection of rations and water.

(c) Avoiding the use of contaminated areas and assets.

(d) Decontaminating key assets.

(3) **Homeland Defense Implications.** One of the dangers of biological weapons is amplified by the fact that exposure to the agents would probably not be known until symptoms appear (sentinel casualty). Personal protection generally consists of individual protection and medical measures, such as immunization or the application of some other postincident medical treatment (antibiotics). Biological-agent dissemination could be accomplished by measures such as aerosol dissemination, food or water contamination, and vector release. Biological agents can be produced in the laboratory or purchased from a number of medical-research firms. For planning purposes, individual protection at any suspected biological incident is of the utmost importance. Mobile laboratories can process

samples and identify pathogens. Early identification is essential in order to begin treatment protocols.

d. Nuclear and Radiological Defense Planning and Considerations. (See Appendixes G and H.)

(1) Operational Implications. The devastation resulting from a nuclear burst is likely to require that a significant portion of the joint force assets be deployed to assist in recovery in the area of the nuclear burst. The fallout from the nuclear detonation will cover a portion of the joint operational area, and measures to control the contamination and exposure of all personnel in the area will be needed. The operational capability of the joint force is likely to be degraded for a considerable period. The potential for mass casualties in the local civilian population is also likely to place a burden on the operational command and staff.

(2) Tactical Implications. In the area of a nuclear detonation, the operational capability of the joint force will be seriously degraded. Degradation will be caused by the loss of personnel, equipment, and resources; and the need to rescue and treat injured personnel and fight possible fires will require a significant expenditure of resources. The blocking of transportation routes and mobility corridors by debris and trees may also degrade recovery. There will also be a need to deploy assets to assist other agencies and the HN. The immediate area of the nuclear detonation is likely to be highly contaminated, and movement, except to save life, will be severely limited. Fallout and induced radiation patterns will require that units follow the operational exposure guidelines in Appendix C.

(3) Homeland Defense Implications. While the detonation of a nuclear device is perhaps the least likely scenario for a terrorist incident, it has the potential to cause the greatest damage in terms of destruction and psychological damage (fear and panic). The effects of a nuclear detonation include thermal, blast, and nuclear radiation. Even for a small nuclear device, the number of casualties from blast, thermal, and initial nuclear radiation could number in the hundreds. The presence of an induced radiation pattern and downwind fallout will require a large number of monitors using radiac equipment and might require the evacuation of a large number of people until the radiation decays to a safe level.

e. Radiological Weapons Defense Planning and Considerations. (See Appendixes G and H.)

(1) Operational Implications. Radiological warfare can be used to contaminate ground and resources with radioactive hazards. Commanders will need to consider the avoidance and evacuation of the hazard areas, particularly during military operations other than war (MOOTW). Radiological protection will be needed for forces that remain in the area. Operational capability and tempo are likely to be degraded because of the need for the joint force to adopt CBRN defense detection, warning, protection, and control measures.

(2) Tactical Implications. There will be some loss of operational capability by those forces remaining in or near radiological hazard areas. This will be caused by the need to—

(a) Remain in CBRN protection for long periods of time.

(b) Manage exposure to radioactive hazard and rotate personnel, particularly during MOOTW.

- (c) Avoid the use of contaminated routes, areas, and assets.
- (d) Decontaminate key assets.

(3) Homeland Defense Implications. A terrorist could wrap an improvised explosive device (IED) with radiological materials to create an incident in which the initial explosion may kill or injure persons in the immediate vicinity of the device. Following the incident, the possible ingestion and inhalation of radioactive particles would also pose a health risk. Simple radiological dispersal is an act intended to spread radioactive material not involving an explosive device. A terrorist need only secure a supply of radiological material (e.g., gamma, beta, or alpha emitters) from a medical laboratory, industrial facility, or other site and disperse the material.

f. ROTA and TIM Defense Planning and Considerations. (See Appendix H.)

(1) Operational Implications. The sites of significant TIM facilities in the joint operations area need to be plotted and, whenever and wherever possible, avoided during operations. Contingency plans need to be made with the HN to control and contain the hazards if TIM facilities are damaged. Whatever the circumstances of a TIM release, the impact on military capability will need to be assessed. A large-scale release from TIM facilities, particularly if there are also large fires, has the potential to spread toxic aerosols and smoke across a significant percentage of the operational area. Such hazards will need to be avoided by the joint force or protection will be needed, particularly during MOOTW. This is likely to restrict the freedom of action of the joint force and may degrade OPTEMPO. Damage to nuclear facilities, even without a breach to core containment, may also spread radioactive aerosols and smoke. In addition, if threat CBRN weapon production or storage sites are targeted and hit, downwind hazard prediction should be accomplished to determine if there is any threat to the force or HN personnel.

(2) Tactical Implications. Forces that remain in the area will probably need to adopt protection. Because of the nature of the TIM, countermeasures may not be within the CBRN defense capability of the joint force. In this case, a specialist in the field of hazardous materials (HAZMAT) management will be needed from the HN or outside the theater. If conflict takes place in the area of TIM storage facilities, the risk of collateral damage and the release of TIM must be assessed. Unused industrial sites with hardstands and warehouses often provide ideal logistics facilities, but need to be checked for all forms of TIM before use. Particular note of TIM needs to be taken when accommodations for personnel are selected.

(3) Homeland Defense Implications. TIM are substances that may create signs and symptoms similar to CBRN exposure. These materials are found throughout the normal transaction of daily business in the United States and are transported on our railways, roadways, and waterways. They may or may not be precursors to CBRN agents. Most of the materials contain volatile organic compounds, which are materials that contain hydrocarbons and possibly other hazardous elements. They may be naturally occurring or man-made and may evaporate easily based on agent characteristics. Testing has proven that extended exposure may lead to debilitating injury. Some are carcinogenic, such as benzene, or mutagenic, such as hexane (nervous system disorder). Technological innovations and the widening proliferation of CBRN hardware and scientific expertise increase the likelihood that states, nonstate actors, or transnational groups could threaten the US homeland and population directly and, in times of conflict, deny US access to critical overseas and domestic infrastructures. Terrorism remains one of the deadliest and most

persistent threats to US security. The motives, perpetrators, and methods of terrorist groups are evolving in ways that complicate analysis, collection, and counteraction and require the ability to respond flexibly and quickly. Sophisticated detection, analytical, and protective equipment is required to detect and identify the TIM and the special protective equipment that may be needed.

THIS PAGE IS INTENTIONALLY LEFT BLANK.

Chapter II

DEVELOPING THE CHEMICAL, BIOLOGICAL, RADIOLOGICAL, AND NUCLEAR COMMON OPERATIONAL PICTURE

1. Background

a. CBRN avoidance measures can consist of passive measures as described in Chapter I. However, the reporting of critical information will support time-sensitive decisions to warn and protect our forces. The effective and efficient processing of CBRN information will support the unit mission and the commander's FP decision making. Timely CBRN IM is built on integrating NBC report input into the command and staff COP.

b. A CBRN COP provides the commander and his forces with information that is accurate, timely, usable, precise, and reliable. As defined in Joint Publication (JP) 1-02, COP is a single identical display of relevant information shared by more than one command. A COP facilitates collaborative CBRN planning and assists all echelons to achieve SA. While the COP is intended to support the unit mission, the CBRN staff will display information specifically designed to support their operations (e.g., NBC reports, hazard predictions). The key consideration is that the information must be organized and easily understood. The CBRN staff supports the preparation of the COP through the following:

- Identifying information requirements (e.g., adversary CBRN capabilities, potential time and place of attacks).
- Collecting and processing information (e.g., collection, analysis, and dissemination of NBC reports).
- Providing information to build the COP and displays (e.g., hazard overlays, areas of contamination).
- Developing understanding (e.g., supporting the commander's decision-making process to take avoidance or protective measures).

2. Chemical, Biological, Radiological, and Nuclear Common Operational Picture Functions

There are four representative functions that support CBRN COP operations. They are—

- a. **Detection.** Detection is the act of locating CBRN hazards by the use of CBRN detectors or monitoring and/or survey teams.
- b. **Identification.** Identification is the process of determining the benign or hazardous character of an unknown detected substance.
- c. **Contamination Marking.** Contamination marking is used to provide warning to friendly forces of the presence of contamination.
- d. **Warning and Reporting.** The warning and reporting of a CBRN attack is done using the CBRNWRS.

3. Chemical, Biological, Radiological, and Nuclear Information Management

CBRN IM is providing quality information to the right person at the right time in a usable form to facilitate understanding and decision making. CBRN IM uses the CBRNWRS as a tool to provide relevant, precise, accurate, timely, usable, and complete information.

NOTE: An automated version of the CBRNWRS (joint warning and reporting network [JWARN]) is currently being integrated into existing C4I systems in order to collect, process, store, protect, display, and disseminate CBRN information.

a. CBRN Processes. CBRN IM supports the commander in three main areas: achieving SA/understanding, making decisions, and communicating execution information to implement those decisions. CBRN IM is cyclical in nature and has four basic steps (Figure II-1).

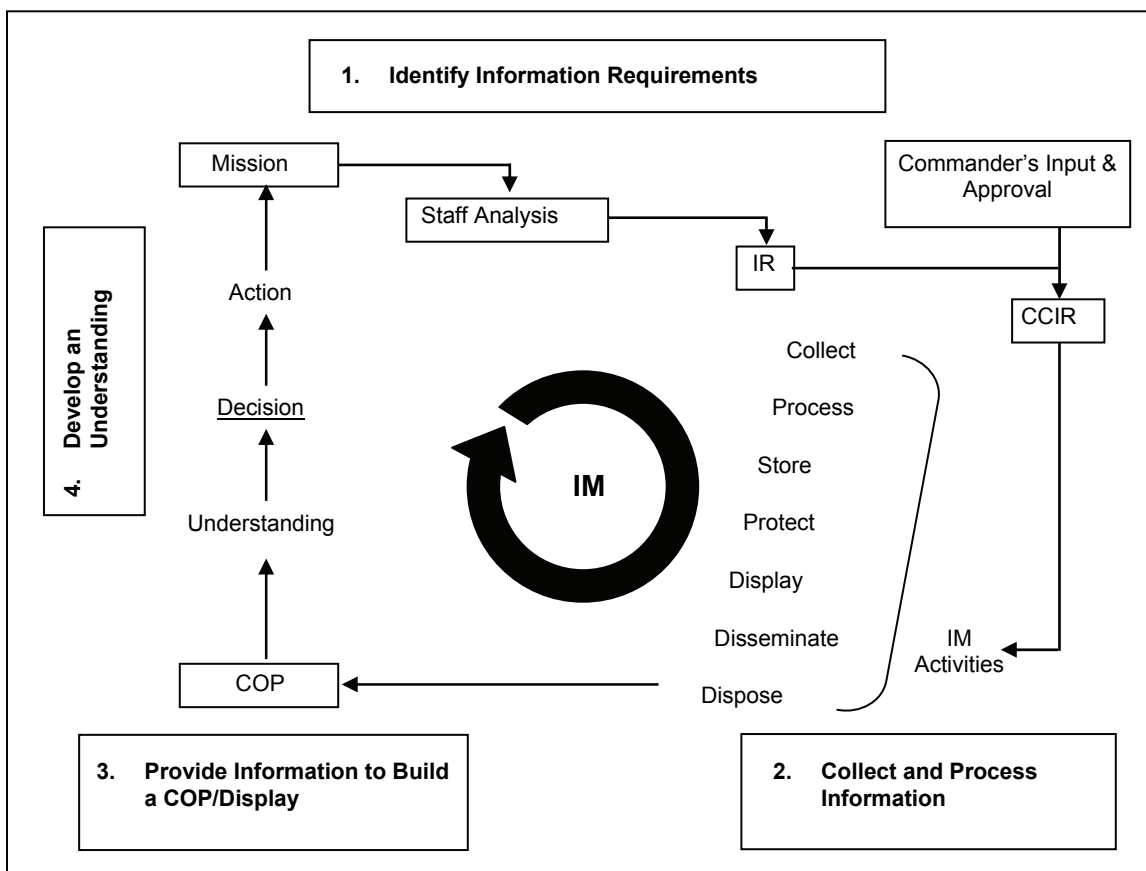

Figure II-1. IM Cycle

(1) Identify Information Requirements. Information requirements are the criteria that must be known about the battlespace to enable mission accomplishment. Information requirements such as MET data; friendly unit locations; enemy CBRN capabilities; the likelihood of CBRN weapons use; and where, how, and what CBRN materials may have already been employed against friendly forces will all have a direct impact on information requirements.

(2) Collect and Process Information. The process continues with the collecting and processing of information to fulfill information requirements. The receipt of NBC1 or NBC4 reports will require processing in accordance with Appendixes E through H and will directly contribute to fulfilling and identifying information requirements.

(a) Collect. Obtain information on a CBRN attack from the NBC1 and NBC4 reports in any manner, including direct observation or other reconnaissance and surveillance (R&S) means.

(b) Process. Discern the meaning of the data; and filter, format, compile, organize, correlate, plot, and evaluate the CBRN information.

(c) Store. Retain the CBRN information in any form for orderly, timely retrieval and documentation until needed.

(d) Protect. Take measures to ensure the availability of information and information systems.

(e) Display. Represent the CBRN information in a usable, easily understood audio or visual form tailored to the needs of the user. The display conveys the COP for decision making and exercising C2 functions. Historically, the display of CBRN information has taken the form of formatted charts, written reports, verbal narrative reports, and graphic map displays.

(f) Disseminate. Communicate the evaluated information (such as NBC2, NBC3, or NBC5 reports), and coordinate the procedures to disseminate the applicable information to be incorporated into the standard operating procedure (SOP).

(g) Dispose. Take action on inactive records. These include destroying and archiving information.

(3) Provide Information to Build a COP/Display. CBRN information that is accurate, timely, usable, complete, precise, and reliable is used to build a COP. COP is a single, identical display of information shared by more than one command. CBRN information contributes to the COP. The impact of a CBRN attack can affect more than one command. Each command affected requires relevant information on the CBRN attack (e.g., when, where, impact).

(4) Develop an Understanding. Awareness is achieved by the provided information, but it takes an understanding of the information to make prompt, correct decisions (such as changing a route to avoid contamination or adjusting the MOPP level).

b. CBRN IM Activities. The CBRN IM includes seven basic activities—collecting, processing, storing, protecting, displaying, disseminating, and disposing of the information.

c. CBRN IM Capabilities. The capability to receive and report CBRN attack information varies from command to command. The CBRN staff makes an assessment of the capability that exists within their command. Capabilities may range from detectors and alarms that are not integrated to fully integrated sensors at selected locations.

(1) Currently, many CBRN-agent detector and alarm arrays operate as independent units. When a CBRN attack is detected, only those personnel in the immediate vicinity hear the alarm. Adjacent units need to be notified by radio, wire communications, or audible or verbal means. CBRN calculations and computations in support of CBRN hazard prediction are often done manually.

(2) To assist commanders and improve and automate the information gathering and sharing process, several government off-the-shelf (GOTS) and commercial off-the-shelf (COTS) systems have been developed and are in use throughout the US military (see Chapter III for more information).

4. Chemical, Biological, Radiological, and Nuclear Information Flow Strategy

The effective flow of information is paramount to CBRN defense operations.

a. The CBRN IM procedures must provide for the rapid vertical and horizontal flow of information. Traditional staff arrangements have determined that the flow of CBRN information should logically flow to the CBRN cells. However, it should not form a firewall to the exchange of CBRN information with the other staff elements (e.g., operations, intelligence, and logistics) or commands. Optimum information flow within a HQ requires speed and clarity of transfer, without creating fragmented or useless information. The effective flow of CBRN information requires the information to be—

- Positioned properly. Positioning the required information at its anticipated points of need speeds the flow (e.g., using public folders or web pages to post the required CBRN information, such as MET reports).
- Mobile. Information flow must be immediately adjusted to support the vertical and lateral flow of information between adjacent forces (e.g., collaborative planning system on the integration of CBRN R&S assets).
- Accessible. All levels of command must be able to pull the information they need to support concurrent or parallel planning and mission execution (e.g., graphic depiction of CBRN forces in a COP).
- Fused. Information is received from many sources, in many mediums, and in different formats. It is blended into an accurate summary (e.g., a CBRN threat assessment disseminated in graphic form on an automated COP system).

b. The information flow provides input for the commander's decision support matrix (DSM). The DSM identifies key decisions, expected events, and planned friendly actions that the commander expects to make during the next stage or phase of the operation. The DSM links information to key CBRN decisions. The CBRN staff provides input to help develop a DSM during the planning process. The DSM identifies the commander's critical information requirement (CCIR) needed to make decisions and achieve the desired results. (For more information on DSMs refer to Marine Corps Warfighting Publication [MCWP] 3-40.2)

c. Implementing the CBRN information flow strategy provides for the required input for the decision-making process. The CBRN staff performs the following representative functions that furnish information to support the COP and the decision-making process:

- Collect and analyze sensor inputs (e.g., detector data, detector alarms, medical alerts).
- Maintain information on the status of CBRN networked sensor grids.
- Format and forward NBC reports to facilitate the warning of personnel.

- Disseminate NBC reports and detector data over service tactical communication networks.
- Conduct planning, training and certifying of war fighters to help ensure that deployed and/or fielded (developmental) CBRN detectors are interoperable with the warning and reporting system. If integrated detectors are not used, ensure that personnel are trained in manual report procedures.
- Generate and display scalable hazard overlays (e.g., plots) resulting from CBRN and TIM hazards.
- Provide hazard prediction analysis capabilities, perform CBRN and TIM risk assessments, and provide situation reports (SITREPs) in support of CBRN reconnaissance/survey plans and decontamination plans.
- Create CBRN annexes to operation plans (OPLANs), operation orders (OPORDs), and fragmentary orders (FRAGORDs).
- Store, modify, retrieve, display, archive, and transfer data on weather, terrain, unit locations, intelligence, locations of attacks, sources (suspected and actual) of attacks, and CBRN or TIM hazards. This archived data is needed for event reconstruction in the postattack phase. Weather, terrain, unit location, etc., information is required for input to the basic hazard prediction analysis capability.
- Provide hazard estimated times of arrival and times of departure to units near a hazard area.
- Maintain information on the locations of assigned (remote, direct, and networked) detectors.
- Maintain unit CBRN information status, radiation exposure status (RES) for reporting units, and operational status and expected changes for supporting CBRN units. Monitoring CBRN unit status facilitates the decision process and risk assessment, and provides current and expected unit status for the support of CBRN defense missions.
- Provide recommendations on dewarning via manual voice or automatic means to affected units within and outside the area of concern.
- Provide input, as required, on detailed characteristics of CBRN agents, their delivery means, their symptoms (e.g., human effects), and other data required for adequate risk assessment.
- Provide basic hazard predictions of CBRN agents and TIM to assist in the preparation of vulnerability assessments.
- Provide a man-in-the-loop filtering capability at the operator level to validate CBRN detections, reduce the likelihood of being falsely warned, and reduce information overload for single and multiple attacks.
- Log and archive CBRN report, detector, and sensor inputs.
- Receive and accept the input of intelligence data from tactical, operational, and strategic sources; predicted intercepts of theater air and missile (TAM) data from air defense radar systems and defense C2 systems; and other C4I and R&S inputs.

- Receive and accept meteorology and oceanography data from tactical, operational, and strategic sources.

5. Common Operational Picture Management

Maintaining the COP ensures that US forces can make informed CBRN defense decisions.

a. Information Inputs. CBRN data feeds into the COP and can be automated or manual. CBRN IM input may include the following:

(1) Friendly CBRN air, maritime, and ground force tracks/locations within the operational area.

(2) Enemy air, maritime, and ground force CBRN capabilities within the operational area.

(3) CBRN operational overlays.

(4) MET and terrain overlays.

(5) CBRN-related nongovernmental organization products.

(6) Any other information or graphic displays required.

b. Standardization. CBRN information requirements are often predictable. The staff can position information at its anticipated points of need to speed information flow and reduce the demands on communications systems. One method is establishing a standard reports matrix (Table II-1) to meet recurring information requirements. It provides a brief description of the report, the sender, the receiver, and when and how to transmit the report. The matrix should reflect the following information:

- Report title: Report title or type of information provided.
- Submitted by: The component or agency normally responsible for submitting the report.
- Submitted as of: Close-out time for recurring reports. This should be no more than 1 hour before the arrive-not-later-than (NLT) time.
- Arrive NLT: Time to post the report for joint task force review.
- Transmission type: System used (e.g., e-mail or defense message system).
- Precedence: The precedence to use when notifying the joint task force that the report is available (not applicable to some notification methods).
- Addressee: Who the report goes to.
- Info to: Additional addresses.

Table II-1. Reports Matrix (Sample)

| Report Title | Submitted by | Submitted as of | Arrive NLT | Transmission Type | Precedence | Addressee | Info to |
|----------------------------------|-------------------|---|----------------|-------------------|------------|-----------|------------|
| Personnel Status Report | Components | 2000Z | 2100Z | E-mail/home page | Routine | J1/G1 | |
| Intelligence RFI | Components | As required | As required | Colliseum | Priority | J2/G2 | |
| Spot Report | Components | As required | As required | E-mail | Routine | J2/G2 | |
| SITREP (Commander) | Components | 2400Z | 0100Z | DMS/home page | Priority | J3/G3 | Components |
| Orders (FRAGORD, WARNORD, OPORD) | J3/G3/ Operations | As required | As required | DMS/home page | Priority | All | Components |
| NBC1 | Components | As required | As required | Voice, e-mail | Flash | CBRN cell | Components |
| NBC2 | Components | NLT 2 hours after "as of time" | As required | GCCS/e-mail | Immediate | CBRN cell | Components |
| NBC3 | Components | As required | As required | GCCS/e-mail | Immediate | CBRN cell | Components |
| NBC4 | Components | As required | As required | GCCS/e-mail | Immediate | CBRN cell | Components |
| NBC5 | Components | After survey completed | As required | GCCS/e-mail | Immediate | CBRN cell | Components |
| NBC6 | Components | When requested | When requested | GCCS/e-mail | Immediate | CBRN cell | Components |
| BWR | | | | | | | |
| BWM | J2/G2 | Contains weather information for the following 6 hours | As required | All | Immediate | All | Components |
| BWF | J2/G2 | Contains weather information for the subsequent 6-hour period | As required | All | Immediate | All | Components |

Table II-1. Reports Matrix (Sample) (Continued)

| Report Title | Submitted by | Submitted as of | Arrive NLT | Transmission Type | Precedence | Addressee | Info to |
|--------------|--------------|---|-------------|-------------------|------------|-----------|------------|
| EDR | | | | | | | |
| EDM | J2/G2 | Contains weather information for the following 6 hours | As required | All | Immediate | All | Components |
| EDF | J2/G2 | Contains weather information for the subsequent 6-hour period | As required | All | Immediate | All | Components |
| CDR | | | | | | | |
| CDM | J2/G2 | Contains weather information for the following 6 hours | As required | All | Immediate | All | Components |
| CDF | J2/G2 | Contains weather information for the subsequent 6-hour period | As required | All | Immediate | All | Components |

c. CBRN Information Network Applications.

(1) Networking technologies are expanding the options available for managing the flow of CBRN-related information. A collaborative environment for sharing CBRN-related information can be achieved using tools such as web pages, public folders, and e-mail. An intranet infrastructure for HQ may differ from one HQ to another, but the concepts are generally the same. A HQ intranet is a communications network in which access to published information is restricted.

(a) Web sites and portals. A well-organized Web site assembles, organizes, and presents vital CBRN information in a timely manner. The CBRN staff may develop and maintain their own Web pages for the site. CBRN information on these Web pages could include important updates, status reports, common staff products, and current activities.

(b) E-mail. E-mail is a highly effective means to communicate CBRN information, which would provide rapid dissemination of time-critical information within the HQ. The CBRN staff should consider establishing functional versus individual accounts to avoid an unnecessary e-mail overload. This helps prevent a message backlog for personnel not on shift. Additionally, the use of a precedence system within an e-mail identifies the messages requiring timely handling and review.

(c) Shared disk drives and folders are other means that allow common access to information. Shared drive folder names may be topical or use the same titles as those shown in the file plan drive. See Table II-2 for a sample of shared message folders.

Table II-2. Shared Message Folders (Sample)

| Personnel | Intelligence | Operations | Logistics | CBRN |
|---------------------------|------------------------------|-------------------------------|---------------------|--|
| Administrative | Action Items | Air Operations | Briefings | Administrative |
| Completed Taskers | Administrative | Airlift | General Information | Directories/Rosters |
| Daily News Briefs | JULLS | Fighters | RFI | Organization Structure |
| Incoming Messages | MSG-Air | Army Aviation | Play Information | Briefing Slides |
| Information Requests | MSG-BDA | Army Ground | Reports | Incoming Messages NBC1/4/6 SITREPs |
| Outgoing Messages | MSG-FP | CMOC | Administrative | Outgoing NBC3/4 |
| Personnel | MSG-Ground | Everybody Read | Civil Engineers | CBRN R&S |
| SITREPs | MSG-IIR/Collection Report | EWO | Comptroller | JULLS |
| J1 Reports | MSG-INSUM | General Information | Contracting | Administrative |
| Personnel Status Requests | MSG-Naval | Information Operations | Director | Computer System Support |
| Receipts (Verification) | MSG-Political | JOC | Fuels | Current Operations |
| Policy Guidance | MSG-Refugees/Med | JULLS | LNO | OPLAN/OPORD/ FRAGORD Input |
| Postal | MSG-SITREPs | LNOs (J1, J2, J3, J4, J5, J6) | Medical | Future Operations |
| Incoming | MSG-Targets | MSEL | Plans | Future Plans |
| Outgoing | MSG-Terrorist Activity | Navy Operations | Services | Decontamination Plans |
| Suspenses | MSG-WARNORD Execute Order | Operations Plans | Supply | SITREP Inputs |
| | WMD/CBRN/SCUDS | Operations Analysis | Suspenses | CBRN IPB |
| | Weather | Orders | Taskers | Joint SYSCON |
| | | FRAGORDs | Transportation | JULLS |
| | | WARNORDs | Weapons | LNO |

THIS PAGE IS INTENTIONALLY LEFT BLANK.

Chapter III

CHEMICAL, BIOLOGICAL, RADIOLOGICAL, AND NUCLEAR WARNING AND REPORTING SYSTEM

1. Background

The collection, evaluation, and exchange of information on CBRN incidents are extremely important parts of avoidance. Chapter I provided a CBRN avoidance overview and describe how it fits into the overall CBRN defense concept of operations. Chapter II provided a CBRN COP and CBRN IM overview. The CBRNWRS is a CBRN avoidance cornerstone. It provides the information transfer necessary to develop the CBRN COP and IM. Commanders at all levels must be provided with timely, accurate, and evaluated information on contamination from CBRN attacks and ROTA. These incidents can have a significant effect on any military operations, plans, and decisions. The primary means of warning units of an actual or predicted CBRN hazard is the CBRNWRS. The CBRNWRS allows commanders and CBRN staffs to determine required protective measures and plan operations accordingly. It is the responsibility of commanders at all levels to ensure that plans, directives, and SOPs consider CBRN defense as a priority.

2. Organization

The CBRNWRS provides a systematic organization of the CBRN COP information.

a. CBRN Warning and Reporting Areas. In order to organize the reporting, evaluating, and sharing of CBRN incident information, the following information areas and zones will be established:

(1) The CBRN area of observation is a geographical area consisting of several CBRN zones of observation. When operating in areas where the CBRN area of observation is not defined beforehand, the area must be defined and agreed to by the involved commands. An example of an area of observation would be Central Command (CENTCOM).

(2) The CBRN zone of observation is a geographical area which defines the responsibility for collecting and reporting information on enemy or unidentified nuclear detonations, CB attacks, NBC ROTAs, and resulting contamination. CBRN zones of observations must cover the entire geographical area defined by a CBRN area of observation. An example of a zone of observation would be a USA division AO.

b. CBRN Warning and Reporting Centers and Cells. These sections will be responsible for processing and evaluating CBRN-related data, updating information requirements, assisting with the development of the CBRN COP, and updating battlefield intelligence. Refer to Appendix B for more information on the responsibilities and TTP on CBRN center and cell operations.

3. Information Management

Managing the CBRNWRS is crucial for the success of a command. To be useful, CBRN information must be collected, reported, and evaluated. Once evaluated, it can be used to update battlefield intelligence. Obtaining and converting CBRN information into usable intelligence does not just happen. The volume of information that needs to be

collected and reported could easily disrupt communications and tactical operations if it is not properly managed. This section describes what information is available and how that information gets to the person or unit needing it.

a. **Gathering Information.** The first step in managing the CBRNWRS is to determine what information is available and who is available to collect it. Two types of data must be collected. Observer data provides information that a CBRN attack has occurred. Monitoring, survey, and reconnaissance data provide information on where the hazard is located. Every unit is responsible for observing and recording enemy attacks, but every unit does not automatically forward NBC1 reports. For example, many units may observe a nuclear burst, but if every unit forwarded a report, nothing would get through. For this reason, selected units that have the equipment to make the accurate measurements will submit the NBC1 reports. These units are called *designated observers*. The units that are required to forward NBC reports will be designated in the field SOP, OPORD, or OPLAN. Additional units are selected during tactical operations, based on their physical locations. These units may or may not be listed in the OPORD.

(1) **Designated Observers.** All units have some information-gathering responsibilities. Certain units, because of their capabilities and location, are chosen as designated observers for attacks. Designated observers must be as accurate as possible when providing data on enemy releases. Observers are selected to provide total coverage over the entire area of interest (AOI). This requires ground and aerial observers. The designated observer system provides the essential data to prepare the hazard location predictions and the CBRN damage assessments. It provides raw observer data, using a standard report format. The communications section of the OPORD will specify the primary and alternate means of communication.

(a) **Ground.** Ground units are selected for the designated observer system based on the following factors:

- Battlefield location.
- Available communication networks.
- Mission (current and future).
- Training and experience.
- Availability of accurate measuring devices.

(b) **Aerial.** Aircraft provide excellent observer coverage for CBRN attacks. The aviation unit commander selects the crews. Designated aircrews are instructed to report data about the type of attack and when and where it occurred. If the aviators measure the cloud parameters, they must also provide the location from which it was measured. Aviators have the advantage of height. They are able to see and report actual ground zero (GZ) locations. They also can see and estimate the crater width. Such data is usually not obtainable from ground observer units.

(2) **Monitoring, Survey, and Reconnaissance Data.** NBC1 reports are the first step to predict where the CBRN hazards will be. These predictions (NBC3 reports) are only an estimation of the hazard area. Feedback is needed from the reporting units to determine exactly where the contamination is located.

(a) This feedback comes from monitoring, survey, and reconnaissance (NBC4 reports). Monitoring and reconnaissance operations give the initial location of the CBRN hazards. The initial monitoring and reconnaissance reports are forwarded through the intelligence channels to the processing CBRN center or cell. This information may also be sent via integrated C2 systems (i.e, the JWARN).

(b) The NBC4 reports are then plotted on the situation map. If more information is needed, the CBRN staff will direct a unit (picked because of its location and capability) to collect and forward the necessary data. Depending on the type of information required, this unit may be an organic CBRN defense team or a CBRN reconnaissance unit.

(c) The collection of CBRN information is a joint effort between tactical units and the processing CBRN staff. The CBRN staff plans and directs the collection effort. The field SOP, OPORD, or OPLAN will describe who collects and forwards the information for an evaluation.

b. Evaluating Information. After an attack has occurred and the data has been collected, it will be forwarded to, and evaluated by, the CBRN center or cell. It will then be used to update the battlefield intelligence. Units and intermediate HQ may use the raw data that is being reported to develop their own intelligence until detailed results are made available from the CBRN cell.

c. Transmitting Information. Procedures used to transmit information to and from the CBRN cell are an important part of the CBRNWRS. The signal or communications section of the SOP, OPORD, or OPLAN will outline what information is to be sent to what sections. Figure III-1, page III-4, shows the direction that various NBC reports will travel. Usually, the flow of the CBRN data is through the normal chain of command; however, there are some exceptions.

(1) The CBRN center or cell may request information, such as R&S information. The unit doing the survey shall be responsible and will report directly back to the CBRN cell. This is especially true for aerial surveys. The surveying unit should also send a copy back to its parent unit for archiving and recording of the CBRN exposure, if necessary.

(2) The designated observers will send the reports directly to the CBRN cell.

(3) The attached units or operational control units may have no direct contact with a parent unit. In these cases, their HQ will receive the information.

(4) The units that operate independently in an area will report through the HQ controlling that AO.

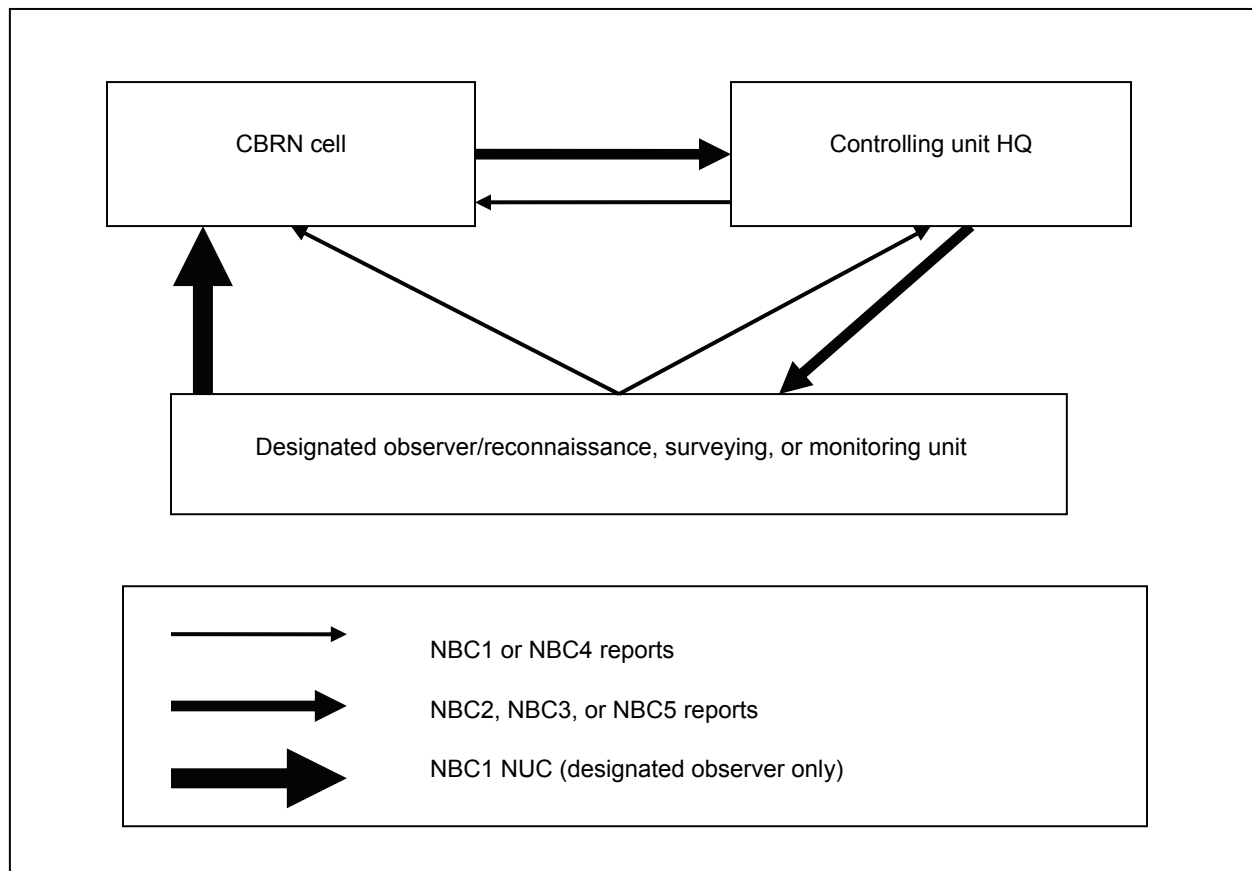

Figure III-1. Flow of NBC Reports

(5) The method of transmitting the information depends on the tactical situation and mission of the unit. Methods will be specified in OPORDs, OPLANs, or unit SOPs.

(6) The NBC reports should be formatted ahead of time and be as short and concise as possible. In this case, wire communications are best.

4. Types of Reports

The CBRNWRS uses standardized reports to effectively organize and disseminate CBRN COP information.

a. **Standard CBRN Reports.** The CBRNWRS consists of six standard reports for CBRN incidents. The STANAG and the US message text format (USMTF) standardize each of the CBRN reports. The United States and its NATO allies use the same message formats. This improves the accuracy, comprehension, and interoperability of the system. It also increases the speed of dissemination and submission. The standard NBC reports are as follows:

(1) The NBC1 report is an observer's report. This report gives the basic data of the CBRN attack.

(2) The NBC2 report is used to pass evaluated data from the collected NBC1 reports.

(3) The NBC3 report is used to provide immediate warning of the predicted contamination and hazard areas.

(4) The NBC4 report is used to report detection data and pass monitoring and survey results. This report is used if an attack is not observed and the first indication of the contamination is by detection.

(5) The NBC5 report is used to pass information of an actual contamination. This report can also include areas of possible contamination, but only when the actual contamination coordinates are also included in the report.

(6) The NBC6 report is used to pass detailed information of the CBRN events.

(7) The CBRN reports use a standard format and line items to shorten the message (see Table III-1). The CBRNWRS is based on a code letter system. The meaning of each letter used to transmit an NBC report is described in this MTTP. Each type of NBC report is comprised of a sequence of lines and has a unique identifier. Letter formats for the CBRNWRS and the meaning of the lines are described below in Table III-1 and in the applicable appendix for the specific type of report. Each set contains a sequence of fields. NBC reports start with a common message heading consisting of the NBC report number (1–6), and the event. The format for the fields, allowable entries, and conditions are explained later in this chapter and the applicable appendixes.

Table III-1. Standard Format and Line Items

| Line: | MEANING: |
|-----------------|---|
| ALFA | Strike serial number |
| BRAVO | Location of the observer and the direction of the attack or event |
| CHARLIE | DTG of the report or observation and end of the event |
| DELTA | DTG of attack or detonation and attack end |
| FOXTROT | Location of the attack or event |
| GOLF | Delivery and quantity information |
| HOTEL | Type of nuclear burst |
| INDIA | Release information on the CB agent attacks or ROTA events |
| JULIET | Flash-to-bang time (in seconds) |
| KILO | Crater description |
| LIMA | Nuclear burst angular cloud width at H+5 minutes |
| MIKE | Stabilized cloud measurement at H+10 minutes |
| MIKER | Description and status of ROTA event |
| NOVEMBER | Estimated nuclear yield (in kilotons) |

Table III-1. Standard Format and Line Items (Continued)

| Line: | MEANING: |
|----------------|--|
| OSCAR | Reference DTG for the estimated contour lines |
| PAPAA | Predicted attack or release and hazard area |
| PAPAB | Detailed fallout hazard prediction parameters |
| PAPAC | Radar-determined external contour of the radioactive cloud |
| PAPAD | Radar-determined downwind direction of the radioactive cloud |
| PAPAX | Hazard area location for the weather period |
| QUEBEC | Location of the reading, sample, and detection and the type of reading, sample, or detection |
| ROMEO | Level of contamination, dose rate trend, and decay rate trend |
| SIERRA | DTG of the reading or initial detection of the contamination |
| TANGO | Terrain or topography and vegetation description |
| WHISKEY | Sensor information |
| XRAYA | Actual contour information |
| XRAYB | Predicted contour information |
| YANKEE | Downwind direction and downwind speed |
| ZULU | Actual weather conditions |
| GENTEXT | General text |

b. The Merchant Warning System (MERWARN). A simplified contamination warning system has been established throughout NATO for broadcasting warnings of a contamination dangerous to the merchant shipping. This system calls for the origination of five types of messages by NATO naval authorities.

(1) MERWARN NBC Effective Downwind Message (EDM). The MERWARN NBC EDM is a prediction of the fallout that will result from a 1-megaton (mt) nuclear surface explosion in a specified sea area at a specified time. It will give the master of a ship, observing a nuclear explosion, an immediate indication of the area likely to be affected by fallout.

(2) MERWARN NBC3 Nuclear. This message will be issued after a nuclear attack and gives fallout data for a specific nuclear explosion or series of explosions, which will be identified in the message.

(3) MERWARN NBC Chemical Downwind Message (CDM). This contains a forecast of the MET data needed for the chemical hazard area prediction procedure.

(4) MERWARN NBC3 Chemical. This message is issued to pass immediate warning of a predicted chemical contamination and hazard area.

(5) MERWARN Diversion Order. This is a general diversion order, based upon the fallout threat, whereby merchant ships proceeding independently are passed evasive routing instructions of a general nature.

NOTE: In some cases, it may be better to provide warning of a contamination by means of general plain language messages rather than by the formats above. See Appendix C for more information on CB MERWARN messages and Appendix G for more information on nuclear MERWARN messages.

c. Strike Warning (STRIKWARN). Friendly forces need to receive advanced warning of a nuclear strike to ensure that they are not placed at unnecessary risk. Such attacks are announced through a STRIKWARN message. This message applies to nuclear strikes that may affect forces operating on land, over land, or at sea. STRIKWARN messages typically use automatic data processing (ADP) messages, but can use alternate means of communication to transmit warnings using the STRIKWARN format. Appendix I of this manual covers STRIKWARN in more detail.

d. MET and Weather Reports. Current MET data is a vital prerequisite for radiological fallout and CB and ROTA downwind hazard prediction. MET data is transmitted as a basic wind report (BWR). The effective downwind report (EDR) and the chemical downwind report (CDR) are prepared at the CBRN control center and are disseminated to all units served by the preparing CBRN control center.

(1) BWR. A BWR is a basic wind message (BWM) or a basic wind forecast (BWF). This message contains the basic MET data to be used for a fallout prediction (see Appendix D). A BWR is an ADP-formatted message used to accommodate the BWM or the BWF when transmitted.

(2) EDR. An EDR is an EDM or an effective downwind forecast (EDF). This message contains information on downwind speed and downwind direction for each of seven preselected nuclear weapon yields (see Appendix I). An EDR is an ADP-formatted message used to accommodate the EDM or the EDF message when transmitted.

(3) CDR. A CDR is a CDM or a chemical downwind forecast (CDF). This message contains basic MET information for predicting a biological aerosol (see Appendix E) and chemical vapor hazard area (see Appendix F). A CDR is an ADP-formatted message used to accommodate the NBC CDM or the NBC CDF message when transmitted.

5. Mandatory Entries in Nuclear, Biological, and Chemical Reports

In order to process and evaluate the CBRN attack data quicker and with more efficiency, ensure that the information is valid and assist in manually inputting the data into the automated systems (each line has mandatory information that must be entered for the NBC message to be properly formatted). Certain rules apply to all lines or messages and are as follows (see Table III-2, page III-8, for information required by line):

a. The field contents are described by one of the following: A = alphabetic, N = numeric, S = special characters (e.g., &, *), B = blank, and X = any code. Combinations of the codes exist in some fields.

b. The fields must be filled with the number and the type of characters identified, or a dash (-) may be inserted into a field when the information is not available. However, some fields vary in length, which is indicated by giving a range for the number of characters (e.g., 1-20X).

c. When a line is repeatable, this is indicated by a preceding asterisk (e.g., *=3). This indicates that data can be entered up to three times.

- d. If a repeatable line is used, then all fields within that line must be used each time that line is repeated.
- e. In manual procedures, all information under one set is put into one sentence.
- f. In STRIKWARN messages, the units of measurement are default values and are, therefore, excluded from the fields.
- g. All directional/angular measurements must be stated in degrees (3N) or mils (4N) (i.e., 40 degrees = 040, 18 mils = 0018).
- h. Sets or fields are mandatory (M), operationally determined (O), or conditional (C).

Table III-2. Required Information by Line

| | |
|--|--|
| ALFA | Strike Serial Number |
| /- /- // | (O) Grading of message/report, 1-3N |
| | (M) Type of incident*, 1-2A |
| | (M) Sequence number, 1-10X |
| | (M) Code for originator, 1-6X |
| | (M) Nationality, 2A or: |
| | (M) Area control center code, 2-3AN |
| *N=Nuclear Attack, B=Biological Attack, C=Chemical Attack, RN=Nuclear ROTA, RB=Biological ROTA, RC=Chemical ROTA, RU=Unidentified ROTA | |
| BRAVO | Location of the Observer and Direction of the Attack or Event |
| /- /- // | (M) Direction of Attack or Event from Observer and Unit of Measurement (see paragraph 5g), 6-7AN Location of Observer, one of the following: |
| | (M) Geographic Place Name, 1-30 X, or (M) Geographic Position, LAT/LONG, Seconds, 15AN, or |
| | (M) Geographic Position, UTM 10-Meter, 13AN, or |
| | (M) Geographic Position, LAT/LONG, Minutes, 11AN, or |
| | (M) Geographic Position, UTM 100-Meter, 11AN |
| CHARLIE | DTG of Report or Observation and End of Event |
| /- /- // | (O) DTG Event ended in Zulu Time, Month, and Year, 14AN |
| | (M) DTG of Report or Observation in Zulu Time, Month, and Year, 14AN |
| DELTA | DTG of Attack or Detonation and Attack End |
| /- /- // | (O) DTG Attack ended in Zulu Time, Month, and Year, 14AN |
| | (M) DTG of Attack or Detonation in Zulu Time, Month, and Year, 14AN |
| FOXTROT | Location of Attack or Event |
| /-* /- // (* = 6) | (M) Location Qualifier (AA=Actual Area, EA=Estimated Area), 2A |
| | Attack or Event Location, one of the following: |
| | (M) Geographic Place Name, 1-30X, or |
| | (M) Geographic Position, LAT/LONG, Seconds, 15AN, or |
| | (M) Geographic Position, UTM 10-Meter, 13AN, or |
| | (M) Geographic Position, LAT/LONG, Minutes, 11AN, or |
| | (M) Geographic Position, UTM 10-Meter, 11AN |
| | Explanation of Repeatable Field |
| | Line FOXTROT: Fields 1-2 are repeatable to accommodate up to 6 data entries in order to define a line or area attack. |

Table III-2. Required Information by Line (Continued)

| | | | | |
|---|---|-----|----|--|
| GOLF | Delivery and Quantity Information | | | |
| /- /- | /- | /- | /- | // |
| | | | | (M) Number of Agent Containers, 1-3N, or |
| | | | | (M) Size of Release*, 3A |
| | | | | (M) Type of Agent C Containers**, 3A |
| | | | | (M) Number of Delivery Systems, 1-3N |
| | | | | (M) Type of Delivery***, 3A |
| | | | | (M) Suspected/Observed Event (SUS=Suspected, OBS=Observed), 3A |
| <p>*SML (Less than 200 Liters or 200 Kilograms), LRG, XLG (More than 1,500 Liters or Kilograms), UNK=Unknown **BML=Bomblets, BOM=Bomb, BTL=Pressurized Gas Bottle, BUK=Bunker, CON=Generic Storage Container, DRM=Nominal 55-gallon Storage Drum, GEN=Generator (Aerosol), MSL=Missile, RCT=Reactor, RKT=Rocket, SHL=Shell, SPR=Spray (tank), STK=Stockpile, TNK=Storage Tank, TOR=Torpedo, MNE=Mine (NBC-filled only), UNK=Unknown, WST=Waste ***AIR=Aircraft, BOM=Bomb (delivering bomblets only), CAN=Cannon, MLR=Multiple-Launched Rocket System, MSL=Missile, MOR=Mortar, PLT=Plant, RLD=Railroad Car, SHP=Ship, TPT=Transport, UNK=Unknown</p> | | | | |
| HOTEL | Type of Nuclear Burst | | | |
| /- // | | | | |
| | (M) Type of Nuclear Burst (AIR, SUBS, SURF, UNK), 3-4A | | | |
| INDIA | Release Information CB Agent Attacks or ROTA Events | | | |
| /- /- | /- | /-* | // | (* = 2) |
| | | | | (O) Type of Detection*, 3-5A |
| | | | | (O) Type of Persistency**, 1-3A |
| | (O) Type of Agent (see Table III-3, page III-14), 1-4A or | | | |
| | (O) Agent Name (see Table III-4, page III-15), 1-4A or | | | |
| | (O) UN/NA Identification Number (see ERG), 4N | | | |
| | (M) Type of Agent-Release-Height (AIR, SUBS, SURF, UNK), 3-4A | | | |
| Explanation of Repeatable fields. | | | | |
| Line INDIA: Field 4 is repeatable to accommodate up to 2 entries in order to provide information on multiple types of detection. | | | | |
| *OTH=Other (use GENTEXT to specify), MPDS=Manned Point Detection System, UMPDS=Unmanned Point Detection System, MSDS=Manned Standoff Detection System, UMSDS=Unmanned Standoff Detection System, MSVY=Manned Survey, UMSVY=Unmanned Survey** P=Persistent, NP=Nonpersistent, T=Thickened, UNK=Unknown | | | | |
| JULIET | Flash-to-Bang Time in Seconds | | | |
| /- // | | | | |
| | (M) Flash-to-Bang Time in Seconds, 1-3N | | | |
| KILO | Crater Description | | | |
| /- /- | // | | | |
| | (O) Crater Width and Unit of Measurement*, 2-7AN | | | |
| | (M) Crater Indicator (CRATER=Crater present, NONE=No crater present, UNK=Unknown), 3-6A | | | |
| *KM=Kilometers, NM=Nautical Miles, FT=Feet, KF=Kilofeet (1,000 feet), HM=Hectometres (100 meters), YD=Yards, M=Meters, SM=Statute Miles | | | | |
| LIMA | Nuclear Burst Angular Cloud Width at H+5 Minutes | | | |
| /- // | | | | |
| | (M) Angular Cloud Width (at H + 5 Min) and Unit of Measurement (DEG or MIL), 6-7 AN | | | |
| MIKE | Stabilized Cloud Measurement at H+10 Minutes | | | |
| /-* | /- | /- | // | (* = 2) |
| | (M) Cloud Height and Unit of Measurement, 2-7AN | | | |
| | (M) Cloud Angle and Unit of Measurement (MIL or DEG), 6-7AN | | | |
| | (M) Cloud Section (TOP or BOT), 3A | | | |
| Explanation of Repeatable Field | | | | |
| Line MIKE: Fields 1-3 are repeatable to accommodate up to 2 data entries in order to describe the cloud height and/or the cloud angle for cloud top and/or for cloud bottom. | | | | |

Table III-2. Required Information by Line (Continued)

| | |
|-----------------|--|
| MIKER | Description and Status of ROTA Event |
| /-/- // | (M) Status of ROTA Event (PUFF=Single Release of a Cloud, CONT=Continuous) SPRAY=Spraying) 4-5A (M) Description of ROTA Event*, 4-6A * CLOUD =Visible Cloud, FIRE =Burning Fire, POOL =Large Quantity of Still Liquid, LEAK =Continuous Flow from Damaged Pipe or Container, SPILL =Small Quantity of Still Liquid, LIQUID =Liquid |
| NOVEMBER | Estimated Nuclear Yield in Kilotons |
| /-// | (M) Estimated Nuclear Yield in Kilotons, 1-6NS |
| OSCAR | Reference Date Time Group for Estimated Contour Lines |
| /-// | (M) Reference Date-Time Group for estimated contour lines in Zulu Time, Month, and Year, 14AN |
| PAPAA | Predicted Attack/Release and Hazard Area |
| /- /- /- // | (M) Duration of Hazard in Hazard Area and Unit of Measurement*, 5-8ANS (M) Hazard Area Distance (see Appendix E for CHEM or Appendix F for BIO) and Unit of Measurement (M, KM, YD), 2-7 AN (M) Duration of Hazard in Attack or Release Area and Unit of Measurement*, 5-8ANS (M) Attack or Release Area Radius and Unit of Measurement (M, KM, FT), 2-7AN * DAY =Days, HR =Hours, MIN =Minutes, SEC =Seconds, WK =Weeks, MON =Month |
| PAPAB | Detailed Fallout Hazard Prediction Parameters |
| /- /- /- // | (M) Right Radial Line and Unit of Measurement*, 6-7AN (M) Left Radial Line and Unit of Measurement*, 6-7AN (M) Cloud Radius and Unit of Measurement, 3-4AN (M) Downwind Distance of Zone I and Unit of Measurement, 4-5AN (M) Effective Wind Speed and Unit of Measurement (MPS=Meters per Second, KPH=Kilometers per Hour, KTS=Knots, MPH=Miles per Hour), 6AN * DGM =Degrees/Magnetic North, DGT =Degrees/True North, DGG =Degrees/GN, MLM =Mils/Magnetic North, MLT =Mils/True North, MLG =Mils/GN |
| PAPAC | Radar Determined External Contour of Radioactive Cloud |
| /-* // (* = 6) | External Contour of Radioactive Cloud, one of the following: (M) Geographic Position, LAT/LONG, Seconds, 15AN, or (M) Geographic Position, UTM 10-Meter, 13AN, or (M) Geographic Position, LAT/LONG, Minutes, 11AN, or (M) Geographic Position, UTM 100-Meter, 11AN Explanation of Repeatable Fields Set PAPAC: Field 1 is repeatable to accommodate up to 6 entries in order to describe the radioactive cloud outline. |
| PAPAD | Radar Determined Downwind Direction of Radioactive Cloud |
| /-// | (M) Downwind Direction of Radioactive Cloud and Unit of Measurement*, 6-7 AN * DGM =Degrees/Magnetic North, DGT =Degrees/True North, DGG =Degrees/GN, MLM =Mils/Magnetic North, MLT =Mils/True North, MLG =Mils/GN |

Table III-2. Required Information by Line (Continued)

| |
|---|
| <p>PAPAX** Hazard Area Location for Weather Period (**=3) /- /-* // (* = 20) Hazard Area Location, one of the following: (M) Geographic Position, LAT/LONG, Seconds, 15AN, or (M) Geographic Position, UTM 10-Meter, 13AN, or (M) Geographic Position, LAT/LONG, Minutes, 11AN, or (M) Geographic Position, UTM 100-Meter, 11AN (M) Date-Time Group of Start of Meteorological Period in Zulu Time, Month, and Year, 14AN</p> <p>PAPAX is repeatable up to 3 times in order to describe three possible hazard areas corresponding to the time periods from the CDM. A hazard area for a following time period will always include the previous hazard area.</p> <p>Field 2 is repeatable up to 20 times in order to describe the hazard area outline.</p> <p>NOTE: If the hazard area location has only one position, draw a circle with a radius of the (remaining) hazard area distance from line PAPAA. If the hazard area location has only two positions, these are the extreme ends of a linear attack. For each point, draw a circle with a radius of the (remaining) hazard area distance from line PAPAA and connect the circles by two tangents.</p> |
| <p>QUEBEC* Location of Reading/Sample/Detection and Type of Sample/Detection (* = 20) /-/- /- /- //</p> <p> ((O) Height of Measurement Above Ground Level and Unit of Measurement, 2-7AN (M) Type of Detection*, 3-5A (M) Type of Sample**, 1-5A</p> <p>Location of Reading/Sample/Detection, one of the following: (M) Geographic Position, LAT/LONG, Seconds, 15AN, or (M) Geographic Position, UTM 10-Meter, 13AN, or (M) Geographic Position, LAT/LONG, Minutes, 11AN, or (M) Geographic Position, UTM 100-Meter, 11AN</p> <p>QUEBEC is repeatable up to 20 times in order to describe multiple detectors and monitoring or survey points.</p> <p>*OTH=Other (use GENTEXT to specify), MPDS=Manned Point Detection System, UMPDS=Unmanned Point Detection System, MSDS=Manned Standoff Detection System, UMSDS=Unmanned Standoff Detection System, MSVY=Manned Survey, UMSVY=Unmanned Survey</p> <p>**LIQ=Liquid sample, VAP=Vapor, SOIL=Soil Sample, SOLID= Solid Sample, VEG=Vegetation Sample, WATER=Water Sample</p> |

Table III-2. Required Information by Line (Continued)

| |
|--|
| <p>ROMEO* Level of Contamination, Dose Rate Trend, and Decay Rate Trend. (* = 20)</p> <p>/-/- /- //</p> <p> (O) Relative Decay Rate (DN=Normal, DF=Fast, DS=Slow), 2A, or</p> <p> (O) Actual Decay Rate, 3-4NS</p> <p> (O) Dose Rate*, 4A</p> <p>(M) Level of Dose Rate/Dosage and Unit of Measurement**4-12ANS, or</p> <p>(M) Level of Dose and Unit of Measurement***, 4-12ANS, or</p> <p>(M) Level of Contamination and Unit of Measurement***4-12ANS, or</p> <p>(M) Miosis****, 4-5A</p> <p>Line is repeatable up to 20 times in order to describe multiple detection and monitoring or survey points.</p> <p>*BACK=Background, DECR=Decreasing, INCR=Increasing, INIT=Initial, SAME=Same, PEAK=Peak</p> <p>**CFU=Colony-Forming Units, CGH=Centigray Per Hour, CSH=Centisievert Per Hour, MSH=Millisievert Per Hour, USH=Microsievert Per Hour, BQS=Becquerel, MM3=Milligram-Minutes Per Cubic Meter</p> <p>***CGY=Centigray, CSV=Centisievert, MGY=Milligray, MSV=Millisievert, USV=Microsievert</p> <p>****ACPL=Agent-Containing Particles per Liter, BQM2=Becquerel per Square Meter, BQM3=Becquerel per Cubic Meter, MGM2=Milligrams per Square Meter, MGM3=Milligrams per Cubic Meter, PPM=Parts per Million (10^6), PPB=Parts per Billion (10^9)</p> <p>*****LDXX=Lethal Dose xx = LD₁ to LD₉₉, IDXX=Incapacitating Dose xx = ID₁ to ID₉₉, ICTXX=Incapacitating Dosage xx = ICt₁ to ICt₉₉, LCTXX=Lethal Dosage xx = LCt₁ to LCt₉₉, MCTXX=Eye-Affecting Dosage xx (Miosis) = MCt₁ to MCt₉₉</p> |
| <p>SIERRA* DTG of Reading or Initial Detection of Contamination (* = 20)</p> <p>/-//</p> <p>(M) DTG, Contamination Detected in Zulu Time, Month, and Year, 14AN, or</p> <p>(M) DTG of Reading in Zulu Time, Month, and Year, 14AN</p> <p>SIERRA is repeatable up to 20 times in order to describe multiple detection and monitoring or survey points.</p> |
| <p>TANGO* Terrain/Topography and Vegetation Description (* = 20)</p> <p>/-/- //</p> <p> (M) Vegetation Description*, 3-5A</p> <p>(M) Terrain/Topography Description**, 3-6 A</p> <p>TANGO is repeatable up to 20 times in order to describe multiple detection and monitoring or survey points.</p> <p>*BARE=Bare, SCRUB=Scrubby Vegetation, WOODS=Wooded Terrain, URBAN=Urban, UNK=Unknown</p> <p>**FLAT=Flat, URBAN=Urban, HIL=Hill, SEA=Sea, VALLEY=Valley, UNK=Unknown</p> |
| <p>WHISKEY Sensor information</p> <p>/-/- /- /- //</p> <p> (O) Assurance Level of Results, (LOW, MED, HIGH), 3-4A</p> <p> (O) Confirmatory Test (Y or N), 1A</p> <p> (M) Nonspecific Potential Harmful Result (POS or NEG), 3A</p> <p>(M) Generic Alarm Result (POS or NEG), 3A</p> <p>WHISKEY format is prepared for future use. Procedures on how to use it will follow later.</p> |

Table III-2. Required Information by Line (Continued)

| |
|---|
| <p>XRAYA** Actual Contour Information (** = 50)</p> <p>/- /-* // (*=50)</p> <p> Limit Contour Line or Area of Contamination, one of the following:</p> <p> (M) Geographic Position, LAT/LONG, Seconds, 15AN, or</p> <p> (M) Geographic Position, UTM 10-Meter, 13AN, or</p> <p> (M) Geographic Position, LAT/LONG, Minutes, 11AN, or</p> <p> (M) Geographic Position, UTM 100-Meter, 11AN</p> <p>(M) Level of Dose Rate/Dosage and Unit of Measurement*, 4-12ANS, or</p> <p>(M) Level of Dose and Unit of Measurement**, 4-12 ANS, or</p> <p>(M) Level of Contamination and Unit of Measurement***, 4-12ANS, or</p> <p>(M) Level of Hazard****, 4-5AN, or</p> <p>(M) Miosis****, 4-5AN</p> <p>Field 2 is repeatable to accommodate up to 50 data entries in order to describe respective contour lines.</p> <p>XRAYA is repeatable up to 50 times to represent multiple contours.</p> <p>*CFU=Colony-Forming Units, CGH=Centigray per Hour, CSH=Centsievert per Hour, MSH=Millisievert per Hour, USH=Microsievert per Hour, BQS=Becquerel, MM3=Milligram-Minutes per Cubic Meter</p> <p>**CGY=Centigray, CSV=Centsievert, MGY=Milligray, MSV=Millisievert, USV=Microsievert</p> <p>****ACPL=Agent-Containing Particles per Liter, BQM2=Becquerel per Square Meter, BQM3=Becquerel per Cubic Meter, MGM2=Milligrams per Square Meter, MGM3=Milligrams per Cubic Meter, PPM=Parts per Million (10^6), PPB=Parts per Billion (10^9)</p> <p>****LDXX=Lethal Dose xx = LD₁ to LD₉₉, IDXX=Incapacitating Dose xx = ID₁ to ID₉₉, ICTXX=Incapacitating Dosage xx = ICt₁ to ICt₉₉, LCTXX=Lethal Dosage xx = LCt₁ to LCt₉₉, MCTXX=Eye-Affecting Dosage xx (Miosis) = MCt₁ to MCt₉₉</p> |
| <p>XRAYB** Predicted Contour Information (** = 50)</p> <p>/- /- /-* // (*=50)</p> <p> Limit Contour Line or Area of Contamination, one of the following:</p> <p> (M) Geographic Position, LAT/LONG, Seconds, 15AN, or</p> <p> (M) Geographic Position, UTM 10-Meter, 13AN, or</p> <p> (M) Geographic Position, LAT/LONG, Minutes, 11AN, or</p> <p> (M) Geographic Position, UTM 100-Meter, 11AN</p> <p> (M) Level of Dose Rate/Dosage & Unit of Measurement*, 4-12ANS or</p> <p> (M) Level of Dose and Unit of Measurement**, 4-12 ANS or</p> <p> (M) Level of Contamination and Unit of Measurement***, 4-12ANS</p> <p> (M) Level of Hazard****, 3-5AN, or</p> <p> (M) Miosis****, 5A</p> <p>(M) Type of Contour*****, 2N</p> <p>Field 3 is repeatable to accommodate up to 50 data entries in order to describe respective contour lines.</p> <p>XRAYB is repeatable up to 50 times to describe multiple contours or segments.</p> <p>*CFU=Colony-Forming Units, CGH=Centigray per Hour, CSH=Centsievert per Hour, MSH=Millisievert per Hour, USH=Microsievert per Hour, BQS=Becquerel, MM3=Milligram-minutes per Cubic Meter</p> <p>**CGY=Centigray, CSV=Centsievert, MGY=Milligray, MSV=Millisievert, USV=Microsievert</p> <p>****ACPL=Agent-Containing Particles per Liter, BQM2=Becquerel per Square Meter, BQM3=Becquerel per Cubic Meter, MGM2=Milligrams per Square Meter, MGM3=Milligrams per Cubic Meter, PPM=Parts per Million (10^6), PPB=Parts per Billion (10^9)</p> <p>****LDXX=Lethal Dose xx = LD₁ to LD₉₉, IDXX=Incapacitating Dose xx = ID₁ to ID₉₉, ICTXX=Incapacitating Dosage xx = ICt₁ to ICt₉₉, LCTXX=Lethal Dosage xx = LCt₁ to LCt₉₉, MCTXX=Eye-Affecting Dosage xx (Miosis) = MCt₁ to MCt₉₉</p> <p>*****01 through 99=Probability in percent terms of exceeding value in Field 2 of Set XRAYB</p> |

Table III-2. Required Information by Line (Continued)

| |
|---|
| <p>YANKEE* Downwind Direction and Downwind Speed (* = 20) /- /- // (M) Downwind Speed and Unit of Measurement, 4-6AN (M) Downwind Direction and Unit of Measurement, 6-7AN</p> <p>YANKEE is repeatable up to 20 times in order to describe multiple detection and monitoring or survey points.</p> |
| <p>ZULU* Actual Weather Conditions (* = 20) /- /- /- /- // (M) Cloud Coverage*, 1N (M) Significant Weather Phenomena**, 1AN (M) Relative Humidity Range***, 1N (M) Surface Air Temperature and Unit of Measurement (-48F, 27C), 2-4ANS (M) Detailed Air Stability Category****, 1N or (M) Simplified Air Stability Category, (U=unstable, N=neutral, or S=stable), 1A</p> <p>ZULU is repeatable up to 20 times in order to describe multiple detection and monitoring or survey points.</p> <p>*0=Less than half covered (scattered), 1=More than half covered (broken), 2=Completely covered (overcast), 3=No clouds (clear conditions) **0=No Significant Weather Phenomena, 1=Sea Breeze, 2=Land Breeze, 3=Blowing Snow, Sand Storm, Dust Storm, 4=Fog, Ice Fog, Thick Haze (visibility less than 4 km), 5=Drizzle, 6=Rain, 7=Snow, Rain, Snow mixed (no shower), 8=Showers of Rain, Snow, Rain and Snow mixed, Hail, 9=Thunderstorm with or without Precipitation, A=Top of inversion layer lower than 800 M, B=Top of inversion layer lower than 400 M, C=Top of inversion layer lower than 200 M</p> <p>***0=0-9 Percent, 1=10-19 Percent, 2=20-29 Percent, 3=30-39 Percent, 4=40-49 Percent, 5=50-59 Percent, 6=60-69 Percent, 7=70-79 Percent, 8=80-89 Percent, 9=90-100 Percent</p> <p>****1=Very Unstable, 2=Unstable, 3=Slightly Unstable, 4=Neutral, 5=Slightly Stable, 6=Stable, 7=Very Stable</p> |
| <p>GENTEXT General Text (unlimited free text). /- /- // (M) Free Text, Unlimited X (M) Text Indicator, (NBC INFO or NBC SITREP), 1-61X</p> |

Table III-3. Types of Agents

| Nuclear | | Biological | | Chemical | |
|----------------|---------------------------------------|-------------------|---------------------------------------|-----------------|---------------------------------------|
| NIL | No agent detected (only used in NBC4) | BIO | Biological | BL | Blister agent |
| OTR | Other agent | NIL | No agent detected (only used in NBC4) | BLOD | Blood agent |
| RNP | ROTA nuclear power plant | OTR | Other agent | CHOK | Choking agent |
| TIM | TIM | TIM | TIM | G | G agent |
| UNK | Unknown | TOX | Toxin | H | Mustard agent |
| | | UNK | Unknown | INCP | Incapacitating agent |
| | | BAC | Bacterial | IRT | Irritant |
| | | CLA | Chlamydia | NERV | Nerve agent |
| | | RIC | Rickettsiae | NIL | No agent detected (only used in NBC4) |

Table III-3. Types of Agents (Continued)

| Nuclear | | Biological | | Chemical | |
|---------|--|------------|-------|----------|-------------------|
| | | VIR | Viral | OTR | Other agent |
| | | | | PENT | Penetrating agent |
| | | | | TIM | TIM |
| | | | | UNK | Unknown |
| | | | | V | V agent |
| | | | | VMT | Vomiting agent |

Table III-4. Agent Name

| Nuclear | | Chemical | |
|---------|------------------------|----------|-------------------------|
| ALP | Alpha | AC | Hydrogen cyanide |
| BETA | Beta | BZ | Quinuclidinyl benzilate |
| GAM | Gamma | CG | Phosgene |
| NEU | Neutron | CK | Cyanogen chloride |
| COB | Cobalt-60 | CX | Phosgene oxime |
| CES | Cesium-137 | DP | Di-phosgene |
| FF | Fresh reactor fuel | GA | Tabun |
| FL | Nuclear weapon fallout | GB | Sarin |
| IO | Iodine | GD | Soman |
| OF | Spent reactor fuel | GF | Cyclo-Sarin |
| PU | Plutonium | HD | Mustard distilled |
| | | HL | Mustard-lewisite |
| | | HN | Nitrogen mustard |
| | | HT | Trimeric mustard |
| | | L | Lewisite |
| | | PS | Chloropicrin |
| | | SA | Arsin |
| | | TG | Tear gas |
| | | VX | VX |

NOTE: If the biological agent identity is known, enter it in GENTEXT set.

6. Classification and Precedence

The classification and precedence of the CBRN messages ensure that they are disseminated in a timely and effective manner.

- a. Classification. Unless the NBC message contains specific operational information (e.g., effects on troops), all such messages should be unclassified.
- b. Precedence. NBC1 messages reporting the first enemy use of CBRN weapons (first use of nuclear weapons, first use of biological weapons and first use of chemical weapons) or ROTA incidents must be given FLASH precedence. All other messages should be given a precedence that reflects the operational value of the contents. Normally, IMMEDIATE would be appropriate. Once a CBRN event occurs, the number of NBC messages will be substantial. CBRN staffs must prepare their SOPs carefully in order to avoid an unnecessary load on the communication systems.

7. Decision Support Tools

Collecting, evaluating, processing, and relaying all the reports from the field can be an extremely difficult and time-consuming task when done manually. In order to help reduce the number of errors and expedite the process, the United States Government (USG) has developed various modeling programs and systems to help commanders make more informed decisions quicker and more accurately. There are a large number of models

available through various Department of Defense (DOD) and other federal agencies. Models are volatile and dynamic; therefore, considerable expertise is required to avoid misuse or misreading of the results. For additional information on models, refer to the Modeling and Simulation Information Analysis Center Web site <www.msiaac.dmsso.mil>.

8. Technical Reach-Back Capabilities

The commander will require not only accurate and timely information but also tremendous reach-back capabilities. Reach-back occurs when commanders access the capabilities of remotely located informational resources through their C2 systems. Reach-back is a process that employs communications assets to identify and bring to bear resources that are not present at a CBRN site.

a. General.

(1) Technical reach-back is the ability to contact technical subject matter experts (SMEs) when a technical issue exceeds the on-scene SME's capability. Reach-back should be conducted using established unit protocols. Many of the listed reach-back resources have other primary missions and are not specifically resourced for reach-back. Issues may include the following:

(a) Nonstandard Agent Identification of CBRN and TIM. If a TIM is used or is suspected, CBRN personnel must obtain technical information. This information could include persistency, medical effects, and decontamination or protection requirements.

(b) Modeling/Hazard Prediction. The spread of contamination must be known to operational units. Technical experts can use modeling to provide a better indication of where vapor, liquid, or aerosolized hazards may occur. Technical reach-back should provide the ability for detailed analysis of the area to assist in determining downwind hazard areas and locating staging areas, operation centers, decontamination sites, etc.

(2) Reach-back can be accomplished through various means, from the telephone to broadband satellites.

b. Technical Reach-Back Capabilities. The following technical reach-back capability is available if technical issues exceed on-site, local SME capabilities (see Table III-5). Reach-back should be conducted using established local protocols and SOPs.

Table III-5. Technical Reach-Back Points of Contact

| | |
|------------------------------------|----------------------------|
| DTRA | 877-244-1187 |
| AFRRI | 301-295-0316/0530 |
| Technical CB Assistance Hotline | 877-269-4496 |
| USAMRIID | 888-872-7443 |
| USAMRICD | 800-424-8802 |
| NEPMU | See paragraph 8b(6) |
| NMRC | 301-319-7510 |
| NEHC | See paragraph 8b(7) |
| AFCESA | 850-283-6995, DSN 523-6995 |
| NRC, Chemical Terrorism/CB Hotline | 800-424-8802 |

(1) Defense Threat Reduction Agency (DTRA). The DTRA can provide technical reach-back information and services for on-scene personnel. The focal/coordination point for support is through the DTRA emergency operations center (EOC). The DTRA EOC enables first responders and warfighters to deal with CBRN threats through on-line assistance and provides a wide-band infrastructure for user support. As part of the Combat Support Directorate in DTRA, the EOC is manned 7 days a week, 24 hours a day, and has the requisite communications links to act as the single point of contact (POC) for on-line assistance and the dispatch of other agency resources, as required. For more information on DTRA, visit <<http://www.dtra.mil>>.

(2) Armed Forces Radiobiology Research Institute (AFRRI). The AFRRI can provide DOD technical support for nuclear/radiological incidents or accidents.

(3) Technical CB Assistance Hotline. The USA Soldier and Biological Chemical Command (SBCCOM) hotline provides technical assistance to emergency responders. The hotline is manned and operated 7 days a week, 24 hours a day.

(4) USA Medical Research Institute of Infectious Diseases (USAMRIID). The USAMRIID provides medical and scientific SMEs and technical guidance to commanders and senior leaders on the prevention and treatment of hazardous diseases and the medical management of biological casualties. The USAMRIID serves as the DOD reference center for the identification of biological agents from clinical specimens and other sources. The USAMRIID can provide technical guidance for assessing and evaluating a biological terrorist incident from initial communication of the threat through incident resolution.

(5) USA Medical Research Institute for Chemical Defense (USAMRICD). The USAMRICD provides medical and scientific SMEs and technical guidance to commanders and senior leaders on the prevention and treatment of chemical casualties. The USAMRICD can provide technical guidance for assessing and evaluating a chemical terrorist incident from initial communications of the threat through incident resolution.

(6) Navy Environmental and Preventive Medicine Units (NEPMUs). Regional NEPMUs have the mission to provide specialized consultation, advice, recommendations, and technical support in matters of environmental health, preventive medicine, and occupational safety to USN and USMC shore activities and units of the operational forces within their designated areas of responsibility. An ashore or afloat command requesting guidance related to suspect bioagent material can consult one of the following NEPMUs within their area of responsibility. The units are available on-call 7 days a week, 24 hours a day. The NEPMU staff can provide technical assistance and confirmatory laboratory analysis for biological and chemical agents. They can also provide assistance on requests for additional support teams (CB incident response force, technical escort unit, CB response team, etc). Response teams are deployable within 48 hours upon notification. See OPNAV N931/BUMED M3F for more information. Regional NEPMU locations and contact information are listed below.

- NEPMU-2, Norfolk, VA
(DSN) 564-7671, (COMM) 757-444-7671
Email: <nepmu2@nepmu2.med.navy.mil>
Classified Message Traffic:
NAVENPVNTMEDU TWO NORFOLK VA

- NEPMU-5, San Diego, CA
(DSN) 526-7070, (COMM) 619-556-7070
Email: <nepmu5@nepmu5.med.navy.mil>
Classified Message Traffic:
NAVENPVNTMEDU FIVE SAN DIEGO CA
- NEPMU-6, Pearl Harbor, HI
(DSN) 473-0555, (COMM) 808-473-0555
Email: <nepmu6@nepmu6.med.navy.mil>
Classified Message Traffic:
NAVENPVNTMEDU SIX PEARL HARBOR HI
- NEPMU-7, Sigonella, Italy
(DSN) 314-624-9251, (COMM) +39-095-86-9251
Email: <nepmu7@nepmu7.med.navy.mil>
Classified Message Traffic:
NAVENPVNTMEDU SEVEN SIGONELLA IT

(7) Navy Medical Research Center (NMRC). The NMRC conducts research and development, test and evaluation, and disease surveillance to enhance the health, safety, performance, and deployment medical readiness of the USN and USMC. Its Biological Defense Research Directorate (BDRD) has a staff that is recognized as a leader in the rapid and confirmatory diagnosis of infectious diseases. The BDRD explores basic and applied microbiological, immunological, and related scientific research methodologies for the development of medical diagnostics. The BDRD staff has designed, developed, and tested a broad variety of methodologies that have allowed for swift and accurate diagnosis essential for substantive medical protection and readiness of USN and USMC personnel. They have been instrumental in the advancement and refinement of confirmatory diagnostic methods utilizing polymerase chain reaction (PCR) methodologies in tandem with state-of-the-art biosensor technologies. Additional information is available at the NMRC Web site <<http://www.nmrc.navy.mil>>. The BDRD staff can be contacted via e-mail at <bdrd1@nmrc.navy.mil> or <bdrd2@nmrc.navy.mil>. Subsequent Secret Internet Protocol Router Network (SIPRNET) communications links will be established as requested.

(8) Navy Environmental Health Center (NEHC). The mission of the NEHC is to ensure USN and USMC readiness through leadership in the prevention of disease and promotion of health. The command has specialists in environmental health, radiation health, industrial hygiene, medical entomology, biochemistry, toxicology, and preventive medicine. Chemical, biological, radiological, and environmental medical defense technical support and consultative assistance is available within the Plans and Operations Directorate. The SIPRNET e-mail address is <plansops@nehc.navy.smil.mil>. The command Web site <<http://www.nehc.med.navy.mil>> contains numerous links to additional useful references and instructions.

(9) Air Force Civil Engineer Support Agency (AFCESA). The Full-Spectrum Threat Response (FSTR) Division plans, trains, equips, and conducts USAF FSTR programs that include nuclear, biological, chemical, and conventional (NBCC) weapons of mass destruction (WMDs), HAZMAT incidents, natural disasters, and major accidents. The FSTR Integration Division also coordinates homeland security issues and is the lead US representative for international NBCC defense standardization.

(10) The National Response Center (NRC) mans the hotline service and serves as an emergency resource for first responders to request technical assistance during an incident. The intended users include trained emergency personnel, such as emergency operators and first responders. Other potential users may include the state EOCs and hospitals that may treat victims of agent exposure.

(a) The United States Coast Guard (USCG) operates the NRC, and trained operators staff the hotline 7 days a week, 24 hours a day. Operators use extensive databases and reference material in addition to having immediate access to the nation's top SMEs in the field of CBRN agents. NRC duty officers take reports of actual or potential domestic terrorism and link emergency calls with applicable SMEs (such as USA SBCCOM, USAMRICD) for technical assistance and with the Federal Bureau of Investigation (FBI) for federal-response actions. The NRC also provides reports and notifications to other federal agencies, as necessary. Specialty areas include the following:

- Detection equipment.
- Personal protective equipment.
- Decontamination systems and methods.
- Physical properties of CB agents.
- Toxicology information.
- Medical symptoms from exposure to CB agents.
- Treatment of exposure to CB agents.
- Hazard prediction models.
- Federal-response assets.
- Applicable laws and regulations.

(b) The CB hotline is a joint effort of the USCG, FBI, Federal Emergency Management Agency (FEMA), Environmental Protection Agency (EPA), Department of Health and Human Services (DHHS), and DOD. The NRC is the entry point for the CB hotline. The NRC receives basic incident information and links the caller to the DOD and FBI CB and terrorism experts. These and other federal agencies can be accessed within a few minutes to provide technical assistance during a potential CB incident. If the situation warrants, a federal-response action may be initiated.

(c) Use the local established policies and procedures for requesting federal assistance before contacting the CB hotline. State and local officials can access the hotline in emergency circumstances by calling 1-800-424-8802.

(d) For more information on the NRC, visit <<http://www.nrc.uscg.mil/>>.

9. Avoidance Tools

Conducting CBRN avoidance operations is a complex process. Various tools and TTP have been developed to systematically and accurately prepare for and conduct CBRN avoidance operations.

a. Many of the tools required to conduct CBRN avoidance operations are included in this manual. They are:

CBRN checklists (Appendix A)

CBRN center/cell operations (Appendix B).

Guidance on the management of radiological hazards (Appendix C).

MET reports (Appendix D).

TTP for chemical contamination avoidance (Appendix E).

TTP for biological contamination avoidance (Appendix F).

TTP for nuclear contamination avoidance (Appendix G).

TTP for ROTA contamination avoidance (Appendix H).

Guidance on the use of the STRIKWARN message (Appendix I).

Required nomograms, tables, and graphs (Appendix J).

Calculations used in conducting CBRN avoidance operations (Appendix K).

Example forms used when conducting CBRN avoidance operations (Appendix L).

b. Other TTP specifically designed to support CBRN avoidance operations are found in Multiservice Tactics, Techniques, and Procedures for Nuclear, Biological, and Chemical Reconnaissance; Multiservice Tactics, Techniques, and Procedures for Nuclear, Biological, and Chemical Vulnerability Assessment; and Multiservice Tactics, Techniques, and Procedures for Biological Surveillance.

Appendix A

SAMPLE CHEMICAL, BIOLOGICAL, RADIOLOGICAL, AND NUCLEAR CONTAMINATION AVOIDANCE CHECKLISTS

1. Background

This appendix provides a series of checklists that outline CBRN contamination avoidance procedures. The various checklists are designed to assist commanders and CBRN staff personnel. These checklists are not all-inclusive and may be adapted or modified for local use. Checklist items are not necessarily in chronological order; actions may occur simultaneously, and some may deviate based on the situation. All actions should be considered.

NOTE: These statements are common tasks and actions for CBRN attacks. Use the following checklists along with the specific CBRN tasks and actions in Appendixes E, F, and G to create your unit-specific preattack, during attack, and postattack and recovery checklists.

2. Chemical, Biological, Radiological, and Nuclear Preattack Checklist

Sample preattack tasks and actions and the office(s) of primary responsibility (OPR) are outlined in Table A-1.

Table A-1. Preattack Checklist for CBRN Attacks (Sample)

| Item # | Task/Action | OPR |
|--------|---|-----------------------------|
| 1. | Establish and activate the primary and alternate CBRN cells. | CBRN |
| 2. | Recommend an alarm signal, CBRN threat, protection levels, and FPCON (e.g. Alarm [color], MOPP4, FPCON Delta, missiles inbound, estimated time of arrival 3 minutes). | CBRN |
| 3. | Verify the following with higher HQ: <ul style="list-style-type: none"> • Procedures and timelines on how to receive and disseminate attack warnings. • Reporting procedures (e.g., CBRNWRS procedures and responsibilities, including geographically separated units and joint service, allied, coalition, and HN CBRN defense units). • Establish preformatted or preaddressed CBRNWRS messages. Verify that the base warning system is able to provide attack warning and notification to the base population within 10 minutes. NOTE: Ensure that the operations section has direct access to activate the installation-wide warning network. | CBRN/Operations |
| 4. | Conduct CBRN VA. | Intelligence/ CBRN |
| 5. | Position the CBRN detectors and the ISR assets according to the VA. | CBRN |
| 6. | Review the specific CA actions based on the alarm signal and the type of attack. NOTE: Adjust during-attack actions to conform to local policies and procedures. | CBRN/Operations |
| 7. | Reconfirm that communications with the CBRN defense teams are available for 24-hour operations. | Survival recovery center |
| 8. | Verify the availability of the MET forecast data. | CBRN/Operations |

Table A-1. Preattack Checklist for CBRN Attacks (Sample) (Continued)

| Item # | Task/Action | OPR |
|--------|--|----------------------------------|
| 9. | Ensure that maps and overlays include— <ul style="list-style-type: none"> • Theater missile defense zones. • Friendly forces. • Key facilities and shelters. • CBRN detectors. • CBRN templates. • CBRN reconnaissance routes. | Intelligence/ Operations/CBRN |
| 10. | Determine environmental and medical baselines. | Medical |
| 11. | Provide current information to ensure that all personnel are trained for the CBRN avoidance measures (e.g., alarms, CBRN markers, reporting). | CBRN |
| 12. | Identify and direct the CBRN CA training of noncombatants at overseas locations according to the theater or Department of State directives. | Operations/CBRN |
| 13. | Review the MOA/MOU arrangements with local, state, federal, or HN authorities to ensure that the proper NBCWRS communications and the roles and responsibilities are mutually understood. | Legal/Operations/ CBRN |
| 14. | Coordinate operations on the dispersal of critical assets. | Operations |
| 15. | Direct priority items to be placed inside facilities, under cover, or double-wrapped with plastic sheeting. Shipboard: strike below all porous materials. | Operations/CBRN |
| 16. | Keep windows and doors closed whenever possible. | All |
| 17. | Review during-attack, postattack, and recovery actions checklists, plans, and concepts. | All |

3. Chemical, Biological, Radiological, and Nuclear During-Attack Checklist

Sample during-attack tasks and actions and the OPRs are outlined in Table A-2.

Table A-2. During-Attack Checklist for CBRN Attacks (Sample)

| Item # | Task/Action | OPR |
|--------|--|-----------------|
| 1. | Declare the alarm signal, MOPP level, FPCON, and situation (e.g., Alarm [color], MOPP4, FPCON Delta, missiles inbound, estimated time of arrival 3 minutes). | Operations/CBRN |
| 2. | (Actions for personnel in open areas) <ul style="list-style-type: none"> • Seek the best available protection (e.g., building, bunker). • Move to a ditch, depression, or structure that provides protection from the blast, fragments, and small arms fire if a building or bunker is not available. • Drop to the ground, don the protective mask, crawl to the closest available protection, and don the remaining IPE if no warning is received and an attack begins. • Use any available material to provide overhead cover (e.g., rain gear, poncho, tarp, or plastic). <p>NOTE: Adjust actions to conform to the local policies and procedures.</p> | All |
| 3. | (Actions for vehicle/equipment operators and passengers) <ul style="list-style-type: none"> • Drive to the best available protection within 1 minute, while passengers don IPE. • Move the vehicle or equipment into or under shelter if possible. • Drive near a ditch, depression, or structure that provides protection from the blast, fragments, and small arms fire if no shelter is available. • Exit, take cover, and don IPE. <p>NOTES: 1. For missile attacks only, all personnel remain inside the vehicle or equipment (window up and doors closed) and don IPE. 2. Adjust actions to conform to local policies and procedures.</p> | All |
| 4. | (Actions for aircrews operating aircraft) <ul style="list-style-type: none"> • Taxi tactical aircraft into any available shelter. • Notify passengers to don IPE, and request instructions from ground control if operating large-frame aircraft or shelter is not available for smaller aircraft. <p>NOTE: Adjust actions to conform to the local policies and procedures.</p> | All |
| 5. | Perform buddy checks, ensuring that the IPE is worn correctly. | All |
| 6. | Perform self-aid and buddy care while maintaining a low profile. | All |
| 7. | Close the doors and windows and cover items with plastic if time allows. Monitor and report attack indicators to the CBRN cell. <ul style="list-style-type: none"> • CBRN detector response. • Casualty data. • Environmental data. | All |
| 8. | Turn off the air handlers on the facilities not provided COLPRO. | Logistics |
| 9. | Monitor the overpressure and filtration systems for proper operation. | Logistics |
| 10. | Monitor the CBRNWRS for reports of CBRN attacks. | CBRN/Operations |
| 11. | Monitor intelligence and airborne radar data. | Intelligence |

4. Chemical, Biological, Radiological, and Nuclear Postattack Checklist

Sample postattack tasks and actions and the OPRs are outlined in Table A-3.

Table A-3. Postattack Checklist for CBRN Attacks (Sample)

| Item # | Task/Action | OPR |
|--------|---|--|
| 1. | Declare the alarm signal, MOPP level, FPCON, and situation (e.g., Alarm [color], MOPP4, FPCON Charlie, begin postattack reconnaissance). | Operations/CBRN |
| 2. | Remain in during-attack posture until directed otherwise. | All |
| 3. | Initiate contamination control and decontamination measures. | All |
| 4. | Seek overhead cover, and perform immediate personal decontamination if required. | All |
| 5. | Evaluate the risk of a reattack. | Operations/ Intelligence/ CBRN |
| 6. | Initiate a request for additional DOD resources. | Command |
| 7. | Project follow-on attacks; assess other facilities as sources of assistance, burden, or hazard; and provide threat and target support to unit operations. | Intelligence/ Operations |
| 8. | Determine the attack location. | CBRN |
| 9. | Report information on the status of automated CBRN detection devices (operational status, alarming or silent, and displays). | CBRN |
| 10. | Limit outside movement to teams involved in the identification of hazards and recovery. | Operations/CBRN |
| 11. | Inspect shelters for damage, and report findings to operations/CBRN. | Logistics |
| 12. | Verify the integrity of the filtration and over-pressurization systems. | Logistics |
| 13. | Direct personnel to unmask if system operation remains normal (shelters with filtration systems only). NOTE: Direct personnel to don their protective masks if agent effects are observed. | CBRN/Operations |
| 14. | Periodically check the CCA or entrance to the facility for contamination, and decontaminate as necessary. | CBRN/Operations |
| 15. | Begin postattack reconnaissance operations at the direction of the CBRN cell, and report the following findings: <ul style="list-style-type: none"> • Contamination. • UXO. • Damage. • Fires. • Enemy activity/suspicious personnel, using the SALUTE format. • Enemy casualties and abandoned weapons. • Casualties. | Postattack reconnaissance teams/CBRN |
| 16. | Track and plot reports of casualties, contamination, damage, etc. | CBRN/Operations |
| 17. | Submit the appropriate NBC reports. | CBRN |
| 18. | Warn friendly forces of dangers. | CBRN/Operations/ Intelligence |
| 19. | Track the levels of the contamination, and forward the information to the survival recovery center. | CBRN/ Reconnaissance |

5. Chemical, Biological, Radiological, and Nuclear Recovery Checklist

Sample recovery tasks and actions and the OPRs are outlined in Table A-4.

Table A-4. Recovery Checklist for CBRN Attacks (Sample)

| Item # | Task/Action | OPR |
|--------|---|-------------------------------|
| 1. | Determine the extent of contamination, develop a sampling plan, and conduct the required sampling. | CBRN |
| 2. | Relocate personnel/operations as required. | CBRN/Operations |
| 3. | Identify the type and specifics of contamination. | CBRN/ Reconnaissance |
| 4. | Determine the hazard persistency and the protective measures needed. | CBRN |
| 5. | Reassess and change the MOPP level/alarm signal to the lowest possible level consistent with identified hazards. Recommend split MOPP levels, if appropriate, to continue the mission. | CBRN/Operations |
| 6. | Make recommendations on the need for CCA/automatic chemical-agent alarm operations. | CBRN/Medical |
| 7. | Assess the ability of the installation/units to continue to support the primary unit mission. | Operations |
| 8. | Establish, prioritize, and direct recovery actions to restore mission capability and protect personnel. | Operations/CBRN/ Logistics |
| 9. | Verify the operation of automated CBRN detectors. | CBRN/ Reconnaissance |
| 10. | Take contaminated waste to unit waste-disposal points. | All |
| 11. | Ensure the control of contaminated areas, facilities, and equipment to prevent the spread of contamination. | CBRN/Operations |
| 12. | Track the status of all contaminated items/areas. | CBRN/Operations |
| 13. | Perform operational decontamination on contaminated items as needed. | All |
| 14. | Perform patient decontamination as needed. | CBRN/Medical |
| 15. | Perform vehicle decontamination as needed. | CBRN |
| 16. | Perform aircraft/aerospace ground equipment decontamination as needed. | CBRN |
| 17. | Perform limited area decontamination as needed. | CBRN |
| 18. | Control contaminated runoff from decontamination operations, and transfer it to installation waste collection sites. | CBRN |
| 19. | Obey all restrictions placed on previously contaminated items. NOTE: Low levels of contamination may continue after decontamination and present a hazard to personnel nearby. | All |
| 20. | Ensure the control of contaminated areas, facilities, and equipment to prevent the spread of contamination. | CBRN |
| 21. | Document the agent exposure in medical records. | CBRN/Medical |
| 22. | Brief personnel on the health hazards and protective measures, and monitor the exposures. | CBRN/Medical |
| 23. | Monitor the effectiveness of the decontamination. | CBRN/Medical |
| 24. | Provide environmental protection and remediation advice. | CBRN/Logistics |
| 25. | Advise mortuary affairs on the occupational and environmental concerns regarding the contaminated remains. | CBRN/Operations |
| 26. | Process the human remains using the mortuary processing stations or systems. | Logistics |
| 27. | Review and track the status of the reported damage. | Logistics |

Table A-4. Recovery Checklist for CBRN Attacks (Sample) (Continued)

| Item # | Task/Action | OPR |
|---------------|--|----------------------------|
| 28. | Support the local community according to the higher HQ direction, status of forces agreement, or MOU. Inform the US Embassy. | Operations/Legal |
| 29. | Consider the reconstitution issues for the contaminated items. | CBRN/Medical/ Logistics |
| 30. | Prepare a written record that identifies the location of previously contaminated areas, unrecovered human remains, contaminated-waste burial sites, missile and bomb craters, and unrecovered UXO. | CBRN/Operations |

Appendix B

CHEMICAL, BIOLOGICAL, RADIOLOGICAL, AND NUCLEAR CENTER AND CELL OPERATIONS

1. Background

The CBRN cell is the focal point for all data relating to a CBRN attack or a ROTA event within the established AO. The organizations of the CBRN cells will be theater-, mission- and service-dependent, which is meant to be flexible in size and composition.

2. Responsibilities

The responsibilities of the CBRN staff will vary depending on the echelon where the cell is established. All CBRN cells will have several of the same functions regardless of the established echelon. These common functions include the following:

- Advising the commander and staff on CBRN defense matters.
- Monitoring the subordinate unit's CBRN status.
- Operating the CBRNWRS for the AO where established.
- Assisting with vulnerability analysis.
- Assisting the intelligence section with the identification of CBRN-related intelligence requirements.
- Assisting the intelligence section with the interpretation of CBRN-related intelligence.

a. Theater, Corps, Air Force, and Fleet Levels of Command. The CBRN cells must have an appropriate number of personnel who are equipped, trained, and qualified to perform tasks efficiently and rapidly (see Table B-1 for a sample structure). They must—

Table B-1. CBRN Cell at Theater, Corps, Air Force, or Fleet Level (Sample)

| Duty Position | Shift |
|------------------------------------|---------|
| Senior CBRN staff officer | A and B |
| CBRN staff officer (one per shift) | A |
| Senior NCO/petty officer | A |
| Computer/plotters (two per shift) | A and B |
| Clerk typist (one per shift) | A and B |
| Operations NCO/petty officer | B |

(1) Assess the status and capability of friendly units operating in the CBRN environment.

(a) The CBRN cell evaluates the impact of the CBRN contamination on the tactical operations. The evaluation may include the following information:

- The degree of contamination at selected points or areas.

- The effects of contamination on tactical units.
- The protection required by troops operating in designated

contaminated areas.

The CBRN cell must be prepared to recommend the length of time troops can safely operate within the radiologically contaminated areas. In coordination with the surgeon's staff, the CBRN cell must be prepared to make recommendations about the psychological aspects of prolonged operations in MOPP gear.

(b) The CBRN cell may then recommend the type and quantity of supplies and equipment required to support the decontamination operations. The CBRN cell balances these recommendations with the information received from the contaminated unit and the logistics staff officer on the availability of the supplies and equipment.

(2) Maintain the status and coordination of CBRN support (i.e., decontamination or reconnaissance units).

(a) When information in the AOI is inadequate, the CBRN cell, in cooperation with appropriate support elements, recommends locations for conducting surveys. The CBRN cell may coordinate and control a survey if transportation, communications, and personnel assets are available. The CBRN cell briefs the survey parties and designates the areas to be surveyed. The briefing includes the type, amount, frequency, and means of reporting. For detailed procedures pertaining to monitoring and surveying, see *Multiservice Tactics, Techniques, and Procedures for Nuclear, Biological, and Chemical Reconnaissance*.

(b) The CBRN cells at this level may also be responsible for the organization and implementation of the sampling, identification, and evacuation of the CB agents. This information can be critical in treating patients and confirming an exposure. It can also be used as evidence in a prosecution.

(3) Transmit CBRN warnings (NBC3 report) to the adjacent HQ and to military and civilian agencies when the predicted hazard areas extend beyond the area of responsibility (AOR).

(4) Organize and coordinate the CBRNWRS within the AOs.

(5) Track information on enemy CBRN activities. CBRN personnel prepare an overlay showing the locations, times, number, and extent of enemy CBRN attacks. This overlay provides higher commands with data on the number of attacks or strikes reported and the nuclear yields employed. It also gives a brief assessment of the significance of these strikes.

(6) Make final filtering and correlation of the CBRN incidents within the AO.

b. Area and Maritime HQ. The area and maritime HQ must maintain direct communication with the regional HQ and the appropriate units of the national civil defense organizations concerned. Information and predictions of the land areas that will be affected by the fallout should be passed to the area HQ or the relevant CBRN center. In the same manner, the information on the CBRN and ROTA hazards should be exchanged between the area and maritime HQ.

c. Fixed-Site, Division, Regiment, Brigade, and Designated Shipboard and Wing Levels of Command. The responsibilities at the designated fixed-site, division, regiment, brigade, shipboard and wing levels of command have common duties and responsibilities for a higher and lower echelon CBRN reporting agency. At this level, some of the main duties include the following:

- (1) Receiving, consolidating, and evaluating reports of the following:
 - CBRN attacks.
 - ROTA.
 - Resultant contamination within the AO (for the unit where the center is established).
- (2) Performing computer modeling and simulations. This level has the resources and techniques available to conduct the more involved and complicated procedures. These techniques and procedures are based on the comparison of data from many sources (much of the data used is not available to a single unit).
- (3) Executing tasks in the AO, which have influence on the unit's or subunit's operations. The NBC reports generated or processed at this level will have a line ALPHA (strike serial number).
- (4) Calculating detailed fallout predictions, including recalculations as a result of significant weather changes and passing the appropriate warnings to the units likely to be affected (NBC3 report).
- (5) Directing CBRN reconnaissance and survey efforts within the AO.
- (6) Analyzing the survey and monitoring results and passing the information on the contaminated areas to the units likely to be affected (NBC4 and NBC5 reports).
- (7) Requesting and providing detailed information on the CBRN or ROTA events, as directed (NBC6 report).
- (8) Exchanging CBRN information with the appropriate national, military, and civilian authorities as outlined by directives and SOPs.
- (9) Providing information to merchant shipping on the predicted or actual contamination via MERWARN.
- (10) Maintaining the CBRN situation map. At this level, the CBRN cell plots data from the NBC reports on the tactical situation maps and overlays. These maps and overlays show the actual areas affected by the contamination at a selected time and for a given AOI. The maps and overlays also show the predicted downwind hazard areas. CBRN personnel recompute and adjust the prediction several times daily based on the changes, decay rate, additional contamination, and tactical situation.
- (11) Preparing and disseminating wind messages (see Appendix D).
- (12) Providing technical assistance in the interrogation of prisoners of war. This technical assistance is generally in the form of providing the interrogator with a list of questions to ask the prisoner. The questions may involve employment tactics, CBRN munitions, types of weapon systems available, and defense training status.
- (13) Assisting the commander with the selection of designated observers.

d. **Unit Level of Command and Designated Observers.** The unit level procedures and designated observer's primary concern is the collection of useful data for the CBRN cell and not the detailed analysis or evaluation of the data. The processing and analysis techniques at this level are designed for the rapid evaluation of data. These results are not as accurate as those obtained by the CBRN cell, but are sufficient for planning until they can be replaced. Designated observers are any unit tasked to report and forward information to a CBRN cell, such as CBRN observation posts, survey and reconnaissance teams, and preattack reconnaissance teams. Designated observers and unit level CBRN sections are responsible for—

(1) Reporting the initial enemy use of CBRN weapons by the most expeditious means available in accordance with directives and SOPs (NBC1 report).

(2) Immediately reporting any CBRN incident and subsequent data to the respective CBRN center (NBC1 or NBC4 report).

(3) Reporting detection data, monitoring, reconnaissance and survey results to the respective CBRN cell (NBC4 report).

(4) Plotting simplified hazard predictions (see Appendixes E, F, G, and H for detailed instructions on how to complete them).

(5) Submitting detailed information on CBRN and ROTA events as requested (NBC6 report).

(6) Monitoring for symptoms, radiation, and casualties.

(7) Collecting and forwarding samples.

e. **Coordination.** Coordination is essential for proper contingency planning at all levels of the CBRN warning and reporting organization. This planning provides CBRN information rapidly where it is required and reduces the duplication of reports. Cooperation and coordination between the NATO CBRNWRS and the national military and civilian systems are important strengthening factors to the common defense effort. The details of information exchange depend upon national policy and the structure of the national forces and civil defense organizations. Commanders must delegate authority to the appropriate levels of command for negotiating agreements and arrangements with corresponding national armed forces and civil defense authorities. Warning information should be exchanged at the lowest level possible.

f. **Responsibilities.** To achieve success on the modern battlefield, commanders and CBRN staffs must create an effective and efficient C2 system for CBRN support efforts. The CBRN staff must clearly understand its responsibilities and relationships with the supported commanders and their staff elements.

(1) The CBRN staff officer is the principal advisor to the force commander for all CBRN matters. He is responsible for the following:

- CBRN support to all elements of the force according to the decisions and priorities of the force commander.
- Staff planning and coordination for all CBRN subordinate units.
- Staff supervision during the execution of the CBRN support operations.

(2) The senior CBRN NCO's or petty officer's primary responsibilities include the following:

- Train enlisted personnel within the CBRN cell.
- Assist the shift officer in charge (OIC) as a 12-hour shift noncommissioned officer in charge (NCOIC).
- Supervise the processing of the CBRN attack information,
- Coordinate with the other staff sections in preparing and disseminating the CDM and EDM messages and managing the CBRNWRS.
- Ensure that all staff journals, files, and records are maintained.
- Supervise the maintenance of the section's vehicles.
- Advise the senior CBRN officer on the distribution of chemical personnel within the AO and advise on readiness issues.

(3) The computer and plotter are responsible for the following:

- Receive, process, and plot the CBRN attack information and determine downwind hazard predictions of the enemy CB agent clouds and radioactive fallout.
- Prepare the appropriate NBC reports and distribute them.
- Maintain the visual displays and staff journals as required.
- Maintain the CBRN situation map in the CBRN cell.
- Gather CBRN information from the subordinate command's SITREPs.
- Use various DSTs to assist with the hazard prediction and sending and receiving messages.
- Transmit the detailed instructions to radiological survey parties and survey operations.
- Calculate the transmission factors (TFs) and correlation factors (CFs) from the data provided by radiological monitoring or survey parties.
- Prepare and disseminate the EDMs and CDMs.
- Select the CFs for the radiological decay (from tables, graphs, or nomograms).
- Convert the radiological contamination data to the ground dose rates at a reference time.
- Maintain the radiation status reports of subordinate units.

(4) The operations NCO's or petty officer's duties include the following:

- Assist with the processing of CBRN attack information.
- Coordinate with the other staff sections.
- Prepare and disseminate CDMs and EDMs.
- Manage the CBRNWRS.

- Ensure that all staff journals, files, and records are maintained.
- Assist the senior NCO or petty officer.

(5) The clerk performs general administrative support functions for the CBRN cell. The clerk's duties include the following:

- Act as the radio-telephone operator.
- Prepare and dispatch messages and maintain the daily staff journal/message file.
- Record and forward NBC messages to the plotters and prepare chemical and radiological contamination overlays for transmission.

3. Overlap and Duplication

For functional and operational reasons, the AOR of NATO, USA, USAF and USN forces overlap. In addition, the AOR of the USA, civil defense, and forces not assigned to the NATO may overlap or even be identical. NBC reports will inevitably be duplicated, particularly in the case of a nuclear detonation. Therefore, commanders at all levels must ensure that their plans are fully coordinated with all neighboring CBRN centers in order to avoid duplication of reports and to ensure the rapid and efficient exchange of useful CBRN information. CBRN warning and reporting plans must be available and must state the requirement for the NBC reports to be submitted between units.

4. Correlation of Nuclear, Biological, and Chemical Reports

a. The purpose of this correlation is to show the relationship between NBC messages and to help determine whether a CBRN incident is a stand-alone incident or belongs with a multiple strike. Whenever new reports are received, they should be correlated with the existing reports. Some specific lines or sets to pay particular attention to include the following:

- Set Bravo—location of the observer and direction of the attack.
- Set Golf—delivery means and quantity.
- Set India—release of information.

b. Using the sets above, the CBRN defense specialist and officer can determine whether the attacks occurred in the same proximity, whether the means of delivery and quantity were identical or similar (fog of war), agent likeness, air or ground burst, and liquid or vapor.

Appendix C

MANAGEMENT OF EXPOSURE TO RADIOLOGICAL HAZARDS

1. Background

The exposure of forces to a radiological and nuclear hazard can have an immediate effect on personnel or affect their health or ability to survive subsequent exposures in the longer term.

a. **Exposure Control.** International recommendations and national regulations of various force components cover the management of exposure to ionizing radiation. There are also various regulations covering the exposure of personnel to other toxic industrial hazards. However, these are yet to become as pervasive as the ionizing radiation regulations. The joint force commander's operational exposure guide (OEG) needs to be prepared in the preevent phase.

(1) US forces and subordinate commanders will avoid exposing personnel to radiological hazards.

(2) Where the avoidance of exposure is impractical because of other operational priorities, exposure is to be as low as reasonably achievable (ALARA). The local commander needs to balance the successful outcome of the mission with the maintenance of the ALARA principle.

(3) Exposure or suspected exposure to a radiological hazard needs to be recorded to assist the short-term and possible long-term employment of personnel.

(4) By waiting to enter a contaminated area, the contamination level will usually be reduced and, with it, the chance of exposure. Exposure can also be accidental. Personnel may not know that equipment is contaminated. Usually, this can be prevented by always marking contaminated equipment, but there are places where contamination hazards can accumulate (e.g., in air filters). All engines have air filters which trap contaminants, and these contaminants accumulate. Even if the hazard area is small, it can be deadly. Persons working around equipment should be aware of hidden hazards. Always dispose of contaminated collectors, such as air filters, as contaminated waste.

(5) All plans should include postattack procedures for limiting exposure to a radiological hazard. The longer a person is exposed to the contamination, the greater the chance of becoming a casualty. Only the personnel required to accomplish a mission should be sent into a contaminated area.

b. **Data Recording.** The exposure of personnel to hazards will be recorded. This is so that, where practical, exposure levels can be made similar across the force and the long-term health of the individuals can be managed.

c. **Rotation of Assets.** If it is necessary for operational reasons, commanders and staff need to plan to rotate other forces through the area. This is so that exposure to the hazards is kept as even as possible throughout the force according to the ALARA principle. Such rotations will require a considerable planning effort by the joint staff if forces in the hazard area have been or become contaminated by the hazards. Movement control to limit the spread of decontamination may also be needed.

2. Information Management—Operational Exposure Guide

a. The OEG concept requires that all units maintain radiation exposure records. For example, USA records are based on platoon level data received daily, or after a mission in a radiological contaminated area. The unit dose is an average of the doses to individuals in the unit who have dosimeters, usually two per squad in the USA. Therefore, the USA assumes that each soldier receives an individual dose equal to that of the average for the platoon. The records are usually kept by the unit chemical officer at the battalion level. When a soldier transfers out of an exposed unit, the RES for that platoon is noted in the soldier's personnel file. When possible, soldiers are reassigned to platoons with the same RES category. Although this might create personnel strength management problems, it is intended to prevent personnel from incapacitation due to radiation overexposure in future operations. The other services have service-specific requirements to maintain radiation dose records. The individual dosimetry should be requested if the situation warrants, since individual dosimetry can greatly assist with the patient assessment and management.

b. The credibility of leaders and the trust on which that credibility is based must be maintained. Leaders must keep the troops informed on the possible mission exposures, realistic risk estimates, unit dose information from radiac equipment, and any other information that removes ambiguities and uncertainties in any given situation. Leaders must address, not dismiss, real concerns. The leaders should know the OEG for their mission, the RES of their unit, and the risks associated with their mission. They should have an understanding of the acute radiation exposure hazards in comparison with the immediate dangers of a conventional combat. They should also understand the potential for long-term health risks when troops receive radiation exposures. Leaders should also be knowledgeable on how to request assistance for interpreting the risks associated with radiation exposures.

3. Nuclear and Radiological Exposure Control

Nuclear and radiological exposure control ensures the safety of all personnel operating in and near these environments.

a. Radiation Exposure Control. Radiation exposure plans and the OEG need to be prepared in the preevent phase. This will be based on the CBRN IPB and the results of in-theater reconnaissance and survey of the local nuclear and radiological TIM facilities. Commanders and staffs need to ensure that—

(1) Exposure to radiation hazards is recorded by the issue and use of individual and group reading dosimeters, to national force components as appropriate.

(2) Exposure of groups to radiation is controlled by the calculation of nuclear RES and control doses so that the radiation doses received by groups are evenly distributed according to STANAG 2083.

(3) Long-term medical records need to be maintained for all personnel after any exposure to ionizing radiation above normal, local background radiation.

(4) All plans should include postattack procedures for limiting exposure to radiological hazards. The amount of an exposure is important. Every minute spent in a radiologically contaminated environment increases a person's total radiation dose. Only personnel required to accomplish a mission are sent into a contaminated area.

b. Low-Level Radiation (LLR). Unlike residual radiation deposited by a nuclear detonation, LLR hazards may result from highly diverse materials and represent a wide range of hazards. Figure C-1 provides flowcharts to conduct decision making for LLR. Possible sources of LLR include the following:

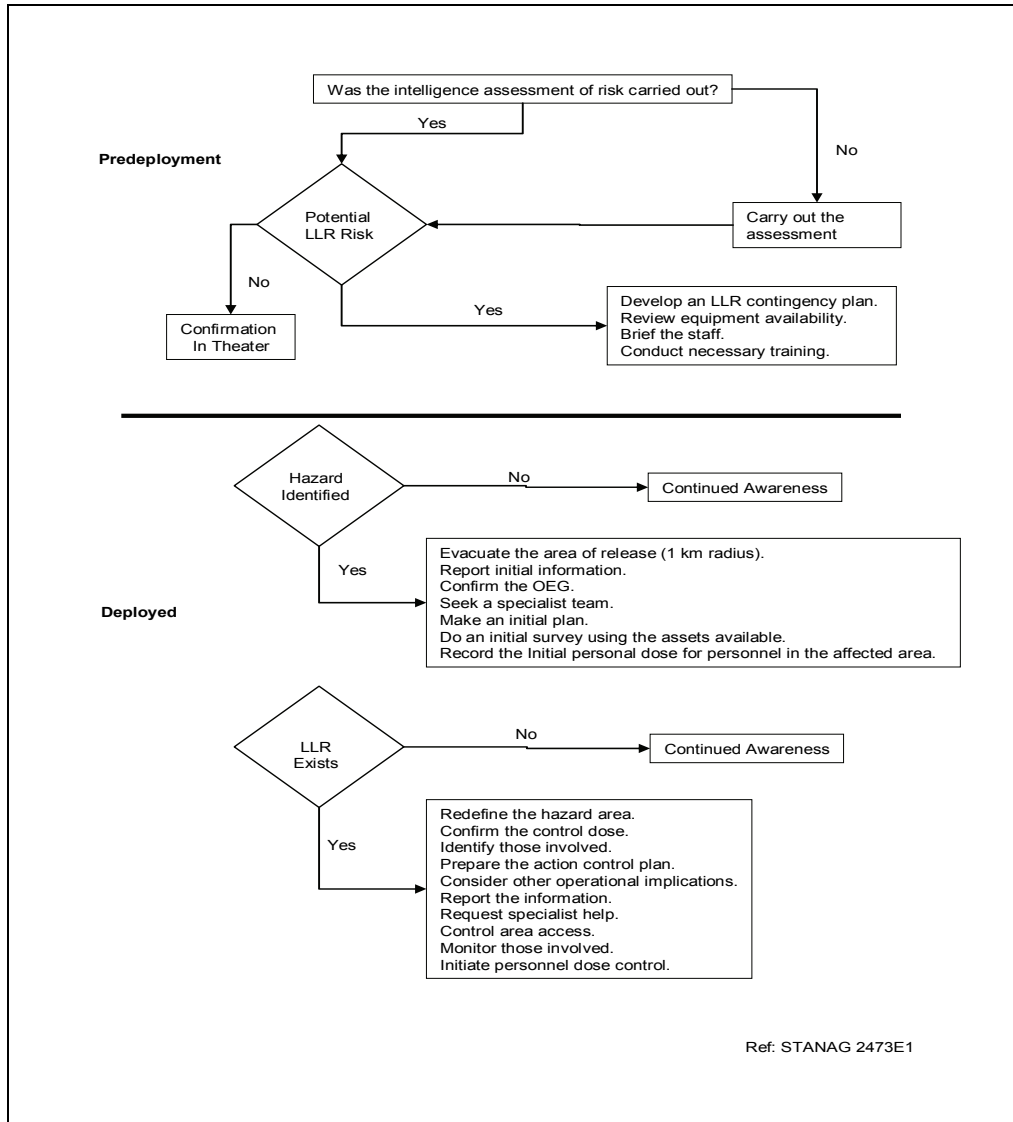

Figure C-1. LLR Decision Making

(1) Civil Nuclear Facilities. These facilities may include those for power generation and research and those for processing, storing, and disposing of nuclear waste.

(2) Industrial and Medical Facilities. Wide-scale uses of radioactive sources include the testing of industrial products, medical or diagnostic treatment and equipment sterilization, and food processing.

(3) Radiological-Dispersal Weapons. These are devices designed to release radioactive materials into the environment. This could be achieved by combining nuclear materials with conventional explosives or combustion, to produce radioactive particles or smoke.

(4) Nuclear-Weapon Release. This is the spread of fallout or rainout, resulting from the distant (outside the AO) or use (within the AO) of a nuclear weapon, which produces LLR.

(5) Military Commodities. Some military munitions (e.g., depleted uranium [DU]) and equipment contain radiation, which may present a radiation hazard if disrupted.

c. Medical Effects of LLR.

(1) Late or delayed effects of a radiation exposure occur following a wide range of doses and dose rates. Delayed effects may appear months to years after irradiation and include a wide variety of effects involving almost all tissues and organs. Some of the possible delayed consequences of radiation injury include the following:

- Shorter life.
- Carcinogenesis.
- Cataract formation.
- Chronic radiodermatitis.
- Decreased fertility.
- Genetic mutations.

The effect upon future generations is unclear. Data from Japan and Russia have not demonstrated the significant genetic effects in humans.

(2) Delivering the same gamma radiation dose at a much lower dose rate or in fractions over a long period of time allows tissue repair to occur. There is a consequent decrease in the total level of injury that would be expected from a single dose of the same magnitude delivered over a short period of time. Neutron radiation damage does not appear to be dose rate-dependent.

(3) Chronic radiation syndrome (CRS) is defined as a complex clinical syndrome occurring as a result of the long-term exposure to single or total radiation doses that regularly exceed the permissible occupational dose. CRS is highly unlikely to affect military personnel in operational settings. Prolonged deployments to heavily contaminated areas or long-term ingestion of highly contaminated food or water would be required for CRS. A near-ground weapon detonation, radiological dispersal device (RDD), major reactor accident, or similar event that creates contamination with high dose rates, given prolonged exposure, would permit development of CRS.

d. Command Radiation Exposure Guidance. Commanders will require advice from their medical officers concerning the radiation effects on their personnel. Medical advice must be practical and be based upon the requirements of the mission and the diversity of the human response to radiation. Overreaction to a contamination could make enemy use of an RDD more tenable. The effects of radiation that exceeds the normal occupational exposure levels must not be minimized or exaggerated. CBRN risks must be in their proper places relative to the other hazards of combat. Widespread environmental radiological contamination can never be so great as to preclude mandatory mission accomplishment. Maintain dose records of those exposed to the LLR.

(1) Commanders need to be aware of the individual dose histories when planning future operations that are at risk of LLR exposure.

(2) On completion of the military operation, long-term health monitoring may be required for those personnel who have been exposed to radiation. This should be done according to the national regulations. A postoperation assessment of the internal doses may also be required.

e. Personnel Evacuation From a Radiological Area. When evacuation personnel are sent into a radiologically contaminated area, an OEG must be established. Prolonged wearing of the IPE under MOPP conditions, the climate, workload, and fatigue combine to limit personnel effectiveness and, consequently, hamper casualty evacuation. Based on factors such as missions, priorities, and OEG, commanders decide which of the evacuation assets will be sent into the contaminated area. As a general principle, to limit the contamination of evacuation assets, patients should be decontaminated before the evacuation.

f. RDD. The severity of the psychological effects of an RDD will depend on the nature of the RDD material itself and the method of deployment. A point source of radiation produces physical injury only to the soldiers within its immediate vicinity. An RDD that uses a conventional explosion as a dispersal method will cause psychological injury from the physical effects of the blast in addition to the radiation and heavy-metal hazard inherent in many radioactive materials. The misinterpretation of the explosion as a nuclear detonation may induce psychological effects similar to those produced by a true nuclear detonation. The number of casualties from the blast and a generally more frantic situation will intensify the level of stress on soldiers.

(1) The presence of an RDD within a civilian population center will produce more detrimental psychological damage to the soldiers than it will to a military target. Military units in a theater of operation during war often have limited contact with civilian populations. However, during peacetime missions (such as operations other than war [OOTW]), a closer relationship may exist between civilians and soldiers. The treatment of civilian casualties, particularly children, from the exposure to an RDD could markedly increase the psychological impact on soldiers.

(2) Mass psychosomatic symptoms from the unrealistic fear of the effects of radioactive material pervasive in many civilian populations could severely overload medical support and operations.

4. Radiological Exposure

Radiological exposure must be controlled to ensure the safety of all personnel. Exposure levels have been developed to categorize and manage the risk posed to warfighters who have been exposed to radiation.

a. Radiation Exposure During War. Consult medical specialists for medical assessments and recommendations. With exposures below 125 centigray (cGy), the overall effectiveness of combat units will not be degraded. However, above this threshold, commanders must be aware that their force's capability to fight will be diminished. The term "combat effective" is used for personnel who will be suffering radiation sickness signs and symptoms to a limited degree and who will be able to maintain their performance at least 75 percent of their preexposure performance level. Those individuals who are predicted to be "performance degraded" would be operating at a performance level between 25 and 75 percent of their preexposure performance. Those predicted as "combat ineffective" should be considered as capable of performing their tasks at 25 percent (at best)

of their preexposure performance level. Tables C-1 and C-2 provide examples of expected radiation intensities and effects after a nuclear attack.

Table C-1. Projected Radiation Intensities After a Nuclear Attack (cGy per hour)

| 1 Hour | 5 Hours | 25 Hours | 50 Hours | 100 Hours | 300 Hours |
|--------|---------|----------|----------|-----------|-----------|
| 1,000 | 100 | 21 | 9 | 4 | 1 |
| 500 | 75 | 11 | 5 | 2 | <1 |
| 250 | 37 | 5 | 6 | 1 | <1 |
| 100 | 15 | 2 | 1 | <1 | <1 |
| 50 | 8 | 1 | <1 | <1 | <1 |
| 10 | 2 | <1 | <1 | <1 | <1 |

NOTE: This chart shows a normal decay rate (1.2). The actual decay rate may be slower or faster. Refer to ATP-45B for detailed information on decay rates and radiation prediction methods.

Table C-2. Effects by Nuclear Weapon Yield in Kilometers From GZ

| | Weapon Yield | | | |
|-------------------------------|--------------|-------|--------|------|
| | 1 kt | 10 kt | 100 kt | 1 mt |
| Blast: Lethality | | | | |
| Threshold 30-50 psi | 0.18 | 0.38 | 0.81 | 1.8 |
| 50% 50-75 psi | 0.14 | 0.30 | 0.65 | 1.4 |
| 100% 75-115 psi | 0.12 | 0.25 | 0.55 | 1.2 |
| Blast: Lung Damage | | | | |
| Threshold 8-15 psi | 0.34 | 0.74 | 1.60 | 3.4 |
| Severe 20-30 psi | 0.21 | 0.46 | 0.98 | 2.1 |
| Blast: Eardrum Rupture | | | | |
| Threshold 5 psi | 0.44 | 0.96 | 2.10 | 4.4 |
| 50% 14 psi | 0.25 | 0.54 | 1.10 | 2.5 |
| Thermal | | | | |
| 50% First Degree Burns | 1.20 | 3.40 | 8.30 | 17.0 |
| 50% Second Degree Burns | 0.86 | 2.50 | 6.50 | 14.0 |
| 50% Third Degree Burns | 0.71 | 2.10 | 5.60 | 12.0 |
| Flash Blindness | 3.70 | 9.00 | 18.00 | 31.0 |
| Retinal Burns | 33.00 | 49.00 | 66.00 | 84.0 |

Table C-2. Effects by Nuclear Weapon Yield in Kilometers From GZ (Continued)

| Ionizing Radiation Effects | | | | | | |
|----------------------------|-------------------------|----------|------|------|------|-----|
| 50 cGy | Threshold acute effects | | 1.10 | 1.60 | 2.20 | 3.1 |
| 100 cGy | <5% deaths | years | 1.00 | 1.50 | 2.00 | 3.0 |
| 450 cGy | 50% death | weeks | 0.77 | 1.20 | 1.70 | 2.6 |
| 1,000 cGy | 100% death | few days | 0.65 | 1.00 | 1.60 | 2.4 |
| 10,000 cGy | 100% death | <1 day | 0.36 | 0.66 | 1.10 | 1.9 |

b. RES.

(1) The RES of a given unit is based on the operational exposure above normal background radiation. It is designed to be an average, based on unit level dosimeters, and is not useful for the individual casualty. The degree-of-risk concept helps the commander establish an OEG for a single operation and minimize the number of radiation casualties. By using the RES categories of subordinate units, the commander establishes an OEG based on the acceptable degree of risk.

(2) Medical officers may adjust a unit's RES after careful evaluation of the exact exposure status of individual members of the unit. When possible, the physical and biological dosimetry should be used in this regard. The unit status should reflect the arithmetic mode of the available radiation exposure history of all individual members. Any unit member whose exposure status is more than one category greater than the mode should be replaced (or designated as a subcategory in OOTW). A command health physicist should be consulted whenever possible. When the exposure dose rate is known to be less than 5 cGy per day, the repair of an injury is enhanced and the time for cellular repair is reduced. In these circumstances, dosimetry should be available that would allow the RES category to be reduced after 3 months at the normal background levels. When individual dosimetry is unavailable, a period of 6 months (since the last radiation exposure above background) is sufficient to upgrade a unit's RES status one category or subcategory one time only. Tables C-3 and C-4 (page C-9) provide RES categories and their respective effects.

Table C-3. Radiation Injuries and Effects of Radiation Exposure to Personnel

| RES | Total Dose ¹ | Long-Term Health Effects | Medical Note | Medical Actions |
|-----|-------------------------|--|---|--|
| 0 | <0.05 cGy | Normal risk | US baseline 20% lifetime risk of a fatal cancer | Record in exposure record of normally monitored personnel. |
| 1 | ≤75 cGy | Up to 1% incidence of LI ³ | | |
| 1A | 0.05 to 0.5 cGy | Up to 0.04% increased risk of a lifetime fatal cancer | None (0.1 cGy annual general population exposure limit) | Record individual dose readings. Initiate periodic monitoring (including air and water). |
| 1B | 0.5 to 5 cGy | Occupational risk 0.04–0.4% increased risk of lifetime cancer | Reassurance (5 cGy US annual occupational limit) | Record individual dose readings. Continue monitoring. Initiate a radiation survey. Prioritize tasks. Establish radiation control measures. |

Table C-3. Radiation Injuries and Effects of Radiation Exposure of Personnel (Continued)

| RES | Total Dose ⁴ | Long-Term Health Effects | Medical Note | Medical Actions |
|-----|-------------------------|--|--|---|
| 1C | 5 to 10 cGy | 0.4–0.8% increased risk of lifetime fatal cancer | Counsel regarding increased long-term risk No live virus vaccines for 3 months | Record individual dose readings. Continue monitoring. Update the radiation survey. Continue radiation control measures. Execute priority tasks ² only. |
| 1D | 10 to 25 cGy | 0.8–2% increased risk of lifetime fatal cancer | Potential for increased morbidity of other injuries or incidental disease <2% increased lifetime risk of fatal cancer | Record individual dose readings. Continue monitoring. Update the radiation survey. Continue radiation control measures. Execute critical tasks ³ only. |
| 1E | 25 to 70 cGy | 2–5.6% increased risk of lifetime fatal cancer | Increased morbidity of other injuries or incidental disease <6% increased lifetime risk of fatal cancer | Record individual dose readings. Continue monitoring. Update radiation survey. Continue radiation control measures. Execute critical tasks ³ only. |
| 2 | >75 to 125 cGy | Up to 5% LI ⁴ | See Table C-5, page C-10 | See Table C-5, page C-10 |
| 3 | > 125 cGy | >5% LI | See Table C-5, page C-10 | See Table C-5, page C-10 |

NOTES:
¹Injury or exposure to CB agents may affect response to radiation.
² Examples of critical tasks are those missions to save lives.
³ Examples of priority tasks are those missions to avert danger to persons or to prevent damage from spreading.
⁴LI is the casualty criterion defined as the lowest dose at which performance is degraded (i.e., 25–75% capable) within 3 hours and will remain so until death or recovery or become combat ineffective at any time within 6 weeks.

c. Nuclear Risk Criteria. There are three degrees of risk—negligible, moderate, and emergency. Table C-4 provides the risks associated with each respective RES category. Latent ineffectiveness (LI) is the casualty criterion defined as the lowest dose at which performance is degraded (i.e., 25 to 75 percent capable) within 3 hours and will remain so until death or recovery or become combat ineffective at any time within 6 weeks.

- Negligible (1 percent LI). Negligible risk is acceptable when the mission requires units to operate in a contaminated environment. However, it should not be exceeded unless a significant advantage will be gained.
- Moderate (2.5 percent LI). Moderate risk is usually acceptable in close support operations. Moderate risk must not be exceeded if troops are expected to operate at full efficiency.
- Emergency (5 percent LI). The emergency risk dose is only acceptable in rare situations termed disaster situations. Only the commander can decide when the risk of the disaster situation outweighs the radiation emergency risk.

Table C-4. Nuclear Radiation cGy Exposure Status and Degree of Risk Exposure

| Radiation Status Category (A) | Possible Exposure Criteria for a Single Operation not Resulting in Exceeding the Dose Criteria for the Degree of Risk (B) |
|---|--|
| RES-0 Units (Previously unexposed) | Negligible: ≤ 75 Moderate: ≤ 100 Emergency: ≤ 25 |
| RES-1 Units (Previously exposed >0 to ≤ 75 cGy) | Negligible: $A+B \leq 75$ Moderate: $A+B \leq 100$ Emergency: $A+B \leq 125$ |
| RES-2 Units (Previously exposed ≥ 75 to ≤ 125 cGy) | Any further exposure will exceed negligible risk and could exceed moderate risk. Negligible: > 0 Moderate: $A+B \leq 100$ Emergency: $A+B \leq 125$ |
| RES-3 Units (Previously exposed >125 cGy) | Any further exposure will exceed emergency risk. |
| <p>NOTES:</p> <ol style="list-style-type: none"> 1. RES categories are based on previous exposure. Risk levels are graduated within each RES category in order to provide more stringent criteria as the total radiation dose accumulated becomes more serious. 2. Reclassification from one RES category to a less serious one is made by the commander upon advice from medical personnel and after ample observation of the actual state of health of exposed personnel. 3. All exposures to radiation are considered total body and simply additive. No allowance is made for body recovery from radiation injury. 4. Exposure criteria given for RES-1 and RES-2 units should be used only when the numerical value of a unit's total past cumulative dose is unknown. 5. Each of the degrees of risk can be applied to radiation hazards resulting from enemy or friendly weapons or both and from initial nuclear radiation resulting from planned friendly supporting fire. | |

Table C-5. Physiological Effects of Radiation¹

| Total Dose Estimate (cGy) ² | Performance Capability | Symptoms | Initial Symptoms Interval ³ | | Disposition Without Medical Care ⁴ | Medical Care Requirement ⁴ |
|---|--|--|--|----------|---|--|
| | | | Onset | End | | |
| <0.05 | CE | US baseline 20% lifetime risk of fatal cancer | | | | |
| 0.05–0.5 | CE | Up to 0.04% increased risk of lifetime fatal cancer | | | | |
| 0.1 | CE | Annual general population exposure limit | | | | |
| 5 | CE | US occupational annual limit | | | | |
| 5–10 | CE | 0.4–0.8% increased risk of lifetime fatal cancer | | | | |
| 10–25 | CE | 0.8–2% increased risk of lifetime fatal cancer | | | | |
| 25–75 | CE | 2–6% increased risk of lifetime fatal cancer | | | | |
| 35–75 | CE | Nausea, mild headache, and vomiting in up to 5% in upper range | 6 | 12 | Duty | None |
| 75–125 | CE | Transient mild nausea and vomiting in 5–30% | 3–5 | 1 day | Restricted duty ⁵ | Restricted duty ⁵ |
| 125–300 LD ₅ –LD ₁₀ | DT: PD 4 hours until recovery UT: • PD 6–24 hours • 6 weeks recovery | Transient mild to moderate nausea and vomiting in 20–70% of personnel Mild to moderate fatigability and weakness in 25–60% of personnel | 2–3 | 2 days | Restricted duty ⁵ | Restricted duty ⁵ Medical care may be needed at 3–5 weeks for 10–50% to attend to infection, bleeding, and fever |
| 300–530 LD ₁₀ –LD ₅₀ | DT: PD 3 hours until death or recovery UT: • PD 4 hours–2 days • PD 2 weeks–death or recovery | Transient nausea and vomiting in 50–100% Mild to moderate fatigue in 60–90% 2–5 weeks: 20–60% infection, bleeding, fever, ulceration, loss of appetite, and diarrhea | 2 | 3–4 days | Survivors may be able to return to light duty >5 weeks ⁵ May require evacuation | Restricted duty ⁵ May require evacuation |

Table C-5. Physiological Effects of Radiation¹ (Continued)

| Total Dose Estimate (cGy) ² | Performance Capability | Symptoms | Initial Symptoms Interval ³ | | Disposition Without Medical Care ⁴ | Medical Care Requirement ⁴ |
|---|---|---|--|---------------|--|--|
| | | | Onset | End | | |
| 530–830 LD ₅₀ –LD ₉₀ | <p>DT:</p> <ul style="list-style-type: none"> • PD 1 hour–3 weeks • CI until death <p>UT:</p> <ul style="list-style-type: none"> • PD 2 hours–2 days • CE 4–7 days • PD 7 days - 4 weeks • CI 4 weeks until death or recovery | <p>Moderate to severe nausea and vomiting in 50–100% of personnel</p> <p>Moderate to severe fatigue and weakness in 90–100% of personnel</p> <p>10 days–5 weeks: 50–100% infection, bleeding, fever, loss of appetite, ulceration, diarrhea, nausea, vomiting, fluid and electrolyte imbalance, and hypotension</p> | <1 | Days to weeks | <p>Low end⁵ Death may occur in 6 weeks</p> <p>High end⁵ Death may occur in 3–5 weeks</p> | <p>Early evacuation to tertiary medical center before onset of illness</p> |
| 830–3,000+ LD ₉₀ –LD ₁₀₀ | <p>DT:</p> <ul style="list-style-type: none"> • PD 45 minutes–3 hours • CI 3 hours until death <p>UT:</p> <ul style="list-style-type: none"> • PD 1–7 hours • CI 7–24 hours • PD 1–4 days • CI 4 days until death | <p>Severe nausea, vomiting, fatigability, weakness, dizziness, disorientation, possible high fever, and sudden vascular collapse</p> | <3 min | Death | Death expected | <p>1,000 cGy: Death at 2–3 weeks</p> <p>3,000 cGy: Death at 5–10 days</p> <p>If assets are available, early evacuation to tertiary medical center; most will not survive</p> |
| <p>Abbreviation Key</p> <p>CE—Combat Effective = >75% of full capacity</p> <p>PD—Performance Decrement or Partially Degraded = 25%–75% of full capacity</p> <p>CI—Combat Ineffective = <25% of full capacity</p> <p>DT—Demanding Task = Heavy physical work</p> <p>UT—Undemanding Task = Sedentary or cognitive</p> | | | | | | |

Table C-5. Physiological Effects of Radiation¹

| Total Dose Estimate (cGy) ² | Performance Capability | Symptoms | Initial Symptoms Interval ³ | | Disposition Without Medical Care ⁴ | Medical Care Requirement ⁴ |
|---|------------------------|----------|--|-----|---|---------------------------------------|
| | | | Onset | End | | |
| ¹ For more information, see <i>Treatment of Nuclear and Radiological Casualties</i> . ² Peacetime US occupational annual radiation dose limit: 5 cGy = 0.8% increase in lifetime risk of death from cancer. ³ Time is in hours unless otherwise indicated. ⁴ Consult list for detailed information. ⁵ No further radiation exposure allowable. Personnel are very susceptible to disease and nonbattle injuries due to infections. | | | | | | |

d. **Radiation Exposure During Military Support to Civil Authorities.** The Health Physics Society believes that the receipt of doses of ionizing radiation by responders to a nuclear terrorism event is unavoidable and justifiable. For certain individuals, doses could exceed levels normally encountered in the typical utilization of radiation (e.g., occupational exposures, exposures to medical practitioners and patients). While regulatory limits of exposure have been well-described for radiation doses from such routine utilization of radioactivity and radiation, exposure limits for emergency workers are not well-described.

(1) **Occupational Versus Emergency Dose Limits.** In the regulatory scheme for occupational radiation exposure, a number of dose limits have been defined and described for members of the public and occupationally exposed persons. The basic assumptions used to derive these limits involve a balance of risk to the individual against the benefits to be obtained by permitting such exposure (both to the individual and to society). In a terrorist event, however, the assumptions used in the justification of limits would not likely apply, thus the limits may not be appropriate to members of the public nor to personnel responding to the event.

(2) **Dose Guidelines to Responders to a Terrorist Event.** The use of radioactivity or radiation as a means of a terrorist attack will result in dose rates significantly higher than natural background. In a terrorist event, immediate response is critical for the mitigation of effects, saving lives, protecting property, and the timely restoration of the affected area, particularly where the affected area has significant economic or iconic value to the area or country. Such compelling needs justify higher levels of dose rates in the performance of these duties, much higher than would normally be justified from routine life activities. Accordingly, higher dose limits can be justified (see Table C-6, page C-14). The following dose guidelines apply during response to a terrorist event:

- The dose rate will not exceed 50 REM for the responders.
- Provisions are in place for long-term MEDSURV of the responders that exceed 25 REM.
- The individuals most likely to be permitted these levels of exposures would be professional responders (e.g., firefighters, police, emergency medical technicians [EMTs]) who, by sake of employment, have implicitly agreed to assume the significant risks in a rescue operation.
 - The most likely effect at 50 REM would be some minor fluctuations in blood count which are entirely reversible. In addition, the exposed persons might face a slightly higher chance of incurring a fatal cancer.
 - These risk levels are comparable to other risk factors which are commonly found in these types of activities (e.g., smoke inhalation, physical trauma, heavy physical exertion).
 - The benefit of such individual exposure would be the mitigation of a condition or situation that could result in dangerous levels of exposure to members of the public or in some other way threaten the general public health and safety (e.g., the mitigation of widespread fires or the protection of critical infrastructure that is needed for organized evacuation or relocation of populations).

- The dose rate will not exceed 5 REM during routine duties other than lifesaving, firefighting, etc.
- The dose rate for members the public will not exceed 0.1 REM.

Table C-6. First-Responder Exposure Limits

| Locations | Exposure Limits | Restrictions |
|---|-----------------|---|
| Outer Exclusion Zone | 0.02 cGy/hr | This area is limited to designated response personnel only. Members of the general public are excluded. |
| Incident Command Centers, Staging Areas, etc. | 0.10 cGy/hr | Command centers, staging areas, etc., may need to be set up close to the event. Such areas should be established in a location that is below the listed dose rate. |
| Hot Zone | 1.00 cGy/hr | Responders should enter the area only on an as-needed basis in order to accomplish specific tasks. |
| "Turn Around" Limit | 100.00 cGy/hr | Dose rates in these areas represent levels of radiation that require detailed planning to enter. Entry is permitted only with special authorization and to accomplish well-defined tasks. |
| Justifiable Rescue Limit | 1,000.00 cGy/hr | At this dose rate, the likelihood of the successful rescue of victims is outweighed by the dose effects to the responders. This guideline represents the level that rescue operations may not be justified. Enter such areas only after it has been determined that the likelihood of success outweighs the potential harm to the rescuers. |

5. Radioactive Materials of Military Significance

A warfighter could potentially be exposed to various radioactive materials. Some are more dangerous than others. Below is a listing of radioactive materials that are of significance to the military.

a. Americium.

(1) Americium-241 (^{241}Am) is a decay daughter of plutonium and is primarily an alpha emitter and a very low energy gamma emitter. It is detectable with a standard radiac, such as the field instrument for detection of low-energy radiation (FIDLER) instrument, due to the emission of a 60-kEv gamma ray.

(2) Americium is used in smoke detectors and other instruments, and it will be found in fallout from a nuclear-weapon detonation. It is used as a sealed source in the M43A1 chemical agent detector that is a component of the M8A1 alarm.

(3) Americium is a heavy-metal poison but, in large quantities, can cause whole-body irradiation. Seventy-five percent of an initial lung burden is absorbed, with 10 percent of the particles retained in the lung. Gastrointestinal absorption of americium is minimal, but it may be absorbed rapidly through skin wounds. External exposure is not a concern unless large amounts of the substance are located in one area and personnel are in close contact for an extended period of time.

b. Cesium.

(1) Cesium-137 emits a beta particle as it decays to barium-137, which in turn decays by emitting gamma rays. It emits gamma rays and beta radiation and can be readily detected by gamma instruments.

(2) Cesium-137 (^{137}Cs) is found in medical radiotherapy devices and in soil density and moisture testers. The mishandling of a medical radiotherapy device was responsible for the worst radiation accident in the western hemisphere. It was used in the Chechen RDD threat against Moscow.

(3) Cesium is completely absorbed by the lungs, gastrointestinal tract, and wounds. It is soluble in most forms and is treated by metabolism as a potassium analog. Excretion is in urine. Primary toxicity is whole-body irradiation. Deaths due to acute radiation syndrome have occurred.

c. Cobalt.

(1) Cobalt-60 (^{60}Co) is used in medical radiotherapy devices and commercial food irradiators. It will most likely be found after improper disposal or after the destruction of a hospital or commercial facility. It generates high-energy gamma rays and 0.31 million electron volts (MeV) of beta rays. It is easily detectable with a gamma detector.

(2) Cobalt could be used as a contaminant in an improvised nuclear device to make the fallout more radioactive.

(3) Cobalt will be rapidly absorbed by the lung, but less than 5 percent will be absorbed from the gastrointestinal tract. Nothing is known about absorption through wounds. Primary toxicity will be from whole-body irradiation and acute radiation syndrome.

d. DU.

(1) DU emits alpha, beta, and weak gamma radiation. Due to its high density, much of the radiation never reaches the surface of the metal. It is, thus, self-shielding. Also, intact DU rounds and armor are packaged to provide sufficient shielding that stops beta and alpha radiations. Gamma radiation exposure is minimal. After several months of continuous operations in an armored vehicle completely loaded with DU munitions, crew exposures might exceed peacetime general-population exposure limits, but would not exceed peacetime occupational exposure limits. Hence, DU is not a serious irradiation threat. It is readily detectable with a typical end-window Geiger-Mueller™ counter.

(2) Although DU is not a chemical or radiological hazard, it can present a chemical toxicity hazard and, perhaps, a long-term radiological health risk under some conditions when it is introduced internally to the body. Some risks associated with DU munitions have been evaluated experimentally, some risks are still under study, and some risks were identified from practical experience during Operation Desert Storm. DU internalization via inhalation is the primary concern.

(3) Inhaled DU compounds may be metabolized and result in urinary excretion. The inhalation of DU oxides may occur during tank fires or by entering destroyed armored vehicles without a protective mask. Absorption will be determined by the chemical state of the DU. Soluble salts are readily absorbed; the metal is not. DU fragments in wounds become encapsulated and are gradually metabolized, resulting in whole-body distribution, particularly to bones and kidneys. In laboratory tests, DU does cross the placenta. No renal toxicity has been documented to date.

e. Iodine.

(1) Iodine-131, -132, -134, and -135 will be found after a reactor accident and following the destruction of a nuclear reactor. Radioactive iodine is a normal fission

product found in reactor fuel rods. It is released by rupturing the reactor core and its containment vessel. Postdestruction winds will determine the fallout pattern. Most of the radiation is beta rays, with some gamma.

(2) Primary toxicity is to the thyroid gland. Thyroid uptake concentrates the radioactive iodine and allows local irradiation similar to therapeutic thyroid ablation. A high incidence of childhood thyroid carcinoma was documented following the Chernobyl disaster.

f. Nickel-63. Nickel-63 is a pure beta emitter with a radiological half-life of 92 years and is used in chemical-agent monitors (CAMs). The beta energy of nickel-63 is too low to penetrate the dead layer of skin; however, efforts should be taken to prevent internalization.

g. Phosphorus.

(1) Phosphorus-32 (^{32}P) will generally be found in research laboratories and in medical facilities where it is used as a tracer. It has a strong beta ray and can be detected with the beta shield open on a beta-gamma detector.

(2) Phosphorus is completely absorbed from all sites. It is deposited in the bone marrow and other rapidly replicating cells. Local irradiation causes cell damage.

h. Plutonium.

(1) Plutonium-238 and -239 (238 and ^{239}Pu) are produced from uranium in reactors. It is the primary fissionable material in nuclear weapons and is the predominant radioactive contaminant in nuclear-weapon accidents. The primary radiation is in the form of alpha particles, so plutonium does not present an external irradiation hazard. It is always contaminated with americium, which does have a fairly easily detectable X-ray by use of a thin-walled gamma probe.

(2) Five-micron or smaller particles will remain in the lung and are metabolized based on the salt solubility. The particles that remain will cause local irradiation damage. Gastrointestinal absorption will depend on the chemical state of the plutonium; the metal is not absorbed. Stool specimens will be positive after 24 hours, and urine specimens will be positive after 2 weeks. Wound absorption is variable. Plutonium may be washed from intact skin.

i. Radium.

(1) Radium-226 (^{226}Ra) is not a federally regulated commodity and has no US military use. It may be encountered in the former Soviet Union equipment as instrument illumination, in industrial applications, and in older medical equipment. Primary radiation is alpha particles, but daughter products emit beta and gamma rays and, in quantity, may present a serious external irradiation hazard.

(2) Most exposure is by ingestion, with 30 percent absorption. Little is known about wound absorption, but radium will follow calcium to bone deposition. Long-term exposure is associated with leukemia, aplastic anemia, and sarcomas.

NOTE: Former Soviet Union equipment is manufactured and used by militaries throughout the world as a result of arms purchases and technology transfers.

j. Strontium.

(1) Strontium-90 (^{90}Sr) is a direct fission product (daughter) of uranium. It and its daughters emit beta and gamma rays and can be an external irradiation hazard if present in quantity.

(2) Strontium will follow calcium and is readily absorbed by respiratory and gastrointestinal routes. Up to a 50 percent dose will be deposited in the bone.

k. Thorium-232.

(1) Thorium-232 is a naturally occurring radioisotope of thorium and is an alpha emitter.

(2) When thorium is heated in the air, it glows with a white light. For this reason, one of the major uses of thorium has been the WelsbackTM lantern mantle used in portable gas lanterns. Thorium-232 is also used in radiac sets AN/VDR-2, AN/PDR-54, and AN/PDR-77 for use as calibration check sources. Thorium-coated optics are found on many night vision devices and thermal optic fire control systems. Also, heat-resistant thorium alloys are used in the combustor liner for the Abrams tank turbine engine and on various military aircraft engines.

(3) In general, Thorium-232 presents a minimal hazard, but care should be taken to avoid internalization of any particles from damaged components or during metal working activities.

l. Tritium.

(1) Tritium is the heaviest isotope of hydrogen and is a low-energy beta emitter with a physical half-life of 12 years. Tritium gas rapidly diffuses into the atmosphere.

(2) It is used in nuclear weapons and muzzle velocity detectors. Tritium is generally used in devices requiring a light source, such as luminescent gun sights, watches, compasses, and fire control devices for tanks, mortars, and howitzers.

(3) Tritium is a beta emitter and is not a significant irradiation hazard. However, the release of a large amount in a closed space can cause an exposure of clinical importance. No adverse health effects have been reported from a single exposure.

m. Uranium.

(1) Uranium-235, -238, and -239 (^{235}U , ^{238}U , and ^{239}U) are found (in order of increasing radioactivity) in DU, natural uranium, fuel rods, and weapons grade material. Uranium and its daughters emit alpha, beta, and gamma radiation. DU and natural uranium are not serious irradiation threats. Used fuel rods and weapons-grade (enriched) uranium-containing fission products can emit significant levels of gamma. If enough enriched uranium is placed together, a critical mass may form and emit lethal levels of radiation. This could be encountered in a fuel-reprocessing plant or melted reactor core.

(2) Inhaled uranium compounds may be metabolized and excreted in the urine. Urinary levels of 100 micrograms per deciliter following acute exposure may cause renal failure.

(3) Absorption will be determined by the chemical state of the uranium. Soluble salts are readily absorbed; the metal is not.

NOTE: Table C-7 provides the international system of units and their conversions. This information, along with the radiation type and quality factors provided in Table C-8, is used when measuring and qualifying different radioactive materials.

Table C-7. International System of Units—Conversions

| Old Unit | SI Unit | Old Unit | SI Unit |
|--------------|------------------|------------|----------------------------|
| Curie | Becquerel | Rem | Sievert |
| 1 pCi | 37 mBq | 0.1 mrem | 1 μ Sv |
| 27 pCi | 1 Bq | 1 mrem | 0.01 mSv |
| 1 μ Ci | 37 kBq | 1 mrem | 10 μ Sv |
| 27 μ Ci | 1 MBq | 100 mrem | 1 mSv |
| 1 Ci | 37 GBq | 500 mrem | 5 mSv |
| 27 Ci | 1 TBq | 1 rem | 10 mSv |
| | | 1 rem | 1 cSv |
| | | 100 rem | 1 Sv |
| rad | gray | | |
| 1 rad | 10 mGy | | |
| 1 rad | 1 cGy | | |
| 100 rad | 1Gy | | |
| | | | |
| Symbol | Name | Multiplier | Value |
| p | pico | 10^{-12} | million millionth |
| n | nano | 10^{-9} | thousand millionth |
| μ | micro | 10^{-6} | millionth |
| m | milli | 10^{-3} | thousandth |
| c | centi | 10^{-2} | hundredth |
| k | kilo | 10^3 | thousand |
| M | mega | 10^6 | million |
| G | giga | 10^9 | billion (thousand million) |
| T | tera | 10^{12} | thousand billion |
| P | peta | 10^{15} | million billion |
| E | exa | 10^{18} | billion billion |

1 rad = 100 ergs/gram
 1 Gy = 1 joule/kilogram = 100 rads
 Rem = QF x Rad
 Sievert = QF x Gy
 1 Sv = 1 joule/kilogram = 100 rem

Table C-8. Radiation Type/Quality Factor

| Radiation Type | Quality Factor |
|--|----------------|
| X ray, gamma ray, beta ray | 1 |
| Alpha particles, fission fragments, and heavy nuclei | 20 |
| Neutrons | 3–20* |
| *Values of quality factors for neutrons are dependent the energy of the neutron. | |

Appendix D

WEATHER EFFECTS ON NUCLEAR, BIOLOGICAL, AND CHEMICAL AGENTS AND METEOROLOGICAL REPORTS

1. Background

MET reports are used—

- As the basis to assess weather data determining if environmental factors are conducive to enemy employment of CBRN weapons.
- In conjunction with plotting tools to predict downwind vapor hazard and fallout patterns.
- To assess the impact of seasonal climate on CBRN weapons effects.
 - a. MET Operations.

(1) MET operations identify the critical weather information needed to determine the effects of weather on the use of CBRN weapons. MET operations also analyze the seasonal or monthly normal variations in weather patterns that might affect the use of CBRN weapons.

(2) Intelligence ensures that EDMs and CDMs are passed to subordinate commands, in coordination with the USAF staff weather officer (SWO).

(3) The CBRN staff must have close coordination with intelligence and meteorology personnel.

(4) The CBRN staff is responsible for CBRN defense at every echelon of command. It assesses whether environmental factors are conducive to the enemy use of CBRN weapons.

(5) The CBRN staff provides input on hazard predictions, increasing the commander's SA.

b. USN. The Fleet Numerical Meteorology and Oceanography Center provides wind field data and high-resolution MET data for DTRA CBRN dispersion modeling and simulation. DTRA supports the DOD hazard assessment planning and contingency operations. The Naval Oceanography Program will provide MET forecasts as required in support of CBRN avoidance and consequence management to the USN and joint commanders.

2. Weather Effects on Chemical, Biological, Radiological, and Nuclear Agents

Weather can affect CBRN agents in various ways. In some instances, it can prolong the presence of agents in the battlespace and, in other instances, it can shorten the time agents pose a hazard to the warfighter.

a. Nuclear. Any condition that significantly affects the visibility or the transparency of the air affects the transmission of thermal radiation. Clouds, smoke (including artificial), fog, snow, and rain absorb and scatter thermal energy. Depending on the concentration, they can stop as much as 90 percent of the thermal energy. On the other

hand, clouds above the burst may reflect additional thermal radiation onto the target that would have otherwise traveled harmlessly into the sky.

(1) Rain.

(a) Rain on an area contaminated by a surface burst changes the pattern of radioactive intensities by washing off higher elevations, buildings, equipment, and vegetation. This reduces intensities in some areas and, possibly, increases intensities in drainage systems, on low ground, and in flat or poorly drained areas.

(b) Rain and fog may lessen the blast wave because energy dissipates by heating and evaporating the moisture in the atmosphere.

(c) Clouds and air density have no significant effects on fallout patterns.

(d) Precipitation scavenging can cause the removal of radioactive particles from the atmosphere; this is known as *rainout*. Because of the uncertainties associated with weather predictions, the locations that could receive rainout cannot be accurately predicted. Rainout may occur in the vicinity of GZ, or the contamination could be carried aloft for tens of kilometers before deposition. The threat of rainout especially exists from a surface or subsurface burst. Vast quantities of radioactive debris will be carried aloft and deposited downwind. However, rainout may cause the fallout area to increase or decrease and also cause hot spots within the fallout area.

(e) For airbursts, rainout can increase the residual contamination hazard. Normally, the only residual hazard from an airburst is a small neutron-induced contamination area around GZ. However, rainout will cause additional contaminated areas in unexpected locations.

(f) Yields of 10 kilotons (kt) or less present the greatest potential for rainout, and yields of 60 kt or more offer the least. Additionally, yields between 10 kt and 60 kt may produce rainout if the nuclear clouds remain at or below rain cloud height.

(2) Wind Speed and Direction.

(a) Wind speed and direction at various altitudes are two factors that determine the shape, size, location, and intensity of the fallout pattern on the ground because contaminated dirt and debris deposit downwind.

(b) Surface winds also play an important role in the final location of the fallout particles. They pile fallout material in drifts, and winds cause localization in the crevices and ditches and against curbs and ledges. This effect is not locally predictable, but personnel must be aware of the probability of these highly intense accumulations of radioactive material occurring and their natural locations.

(3) Cold-Weather Operations.

(a) Weather conditions limit the number of passable roadways. Radiological contamination on the roadways may further restrict resupply and troop movement. Seasonal high winds in the arctic may present a problem in radiological contamination predictions. These winds may reduce dose rates at GZ. At the same time, they extend the area coverage and create a problem for survey and monitoring teams. Hot spots or areas of concentrated accumulation of radiological contamination may also occur in the areas of heavy snow and snow drifts.

(b) At subzero temperatures, the radius of damage to material targets can increase as much as 20 percent. Blast effects can drastically interfere with troop movement by breaking up ice covers and causing quick thaws. These effects can cause avalanches in mountainous areas. In flat lands, the blast may disturb the permafrost to such an extent as to restrict or disrupt movement.

(c) The reflecting nature of the surface over which a weapon is detonated can significantly influence the distance to which blast effects extend. Generally, reflecting surfaces (such as thin layers of ice, snow, and water) increase the distance to which overpressures extend.

(d) The high reflectivity of ice and snow may increase the minimum safe distance (MSD) as much as 50 percent for unwarned troops and for warned, exposed troops. Reflectivity may also increase the number of personnel whose vision is affected by the brilliant flash or light dazzle especially at night.

(e) Cold temperatures also reduce thermal effects on materials. Snow, ice, and frost coverings on combustible materials greatly reduce the tendency of the materials to catch fire. However, thermal effects will dry out exposed tundra areas, and grass fires may result.

(4) Mountain Operations.

(a) The clear mountain air extends the range of casualty-producing thermal effects. Within this range, however, the added clothing required by the cool temperatures at high altitudes reduces casualties from these effects.

(b) In the mountains, the deposit of radiological contamination will be very erratic because of the rapidly changing wind patterns. Hot spots may occur far from the point of detonation, and low intensity areas may occur very near it. Limited mobility makes radiological surveys on the ground difficult, and the difficulty of maintaining a constant flight altitude makes air surveys highly inaccurate.

(5) Desert Operations. Desert operations present many varying problems. Desert daytime temperatures can vary between 90°F to 125°F (32°C to 52°C). These temperatures create an unstable temperature gradient. However, with nightfall, the desert cools rapidly and a stable temperature gradient results. The possibility of a night attack must be considered in all planning. Blowing winds and sand make widespread radiological survey patterns likely.

(6) Jungle Operations. Radiation hazards may be reduced because some of the falling particles are retained by the jungle canopy. Subsequent rains, however, will wash these particles to the ground and concentrate them in water collection areas. Radiation hot spots will result.

b. Biological.

(1) Air Stability. A stable atmosphere results in the greatest cloud concentration and area coverage of biological agents. Under unstable and neutral stability conditions, more atmospheric mixing occurs. This leads to a cloud of lower concentration, but the concentration is sufficient enough to inflict significant casualties. The coverage area under unstable stability conditions is also reduced. Table D-1, page D-4, provides a snapshot of how weather effects the biological dissemination.

Table D-1. Weather Effects on Biological Dissemination

| Weather Conditions | Cloud Performance | Operational Considerations |
|---|--|--|
| Favorable Stable or Inversion Conditions | Agent clouds travel downwind for long distances before they spread laterally. High humidity and light rains generally favor wet agent dissemination. | Agent clouds tend to dissipate uniformly and remain cohesive as they travel downwind. Clouds lie low to the ground and may not rise high enough to cover the tops of tall buildings or other tall objects. |
| Marginal Neutral Conditions | Agent clouds tend to dissipate quickly. | More agent is required for the same result as those achieved in stable conditions. Desired results may not be achieved. |
| Unfavorable Unstable or Lapse Conditions | Agent clouds rise rapidly and do not travel downwind any appreciable distance. Cold temperatures affect wet agent dissemination. | Agent clouds tend to break up and become diffused. There is little operational benefit from off-target dissemination. |

(2) **Temperature.** Air temperature in the surface boundary layer is related to the amount of sunlight the ground has received. Normal atmospheric temperatures have little direct effect on the microorganisms of a biological aerosol. Indirectly, however, an increase in the evaporation rate of the aerosol droplets normally follows a temperature increase. There is evidence that survival of most pathogens decreases sharply in the range of minus 20°C to minus 40°C and above 49°C. High temperatures kill most bacteria and most viral and rickettsial agents. However, these temperatures will seldom, if ever, be encountered under natural conditions. Subfreezing temperatures tend to quick-freeze the aerosol after its release, thus decreasing the rate of decay. Exposure to ultraviolet (UV) light (one form of the sun's radiation) increases the decay rate of microorganisms. UV light, therefore, has a destructive effect upon biological aerosol. Most toxins are more stable than pathogens and are less susceptible to the influence of temperature.

(3) **Relative Humidity.** The relative humidity level favoring employment of a biological agent aerosol depends on whether the aerosol is distributed wet or dry. For a wet aerosol, a high relative humidity retards evaporation of the tiny droplets containing the microorganisms. This decreases the decay rate of wet agents, as drying results in the death of these microorganisms. On the other hand, a low relative humidity is favorable for the employment of dry agents. When the humidity is high, the additional moisture in the air may increase the decay rate of the microorganisms of the dry aerosol. This is because moisture speeds up the life cycle of the microorganisms. Most toxins are more stable than pathogens and are less susceptible to the influence of relative humidity.

(4) **Pollutants.** Atmospheric pollutant gases can also affect the survival of pathogens. Pollutant gases have been found to decrease the survival of many pathogens. These gases include nitrogen dioxide, sulfur dioxide, ozone, and carbon monoxide. This could be a significant factor in the battlefield where the air is often polluted.

(5) **Cloud Coverage.** Cloud coverage in an area influences the amount of solar radiation received by aerosol. Thus, clouds decrease the amount of destructive UV light that the microorganisms receive. Cloud coverage also influences factors such as ground temperature and relative humidity.

(6) **Precipitation.** Precipitation may wash suspended particles from the air. This washout may be significant in a heavy rainstorm but minimal at other times. High relative humidity associated with mist, drizzle, or very light rain is also an important

factor. Humidity may be favorable or unfavorable, depending on the type of agent. The low temperatures associated with ice, snow, and other winter precipitation prolong the life of most biological agents.

c. Chemical. Adversaries will seek to employ chemical agents under favorable weather conditions, if possible, to increase their effectiveness. Table D-2 provides an overview of how weather effects aerosolized chemical agents.

Table D-2. Weather Effects on Aerosol Chemical Agents

| Factors | Wind Speed (kph) | Air Stability | Temperature (°C) | Humidity (percent) | Precipitation |
|-------------|------------------|---------------|------------------|--------------------|---------------|
| Favorable | Steady <5 | Stable | >21 | >60 | None |
| Moderate | Steady 5–13 | Neutral | 4–21 | 40–60 | Light |
| Unfavorable | >13 | Unstable | <4 | <40 | Any |

(1) Atmospheric Stability. One of the key factors in using chemical weapons is the determination of the atmospheric stability condition that will exist at the time of attack. This determination can be made from a MET report or by observing field conditions.

(a) Unstable conditions (such as many rising and falling air currents and great turbulence) quickly disperse chemical agents. Unstable is the least favorable condition for chemical agent use because it results in a lower concentration, thereby reducing the area affected by the agent. Many more munitions are required to attain the commander's objectives under unstable conditions than under stable or neutral conditions.

(b) Stable conditions (such as low wind speeds and slight turbulence) produce the highest concentrations. Chemical agents remain near the ground and may travel for long distances before being dissipated. Stable conditions encourage the agent cloud to remain intact, thus allowing it to cover extremely large areas without diffusion. However, the direction and extent of cloud travel under stable conditions are not predictable if there are no dependable local wind data. A very stable condition is the most favorable for achieving a high concentration from a chemical cloud being dispersed.

(c) Neutral conditions are moderately favorable. With low wind speed and smooth terrain, large areas may be effectively covered. The neutral condition occurs at dawn and sunset and generally is the most predictable. For this reason, a neutral dispersion category is often best from a military standpoint.

(2) Vapor Concentration and Diffusion.

(a) Agent concentration is governed by the volume of the agent cloud. Since clouds continually expand, agent concentration levels decrease over time. Wind speed determines the downwind growth of the cloud. Vertical and horizontal turbulence determines the height and width of the cloud. The rate at which the downwind, vertical, and horizontal components expand governs the cloud volume and the agent concentration.

(b) To be effective at a specific concentration level, the agent cloud must remain in the target area for a definite period. Wind in the target area mixes the agent and distributes it over the target after release. For ground targets, high concentrations and good coverage can best be achieved with low turbulence and calm winds when the agent is

delivered directly on target. A steady, predictable wind drift over the target is best when the agent is delivered on the upwind side of the target. Conditions other than these tend to produce lower concentrations and poorer target coverage. However, unless the weather conditions are known within the target area, the effects of the agent on the target will be approximations.

(c) The concentration and diffusion of a chemical-agent cloud are also influenced by the following:

- Hydrolysis is a process in which (chemical) compounds decompose and split into other compounds by taking up the elements of water. Chemical agents with high hydrolysis rates are less effective under high-humidity conditions.
- Absorption is the process of the agent being taken into the vegetation, skin, soil, or material. Adsorption is the adding of a thin layer of agent to vegetation or other surfaces. This is important in dense vegetation. Absorption and adsorption of chemical agents may kill vegetation, thus defoliating the area of employment.
- Shifting air currents and horizontal turbulence blow a chemical cloud from side to side. The side-to-side motion of the air is called *meandering*. While the agent cloud meanders, it also spreads laterally. Lateral spreading is called *lateral diffusion*. In unstable conditions, the lateral spread tends to be greater than in stable conditions.
- Wind currents carry chemical clouds along the ground with a rolling motion. This is caused by the differences in wind velocity. Wind speeds increase rapidly from near zero at the ground to higher speeds at higher elevations aboveground. The drag effect by the ground, together with the interference of vegetation and other ground objects, causes the base of an agent cloud to be retarded as the cloud stretches out in length. When clouds are released on the ground, the drag amounts to about 10 percent of the vertical growth over distance traveled on grass, plowed land, or water. It amounts to about 20 percent over gently rolling terrain covered with bushes, growing crops, or small patches of scattered timber. In heavy woods, the drag effect is greatly increased.
- Wind speeds can vary at different heights. The wind direction can also change with an increase in height; this is known as *wind shear*. Because of wind shear, a puff (or chemical cloud) may become stretched in the downwind direction and may travel in a direction different from that of the surface wind. Additionally, a chemical cloud released in the air may be carried along faster than it can diffuse downward. As a result, air near the ground on the forward edge of the cloud may be uncontaminated while the air a few feet up may be heavily contaminated. This layering effect becomes more pronounced and increases proportionately with the distance of the forward edge of the cloud from the source.
- The vertical rise of a chemical cloud depends on the weather variables (such as temperature gradient, wind speed, and turbulence) and the difference between the densities of the clouds and the surrounding air. As mentioned earlier, the temperature of the cloud and the air influences their relative densities. Hotter gases are less dense and, therefore, lighter than cooler gases and air. Therefore, they rise until they are mixed and somewhat diluted and then attain the same temperature and approximately the same density as the surrounding air.

- The vapor cloud formed by an agent normally employed for a persistent effect rises in a similar manner, but vapor concentrations build up more gradually.

(3) Wind.

(a) High wind speeds cause rapid dispersion of vapors or aerosols, thereby decreasing the effective coverage of the target area and the time of exposure to the agent. In high winds, larger quantities of munitions are required to ensure the effective concentrations. Agent clouds are most effective when wind speeds are less than 4 knots and steady in direction. The clouds move with the prevailing wind as altered by terrain and vegetation. Steady, low wind (speeds of 3 to 7 knots) enhances the coverage area unless an unstable condition exists. With high winds, chemical agents cannot be economically employed to achieve casualties.

(b) The evaporation of liquid agents due to wind speed depends on the amount of the liquid exposed to the wind (the surface of the liquid) and the rate that the air passes over the agent. Therefore, the duration of effectiveness is longer at the places of greater liquid-agent contamination and in places where the liquid agent is sheltered from the wind.

(c) The evaporation rate of agents employed for persistent effect in a liquid state is proportional to the wind speed. If the speed increases, evaporation increases, thus shortening the duration of the effective contamination. Increased evaporation, in turn, creates a larger vapor cloud. The vapor cloud is dispersed by higher winds. The creation and dispersion of the vapor is a continuous process, increasing or decreasing in proportion to the wind speed.

(4) Temperature. There will be increased vaporization with higher temperatures. Also, the rate of evaporation of any remaining liquid agent from an exploding munition can vary with the temperature.

(5) Humidity. Humidity is the measure of the water vapor content in the air. Hydrolysis is a process where compounds react to chemical change with water, resulting in chemical agents with high hydrolysis. Rates are less effective under conditions of high humidity. Humidity has little effect on most chemical-agent clouds. Some agents (phosgene and lewisite) hydrolyze quite readily. Hydrolysis causes these chemical agents to break down and change their chemical characteristics. If the relative humidity exceeds 70 percent, phosgene and lewisite cannot be employed effectively except for a surprise time-on-target attack because of rapid hydrolysis. Lewisite hydrolysis by-products are not dangerous to the skin; however, they are toxic if taken internally because of the arsenic content. The riot control agent CS also hydrolyzes, although slowly, in high humidity. High humidity combined with high temperatures may increase the effectiveness of some agents because of body perspiration that will absorb the agents and allow for better transfer.

(6) Precipitation.

(a) The overall effect of precipitation is unfavorable because it is extremely effective in washing chemical vapors and aerosols from the air, vegetation, and material. Weather forecasts or observations indicating the presence of, or potential for, precipitation present an unfavorable environment for the employment of chemical agents. However, light rains distribute persistent agents more evenly over a large surface. Since

more liquid is then exposed to the air, the rate of evaporation may increase and cause higher vapor concentrations. Precipitation also accelerates the hydrolysis effect. Heavy rain or rain of a long duration tends to wash away liquid chemical agents. These agents may then collect in areas previously uncontaminated (such as stream beds and depressions) and present an unplanned contamination hazard.

(b) The evaporation rate of a liquid agent reduces when the agent is covered with water, but returns to normal when the water is gone. Precipitation may bring some persistent agents back to the surface as contact hazards that have previously lost their contact effectiveness by soaking into the soil or other porous surfaces.

(c) Snow acts as a blanket, covering the liquid contaminant. It lowers the surface temperature and slows evaporation so that only very low vapor concentrations form. When the snow melts, the danger of the contamination reappears; however, hydrolysis may reduce its operational effectiveness.

3. Overview of Meteorological Reports

Weather reporting must be thoroughly integrated into the CBRNWRS.

a. BWR.

(1) The BWR provides information on the wind conditions (i.e., wind direction and wind speed) in a number of layers from the surface of the earth to 30,000 meters (m) altitude. Each layer has a thickness of 2,000 m.

(2) The NBC BWR is an ADP-formatted message used to accommodate the two types of BWRs.

(a) The BWM provides wind directions and speeds at various elevations for an initial 6-hour period based on actual weather data.

(b) The BWF provides wind directions and speeds for a subsequent 6-hour period based on predicted data.

(3) Within each of the two types of BWRs, the message always begins with information on the wind conditions within the lowest layer first (from the surface to 2,000 m), then for the 2,000- to 4,000-m layer, etc. A numerical identifier is used for each of the layers, beginning with 2 for the 0 m–2,000 m layer, 4 for the 2,000 m–4,000 m layer, etc.

b. EDR.

(1) The EDR is used to provide the effective downwind data needed to predict a fallout area following a nuclear burst. Seven downwind speeds and downwind directions (toward which the wind is blowing) are transmitted within each BDR, corresponding to seven preselected weapon yield groups.

(2) The NBC EDR is an ADP-formatted message used to accommodate two types of EDRs.

(a) The EDM provides downwind speeds and directions for the selected seven yield groups during an initial 6-hour period.

(b) The EDF provides wind directions and speeds for selected yield groups for a subsequent 6-hour period.

(3) Special Case. When the effective downwind speed is less than 8 kilometers per hour (kph), the predicted fallout area will be circular and the radii of two concentric circles around GZ will be equal to the Zone I downwind distance and the Zone II downwind distance, respectively.

c. CDR.

(1) A CDR contains basic MET information for predicting biological aerosol or chemical vapor hazard areas. These reports are also used for ROTA incidents where Type T, TIM, Case 2, RDD, Case 3, biological bunker or production facility, or Case 4, chemical stockpile or TIM transport/storage are involved.

(2) The NBC CDR is an ADP-formatted message used to accommodate two types of CDRs.

(a) The CDM provides required weather information during an initial 6-hour period.

(b) The CDF provides required weather information for a subsequent 6-hour period.

(3) These reports are prepared by corps and division CBRN cells from information obtained through the assigned weather support element (USAF Air Weather Service (AWS), SWO, or Naval Oceanography Program representative).

(4) The CDR is transmitted at least four times a day, and each message is valid for a 6-hour period. Each 6-hour period is subdivided into three 2-hour subperiods.

d. MET Report Fields. Tables D-3 and D-4 (page D-10) provide fields and lines used in the different MET reports.

Table D-3. Common Message Headings for MET Reports

| Field | BWR | EDR | CDR |
|--|-----|-----|-----|
| EXER | O | O | O |
| OPER | C | C | C |
| MSGID | M | M | M |
| REF | O | O | O |
| DTG | M | M | M |
| ORGIDFT | M | M | M |
| NBCEVENT | M | M | M |
| M = Mandatory O = Optional C = Conditional | | | |

Table D-4. NBC MET Reports

| Field* | BWR | EDR | CDR |
|---|-----|-----|-----|
| AREAM | M | M | M |
| ZULUM | M | M | M |
| UNITM | M | M | M |
| LAYERM | M | - | - |
| ALFAM | - | M | - |
| BRAVOM | - | O | - |
| CHARLIEM | - | O | - |
| DELTAM | - | O | - |
| FOXTROT M | - | O | - |
| GOLFM | - | O | - |
| WHISKEYM | - | - | M |
| XRAYM | - | - | O |
| YANKEEM | - | - | O |
| *The letter M is added behind the field to signify a meteorological message. - = Not used M = Mandatory O = Optional | | | |

e. Common Report (ADP) Field Explanations.

- EXER

Exercise identification

Example using EXER/VALIANTCOURAGE2004/-//

EXER/VALIANTCOURAGE2004/-//

Exercise nickname

1–56 letters and numbers

Mandatory if EXER is used

EXER/VALIANTCOURAGE2004/-//

Additional identifier

4–16 letters and blank spaces

Optional if EXER is used

- OPER

Operation code word

Example using GRAND ACCOMPLISHMENT/-/-//

OPER/GRAND ACCOMPLISHMENT/-/-//

Operation code word

1–32 letters and blank spaces

Mandatory if OPER is used

OPER/GRAND ACCOMPLISHMENT/-/-//

Plan originator and number

5–36 letters and numbers

Optional if OPER is used

OPER/GRAND ACCOMPLISHMENT/-/-//

Nickname

1–23 letters and numbers

Optional if OPER is used

OPER/GRAND ACCOMPLISHMENT/-/-//

Secondary nickname

1–23 letters and numbers

Optional if OPER is used

- MSGID

Message text identifier

Example using MSGID/CDR/AWS/382856/-/-//

MSGID/CDR/AWS/382856/-/-//

Message text format identifier

3–20 letters and numbers

Mandatory

MSGID/CDR/AWS/382856/-/-//

Originator

1–30 letters and numbers

Mandatory

MSGID/CDR/AWS/382856/-/-//

Message serial number

1–7 numbers

Mandatory

MSGID/CDR/AWS/382856/-/-//

Month name

3 letters

Optional

MSGID/CDR/AWS/382856/-/-//

Qualifier

3 letters

Optional

MSGID/CDR/AWS/382856/-/-//

Serial number of qualifier

1–3 numbers

Optional

- REF

Reference

Example using REF/A/CMP/NBCACCUK/20040427/-/-//

REF/A/CMP/NBCACCUK/20040427/-/-//

Serial letter

1 letter

Mandatory

REF/A/CMP/NBCACCUK/20040427/-/-//

Communication type

3–20 letters and numbers

REF/A/CMP/NBCACCUK/20040427/-/-//

Originator

1–30 letters and numbers

REF/A/CMP/NBCACCUK/20040427/-/-//

DTG of Reference

6 numbers

DTG of Reference

7 letters or numbers

Verified DTG of Reference

8 letters or numbers

DTG and Month of Reference

10 letters or numbers

Verified DTG and Month of Reference

11 letters or numbers

DTG of Reference

14 letters or numbers

Verified DTG of Reference

15 letters or numbers

Date of Reference, Day-Alpha month-Year

9 letters or numbers

Date of Reference, Day-Month-Year

8 numbers

Date of Reference, Year-Month-Day

8 numbers

REF/A/CMP/NBCACCUK/20040427/-/-//

Reference serial number or

Document serial number

10 letters or numbers

Optional

REF/A/CMP/NBCACCUK/20040427/-/-//

Special notification

5 letters

Optional

REF/A/CMP/NBCACCUK/20040427/-/-//

Signal indicator code (SIC) or

File number

1–10 letters or numbers

Can be repeated 3 times

Optional

- DTG

DTG

14 letters and numbers

Example using DTG/231100ZNOV2004//

DTG/231100ZNOV2004//

Day of the month

DTG/231100ZNOV2004//

Time in Zulu

DTG/231100ZNOV2004//

Month and Year

- ORGIDDFT

Organization designator of drafter/releaser

Example using ORGIDDFT/UKRA/BAT/UK/AA/BB/CC/DD/AG/A/-//

ORGIDDFT/UKRA/BAT/UK/AA/BB/CC/DD/AG/A/-//

Unit designation name

1–15 letters, numbers, and special characters

Mandatory

ORGIDDFT/UKRA/BAT/UK/AA/BB/CC/DD/AG/A/-//

Unit size indicator

1–7 letters

Mandatory

ORGIDDFT/UKRA/BAT/UK/AA/BB/CC/DD/AG/A/-//

Geographical entity

2 letters

Mandatory

ORGIDDFT/UKRA/BAT/UK/AA/BB/CC/DD/AG/A/-//

Unit role indicator code “A”

2– letters

Mandatory

ORGIDDFT/UKRA/BAT/UK/AA/BB/CC/DD/AG/A/-//

Unit role indicator code “B”

2–6 letters

Mandatory

ORGIDDFT/UKRA/BAT/UK/AA/BB/CC/DD/AG/A/-//

Unit role indicator code “C”

2–6 letters

Mandatory

ORGIDDFT/UKRA/BAT/UK/AA/BB/CC/DD/AG/A/-//

Unit role indicator code “D”

2–6 letters

Mandatory

ORGIDDFT/UKRA/BAT/UK/AA/BB/CC/DD/AG/A/-//

Higher formation name

1–15 letters, numbers, or special characters

Mandatory

ORGIDDFT/UKRA/BAT/UK/AA/BB/CC/DD/AG/A/-//

Armed service (1 letter or number) or

Civilian agency code (2–8 letter and numbers)

Mandatory

ORGIDDF/UKRA/BAT/UK/AA/BB/CC/DD/AG/A/-//

Unit identification code (UIC)

7–9 letters and numbers

Conditional

- NBCEVENT

Type of NBC MET report

Example using NBCEVENT/CDM/-//

NBCEVENT/CDM/-//

Type of weather report

BWM

BWF

EDM

EDF

CDM

CDF

3 letters

NBCEVENT/CDM/-//

Validation code

1–10 letters and numbers

Used only with ADP systems

f. MET Report (ADP) Field Explanations.

- AREAM

Area affected; may be a map sheet number or an area such as I CORPS

2–20 letters and numbers

- ZULUM

DTG for:

Observation time

Valid from

Valid to

Three sets of 14 letters and numbers

Example ZULUM

ZULUM/231100ZNOV2004/231200ZNOV2004/231800ZNOV2004//

Day of the month

ZULUM/231100ZNOV2004/231200ZNOV2004/231800ZNOV2004//

Time in Zulu

ZULUM/231100ZNOV2004/231200ZNOV2004/231800ZNOV2004//

Month and Year

- UNITM

Units of measurement used in the message

Example using UNITM/-/DGT/KPH/-//

Length or height

1-2 letters

NOTE: Not used for BWR or CDR

| | |
|----|--------------------------|
| - | Not used or unknown |
| KM | Kilometers |
| NM | Nautical Miles |
| FT | Feet |
| KF | Kilofeet (1,000 feet) |
| HM | Hectometers (100 meters) |
| YD | Yards |
| M | Meters |
| SM | Statute Miles |

UNITM/-/DGT/KPH/-// (3 letters for degrees and 4 letters for mils; direction from which the wind is blowing)

| | |
|-----|-------------------------|
| - | Not used or unknown |
| DGM | Degrees/Magnetic North |
| DGT | Degrees/True North |
| DGG | Degrees/Grid North (GN) |
| MLM | Mils/Magnetic North |
| MLT | Mils/True North |
| MLG | Mils/GN |

UNITM/-/DGT/KPH/-// (3 letters - Speed)

| | |
|-----|---------------------|
| - | Not used or unknown |
| KPH | Kilometers per Hour |
| MPS | Meters per Second |
| KTS | Knots |

MPH Miles per Hour

UNITM/-/DGT/KPH/-/ (1 letter - Temperature)

NOTE: Not used for EDR or BWR

- Not used or unknown

C Celsius

F Fahrenheit

- LAYERM

Wind conditions at 2,000 m increments up to 30,000 m

Repeatable up to 15 times

Example using LAYERM/02/265/020//

LAYERM/02/265/020// (2 numbers, wind layer)

02 0–2,000 m

04 2,000 m–4,000 m

28 26,000 m–28,000 m

30 28,000 m–30,000 m

LAYERM/04/290/030// (3 numbers for degrees and 4 numbers for mils; wind direction from which the wind is blowing)

LAYERM/26/025/020// (3 numbers, wind speed)

- ALFAM

Effective downwind for 2 KT and less

Example yield group explanations ALFAM/-/310/015/-/

ALFAM/-/310/015/-/ (yield group)

ALFAM

BRAVOM

CHARLIEM

DELTAM

ECHOM

FOXTROTM

GOLFM

ALFAM/-/310/015/-/ (radius of Zone 1)

- Not used or unknown

3 numbers

NOTE: If used, then direction, wind speed, and the angle of expansion are not used.

ALFAM/-/310/015/-// (direction the wind is heading towards)

3 numbers for degrees and 4 numbers for mils

ALFAM/-/310/015/-// (wind speed)

- Not used or unknown

3 numbers

ALFAM/-/310/015/-// (angle of expansion)

- Not used or unknown

1 number

| | |
|---|-----------------------|
| 4 | 40 degrees |
| 5 | 50 degrees |
| 6 | 60 degrees |
| 7 | 70 degrees |
| 8 | 80 degrees |
| 9 | 90 degrees |
| 0 | 100 degrees |
| 1 | 110 degrees |
| 2 | 120 degrees |
| 3 | more than 120 degrees |

- BRAVOM
Effective downwind for more than 2 KT to 5 KT yield group
Same as ALFAM
- CHARLIEM
Effective downwind for 5 KT to 30 KT yield group
Same as ALFAM
- DELTAM
Effective downwind for more than 30 KT to 100 KT yield group
Same as ALFAM
- ECHOM
Effective downwind for 100 KT to 300 KT yield group
Same as ALFAM
- FOXTROTM
Effective downwind for 300 KT to 1 MT yield group
Same as ALFAM

- GOLF M
Effective downwind for more than 1 MT to 3 MT yield group
Same as ALFAM
- WHISKEY M
Weather conditions for first of three consecutive 2-hour periods

NOTE: The optimal measuring height should be 10 m aboveground in open terrain averaged over a period of 10 minutes.

Example using WHISKEYM/120/010/4/18/7/4/2//

WHISKEYM/120/010/4/18/7/4/2//

Downwind direction

3 numbers for degrees and 4 numbers for mils

WHISKEYM/120/010/4/18/7/4/2//

Wind speed

3 numbers

NOTE: The optimal measuring height should be 10 m aboveground in open terrain averaged over a period of 10 minutes.

WHISKEYM/120/010/4/18/7/4/2//

Air stability

1 letter or number

Simplified

U Unstable

N Neutral

S Stable

Detailed

1 Very Unstable

2 Unstable

3 Slightly Unstable

4 Neutral

5 Slightly Stable

6 Stable

7 Very Stable

WHISKEYM/120/010/4/18/7/4/2//

Temperature

1 special character and 2 numbers or 2 to 3 numbers

| | |
|-----|------------------|
| -20 | Minus 20 degrees |
| -03 | Minus 3 degrees |
| 00 | 0 degrees |
| 02 | 2 degrees |
| 15 | 15 degrees |
| 999 | 999 degrees |

WHISKEYM/120/010/4/18/7/4/2//

Humidity shown in percentage

1 number

| | |
|---|---------|
| 0 | 0–9% |
| 1 | 10–19% |
| 2 | 20–29% |
| 3 | 30–39% |
| 4 | 40–49% |
| 5 | 50–59% |
| 6 | 60–69% |
| 7 | 70–79% |
| 8 | 80–89% |
| 9 | 90–100% |

WHISKEYM/120/010/4/18/7/4/2//

Significant weather phenomena

1 letter or number

| | |
|---|---|
| 0 | No significant weather phenomena |
| 1 | Sea breeze |
| 2 | Land breeze |
| 3 | Blowing snow or sand |
| 4 | Fog, ice fog, or thick haze |
| 5 | Drizzle |
| 6 | Rain |
| 7 | Light rain or snow |
| 8 | Showers of rain, snow, hail, or a mixture |
| 9 | Thunderstorm |
| A | Top of inversion layer lower than 800 m |

- B Top of inversion layer lower than 400 m
- C Top of inversion layer lower than 200 m

WHISKEYM/120/010/4/18/7/4/2//

Cloud cover

1 number

- 0 Less than half-covered (scattered)
- 1 More than half-covered (broken)
- 2 Completely covered (overcast)
- 3 No clouds (clear conditions)

- XRAYM

Surface weather conditions for first of three consecutive 2-hour periods

See WHISKEYM for details of message

- YANKEEM

Surface weather conditions for first of three consecutive 2-hour periods

See WHISKEYM for details of message

4. Basic Wind Reports (Details and Examples)

This paragraph details how to effectively create and use BWRs.

a. BWRs. As described previously, the BWR is an ADP-formatted message used to accommodate the two types of BWRs—the BWM based on actual weather data, and the BWF based on predicted data. It provides wind conditions (direction and speed) in 2,000-meter intervals from the surface of the earth to 30,000 meters.

b. Wind Vector Plot.

(1) The information contained in the BWM is used for the construction of a wind vector plot. The BWM is converted into downwind directions for each layer of height by reversing the wind direction by 180 degrees.

(2) The wind speed of each layer, as given in the BWM, is represented by a vector, the length of which is extracted from the appropriate table. Tables D-5 through D-10 (pages D-22 through D-24) give the vector length in centimeters for different scale maps listed in kph and knots. Ensure that the correct map size and wind speed are selected.

NOTE: Above 18,000 meters, altitude layers for plotting vector diagrams continue at 2,000-meter intervals; however, since the map distance factors vary so little, some of the columns in the following tables have been combined for convenience.

Table D-5. Map Distance for Wind Speed (Map Scale 1:50,000)

| Wind Speed (kph) | Altitude Layers (Thousands of Meters) | | | | | | | | | | | |
|------------------|---------------------------------------|------|------|------|------|-------|-------|-------|-------|-------|-------|------|
| | 0-2 | 2-4 | 4-6 | 6-8 | 8-10 | 10-12 | 12-14 | 14-16 | 16-18 | 18-22 | 22-30 | >30 |
| 5 | 6.8 | 5.8 | 5.2 | 5.0 | 4.8 | 4.4 | 4.2 | 4.0 | 3.8 | 3.8 | 3.6 | 3.4 |
| 10 | 13.6 | 11.8 | 10.4 | 10.0 | 9.6 | 9.0 | 8.4 | 8.0 | 7.8 | 7.6 | 7.2 | 6.8 |
| 15 | 20.4 | 17.6 | 15.6 | 15.0 | 14.4 | 13.4 | 12.6 | 12.0 | 11.6 | 11.2 | 10.8 | 10.2 |
| 20 | 27.2 | 23.6 | 20.8 | 20.0 | 19.2 | 18.0 | 16.8 | 16.0 | 15.6 | 15.0 | 14.2 | 13.6 |
| 25 | 34.0 | 29.4 | 26.0 | 25.2 | 24.0 | 22.4 | 21.0 | 20.0 | 19.4 | 18.8 | 17.8 | 17.0 |

Table D-6. Map Distance for Wind Speed (Map Scale 1:100,000)

| Wind Speed (kph) | Altitude Layers (Thousands of Meters) | | | | | | | | | | | |
|------------------|---------------------------------------|------|------|------|------|-------|-------|-------|-------|-------|-------|------|
| | 0-2 | 2-4 | 4-6 | 6-8 | 8-10 | 10-12 | 12-14 | 14-16 | 16-18 | 18-22 | 22-30 | >30 |
| 5 | 3.4 | 2.9 | 2.6 | 2.5 | 2.4 | 2.2 | 2.1 | 2.0 | 1.9 | 1.9 | 1.8 | 1.7 |
| 10 | 6.8 | 5.9 | 5.2 | 5.0 | 4.8 | 4.5 | 4.2 | 4.0 | 3.9 | 3.8 | 3.6 | 3.4 |
| 15 | 10.2 | 8.8 | 7.8 | 7.5 | 7.2 | 6.7 | 6.3 | 6.0 | 5.8 | 5.6 | 5.4 | 5.1 |
| 20 | 13.6 | 11.8 | 10.4 | 10.0 | 9.6 | 9.0 | 8.4 | 8.0 | 7.8 | 7.5 | 7.1 | 6.8 |
| 25 | 17.0 | 14.7 | 13.0 | 12.6 | 12.0 | 11.2 | 10.5 | 10.0 | 9.7 | 9.4 | 8.9 | 8.5 |
| 30 | 20.4 | 17.7 | 15.6 | 15.1 | 14.4 | 13.4 | 12.6 | 12.0 | 11.7 | 11.3 | 10.7 | 10.2 |
| 35 | 23.8 | 20.6 | 18.1 | 17.6 | 16.8 | 15.7 | 14.7 | 14.0 | 13.6 | 13.1 | 12.5 | 11.9 |
| 40 | 27.2 | 23.6 | 20.7 | 20.1 | 19.2 | 17.9 | 16.8 | 16.0 | 15.6 | 15.0 | 14.3 | 13.6 |
| 45 | 30.6 | 26.5 | 23.3 | 22.6 | 21.6 | 20.2 | 19.0 | 18.0 | 17.5 | 16.9 | 16.1 | 15.3 |
| 50 | 34.0 | 29.5 | 25.9 | 25.1 | 24.0 | 22.4 | 21.1 | 20.0 | 19.4 | 18.8 | 17.9 | 17.0 |

Table D-7. Map Distance for Wind Speed (Map Scale 1:250,000)

| Wind Speed (kph) | Altitude Layers (Thousands of Meters) | | | | | | | | | | | |
|------------------|---------------------------------------|------|------|------|------|-------|-------|-------|-------|-------|-------|------|
| | 0-2 | 2-4 | 4-6 | 6-8 | 8-10 | 10-12 | 12-14 | 14-16 | 16-18 | 18-22 | 22-30 | >30 |
| 5 | 1.4 | 1.2 | 1.0 | 1.0 | 1.0 | 0.9 | 0.8 | 0.8 | 0.8 | 0.8 | 0.7 | 0.7 |
| 10 | 2.7 | 2.4 | 2.1 | 2.0 | 1.9 | 1.8 | 1.7 | 1.6 | 1.6 | 1.5 | 1.4 | 1.4 |
| 15 | 4.1 | 3.5 | 3.1 | 3.0 | 2.9 | 2.7 | 2.5 | 2.4 | 2.3 | 2.3 | 2.1 | 2.0 |
| 20 | 5.4 | 4.7 | 4.1 | 4.0 | 3.8 | 3.6 | 3.4 | 3.2 | 3.1 | 3.0 | 2.9 | 2.7 |
| 25 | 6.8 | 5.9 | 5.2 | 5.0 | 4.8 | 4.5 | 4.2 | 4.0 | 3.9 | 3.8 | 3.6 | 3.4 |
| 30 | 8.2 | 7.1 | 6.2 | 6.0 | 5.8 | 5.4 | 5.1 | 4.8 | 4.7 | 4.5 | 4.3 | 4.1 |
| 35 | 9.5 | 8.2 | 7.3 | 7.0 | 6.7 | 6.3 | 5.9 | 5.6 | 5.4 | 5.3 | 5.0 | 4.8 |
| 40 | 10.9 | 9.4 | 8.3 | 8.0 | 7.7 | 7.2 | 6.7 | 6.4 | 6.2 | 6.0 | 5.7 | 5.4 |
| 45 | 12.2 | 10.6 | 9.3 | 9.0 | 8.6 | 8.1 | 7.6 | 7.2 | 7.0 | 6.8 | 6.4 | 6.1 |
| 50 | 13.6 | 11.8 | 10.4 | 10.0 | 9.6 | 9.0 | 8.4 | 8.0 | 7.8 | 7.5 | 7.1 | 6.8 |
| 55 | 15.0 | 12.9 | 11.4 | 11.0 | 10.6 | 9.9 | 9.3 | 8.8 | 8.6 | 8.3 | 7.9 | 7.5 |
| 60 | 16.3 | 14.1 | 12.4 | 12.0 | 11.5 | 10.8 | 10.1 | 9.6 | 9.3 | 9.0 | 8.6 | 8.2 |
| 75 | 20.4 | 17.7 | 15.5 | 15.1 | 14.4 | 13.4 | 12.6 | 12.0 | 11.7 | 11.3 | 10.7 | 10.2 |
| 100 | 27.2 | 23.5 | 20.7 | 20.1 | 19.2 | 17.9 | 16.9 | 16.0 | 15.6 | 15.0 | 14.3 | 13.6 |

Table D-8. Map Distance for Wind Speed (Map Scale 1:50,000)

| Wind Speed (Knots) | Altitude Layers (Thousands of Meters) | | | | | | | | | | | |
|--------------------|---------------------------------------|------|------|------|------|-------|-------|-------|-------|-------|-------|------|
| | 0-2 | 2-4 | 4-6 | 6-8 | 8-10 | 10-12 | 12-14 | 14-16 | 16-18 | 18-22 | 22-30 | >30 |
| 5 | 12.6 | 11.0 | 9.6 | 9.4 | 9.0 | 8.4 | 7.8 | 7.4 | 7.2 | 7.0 | 6.6 | 6.4 |
| 10 | 25.2 | 21.8 | 19.2 | 18.6 | 17.8 | 16.6 | 15.6 | 14.8 | 14.4 | 14.0 | 13.2 | 12.6 |
| 15 | 37.8 | 32.8 | 28.8 | 28.0 | 26.8 | 25.0 | 23.4 | 22.2 | 21.6 | 20.8 | 19.6 | 19.0 |
| 20 | 50.4 | 43.6 | 38.4 | 37.2 | 35.6 | 33.2 | 31.2 | 29.6 | 28.8 | 27.8 | 26.2 | 25.2 |
| 25 | 63.0 | 54.6 | 48.0 | 46.6 | 44.6 | 41.2 | 39.0 | 37.0 | 36.0 | 34.8 | 32.8 | 31.6 |
| 30 | 65.6 | 65.4 | 57.6 | 55.8 | 53.4 | 49.8 | 46.8 | 44.4 | 43.2 | 41.8 | 39.4 | 37.8 |

Table D-9. Map Distance for Wind Speed (Map Scale 1:100,000)

| Wind Speed (Knots) | Altitude Layers (Thousands of Meters) | | | | | | | | | | | |
|--------------------|---------------------------------------|------|------|------|------|-------|-------|-------|-------|-------|-------|------|
| | 0-2 | 2-4 | 4-6 | 6-8 | 8-10 | 10-12 | 12-14 | 14-16 | 16-18 | 18-22 | 22-30 | >30 |
| 5 | 6.3 | 5.5 | 4.8 | 4.7 | 4.5 | 4.2 | 3.9 | 3.7 | 3.6 | 3.5 | 3.3 | 3.2 |
| 10 | 12.6 | 10.9 | 9.6 | 9.3 | 8.9 | 8.3 | 7.8 | 7.4 | 7.2 | 7.0 | 6.6 | 6.3 |
| 15 | 18.9 | 16.4 | 14.4 | 14.0 | 13.4 | 12.5 | 11.7 | 11.1 | 10.8 | 10.4 | 9.8 | 9.5 |
| 20 | 25.2 | 21.8 | 19.2 | 18.6 | 17.8 | 16.6 | 15.6 | 14.8 | 14.4 | 13.9 | 13.1 | 12.6 |
| 25 | 31.5 | 27.3 | 24.0 | 23.3 | 22.3 | 20.6 | 19.5 | 18.5 | 18.0 | 17.4 | 16.4 | 15.8 |
| 30 | 37.8 | 32.7 | 28.8 | 27.9 | 26.7 | 24.9 | 23.4 | 22.2 | 21.6 | 20.9 | 19.7 | 18.9 |
| 35 | 44.1 | 38.2 | 33.6 | 32.6 | 31.2 | 29.1 | 27.3 | 25.9 | 25.2 | 24.3 | 22.9 | 22.1 |
| 40 | 50.4 | 43.6 | 38.4 | 37.2 | 35.6 | 33.2 | 31.2 | 29.6 | 28.8 | 27.8 | 26.2 | 25.2 |
| 45 | 56.7 | 49.1 | 43.2 | 41.9 | 40.1 | 37.4 | 35.1 | 33.3 | 32.4 | 31.3 | 29.5 | 28.4 |
| 50 | 63.0 | 54.5 | 48.0 | 46.5 | 44.5 | 41.5 | 39.0 | 37.0 | 36.0 | 34.8 | 32.8 | 31.5 |

Table D-10. Map Distance for Wind Speed (Map Scale 1:250,000)

| Wind Speed (Knots) | Altitude Layers (Thousands of Meters) | | | | | | | | | | | |
|--------------------|---------------------------------------|------|------|------|------|-------|-------|-------|-------|-------|-------|------|
| | 0-2 | 2-4 | 4-6 | 6-8 | 8-10 | 10-12 | 12-14 | 14-16 | 16-18 | 18-22 | 22-30 | >30 |
| 5 | 2.5 | 2.2 | 1.9 | 1.9 | 1.8 | 1.7 | 1.6 | 1.5 | 1.4 | 1.4 | 1.3 | 1.3 |
| 10 | 5.0 | 4.4 | 3.8 | 3.7 | 3.6 | 3.3 | 3.1 | 3.0 | 2.9 | 2.8 | 2.6 | 2.5 |
| 15 | 7.6 | 6.5 | 5.8 | 5.6 | 5.3 | 5.0 | 4.7 | 4.4 | 4.3 | 4.2 | 3.9 | 3.8 |
| 20 | 10.1 | 8.7 | 7.7 | 7.4 | 7.1 | 6.6 | 6.2 | 5.9 | 5.8 | 5.6 | 5.2 | 5.0 |
| 25 | 12.6 | 10.9 | 9.6 | 9.3 | 8.9 | 8.3 | 7.8 | 7.4 | 7.2 | 7.0 | 6.6 | 6.3 |
| 30 | 15.1 | 13.1 | 11.5 | 11.2 | 10.7 | 10.0 | 9.4 | 8.9 | 8.6 | 8.3 | 7.9 | 7.6 |
| 35 | 17.6 | 15.3 | 13.4 | 13.0 | 12.5 | 11.6 | 10.9 | 10.4 | 10.1 | 9.7 | 9.2 | 8.8 |
| 40 | 20.2 | 17.4 | 15.4 | 14.9 | 14.2 | 13.3 | 12.5 | 11.8 | 11.5 | 11.1 | 10.5 | 10.1 |
| 45 | 22.7 | 19.6 | 17.3 | 16.7 | 16.0 | 14.9 | 14.0 | 13.3 | 13.0 | 12.5 | 11.8 | 11.3 |
| 50 | 25.2 | 21.8 | 19.2 | 18.6 | 17.8 | 16.6 | 15.6 | 14.8 | 14.4 | 13.9 | 13.1 | 12.6 |
| 55 | 27.7 | 24.0 | 21.1 | 20.5 | 19.6 | 18.3 | 17.2 | 16.3 | 15.8 | 15.3 | 14.4 | 13.9 |
| 60 | 30.2 | 26.2 | 23.0 | 22.3 | 21.4 | 19.9 | 18.7 | 17.8 | 17.3 | 16.7 | 15.7 | 15.1 |
| 75 | 37.8 | 32.7 | 28.8 | 27.9 | 26.7 | 24.9 | 23.4 | 22.2 | 21.6 | 20.9 | 19.7 | 18.9 |
| 100 | 50.4 | 43.6 | 38.4 | 37.2 | 35.6 | 33.2 | 31.2 | 29.6 | 28.8 | 27.8 | 26.2 | 25.2 |

(3) From GZ, draw a vector in the downwind direction of the layer 0-2,000 meters. Label the downwind end of the vector with the label 2, and label the vector length alongside the vector. The vector now represents the downwind direction and the downwind speed within the height layer from the surface to 2,000 meters.

(4) From the end of the first vector, draw the next vector. The downwind end of this vector is labeled 4, so the vector represents the downwind direction and downwind speed within the height layer 2,000 to 4,000 meters.

(5) Proceed in the same manner, using all information given in the BWR. The result will be a wind vector plot as shown in Figure D-1 (page D-26). The following is a sample of a BWR:

```
MSGID/BWR/AWS/382856/DEC /-/-//
DTG/250630ZDEC2004//
ORGIDDF/UKRA/BAT/UK/AA/BB/CC/DD/AG/A/-//
NBCEVENT/BWM/-//
AREAM/NFEB4//
ZULUM/250600ZDEC2004/230700ZDEC2004/241900ZDEC2004//
UNITM/-/DGG/KTS /-/
LAYERM/02/266/004/
LAYERM/04/289/007/
LAYERM/06/301/008/
LAYERM/08/311/008/
LAYERM/10/329/009/
LAYERM/12/339/009/
LAYERM/14/356/008/
LAYERM/16/009/007/
LAYERM/18/019/005/
LAYERM/20/015/003/
LAYERM/22/025/004/
LAYERM/24/029/004/
LAYERM/26/030/004/
LAYERM/28/031/005/
LAYERM/30/034/005//
```

NOTE: Unless otherwise annotated, winds are taken “from” not in the direction “to”; therefore, the back azimuth must be taken (more than 180°, subtract 180; less than 180°, add 180). If the windspeed is provided in kph rather than knots per hour, then multiply by 0.54 (see Tables D-11 and D-12, page D-27).

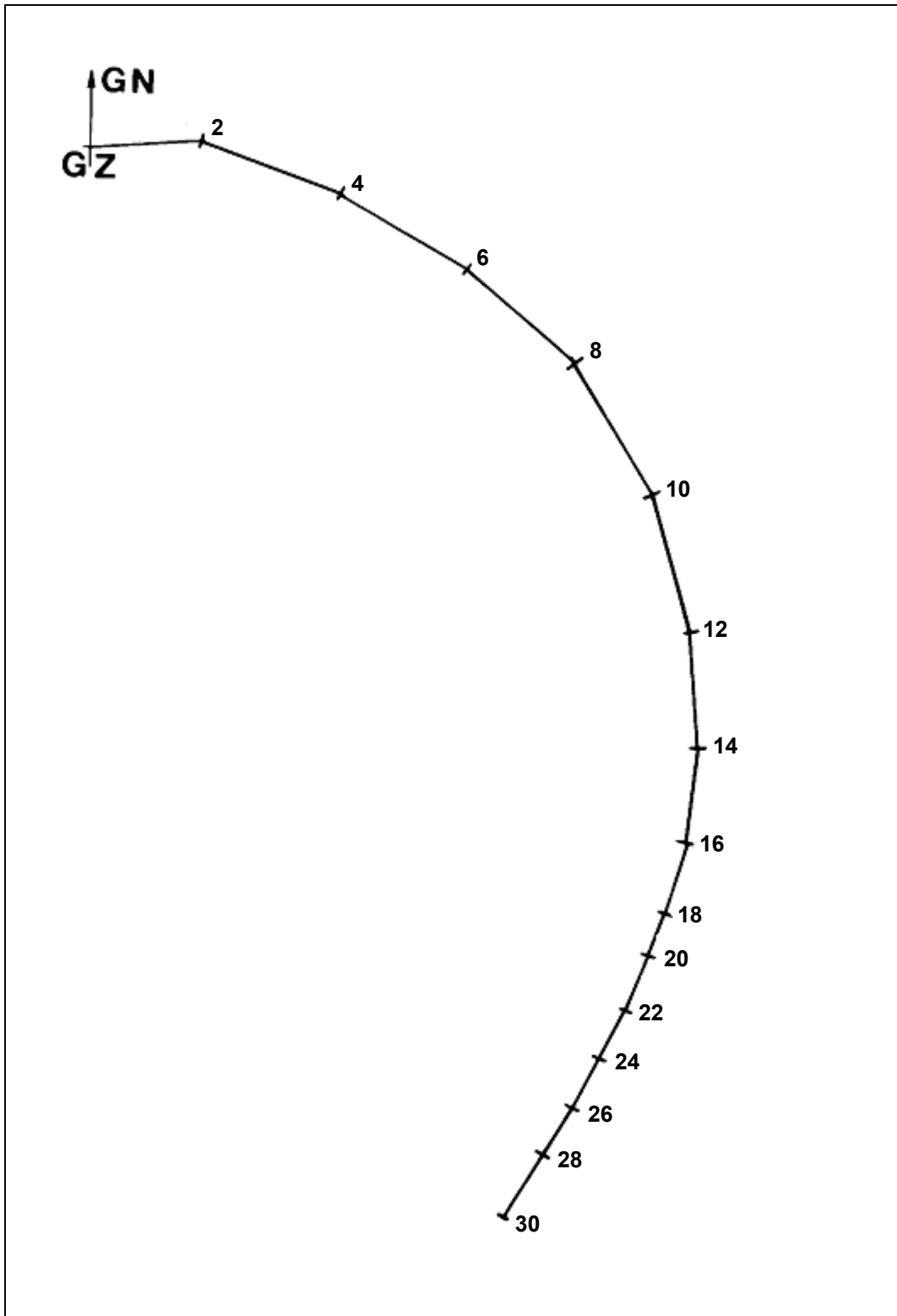

Figure D-1. Example Wind Vector Plot

Table D-11. Weighting Factor Table

| WIND LAYER (10³ meters) | Weighting Factor |
|---|-------------------------|
| 0–2 | 1.26 |
| 2–4 | 1.09 |
| 4–6 | 0.96 |
| 6–8 | 0.93 |
| 8–10 | 0.89 |
| 10–12 | 0.83 |
| 12–14 | 0.78 |
| 14–16 | 0.74 |
| 16–18 | 0.72 |
| 18–20 | 0.70 |
| 20–22 | 0.69 |
| 22–24 | 0.67 |
| 24–26 | 0.67 |
| 26–28 | 0.65 |
| 28–30 | 0.63 |
| NOTE: Multiply the wind speed, in knots, by the weighting factor to obtain the vector length, in kilometers. | |

Table D-12. Wind Vector Lengths

| Wind Layer (10³ meters) | Weighting Factor | Wind Speed (knots) | Vector Length (km) |
|---|-------------------------|-------------------------------|-------------------------------|
| 0–2 | 1.26 | 4 | 5.04 |
| 2–4 | 1.09 | 7 | 7.63 |
| 4–6 | 0.96 | 8 | 7.68 |
| 6–8 | 0.93 | 8 | 7.44 |
| 8–10 | 0.89 | 9 | 8.01 |
| 10–12 | 0.83 | 9 | 7.47 |
| 12–14 | 0.78 | 8 | 6.24 |
| 14–16 | 0.74 | 7 | 4.90 |
| 16–18 | 0.72 | 5 | 3.60 |
| 18–20 | 0.70 | 3 | 2.16 |
| 20–22 | 0.69 | 4 | 2.76 |
| 22–24 | 0.67 | 4 | 2.68 |
| 24–26 | 0.67 | 4 | 2.68 |
| 26–28 | 0.65 | 5 | 3.25 |
| 28–30 | 0.63 | 5 | 3.15 |

5. Effective Downwind Reports (Details and Example)

The EDR is used to provide the effective downwind data needed to predict a fallout area following a nuclear burst for the nearest 6-hour period (EDR) or for a period more than 6 hours ahead (EDF). Seven downwind speeds and corresponding downwind directions are transmitted in the EDM, corresponding to seven preselected weapon yield groups.

a. Since effective downwind speed and effective downwind direction vary with the yield, seven downwind speeds and downwind directions are transmitted, corresponding to seven preselected yield groups, ALFA through GOLF as follows:

| | | | | | |
|----------|----|---|----------|---|-----------------|
| ALFAM | is | ≤ | 2 KT | | |
| BRAVOM | is | > | 2 KT | ≤ | 5 KT |
| CHARLIEM | is | > | 5 KT | ≤ | 30 KT |
| DELTAM | is | > | 30 KT | ≤ | 100 KT |
| ECHOM | is | > | 100 KT | ≤ | 300 KT |
| FOXTROTM | is | > | 300 KT | ≤ | 1,000 KT (1 MT) |
| GOLFM | is | > | 1,000 KT | ≤ | 3,000 KT (3 MT) |

b. To calculate the data, use the following procedure with 2 KT for ALFAM, 5 KT for BRAVOM, and 30 KT for CHARLIEM and so on.

(1) Step 1. Army users may obtain a blank DA Form 1971-3-R, *Effective Downwind Message Worksheet*, located in Appendix L (see Figure D-2).

| EFFECTIVE DOWNWIND MESSAGE WORKSHEET | | | | | | | | | | |
|---|------------|---------------------------|------------------------------|--------------------------|--------------------------------------|--|--|--|---|--------------------|
| For use of this form, see FM 3-11.3; the proponent agency is TRADOC | | | | | | | | | | |
| TIME OF WIND MEASUREMENT (DATE-TIME GROUP) <u>DDTTT</u> | | | | | | | | | | |
| DATA AND CALCULATIONS | | | | | | | | | | |
| MESSAGE LINE | YIELD (KT) | CLOUD-TOP HEIGHT (METERS) | CLOUD-BOTTOM HEIGHT (METERS) | 2/3 STEM HEIGHT (METERS) | ① DISTANCE OF GZ/CB RADIAL LINE (KM) | EFFECTIVE WIND SPEED-sss (KMPH) ① × 1 = sss TIME OF FALL ROUND OFF TO NEAREST KILOMETER PER HOUR | ② AZIMUTH OF GZ/CT RADIAL LINE (DEGREES) | ③ AZIMUTH OF GZ/2/3 STEM RADIAL LINE (DEGREES) | EFFECTIVE DOWNWIND DIRECTION-ddd (DEGREES) SUM OF | WARNING AREA ANGLE |
| A | 2 | 4,900 | 2,600 | 1,700 | _____ | _____ X 1.136 = _____ | _____ | _____ | ② + ③ = ② AND ③ = ddd' | |
| B | 5 | 7,100 | 4,400 | 2,800 | _____ | _____ X 0.758 = _____ | _____ | _____ | _____ = _____ = _____ | |
| C | 30 | 11,600 | 7,700 | 5,100 | _____ | _____ X 0.455 = _____ | _____ | _____ | _____ = _____ = _____ | |
| D | 100 | 14,400 | 9,300 | 6,200 | _____ | _____ X 0.385 = _____ | _____ | _____ | _____ = _____ = _____ | |
| E | 300 | 16,700 | 11,000 | 7,400 | _____ | _____ X 0.333 = _____ | _____ | _____ | _____ = _____ = _____ | |
| F | 1,000 | 21,600 | 13,500 | 9,000 | _____ | _____ X 0.286 = _____ | _____ | _____ | _____ = _____ = _____ | |
| G | 3,000 | 26,250 | 15,800 | 10,500 | _____ | _____ X 0.250 = _____ | _____ | _____ | _____ = _____ = _____ | |

EFFECTIVE DOWNWIND MESSAGE

| | | | | | |
|---------|--------|-------|-------|-------|-------|
| ZULU | DDTTTT | _____ | _____ | _____ | _____ |
| ALFA | dddsss | _____ | _____ | _____ | _____ |
| BRAVO | dddsss | _____ | _____ | _____ | _____ |
| CHARLIE | dddsss | _____ | _____ | _____ | _____ |
| DELTA | dddsss | _____ | _____ | _____ | _____ |
| ECHO | dddsss | _____ | _____ | _____ | _____ |
| FOXTROT | dddsss | _____ | _____ | _____ | _____ |
| GOLF | dddsss | _____ | _____ | _____ | _____ |

When the azimuth of the ground zero/cloud-top radial line ② or the azimuth of the ground zero/2/3 stem radial line ③ falls in the first quadrant (0° to 90°) and the other falls in the fourth quadrant (270° to 360°), result of $\frac{②+③}{②}$ will be the back azimuth of the effective downwind direction. In this case, determine ddd by the following method: If result is greater than 180°, subtract 180°; If result is less than 180°, add 180°. Enter in the effective downwind message.

DA FORM 1971-3-R, SEP 94 EDITION OF SEP 94 IS OBSOLETE AFD V2.00

Figure D-2. Effective Downwind Message Worksheet

(2) Step 2. Place a sheet of overlay paper over the wind vector plot, and mark a GN reference line and GZ. Mark the cloud top height, cloud bottom height, and 2/3 stem height for the 2 KT yield. Draw radial lines from GZ through these three points (see Figure D-3).

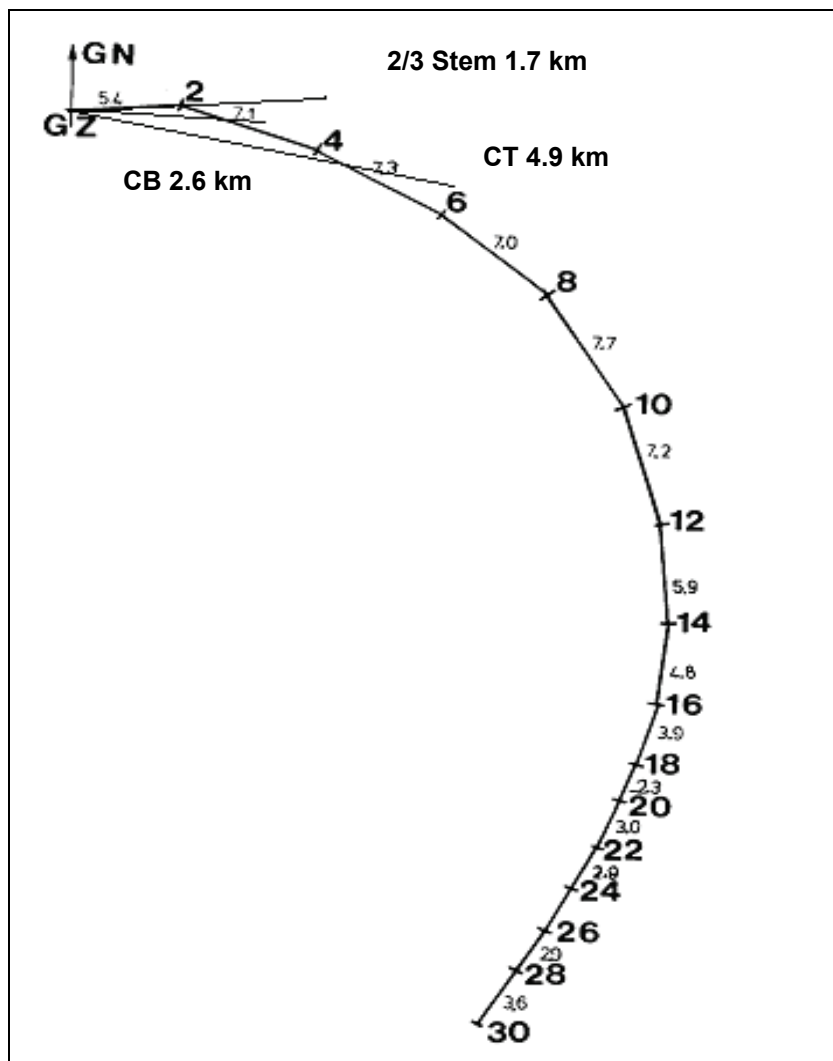

Figure D-3. Wind Vector Plot with Cloud and Stem Radial Lines (2 KT)

(3) Step 3. To determine the effective wind speed (sss), measure the distance along the cloud bottom radial line from GZ to its intersection with the wind vector plot at the cloud bottom height point. Multiply as indicated on the EDM work sheet. Round each result to the nearest kilometer (km) (28.4 km = 28, 28.5 km = 29 km).

NOTE: A situation may arise when the effective wind speed for one or more yield groups is less than 8 kph. In this case the downwind distance for Zone I is determined using a nomogram in Appendix J. Enter the nomogram with the effective wind speed of 8 kph on the left-hand scale and the highest yield for each

yield group on the right-hand scale. Then, read the downwind distance for Zone I on the center scale.

(4) Step 4. To determine the effective downwind direction, use a protractor and measure the azimuth from GZ to cloud top and the azimuth from GZ to 2/3 stem. Add these two measurements, and divide by 2. This is known as bisecting the angles. The result of this bisection is the effective downwind direction (ddd).

NOTE: When the GZ and/or the cloud top radial line or the GZ and/or the 2/3 stem radial line fall in the first quadrant (0 to 90) and the other radial line falls in the fourth quadrant (270 to 360), the result of adding the GZ/cloud top azimuth and the GZ and/or 2/3 stem azimuth divided by 2 will be the back azimuth of the ddd. In this case, determine ddd by the following method: If the total is greater than 180°, subtract 180°; if the total is less than 180°; add 180° and enter the ddd in the EDM.

(5) Step 5. Measure the angle between the cloud top and 2/3 stem. If the angle exceeds 40°, report the actual angle measured in the "Warning Area Angle" column of the EDM. If the angle measured is an odd number, round the angle to the next highest even number.

(6) Step 6. Repeat Steps 2 through 5 for the remaining yield groups. Use a separate sheet of overlay paper for each yield group.

(7) Step 7. Complete the EDM portion of the work sheet based on the data and calculations. Remember the 3-6-9 rule:

- 3 digits mean winds less than 8 kph, and digits represent the Zone I distance.
- 6 digits mean normal message.
- 9 digits mean expanded radial lines to a given number of degrees.

NOTE: For ADP EDM reports the expanded angle special case will only contain seven digits versus nine. For example if the EDM line reads CHARLIEM-/310/015/6/, the "6" represents an angle of 60°. See paragraph 5c below.

c. Special Cases.

(1) When the effective wind speed is less than 8 kph for a given yield group, the applicable line will contain only three digits. These three digits will represent the radial line distance of Zone I. In this case, no wind speed is given and the fallout pattern will be two concentric circles.

(2) Another special case occurs when the fallout is not expected to fall within the normal 40° angle of the prediction. In this case, the appropriate line on the EDM has nine digits. The first six digits represent wind direction and wind speed. The last three digits will be the angle in degrees between the left and right radial lines.

(3) The simplified procedure does not normally provide for a warning angle greater than 40°. In the instances where the detailed procedure demands an angle greater than 40°, this warning area is given in the EDM to subordinate units to expand their original warning area. The 40° standard angle between the two radial lines must be expanded in equal degrees on each side of the reference line.

The following is a sample EDM:

```
MSGID/CDR/AWS/382856/NOV/-/-//
DTG/231130NOV2004//
ORGIDDFT/UKRA/BAT/UK/AA/BB/CC/DD/AG/A/-//
NBCEVENT/EDM/-//
AREAM/NFEB4//
ZULUM/231100ZNOV2004/231200ZNOV2004/231800ZNOV2004//
UNITM/KM/DGT/KPH/-//
ALFAM/020/-/-/-/
BRAVOM/020/-/-/-/
CHARLIEM/-/310/015/6/
DELTAM/-/330/025/-/
ECHOM/-/350/045/-/
FOXTROTM/-/350/045/-/
GOLFM/-/340/050/-//
```

6. Chemical Downwind Reports (Details and Example)

This paragraph details how to effectively prepare and use CDRs.

a. General Preparation. A CDR contains basic MET information for predicting biological aerosol and chemical vapor hazard areas. These reports are also used for a ROTA incident. Biological agents will generally remain toxic through multiple changes in MET conditions and multiple CB MET reports.

(1) The CDR is prepared by corps and division CBRN staffs (or service equivalent) from information obtained through the USAF AWS, SWO, or Naval Oceanography Program. The CDR is transmitted at least four times a day, and each message is valid for a 6-hour period. Each 6-hour period is subdivided into three 2-hour periods.

(2) The NBC CDR is an ADP-formatted message that is used to accommodate the CDM which provides the required weather information during an initial 6-hour period or the CDF which provides required weather information for subsequent 6-hour periods. The following is a sample CDM:

```
MSGID/CDR/AWS/382856/NOV/-/-//
DTG/231130NOV2004//
ORGIDDFT/UKRA/BAT/UK/AA/BB/CC/DD/AG/A/-//
NBCEVENT/CDM/-//
AREAM/NFEB4//
ZULUM/231100ZNOV2004/231200ZNOV2004/231800ZNOV2004//
UNITM/-/DGT/KPH/C//
```

WHISKEYM/120/010/4/18/7/4/2//

XRAYM/100/015/4/15/7/5/2//

YANKEEM/110/010/4/13/7/6/2//

(3) The first step in preparing the CDM is to acquire the weather data. Weather information can also be obtained from the artillery MET section. Although the MET section cannot provide forecasts, it can provide current weather information.

(4) The next step is to break the information down into three consecutive 2-hour increments. WHISKEYM is used for the first 2-hour increment, XRAYM for the second, and YANKEEM for the final 2-hour increment. Then, the CBRN cell translates this data into codes and puts it in the proper format. Each forecast line contains 12 digits.

(5) The first six digits represent the downwind direction and wind speed. The last six digits represent the air stability, temperature, humidity, significant weather phenomena, and cloud cover. Weather data which is unavailable or for which no code exists is represented by a dash.

b. CDM Preparations Without Weather Service Support. A valid CDM may not always be available from the corps or division CBRN cell or applicable to the unit AO. Units may estimate the air stability category by observing local MET conditions. A field-expedient method of obtaining the necessary weather data may be used when all other sources are unavailable. In order to obtain local weather data, units may obtain a belt weather kit (National Stock Number [NSN] 6660-01-024-2638) and barometer (NSN 660-00-551-3998). The weather information obtained in this manner is only for that particular area, for that period of time. It is by no means a forecast from which a CDM may be produced. However, it is a local method of verifying CDM weather data. If this method is used for local weather, include this data on the NBC1 chemical report.

(1) Step 1. Measure the wind speed and direction with the lensatic compass and ananometer. Use the highest wind speed recorded. Take the temperature and humidity readings using the wet bulb at 1 meter aboveground. Obtain readings every 2 hours if practical, but not greater than 4 hours.

(2) Step 2. Determine the four transition periods of wind speed and direction during the day. Take the average of the readings during each transition period. The most difficult aspect is determining the sun by observation. Since most units do not have equipment to do this, make the best estimation possible. (Example: It is morning. The sun's angle is 45°, and the sky is less than half covered. Find the time of day [morning] and the angle of the sun [45°] in Table D-13. Find the sky condition [less than half-covered]. Read across and down to the point where the lines converge. The air stability category is U.)

Table D-13. Air Stability Category Basic Chart

| Time of Day | Angle of Sun | Condition of Sky | | |
|-------------|--------------|------------------------|------------------------|----------|
| | | Less Than Half-Covered | More Than Half-Covered | Overcast |
| Morning | <4 | S | S | N |
| | 5–32 | N | N | N |
| | 33–40 | U | N | N |
| | >40 | U | U | N |
| Evening | >46 | U | U | N |
| | 36–46 | U | N | N |
| | 13–35 | N | N | N |
| | 6–12 | S | N | N |
| | 0–5 | S | S | N |

S=Stable; N=Neutral; U=Unstable

(3) Atmospheric Stability Charts. The stability of a CB agent cloud is directly affected by the temperature of the air at the surface of the earth and the first few meters above the surface.

(4) Temperature Gradients. The air stability categories are dependent on the temperature gradient (difference of air temperature at two altitudes). The temperature gradient is determined by measuring the air temperature at two different altitudes. Compare the differences in air temperature to the normal or expected change in temperature. The normal change in temperature is 1° cooler for every 100 meters increase in altitude. The four possible gradient conditions are inversion, neutral, lapse, and elevated inversion.

(a) Inversion Temperature Gradient (Stable). If air at the higher altitude is warmer than the normal temperature at the lower altitude, the air will not move vertically. This represents an inversion temperature gradient. This condition usually exists on a clear night when middle and low clouds cover less than 30 percent of the sky and on early mornings until about 1 hour after sunrise when the wind speed is less than 5 knots. It is characterized by a minimum of convection currents and by maximum air stability, which is ideal for enemy employment of chemical agents. Weak inversion conditions tend to prevail during the day over large bodies of water.

(b) Neutral Temperature Gradient (Neutral). A neutral condition exists when the air temperature shows very little or no change with air increase in altitude. This represents the neutral temperature gradient. This condition usually exists on heavily overcast days or nights, at 1 or 2 hours before sunset or 1 to 2 hours after sunrise, when the middle and low clouds cover more than 30 percent of the sky. Independent of cloud cover and the time of day, a neutral condition may also exist when the wind speed is greater than 5 knots. Additionally, periods of precipitation are normally accompanied by a neutral condition. A neutral temperature gradient is most favorable for enemy use of biological agents because the associated wind speeds result in larger area coverage.

(c) Lapse Temperature Gradient (Unstable). If the air at the higher altitude is cooler than the expected difference, there will be vertical movement of air creating turbulence. This condition normally exists on a clear day, when the middle and low clouds cover less than 30 percent of the sky and when the wind speed is less than 5 knots. This is the least favorable condition for the enemy to employ CB agents. Over large bodies of water, weak lapse conditions tend to prevail at night. When a lapse condition exists, area coverage without diffusion will be enhanced with a steady low wind speed of 3 to 7 knots.

(d) Elevated Inversion (Stable).

- Elevated inversion may occur when cooler air settles under warmer air. This condition will generally occur when a warm and cold frontal system converge over a large body of water. Elevated inversions also occur when the stable boundary layer formed overnight weakens in the morning as the sun heats the surface. The significance of an elevated inversion layer is that the layer will act as a lid over the surface. This lid traps air particulates and chemical agents at a given height aboveground, thus presenting an increased threat to aircrews. The SWO must report this condition to the CBRN and divisional aviation units when it occurs.

- Once the air stability category has been obtained from Table D-13 (page D-33), enter the adjustment chart (Table D-14) with that category. Select the appropriate weather and terrain condition. Read across to where they intersect, and extract the final stability category. Use this stability category to determine the maximum downwind distance.

Table D-14. Air Stability Category Adjustment Chart

| Weather and Terrain | Stability Category from Table D-13 (page D-33) | | |
|----------------------------------|--|---|---|
| Dry to slightly moist surface | U | N | S |
| Wet surface | N | N | S |
| Frozen surface | N | S | S |
| Completely covered with snow | S | S | S |
| Continuous rainfall | N | N | N |
| Haze or mist (1–4 km visibility) | N | N | S |
| Fog (<1 km visibility) | N | S | S |
| Wind speed >18 kph | N | N | N |

NOTE: All conditions must be checked. If more than one applies, choose the most stable category.

c. Naval CDM. The Naval CDM is essentially computed in the same manner as the land CDM. In most cases, the CDM information is obtained through land-based CBRN centers. However, in the event that land CDM information is not available or differs significantly from the weather conditions at sea, Figure D-4 can be used to determine the stability category. The numbers 1 through 7 depicted on the graph correspond to the seven stability categories used in the land CDM. The seven stability categories indicated on Figure D-4 are as follows:

- 1—Very unstable.
- 2—Unstable.
- 3—Slightly unstable.
- 4—Neutral.

- 5 - Slightly Stable
- 6 - Stable
- 7 - Very Stable

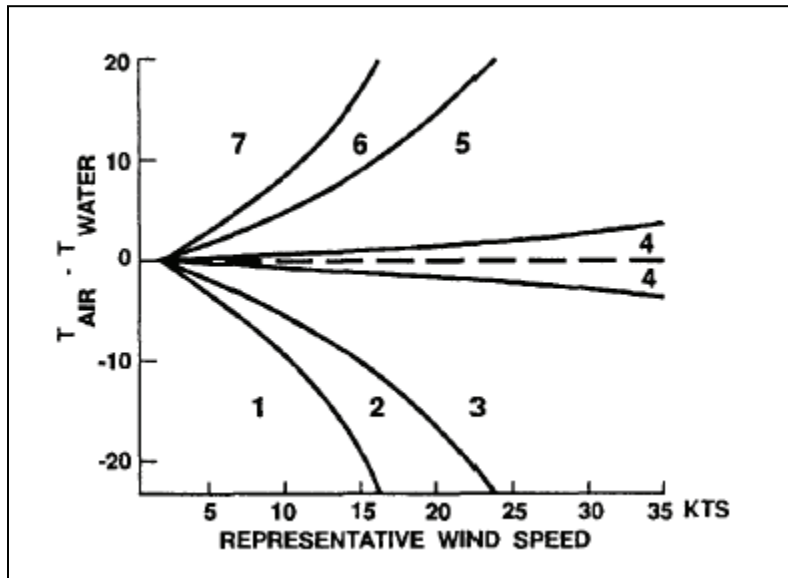

Figure D-4. Naval Air Stability

THIS PAGE IS INTENTIONALLY LEFT BLANK.

Appendix E

CHEMICAL-CONTAMINATION AVOIDANCE TACTICS, TECHNIQUES, AND PROCEDURES

1. Background

a. The CBRN cell staff monitors and tracks all CBRN information within the AO. The commander, CBRN cell, and medical and intelligence sections make decisions that rely on the SA and the significance of gathered data. The commander and staff apply the information from intelligence, medical, and surveillance systems to support the following:

- Hazard predictions.
- Warning, reporting, and notification.
- Casualty prevention.
- Casualty management.

b. Units obtain relevant data from multiple sources (such as, sensors, detectors, observers, and medical staffs). The applicable NBC chemical (CHEM) report data is processed, extracted, formatted, and forwarded. The commanders and their staff evaluate the information to assess any impact on operations. Risk assessment is part of the decision-making process and may result in directives or orders to help reduce the impact of the assessed hazards. The commanders may direct an integrated series of protective or avoidance measures to decrease the level of risk (decrease exposure opportunities) or reduce the effects of exposure. Because SA is an ongoing process, the plan is revised as updated information is received.

2. Chemical-Contamination Avoidance Procedures

Avoidance procedures are broken down into preattack, during attack, and postattack. The lists given below, while not all-encompassing, will assist in developing unit SOPs and directives.

a. Before the Attack.

- (1) Subordinate units are alerted.
- (2) Commanders specify the appropriate MOPP levels, establish automatic masking criteria, and if MOPP0 is assumed, determine the location for chemical protective clothing based on METT-TC.
- (3) The unit continues the mission while implementing actions to minimize casualties and damage.
 - (a) Personnel, equipment, munitions, POL, food, and water are protected from contamination.
 - (b) Detection paper is placed to provide visibility and maximum exposure to liquid agents.

(c) OPSEC, dispersion, cover, and concealment are practiced so that the unit may avoid being targeted.

(d) Chemical detectors and alarms are checked and prepared for use.

(e) Updated CDMs are prepared for each unit

(f) (Shipboard) Countermeasure wash-down system, shipboard ACADA, and AN/KAS-1A CW directional detector are activated as appropriate.

b. During the Attack.

(1) All personnel automatically mask, sound the alarm, decontaminate themselves as required, assume MOPP4, and administer self-aid and buddy aid.

(2) The chain of command and communications are restored, and the unit continues with the mission.

(3) Adjacent units are immediately warned of the potential downwind vapor hazards.

(4) The unit identifies the type of agent and submits an NBC1 CHEM report as the mission permits.

(5) The unit performs the following actions for attacks that leave liquid or solid contamination on the equipment, personnel, or terrain:

(a) Conduct personal wipe-down and operator's spray-down or wipe-down.

(b) Warn the casualty evacuation section of contaminated casualties. Personnel killed in action are wrapped and marked.

(c) Mark the contaminated area, and relocate to a clean area if the mission allows.

(d) Determine where and when further decontamination can be accomplished, if necessary.

(e) Coordinate for decontamination, and resupply protective clothing and decontaminants.

(f) Ensure that contaminated battledress overgarments are exchanged within 24 hours after being contaminated.

(g) Replace contaminated protective covers within 24 hours.

(h) Conduct unmasking procedures for nonpersistent agents.

(i) Treat casualties, and prepare for evacuation as the mission permits.

(j) Receive the NBC2 CHEM report, plot the potential hazard area, and inform the commander.

c. After the Attack.

(1) The unit has undergone decontamination operations, and casualties have been evacuated.

(2) The unit reorders chemical defense equipment (i.e., MOPP suits, filters, M291 refill kits).

(3) Continue the effort to identify the agent if the unit has not yet identified what agent was used. This will be done by—

- Using the M256A1 Kit.
- Using the ICAM.
- Using the ACADA.
- Taking samples and forwarding them to the area lab for analysis.

(4) Perform the following if the unit must continue to operate in or occupy the contaminated area:

- Continue efforts to refine the contamination hazard area and extent by continued sampling and detection.
- Adjust or improve MOPP as required.
- Mark contaminated areas, and identify “hot spots.”
- Monitor contamination decay or covering to determine when natural decay may render the area safe.
- Be alert for “transient contamination” and the spread or movement of contamination by natural sources (i.e., wind, rain, runoff, rivers) or human sources, (i.e., vehicle traffic, rotor wash).

3. NBC1 CHEM Report

The NBC1 CHEM report is the most widely used report. The observing unit uses this report to provide chemical attack data. All units must be completely familiar with the NBC1 CHEM report format and the information needed to complete the report. This report is prepared at the unit level quickly and accurately and then sent to the next higher HQ. NBC1 CHEM reports are not routinely passed to corps or higher CBRN cells except for the initial-use report. Line items BRAVO (location of observer), DELTA (DTG), GOLF (means of delivery), INDIA (release information), and TANGO (terrain, topography, and vegetation description) are mandatory entries in the NBC1 CHEM report.

a. Precedence. The precedence of the NBC1 CHEM report depends on whether or not it is an initial report. The initial use of a CBRN weapon report is FLASH precedence; all others are IMMEDIATE precedence.

b. Report Preparation. Individuals identified by the unit SOP submit raw data to the unit CBRN defense team. NBC1 format should be used; however, a size, activity, location, unit, time, and equipment (SALUTE) or spot report may also be used and should be submitted to the unit CBRN defense team. The unit CBRN defense team normally consists of individuals who have been trained in CBRN defense. This ensures who the report is in the proper format and is as correct as possible.

c. Sample. A sample NBC1 CHEM report is shown in Figure E-1, page E-4). The column “Cond” indicates the means operationally determined (O) or

mandatory (M) for each message type. Operationally determined lines listed may be added or deleted at command discretion.

| NBC1 CHEM Report | | | |
|------------------|--|------|---|
| Line Item | Description | Cond | Example |
| ALFA | Strike serial number | | Will be assigned by the appropriate CBRN cell |
| BRAVO | Location of observer and direction of attack or event | M | BRAVO/32UNB062634/2500MLG// |
| DELTA | DTG of attack or detonation and attack end | M | DELTA/201405ZSEP2005/ 201420ZSEP2005// |
| FOXTROT | Location of attack or event | O | FOXTROT/32UNB058640/EE// |
| GOLF | Delivery and quantity information | M | GOLF/OBS/AIR/1/BML/-// |
| INDIA | Release information on CB agent attacks or ROTA events | M | INDIA/AIR/NERV/P/ACD// |
| TANGO | Terrain/topography and vegetation description | M | TANGO/FLAT/URBAN// |
| YANKEE | Downwind direction and downwind speed | O | YANKEE/270DGT/015KPH// |
| ZULU | Actual weather conditions | O | ZULU/4/10C/7/5/1// |
| GENTEXT | General text | O | None |

Figure E-1. Sample NBC1 CHEM Report

4. NBC2 CHEM Report

The NBC2 CHEM report is based on one or more NBC1 CHEM reports. It is used to pass evaluated data to higher, subordinate, and adjacent units.

a. When actual attack areas are reported, it is easy to differentiate between attacks by their locations. When estimated attack areas are reported, the CBRN specialist uses the following sets to differentiate attacks:

- Set BRAVO: Location of the observer and direction of the attack.
- Set GOLF: Delivery means and quantity.
- Set INDIA: Release of information.

b. Using the sets above, the CBRN specialist can determine whether the attacks occurred in the same proximity, whether the means of delivery/quantity were identical or similar (taking into account the fog of war), agent likeness, air or ground burst, and liquid or vapor.

c. The CBRN cell prepares the NBC2 CHEM report, assigns it a strike serial number, and disseminates it to the appropriate units. Each subordinate unit then decides whether to disseminate the report further. Line items ALFA (strike serial number), DELTA (DTG), FOXTROT (location of attack), GOLF (means of delivery), INDIA (release information), and TANGO (terrain, topography, and vegetation description) are mandatory entries in the NBC2 CHEM report. A sample NBC2 CHEM report is shown in Figure E-2.

| NBC2 CHEM Report | | | |
|------------------|--|------|--|
| Line Item | Description | Cond | Example |
| ALFA | Strike serial number | M | ALFA/US/A234/001/B// |
| DELTA | DTG of Attack or Detonation and Attack End | M | DELTA/201405ZSEP2005// 201420ZSEP2005// |
| FOXTROT | Location of attack or event | M | FOXTROT/32UNB058640/EE// |
| GOLF | Delivery and quantity information | M | GOLF/OBS/AIR/1/BML/-// |
| INDIA | Release information on CB agent attacks or ROTA events | M | INDIA/AIR/NERV/P/ACD// |
| TANGO | Terrain/topography and vegetation description | M | TANGO/FLAT/URBAN// |
| YANKEE | Downwind direction and downwind speed | O | YANKEE/270DGT/015KPH// |
| ZULU | Actual weather conditions | O | ZULU/4/10C/7/5/1// |
| GENTEXT | General text | O | None |

Figure E-2. Sample NBC2 CHEM Report

5. NBC3 CHEM Report

The NBC2 CHEM report and current wind information are used to predict the area of hazard. This prediction is disseminated as an NBC3 CHEM report, which is sent to all units or activities that could be affected by the hazard. Each unit or activity prepares a plot of the NBC3 CHEM report, determines which of its subordinate units or activities are affected, and warns them accordingly. Commanders should use this report as battlefield intelligence when planning missions. The NBC3 CHEM report is a prediction of the hazard area. This prediction is safe-sided to ensure that a significant hazard will not exist outside the predicted hazard area. Units within the hazard area must adjust their MOPP level as necessary. They must ensure that chemical-agent alarms are placed far enough upwind to provide adequate warning. A sample NBC3 CHEM report is shown in Figure E-3.

| NBC3 CHEM Report | | | |
|------------------|--|------|--|
| Line | Description | Cond | Example |
| ALFA | Strike serial number | M | ALFA/US/A234/001/C// |
| DELTA | DTG of attack or detonation and attack end | M | DELTA/201405ZSEP2005/ 201420ZSEP2005// |
| FOXTROT | Location of attack or event | M | FOXTROT/32UNB058640/EE// |
| GOLF | Delivery and quantity information | O | GOLF/OBS/AIR/1/BML/-// |
| INDIA | Release information on CB agent attacks or ROTA events | M | INDIA/AIR/NERV/P/ACD// |
| PAPAA | Predicted attack/release and hazard area | M | PAPAA/1KM/3-10DAY/10KM/ 2-6DAY// |
| PAPAX | Hazard area location for weather period | M | PAPAX/201600ZSEP2005/ 32VNJ456280/32VNJ456119/ 32VNJ576200/32VNJ566217/ 32VNJ456280// |
| XRAYB | Predicted contour information | C | |
| YANKEE | Downwind direction and downwind speed | O | YANKEE/270DGT/015KPH// |
| ZULU | Actual weather conditions | O | ZULU/4/10C/7/5/1// |
| GENTEXT | General text | O | GENTEXT/CBRNINFO/RECALCULATION BASED ON WEATHER CHANGE// |

Figure E-3. Sample NBC3 CHEM Report

a. Chemical Contamination Prediction and Plotting. The chemical prediction procedure for land provides information on the location and extent of the hazard area and the duration of the hazard resulting from attacks with chemical weapons. It provides the necessary information for commanders to warn units within the predicted hazard area. In general, the predicted hazard area will be dependent on the type of attack, the means of delivery, and MET factors in the attack area.

b. Definitions Used in Chemical Hazard Predictions.

(1) Attack Area. This is the predicted area immediately affected by the delivered chemical agent.

(2) Hazard Area. This is the predicted area in which unprotected personnel may be affected by vapor spreading downwind from the attack area. The downwind distance depends on the type of attack, the weather, and the terrain in the attack area and the area downwind of the attack area.

(3) Contaminated Area. This is the area in which liquid hazard may remain for some time after the attack. The actual shape and duration can only be determined by surveys.

NOTE: If actual surveys alter the initial data used for the determination of the attack, the NBC2 and NBC3 CHEM reports must be changed or updated.

c. Types of Chemical Attacks. Chemical attacks can be divided into three types, as follows:

(1) Type A: Air-Contaminating attacks (nonpersistent agents). Type A attacks are to be assumed unless liquid is present that is subsequently confirmed to be a persistent agent.

(2) Type B: Ground-contaminating attacks (persistent agents).

(3) Type C: Attack origin unknown.

d. Means of Delivery.

(1) The means of delivery and types of agent containers are listed in Table E-1.

(2) In cases where the type of agent container is unknown (UNK), then rocket (RKT) should be used for computations.

e. Prediction of the Downwind Hazard. After an attack by chemical agents, personnel may encounter three types of hazards depending on their position relative to the attack area—liquid, vapor, or liquid and vapor.

(1) Liquid Hazard. Personnel in an area contaminated with liquid chemical agents will be exposed to a hazard that varies according to—

(a) The type and amount of agent disseminated.







(b) The method of dissemination.

(c) The local climatic conditions.

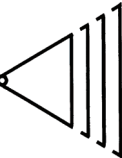
- (d) The nature of the terrain.
 (e) The time lapse after the contamination.

Liquid agents may completely stop evaporating and result in an all-clear survey under very cold conditions. A hazard can be recreated when temperatures rise.

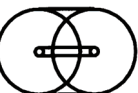
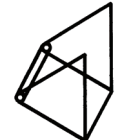
Table E-1. Types and Cases of Chemical Attacks

| Type of Agent Container | Radius of Attack Area | Wind Speed | Type | Case | Symbol |
|---|-----------------------|------------|------|------|---|
| BML, BOM, RKT, SHL, MNE, UNK, surface burst MSL | 1 km | ≤10 kph | A | 1 |  |
| BML, BOM, RKT, SHL, MNE, UNK, surface burst MSL | 1 km | >10 kph | | 2 |  |
| BML, SHL, MNE, surface burst RKT and MSL | 1 km | ≤10 kph | B | 1 |  |
| BML, SHL, MNE, surface burst RKT and MSL | 1 km | >10 kph | | 2 |  |
| BOM, UNK, air burst RKT and MSL | 2 km | ≤10 kph | | 3 |  |
| BOM, UNK, air burst RKT and MSL | 2 km | >10 kph | | 4 |  |
| SPR, GEN | 1 km | ≤10 kph | | 5 |  |
| SPR, GEN | 1 km | >10 kph | | 6 |  |
| Detection after unobserved attack (NBC4 CHEM) | 10 km | N/A | C | N/A |  |

BML – Bomblets; BOM – Bomb; MNE – Mine; MSL – Missile; RKT – Rocket; SHL – Shell; SPR – Spray; UNK - Unknown

(2) **Nonpersistent Agents.** Most nonpersistent agents are disseminated mainly as vapor, but some of the agent types may leave residual liquid in shell or bomb craters for hours or days depending on the climatic conditions and munition type. Craters should be avoided until tests have proven the absence of a liquid hazard.

(3) **Persistent Agents.** Persistent agents are disseminated as liquid and present a vapor and contact hazards. This hazard will last for several hours to days depending on the terrain, climatic conditions, and munition type.

(4) **Border Areas.** Some agents, normally classified as nonpersistent, may behave as persistent agents in very cold environments, and liquid from nonpersistent and persistent agents may freeze at low temperatures (e.g., HD freezes at temperatures below 14°C) and can present a delayed hazard to personnel when the temperature rises.

(5) **Thickened, Nonpersistent Agents.** Thickened, nonpersistent agents may have to be treated as persistent, ground-contaminating agents. Blister agents are normally classified as persistent agents and will be indicated as such when detected by three-way detector paper. Some ground-contaminating agents, however, are very volatile and should be treated as nonpersistent.

(6) **Vapor Hazard.** All chemical agents present a vapor or aerosol hazard to personnel downwind of the attack area. The area covered by this hazard may be estimated by using prediction techniques. The actual downwind distance covered by a toxic cloud will depend on the type and amount of agent disseminated, method of dissemination, climatic conditions, and terrain.

f. **Attack Chronology.**

(1) The dimensions of the downwind hazard area will depend on the means of delivery, category of agent, type of attack, weather, and terrain. The cloud arrival time at positions downwind of the attack point or area will depend on the representative downwind speed.

(2) The ability to provide a timely warning to personnel downwind of the point or area of attack will depend on the time taken to learn of the attack, the time taken to predict a downwind hazard area, and the time required to transmit the warning to those in the hazard area.

g. **Principles of Chemical Predictions and Limitations.**

(1) Unprotected personnel in an attack area will be exposed to chemical-agent hazards unless they take immediate protective action at the first indication of an attack. It is assumed that once chemical warfare has been initiated, troops in areas attacked by aircraft or missiles or coming under artillery or other bombardment will immediately and automatically carry out appropriate chemical defense tactics whether or not a chemical alarm has been given.

(2) An attacked unit will attempt to warn all friendly forces in the immediate vicinity, using the procedures described in STANAG 2047 (CBRN and air attacks only).

(3) At fixed installations and at other locations where established communications and alarms are available, the procedures in STANAG 2047 should be used.

(4) Units and installations that are warned should not promulgate the alarm beyond their own area.

NOTE: As soon as a CBRN cell realizes that the completion and submission of an NBC3 CHEM report would not warn a unit in the hazard area in time, it will attempt to pass the alarm by the most expeditious means available.

(5) CBRN cells will use information in the NBC3 CHEM report to provide timely warning to units and installations in the predicted downwind hazard area. Due to climatic and geographical variations, the lateral limits of the predicted hazard area are normally defined by an angle of lateral spread that is 30° on either side of the forecast representative downwind direction.

(6) The hazard area prediction will be less reliable as the distance from the point of emission increases.

(7) Units in the downwind hazard area that are warned by a CBRN cell will not raise an alarm outside their own area, but will submit an NBC4 CHEM report according to the SOP when the chemical agent cloud actually arrives.

(8) The limiting dosages of agents assumed in establishing the procedures for hazard area prediction, while not sufficient to produce casualties immediately, may produce later effects (i.e., miosis from nerve agents).

h. Simplified Hazard Prediction (Land). The simplified hazard prediction tells subordinate units whether they are in a chemical downwind hazard area. Since Type A attacks present the greatest hazard, the simplified procedures are based on that type of attack. It is valid until an NBC3 CHEM report is received. Units need to make a simplified prediction using a CDM and a simplified template. The template can be made from acetate, overlay paper, or plastic. Figure E-4, page E-10, shows a sample simplified predictor. The following steps describe how to use a simplified prediction:

(1) Step 1. Get the wind speed from the CDM. If it is less than 10 kph, use the circular portion of the prediction. If it is greater than 10 kph, follow the remaining steps.

(2) Step 2. Get the wind direction from the CDM. Mark that direction on the compass circle of the template.

(3) Step 3. Get the air stability code from the CDM and adjust the code using Table D-14, page D-34, to determine the downwind distance (see Table E-2, page E-10).

(4) Step 4. Place the template on the map with the attack center of the prediction (the cross mark) over the actual attack center. Rotate the predictor until the downwind direction points toward GN.

(5) Step 5. Draw the downwind line perpendicular to the downwind direction using the distance obtained in Step 3.

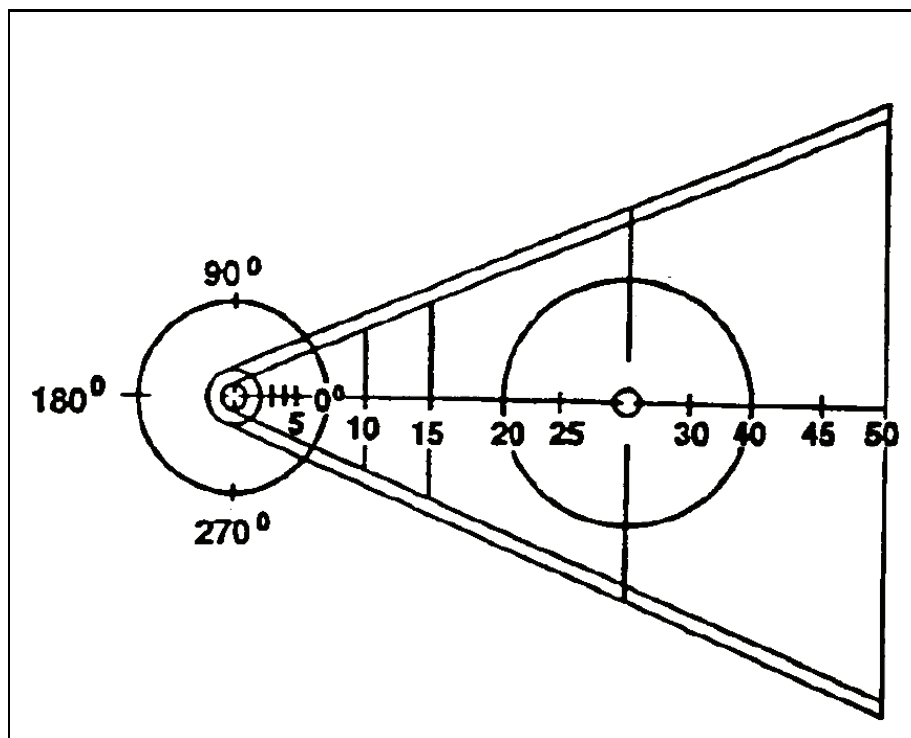

Figure E-4. Simplified Type A Chemical Predictor

Table E-2. DHD Versus Wind Speed (kph) and Air Stability, Land

| Agent: Sarin Weapon: Artillery (Cannon/Mortar) Effective Payload: 650 kg | | | | | | | | | Agent: Soman Weapon: Rocket/Missile Effective Payload: 250 kg | | | | | | | | |
|--|--------------|---------------|----------------|----------------|----------------|----------------|---------------|-------------------------|---|--------------|--------------|---------------|---------------|----------------|----------------|----------------|-------------------------|
| Stability | 1 | 2 | 3 | 4 | 5 | 6 | 7 | Dose | Stability | 1 | 2 | 3 | 4 | 5 | 6 | 7 | Dose |
| Wind 11-17 kph | <1 5 5 | <1 5 10 | <1 10 10 | <1 10 15 | <1 15 20 | 5 15 25 | 5 15 20 | LCt50 ICt5 Miosis | Wind 11-17 kph | <1 5 5 | <1 5 5 | <1 5 10 | <1 5 10 | <1 10 10 | <1 10 15 | <1 10 10 | LCt50 ICt5 Miosis |
| Wind 18-26 kph | <1 5 5 | <1 5 5 | <1 5 10 | <1 10 15 | <1 15 20 | <1 20 25 | | LCt50 ICt5 Miosis | Wind 18-26 kph | <1 5 5 | <1 5 5 | <1 5 5 | <1 5 10 | <1 5 10 | <1 10 15 | | LCt50 ICt5 Miosis |
| Wind 27-36 kph | | <1 5 5 | <1 5 10 | <1 10 10 | <1 10 15 | | | LCt50 ICt5 Miosis | Wind 27-36 kph | | <1 5 5 | <1 5 5 | <1 5 10 | | | | LCt50 ICt5 Miosis |
| Wind 37-45 kph | | | <1 5 5 | <1 5 10 | <1 10 15 | | | LCt50 ICt5 Miosis | Wind 37-45 kph | | | <1 5 5 | <1 5 5 | <1 5 5 | | | LCt50 ICt5 Miosis |
| Wind 46-54 kph | | | <1 5 5 | <1 5 10 | <1 10 15 | | | LCt50 ICt5 Miosis | Wind 46-54 kph | | | <1 5 5 | <1 5 5 | <1 5 5 | | | LCt50 ICt5 Miosis |
| Wind 55-63 kph | | | <1 5 5 | <1 5 10 | <1 5 10 | | | LCt50 ICt5 Miosis | Wind 55-63 kph | | | <1 5 5 | <1 5 5 | <1 5 5 | | | LCt50 ICt5 Miosis |

Table E-2. DHD Versus Wind Speed (kph) and Air Stability, Land (Continued)

| Agent: Sarin Weapon: Bombs (6) Effective Payload: 600 kg | | | | | | | | | Agent: Sarin Weapon: Multiple-Launched Rocket System Effective Payload: 3,500 kg | | | | | | | | |
|--|--------------|---------------|----------------|----------------|----------------|----------------|---------------|-------------------------|--|----------------|----------------|----------------|---------------|----------------|----------------|----------------|-------------------------|
| Stability | 1 | 2 | 3 | 4 | 5 | 6 | 7 | Dose | Stability | 1 | 2 | 3 | 4 | 5 | 6 | 7 | Dose |
| Wind 11–17 kph | <1 5 5 | <1 5 10 | <1 10 10 | <1 10 15 | <1 15 20 | <1 15 20 | 5 15 20 | LCt50 LCt5 Miosis | Wind 11–17 kph | <1 10 15 | 5 20 25 | 5 25 40 | 5 40 55 | 10 50 65 | 10 45 60 | 10 35 45 | LCt50 LCt5 Miosis |
| Wind 18–26 kph | <1 5 5 | <1 5 10 | <1 5 15 | <1 10 20 | <1 15 25 | | | LCt50 LCt5 Miosis | Wind 18–26 kph | <1 10 15 | 5 15 20 | 5 25 35 | 5 35 50 | 5 50 70 | 10 55 75 | | LCt50 LCt5 Miosis |
| Wind 27–36 kph | | <1 5 5 | <1 5 10 | <1 10 15 | | | | LCt50 LCt5 Miosis | Wind 27–36 kph | | <1 10 15 | 5 20 25 | 5 30 40 | 5 40 60 | | | LCt50 LCt5 Miosis |
| Wind 37–45 kph | | | <1 5 5 | <1 5 10 | <1 10 15 | | | LCt50 LCt5 Miosis | Wind 37–45 kph | | | <1 15 25 | 5 25 35 | 5 35 55 | | | LCt50 LCt5 Miosis |
| Wind 46–54 kph | | | <1 5 5 | <1 5 10 | <1 10 15 | | | LCt50 LCt5 Miosis | Wind 46–54 kph | | | <1 15 20 | 5 25 30 | 5 35 45 | | | LCt50 LCt5 Miosis |
| Wind 55–63 kph | | | <1 5 5 | <1 5 10 | <1 5 10 | | | LCt50 LCt5 Miosis | Wind 55–63 kph | | | <1 10 20 | 5 20 25 | 5 30 40 | | | LCt50 LCt5 Miosis |

Table E-3. Type A Case 2 Attack Downwind Distance of Hazard Area

| Type of Agent Container | Distance From Center of Attack Area Along Downwind Axis, When Stability Condition Is: | | |
|---|---|-------|-------|
| | U | N | S |
| Shell, bomblets and mines | 10 km | 30 km | 50 km |
| Air-burst missiles, bombs, rockets and unknown munitions. | 15 km | 30 km | 50 km |

i. Detailed Type A Attack Downwind Hazard Prediction (Land).

(1) Type A agents are normally dispersed as an aerosol or vapor cloud with little or no ground contamination. A nonpersistent nerve agent employed upwind of the target is an example of this type of attack. Air-contaminating agents are normally dispersed in ground-bursting munitions, such as artillery shells and multiple rocket launchers.

(2) For the following two cases of chemical attacks, see examples in Figures E-5 and E-6, pages E-12 and E-14) the following information is required:

- (a) NBC1 or NBC2 CHEM report.
- (b) Detailed MET information.

NOTE: If detailed MET information is not available, the air stability category should be determined by using Table D-13, page D-33. The downwind direction and downwind speed must be measured locally.

(3) Type A, Case 1.

Sample NBC3 CHEM

ALFA/US/A234/001/C//

DELTA/271630ZAPR1999//

FOXTROT/33UUB206300/AA//

INDIA/SURF/NERV/NP//

PAPAA/01KM/-/10KM/-//

PAPAX/271600ZAPR1999/-//

YANKEE/105DGT/009KPH//

ZULU/4/18C/9/-/2//

GENTEXT/CBRNINFO/TYPE A, CASE 1//

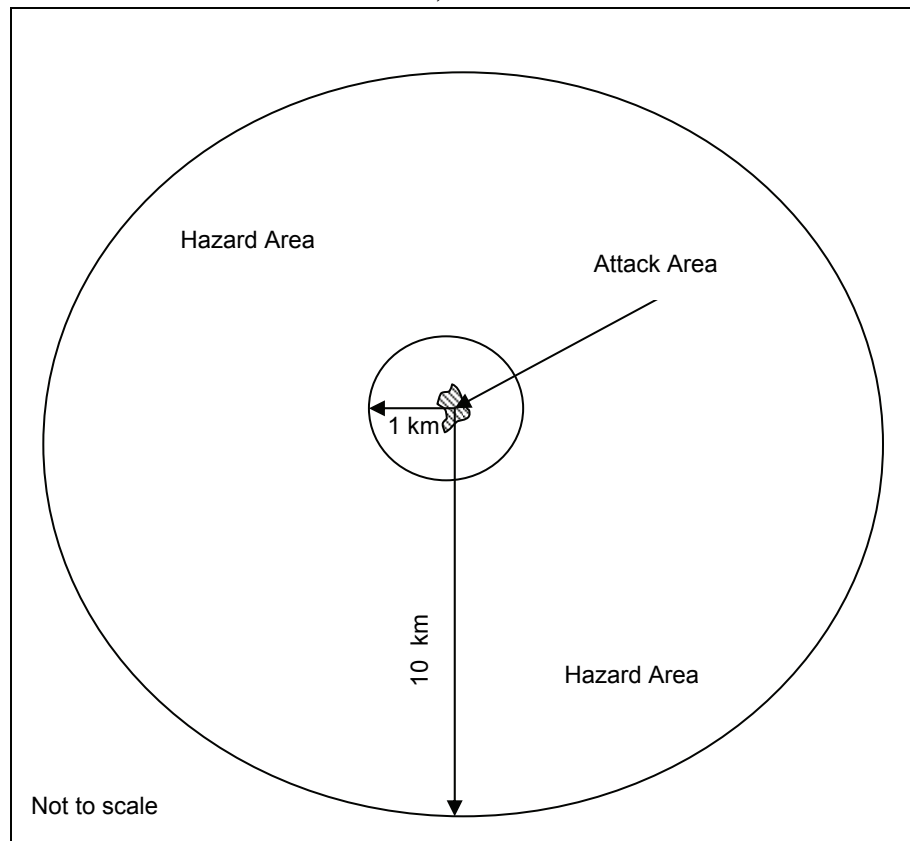

Figure E-5. Hazard Area From Type A Attack, Case 1 (Wind Speed ≤ 10 kph)

(a) Obtain the location of the attack from the relevant NBC CHEM reports, and plot it on the map.

(b) Draw a circle (radius 1 km) around the center of the attack location. The area within this circle represents the attack area.

(c) Draw a circle (radius 10 km) around the center of the attack location. The area within this circle represents the hazard area.

(d) Prepare and transmit an NBC3 CHEM report and/or map overlays to those units and installations within the hazard area according to the SOP.

(4) Type A, case 2.

Sample NBC3 CHEM

ALFA/US/A234/003/C//

DELTA/271647ZAPR1999//

FOXTROT/32UPG560750/AA//

INDIA/AIR/NERV/NP//

PAPAA/01KM/-/10KM/-//

PAPAX/271600ZAPR1999/

32UPG674791/

32UPG557759/

32UPG550752/

32UPG552742/

32UPG638657//

YANKEE/105DGT/015KPH//

ZULU/2/15C/8/-/2//

GENTEXT/CBRNINFO/TYPE A, CASE 2, DHD 10KM//

NOTE: In order that a recipient of an NBC3 CHEM report be able to plot the downwind hazard easily and quickly, the GENTEXT/CBRNINFO line may contain the type, case, and downwind hazard distance (DHD).

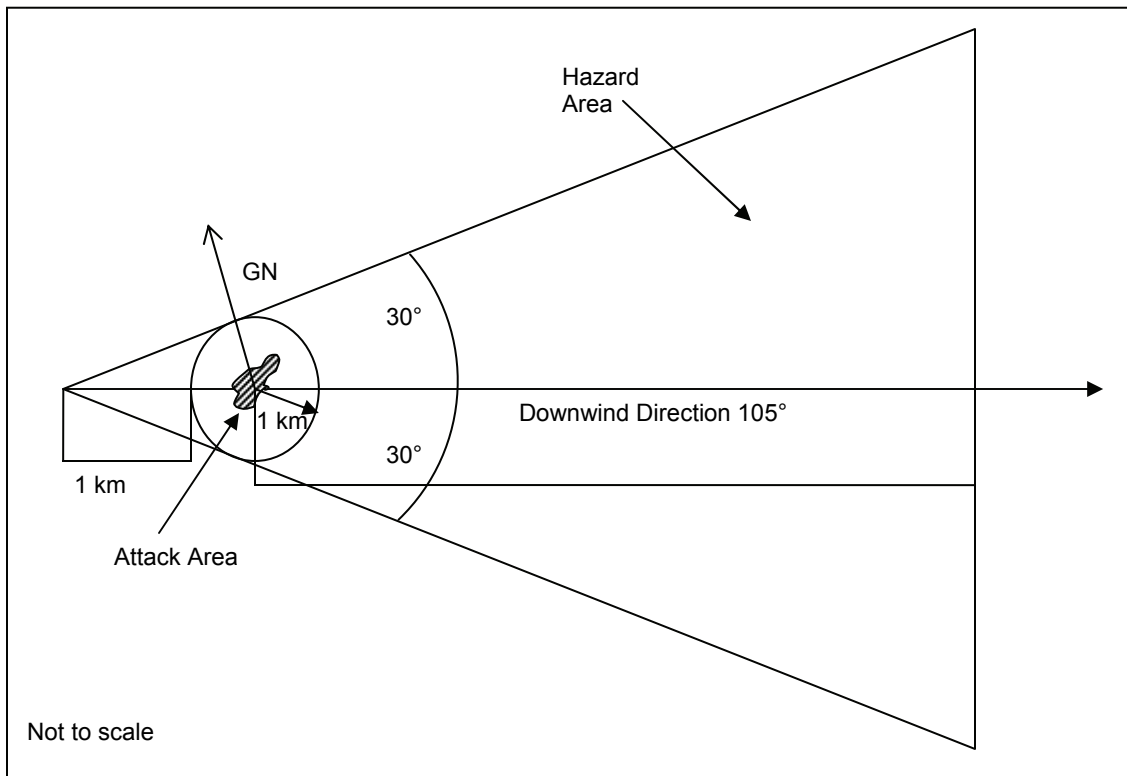

Figure E-6. Hazard Area From Type A Attack, Case 2 (Wind Speed >10 kph)

(a) Obtain the location of the attack from the relevant NBC CHEM reports, and plot it on the map.

(b) Draw the GN line from the center of the attack location.

(c) Draw a circle (radius 1 km) around the center of the attack location. The area within this circle represents the attack area.

(d) Identify the air stability category, downwind direction, and downwind speed using the valid NBC CDM or from locally measured data.

(e) Draw a line from the center of the attack area showing the downwind direction.

(f) Determine the DHD.

- Use the simplified procedure if no more detailed information is available (use the appropriate air stability category and means of delivery).

- Use the detailed procedure if more detailed information is available regarding the agent type, means of delivery, and the wind speed use Table E-2, page E-10.

NOTE: When information concerning the means of delivery is not available, use the figures for multiple-launched rocket systems, missiles, bombs, and unknown munitions.

(g) Plot the maximum downwind distance from the center of the attack area on the downwind line.

(h) Draw a line from the maximum downwind distance at right angles to the downwind direction line. Extend the line on either side of the downwind direction line.

(i) Extend the downwind line upwind from the center of the attack area 2 km. This is equal to twice the radius of the attack area.

(j) Draw two lines from the upwind end of this line, which are tangents to the attack area circle, and extend them until they intersect with the maximum downwind distance line. These lines will form a 30° angle on either side of the downwind line.

(k) Ensure that the hazard area is taken to be the area bounded by—

- The upwind edge of the attack area circle.
- The two 30° tangents.
- The maximum downwind distance line.

(l) Prepare and transmit an NBC3 CHEM report and/or map overlays to those units and installations within the hazard area according to the SOP.

(5) To estimate the earliest and latest arrival times of the chemical cloud at a certain point, calculate the traveling speeds of the leading and trailing edges of the chemical cloud.

(a) Leading Edge Speed = Downwind Speed x 1.5

$$\text{Earliest Arrival Time} = \frac{\text{Distance to Point}}{\text{Leading-Edge Speed}}$$

(b) Trailing Edge Speed = Downwind Speed x 0.5

$$\text{Latest Arrival Time} = \frac{\text{Distance to Point}}{\text{Trailing-Edge Speed}}$$

NOTE: The distance to the points considered must be measured from the upwind edge (circle center for Case 1) of the attack area.

j. Detailed Type B Attack Downwind Hazard Prediction (Land).

(1) Type B agents are normally dispersed in liquid form to contaminate surfaces. Persistent nerve and mustard agents are examples of this type of attack. Ground-contaminating agents are normally dispersed by aircraft spray tanks, air-bursting artillery shells, rockets, missiles, and mines. The evidence of ground contamination may include the observer's report of the agent falling to the ground from air-bursting munitions, the identification of the agent with NBC-M8 paper, the positive response of M9 paper, or the identification of a blister agent with the M256 series sampler or reading on the ICAM.

(2) For the next six cases of chemical attacks the following information is required:

- (a) NBC1 or NBC2 CHEM report.
- (b) Detailed MET information (e.g., CDM or similar information).

NOTES:

1. The daily mean surface temperature is needed for the estimation of the probable time after which personnel may safely remove their protective masks (see Table E-4).
2. The air stability category is not considered in Type B hazard predictions as the maximum downwind distance is always 10 km.

Table E-4. Type B Attack, Probable Time After Ground Contamination at Which Personnel May Safely Remove Protective Masks

| Daily Mean Surface Air Temperature | Within Attack Area (Number of days) | Within Hazard Area (Number of Days) |
|------------------------------------|-------------------------------------|-------------------------------------|
| < 10° C | 3–10 days | 2–6 days |
| 11°–20° C | 2–4 days | 1–2 days |
| > 20° C | up to 2 days | up to 1 day |

(3) Type B, Case 1 (Figure E-7).

Sample NBC3 CHEM

ALFA/US/A234/001/C//

DELTA/271630ZAPR1999//

FOXTROT/33UUB206300/AA//

INDIA/SURF/NERV/P//

PAPAA/01KM/-/10KM/-//

PAPAX/271600ZAPR1999/-//

YANKEE/105DGT/009KPH//

ZULU/4/18C/9/-/2//

GENTEXT/CBRNINFO/TYPE B, CASE 1//

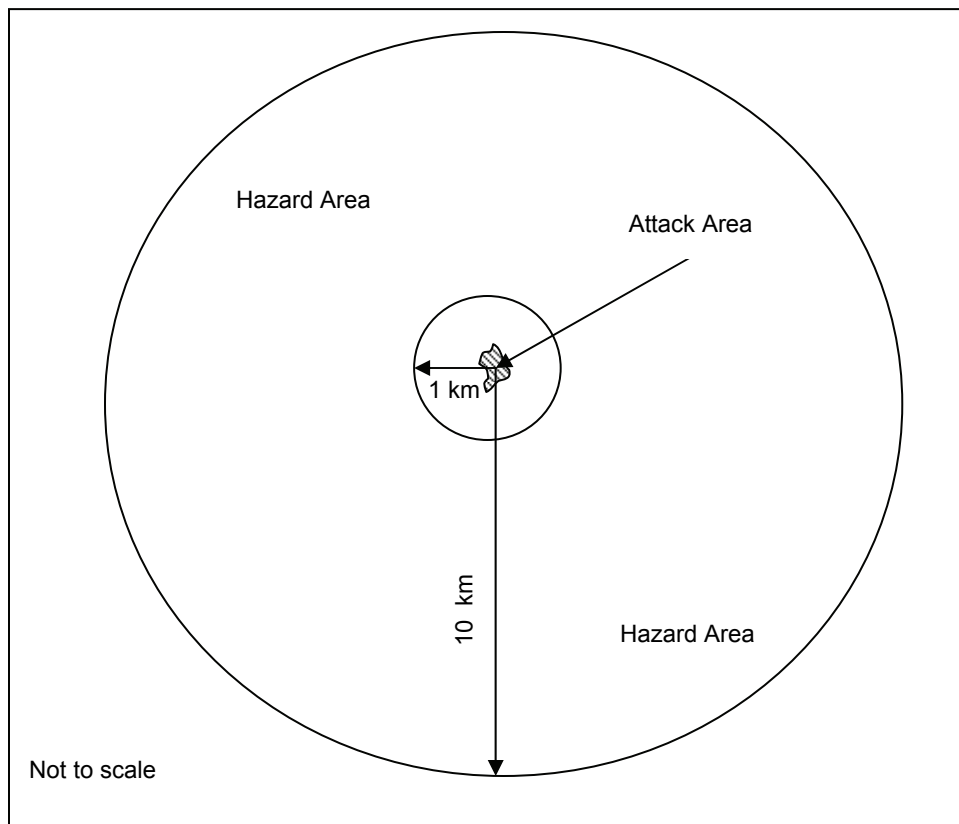

Figure E-7. Hazard Area From Type B Attack, Case 1 (Wind Speed ≤ 10 kph)

- (a) Obtain the location of the attack from the relevant NBC chemical messages, and plot it on the map.
- (b) Draw a circle (radius 1 km) around the center of the attack location. The area within this circle represents the attack area.
- (c) Draw a circle (radius 10 km) around the center of the attack location. The area within this circle represents the hazard area.
- (d) Prepare and transmit an NBC3 CHEM report and/or map overlays to those units and installations within the hazard area according to the SOP.

(4) Type B, Case 2.

Sample NBC3 CHEM

ALFA/US/A234/011/C//

DELTA/271650ZAPR1999//

FOXTROT/32UNH250010/AA//

INDIA/AIR/NERV/P//

PAPAA/01KM/2-4DAY/10KM/1-2DAY//

PAPAX/271600ZAPR1999/

32UNH371020/
 32UNH250020/
 32UNH241015/
 32UNH241005/
 32UNG301900//
 YANKEE/120DGT/015KPH//
 ZULU/2/15C/8/-/2//
 GENTEXT/CBRNINFO/TYPE B, CASE 2//

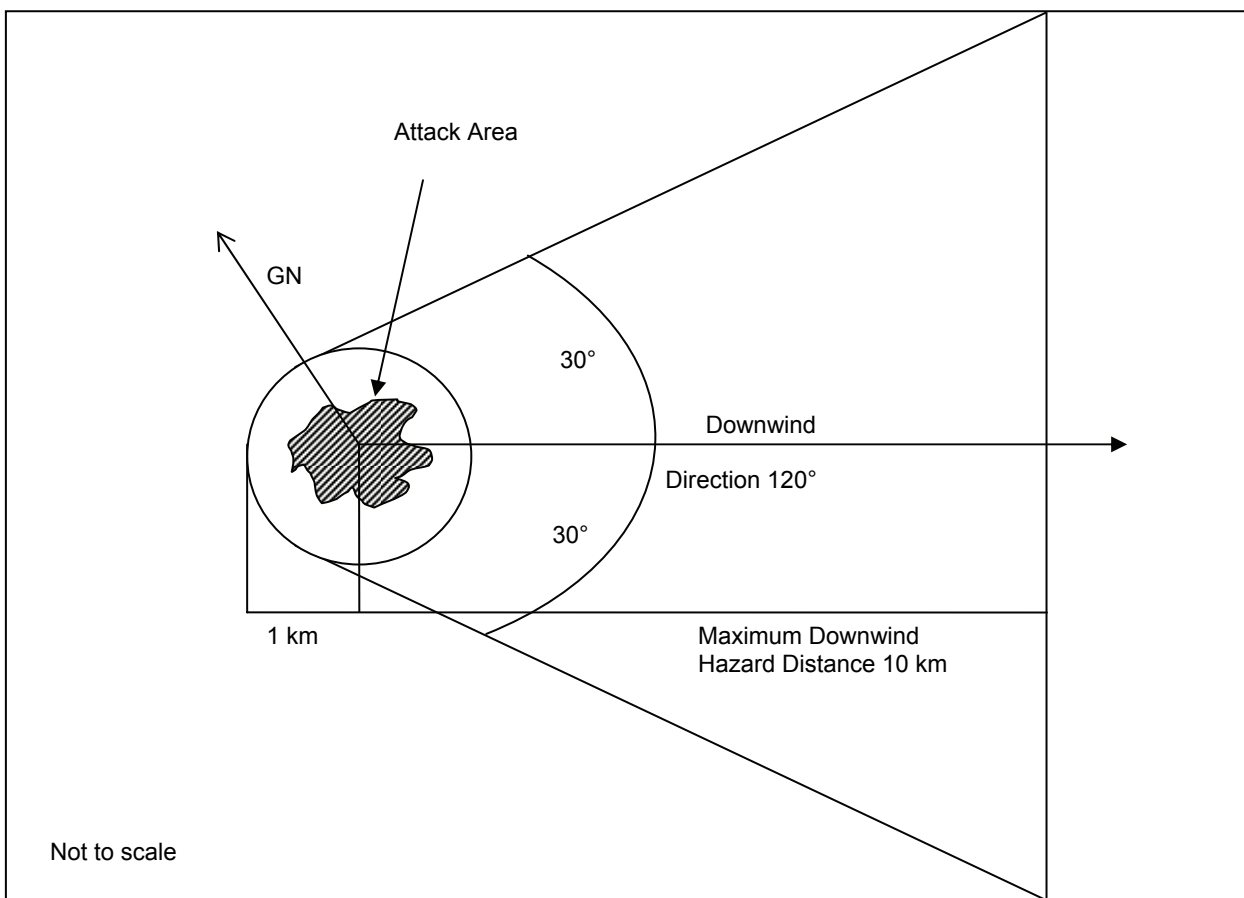

Figure E-8. Hazard Area From Type B Attack, Case 2 (Radius of Attack Area ≤ 1 km, Wind Speed > 10 kph)

- (a) Obtain the location of the attack from the relevant NBC CHEM reports, and plot it on the map.
- (b) Draw a GN line from the center of the attack location.
- (c) Draw a circle (radius 1 km) around the center of the attack location. The area within this circle represents the attack area.

- (d) Draw a line from the center of the attack area showing the downwind direction.
- (e) Plot the 10-km downwind distance from the center of the attack area on the downwind line.
- (f) Draw a line from the 10-km downwind distance at right angles to the downwind direction line. Extend the line on either side of the downwind direction line.
- (g) Extend the downwind line upwind from the center of the attack area 2 km. This is equal to twice the radius of the attack area.
- (h) Draw two lines from the upwind end of this line, which are tangents to the attack area circle, and extend them until they intersect with the 10-km downwind distance line. These lines will form a 30° angle on either side of the downwind line.
- (i) Find the probable time after ground contamination at which personnel may safely remove their protective masks using Table E-4, page E-16.
- (j) Prepare and transmit an NBC3 CHEM report and/or map overlays to those units and installations within the hazard area according to the SOP.

(5) Type B, Case 3.

Sample NBC3 CHEM
 ALFA/US/A234/013/C//
 DELTA/211605ZAPR1999//
 FOXTROT/32UNH431562/EE//
 GOLF/OBS/MSL/10/-/://
 INDIA/AIR/NERV/P//
 PAPAA/02KM/2-4DAY/010KM/1-2DAY//
 PAPAX/211500ZAPR1999/-//
 YANKEE/105DEG/8KPH//
 ZULU/2/15C/6/-/2//
 GENTEXT/CBRNINFO/TYPE B, CASE 3//

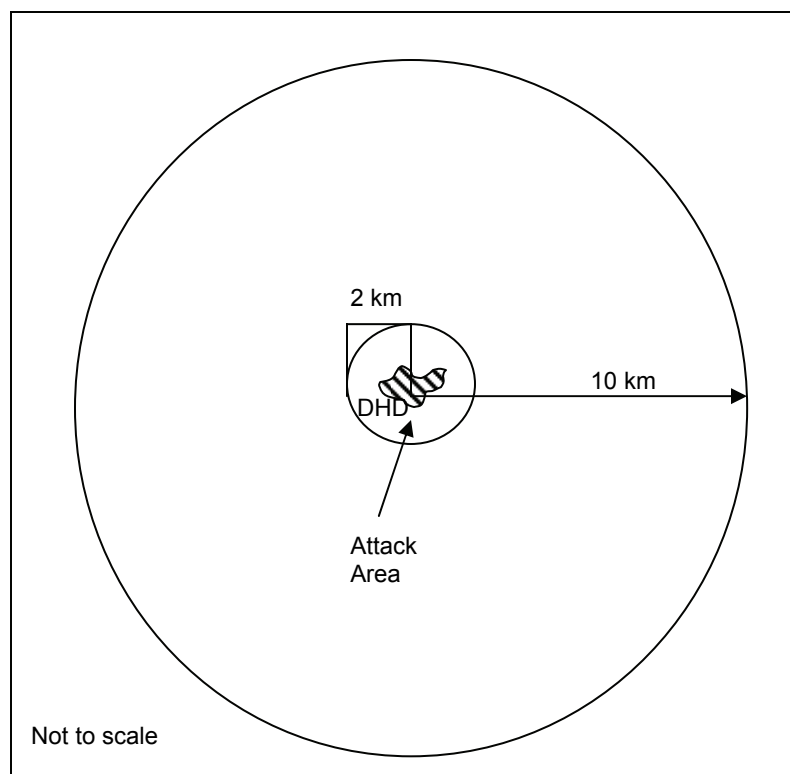

Figure E-9. Hazard Area From Type B Attack, Case 3 Attack Area (Radius >1 km but \leq 2 km, Wind Speed <10 kph)

- (a) Obtain the location of the attack from the relevant reports, and plot it on the map.
- (b) Draw a circle (radius 2 km) around the center of the attack location. The area within this circle represents the attack area.
- (c) Draw a circle (radius 10 km) around the center of the attack location. The area within this circle represents the hazard area.
- (d) Prepare and transmit an NBC3 CHEM report and/or map overlays to those units and installations within the hazard area according to the SOP.

(6) Type B, Case 4.

Sample NBC3 CHEM

ALFA/US/A234/006/C//

DELTA/181730ZAPR1999//

FOXTROT/32UNH320010/EE//

INDIA/AIR/NERV/P//

PAPAA/02KM/2-4DAY/10KM/1-2DAY//

PAPAX/181600ZAPR1999/

32UNH441051/

32UNH316029/

32UNH301016/
 32UNG304997/
 32UNG386899//
 YANKEE/110DGT/020KPH//
 ZULU/4/16C/-/-/2//
 GENTEXT/CBRNINFO/TYPE B, CASE 4//

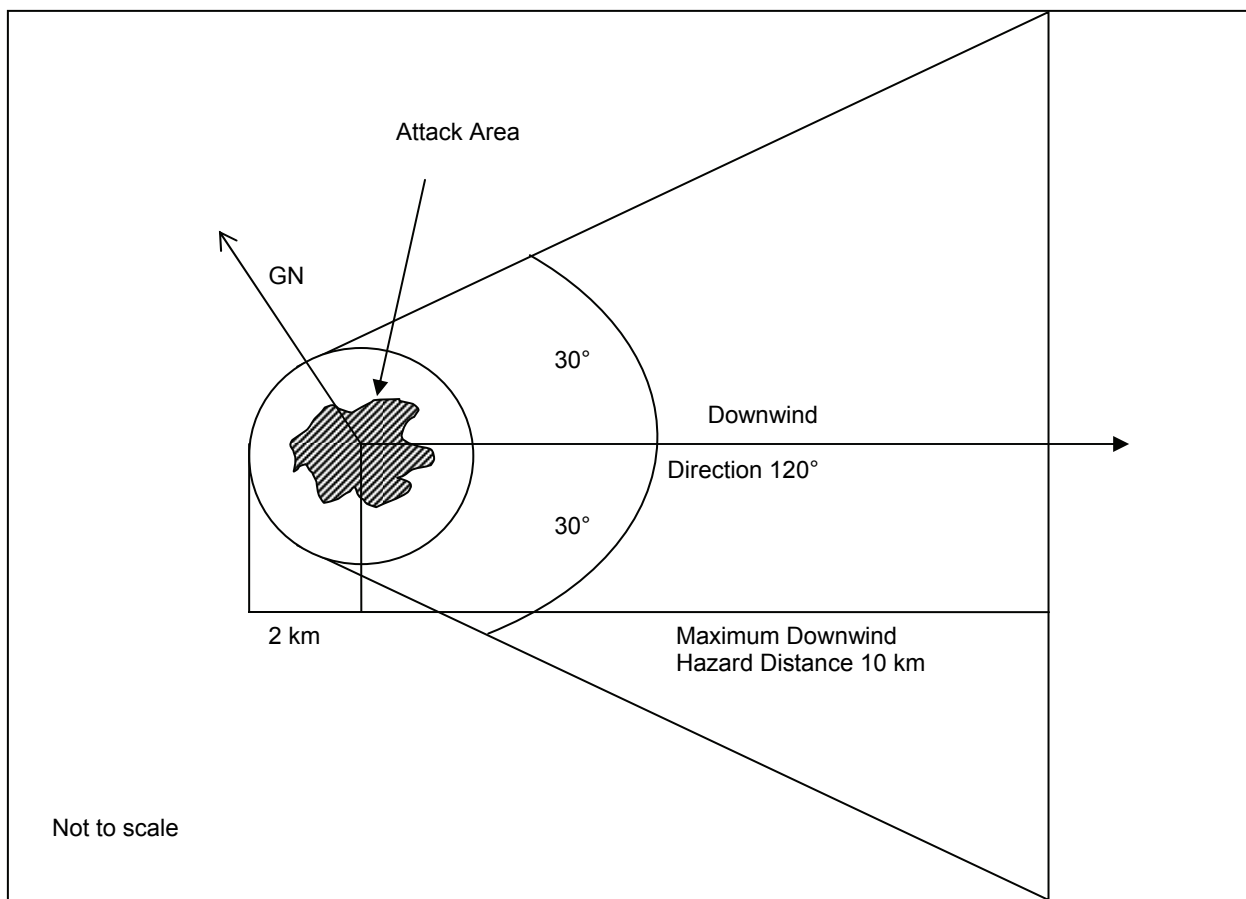

Figure E-10. Hazard Area From Type B Attack, Case 4 (Attack Area Radius >1 km but \leq 2 km, Wind Speed >10 kph)

- (a) Obtain the location of the attack from the relevant NBC CHEM reports, and plot it on the map.
- (b) Draw a GN line from the center of the attack location.
- (c) Draw a circle (radius 2 km) around the center of the attack location. The area within this circle represents the attack area.
- (d) Draw a line from the center of the attack area showing the downwind direction.

- (e) Plot the 10-km downwind distance from the center of the attack area on the downwind line.
- (f) Draw a line from the 10-km downwind distance at right angles to the downwind direction line. Extend the line on either side of the downwind direction line.
- (g) Extend the downwind line upwind from the center of the attack area 4 km. This is equal to twice the radius of the attack area.
- (h) Draw two lines from the upwind end of this line, which are tangents to the attack area circle, and extend them until they intersect with the 10-km downwind distance line. These lines will form a 30° angle on either side of the downwind line.
- (i) Find the probable time after ground contamination at which personnel may safely remove their protective masks by using Table E-4, page E-16.
- (j) Prepare and transmit an NBC3 CHEM report and/or map overlays, to those units and installations within the hazard area according to the SOP.

(7) Type B, Case 5.

Sample NBC3 CHEM

ALFA/US/A234/014/C//

DELTA/201530ZAPR1999//

FOXTROT/32UNG420620/EE/

32UNG435620/EE//

INDIA/AIR/NERV/P//

PAPAA/01KM/2-4DAY/010KM/1-2DAY//

PAPAX/211500ZAPR1999/-//

YANKEE/147DGT/009KPH//

ZULU/2/15C/6/-/2//

GENTEXT/CBRNINFO/TYPE B, CASE 5//

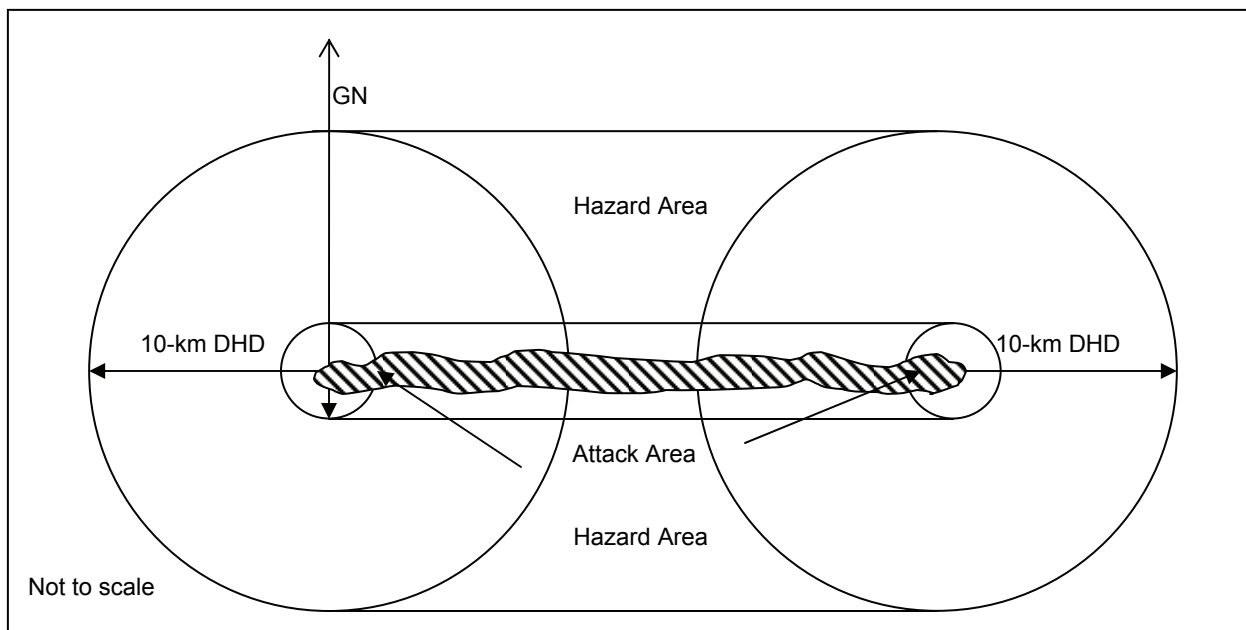

Figure E-11. Hazard Area From Type B, Case 5 (Any Dimension of Attack Area >2 km, Wind Speed ≤10 kph)

- (a) Estimate the attack area from an NBC1 or NBC2 CHEM report, and plot a point at each extreme end.
 - (b) Connect the end points to form one or more attack lines.
 - (c) Draw a 1-km-radius circle around each end point.
 - (d) Connect these circles on both sides by drawing tangents to the circles parallel to the attack line to designate the attack area.
 - (e) Draw a 10-km-radius circle around each 1-km circle at the end points.
 - (f) Connect these circles on both sides by drawing tangents to the circles parallel to the attack line, to designate the hazard area.
 - (g) Find the probable time after ground contamination at which personnel may safely remove their protective masks by using Table E-4, page E-16.
 - (h) Prepare and transmit an NBC3 CHEM report and/or map overlays to those units and installations within the hazard area according to the SOP.
- (8) Type B, Case 6.
- Sample NBC3 CHEM
ALFA/US/A234/007/C//
DELTA/141550ZAPR1999//
FOXTROT/33UUC330060/EE/
33UUC370061/EE//
INDIA/AIR/NERV/P//

PAPAA/01KM/2-4DAY/10KM/1-2DAY//

PAPAX/141400ZAPR1999/

33UUC482014/

33UUC374069/

33UUC368070/

33UUC328069/

33UUC320059/

33UUB326938/

33UUB366939//

YANKEE/147DGT/012KPH//

ZULU/4/18C/3/-/0//

GENTEXT/CBRNINFO/TYPE B, CASE 6//

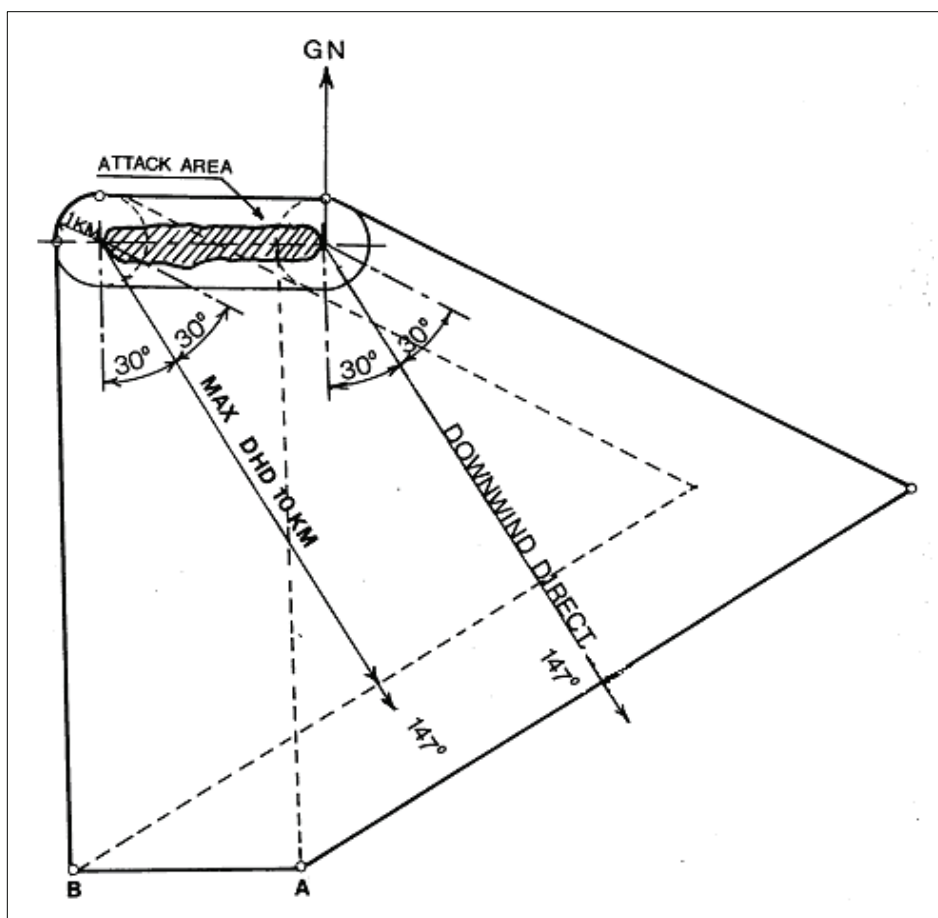

Figure E-12. Hazard Area From Type B Attack, Case 6 (Any Dimension of Attack Area > 2 km, Wind Speed >10 kph)

(a) Estimate the attack area from the NBC1 or NBC2 CHEM report, and plot it on a map.

(b) Identify and mark the extremities of the estimated attack area, and connect the end points to form one or more attack lines.

(c) Draw circles (radius of 1 km), using the extremities as center points, around each point. Connect these circles on both sides by drawing tangents to the circles parallel to the attack line to designate the attack area.

(d) Draw a GN line from the center of each circle.

(e) Consider each circle as a separate attack area, and carry out the following procedure for each attack area:

- Draw a line from the center of the attack area showing the downwind direction.

- Plot the 10-km downwind distance from the center of the attack area on the downwind line.

- Draw a line from the 10-km downwind distance at right angles to the downwind direction line. Extend the line on either side of the downwind direction line.

- Extend the downwind line upwind from the center of the attack area 2 km. This is equal to twice the radius of the attack area.

- Draw two lines from the upwind end of this line, which are tangents to the attack area circle, and extend them until they intersect with the 10-km downwind distance line. These lines will form a 30° angle on either side of the downwind line.

- Draw a line connecting the downwind corners of the two vapor hazard areas (Points A and B in Figure E-10, page E-21).

(f) Use Table E-4, page E-16, to find the probable time after ground contamination at which personnel may safely remove their protective masks.

(g) Prepare and transmit an NBC3 CHEM report and/or map overlays to those units and installations within the hazard according to the SOP.

(9) Calculate the traveling speeds of the leading and trailing edges of the chemical cloud to estimate the earliest and latest arrival times of the chemical cloud at a certain point.

(a) Leading Edge Speed = Downwind Speed x 1.5

$$\text{Earliest Arrival Time} = \frac{\text{Distance To Point}}{\text{Leading Edge Speed}}$$

(b) Trailing Edge Speed = Downwind Speed x 0.5

$$\text{Latest Arrival Time} = \frac{\text{Distance To Point}}{\text{Trailing Edge Speed}}$$

NOTES:

1. The estimates assume ground contamination densities up to 10 g/m².
2. When making hazard estimates, the vapor has been considered to be the determining factor within the attack area and in the downwind hazard area. The duration of the hazard from contact with bare skin is, however, difficult to predict. The duration can only be determined by the use of chemical-agent detection or confirmation devices.
3. When temperatures are considerably lower than 0°C, the duration of contamination may be longer than indicated in Table E-4, page E-16. The absence of vapor does not preclude the presence of contamination.
4. Daily mean surface air temperature may be obtained from local MET sources.
5. The information in Table E-4 is a worst-case scenario. Real, known information should be used to the extent possible.

k. Type C Attack Downwind Hazard Prediction (Land). A Type C attack (Figure E-13) is an attack in which the attack origin is unknown. These attacks will most likely be found by a survey or reconnaissance.

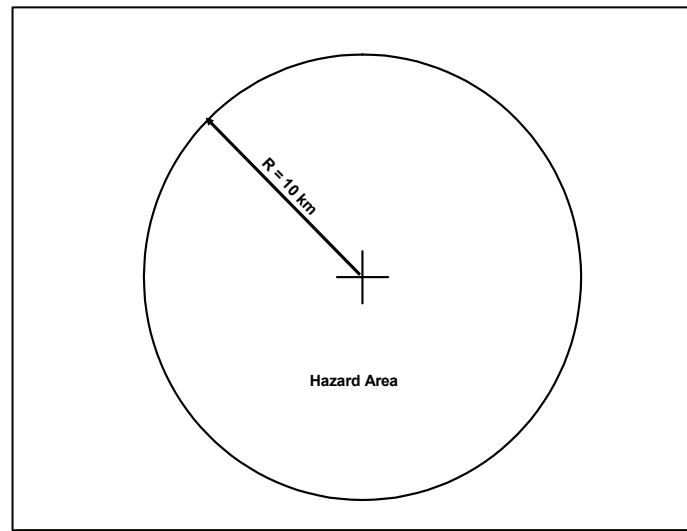

Figure E-13. Type C Attack

- (1) Obtain the location of detection from the relevant NBC4 CHEM report (Line QUEBEC), and then plot it on the map.
- (2) Draw a circle with a 10-km radius around the center of the detection location. The area within this circle represents the attack area and the hazard area.
- (3) Prepare and transmit an NBC3 CHEM report to the units and installations in the predicted hazard area according to the unit SOP.

(4) Repeat the above procedures for the new location if a new NBC4 CHEM message, that cannot be allocated to a strike specifies a location outside of the hazard area.

1. Adjusted Hazard Prediction (Land). The methods previously discussed are based on constant environmental conditions. After significant weather changes, the NBC3 CHEM report may no longer be accurate or apply. An adjusted NBC3 CHEM report must be sent to the unit or installation in the new hazard area if possible. Also, notify units who may no longer be in the hazard area. Significant weather changes include the following:

- Representative downwind speed of 10 kph or more or a wind speed that increases from less than 10 kph to more than 10 kph or the reverse.
- Air stability category (Type A attacks only).
- Changes in downwind direction by 30° or more.

Table E-5 shows which cases and types of attacks may be affected by different atmospheric changes.

Table E-5. Cases and Types of Attacks

| Changes | A 1 | A 2 | B 1 | B 2 | B 3 | B 4 | B 5 | B 6 |
|-------------------------------|-----|-----|-----|-----|-----|-----|-----|-----|
| Wind Speed: By 10 kph or more | | X | | | | | | |
| From >10 kph to ≤10 kph | | X | | X | | X | | X |
| From ≤10 kph to >10 kph | X | | X | | X | | X | |
| Wind Direction by 30° or more | | X | | X | | X | | X |
| Stability Category | | X | | | | | | |

NOTE: For a change in wind speed, determine the geographical center of the frontline of the traveling cloud at the time the new data becomes available. Calculate this distance by multiplying the original wind speed by twice the time in hours since the attack. The center of the cloud front is then considered to be the new center of attack area. Once the new center of attack is determined, the downwind hazard area is determined using the procedures for that type of attack.

(1) Recalculation of Hazard Distances. When significant weather changes occur or are predicted to occur, the following procedures for Type A attacks should be used to determine—

(a) The distance the chemical agent cloud will have traveled prior to the change by using—

$$d_1 = u_1 \times t_1$$

d_1 = distance traveled prior to change in weather conditions

u_1 = downwind speed prior to change in weather conditions

t_1 = time elapsed between the time of attack and the end of the current CDR time period

NOTE: If the distance traveled, as calculated above, is equal to or exceeds the original maximum DHD, recalculation is not required.

(b) For Type A case 2 attacks, measure the distance d_1 along the downwind line and mark it. If that point is outside the current CDR area, get the CDR for the area containing the new point and get the weather conditions for the next time period. Compare these weather conditions with those used for the current CDR time period, and determine if significant weather changes are predicted.

(c) Determine the distance the chemical cloud will travel after the change by using—

$$d_2 = H_2 - d_1$$

$$d_2 = \text{remaining hazard distance}$$

H_2 = maximum hazard distance under the conditions prevailing after the change

$$d_1 = \text{distance traveled prior to change in weather conditions}$$

NOTES:

1. If the second time period has a wind speed ≤ 10 kph (Type A1), always draw a circle with a radius of 10 km (as if $d_2 = 10$ km).

2. In constructing the hazard area, keep in mind that the maximum hazard distance, valid during either set of weather conditions, must not be exceeded. If d_2 is ≤ 0 , recalculation is not required.

(2) Type A, Case 1 Changing to a Type A, Case 2 (Figure E-14 shows an increase in wind speed from ≤ 10 kph to >10 kph).

| | |
|--|--------------------------|
| Sample NBC CDM | Sample NBC2 CHEM |
| AREAM/NFEA12// | ALFA/US/A234/005/C// |
| ZULUM/230600ZAPR1999/230900ZAPR1999/231500ZAPR1999// | DELTA/231030ZAPR1999// |
| UNITM/KM/DGT/KPH/C// | FOXTROT/32VNH450956/AA// |
| WHISKEYM/140/008/4/06/8/-/2// | GOLF/OBS/CAN/-/SHL/24// |
| XRAYM/140/012/4/10/8/-/2// | INDIA/SURF/NERV/NP// |
| YANKEEM/150/014/4/14/8/-/2// | TANGO/FLAT/SCRUB// |
| | YANKEE/140DGT/008KPH// |
| | ZULUA/4/10C/8/-/2// |
| | GENTEXT/CBRNINFO/ |
| | TYPE OF AGENT CONFIRMED |
| | BY CHEMICAL DETECTION |
| | KIT. RECALCULATION BASED |
| | ON CHANGE IN WIND SPEED |
| | 231100Z// |

- (a) Calculate d_1 .
- (b) Draw a circle around the center of the original attack area (radius d_1). The area inside this circle represents the new attack area.

NOTE: If d_1 is >10 km then use $d_1 = 10$ km.

- (c) Draw a line from the center of the attack area showing the downwind direction.
- (d) Draw a GN line from the center of the attack.
- (e) Measure and mark the distance d_2 on the downwind direction line from where the downwind direction line cuts the new attack area circle.
- (f) Draw a line from the d_2 distance at right angles to the downwind direction line, and extend it on either side of the downwind direction line.
- (g) Extend the downwind line upwind from the center of the attack area by $2 \times d_1$. This is equal to twice the radius of the new attack area.
- (h) Draw two lines from the upwind end of this line, which are tangents to the new attack area circle, and extend them until they intersect with the right-angle line resulting from (f).
- (i) Prepare and transmit an NBC3 CHEM report and/or map overlays to those units and installations within the hazard area according to the SOP.

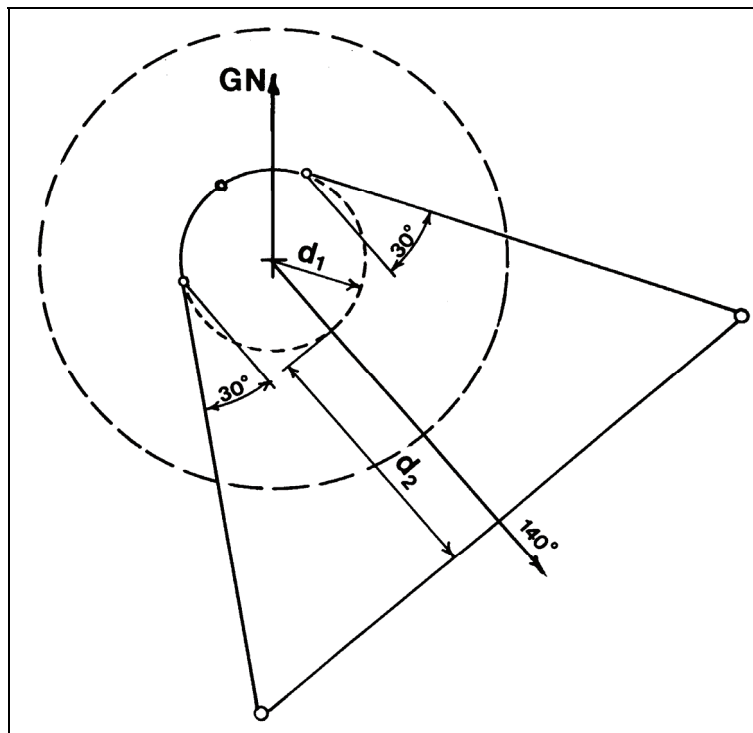

Figure E-14. Recalculation of Downwind Hazard Area Type A Attack (Change in Wind Speed From ≤ 10 kph to >10 kph)

(3) Type A, Case 2 Changing to a Type A, Case 1 (Figures E-15, E-16, and E-17, pages E-31, E-32, and E-33 show a decrease in wind speed from >10 kph to ≤10 kph)

Sample NBC CDM

AREAM/NFEB43//

ZULUM/281200ZAPR1999/281500ZAPR1999/
282100ZAPR1999//

UNITM/KM/DGT/KPH/C//

WHISKEYM/090/018/4/14/8/-/2//

XRAYM/090/008/4/10/8/4/2//

YANKEEM/090/006/2/06/8/4/2//

Example NBC2 CHEM

ALFA/US/A234/005/C//

DELTA/281615ZAPR1999//

FOXTROT/32UPG387764/AA//

GOLF/OBS/MLR/-/RKT/12//

INDIA/SURF/NERV/NP//

TANGO/FLAT/SCRUB//

YANKEE/090DGT/018KPH//

ZULUA/4/14C/8/-/2//

GENTEXT/CBRNINFO/

SYMPTOMS OF NERVE-
AGENT POISONING.

RECALCULATION

BASED ON CHANGE IN WIND
SPEED AS OF 281700Z//

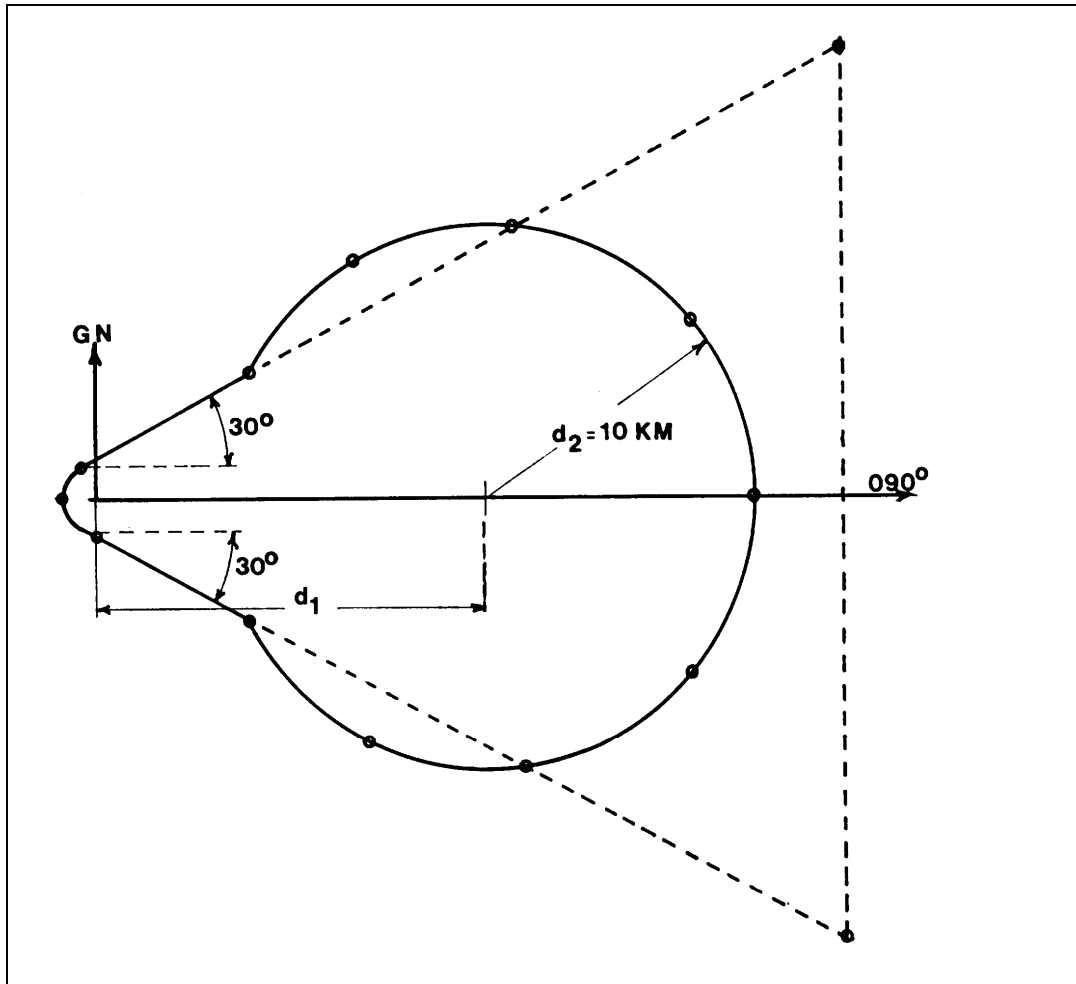

Figure E-15. Recalculation of Downwind Hazard Area Type A Attack (Change in Wind Speed From >10 kph to ≤10 kph) (Example 1)

Sample NBC CDM

AREAM/NFEA12//

ZULUM/280600ZAPR1999/280900ZAPR
1999/281500ZAPR1999//

UNITM/KM/DGT/KPH/C//

WHISKEYM/120/014/4/06/8/-12//

XRAYM/120/009/4/10/8/-12//

YANKEEM/130/007/4/14/8/-12//

Example NBC2 CHEM

ALFA/US/A234/009/C//

DELTA/281030ZAPR1999//

FOXTROT/32UMG892764/AA//

GOLF/OBS/MLR/-/RKT/6//

INDIA/SURF/NERV/NP//

TANGO/FLAT/SCRUB//

YANKEE/120DGT/14KPH//

ZULU/4/06C/8/-12//

GENTEXT/CBRNINFO/

RECALCULATION BASED ON
CHANGE IN WIND SPEED AS OF
281100Z//

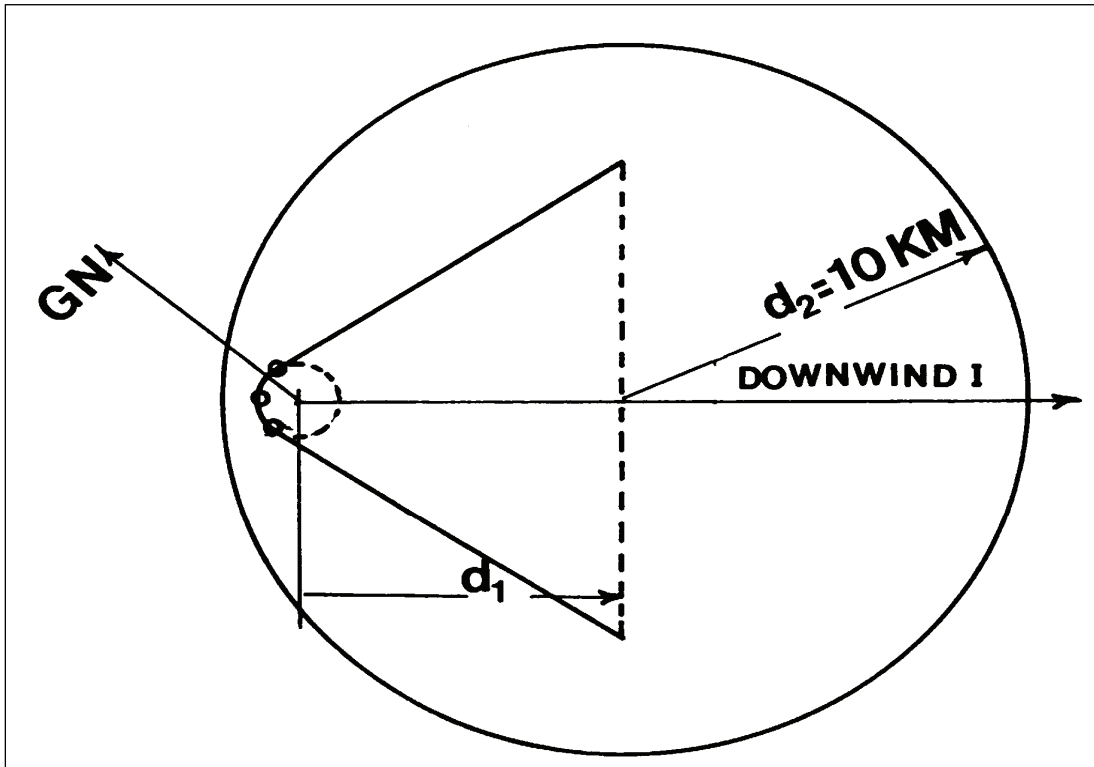

Figure E-16. Recalculation of Downwind Hazard Area Type A Attack (Change in Wind Speed From >10 kph to ≤10 kph) (Example 2)

Sample NBC CDM

AREAM/NFEA12//

ZULUM/280600ZAPR1999/280900ZAPR1999/281500ZAPR1999//

UNITM/KM/DGT/KPH/C//

WHISKEYM/120/014/4/06/8/-/2//

XRAYM/120/009/4/10/8/-/2//

YANKEEM/130/007/4/14/8/-/2//

Sample NBC2 CHEM

ALFA/BE/1BDE/013/C//

DELTA/280930ZAPR1999//

FOXTROT/32UMG892764/AA//

GOLF/OBS/MLR/-/RKT/6//

INDIA/SURF/NERV/NP//

TANGO/FLAT/SCRUB//

YANKEE/120DGT/014KPH//

ZULU/4/06C/8/-/2//

GENTEXT/CBRNINFO/

RECALCULATION BASED ON
CHANGE IN WIND SPEED AS OF
281100Z//

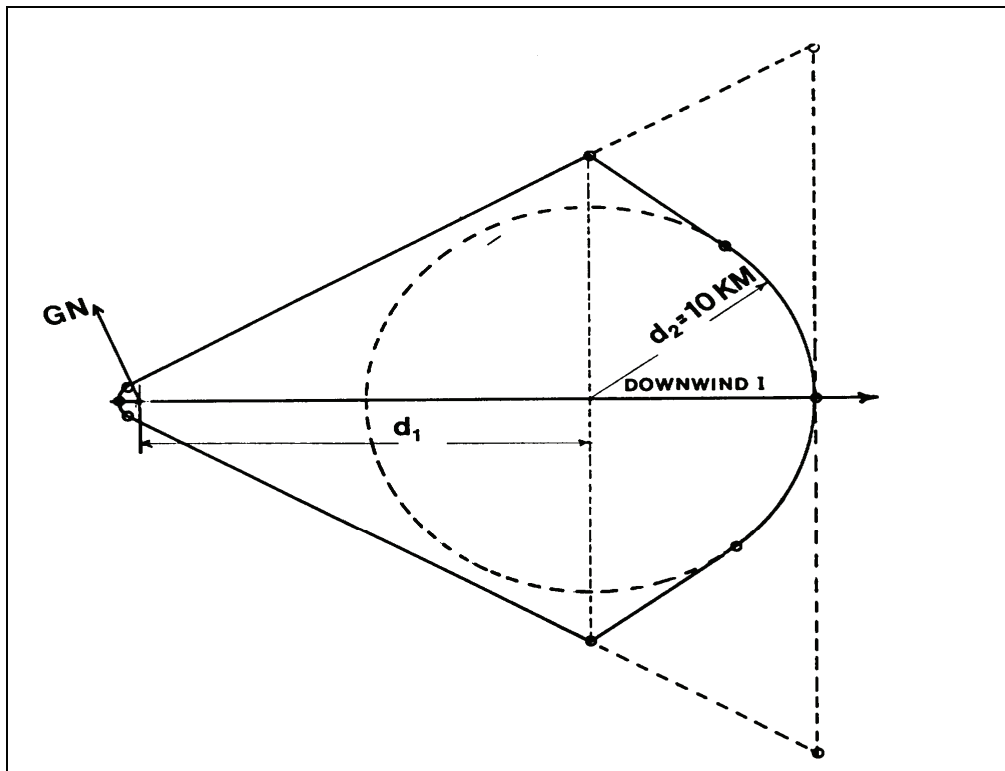

Figure E-17. Recalculation of Downwind Hazard Area Type A Attack (Change In Wind Speed From >10 kph to \leq 10 kph) (Example 3)

- (a) Calculate d_1 .
 - (b) Measure the distance d_1 along the downwind line from the center of the original attack area, and mark it.
 - (c) Draw a circle with a 10-km radius using that point as the center until it intersects the two 30° tangents from the original plot (see Figure E-15, page E-32).
 - (d) Draw a line at right angles to the downwind direction line at the d_1 distance if the circle does not intersect the tangent lines, and mark the intersections with the tangent lines. From these points, draw two new tangents to the 10-km-radius circle.
- (4) Type A, Case 2 Attack With a Change in the Downwind Direction (Figure E-18).

Sample NBC CDM

AREAM/NFEB43//

ZULUM/280600ZAPR1999/280900ZAPR
1999/281500Z APR1999//

UNITM/KM/DGT/KPH/C//

WHISKEYM/090/012/2/06/-/-/2//

XRAYM/090/014/2/08/-/-/2//

YANKEEM/140/015/2/08/-/-/2//

Sample NBC2 CHEM

ALFA/US/A234/010/C//

DELTA/281245ZAPR1999//

FOXTROT/32UNG885419/EE//

GOLF/OBS/MLR/-/RKT/6//

INDIA/SURF/NERV/NP//

TANGO/FLAT/SCRUB//

YANKEE/090DGT/014KPH//

ZULU/2/08C/-/-/2//

GENTEXT/CBRNINFO/

CONFIRMED BY
DETECTOR KIT.
RECALCULATION
BASED ON CHANGE
IN WIND DIRECTION
AS OF 281300Z//

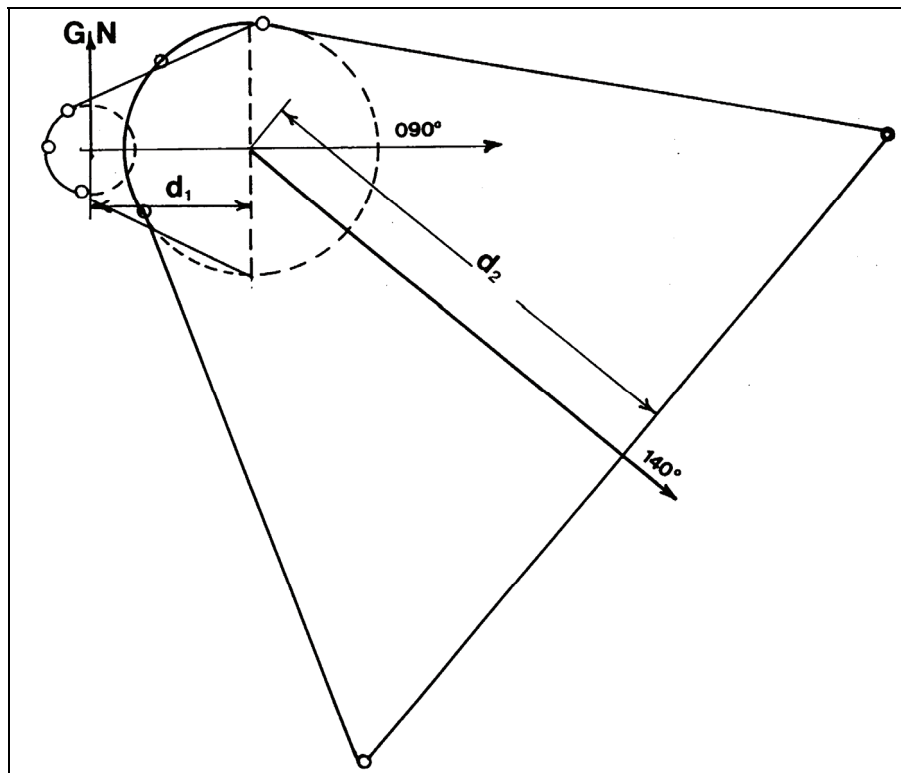

Figure E-18. Recalculation of Downwind Hazard Area Type A, Case 2 Attack
(Change in Downwind Direction by $\geq 30^\circ$)

- (a) Calculate d_1 .
 - (b) Measure the distance d_1 on the downwind line from the center of the original attack before the change in direction, and mark it.
 - (c) Draw a line at right angles to the downwind line through the point d_1 until it meets the 30° lines from the original plot.
 - (d) Draw a new circle using the d_1 point as the center the radius being the distance from the d_1 point to one of the 30° tangents. The area within this circle is considered to be the new attack area.
 - (e) Draw a line from the center of this circle representing the new downwind direction.
 - (f) Measure and mark the d_2 distance on the new downwind direction line from the center of this circle. If this distance falls within the circle, move it to the perimeter of the circle on the new downwind direction line. This will take into account the fact that some of the chemical cloud may travel at 1.5 times the mean wind speed and will, therefore, have traveled further.
 - (g) Complete the plot by following the procedures outlined above.
- (5) Type A, Case 2 Attack With a Change in Stability Category or Downwind Speed (Figure E-19). From the center of the original attack location, plot the hazard area as described above, using H_2 as the maximum downwind distance.

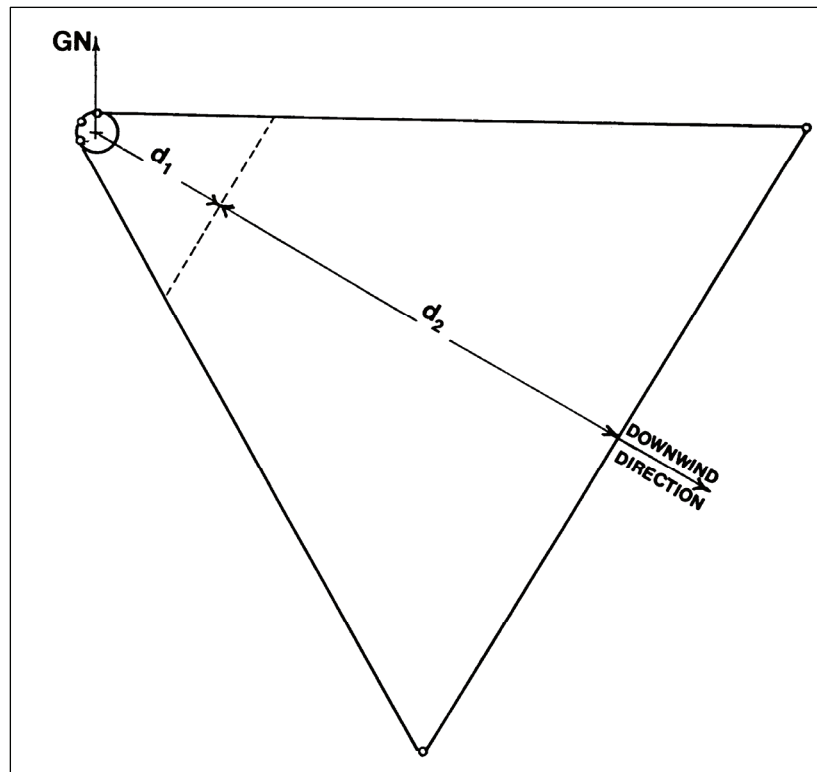

Figure E-19. Recalculation of Downwind Hazard Area Type A, Case 2 Attack (Change in Stability Category and/or Downwind Speed)

| | |
|---|---|
| Sample NBC CDM | Sample NBC2 CHEM |
| AREAM/NFEB34// | ALFA/US/A234/012/C// |
| ZULUM/280600ZAPR1999/280900ZAPR 1999/28/1500ZAPR1999// | DELTA/281230ZAPR1999// |
| UNITM/KM/DGT/KPH/C// | FOXTROT/32UPF730750/EE// |
| WHISKEYM/110/015/6/10/-/4/2// | GOLF/OBS/AIR/6/BOM/18// |
| XRAYM/110/015/6/10/-/4/2// | INDIA/SURF/NERV/NP// |
| YANKEEM/110/025/4/10/-/4/2// | TANGO/FLAT/SCRUB// |
| | YANKEE/110DGT/015KPH// |
| | ZULU/6/10C/-/4/2// |
| | GENTEXT/CBRNINFO/ |
| | RECALCULATION BASED ON CHANGE IN STABILITY CATEGORY AS OF 281300Z// |

(6) Type B, Cases 2 and 4 Attacks With a Change in Downwind Direction.

(a) Draw the new downwind direction line from the center of the original attack location.

(b) Plot the new hazard area as described in paragraphs 5l(4)(b) and (d) on page E-35, or reposition the template along the new downwind direction line and replot.

NOTE: The total area covered by the old and new hazard areas must be considered dangerous until confirmation of the absence of a chemical hazard in the old area is received.

(7) Type B, Case 6 Attack With a Change in Downwind Direction (Figure E-20, page E-38).

Sample NBC2 CHEM

ALFA/US/A234/004/C//

DELTA/281000ZAPR1999//

FOXTROT/32VMH747388/EE//

GOLF/OBS/AIR/-/SPR/-//

INDIA/AIR/NERV/P//

TANGO/FLAT/SCRUB//

YANKEE/090DGT/020KPH//

ZULU/4/18C/8/-/0//

GENTEXT/CBRNINFO/SYMPTOMS OF
NERVE-AGENT POISONING//

Sample NBC CDM

AREAM/NFEA12//

ZULUM/280600ZAPR1999/280900ZAPR1999//

UNITM/KM/DGT/KPH/C//

WHISKEYM/090/020/4/18/8/-/0//

XRAYM/150/020/4/18/8/-/0//

YANKEEM/150/020/4/18/8/-/0//

Sample NBC3 CHEM

ALFA/US/A234/004/C//

DELTA/281000ZAPR1999//

FOXTROT/32VMH747388/EE/32VMH
897388/EE//

INDIA/AIR/NERV/P//

PAPAA/01KM/96HR/10KM/48HR//

PAPAX/281100ZAPR1999/

32VMH846318/32VMH846329/

32VMH856335/32VMH846341/

32VMH847456/32VMH742396/

32VMH740395/32VMH739394/

32VMH738393/32VMH738392/

32VMH737391/32VMH737389/

32VMH737388/32VMH736266/

32VMH836324/32VMH846318//

YANKEE/090DGT/020KPH//

ZULU/4/18C/8/-/0//

GENTEXT/CBRNINFO/
RECALCULATION BASED ON NBC
CDM WEATHER CHANGE AS OF
281100Z//

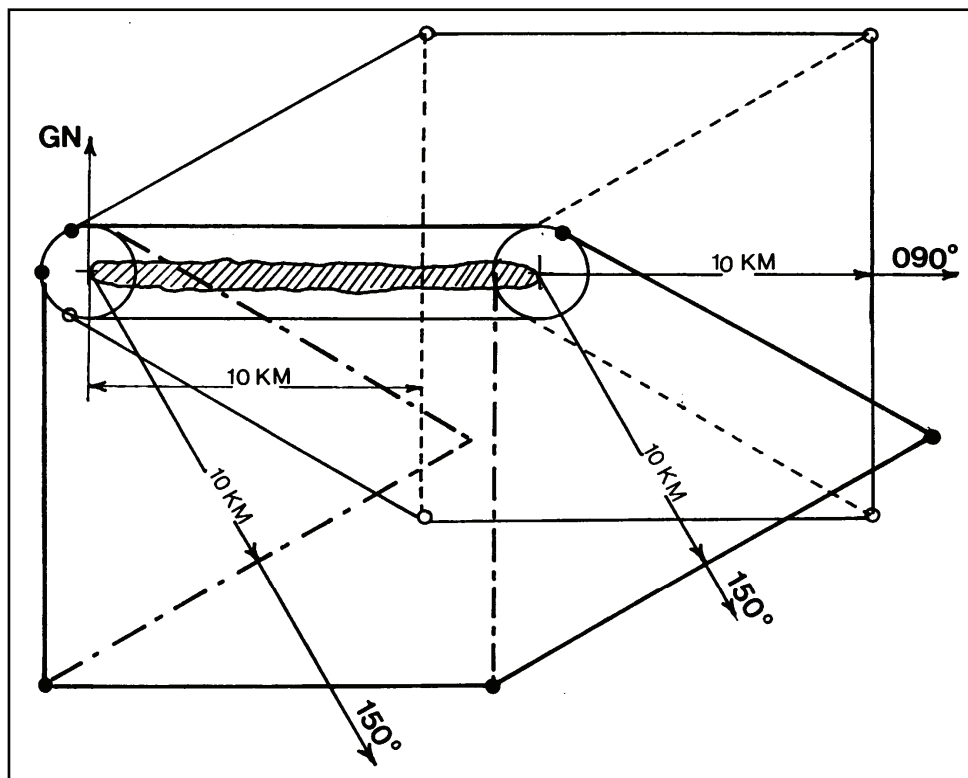

Figure E-20. Recalculation of Downwind Hazard Area Type B, Case 6 Attack (Change in Downwind Direction)

(a) Plot the hazard area as calculated before and after the change in wind direction, using the procedure described above.

(b) Indicate on the GENTEXT/CBRNINFO line the reason for recalculation and the effective time for the new hazard area.

(8) Type B, Case 2, 4, and 6 Attacks With a Change in Wind Speed from >10 kph to ≤ 10 kph.

(a) Plot the hazard area as calculated for the wind speed >10 kph, using the appropriate procedure described above for the correct case.

(b) Plot the hazard area as calculated for the wind speed ≤ 10 kph, using the appropriate procedure described above for the correct case.

(9) Sample Hazard Area. The examples of the hazard area are valid after a change in wind direction; they also include the area before the change. This takes into account transient hazards caused by the shift in wind direction in the areas between the two hazards.

(10) After Recalculation. When recalculation is complete, calculate the arrival time of the hazard and issue an NBC3 CHEM report/map overlays to the units or installations that will be affected. Issue the new NBC3 CHEM report to those units initially warned to inform them that there may be a residual vapor hazard in their area. The same strike serial number should be used as in the

previous message, and the previous message should be referred to in the GENTEXT/CBRNINFO line of the new message.

m. MERWARN. A simplified contamination warning system has been established throughout NATO for broadcasting warnings of contamination dangerous to merchant shipping via the Merchant Ship Communications System (MERCOMMS) and coastal radio stations. This system calls for the origination, by NATO naval authorities, of three types of messages relating to chemical avoidance.

(1) MERWARN NBC3.

(a) This message is issued to pass immediate warning of a predicted chemical contamination and hazard area. MERWARN NBC3 CHEM reports are issued as soon as possible after each attack. They contain sufficient information to enable the master of a ship to plot the downwind hazard area. The following standard format will be used for MERWARN NBC3:

| | |
|-------------------|---|
| MERWARN NBC3 CHEM | (Message identifier) |
| ALFA: | Strike serial number (as defined by naval authority). |
| DELTA: | DTG (Z) of start and end of attack. |
| FOXTROT: | Location of event. |
| GOLF: | Delivery means. |
| INDIA: | Release information. |
| PAPAA: | Predicted attack and hazard area. |

NOTE: If the downwind speed is ≤ 5 knots or variable, line PAPAA will consist of three digits instead of coordinates, representing the radius of a circle in nautical miles, centered on the location of the attack contained in line FOXTROT.

| | |
|----------|---|
| YANKEE: | Downwind direction and speed. |
| ZULU: | Information on actual weather conditions. |
| GENTEXT: | Remarks. |

NOTE: Some of the letter items above may not be completed in the report that is received, but there will be sufficient information for a downwind hazard plot to be developed.

(b) The MERWARN NBC3 standard format may not be suitable after a multiple chemical attack, which produces a hazard from several attacks or depositions in a large or complex target area. In such cases, warnings will be plain language statements of a more general nature, indicating areas affected and expected movement of the hazard.

- Sample 1:
MERWARN NBC3 CHEM
ALFA/DA/CBRNCC-4/003/C//

DELTA/020300ZSEP1999//

GENTEXT/PERSISTENT NERVE-AGENT VAPOR HAZARD EXISTS FROM NORFOLK TO HATTERAS AT 020300ZSEP1999 AND IS SPREADING SOUTH-EASTWARDS AT 017 KNOTS. SEA AREA OUT TO 40 NAUTICAL MILES FROM COAST LIKELY TO BE AFFECTED BY 020600ZSEP1999//

- Sample 2:

MERWARN NBC3 CHEM

ALFA/DA/CBRNC-3/003/C//

DELTA/020300ZSEP1999//

GENTEXT/PERSISTENT NERVE-AGENT VAPOUR HAZARD AT 020600SEP1999 IS ESTIMATED TO BE OCCURRING OVER MOST OF THE SEA AREAS OUT TO 40 MILES EAST OF THE COAST LINE FROM NORFOLK TO HATTERAS. HAZARD IS EXPECTED TO HAVE DISPERSED BY 021000ZSEP1999//

(2) MERWARN Diversion Order. This is a general diversion order, based on the threat, whereby merchant ships proceeding independently are passed evasive routing instructions of a general nature. In addition to the origination of a MERWARN NBC3 message, naval authorities may, if circumstances dictate, broadcast general diversion orders, based on the hazard areas, whereby merchant ships proceeding independently will be passed evasive routing instructions of a more general nature, using the standard naval control of shipping identifier MERWARN DIVERSION ORDER.

Example: MERWARN DIVERSION ORDER: English Channel closed. All shipping in the North Sea is to remain north of 052 degrees N until 031500ZSEP1999.

n. MERWARN Plotting. When a chemical attack is reported in a MERWARN NBC3 message, the following procedures should be followed:

- Plot the location of the attack from the details in line FOXTROT.
- Plot the coordinates or radius of the circle contained in line PAPAA.

If a MERWARN NBC3 is not received but observations of an attack or a local report of an attack is received, then the following procedures should be carried out:

- (1) Mark the actual or suspected location of the attack on the chart.
- (2) Draw a circle, radius 0.5 nautical miles (NM), centered on the attack location. From the center of the attack area, draw the downwind direction, which is contained in line CHARLIE of the MERWARN NBC CDM.
- (3) Place the center of the ship chemical template (Figure E-21, page E-41) on the center of the attack area. Position the center line of the template on the downwind direction line.

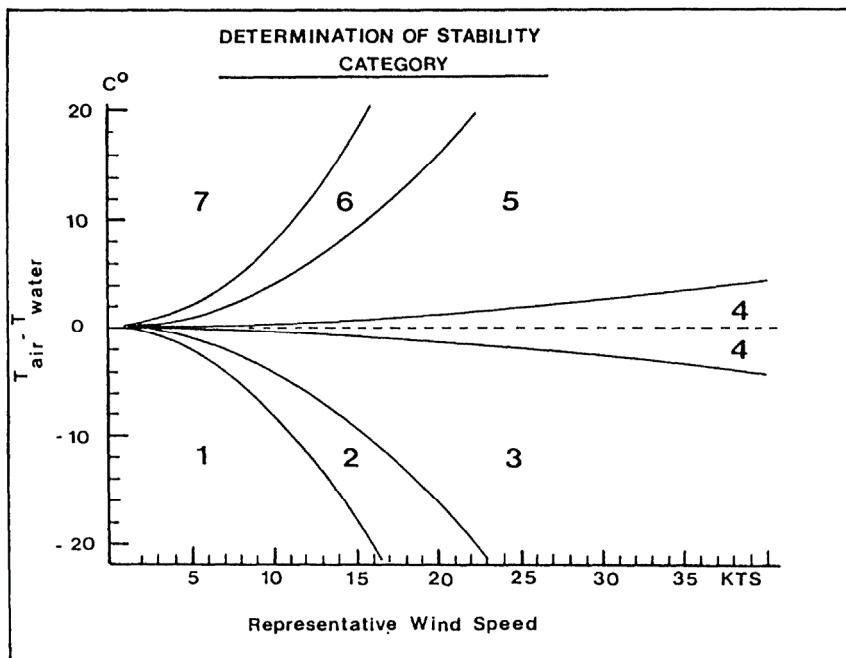

Figure E-21. Air Stability Category (Sea)

(4) Keep the center line of the template on the downwind direction, and move the template upwind until the 20° lines of the template make tangents with the circle around the attack area.

(5) Mark the tangent lines using the holes in the template. Join these marks with the attack area circle.

(6) If the chemical agent is identified as nerve agent, determine the DHD for the miosis level (Table E-6) for the agent. Measure this distance from the center of the attack area on the downwind direction line, and mark it. Through this point, draw a line perpendicular to the downwind direction line until it meets the two tangents.

(7) If the agent is unknown, use the DHD of 44 NM, as this will be the worst-case scenario.

(8) The hazard area is now defined as the area bounded by the—

- Upwind radius of the attack area.
- 20° tangents.
- DHD line.

(9) Adjustments to the DHD can be made when the agent is identified.

o. Simplified Procedure Requirements (Sea). The simplified procedure requires the following:

- Sea chart of the AO.
- Ship chemical template.

- NBC1 or NBC2 CHEM report.
- NBC CDM.

If a valid NBC CDM is not available, Figure E-21 may be used to determine the air stability category, which is the basis for the determination of the maximum DHD. This distance is determined from Table E-6. When using the simplified procedure, use the DHDs related to miosis. The representative downwind direction and downwind speed must be determined onboard.

Table E-6. DHD Versus Wind Speed (Knots) and Air Stability (Sea)

| Agent: Sarin Weapon: Artillery (Cannon/Mortar) Effective Payload: 650 kg | | | | | | | | Agent: Soman Weapon: Rocket/Missile Effective Payload: 250 kg | | | | | | | | | |
|--|--------------|--------------|--------------|---------------|---------------|---------------|--------------|---|------------------|--------------|--------------|--------------|--------------|--------------|--------------|--------------|-------------------------|
| Stability | 1 | 2 | 3 | 4 | 5 | 6 | 7 | Dose | Stability | 1 | 2 | 3 | 4 | 5 | 6 | 7 | Dose |
| Wind 5–9 kt | <1 4 4 | <1 4 6 | <1 6 8 | <1 8 10 | <1 8 12 | 2 10 12 | 2 8 12 | LCt50 ICt5 Miosis | Wind 5–9 kt | <1 2 2 | <1 2 4 | <1 2 4 | <1 4 4 | <1 4 6 | <1 4 6 | <1 4 6 | LCt50 ICt5 Miosis |
| Wind 10–14 kt | <1 2 4 | <1 4 6 | <1 6 8 | <1 6 10 | <1 8 12 | 2 10 14 | | LCt50 ICt5 Miosis | Wind 10–14 kt | <1 2 2 | <1 2 2 | <1 2 4 | <1 2 4 | <1 4 6 | <1 4 8 | | LCt50 ICt5 Miosis |
| Wind 15–19 kt | | <1 2 4 | <1 4 6 | <1 6 8 | <1 6 10 | | | LCt50 ICt5 Miosis | Wind 15–19 kt | | <1 2 2 | <1 2 2 | <1 2 4 | <1 2 4 | | | LCt50 ICt5 Miosis |
| Wind 20–24 kt | | | <1 4 4 | <1 4 6 | <1 6 8 | | | LCt50 ICt5 Miosis | Wind 20–24 kt | | | <1 2 2 | <1 2 2 | <1 2 4 | | | LCt50 ICt5 Miosis |
| Wind 25–29 kt | | | <1 2 4 | <1 4 6 | <1 4 8 | | | LCt50 ICt5 Miosis | Wind 25–29 kt | | | <1 2 2 | <1 2 2 | <1 2 4 | | | LCt50 ICt5 Miosis |
| Wind 30–34 kt | | | <1 2 4 | <1 4 4 | <1 4 6 | | | LCt50 ICt5 Miosis | Wind 30–34 kt | | | <1 2 2 | <1 2 2 | <1 2 2 | | | LCt50 ICt5 Miosis |

Table E-6. DHD Versus Wind Speed (Knots) and Air Stability (Sea) (Continued)

| Agent: Sarin Weapon: Bombs (6) Effective Payload: 600 kg | | | | | | | | Agent: Sarin Weapon: Multiple-Launched Rocket System Effective Payload: 3,500 kg | | | | | | | | | |
|--|--------------|--------------|--------------|---------------|---------------|---------------|--------------|--|------------------|---------------|---------------|---------------|---------------|---------------|---------------|---------------|-------------------------|
| Stability | 1 | 2 | 3 | 4 | 5 | 6 | 7 | Dose | Stability | 1 | 2 | 3 | 4 | 5 | 6 | 7 | Dose |
| Wind 5–9 kt | <1 4 4 | <1 4 6 | <1 6 8 | <1 6 10 | <1 8 12 | 2 8 12 | 2 8 10 | LCt50 LCt5 Miosis | Wind 5–9 kt | 2 12 16 | 2 16 22 | 2 20 30 | 4 26 36 | 4 28 38 | 4 26 34 | 4 20 26 | LCt50 LCt5 Miosis |
| Wind 10–14 kt | <1 2 4 | <1 4 6 | <1 4 8 | <1 6 10 | <1 8 12 | 2 10 14 | | LCt50 LCt5 Miosis | Wind 10–14 kt | 2 10 16 | 2 14 20 | 2 20 28 | 4 26 38 | 4 30 44 | 4 32 42 | | LCt50 LCt5 Miosis |
| Wind 15–19 kt | | <1 2 4 | <1 4 6 | <1 4 8 | <1 6 10 | | | LCt50 LCt5 Miosis | Wind 15–19 kt | | 2 10 16 | 2 16 22 | 2 20 30 | 4 26 38 | | | LCt50 LCt5 Miosis |
| Wind 20–24 kt | | | <1 2 4 | <1 4 6 | <1 6 8 | | | LCt50 LCt5 Miosis | Wind 20–24 kt | | | 2 12 18 | 2 18 26 | 2 22 34 | | | LCt50 LCt5 Miosis |
| Wind 25–29 kt | | | <1 2 4 | <1 4 6 | <1 4 6 | | | LCt50 LCt5 Miosis | Wind 25–29 kt | | | 2 10 16 | 2 14 22 | 2 20 30 | | | LCt50 LCt5 Miosis |
| Wind 30–34 kt | | | <1 2 4 | <1 2 4 | <1 4 6 | | | LCt50 LCt5 Miosis | Wind 30–34 kt | | | 2 10 14 | 2 12 20 | 2 18 28 | | | LCt50 LCt5 Miosis |

(1) Determination of the Hazard Area. The hazard area is determined as follows:

(a) Plot the center of the attack area (line FOXTROT) on the chart. Draw a circle (0.5NM radius) around the center to represent the attack area.

(b) Place the template for a simplified chemical hazard area prediction on the chart in such a way that the center point of the template circle coincides with the center of the attack area. The value on the protractor corresponding to the downwind direction given in the NBC CDM must be oriented towards north on the chart. Mark this position of the template on the chart by using the holes punched in the template along the downwind axis.

(c) Move the template back along the downwind axis until the radial lines become tangents to the circle (30° standard). Use the holes punched out along the radial lines to mark the position and connect to the circle, forming tangents.

(d) Mark the maximum DHD on the downwind axis. Through this point, draw a line perpendicular to the downwind axis to intersect the tangents (Figure E-22, page E-44).

NOTE: When light winds are reported (wind speeds of 5 knots or less) in the NBC CDM, the hazard area is represented by a circle concentric to the attack area, with a radius equal to 15 NM.

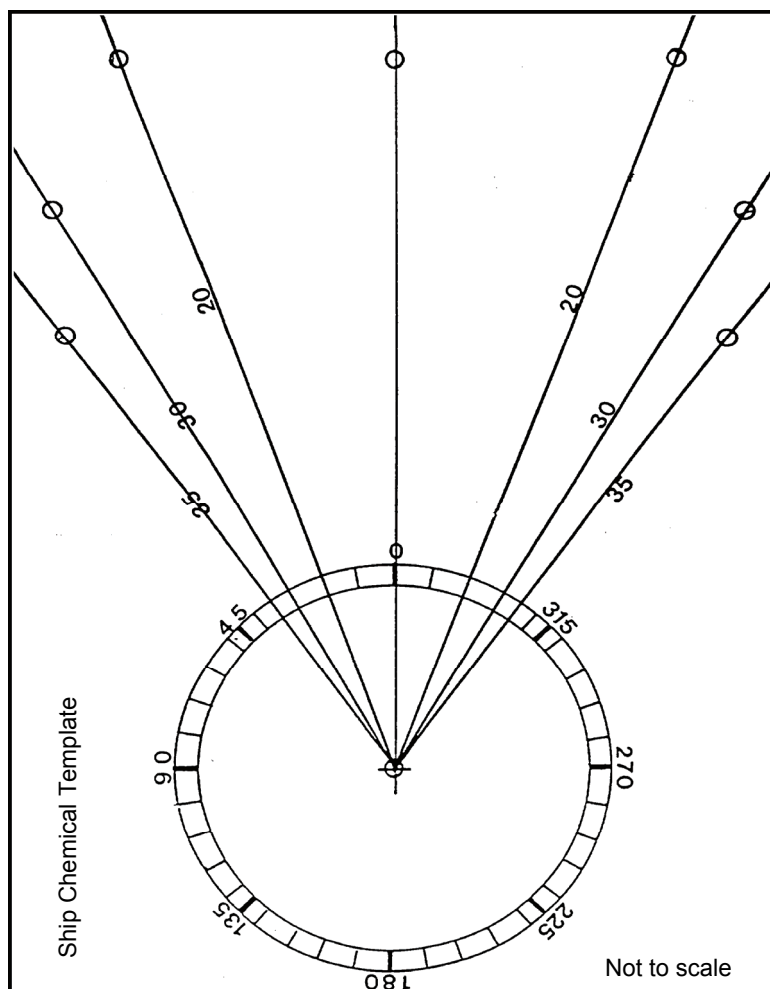

Figure E-22. Ship Chemical Template (Example)

p. Detailed Procedure Requirements (Sea).

(1) Chemical Prediction Data Sheet (CPDS). The detailed procedure for predicting chemical downwind hazard areas is designed for use at naval HQ and leads to a more accurate prediction than does the simplified procedure. The detailed procedure is based on the information compiled in the CPDS and NBC1 or NBC2 CHEM reports. The CPDS (Figure E-23) must be filled in immediately on receipt of a new and updated NBC CDM, and checked on the receipt of an NBC1 or NBC2 CHEM report, containing MET information in lines YANKEE and ZULU.

| Chemical Prediction Data Sheet | | | | |
|--------------------------------|--|----------|------|------|
| Agent: Sarin | | | | |
| Delivery Means: Artillery | | | | |
| Hazard Level: ICt5 | | | | |
| 1 | CBRN Cell: AMZ BSN | | | |
| 2 | Area of Validity: NFEA | | | |
| 3 | Originator of CDM: F1Kdo/GEOPHYS B1St N | | | |
| 4 | DATE: 11 JUN 2005 | PERIOD | | |
| 5 | Time of Validity: 0600Z-1200Z | W | X | Y |
| 6 | Downwind Direction (Degrees) | 30.0 | 40.0 | 70.0 |
| 7 | Representative Downwind Speed 10 m (kts) | 5.0 | 10.0 | 12.0 |
| 8 | 1.5 Times the Wind Speed (kts) | 7.5 | 15.0 | 18.0 |
| 9 | 0.5 Times the Wind Speed (kts) | 2.5 | 5.0 | 6.0 |
| 10 | Stability Category | 1.0 | 3.0 | 4.0 |
| 11 | Temperature (Centigrade) | 14.0 | 15.0 | 16.0 |
| 12 | Relative Humidity (Percent) | 70.0 | 60.0 | 60.0 |
| 13 | Significant Weather Phenomena | - | Rain | Rain |
| 14 | Cloud Coverage | - | - | - |
| 15 | Maximum DHD (NM) | 4.0 | 6.0 | 6.0 |
| 16 | Maximum Duration of Hazard (Hours) | 2.0 | 1.2 | 1.2 |
| 17 | Half Sector Angle (degrees) | Circular | 20.0 | 20.0 |
| 18 | Remarks | - | - | - |

Figure E-23. Sample CDM and CPDS

(2) Delineation of the Hazard Area. The delineation of the hazard area resulting from an attack with chemical agents requires information on the following:

- (a) Means of delivery.
- (b) Location of the attack area as reported in the NBC1 or NBC2

CHEM report.

(c) Representative downwind direction of the agent cloud (taken from the CPDS).

(d) Maximum DHDs related to the appropriate hazard levels (LCt₅₀, ICt₅, and/or miosis) (taken from the CPDS).

(e) Half-sector angle of the hazard area.

- 35 degrees for a wind speed higher than 5 knots, but less than 10 knots.

- 20 degrees for a wind speed of 10 knots or more.

(3) Low Wind Speeds. For wind speeds of 5 knots or less, the hazard area will be circular, with a radius equal to the DHD for 5-knot wind speed. However, the radius should not exceed 15 NM.

q. Determination of the Downwind Hazard Area.

(1) Plotting the Downwind Hazard Area. To plot the chemical downwind hazard area on a sea chart or on general operations plot, the above information is used in the following way (see Figures E-24 and E-25, pages E-47 and E-48).

(a) Plot the location of the attack area. If the exact location (center of the attack) is known, draw a circle with a radius of 0.5 NM around this point. If only a dissemination area is reported, determine the center point of this area and draw a circle with a radius of 0.5 NM around this point. If the size of the attack area is known to be larger, adjust the radius accordingly.

(b) Plot the downwind direction. From the center of the attack area circle, draw a line representing the downwind direction.

(c) Draw the tangents to the attack area. Draw two lines which, being tangents to the circle, form an angle equal to the half-sector angle on either side of the representative downwind direction (downwind axis).

(d) Plot the hazard levels. Label the point on the downwind direction line (downwind axis), marking the extent of the DHD for the relevant level of hazard (LCt₅₀, ICt₅, and/or miosis). Draw a line through this (these) point(s), perpendicular to the downwind axis and intersecting the two tangents. The downwind hazard area is contained within this line, the tangents, and the upwind arc of the attack area circle.

(2) Low Wind Speeds. When low wind speeds (5 knots or less) are reported in the NBC CDM, draw a circle concentric to the attack area circle, using the relevant DHD as the radius. However, the radius should not exceed 15 NM (see Figure E-26, page E-49).

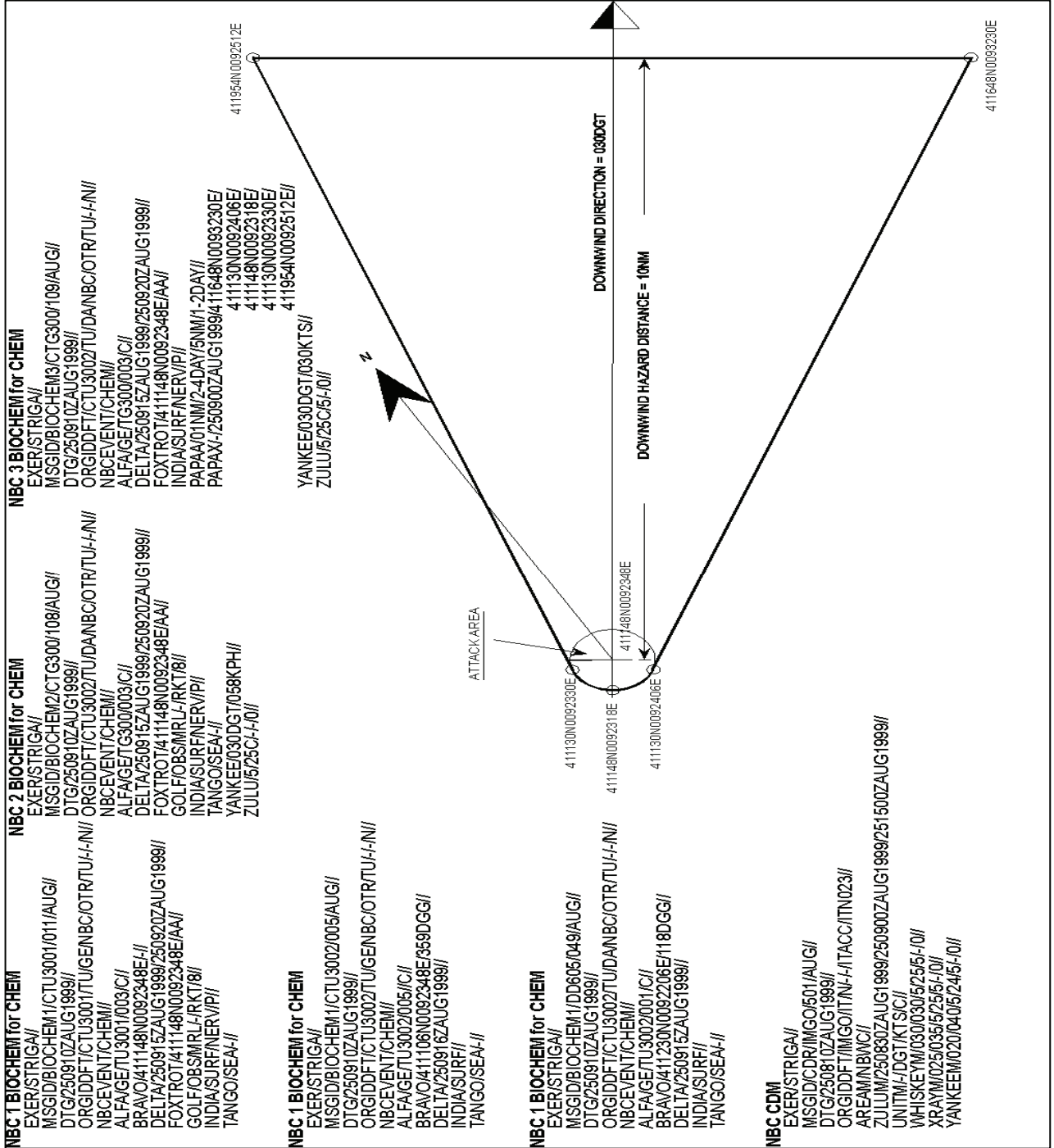

Figure E-24. Chemical Downwind Hazard Area Plot

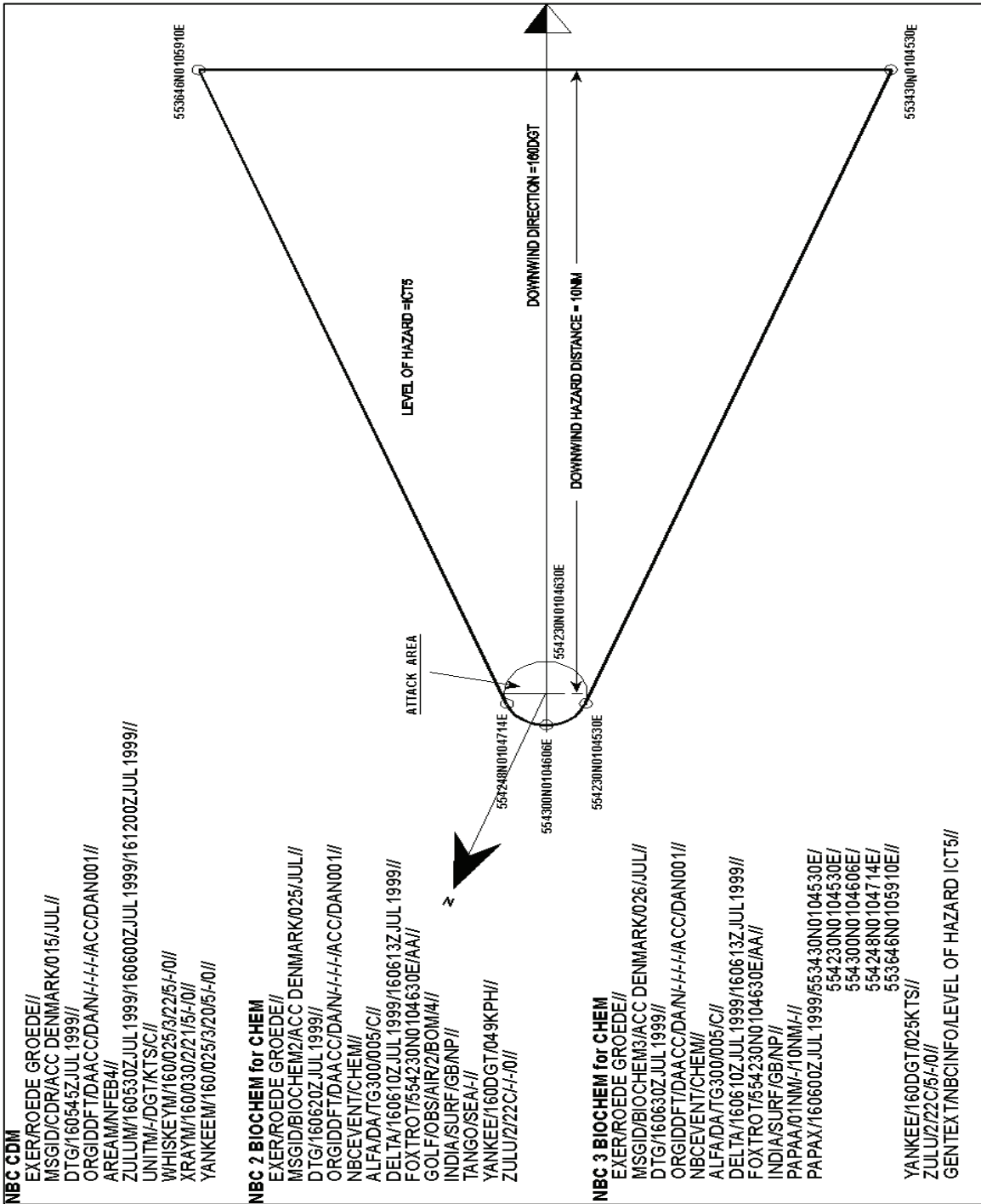

Figure E-25. Downwind Hazard Area, Type A Attack, Wind Speed ≥10 Knots

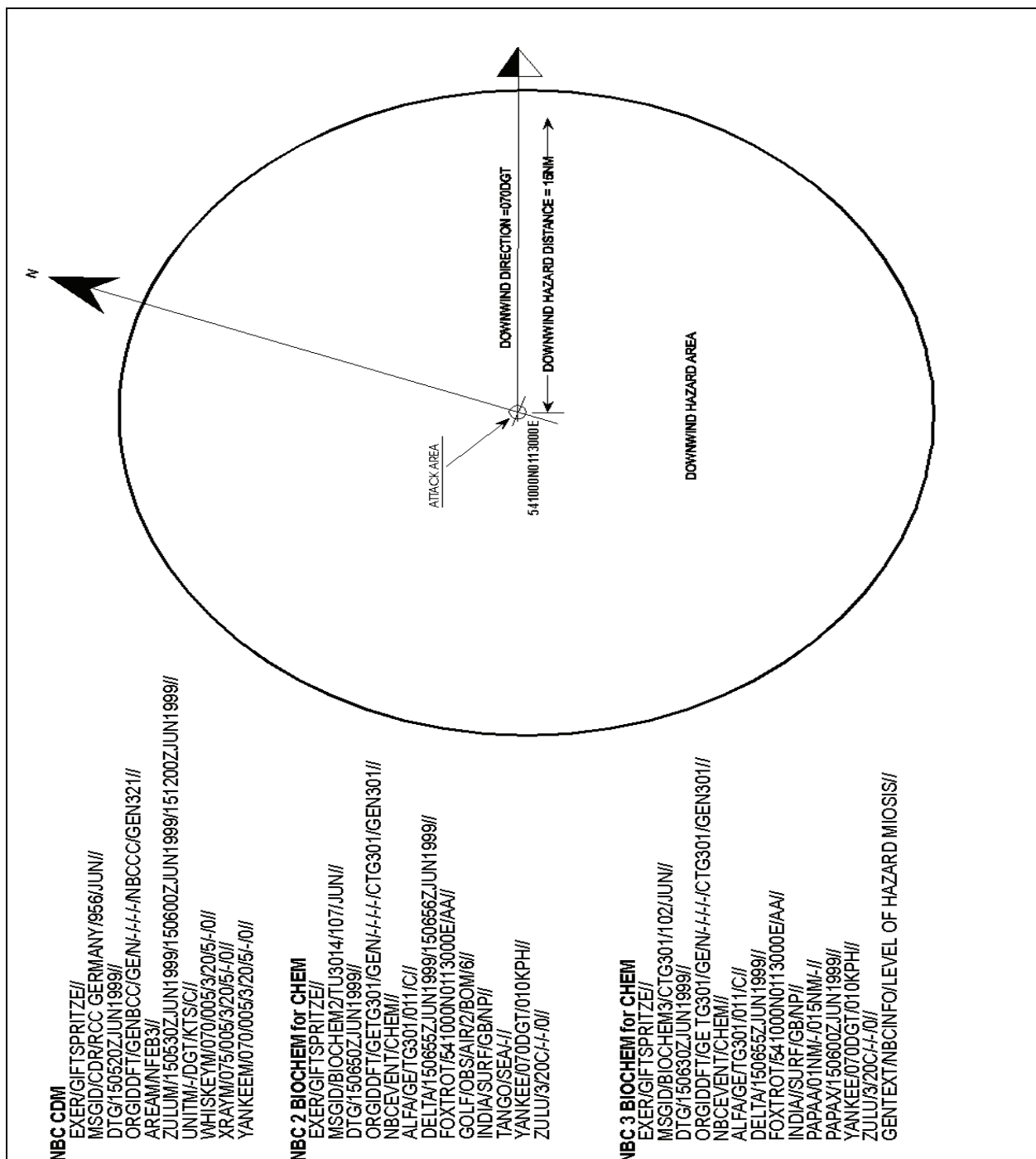

Figure E-26. Downwind Hazard Area, Type A Attack, Wind Speed ≤ 5 Knots or Variable

r. Change in MET Conditions.

(1) Adjustment Requirements. If the MET conditions change during the hazard, the predicted hazard area must be adjusted for the following:

- (a) Stability category changes from one category to another.
- (b) Wind speed changes of more than 5 knots.
- (c) Wind direction changes of more than 20° .

(2) **Recalculation of Hazard.** The new hazard area is determined by calculating the downwind distance that the agent cloud may have traveled at the time of the change in the MET conditions using the representative downwind speed. Consider this point to be the center point of a new attack area, and draw a circle around it with a radius equal to half the width of the hazard area at that point. From there on, repeat the steps using the procedure described previously. The distance which the agent cloud may already have traveled must be subtracted from the maximum DHD under the new weather conditions (see Figure E-27, page E-52).

(3) **Agent Clouds Crossing the Coast Line.** When a cloud from a chemical agent crosses the coast line from sea to land or vice versa, consider the point where the downwind direction line (downwind axis) intersects the coast line to be the center point of a new attack area. Follow the procedure described above using the appropriate tables for sea and land to determine the DHDs. When frequent changes occur, use the land procedure when working manually.

(4) **Beginning and End of Hazard.** In the case of air-contaminating attacks (nonpersistent agent), the beginning and end of the hazard at a given point may be determined using the following:

- (a) Representative downwind speed.
- (b) Distance of the location from the edge of the attack area.
- (c) Beginning and end of the attack.

The following two formulas are used:

$$t_B = (d_A \times 60) / (1.5 \times V_Z) \text{ or } t_B = (d_A \times 40) / V_Z$$

and

$$t_E = (d_B \times 60) / (0.5 \times V_Z) \text{ or } t_E = (d_B \times 120) / V_Z = 3 \times t_B$$

Where—

t_B = time in minutes from the beginning of the attack to the beginning of the hazard.

d_A = distance between the location and the downwind leading edge of the dissemination area (in NM).

d_B = distance between the location and the downwind trailing edge of the dissemination area (in NM).

V_Z = wind speed in knots. If necessary, the wind speed must be determined as the mean wind speed over several periods of validity of the NBC CDM.

t_E = time in minutes from the end of the attack to the end of the hazard.

Example:

Given: $d_A = 5$ NM, $V_Z = 10$ knots.

Using the formulas, t_B and t_E are calculated as follows:

$$t_B = (5 \text{ NM} \times 40) / 10 \text{ knots} = 20 \text{ minutes, and}$$

$$t_E = (5 \text{ NM} \times 120) / 10 \text{ knots} = 60 \text{ minutes}$$

(5) Hazard Arrival Time. The beginning of the hazard is expected at this location 20 minutes after the beginning of the attack and is expected to end 60 minutes after the end of the attack.

(6) Maximum Duration. The expected maximum duration of the air-contaminating hazard (i.e., when the calculated hazard is expected to be completely clear) may be obtained by using the maximum DHD as d_A , and calculating t_E from the formulas in paragraph (4) above.

(7) The CBRN cells must continuously check the NBC3 CHEM messages issued in order to ensure that any new information (MET or CBRN) is considered. If necessary, a corrected NBC3 CHEM message must be transmitted.

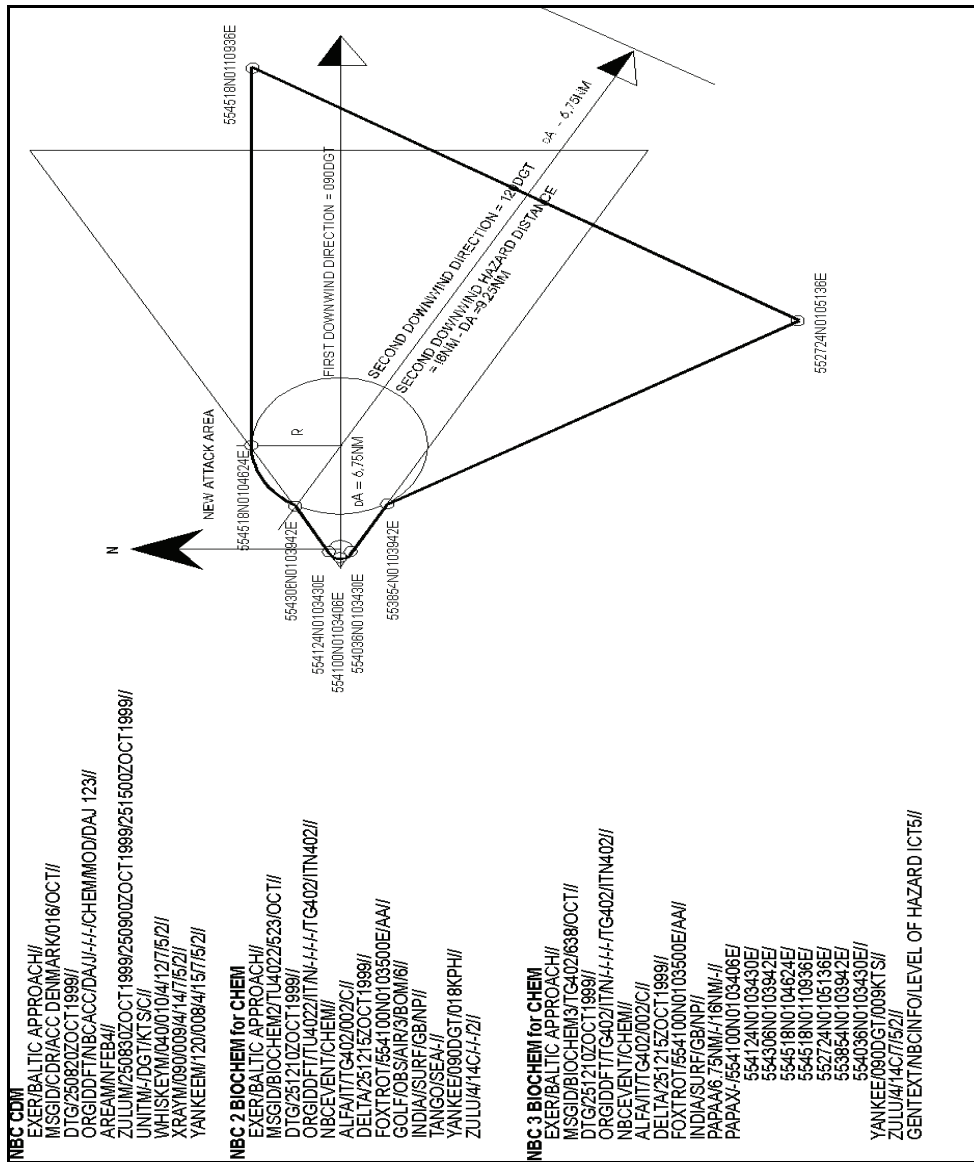

Figure E-27. Recalculation of Downwind Hazard Area, Type A Attack After Change in Downwind Direction at Point B

6. NBC4 CHEM Report

a. When any unit detects CBRN hazards through monitoring, survey or reconnaissance, this information is reported using an NBC4 CHEM report (see Figure E-28). Separate NBC4 CHEM reports are consolidated and then plotted on the tactical map to show where the hazard exists. If monitoring information is incomplete, a survey may be directed. Monitoring reports contain the type of agent detected (line INDIA) indicating the type of chemical agent and persistency, the location of the sampling (geographical position), the type of sample (air sample or liquid sample) (line QUEBEC), the date-time of the detection (line SIERRA), and topography information (line TANGO).

| NBC4 CHEM Report | | | |
|------------------|---|------|----------------------------|
| Line Item | Description | Cond | Example |
| ALFA | Strike serial number | O | ALFA/US/A234/001/C// |
| INDIA | Release information on CB agent attacks or ROTA events | O | INDIA/UNK/NERV// |
| QUEBEC | Location of reading/sample/detection and type of sample/detection | M | QUEBEC/32VNJ481203/-/DET// |
| ROMEO | Level of contamination, dose rate trend and decay rate trend | O | ROMEO/20PPM// |
| SIERRA | DTG of reading or initial detection of contamination | M | SIERRA/202300ZSEP1997// |
| TANGO | Terrain/topography and vegetation description | M | TANGO/FLAT/URBAN// |
| WHISKEY | Sensor information | O | WHISKEY/POS/POS/NO/MED// |
| YANKEE | Downwind direction and downwind speed | M | YANKEE/270DGT/015KPH// |
| ZULU | Actual weather conditions | O | ZULU/4/10C/7/5/1// |
| GENTEXT | General text | O | - |

Figure E-28. Sample NBC4 CHEM Report

b. Lines QUEBEC, ROMEO, SIERRA, and TANGO are a segment. With the exclusion of line ROMEO, this segment is mandatory. Lines/segments are repeatable up to 20 times in order to describe multiple detection, monitoring, or survey points.

c. If no chemical agent is detected, this should be reported by entering NIL in line INDIA. When all hazards from one attack are gone, the responsible CBRN cell should annotate this in an NBC4 CHEM report by entering NIL in line INDIA and by entering "CHEMICAL FREE ATTACK" in line GENTEXT/CBRNINFO. To

be able to identify the attack, the strike serial number (line ALFA from the NBC2 CHEM report) must be included in the report.

d. For detailed information regarding chemical reconnaissance, refer to *Multiservice Tactics, Techniques, and Procedures for Nuclear, Biological, and Chemical Reconnaissance*.

7. NBC5 CHEM Report

a. The NBC5 CHEM report is prepared from the contamination plot. This report is last in order because it consists of a series of grid coordinates. Often, this message must be sent via radio nets. This requires lengthy transmission. The recipient is required to plot each coordinate and redraw the plot. This report may also be sent as a map overlay.

b. For NBC5 CHEM reports, line items INDIA (release information), OSCAR (reference time), and XRAYA (actual contour information) are mandatory (see Figure E-29).

| NBC5 CHEM Report | | | |
|------------------|--|------|---|
| Line Item | Description | Cond | Example |
| ALFA | Strike serial number | O | ALFA/US/A234/001/C// |
| DELTA | DTG of attack or detonation and attack end | O | DELTA/201405ZSEP1997// |
| INDIA | Release information on CB agent attacks or ROTA events | M | INDIA/AIR/NERV/P/ACD// |
| OSCAR | Reference DTG for estimated contour lines | M | OSCAR/201505ZSEP1997// |
| XRAYA* | Actual contour information | M | XRAYA/LCT50/32VNJ575203/ 32VNJ572211/32VNJ560219/ 32VNJ534218/32VNJ575203// |
| XRAYB* | Predicted contour information | O | |
| YANKEE | Downwind direction and downwind speed | O | YANKEE/270DGT/015KPH// |
| ZULU | Actual weather conditions | O | ZULU/4/10C/7/5/1// |
| GENTEXT | General text | O | |

*Line items are repeatable up to 50 times to represent multiple contours.

Figure E-29. Sample NBC5 CHEM Report

8. NBC6 CHEM Report

The NBC6 CHEM report is a summary of the information concerning the CBRN and ROTA events. NBC6 CHEM reports consist mainly of general text, which gives information on the event (see Figure E-30).

| NBC6 CHEM Report | | | |
|------------------|--|------|---|
| Line Item | Description | Cond | Example |
| ALFA | Strike serial number | O | ALFA/US/A234/001/C// |
| DELTA | DTG of attack or detonation and attack end | O | DELTA/201405ZSEP1997/ 201420ZSEP1997// |
| FOXTROT | Location of attack and qualifier | O | FOXTROT/32UNB058640/EE// |
| INDIA | Release information on CB agent attacks or ROTA events | O | INDIA/AIR/NERV/P/ACD// |
| QUEBEC | Location and type reading /sample/ detection | O | QUEBEC/32VNJ481203/-/DET// |
| SIERRA | DTG of reading | O | SIERRA/202300ZSEP1997// |
| GENTEXT | General text | M | GENTEXT/CBRNINFO/SICA LAB REPORT HAS IDENTIFIED THE AGENT AS VX// |

Figure E-30. Sample NBC6 CHEM Report

THIS PAGE IS INTENTIONALLY LEFT BLANK

Appendix F

BIOLOGICAL-CONTAMINATION AVOIDANCE TACTICS, TECHNIQUES, AND PROCEDURES

1. Background

As with all forms of CBRN attacks or ROTA, an effective means of communication must be trained and rehearsed for the avoidance of biological contamination to be successful. Once a unit is aware that it may have been in a biological attack or is within a possible hazard area, the avoidance procedures throughout this manual should be initiated. The CBRNWRS should be used to relay information about the biological agents and hazards in an efficient and timely manner. Biological avoidance requires an understanding of what biological agents are, how they may be employed, and what happens to the agents after they are released. Biological agents are broken down into two broad categories—pathogens and toxins.

- Pathogens are infectious agents that cause disease in man, animals, or plants. Agents that constitute antipersonnel BW threats include bacteria, viruses, and rickettsias.
- Toxins are poisonous substances produced as by-products of the microorganisms (pathogens), plants, and animals.

NOTE: For more information on the types of biological agents, refer to Appendix B.

2. Biological-Agent Dissemination Methods

There are three general methods of disseminating biological agents—aerosol, vector, and covert. Each method is designed to get the agent into the body, and each method targets a specific portal of entry in order to infect the individual.

a. Aerosol Dissemination.

(1) **Biological Agents.** Biological agents may be disseminated by ground- or air-bursting munitions, aircraft spray tanks, or boat- or truck-mounted aerosol generators. An aerosol attack will most likely occur in a covert (hidden) manner. Dissemination is likely to occur at altitudes of 1,000 feet or less (100 feet optimum). The estimation of the hazard areas resulting from dissemination at altitudes greater than 1,000 feet aboveground requires extensive MET analysis.

(2) **Toxins.** Toxins can be disseminated as a liquid (such as “yellow rain”). This makes the toxin highly visible and an immediate hazard. It will generally be limited to the immediate area of the attack.

(3) **Aerosol Cloud Travel.** In a tactical aerosol attack, the aerosol cloud (after initial formation) will travel downwind at a rate determined by the wind speed. The cloud will lengthen and widen as it travels downwind. The length of the agent cloud will equal about one-third of the distance traveled. Units near the release point will encounter a more concentrated cloud. However, units located farther downwind (even though exposed to a less concentrated agent cloud) will be exposed for a longer period of time, so unprotected personnel may inhale a higher total dose. The peak danger area will be located in the area

where the cloud stays intact, while at the same time, it is at its maximum width and length. This distance is approximately the maximum downwind hazard prediction for a chemical agent; therefore, it is vital to determine whether or not the attack is biological or chemical.

(4) **Casualty Production.** The biological-agent cloud can cause immediate and delayed casualties. This is due to the fact that each individual will receive a different dose, and the time until the onset of symptoms will depend on the amount of agent received and each individual's physiological makeup. The onset of illness will also be affected by the person's reaction time and any other forms of protection (i.e., inoculation, masking time) that were available against the agent. Biological-agent casualties can occur in an area as much as two times the maximum DHD for a chemical agent.

(5) **Dispersal and Settling Out.** Traveling farther downwind, the cloud is exposed to the environmental elements. It is subjected to dispersal, settling, and impaction on the terrain features. The agent cloud will lose much of its concentration, and the losses will be such that the majority of unprotected personnel will not receive an infective (pathogen) or effective (toxin) dose. Dispersal will not be uniform, and casualties may occur as far as four to five times the maximum DHD of chemical agents.

(a) **Bursting-Type Munitions.** When a biological projectile or bomb bursts, the filling (liquid slurry or dry powder) is initially dispersed in all directions. An effective ground-bursting munition will project the majority of the filling into the air to form an aerosol cloud. Air-bursting munitions may also form an aerosol cloud that will behave in a similar manner to a spray attack. The agent may be designed to fall to the ground as a surface contaminant, much like persistent chemical agents. The dimensions of the aerosol cloud will be influenced by the means of delivery, weather conditions, and terrain.

(b) **Spray Tanks and Generators.** Aircraft and vehicle spray tanks or aerosol generators may be employed to form an aerosol cloud. This form of attack is likely to take place covertly.

b. **Vector Dissemination.** Some pathogens may be delivered by the use of vectors, such as fleas, ticks, lice, or mosquitoes. Many of these same vectors have carried diseases since recorded history, and avoidance procedures should be practiced at all times to limit the potential for infection.

(1) **Controlling Vectors.** One of the major difficulties with vectors is control. Once they are released, they are basically out of control and can attack anyone. Vectors are quite mobile and can easily leave the area where they were released.

(2) **Logistical and Production Problems.** Getting a live, infective pathogen inside a vector is a difficult proposition. Getting the vector inside a delivery vehicle that will not damage or kill the vector is another difficult issue. Doing these things and then delivering sufficient quantities of the vectors to be effective in producing a disease outbreak will be difficult.

c. **Covert Dissemination.** Sabotage and terrorist personnel may possess a variety of aerosol and contamination (poisoning) techniques for various targets. Aerosol techniques can be fairly large operations, using aerosol generators (or foggers) that produce large, open-air hazard areas. These techniques also can be more limited and selective, targeting the enclosed air space of key C2 facilities, aircraft, ships, troop billets, and similar areas.

Biological agents in liquid, powders, or spray can be placed directly into foodstuffs at harvest, processing, distribution, and preparation points. They can also be placed into the water reservoir or distribution chain.

3. Avoidance Procedures

Avoidance procedures are broken down into actions—before, during, and after the attack. For a biological attack, these procedures will also be broken down by the different dissemination methods. The lists given, while not all-encompassing, will assist in developing the unit SOP and directives.

a. Aerosol Avoidance Procedures.

(1) Preattack.

- (a) Alert subordinate units.
- (b) Establish and enforce preventive medicine (PVNTMED) programs to include immunizations, area sanitation, personal-hygiene standards, and rest and nutritional needs of the troops.
- (c) Gain intelligence on the threat capabilities and intentions.
- (d) Seek out, intercept, and destroy enemy weapon systems, production facilities, and storage sites.
- (e) Instruct troops on the threat, how to recognize the attack, and protective measures to be taken.
- (f) Train and drill on the fitting and donning of protective masks and clothing.
- (g) Set up collective protection systems for personnel, equipment, and supplies.

NOTE: Field-expedient collective protection must be airtight.

- (h) Identify backup (alternate) food, water, and supply sources.
- (i) Establish detection and sampling procedures.
- (j) Conduct a vulnerability analysis.
- (k) Increase MEDSURV.
- (l) Increase food and water surveillance.
- (m) Distribute prophylaxis if the threat agents are known and prophylaxis for the agent exists.

(2) During Attack.

- (a) Recognize the attack.
- (b) Initiate personnel protective measures. In the event of a potential biological attack involving a munitions release, masking is the first priority; but since the attack may be chemical or toxin, MOPP4 is initially required. For the maximum protection and the lowest risk of incurring casualties, soldiers should wear protective clothing and masks for at least 4 hours after the unit has been attacked or the agent cloud is predicted or known to have passed through the unit area. Every effort must be made to identify the

exact agent, including its characteristics. If the skin is contaminated, remove the contamination immediately using the procedures provided in the *Multiservice Tactics, Techniques, and Procedures for Chemical, Biological, Radiological, and Nuclear Decontamination*.

- (c) Repulse or eliminate the delivery vehicle or weapons.
 - (d) Observe for distinguishing signs between a biological- and chemical-agent attack or a mixture of a conventional and biological attack.
 - (e) Report the attack utilizing the CBRNWRS. A biological attack that cannot be immediately identified will be reported as an NBC1 UNK.
- (3) Postattack.
- (a) Estimate the downwind hazard. Significant casualties in unprotected personnel can occur at two times the maximum DHD for a chemical agent.
 - (b) Determine the BW agent.
 - (c) Initiate prophylaxis and vaccination against a biological attack. This should be the first priority once the agent is known.
 - (d) Begin sampling and collection procedures according to the unit SOP.
 - (e) Consume only sealed rations and properly contained water. Outer-container surfaces, if exposed, must be properly decontaminated. Call PVNTMED personnel when the safety of the unit level water supplies is questionable. Inspect food storage depots and supply points. Replenish water supplies from the water purification units.
 - (f) Separate the biological casualties. Separate the ill from the well individuals if the BW agent is contagious (isolation of ill). If possible, only properly protected individuals (vaccinated, on prophylaxis, or in proper personal protective equipment) should provide treatment to sick individuals. If unprotected individuals must provide treatment, use a minimum number of personnel until protective prophylaxis or equipment can be obtained. Keep in mind that when dealing with contagious individuals, evacuation options may be limited.
 - (g) Implement movement restriction if the BW agent is contagious.

b. Vector Avoidance Procedures.

- (1) Preattack.
 - (a) Apply insect repellent on the exposed skin.
 - (b) Gain intelligence on the threat capabilities and intentions.
 - (c) Seek out, intercept, and destroy enemy weapon systems and production and storage sites.
 - (d) Instruct troops on the threat, recognition of the attack, and protective measures.
 - (e) Establish and enforce PVNTMED programs, to include immunizations, area sanitation, personal-hygiene standards, and rest and nutritional needs of the troops.

(2) During Attack.

(a) Recognize and report suspicious indications of the vector attack (the sudden appearance of large numbers or strange kinds of insects not previously encountered in an operational area or the finding of vector bomblet cages).

(b) Cover the exposed skin. Balance between protection and performance degradation. Protective overgarments will not totally exclude a determined tick. Bloused trousers and rolled-down, buttoned sleeves with insect repellent (properly applied) will probably afford as much protection with less degradation.

(c) Apply insect repellent liberally, especially to neck, face, ankle, and wrist areas.

(d) Report the attack.

(3) Postattack.

(a) Coordinate with the supporting medical authority for PVNTMED assistance.

(b) Begin insecticide and other pest control measures as outlined by PVNTMED personnel. Logistical support for unit size pest control procedures should be a coordinated effort between the CBRN staff and the supporting medical authority. Physically remove lice, ticks, and fleas from body by self-aid and buddy aid, as necessary.

(c) Make hazard estimates. Reconnaissance and medical reports may help the CBRN staff assess the hazard areas.

c. Covert Avoidance Procedures.

(1) Preattack.

(a) Maintain OPSEC.

(b) Identify covert and sabotage threat force capabilities and intentions.

(c) Arrange for security measures to be taken based upon threat assessment.

(d) Identify alternate supply sources for high-risk items.

(e) Instruct troops to be alert to the dissemination devices or signs of covert tampering, as intelligence dictates.

(f) Establish and enforce PVNTMED programs, to include immunizations, area sanitation, personal-hygiene standards, and rest and nutrition needs of the troops. The protection of food and water may prevent the successful employment of a specific biological agent.

(2) During Attack.

(a) Report the observation of an attack, the apprehension of enemy agents engaged in such activity, or the finding of signs and indications of covert attacks.

(b) Initiate personnel and collective protection. For maximum protection and the lowest risk of incurring casualties, soldiers should maintain protective posture for at least 4 hours.

(3) Postattack.

(a) Warn personnel downstream, downwind, and down the supply lines. The CBRN cell will warn personnel based on at-hand medical and intelligence information and the analysis of NBC1 BIO reports.

(b) In conjunction with veterinary personnel and the Surgeon General, initiate the disposal and replacement of food, water, and other supplies. The CBRN cell can coordinate inspections and medically approved replenishment sources. Actions involving the disposal of major quantities of food must be coordinated with the supporting veterinary personnel. Actions involving the disposal of major quantities of other nonmedical supplies should be coordinated with the CBRN cell.

(c) Initiate sampling based on the knowledge, consent, and special sampling requirements. If a BW attack is suspected, wash surfaces with at least a 5 percent solution of bleach. Bleach is a very effective form of decontamination for most BW agents.

4. Biological-Contamination Reporting, Predicting, and Plotting

In order for a unit to implement passive avoidance measures, it will need advanced warning of a potential contamination. The rest of this chapter deals with the various NBC BIO reports and the prediction of hazard areas.

5. NBC1 BIO Report

The NBC1 BIO report is the most widely used report. The observing unit uses this report to provide CBRN attack data. All units must be completely familiar with the NBC1 BIO report format and the information needed to complete the report. This report is prepared quickly and accurately at the unit level and sent to the next higher HQ or NBC cell as directed by OPORDs/directives. NBC1 BIO reports are not routinely passed to corps or higher CBRN cells, except for the initial-use report. Lines BRAVO (location of observer), DELTA (DTG), GOLF (means of delivery), INDIA (release information), and TANGO (terrain, topography, and vegetation description) are mandatory entries in the NBC1 report.

a. Precedence. The precedence of the NBC1 BIO report depends on whether or not it is an initial report. The initial use of a CBRN weapons report is FLASH precedence; all others are IMMEDIATE precedence.

b. Preparation. Individuals identified by the unit SOP submit raw data to the unit CBRN defense team. The NBC1 BIO format should be used; however, a SALUTE, or spot report may also be used and should be submitted to the unit CBRN defense team. The unit CBRN defense team normally consists of the individuals who have been trained in CBRN defense. This ensures that the report is in the proper format and is correct.

c. Sample. A sample NBC1 report is shown in Figure F-1. The column "Cond" shows O (operationally determined) or M (mandatory) for each message type. Operationally determined sets listed may be added or deleted at the user's discretion.

| NBC1 BIO Report | | | |
|-----------------|--|---|---|
| Line Item | Description | Cond | Example |
| ALFA | Strike serial number | Will be assigned by the servicing CBRN cell | |
| BRAVO | Location of observer and direction of attack or event | M | BRAVO/32UNB062634/2500MLG// |
| DELTA | DTG of attack or detonation and attack end | M | DELTA/201405ZSEP1997/ 201420ZSEP1997// |
| FOXTROT | Location of attack or event | O | FOXTROT/32UNB058640/EE// |
| GOLF | Delivery and quantity information | M | GOLF/OBS/AIR/1/BML/-// |
| INDIA | Release information on CB agent attacks or ROTA events | M | INDIA/AIR/BIO/BG/DET// |
| TANGO | Terrain/topography and vegetation description | M | TANGO/FLAT/URBAN// |
| YANKEE | Downwind direction and downwind speed | O | YANKEE/270DGT/015KPH// |
| ZULU | Actual weather conditions | O | ZULU/4/10C/7/5/1// |
| GENTEXT | General text | O | - |

Figure F-1. Sample NBC1 BIO Report

6. NBC2 BIO Report

The NBC2 BIO report is based on one or more NBC1 BIO reports. It is used to pass evaluated data to higher, subordinate, and adjacent units. The CBRN cell is usually the lowest level that prepares NBC2 BIO reports. However, CBRN personnel at an intermediate HQ may prepare NBC2 BIO reports if they have sufficient data. These intermediate HQ, however, will not assign a strike serial number. The CBRN cell prepares the NBC2 BIO report, assigns it a strike serial number, and disseminates it to the appropriate units. Each subordinate unit then decides whether to disseminate the report further. Lines ALFA (strike serial number), DELTA (DTG), FOXTROT (location of attack), GOLF (means of delivery), INDIA (release information), and TANGO (terrain, topography, and vegetation description) are mandatory entries in the NBC2 BIO report. A sample NBC2 BIO report is shown in Figure F-2, page F-8.

| NBC2 BIO Report | | | |
|-----------------|--|------|---|
| Line Item | Description | Cond | Example |
| ALFA | Strike serial number | M | ALFA/US/A234/001/B// |
| DELTA | DTG of attack or detonation and attack end | M | DELTA/201405ZSEP1997/ 201420ZSEP1997// |
| FOXTROT | Location of attack or event | M | FOXTROT/32UNB058640/EE// |
| GOLF | Delivery and quantity information | M | GOLF/OBS/AIR/1/BML/-// |
| INDIA | Release information on CB agent attacks or ROTA events | M | INDIA/AIR/BIO/BG/DET// |
| TANGO | Terrain/topography and vegetation description | M | TANGO/FLAT/URBAN// |
| YANKEE | Downwind direction and downwind speed | O | YANKEE/270DGT/015KPH// |
| ZULU | Actual weather conditions | O | ZULU/4/10C/7/5/1// |
| GENTEXT | General text | O | |

Figure F-2. Sample NBC2 BIO Report

7. NBC3 BIO Report

Area CBRN centers use NBC2 BIO reports and current wind information to predict the area of hazard. This prediction is disseminated as an NBC3 BIO report. It is sent to all units or activities that could be affected by the hazard. Each unit or activity prepares a plot of the NBC3 BIO report, determines which of its subordinate units or activities are affected, and warns them accordingly. Commanders should use this report as battlefield intelligence when planning missions. The NBC3 BIO report is a prediction of the hazard area. This prediction is safe-sided to ensure that a significant hazard will not exist outside the predicted hazard area. As the JWARN is developed and fielded, its built-in models will give a more realistic depiction of the actual hazard area. Units within the hazard area must adjust their MOPP level if necessary. A sample NBC3 BIO report is shown in Figure F-3.

| NBC3 BIO Report | | | |
|-----------------|--|------|--|
| Line Item | Description | Cond | Example |
| ALFA | Strike serial number | M | ALFA/US/A234/001/C// |
| DELTA | DTG of attack or detonation and attack end | M | DELTA/201405ZSEP1997/ 201420ZSEP1997// |
| FOXTROT | Location of attack or event | M | FOXTROT/32UNB058640/EE// |
| GOLF | Delivery and quantity information | O | GOLF/OBS/AIR/1/BMLJ-// |
| INDIA | Release information on CB agent attacks or ROTA events | M | INDIA/AIR/BIO/BG/DET// |
| PAPAA | Predicted attack/release and hazard area | M | PAPAA/1KM/3-10DAY/10KM/2-6DAY// |
| PAPAX | Hazard area location for weather period | M | PAPAX/201600ZSEP1997/ 32VNJ456280/32VNJ456119/ 32VNJ576200/32VNJ566217/ 32VNJ456280// |
| XRAYB | Predicted contour information | C | |
| YANKEE | Downwind direction and downwind speed | O | YANKEE/270DGT/015KPH// |
| ZULU | Actual weather conditions | O | ZULU/4/10C/7/5/1// |
| GENTEXT | General text | O | |

Figure F-3. Sample NBC3 BIO Report

a. Definitions. In order to avoid contamination, the commander needs to know where the contamination is located. The biological prediction procedure provides information on the location, extent of the hazard area, and duration of the hazard resulting from attacks with biological weapons. It provides the necessary information for commanders to warn units within the predicted hazard area. The following definitions are used in predicting biological hazards.

(1) Attack Area. This is the predicted area immediately affected by the delivered biological agent.

(2) Hazard Area. This is the predicted area in which unprotected personnel may be affected by an agent spreading downwind from the attack area. The downwind distance depends on the type of attack and on the weather and terrain in the attack and downwind areas.

(3) Contaminated Area. This is the area in which a biological hazard may remain at hazardous levels for some time after the attack. The contamination may be in solid or liquid form. The actual shape and duration can only be determined by surveys and sampling.

b. Types of Biological Attacks. Biological attacks can be categorized into the following four groups, based on the means of delivery and wind speed (see Table F-1).

(1) Type P. Type P consists of attacks with localized exploding munitions (such as bomb [BOM], shell [SHL], rocket [RKT], mine [MNE], missile [MSL]), surface release spray (SPR), or surface release aerosol generator (GEN).

(2) Type Q. Type Q consists of attacks with munitions that cover a large area (such as bomblets [BML] or air burst MSL).

(3) Type R. Type R consists of attacks where the location of the attack is known, but the type of container is unknown (UNK), or the attack was from an air release SPR or GEN.

(4) Type S. Type S consists of detection after an unobserved attack.

NOTE: A surface release SPR or GEN should be treated as Type R if it is mobile and releases material over a distance exceeding 1 km.

Table F-1. Types and Cases of Attacks

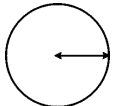
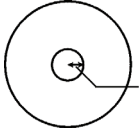
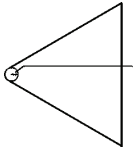
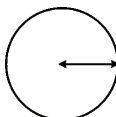
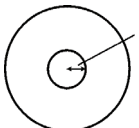
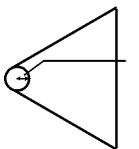
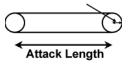
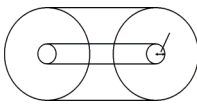
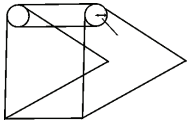
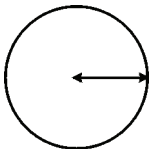
| Type Of Agent Container | Radius Of Attack Area* | Wind Speed | Type** | Case | Figure |
|---|---|------------|--------|------|---|
| BOM, RKT, SHL, MNE, Surface-burst MSL, Surface release SPR, or GEN |  | ≤10 kph | P | 1 |  |
| | | >10 kph | | 2 |  |
| BML or Air-burst MSL |  | ≤10 kph | Q | 1 |  |
| | | >10 kph | | 2 |  |
| Air release SPR and GEN or UNK |  | ≤10 kph | R | 1 |  |
| | | >10 kph | | 2 |  |
| Detection after unobserved attack (NBC4 BIO message) | | | S | 1/2 |  |
| <p>NOTE: An NBC1 BIO report may be received after an unobserved attack and should be treated as an NBC4 BIO report.</p> <p>*A different observed radius may be specified in GENTEXT.</p> <p>**If two types of attack are found, use the following order to determine which type of attack to use: Type R, Type Q, or Type P.</p> | | | | | |

c. Hazard Prediction. Before a detailed prediction can be made, the CBRN staff will determine the type of biological attack and the case. This information is crucial for the hazard prediction.

(1) Attack Location. Determine or estimate the location of the attack from the NBC1 BIO reports, and mark it on a map overlay.

(2) Attack Areas. Determine or estimate the type of attack from the NBC1 BIO reports. The attack area is plotted as outlined below.

(a) Type P. The attack area for type P is drawn as a NOT DISCLOSED radius circle, centered at the release location.

(b) Type Q. The attack area for Type Q is drawn as a NOT DISCLOSED radius circle, centered at the release location.

(c) Type R. The attack area for Type R is defined by the line end points entered as two positions in set FOXTROT. A NOT DISCLOSED radius circle is drawn at the center position or at the two end positions, with tangents connecting the two circles together. If the flight direction cannot be established, assume it to be perpendicular to the wind direction. If only one position is reported in set FOXTROT, the line is NOT DISCLOSED, long-centered on this point, oriented in the direction of the aircraft trajectory, and centered at the middle of the observed flight path.

(d) Type S. The attack area for Type S is drawn as a NOT DISCLOSED radius circle, centered at the detection location. The attack area is unknown; this is only an initial area.

NOTE: The attack area for Types P, Q, or R may be reduced or enlarged based on the available information specified in GENTEXT. In computer-generated messages, this information will be formatted as RDS: XXXKM, always using three digits for the radius (e.g., RDS: 045KM).

d. Downwind Travel Distances.

(1) Downwind Travel. The downwind travel distance is defined as the distance traveled by the center of the cloud. The downwind travel distance is broken into three segments corresponding to the three time periods of the NBC CDR as follows:

$$d_1 = u_1 t_1$$

$$d_2 = 2u_2$$

$$d_3 = 2u_3$$

Where—

d_1 = distance (in km) travelled within the first NBC CDR 2-hour period of the attack.

d_2 = distance (in km) travelled within the next NBC CDR 2-hour period.

d_3 = distance (in km) travelled within the third NBC CDR 2-hour period.

u_1 = wind speed (in kph) for the first NBC CDR 2-hour period following the attack.

u_2 = wind speed (in kph) for the next NBC CDR 2-hour period.

u_3 = wind speed (in kph) for the third NBC CDR 2-hour period.

t_1 = hours remaining after the attack or detection within the NBC CDR 2-hour period of validity corresponding to the attack.

(2) Special Cases.

- For any NBC CDR time periods where the wind speed is <10 kt, a value of 10 kt should be used for computations.

- Weather information may not be available for the full 6-hour period after an attack. If this is the case, the hazard distances can only be calculated for the time weather is available.

(3) Downwind Travel Distance. To calculate the downwind travel distance, perform the following steps:

- Step 1. If the attack or detection occurs in the first NBC CDR 2-hour time period, three downwind distances are calculated: d_1 , using the first NBC CDR time period (set WHISKEY); d_2 , using the second NBC CDR time period (set XRAY); and d_3 , using the third NBC CDR time period (set YANKEE).

- Step 2. If the attack or detection occurs in the second NBC CDR time period, downwind distances are calculated: d_1 , using the second NBC CDR time period (set XRAY) and d_2 , using the third NBC CDR time period (set YANKEE).

- Step 3. If the attack or detection occurs in the third NBC CDR time period, only d_1 can be calculated using set YANKEE.

(4) Total Downwind Distance. The total downwind distance of the center of the biological cloud is the sum of the three distances:

$$DA = d_1 + d_2 + d_3$$

Where —

DA = total downwind distance in km.

(5) Leading and Trailing Edges. The leading and trailing edges for the current NBC CDR should also be computed, based on the downwind distance path and using the factors of 1.5 and 0.5, respectively:

$$DL = 1.5DA$$

$$DT = 0.5DA$$

Where—

DL = leading edge distance, in km

DT = trailing edge distance, in km

(f) Third Time Period. If only the third time period is applicable, it must be extended to include the leading edge:

$$DE = DL - d_1 - d_2$$

Where—

DE = extended distance (in km) traveled within the third NBC CDR 2-hour period.

e. Determining Initial Hazard Areas.

(1) Case 1 Attacks.

(a) Wind Speed. The wind speed is 10 kph or less, so a wind speed of 10 kph should be used.

(b) Radius of Hazard Area. The radius of the hazard area circle equals the attack area radius plus the product of a wind speed of 10 kph times the time in hours remaining after the attack of detection in the corresponding CDR time period. For example, in a Type P, Case 1, attack having a 2-hour travel duration, the hazard area radius would equal:

$$(\text{time} \times \text{wind speed}) = \text{radius for Case 1}$$

$$(2 \text{ h} \times 10 \text{ km/h}) + 4 \text{ km} = 24 \text{ km}$$

(c) Types P, Q, and S. A single hazard area circle will result for Types P, Q, and S. The area within this circle represents the hazard area. The attack area for Type S is drawn as a NOT DISCLOSED (see STANAG 2130, Annex D).

(d) Type R. Two circles are drawn for Type R, with tangents drawn between the hazard area circles. The total enclosed area represents the hazard area.

(e) Downwind Distance. A value of zero is used for the downwind distance path, leading edge, and trailing edge computations for Case 1 attacks, since the wind direction is considered variable. The leading edge can be considered to be the edge of the hazard area circle.

(2) Case 2 Attacks.

(a) Downwind Direction. Determine the downwind direction from the NBC CDM. Draw a line through the center of the attack circle, oriented in the downwind direction.

(b) Type R. For a Type R release, choose one of the attack area circles. Calculate the downwind distance for the first period (d_1). This is accomplished in the same manner as in paragraph 5d above (time x wind speed + radius of circle). The line should extend to distance d_1 in the downwind direction from the center of the circle. In the upwind direction along the same line, mark a distance equal to twice the attack circle radius.

(c) End of d_1 . Draw a line perpendicular to the downwind direction line, at the downwind distance (d_1), and extending in both directions.

(d) Tangent Lines. Draw two lines tangent to the attack circle from the upwind point marked, extending until they intersect with the perpendicular line. These lines will form a 30° angle on either side of the downwind direction line.

(e) Type R. For a Type R release, for the other attack area circle and connect the lower hazard area corners to enclose the combined downwind hazard area repeat this procedure.

(f) Type S. For a Type S release, there is no hazard area plotted because the location and time of the release are unknown. A 25-km-radius circle defines an area where there is a risk of being exposed to the biological agent. Informing friendly units throughout the area of this risk should be considered. Before a hazard prediction can be carried out, reports are required from units in the area or survey teams. Once more information about the attack has been obtained, Type S attacks should then be treated as Type P, Q, or R.

f. Prediction of the Initial Hazard.

(1) Type P, Case 1 Attack (Figure F-4).

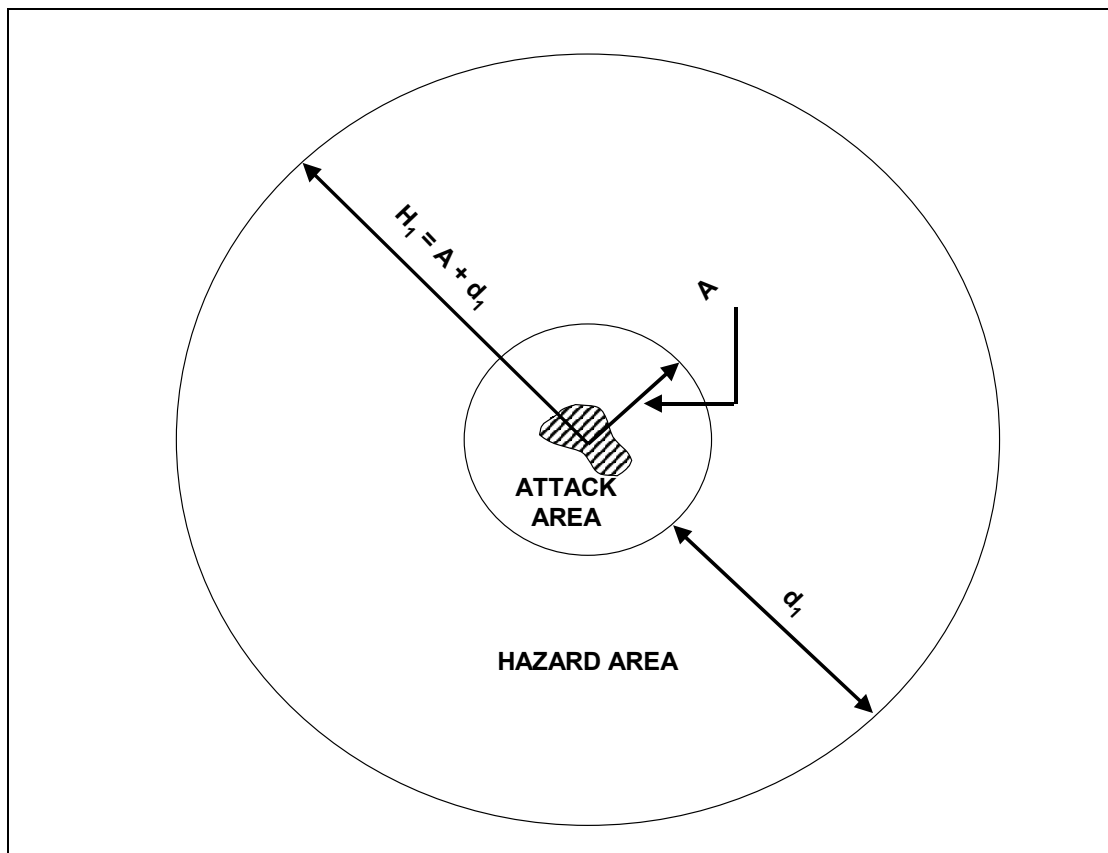

Figure F-4. Type P, Case 1, Attack

NOTE: A = radius of attack area, H₁ = radius of initial hazard area, d₁ = downwind travel distance in the CDR time period, t₁ = time remaining from attack in the CDR time period, u₁ = wind speed (10 kph), H₁ = A + d₁, d₁ = u₁ x t₁. A wind speed of 10 kph is assumed.

- (a) Step 1. Obtain the location of the attack from the relevant NBC BIO message (line FOXTROT), and plot it on the map.
- (b) Step 2. Draw a circle with a radius (A), around the center of the attack location. The area within this circle represents the attack area.
- (c) Step 3. Draw a circle with a radius (H₁) that equals the radius of the attack area (4 km) plus the downwind travel distance (d₁). Distance d₁ is equal to the wind

speed (u_1) for the CDR time period times the remaining time (t_1) from the attack within that CDR time period.

(d) Step 4. Prepare and transmit an NBC3 BIO report to units and installations in the predicted hazard area in accordance with SOPs, using the prediction in Figure F-4, page F-15.

(2) Type P, Case 2, Attack (Figure F-5).

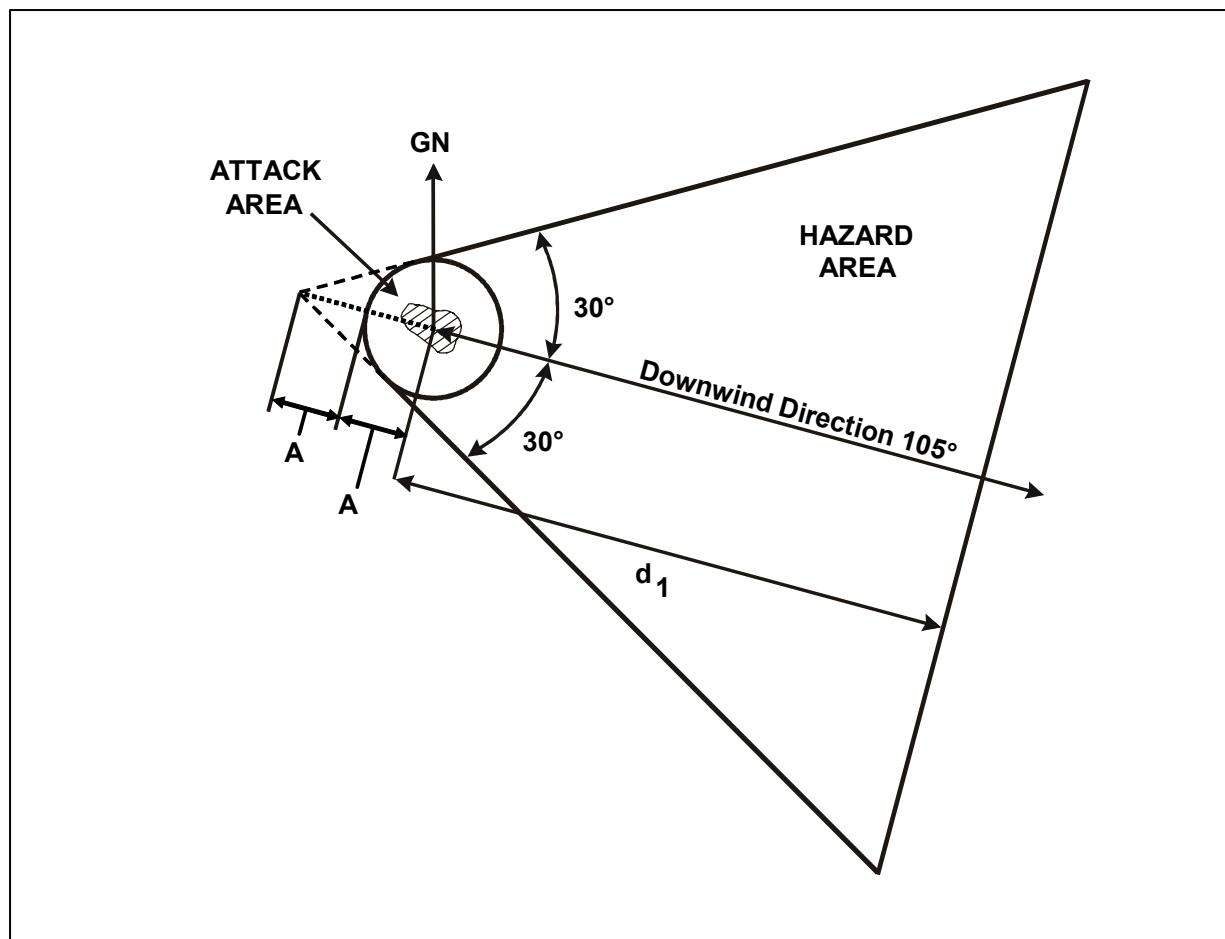

Figure F-5. Type P, Case 2, Attack

NOTE: A = radius of attack area, d_1 = downwind travel distance in the CDR time period, t_1 = time remaining from attack in the CDR time period, u_1 = wind speed, $d_1 = u_1 \times t_1$.

- (a) Step 1. Obtain the location of the attack from the relevant NBC BIO message(s) (set FOXTROT), and plot it on the map (see Figure F-5).
- (b) Step 2. From the center of the attack location, draw a GN line.
- (c) Step 3. Draw a circle with the attack area radius around the center of the attack location. The area within this circle represents the attack area.
- (d) Step 4. Using the valid NBC CDM, identify the downwind direction and the downwind speed.

(e) Step 5. From the center of the attack area, draw a line showing the downwind direction.

(f) Step 6. Determine the downwind travel distance (d_1). If d_1 is less than the attack area radius, set it equal to the attack area radius.

(g) Step 7. Plot the downwind travel distance from the center of the attack area on the downwind direction line.

(h) Step 8. From the downwind travel distance, draw a line perpendicular to the downwind direction line. Extend the line to either side of the downwind direction line.

(i) Step 9. Extend the downwind direction line twice the attack area radius upwind from the center of the attack area. This is equal to twice the radius of the attack area.

(j) Step 10. From the upwind end of this line, draw two lines, which are tangents to the attack area circle, and extend them until they intersect with the line perpendicular of the downwind direction line. These lines will form a 30° angle on either side of the downwind direction line.

(k) Step 11. The hazard area is bound by—

- The upwind edge of the attack area circle.
- The two 30° tangents.
- The line perpendicular to the downwind direction line.

(l) Step 12. Prepare and transmit an NBC3 BIO report to units and installations in the predicted hazard area according to the SOP.

(3) Type Q, Case 1, Attack (Figure F-6).

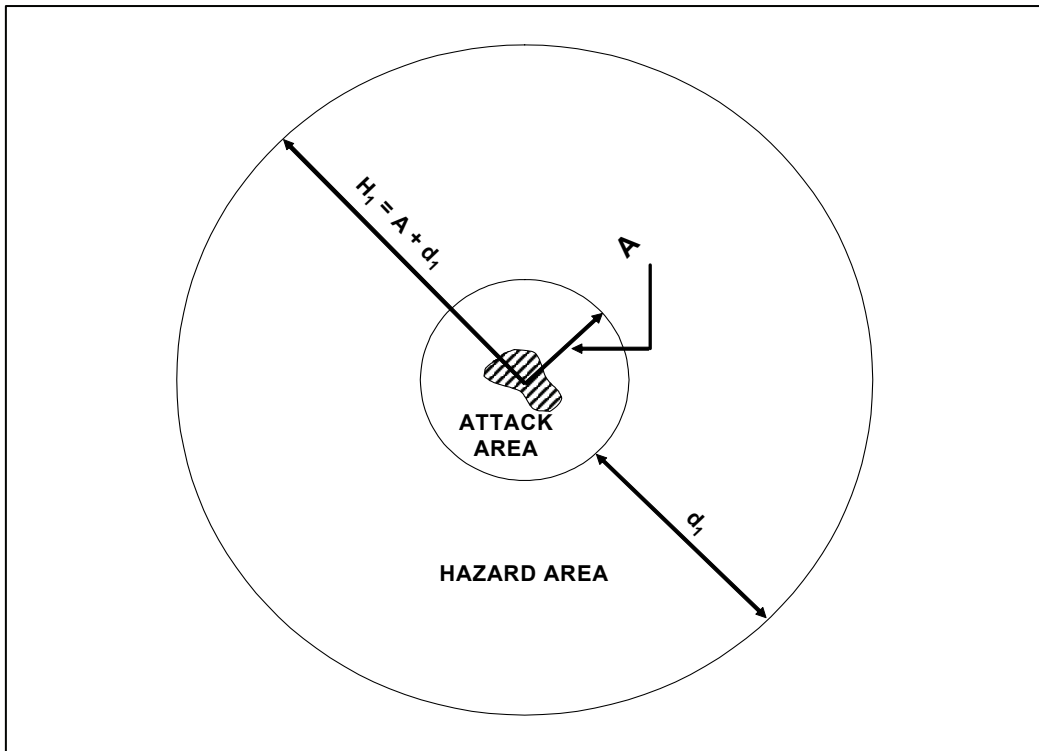

Figure F-6. Type Q, Case 1, Attack

NOTE: A = radius of attack area, H_1 = radius of hazard area, d_1 = downwind travel distance in the CDR time period, t_1 = time remaining from attack in the CDR time period, u_1 = wind speed (10 kph), $H_1 = A + d_1$, $d_1 = u_1 \times t_1$.

- (a) Step 1. Obtain the location of the attack from the relevant NBC BIO message (set FOXTROT), and plot it on the map.
 - (b) Step 2. Draw a circle with the attack area radius around the center of the attack location. The area within this circle represents the attack area.
 - (c) Step 3. Draw a circle with a radius equal to the distance d_1 (10 kph times the travel duration) plus the radius of the attack area. This circle will represent the hazard area.
 - (d) Step 4. Prepare and transmit an NBC3 BIO report to units and installations in the predicted hazard area according to the SOP.
- (4) Type Q, Case 2, Attack (Figure F-7).

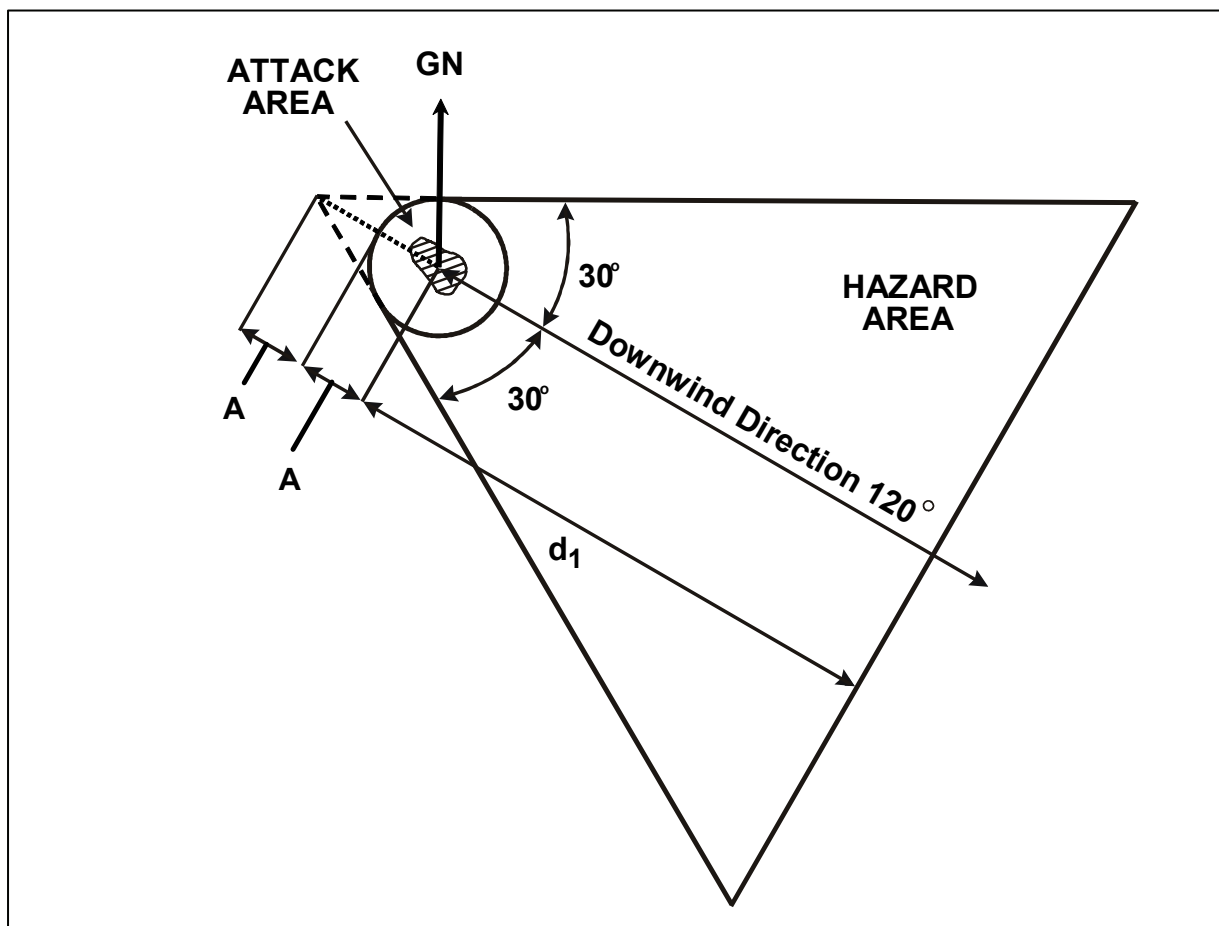

Figure F-7. Type Q, Case 2, Attack

NOTE: A = radius of attack area, H_1 = radius of hazard area, d_1 = downwind travel distance in the CDR time period, t_1 = time remaining from attack in the CDR time period, u_1 = wind speed (10 kph), $H_1 = A + d_1$, $d_1 = u_1 \times t_1$.

- (a) Step 1. Obtain the location of the attack from the relevant NBC BIO message(s) (set FOXTROT) and plot it on the map (see Figure F-7).
- (b) Step 2. From the center of the attack location, draw a GN line.
- (c) Step 3. Draw a circle with the attack area radius around the center of the attack location. The area within this circle represents the attack area.
- (d) Step 4. Using the valid NBC CDM, identify the downwind direction and the downwind speed.
- (e) Step 5. From the center of the attack area, draw a line showing the downwind direction.
- (f) Step 6. Determine the downwind travel distance (d_1) (see paragraph 7d(3)). If d_1 is less than the attack area radius, set it equal to the attack area radius.

(g) Step 7. Plot the downwind travel distance from the center of the attack area on the downwind direction line.

(h) Step 8. From the downwind travel distance, draw a line perpendicular to the downwind direction line. Extend the line to either side of the downwind direction line.

(i) Step 9. Extend the downwind direction line, twice the attack area radius, upwind from the center of the attack area. This is equal to twice the radius of the attack area.

(j) Step 10. From the upwind end of this line, draw two lines that are tangents to the attack area circle, and extend them until they intersect with the perpendicular to the downwind direction line. These lines will form a 30° angle on either side of the downwind direction line.

(k) Step 11. The hazard area is bound by—

- The upwind edge of the attack area circle.
- The two 30° tangents.
- The line perpendicular to the downwind direction line.

(l) Step 12. Prepare and transmit an NBC3 BIO report to units and installations in the predicted hazard area according to the SOP.

(5) Type R, Case 1, Attack (Figure F-8).

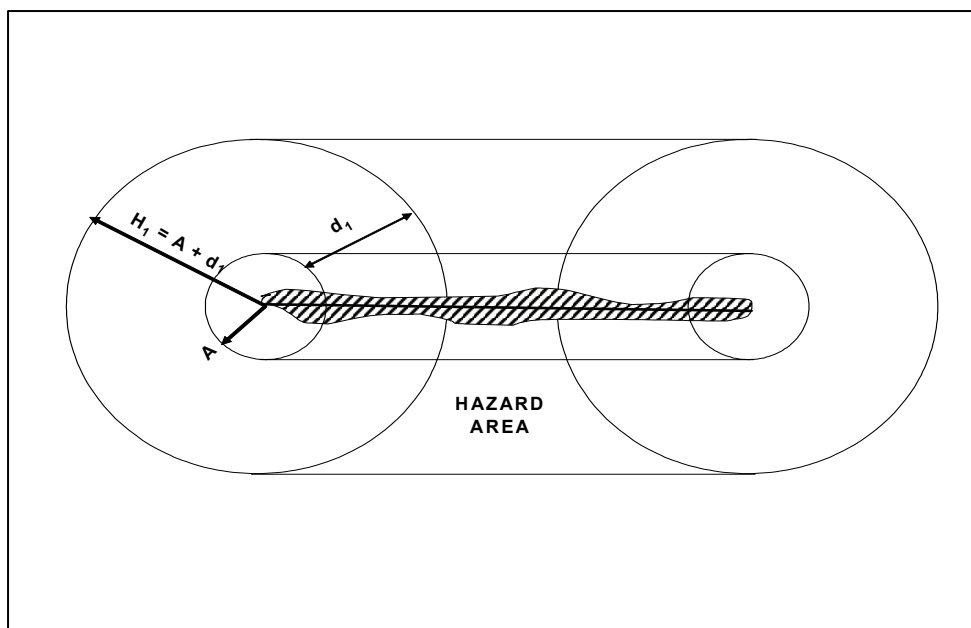

Figure F-8. Type R, Case 1, Attack

NOTE: A = radius of attack area, H_1 = radius of hazard area, d_1 = downwind travel distance in the CDR time period, t_1 = time remaining from attack in the CDR time period, u_1 = wind speed (10 kph), $H_1 = A + d_1$, $d_1 = u_1 \times t_1$.

(a) Step 1. Obtain the locations of the attack end points from the relevant NBC BIO message (set FOXTROT), and plot them on the map. Connect the end points to form the attack line.

(b) Step 2. Draw a circle with the attack area radius around each end point.

(c) Step 3. Connect these circles on both sides by drawing tangents to the circles parallel to the attack line to designate the attack area.

(d) Step 4. Draw a circle with a radius equal to the distance d_1 (10 kph times the travel duration) plus the radius of the attack area.

(e) Step 5. Connect these circles on both sides by drawing tangents to the circles parallel to the attack line to designate the hazard area.

(f) Step 6. Prepare and transmit an NBC3 BIO report to units and installations in the predicted hazard area according to the SOP.

(6) Type R, Case 2, Attack (Figure F-9).

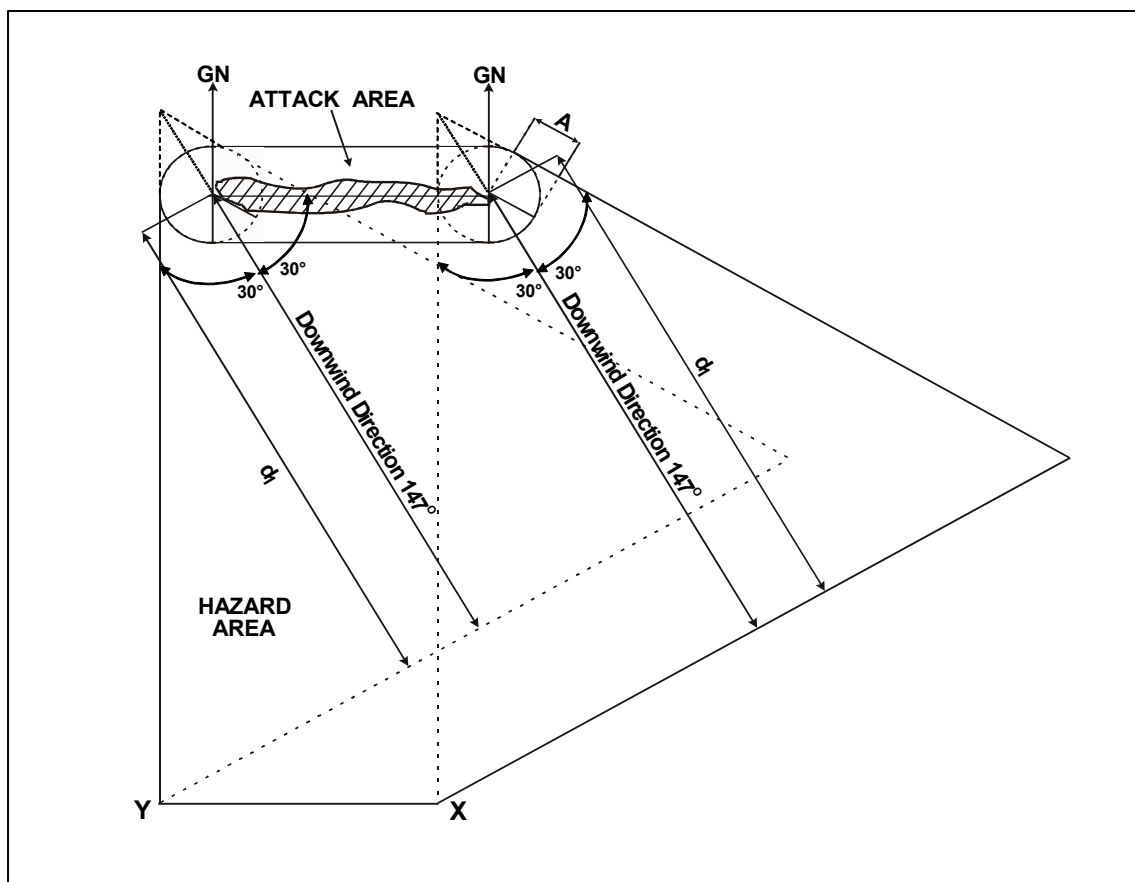

Figure F-9. Type R, Case 2, Attack

NOTE: A = radius of attack area, d_1 = downwind travel distance in the CDR time period, t_1 = time remaining from attack in the CDR time period, u_1 = wind speed, $d_1 = u_1 \times t_1$.

- (a) Step 1. Obtain the locations of the attack end points from the relevant NBC BIO message(s) (set FOXTROT), and plot them on the map. Connect the end points to form the attack line.
 - (b) Step 2. Draw a circle with the attack area radius around each point.
 - (c) Step 3. Connect these circles on both sides by drawing tangents to the circles parallel to the attack line to designate the attack area.
 - (d) Step 4. Draw a GN line from the center of each circle.
 - (e) Step 5. Using the valid NBC CDM, identify the downwind direction and the downwind speed.
 - (f) Step 6. From the center of each attack area circle, draw a line showing the downwind direction.
 - (g) Step 7. Determine the downwind travel distance (d_1).
 - (h) Step 8. Plot the downwind travel distance from the center of each attack area circle on the downwind direction lines.
 - (i) Step 9. From the downwind travel distance, draw a line perpendicular to each of the downwind direction lines. Extend the lines to either side of the downwind direction lines.
 - (j) Step 10. Extend the downwind direction lines, twice the attack area radius, upwind from the center of each attack area circle. This is equal to twice the radius of the attack area.
 - (k) Step 11. From the upwind end of each line, draw two lines, which are tangents to the attack area circle, and extend them until they intersect with the perpendiculars to the downwind direction lines. These lines will form a 30° angle on either side of the downwind direction lines.
 - (l) Step 12. Draw a line connecting the downwind corners of the two hazard areas (Points X and Y in Figure F-9, page F-21).
 - (m) Step 13. Prepare and transmit an NBC3 BIO report to units and installations in the predicted hazard area according to the SOP.
- (7) Type S, Case 1 and 2, Attacks (Figure F-10).

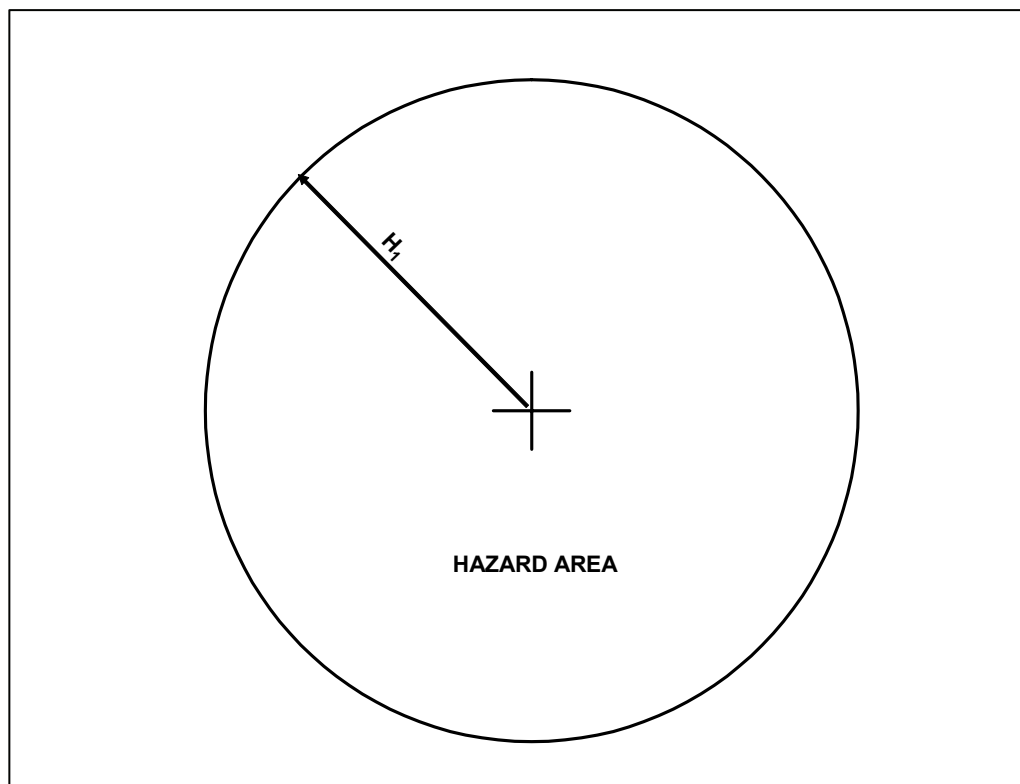

Figure F-10. Type S, Cases 1 and 2, Attacks

NOTE: H_1 = radius of hazard area.

(a) Step 1. Obtain the location of the attack from the relevant NBC BIO message(s) (set FOXTROT or QUEBEC), and plot it on the map.

(b) Step 2. Draw a circle with the attack area radius around the center of the detection location. The area within this circle represents the attack area and the hazard area.

(c) Step 3. Prepare and transmit an NBC3 BIO report to units and installations in the predicted hazard area according to the SOP.

g. Adjusted Hazard Prediction. When the wind direction does not change by 30° or more and does not drop below 10 kph, the total downwind distance can be used to calculate a single hazard area as shown in Figure F-11. The leading and trailing edges should also be computed, starting at the attack location. The leading and trailing edges should be displayed with lines drawn perpendicular to the downwind distance path, extending to the tangent lines. After significant weather changes, the NBC3 BIO report may no longer be accurate or apply. An adjusted NBC3 BIO report must be sent to the unit or installation in the new hazard area if possible. Also notify the units that may no longer be in the hazard area. Significant weather changes are:

- Representative downwind speed of 10 kph or more or if the wind speed increases from less than 10 kph to more than 10 kph or the reverse.
- Change in downwind direction by 30° or more.

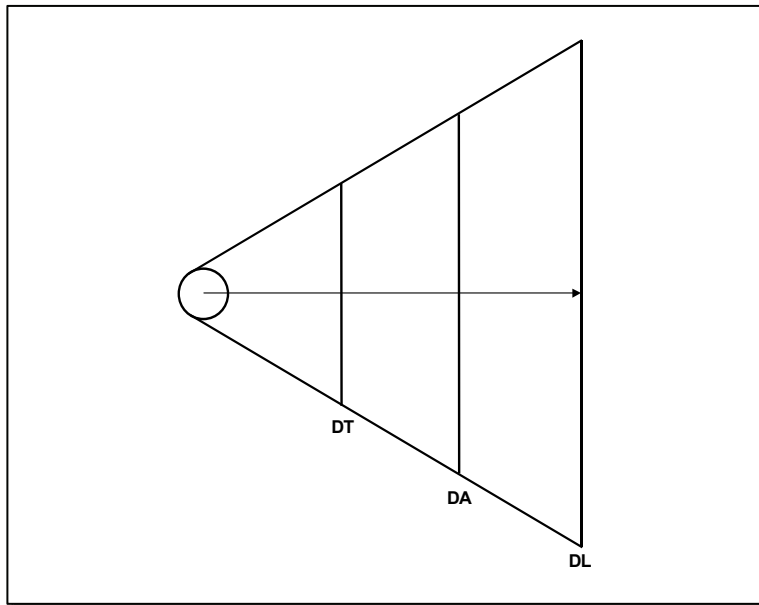

Figure F-11. Type Q, Case 2, Attack With Constant Wind Speed

(1) When the wind direction changes by 30° or more or the wind speed changes between Case 1 and Case 2, the recalculation procedures from Appendix E should be used for Type A chemical as shown in Figure F-12, page F-25.

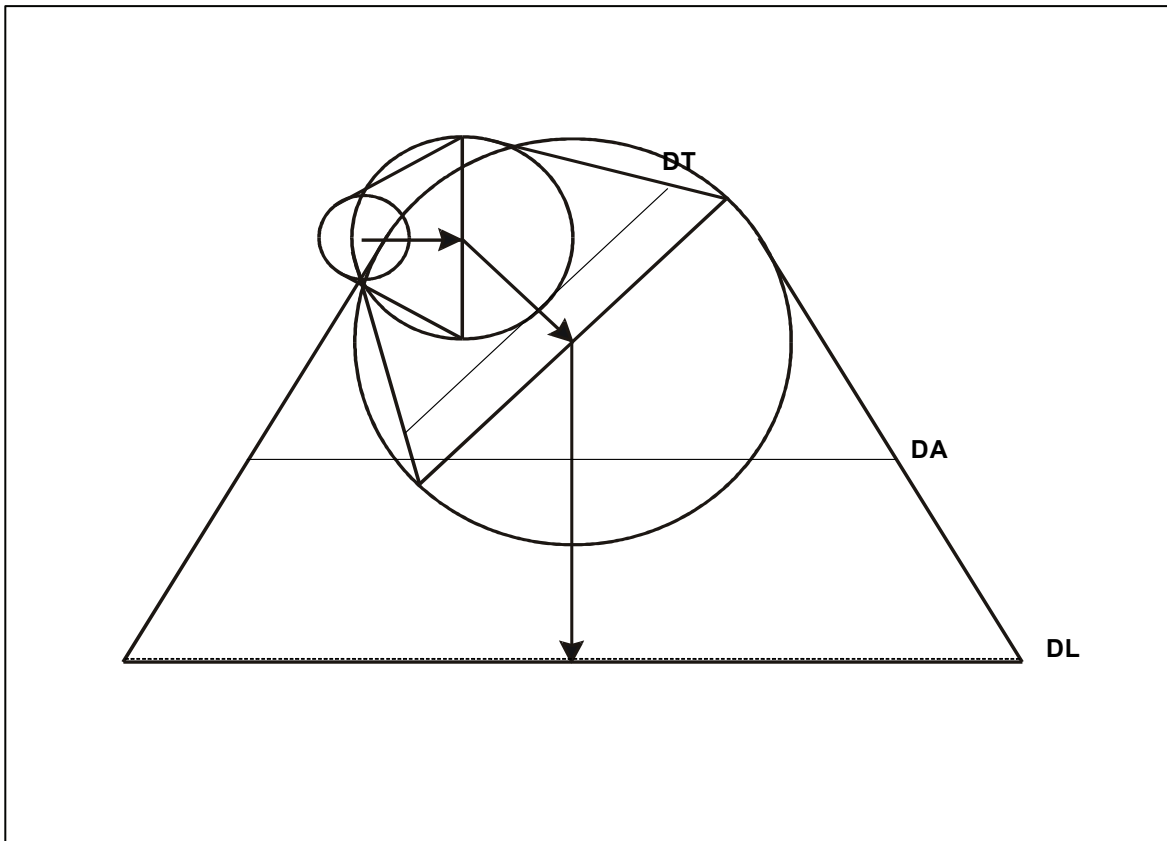

Figure F-12. Type Q, Case 2, Attack (1 Hour Into CDR, Changing Downwind Direction)

(a) Draw the attack area circle and the initial hazard area for the NBC CDR time period containing the attack. For a Type S attack, draw the attack area radius circle centered on the observation location and wait for more information.

(b) The hazard area at the end of that time period is drawn as a circle centered at the downwind edge (d_1), having a radius equal to the distance along the perpendicular line from the downwind direction line to one of the tangents.

(c) If the next time period is Case 1 extend this circle by the distance d_2 .

(d) If the next time period is Case 2, draw a new downwind direction line for the new time period of distance d_2 from the end of the d_1 line. Repeat the triangle procedure with the circle just drawn being the new attack area.

(e) Draw the circle containing the hazard area at the end of the second time period as described for the end of the first time period.

(f) Construct the hazard area for the third time period as described for the second time period. For Case 2, use the extended distance (DE) to include the leading edge.

(g) The hazard area for the current NBC CDR includes the combined areas drawn for the initial hazard area and hazard areas associated with the second and third time periods, if applicable.

(2) The NBC3 BIO report should be generated by corresponding to the current NBC CDR time-periods. The hazard area defined in set PAPAX should only include those

points computed for the current NBC CDR, which should be extended to 6 hours from the time of the attack. In this case, the hazard area for no more than three time periods will appear in PAPAX.

(3) The leading and trailing edges are computed along the downwind distance path, starting at the attack location. The leading and trailing edges should be displayed with lines drawn perpendicular to the downwind distance path, extending to the tangent lines for the time period containing each distance.

(4) For Type S attacks, notice should be taken of the location of enemy positions further upwind of the hazard area, calculated in accordance with paragraph 7c(2)(d). The area between the enemy positions and the template should be considered as being potentially biologically contaminated, with appropriate warnings issued and protective measures taken. If a new detection is made outside the hazard area, the procedures in 7c(2)(d) should be repeated for the new location.

h. Hazards Spanning Multiple CDM Messages.

(1) Before proceeding to the next CDR, the downwind hazard area should be recalculated. The third time period for the recalculation is not to be extended, to include the leading edge, e.g., distance d_3 should be used in place of distance DE; however, the leading and trailing edge distances still need to be computed and plotted as points. Distance (DA) is also not to be extended to result in 6 hours total time. Rather, d_3 will end at the end of the current CDR (e.g., $2u_3$). If the attack occurs in the second or third CDR time period, only one or two distances will result as described in paragraph 7d(3). If actual measured MET conditions have been recorded during a current NBC CDR, a better estimate of the current hazard area will be obtained.

(2) An attack circle for the end of the current NBC CDR is drawn centered at the current downwind location and then extended to the tangent lines. This attack circle defines the extent of the cloud at the end of the current NBC CDR. If this circle does not include the leading and trailing edge distances, the circle radius should be enlarged around the current downwind location until both points are included.

(3) The hazard area for the next 6-hour time period should be computed when the next NBC CDR is received. If the next NBC CDR has not been received, the last time period for the current NBC CDR should be used for lines WHISKEYM, XRAYM, and YANKEEM. When the next NBC CDR is received, the hazard prediction should be recalculated. The hazard area should then be reported in line PAPAX of a new NBC3 BIO report.

(4) Hazard areas should continue to be computed until no further contamination can be confirmed or until the hazard duration that follows has been reached. Attention should still be paid to the previously calculated areas, which may be contaminated until the end of agent effectiveness.

i. Termination of Biological Hazard Assessment. For biological attack Types P, Q, and R where the NBC3 BIO report was generated from one or more NBC1 BIO reports with the biological agent UNK, the NBC3 BIO report computations may be terminated if a chemical agent is confirmed. Otherwise, biological hazard assessment should continue until further information is available.

j. Hazard Duration. Upon confirmation of a specific biological agent or toxin, the expected duration of viability of the agent should be recorded in the second field of set PAPAA. The attack area radius computed for the current NBC CDR should be entered into the first field of set PAPAA.. Agents may continue to be a hazard on the ground in the contaminated area from days to, potentially, years.

8. NBC4 BIO Report

The NBC4 BIO report (see Figure F-13) is the recorded result of an initial detection, reconnaissance, survey, or monitoring action at a location being checked for the presence of biological agents. Each line QUEBEC, ROMEO, SIERRA, TANGO, WHISKEY, YANKEE, and ZULU segment in every NBC4 BIO report is a record of one contamination sample point location, environment, time of reading, type and level of contamination, method of sampling, and local MET conditions. The NBC4 BIO report will often be far downwind of the attack area location as defined in the corresponding NBC2 and NBC3 BIO reports, since biological agents will most likely be detected as airborne contamination. An NBC4 BIO report can be assumed to be associated with the same attack if —

- It can be placed in the hazard area for an NBC3 BIO report between the expected earliest and latest times of arrival.
- It is within 10 km and 2 hours of another NBC4 BIO report, which has already been assigned to an attack.

| NBC4 BIO Report | | | |
|---|---|------|----------------------------|
| Line Item | Description | Cond | Example |
| ALFA | Strike serial number | O | ALFA/US/A234/001/C// |
| INDIA | Release information on CB agent attacks or ROTA events | O | INDIA/AIR/BIO/BG// |
| QUEBEC* | Location of reading/sample/detection and type of sample/detection | M | QUEBEC/32VNJ481203/-/DET// |
| ROMEO* | Level of contamination, dose rate trend and decay rate trend | O | ROMEO/20PPM// |
| SIERRA* | DTG of reading or initial detection of contamination | M | SIERRA/202300ZSEP1997// |
| TANGO* | Terrain/topography and vegetation description | M | TANGO/FLAT/URBAN// |
| WHISKEY | Sensor information | O | WHISKEY/POS/POS/NO/MED// |
| YANKEE* | Downwind direction and downwind speed | M | YANKEE/270DGT/015KPH// |
| ZULU* | Actual weather conditions | O | ZULU/4/10C/7/5/1// |
| GENTEXT | General text | O | |
| *Lines QUEBEC, ROMEO, SIERRA, and TANGO are a segment. With the exclusion of set ROMEO, this segment is mandatory. Sets/segments are repeatable up to 20 times in order to describe multiple detection, monitoring, or survey points. | | | |

Figure F-13. Sample NBC4 BIO Report

9. NBC5 BIO Report

The NBC5 BIO report (Figure F-14) is prepared from the contamination plot. This report is last in order because it consists of a series of grid coordinates. Often, this message must be sent on the radio nets. This requires lengthy transmission. If an overlay is not sent, the recipient is required to plot each coordinate and redraw the plot. For NBC5 BIO reports, lines INDIA (release information), OSCAR (reference time), and XRAYA (actual contour information) are mandatory.

| NBC5 BIO Report | | | |
|---|--|------|---|
| Line Item | Description | Cond | Example |
| ALFA | Strike serial number | O | ALFA/US/A234/001/C// |
| DELTA | DTG of attack or detonation and attack end | O | DELTA/201405ZSEP1997// |
| INDIA | Release information on CB agent attacks or ROTA events | M | INDIA/AIR/BIO/BG// |
| OSCAR | Reference DTG for estimated contour lines | M | OSCAR/201505ZSEP1997// |
| XRAYA* | Actual contour information | M | XRAYA/LCT50/32VNJ575203/ 32VNJ572211/32VNJ560219/ 32VNJ534218/32VNJ575203// |
| XRAYB* | Predicted contour information | O | |
| YANKEE | Downwind direction and downwind speed | O | YANKEE/270DGT/015KPH// |
| ZULU | Actual weather conditions | O | ZULU/4/10C/7/5/1// |
| GENTEXT | General text | O | |
| *Sets are repeatable up to 50 times to represent multiple contours. | | | |

Figure F-14. Sample NBC5 BIO Report

10. NBC6 BIO Report

This optional NBC BIO report is a narrative description of biological attacks that have occurred in the reporting unit AO. The NBC6 BIO report contains as much information as is known about the attacks. It is submitted only when requested.

Appendix G

NUCLEAR-CONTAMINATION AVOIDANCE TACTICS, TECHNIQUES, AND PROCEDURES

1. Background

Under the threat of or in actual nuclear warfare, units continually evaluate the impact that enemy use of nuclear-weapons could have on the conduct of operations. They must be prepared for a contingency action to reduce the disruption caused by a nuclear attack (e.g., establishing a nuclear OEG).

a. Casualty-producing levels of fallout can extend to greater distances and cover greater areas than most other nuclear weapon effects. Such fallout levels can, therefore, influence actions on the battlefield for a considerable time. Knowledge and understanding of the nuclear contamination aspects discussed in this appendix help the commander determine the advantages and disadvantages of each COA open to him in the execution of assigned missions.

b. Fallout areas can be the largest contaminated area produced on the battlefield. There are two important aspects of fallout prediction—winds aloft and surface winds determine where fallout will occur. Therefore, the actual location of the fallout can differ greatly from those that might be expected from the direction of the surface winds.

c. Fallout particles are often visible during daylight hours. The arrival and settling of dust-like particles after a nuclear burst should be assumed to indicate the onset of fallout unless monitoring shows no radiation in the area. Any precipitation following a nuclear attack must be regarded as rainout from the nuclear cloud.

d. The neutron-induced area is small compared to the fallout area produced by the same yield nuclear weapon. It is often contained within the area of greatest destruction and collateral obstacles (e.g., tree blow down, rubble, or fire). Frequently, there will be no need to enter the neutron-induced area. Units should move into neutron-induced areas only when necessary. If units are required to pass through GZ or the attack location or to occupy positions in the immediate vicinity of GZ, the induced radiation is operationally significant. Units will base their entry and stay times on the radiation level present in the induced area.

e. The dose rate at any location within a contaminated area does not remain constant. The dose rate decreases with time. Therefore, in time, a radiation hazard will be of no military significance. The rate at which this decay takes place also varies with time, generally becoming slower as time passes. The decay rate for contamination in an area depends on many factors. It generally cannot be determined until several series of dose rate readings are taken for specific locations within the contaminated area. Standard decay conditions are, therefore, assumed by all units until actual conditions are determined or until higher HQ directs otherwise.

2. Nuclear-Contamination Avoidance Procedures

Avoidance procedures are broken down into actions before the attack, during the attack, and after the attack. The lists given, while not all-encompassing, may assist in developing unit SOPs and directives.

a. Preattack.

(1) Evaluate and monitor enemy nuclear-weapon activities. Reassess threat and risk, including the following:

- Yield of nuclear weapons.
- Expected detonation height (high altitude, air, surface, or subsurface).
- Likely delivery systems and range.
- Nuclear weapons storage facility locations and activity or movement.
- Nuclear weapons deployed to the units.
- Doctrine for use.
- Past use of nuclear weapons and likelihood of use.
- Training and exercises in nuclear warfare.
- The administration of iodine tablets.
- MET and environmental analysis associated with potential delivery means and identified nuclear weapons.

- Expected damage at this location after an attack.

(2) Determine the following radiological detection capabilities:

- Types of radiation able to detect.
- Types of radiation unable to detect.
- Concept of operations for detectors, including joint service, HN, and coalition force assets.
- Normal background readings for radiological detectors.

(3) Determine how many and what types of radiation detection instruments and support equipment are available for use.

NOTES:

1. Consider the instruments available for use through or by joint service, coalition, and HN forces.

2. Consider detectors that are at the home station and those scheduled to arrive via the time-phased force deployment data.

(4) Determine the following number and type of activities that require radiological detection:

- Dosimeter use (individual use and in main shelter area).
- Detection (patient decontamination and mobile reconnaissance teams).

(5) Use the nomograms and calculations for determining probable hazard dimensions for nuclear attacks.

(6) Direct shelter management teams and CBRN reconnaissance teams to take background readings as follows:

- Shelter management teams take readings inside the main living/shelter areas of the facility, in and around the personnel decontamination station, and in the immediate area outside of the shelter.
- Reconnaissance teams take background readings at locations that may be used as reconnaissance points (normally not located near shelters) or future radiological shelters (unmanned at the present time).

(7) Develop a concept of operations for the use of radiological detection instruments. Use the following techniques as guidelines:

- Shelter teams will only take readings outside the shelter until the point is reached where a reading (however small) can be measured inside the main living/shelter area of the facility.

NOTE: Once this point has been reached, the protection factor (PF) or CF of the shelter can be determined by dividing the outside reading by the inside reading. For example, the PF/CF of a shelter would be 50 if the outside reading was 1 cGy/hr and the inside reading was 0.02 cGy/hr.

- CBRN reconnaissance teams will not be used to take survey readings outside unless the information is critical to the mission operations.

NOTE: In all cases (for individuals, CBRN reconnaissance teams, and shelter management team members), the goal will be to limit radiological exposure to the absolute minimum required to accomplish critical mission operations.

(8) Provide specific visual aids and current information to ensure that all personnel are familiar with the following:

- Individual protective actions.
- Radiation signs/symptoms.
- Iodine tablets.

b. During Attack.

- (1) Take action for personnel in an open area.
- Seek the best available protection (building, bunker).
 - Move to a ditch, depression, or structure that provides protection from the blast, fragments, and small arms fire (if a building or bunker is not available).
 - Drop to the ground, crawl to the closest available protection, and don IPE according to the unit SOP or OPOD if no warning is received and an attack begins.
 - Use any available material to provide overhead cover (rain gear, poncho, tarps, or plastic).

NOTE: Adjust to the local policies and procedures.

- (2) Perform buddy checks, ensuring that IPE is correctly worn.
- (3) Perform self-aid/buddy aid while maintaining a low profile.
- (4) Close doors and windows, and cover items with plastic if time allows.
- (5) Monitor and report the following attack indicators to the CBRN cell:
 - Detector response.
 - Casualty data.
 - Environmental data.
- (6) Monitor the CBRNWRS for reports of a CBRN attack.

c. Postattack.

(1) Predict the downwind hazard area of the nuclear detonations and fallout, and predict the radiation intensities.

(2) Ensure that personnel cover their exposed skin while outside.

(3) Ensure that personnel protect themselves from ingesting or inhaling the radioactive particles while outside.

(4) Ensure that the total accumulated gamma dose is kept under 125 cGy per person.

NOTE: The installation commander may adjust this limit, as necessary, to accomplish critical mission operations.

(5) Avoid sending people outside when fallout is accumulating or radiation intensity has not reached a safe level.

(6) Monitor the area for radioactive fallout, and forward information to the CBRN cell.

- Continuously monitor for gamma radiation when fallout is expected.
- Identify the exact time of the arrival and forward it to the CBRN cell.
- Monitor and record the intensity readings every 15 minutes until the radiation peaks.

radiation peaks.

- Monitor and record the intensity readings every hour after the radiation peaks.

NOTE: If an increase is noted, resume monitoring every 15 minutes until a new peak is identified.

(7) Verify or determine the PF or CF of the shelters by dividing the outside intensity reading by the inside intensity reading on the radiac equipment (e.g., 300 cGy/hr divided by 30 cGy/hr = PF or CF of 10).

(8) Activate the decontamination teams, and proceed with the decontamination as directed.

NOTE: Ensure that the decontamination teams are dispatched with dosimeters and that their total radiation doses are tracked and kept to a minimum for each task.

(9) Directly decontaminate the area by using the following methods:

- Covering. Eight centimeters (3 inches) of earth will decrease radiation dose rates by one-half because of the shielding provided by the soil.
- Brushing or Vacuuming. This is effective on personnel and paved or finished surfaces. Use brooms, brushes, and vacuums inside shelters and on personnel. Street sweepers are ideal for roadways and flight lines.
- Scraping. Remove firm soil and snow by scraping. Move contaminated waste as far away as possible.
- Washing. Hot water and detergent are effective on wood, roofing material, masonry products, steel surfaces, asphalt, and concrete. Use a fire hose or power-driven decontamination apparatus to loosen and flush away fallout particles. Scrubbing with brooms, followed by rinsing, produces excellent results on paved surfaces.

NOTES:

1. Radioactive contamination cannot be neutralized; it only can be removed, covered, or isolated.

2. Items exposed to the fallout do not become radioactive themselves. Remove the fallout, and check with radiacs to determine if an item is safe to use.

(10) Determine the radiation decay rate based on the amount of time since the radiation peak and the current gamma radiation intensity.

NOTE: This information is vital for planning military operations.

(11) Monitor the individual radiological records.

(12) Monitor the shelter radiological logs.

(13) Direct the resupply, restocking, or redistribution of the following:

- Munitions/ammunition.
- POL.
- First aid items.
- IPE.
- Iodine tablets.
- Food and water.
- Batteries.
- Contamination control and decontamination assets.

3. Nuclear Information Management

Managing nuclear-attack information is crucial for the success of a command. To be useful, nuclear information must be collected, reported, and evaluated. Once evaluated, it can be used as battlefield intelligence. Obtaining and converting nuclear information into usable nuclear intelligence does not just happen. The volume of information that needs to be collected and reported could easily disrupt communications and tactical operations if not

properly managed. This section describes what information is available and how that information is transmitted to the person or unit requiring it.

a. **Collection of Nuclear Information.** The first step in managing nuclear attack information is to determine what information is available and who is available to collect it. Two types of data must be collected. Observer data provides information that a nuclear attack has occurred. Monitoring, survey, and reconnaissance data provides information on where the hazard is located. Every unit is responsible for observing and recording nuclear attacks, but every unit does not automatically forward NBC1 NUC reports. Many units may observe a nuclear burst, but if every unit forwarded a report, communications would be overwhelmed. For this reason, only selected units with the equipment that can make accurate measurements will submit NBC1 NUC reports. These units are called *designated observers*. Additional units are selected during tactical operations based on their physical locations. Only selected units automatically submit NBC1 NUC reports to the CBRN cell.

b. **Monitoring, Survey, and Reconnaissance Data.**

(1) NBC1 NUC reports allow the CBRN cell to collect information on where designated observers have seen a nuclear attack. The CBRN cell then evaluates this information in the form of an NBC2 NUC report. From the NBC2 NUC report, a simplified or detailed hazard prediction can be made. This prediction (NBC3 NUC report) is only an estimation of the hazard area. Feedback is needed from the units to determine exactly where the contamination is located. This feedback comes from monitoring, survey, and reconnaissance (NBC4 NUC reports). Monitoring and reconnaissance operations give the initial CBRN hazard location to the CBRN cell. Initial monitoring and reconnaissance reports are generally forwarded through the intelligence channels to the CBRN cell. This information may also be sent to the CBRN cell by the use of the various DSTs as discussed in Chapter III.

(2) The CBRN cell then plots the information on the situation map. If more information is needed, the CBRN cell directs a unit (picked because of its location and capability) to collect and forward the necessary data. This information could be from additional monitoring reports or a survey of the area in question. Collecting nuclear information is a joint effort of the unit and the CBRN cell. The unit actually collects the information. The CBRN cell plans and directs the collection effort. More detailed information concerning the collection effort is addressed in *Multiservice Tactics, Techniques, and Procedures for Nuclear, Biological, and Chemical Reconnaissance*.

c. **Evaluation of Nuclear Information.** After the nuclear data has been collected, it is evaluated. It is then used as battlefield intelligence. The CBRN cell is the primary evaluation center. Units and intermediate HQ use this raw data to develop nuclear intelligence for their own use until detailed results are available from the CBRN cell.

d. **Transmission of Nuclear Information.** Procedures used to transmit nuclear information to and from the CBRN cell are an important part of IM. The method of transmitting information depends on the tactical situation and the mission of the unit. Refer to Chapter III for more detailed information.

e. **Designated Observer System.** Although all units have some information-gathering responsibilities, certain units, because of their capabilities and location, are chosen as designated observers for nuclear attacks. Designated observers must be accurate when providing data on a nuclear burst. Observers are selected to

provide total coverage over the entire AOI. This requires ground and aerial observers. The designated observer system provides the essential data to prepare hazard location predictions and nuclear damage assessments. It provides raw observer data, using a standard report format. The CBRN cell specifies the primary and alternate means of communication.

(1) Designated Ground-Based Observers.

(a) Ground units are selected for the designated observer system based on the following factors:

- Battlefield location.
- Communication nets available.
- Mission (current and future) interference due to enemy action.
- Training and experience.
- Anticipated reliability of data.
- Possession of organic angle measuring equipment.

(b) Field artillery and air defense artillery units are best-suited as designated observer units. These units have organic optical equipment ideal for sighting measurements. These items are listed below in order of preference (Figure G-1).

- M2 aiming circle (this equipment is preferred because it is set to GN and measures in mils).
- M65 or M43 battery command periscope.
- T16 or T2 theodolite.
- M2 pocket transit.



Figure G-1. Unit Organic Optical Equipment Ideal for Sighting Measurements

(c) Any other unit (e.g., a mortar platoon) having this or similar equipment may be designated as an observer. Radar should also be considered. Many

types of radar can define the nuclear cloud. Field artillery and air defense artillery radars are positioned in the division and corps areas.

(2) Designated Aerial Observers.

(a) Aircraft provide excellent observer coverage for nuclear attacks. The CBRN control center coordinates with the appropriate aviation officers to have several aircraft crews designated as observers. The aviation unit commander selects the crews. Designated aircrews are instructed to report the type of attack and when and where it occurred. If aviators measure the cloud parameters, they must also provide the location from which it was measured.

(b) Aviators have the advantage of height. They are able to see and report actual GZ locations. They also can see and estimate crater width. Such data is usually not obtainable from ground observer units.

f. Nondesignated Observers. All units are required to record (in the prescribed format) their observations concerning nuclear strikes. Nondesignated observer units that have not been specifically tasked will transmit their reports only upon request. However, these units must report a nuclear attack only to the next higher HQ according to the local SOP.

g. Determination That a Nuclear Attack has Occurred.

(1) The development of a nuclear cloud is divided into three stages—fireball, burst cloud, and stabilized cloud. The fireball stage exists from the instant of the explosion until the generally spherical cloud of explosion products ceases to radiate a brilliant light. During this stage, do not look at the fireball. The brilliant light can cause permanent damage to the eyes.

(2) As the brilliant light fades to a dull reddish glow, the fireball stage transforms into the nuclear-burst cloud stage. At this point the cloud can be safely observed. The cloud may be a spherical cloud (high airburst) or a mushroom type cloud, with or without a stem (low air or surface burst). Relatively low-yield nuclear surface bursts have clouds similar to a surface burst of a conventional explosive. Severe turbulence and rapid growth in cloud height and width are characteristics of this stage.

(3) When the cloud ceases to grow in height, the stabilized cloud stage begins. Height stabilization occurs from about 4 to 14 minutes after the explosion, depending on the yield. The nuclear burst angular cloud width (line LIMA, as explained in Chapter III for an NBC1 NUC report) and stabilized cloud top/bottom angle or height (line MIKE) are measured during this stage. Figure G-2 illustrates the growth of a nuclear cloud. After the height stabilization, the cloud continues to grow. This is due to wind, not nuclear energy. For this reason, cloud measurements are not taken after H+10 minutes. Measurements of the nuclear-burst cloud are taken at H+5 minutes (line LIMA) or at H+10 minutes (line MIKE).

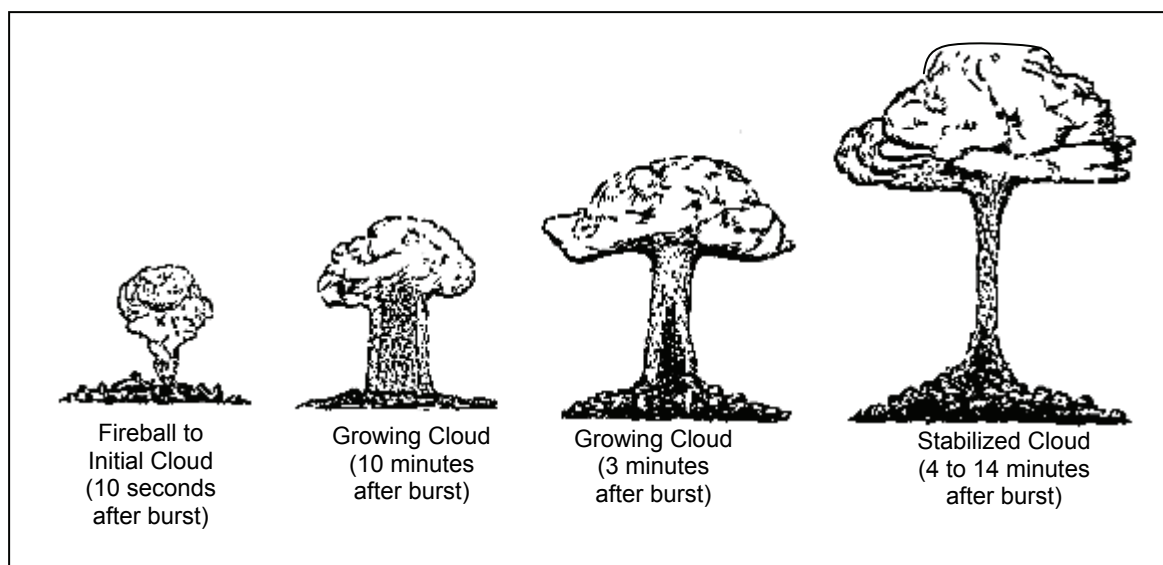

Figure G-2. Growth of a Nuclear Cloud

(4) Nuclear-cloud measurements (parameters) have been correlated with the yield of the weapon. This information can be extracted from nomograms and the ABC-M4A1 nuclear yield calculator. The use of the nomograms and the ABC-M4A1 is described in more detail later in this appendix.

(5) Unit SOPs detail the duties and circumstances concerning when and how measurements are taken. For accuracy, the following list of measurements (in order of reliability) is provided to aid in SOP development:

- (a) Nuclear-burst angular cloud width at H+5 minutes.
- (b) Stabilized cloud top or cloud bottom height at H+10 minutes.
- (c) Stabilized cloud top or cloud bottom angle at H+10 minutes.

4. NBC1 NUC Report

The NBC1 NUC Report can have the most far-reaching consequences of all NBC reports.

a. Introduction. The NBC1 NUC report (Figure G-3, page G-10) is the most widely used report. The observing unit uses this report to provide nuclear-attack data. All units must be familiar with the NBC1 NUC report format and its information. The unit must prepare this report quickly and accurately and send it to the next higher HQ. The battalion (squadron) and higher elements decide which NBC1 NUC reports to forward to the next higher HQ. If several reports are received on the same nuclear attack, then a consolidated NBC1 NUC report is forwarded instead of separate reports. This reduces the number of reports to a manageable level. The data in an NBC1 NUC report is used to locate GZ and to determine the yield of the nuclear burst.

| NBC1 NUC Report | | | |
|-----------------|--|-------|-----------------------------|
| Line Item | Description | Cond* | Example |
| BRAVO | Location of observer and direction of attack or event | M | BRAVO/32UNB062634/2500MLG// |
| DELTA | DTG of attack or detonation and attack end | M | DELTA/201405ZSEP2005// |
| FOXTROT | Location of attack or event | O | FOXTROT/32UNB058640/EE// |
| GOLF | Delivery and quantity information | M | GOLF/SUS/AIR/1/BOM/1// |
| HOTEL | Type of nuclear burst | M | HOTEL/SURF// |
| JULIET | Flash-to-bang time, in seconds | O | JULIET/57// |
| LIMA | Nuclear-burst angular cloud width at H+5 Minutes | O | LIMA/18DGT// |
| MIKE | Stabilized cloud measurement at H+10 minutes | O | MIKE/TOP/33DGT/9KM// |
| PAPAC | Radar-determined external contour of radioactive cloud | O | |
| PAPAD | Radar-determined downwind direction of radioactive cloud | O | |
| YANKEE | Downwind direction and downwind speed | O | YANKEE/270DGT/015KPH// |
| ZULU | Actual weather conditions | O | ZULU/4/10C/7/5/1// |
| GENTEXT | General text | O | |

*The Cond column shows that each line item is operationally determined (O) or mandatory (M).

Figure G-3. Sample NBC1 NUC Report

(1) Purpose. The purpose of the NBC1 NUC report is to provide nuclear-attack data.

(2) Message Precedence. The first time a nuclear weapon is used against US forces, the designated unit will send the NBC1 NUC report with a FLASH precedence. If a previous NBC1 NUC report has been forwarded, an IMMEDIATE precedence will be used.

b. Observer Position. Use universal transverse mercator (UTM) coordinates latitude (LAT) and longitude (LONG) or a place name. Enter this location on line BRAVO of the NBC1 NUC report. Line BRAVO is required on all reports from ground observers and should be encoded. This is the location of the angle-measuring equipment. It may or may not be the unit location. The direction of the attack from the observing unit is also reported on this line.

c. DTG of the Attack.

(1) After the second shock wave has passed, uncover the eyes and record the DTG to the nearest minute. This data is entered as line DELTA of the NBC1 NUC report.

(2) The DTG of the attack is always reported. The time zone used is specified by the field SOP, OPLAN, or OPORD or is contained in other instructions. The CBRN cell conducts time checks with the designated observers and converts all times to Zulu time.

d. Attack Location or GZ. If the designated observer has an actual location, this will be transmitted on line FOXTROT. If the attack location is estimated, a detailed description of how the estimation was made should be transmitted on line GENTEXT. A detailed description of how the CBRN cell calculates the GZ location is covered in paragraph 5 of this appendix.

e. Type of Burst. Observe the developing cloud to see if the burst was an airburst by noting the shape and color of the cloud or the absence of a stem. If the cloud is lighter in color than the stem or if the stem is ragged or broken (does not solidly connect with the cloud), record “air” in line HOTEL of the NBC1 NUC report. If the stem is thick and dark and it connects with the cloud, record “surface” in line HOTEL. If the cloud does not match any mental image for air or surface, record “unknown” in line HOTEL. “Unknown” may also be recorded when the attack occurs at night. A subsurface burst is recorded as “surface” only if the detonation ruptures the surface.

f. Flash-to-Bang Time. The designated observers will be assigned to report the flash-to-bang time. At the instant of the blue-white flash, cover your eyes, hit the ground, and start counting slowly (1,000 and 1, 1,000 and 2, 1,000 and 3, and so on) until the arrival of the shock wave or bang. Make a mental note of the count on which the shock wave arrives (for example, 1,000 and 4). If the observer has a watch and can note the exact time (in seconds), the watch can be used to record the flash-to-bang time. This data is entered as line JULIET on the NBC1 NUC report. Remain in place until the debris has stopped falling. It must be noted that there will be two shock waves—one blowing in one direction and the other blowing a few moments later in the opposite direction. If the bang is not heard in 5 minutes (a count of 1,000 and 300), continue with other measurements below.

g. Angular Cloud Width. The angular width of the cloud is measured 5 minutes after the detonation. The width of the nuclear cloud is the angular dimension, in mils or degrees, of the cloud diameter. The optical equipment operator takes this measurement at H+5 minutes. This measurement is made for nuclear clouds resulting from air and surface bursts. All units have some ability to take this measurement. The lensatic compass should be used if the listed equipment (Figure G-1, page G-7) is not available. Take the measurement of the angle by measuring the right and left side of the nuclear cloud. The numerical difference between these azimuths is the angular cloud width (Figure G-4, page G-12). This measurement is reported as line LIMA.

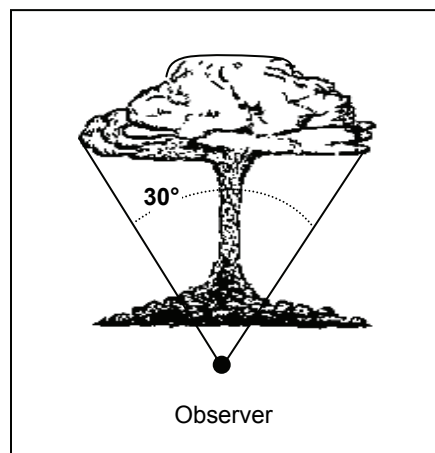

Figure G-4. Angular Cloud Width

h. **Cloud Top or Cloud Bottom Height.** The cloud top or bottom height can only be measured by aircraft or radar. Helicopters and most small, fixed-wing aircraft have a limited capability to determine the cloud height. The CBRN cell may have to coordinate with other service liaison officers to make arrangements to measure the cloud height. Again, CBRN cell coordination is required to establish this data source. Radar may also be helpful in resolving the actual number of bursts and GZs. This measurement is taken at H+10 and reported on line MIKE, in feet or km (Figure G-5).

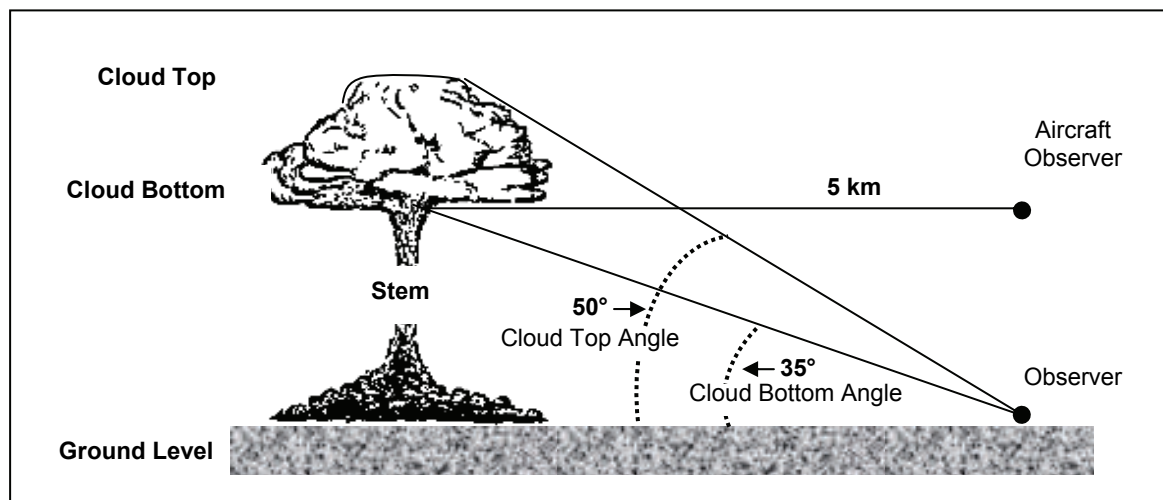

Figure G-5. Stabilized Cloud Top and Cloud Bottom Angle and Height Measurements

i. **Stabilized Cloud Top Angle.**

(1) The cloud top angle is the vertical measurement, in mils or degrees, from the GZ level (or from ground level if the GZ level is unknown), to the cloud top. This measurement is taken at H+10 minutes and reported in line MIKE (see Figure G-3, page G-10).

(2) These measurements are less reliable than measurements made at H+5 minutes. Most units in the field cannot take cloud bottom or top angle measurements. Therefore, they are not normally designated as observer units. These measurements cannot be made with a lensatic compass.

(3) If the angular width of the cloud cannot be measured, the designated observer unit measures the cloud bottom or cloud top angle. Nondesignated observer units with angle-measuring equipment can also take this measurement.

(4) The individuals specifically tasked to take the cloud measurements report this data and other data specified in the unit SOP to the unit CBRN defense team. If the unit is a designated observer, the defense team will format the data into an NBC1 NUC report. The report is transmitted per the SOP or by other written directions.

j. **Stabilized Cloud Bottom Angle.** The cloud bottom angle measurement is the vertical angle (in mils or degrees) measured from the GZ level (or ground level if the GZ level is unknown) to the point of intersection of the stabilized cloud and the stem. The cloud bottom or top angle measurements are not taken for airbursts. This measurement is taken at H+10 minutes and reported in line MIKE (Figure G-3, page G-10).

5. NBC2 NUC Report

a. **Introduction.** The NBC2 NUC report reflects the evaluated nuclear-burst data. It is based on one or more NBC1 NUC reports. NBC2 NUC reports are created for all air, surface, and unknown types of bursts. When surface or unknown bursts are reported, fallout predictions are made. Users of NBC2 NUC reports are not limited to the use of the line items shown in Figure G-6, page G-14. Any other line items may be added as appropriate.

(1) **Purpose.** The purpose of the NBC2 NUC report is to pass the evaluated data to higher, subordinate, and adjacent units.

(2) **Message Precedence.** All other messages (after the initial NBC1 NUC report has been sent) should be given a precedence, which reflects the operational value of the contents. Normally IMMEDIATE would be appropriate.

(3) The division (or designated higher HQ) CBRN cell, after determining the estimated yield, prepares the NBC2 NUC report, assigns it a strike serial number, and disseminates it to the appropriate units.

(4) Subsequent data may be received after the NBC2 NUC report is sent. If this data changes the yield or GZ location, send this data in an NBC2 NUC update report. Use the same strike serial number and DTG of attack.

b. **Strike Serial Number.**

(1) The CBRN cell serves as a focal point for all requests for information concerning nuclear strikes. It is responsible for assigning a strike serial number to each nuclear attack (friendly or enemy) that occurs within its assigned area.

(2) Once the unit receives the NBC2 NUC report, the unit CBRN defense team takes the report and a current EDM (see Appendix D for further information concerning EDMs) and prepares a simplified fallout.

| NBC2 NUC Report | | | |
|--|--|--------------|--------------------------|
| Line Item | Description | Cond* | Example |
| ALFA | Strike serial number | M | ALFA/US/A234/001/N/55// |
| DELTA | DTG of attack or detonation and attack end | M | DELTA/201405ZSEP2004// |
| FOXTROT | Location of attack or event | M | FOXTROT/32UNB058640/EE// |
| GOLF | Delivery and quantity information | M | GOLF/SUS/AIR/1/BOM/1// |
| HOTEL | Type of nuclear burst | M | HOTEL/SURF// |
| NOVEMBER | Estimated nuclear yield in KT or MT | M | NOVEMBER/15KT// |
| YANKEE | Downwind direction and downwind speed | O | YANKEE/270DGT/015KPH// |
| ZULU | Actual weather conditions | O | ZULU/4/10C/7/5/1// |
| GENTEXT | General text | O | |
| *The Cond column shows that each line item is operationally determined (O) or mandatory (M). | | | |

Figure G-6. NBC2 NUC Report

c. Location of GZ (Line FOXTROT).

(1) Any unit that is not part of the designated-observer system is obligated to take the cloud measurements and record all observed burst data. This data is recorded in the NBC1 NUC report in line BRAVO or FOXTROT and evaluated for the NBC2 NUC report. The unit does not report to higher HQ unless specifically requested. The CBRN cell will use this data to locate GZ and to estimate the yield.

(2) At the unit level, GZ is located in one of three ways—direct observation, intersection, or polar plot.

(a) **Direct Observation.** For small-yield weapons, direct observation may provide the actual GZ location. However, units do not reconnoiter for the GZ location. If GZ cannot be observed, measure the azimuth from the observer to the center of the stem (surface burst) or nuclear-burst cloud (air burst). Enter this data in line BRAVO of the NBC1 NUC report. If GZ can be observed, determine the UTM, LAT, and LONG coordinates or the place name. Enter this data as line FOXTROT (actual). Aerial observers may provide an estimated or actual GZ, depending on the altitude, orientation, terrain, and visibility conditions. The GZ must be observed to use line FOXTROT (actual).

(b) **Intersection (Estimation for Line FOXTROT).** The principal GZ location method is a plot of intersecting azimuths sent by the designated observers. The procedures are as follows:

- Locate and mark the position of each observer unit on the operations map overlay using the data on line BRAVO.

- Determine each azimuth to be plotted. This information is also on line BRAVO. Convert all magnetic azimuths to grid azimuths.
- Mark each azimuth from each observer position using a protractor.
- Extend each azimuth to the distance necessary for the observer's positions to intersect.
- Post any data that assists in the determination of the GZ location (e.g., radar, pilot reports).
- Evaluate the data. The result of the intersecting azimuths is an estimation of the location of GZ. The GZ location is reported on the NBC2 NUC report on line FOXTROT, qualified with the word estimated (unless FOXTROT [actual] information is used in the determination).
- Disregard the azimuths that do not intersect with the other azimuths.
- Take the center of the plot as the estimated GZ location whenever azimuths do not cross to form a clear GZ location.

(c) Polar Plot (Estimation for Line FOXTROT). Polar plot techniques are based on flash-to-bang time and the speed of sound (350 meters per second or 0.35 km per second). The procedures are as follows (see Figure G-7, page G-16):

- Make an approximation of the distance between GZ and the observer in km by multiplying the flash-to-bang time (data on line JULIET of the NBC1 NUC report) by 0.35 km per second.
- Plot the observer's location on the situation map. This is line BRAVO on the NBC1 NUC report.
- Mark the azimuth from the observer's position to the attack location using a protractor. Convert the magnetic azimuth to a grid azimuth.
- Draw this azimuth to the length previously calculated as the distance between GZ and the observer.
- Read the grid coordinates of the place where the azimuth line, in the previous step, ends. This is an approximate plot of the GZ location.

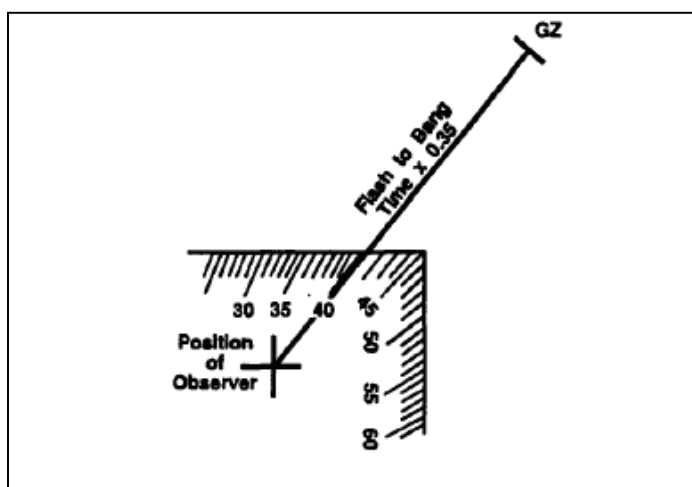

Figure G-7. Polar Plot Method

d. Methods of Determining the Yield (Line NOVEMBER). Before the yield can be estimated, the location of GZ, position of the observer, and DTG cloud measurements were taken must be known. The nuclear-burst parameters are presented in nomograms. Each nomogram is an independent means of estimating yield. The following are methods for determining yield, from the most accurate to the least accurate:

- (1) The distance in km between GZ and the observer, in conjunction with line LIMA or MIKE information, represents the best method of estimating the yield.
- (2) Use Figure G-8 to determine the yield, based on the nuclear-burst angular cloud width and the distance between GZ (or line JULIET, flash-to-bang time) and the observer. The data is reported in line LIMA.
 - (a) The right-hand scale is the nuclear-burst angular cloud width, in mils and degrees.
 - (b) The center scale is the distance in km between GZ and the observer.
 - (c) The left-hand scale is the yield, in KT.
 - (d) To use this nomogram, place a hairline from the point on the right-hand scale (representing the nuclear burst angular cloud width at H+5 minutes) through the point on the center scale (representing the distance between GZ and the observer) (or line item JULIET, flash-to-bang time). Read the yield where the hairline crosses the yield scale (left). You must be as exact as possible.
- (3) The cloud top or cloud bottom height, when stabilized, can be closely measured by aircraft or air defense artillery (ADA) radar. Measurements, in meters or feet above the earth's surface, must be made at H+10 minutes. The data is reported in line MIKE.
 - (a) Use Figure G-9, page G-18, to correlate these measurements with the yield. The distance between GZ and the observer is not required.
 - (b) The extreme left and right scales on the nomogram are yield, in KT and MT.

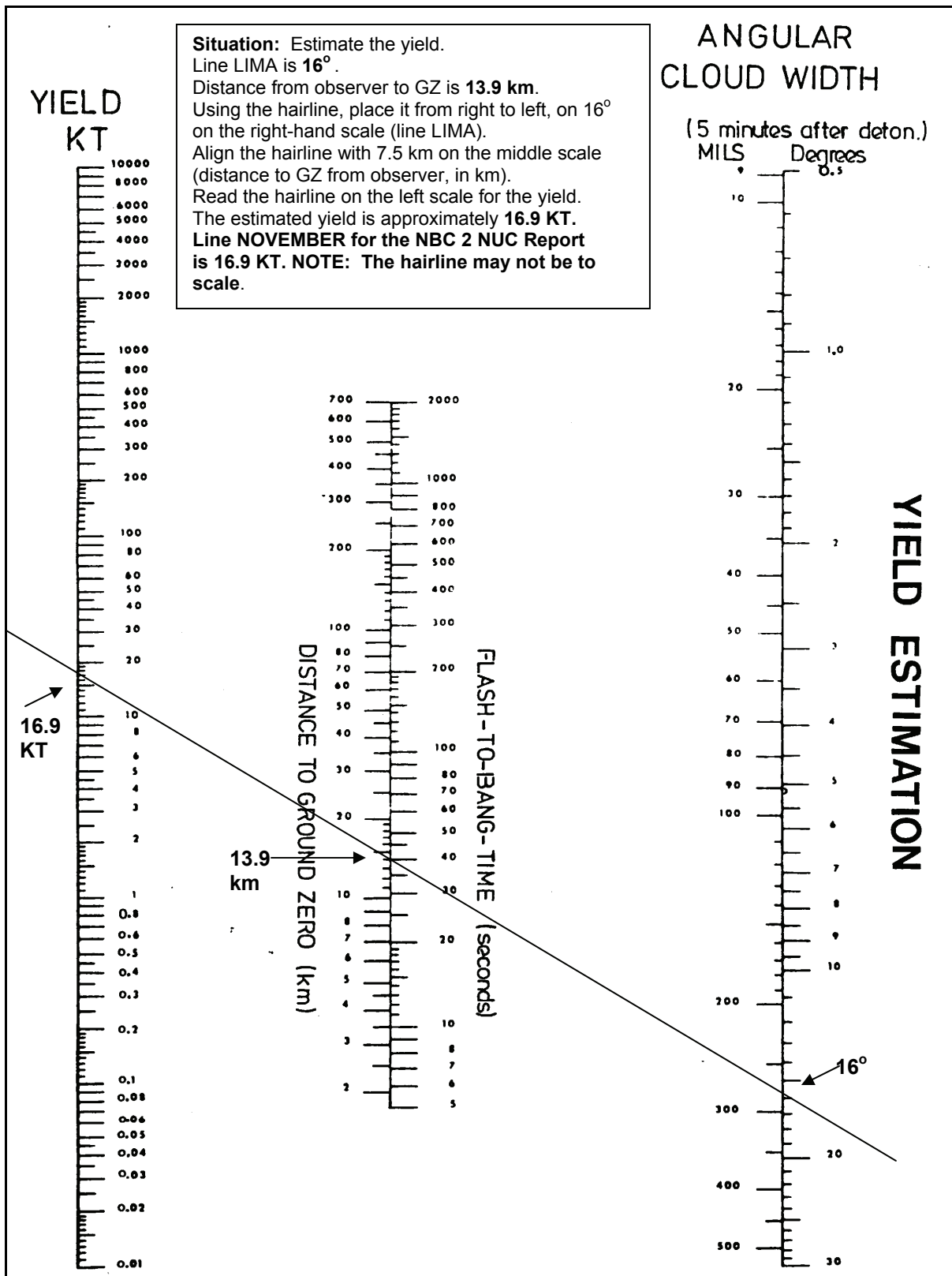

Figure G-8. Yield Estimation, Cloud Width and Flash-to-Bang Time/Distance to GZ (Example)

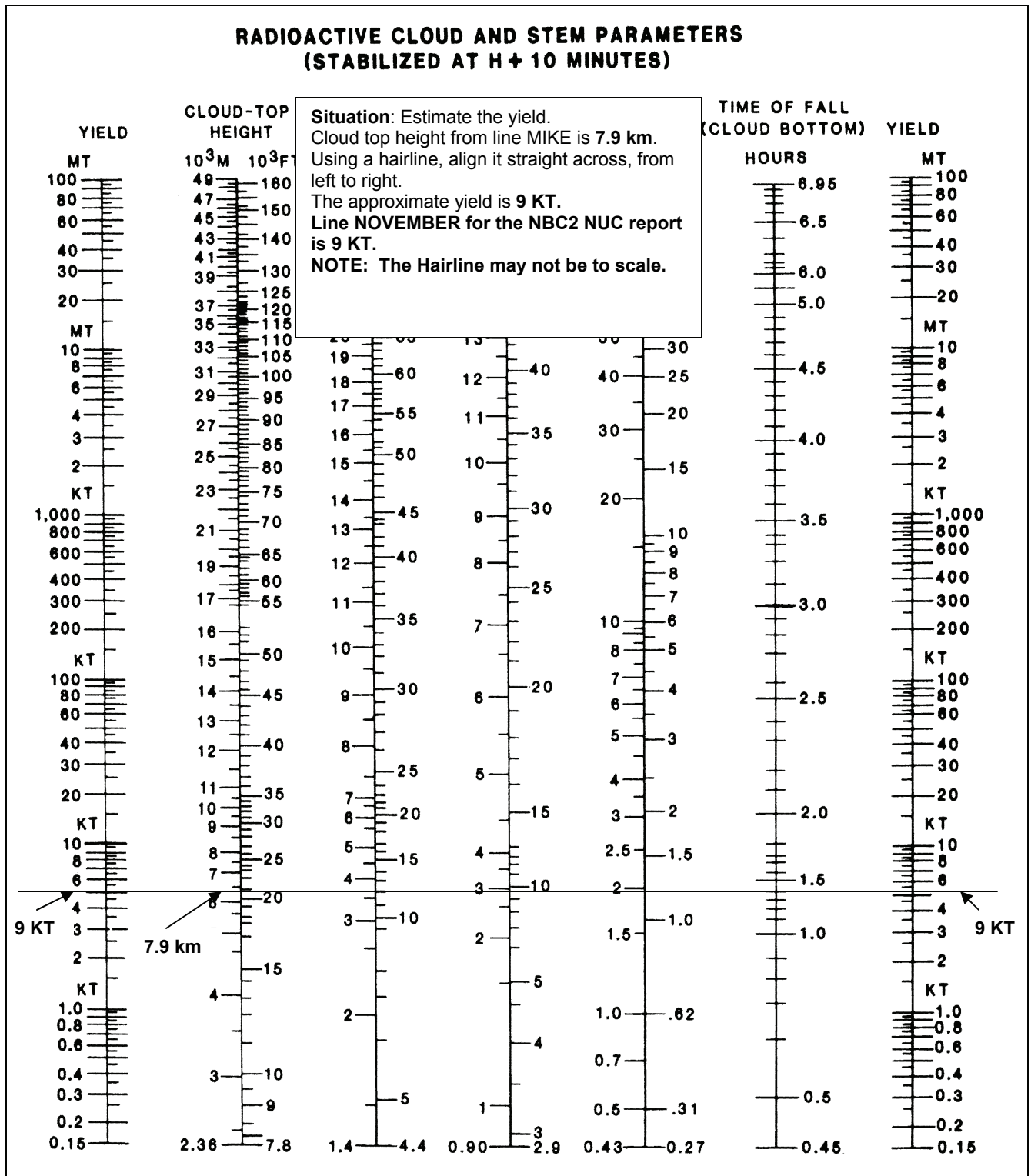

Figure G-9. Stabilized Cloud and Stem Parameters—Cloud Top/Bottom Height (Example)

(c) The scale second from the left is the cloud top height at H+10 minutes, in thousands (10^3) of meters or feet.

(d) The scale third from the left is the cloud bottom height at H+10 minutes, in thousands (10^3) of meters or feet.

(e) The other scales on the nomogram, (2/3 stem height, cloud radius, and time of fall) are not used in the yield estimation. These scales are used in the detailed fallout prediction.

(f) To use the nomogram, determine the stabilized cloud top or cloud bottom height from line MIKE of the NBC1 NUC report. Place a hairline directly over the reported data, and pin the hairline to the nomogram. Pivot the hairline until it crosses the outside yield scales at the same value (far left and far right). This value is the estimated yield.

(4) Given the distance between GZ and the observer and the stabilized cloud top angle or cloud bottom angle, use Figure G-10, page G-20, to determine the yield. The data is reported in line MIKE.

(a) The right-hand scale gives the distance in km from GZ to the observer and the flash-to-bang time, in seconds, counted by the observer.

(b) The center scale is the cloud top or cloud bottom angle, in mils or degrees.

(c) The left-hand scale is actually two scales. The left side of the scale lists the yields to be read when using the cloud bottom angle; the right side of the scale lists the yields to be read when using the cloud top angle.

(d) To use this nomogram, place a hairline through the point on the right-hand scale, representing the distance between GZ and the observer, and through the point on the center scale, representing the cloud top or cloud bottom angle. At the point of intersection of the hairline and the left-hand scale, read the yield. If the cloud top angle was used on the center scale, read the yield on the right side of the left-hand scale titled yield–cloud top (KT). If a cloud bottom angle is used, read the yield on the left side of the left-hand scale titled yield–cloud bottom (KT).

(5) The M4A1 calculator (Figure G-11, page G-21) is designed to provide a rapid yield estimation based on any parameter except the cloud top or cloud bottom height. The M4A1 consists of three plastic disks (front, back, and middle) connected by a rivet. The front and back disks are opaque white plastic in the center and transparent plastic on the outer edge. The middle disk is opaque white plastic.

(a) M4A1 Front:

- Stabilized cloud bottom or top angle scale (mils).
- Yield stabilized cloud bottom scale (KT).
- Yield stabilized cloud top scale (KT).
- Nomenclature.
- Instructions.
- Distance-to-GZ scale (KM).

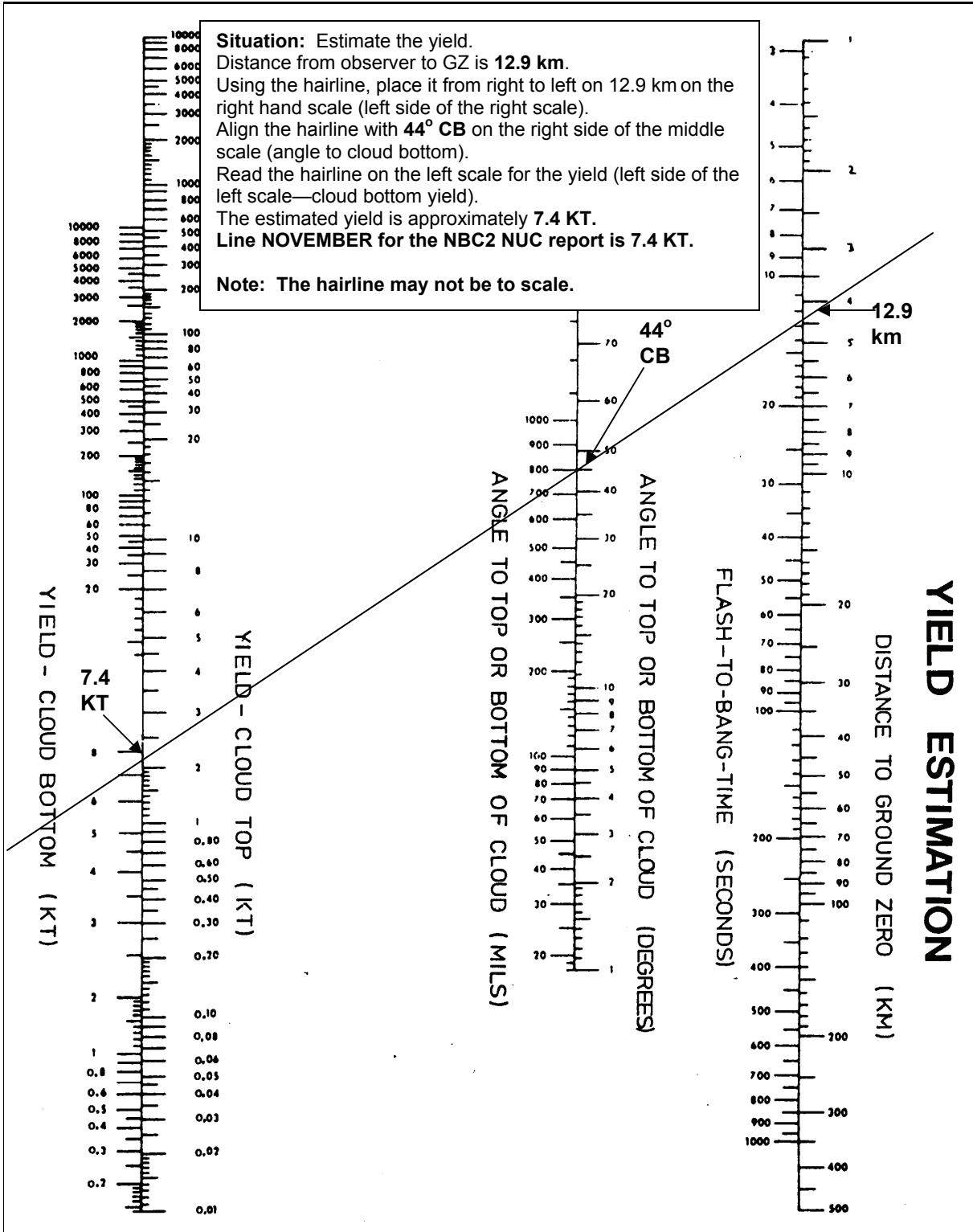

Figure G-10. Yield Estimation, Angle to Top/Bottom of Cloud and Flash-to-Bang Time/Distance to GZ (Example)

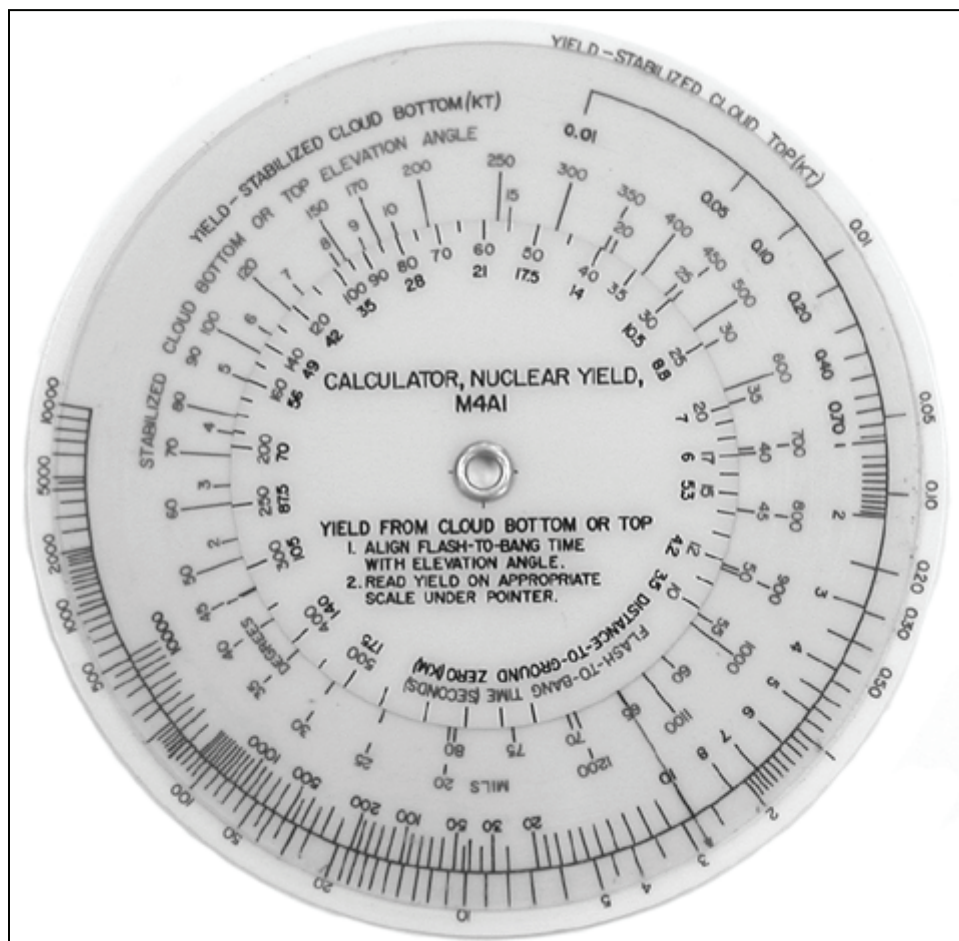

Figure G-11. M4A1 Nuclear Yield Calculator

- Flash-to-bang time scale (seconds).
- Indexing pointer.
- (b) M4A1 Back:
 - Observed cloud width scale at 5 minutes (H+5 or L).
 - Yield scale.
 - Distance-to-GZ scale (KM).
 - Flash-to-bang time scale (seconds).

- Indexing pointer.
- Instructions.

(c) The M4A1 calculator is a round nomogram with a fixed hairline.

Because of this, there are situations in which the yield pointer may go off scale on the high or low ends of the yield scale. (Example: the nuclear cloud is 20 mils wide and the flash-to-bang time was 10 seconds. This is a small cloud that is very close to the observer, indicating a small yield. The calculator shows a yield of 1,000 KT, but the actual yield is less than 0.02 KT).

(d) To use the M4A1, determine the yield utilizing the flash-to-bang time and the angle to the cloud top.

- Situation. An observer reports a flash-to-bang time of 100 seconds and the elevation of the cloud top at the stabilization time of 300 mils.
- Task. Using the calculator, determine the yield from the burst.
- Solution. Align 100 seconds on the flash-to-bang time scale, with 300 mils on the stabilized cloud bottom or top elevation angle scale (H+10/M information). Read the yield on the yield-stabilized cloud top scale that falls under the indexing pointer. The yield of the observed weapon is 20 KT.

(e) Yield from Flash-to-Bang Time and Cloud Width at 5 Mins (H+5/L).

NOTE: If line LIMA is reported in degrees, it must be converted to mils; mils equals degrees x 17.8.

- Situation. An observer reports that the flash-to-bang time from a burst was 100 seconds and the cloud width at 5 minutes was 180 mils.
- Task. Using the calculator, determine the yield.
- Solution. Align 100 seconds on the flash-to-bang time scale with 180 mils on the observed cloud width at 5 mins scale. Read the yield at the point where the indexing pointer aligns with the yield scale.
- The yield of the observed weapon is 50 KT.

(6) The flash-to-bang time is only used to estimate the yield as a last resort.

(7) Each of the yield estimation techniques was given in order of decreasing reliability, with the results providing approximate yields.

(8) When data from several observers, concerning a single attack, does not result in the same yield, add all yields together and divide by the number of observers to get the average estimated yield. This is the yield that is transmitted.

6. NBC3 NUC Calculation Procedures

NBC3 NUC calculation procedures ensure that standard methods are used when determining fallout.

a. Fallout Prediction.

- (1) In the preparation of a fallout prediction, the following must be available:
- MET data.

- GZ location.
- Estimated yield.

(2) The necessary MET data will be available in the format of an NBC BWM or an NBC EDM. Refer to Appendix D for further information concerning NBC BWMs and NBC EDMs.

(3) The method of fallout prediction consists of two procedures: the simplified procedure and the detailed procedure. Both are used to determine the extent of the warning area. Normally, the detailed procedure is used by agencies having a MET capability, and subordinate units use the simplified procedure. The decision on which procedure to use is left to the commanders concerned. These two procedures are described in detail later in this appendix.

(4) The prediction of the fallout hazard area using the detailed procedure is more accurate. Although neither procedure precisely defines the extent of the fallout, the predicted fallout area, calculated by either method, indicates the probable limits to which the fallout of military significance will extend.

(5) The boundaries of the predicted fallout area are not dose rate contour lines, nor do they imply that all points within the enclosed areas will sustain dangerous fallout.

NOTE: No fallout predictions are made for air bursts over land, and the procedures are not used for surface bursts over water.

b. Fallout Area Zones.

(1) The predicted fallout area consists of Zone I and Zone II.

(a) Zone I is an immediate operational concern. Within this zone, there will be areas where exposed, unprotected personnel may receive doses of 125 cGy or greater in relatively short periods of time (less than 4 hours after the actual arrival of fallout). Casualties and major disruptions to the unit operations may occur in some parts of this zone.

(b) Zone II is a secondary hazard. Within this zone, the total dose received by exposed, unprotected personnel is not expected to reach 125 cGy within a period of 4 hours after the actual arrival of fallout. Within this zone, personnel may receive a total dose of 75 cGy or greater within the first 24 hours after the arrival of fallout. Personnel with no previous radiation exposure may be permitted to continue critical missions for as long as 4 hours after the actual arrival of fallout without incurring the 125 cGy emergency risk dose.

(2) Outside the two predicted zones, exposed, unprotected personnel may receive a total dose that does not reach 75 cGy in the first 24 hours after the actual arrival of fallout.

(3) The total dose for an infinite stay time should not reach 125 cGy. Refer to Appendix C for more details.

NOTE: The prediction of fallout is to be regarded as an estimate only. The necessary preparations should be made to avoid the hazard if tactically possible. Even within Zone I, units may not be affected by the fallout at all. However, the decision to act is up to the local commander and national directives or SOPs.

c. Significance of the Fallout Ashore Versus at Sea.

(1) The detailed procedure and the simplified procedure for fallout prediction are intended for use by all services. They are based on assumed land surface bursts. It is recognized that the fallout from a sea burst may be rather different, but very little direct information is available on the fallout from bursts on the surface of deep ocean water.

(2) It must be stressed that the sea acts like an absorbent of and shield against radioactive products, but they remain a hazard on land until they have decayed.

(3) Another important difference is that recipients of warnings ashore do not have the mobility of ships at sea. Therefore, ships will be particularly interested in the determination of the approximate area in which deposition of fallout at the surface is taking place at a given time after the burst.

(4) Ships with a MET capability may be able to obtain the required MET data for computation of NBC EDM using the standard pressure level winds. Basic wind data for this purpose are generally available from MET sources (airbases, MET ships, or mobile weather stations). Ships, which do not have a MET capability, will normally predict the fallout areas by using the simplified procedure.

(5) The fallout warning system (MERWARN) for merchant ships at sea is described later in this appendix.

d. Multiple-Burst Fallout.

(1) No additional prediction procedure is available in the case of multiple-burst fallout. The information obtained in areas where zones overlap is to be interpreted as follows:

(a) The hazard classification of an area where fallout prediction patterns overlap should be that of the higher classification involved. That is, an overlap area involving Zone I should be designated Zone I and an overlap area involving nothing more than Zone II should be designated Zone II (see Figure G-12).

(b) Examples:

- Zone I overlapping Zone I, designate Zone I.
- Zone I overlapping Zone II, designate Zone I.
- Zone II overlapping Zone II, designate Zone II.
- Zone II overlapping Zone I, designate Zone I.

e. Simplified Fallout Prediction.

(1) Purpose. The purpose of the simplified fallout prediction system is to provide small-unit commanders with an immediate estimate of the fallout hazard. The commander will use the simplified fallout prediction in the tactical decision-making process.

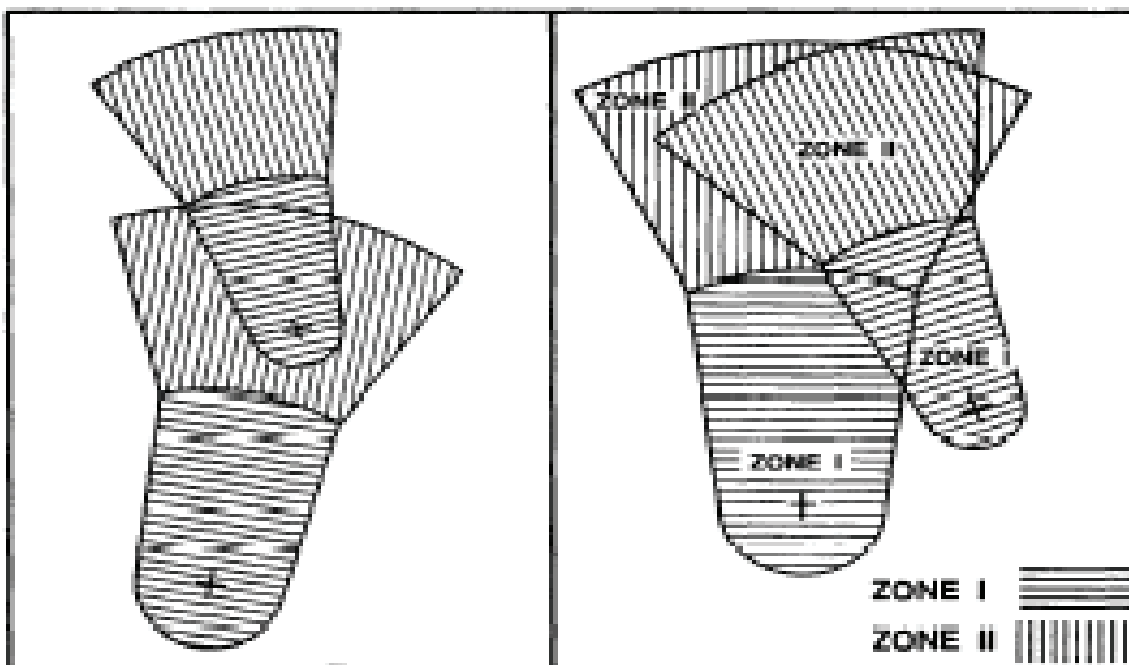

Figure G-12. Multiple-Burst Detailed Fallout Prediction (Example)

(2) Required Items. To construct a simplified fallout prediction, the unit requires the following items:

- (a) Current EDM.
- (b) NBC2 NUC report.
- (c) M5A2 simplified fallout predictor (see Figure G-13, page G-26, and Figure G-14, page G-27).
- (d) Downwind distance zone of immediate concern nomogram.

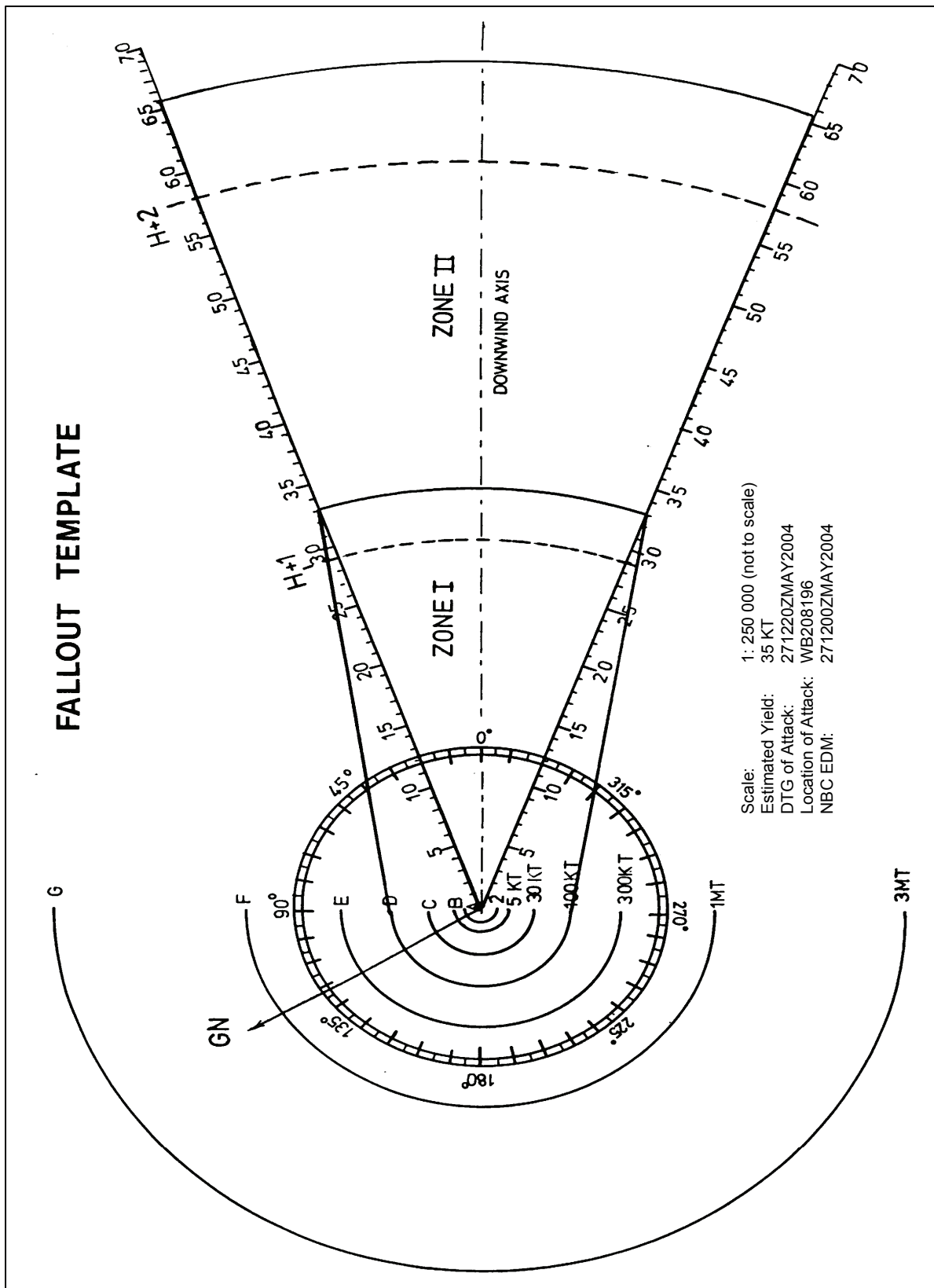

Figure G-13. Simplified Fallout Template With Fallout Prediction

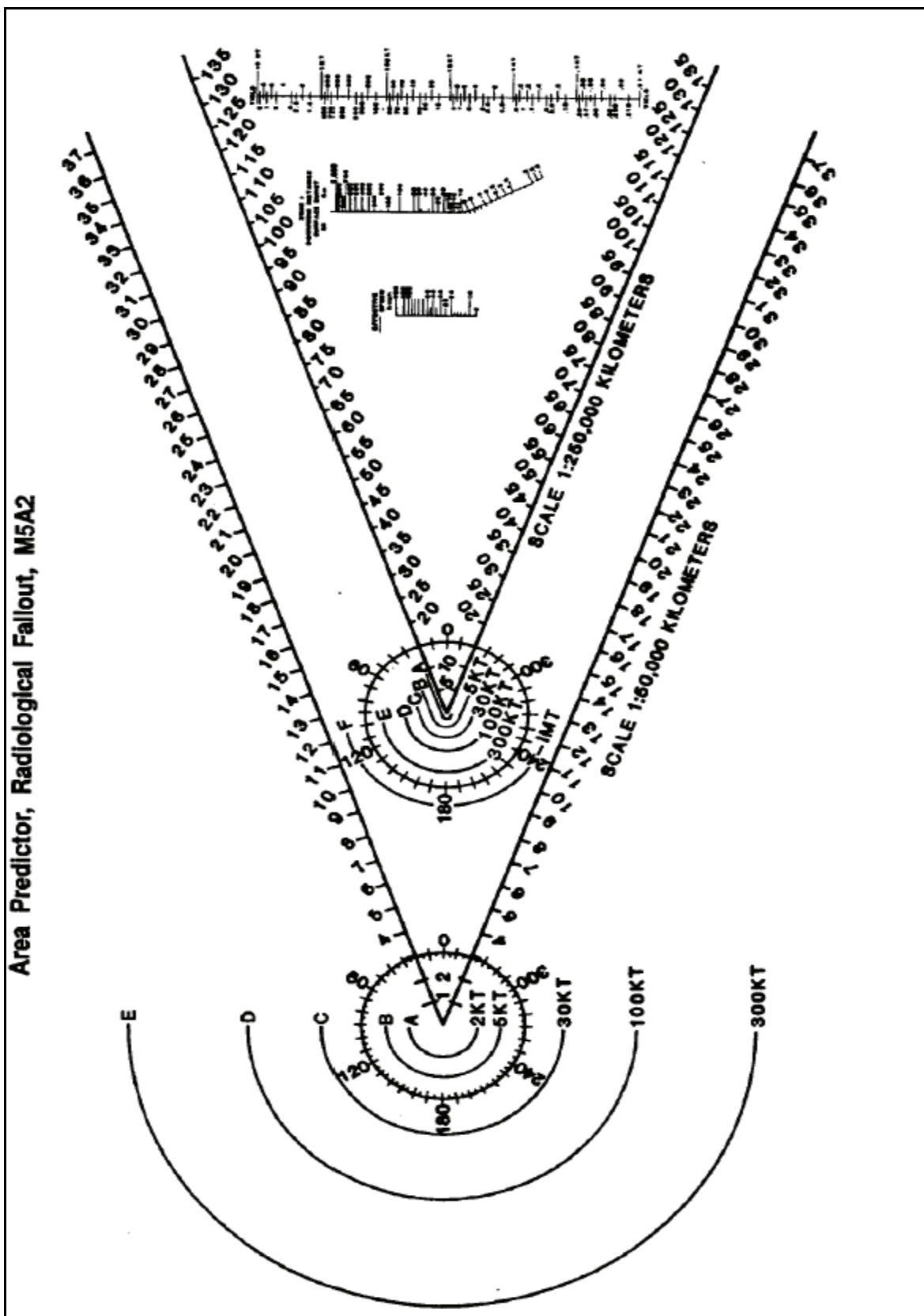

Figure G-14. Simplified Fallout Template, M5A2 (Example)

(3) EDM Yield Groups. There are seven standard yield groups for which the EDM (see Table G-1) provides plotting information. These yield groups are listed as lines ALPHAM through GOLFM on the EDM. The following information is provided by each yield group:

Table G-1. Preselected Yield Groups

| | | | | | |
|-----------------|-----------|-------------|-----------------|----------|------------------------|
| ALPHAM | is | ≤ | 2 KT | ≤ | |
| BRAVOM | is | > | 2 KT | ≤ | 5 KT |
| CHARLIEM | is | > | 5 KT | ≤ | 30 KT |
| DELTAM | is | > | 30 KT | ≤ | 100 KT |
| ECHOM | is | > | 100 KT | ≤ | 300 KT |
| FOXTROTM | is | > | 300 KT | ≤ | 1,000 KT (1 MT) |
| GOLFM | is | > | 1,000 KT | ≤ | 3,000 KT (3 MT) |

(a) The first three digits (ddd) contain the downwind direction for the particular yield group in degrees grid from GN.

(b) The next three digits (sss) contain the EWS, in kph.

(c) The last three digits (***) represent the expanded angle, in degrees, between the left and right radial lines. They are only reported when the angle from the wind vector plot exceeds 40°. (Last digit in ADP [NATO ADatP-3 Data Base] format—7 digit total vice 9 EDM line.)

NOTE: The first three digits could represent the downwind distance of Zone I measured in km if the wind speed is below 8 kph for the respective EDM line (see Figure G-15, page G-29).

| EFFECTIVE DOWNWIND MESSAGE WORKSHEET | | | | | | | | | | |
|--|------------|---------------------------|------------------------------|--------------------------|--------------------------------------|--|--|--|---|--------------------|
| For use of this form, see FM 3-11.3; the proponent agency is TRADOC | | | | | | | | | | |
| TIME OF WIND MEASUREMENT (DATE-TIME GROUP) <u> </u> <u> </u> <u> </u> <u> </u> <u> </u> <u> </u> | | | | | | | | | | |
| MESSAGE LINE | YIELD (KT) | CLOUD-TOP HEIGHT (METERS) | CLOUD-BOTTOM HEIGHT (METERS) | 2/3 STEM HEIGHT (METERS) | ① DISTANCE OF GZ/CB RADIAL LINE (KM) | ① $\frac{WIND\ SPEED-sss}{TIME\ OF\ FALL}$ ROUND OFF TO NEAREST KILOMETER PER HOUR | ② AZIMUTH OF GZ/CT RADIAL LINE (DEGREES) | ③ AZIMUTH OF GZ/2/3 STEM RADIAL LINE (DEGREES) | EFFECTIVE DOWNWIND DIRECTION-ddd SUM OF | WARNING AREA ANGLE |
| A | 2 | 4,900 | 2,600 | 1,700 | | X 1.136 = | | | ② + ③ = ② AND ③ = ddd° | |
| B | 5 | 7,100 | 4,400 | 2,800 | | X 0.758 = | | | = 2 = | |
| C | 30 | 11,600 | 7,700 | 5,100 | | X 0.455 = | | | = 2 = | |
| D | 100 | 14,400 | 9,300 | 6,200 | | X 0.385 = | | | = 2 = | |
| E | 300 | 16,700 | 11,000 | 7,400 | | X 0.333 = | | | = 2 = | |
| F | 1,000 | 21,600 | 13,500 | 9,000 | | X 0.286 = | | | = 2 = | |
| G | 3,000 | 26,250 | 15,800 | 10,500 | | X 0.250 = | | | = 2 = | |

| EFFECTIVE DOWNWIND MESSAGE | |
|----------------------------|--------|
| ZULU | DDtttt |
| ALFA | ddssss |
| BRAVO | ddssss |
| CHARLIE | ddssss |
| DELTA | ddssss |
| ECHO | ddssss |
| FOXTROT | ddssss |
| GOLF | ddssss |

When the azimuth of the ground zero/cloud-top radial line ② or the azimuth of the ground zero/2/3 stem radial line ③ falls in the first quadrant (0° to 90°) and the other falls in the fourth quadrant (270° to 360°), result of ② + ③ will be the back azimuth of the effective downwind direction. In this case, determine ddd by the following method: If result is greater than 180°, subtract 180°. If result is less than 180°, add 180°. Enter in the effective downwind message.

AFD V2.00

EDITION OF SEP 94 IS OBSOLETE

DA FORM 1971-3-R, SEP 94

Figure G-15. EDM Work Sheet

(d) To calculate the data, use the detailed procedure discussed later in this appendix with 2 KT for ALPHAM, 5 KT for BRAVOM, 30 KT for CHARLIEM, and so on.

Example: NBC EDM

AREA/RRRRR// (area of validity)

ZULUM/ddttttZMMMYYYY/ (DTG when winds were measured)

UNIT/LLL/DDD/SSS/-//

ALPHAM /-/ddd/sss/***

BRAVOM /-/ddd/sss/***

CHARLIEM /-/ddd/sss/***

DELTAM /-/ddd/sss/***

ECHOM /-/ddd/sss/***

FOXTROTM /-/ddd/sss/***

GOLFM /-/ddd/sss/***

ZULUM (ddttttZMMMYYYY) is the DTG at which the real winds for the wind vector plot were measured (e.g., 020600ZJUN2004 is the 2nd day of June 2004 at 0600Z).

UNIT (LLL/DDD/SSS/-//) are the units of measurement being used (e.g., LLL = (KM), DDD = degrees grid (DGG), and SSS = KPH). DDD is the effective downwind direction in degrees, and SSS is the effective downwind speed in kph (e.g., ALPHAM 080025 is a downwind direction of 80 degrees, and 25 is an effective downwind speed of 25 kph, valid for yields of 2 KT or less. If ALPHAM was 004, LLL (/-/) would be the downwind distance of Zone I (4 km).

(4) M5A2 Fallout Predictor. The M5A2 fallout predictor is a transparent device used to outline the zones of hazard resulting from surface bursts for the preselected yield groups.

(a) The M5A2 fallout predictor is composed of two simple predictors and a nomogram for determining the downwind distance of Zone I.

(b) One predictor is drawn to a scale of 1:50,000; the other predictor is drawn to a scale of 1:250,000. Each predictor contains preselected yield groups (A, B, C, D, and E—1:50,000 and A, B, C, D, E, and F—1:250,000). Each simplified predictor consists of three major parts:

- Azimuth dial for orientation.
- Semicircles depicting stabilized nuclear-cloud radii drawn around GZ.

This shows the area of contamination for each of the preselected yield groups.

- A map scale calibrated in km along two radial lines extending out from the center of the azimuth dial.

(5) Types and Cases of Simplified Fallout Prediction. There are three cases for simplified fallout prediction: one is normal and two are special. They are defined by the number of digits that are contained on the specific yield group being used.

(a) Six Digits, Normal Case. Under normal conditions, the wind speed will be 8 kph or more. When wind speeds are 8 kph or greater (>8 kph), 6 digits will be given on the EDM. These 6 digits are used to prepare the simplified fallout prediction. To prepare a simplified fallout prediction depicting a 6-digit normal case, see Figure G-12, page G-25.

- Determine the yield of the weapon. This information is located on line NOVEMBER of the NBC2 NUC report.

- Use the yield and determine which line of the EDM will be used to prepare the simplified fallout prediction.

Example: 50 KT = Line DELTA of the EDM; the yield is more than 30 KT, but less than 100 KT.

DELTA is > 30 KT ≤ 100 KT

- Utilize the first three digits (ddd) from the EDM, and draw a line from GZ, through the appropriate wind direction on the azimuth dial. Label this GN. Record the downwind direction (ddd) on the M5A2.

- Utilize the EWS (sss on EDM) and the yield (not the yield group), and determine the downwind distance zone of immediate concern (see Figure G-16, page G-32). Align the two known values (EWS and yield). This will allow the reading of the Zone I distance.

- Draw an arc between the radial lines of the predictor at the appropriate distance downwind from GZ for Zone I. Double this distance, and draw a second arc downwind from GZ for Zone II. Zone II is always twice Zone I. Label Zone I and Zone II.

- Draw left and right tangents from the cloud radius line for the yield group to the points of the intersection of the radial lines and Zone I arc of the predictor.

- Draw a series of dashed arcs at distances equal to the EWS (sss) within Zones I and II. For example, EWS = 15 kph, then H+1 (1 hour after the burst) would be drawn (dashed arc) at 15 km, H+2 at 30 km, and H+3 at 30 km. However, if the extent of Zone II were 29 km, then (in this example) there would be only two time-of-arrival arcs (H+1 and H+2). If a time-of-arrival arc coincides with a zone boundary, extend the zone boundary with a dashed line and label it with the appropriate time of arrival (e.g., H+2 and extent of Zone II were 30 km).

- Place the center of the azimuth dial on the predictor over the estimated GZ on the map. Rotate the predictor around the GZ point until the GN line is pointing toward GN.

- The predictor is now oriented, and the area predicted to be covered by fallout can now be evaluated.

(b) Three Digits, Circular Special Case. Generally, when the wind speed is less than 8 kph, fallout will not go in a definite direction and will return primarily around GZ. The following is how to prepare a simplified fallout prediction depicting a 3-digit circular case:

Situation: Determine the downwind distance of Zone I.

-EWS from line YANKEE of the NBC2 Report is **029 km/h**.

-Estimated yield from line NOVEMBER of the NBC2 Report is **35 KT**.

-Align the hairline from left to right, placing it on 29 km/h, keeping the hairline in place at 29 km/h; align it also with the yield of 35 KT on the left scale.

Read the middle scale for the distance to Zone I of 33 km. Note that this will be rounded to the nearest whole number. **NOTE: Hairline may not be to scale.**

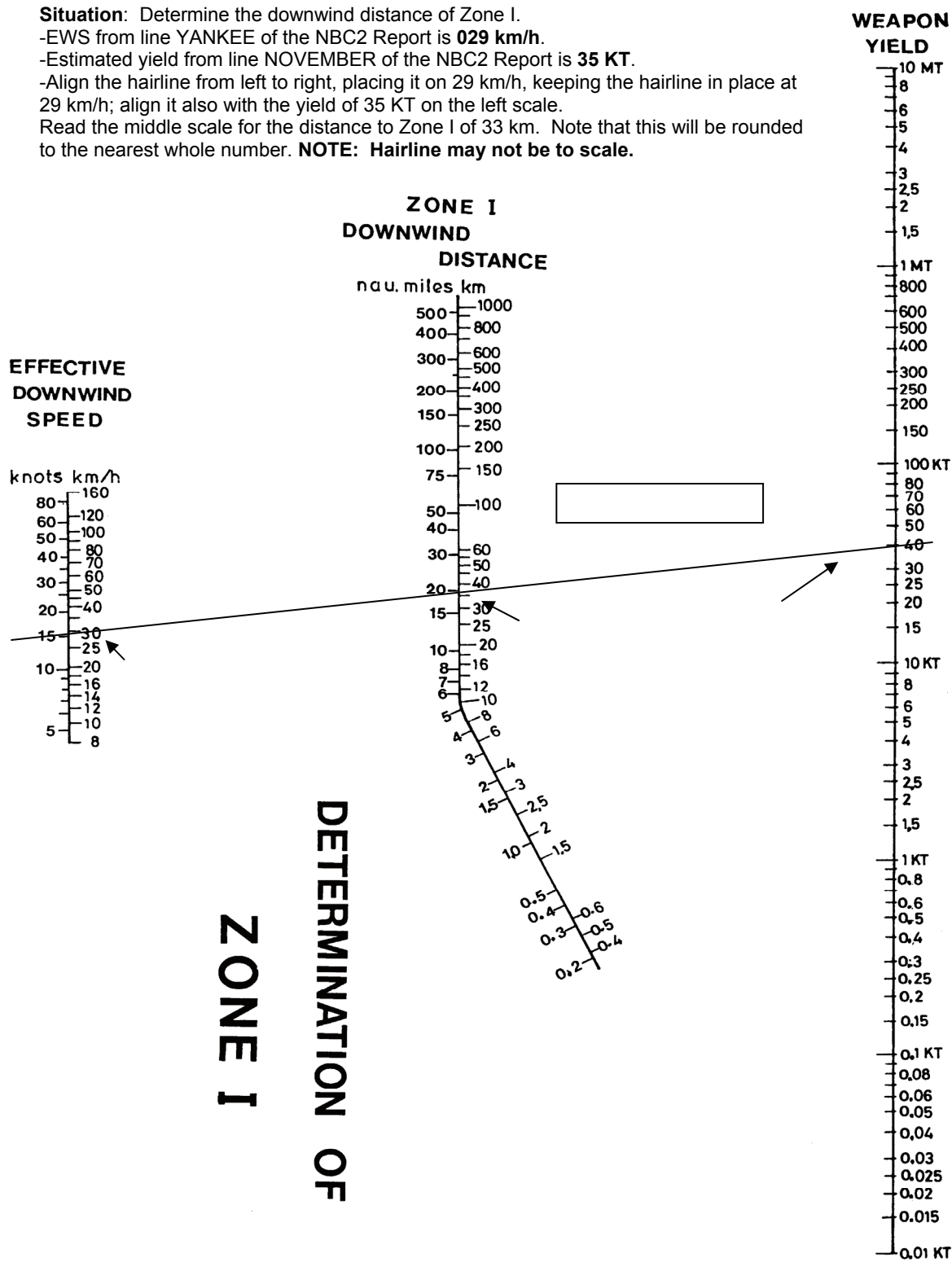

Figure G-16. Determination of Zone I, Downwind Distance (Example)

- Whenever wind speeds are less than 8 kph three (LLL) digits will appear on the EDM line item. This indicates the prediction will have a circular pattern.
- At GZ on the M5A2 predictor, draw a circle equal to the radius reported on the EDM. Label this radius Zone I.
- Double the distance of Zone I, and draw a circle, using the same center (GZ) used for Zone I. Label it Zone II.

(c) Nine Digits, Special Case, Expanded Angles. When 9 digits (7 in ADP format) are reported in the EDM line, the angle reported is greater than 40°. The prediction is plotted in the same manner as a normal case, except the left and right radial lines are expanded equally from the preset 40° angle, to include all radioactive hazards. Radial lines are expanded from GZ to the end of Zone II. (Example: If the expanded angle is (***) 60 degrees or (*) 6, expand the radial lines 30 degrees on each side of the reference line.)

(6) Time of Arrival.

(a) Estimate the time of arrival of the fallout at a specific distance from GZ by dividing the distance by the EWS. The formula looks like this:

$$\frac{\text{Distance from GZ (km)}}{\text{EWS (kph)}} = \text{Time of Arrival}$$

(b) For operational purposes, the following rules of thumb may be applied to the actual arrival of fallout:

- The actual arrival of fallout may occur as early as one-half of the estimated time of arrival. That is, if the estimated time of arrival of the fallout is H+4 hours, the actual arrival may occur as early as H+2 hours.
- If the actual arrival of fallout has not occurred at twice the estimated arrival time (or 12 hours, whichever is earlier), it may be assumed that the area will not receive fallout.

f. Ship Fallout Template. A fallout template, particularly designed for use on ships, is shown in Figure G-17 and Figure G-18 (pages G-34 and G-35). The ship fallout template is similar to the M5A2 fallout predictor (Figure G-14, page G-27) used by forces on land. The main difference is that the semicircles upwind of GZ on the ship fallout template do not refer to preselected weapon yield cloud radii.

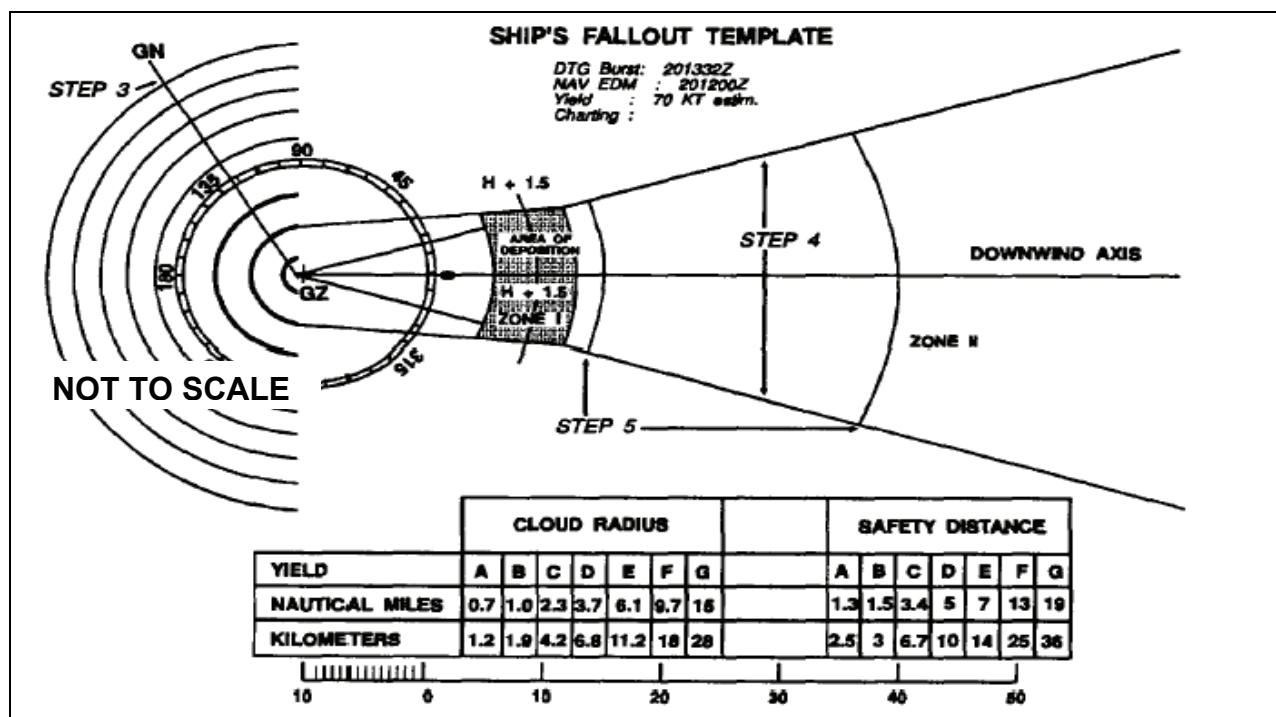

Figure G-17. Ship Fallout Template (Example)

(1) Safety Distance. Determining the safety distance begins with determining the fallout area at a specific time after detonation. Fallout will not occur simultaneously within the predicted fallout area. It will commence in the vicinity of GZ and may be expected to move down the fallout pattern (downwind direction) with an approximate speed of the effective wind. The approximate zone in which deposition at the surface is taking place at a specific time after the detonation may be determined by the use of the following procedures:

- (a) Step 1. Multiply the effective downwind speed by the time (in hours) after the detonation.
- (b) Step 2. Add the safety distance obtained from the template (for the standard yield groups) to the distance found in Step 1 to allow for finite cloud size, diffusion, and wind fluctuations.
- (c) Step 3. On the plot (template), with GZ as center and the two distances obtained from Step 2 as radii, draw two arcs across the fallout pattern. The zone enclosed between these two arcs will, in most cases, contain the area of deposition at a specific time after the detonation.

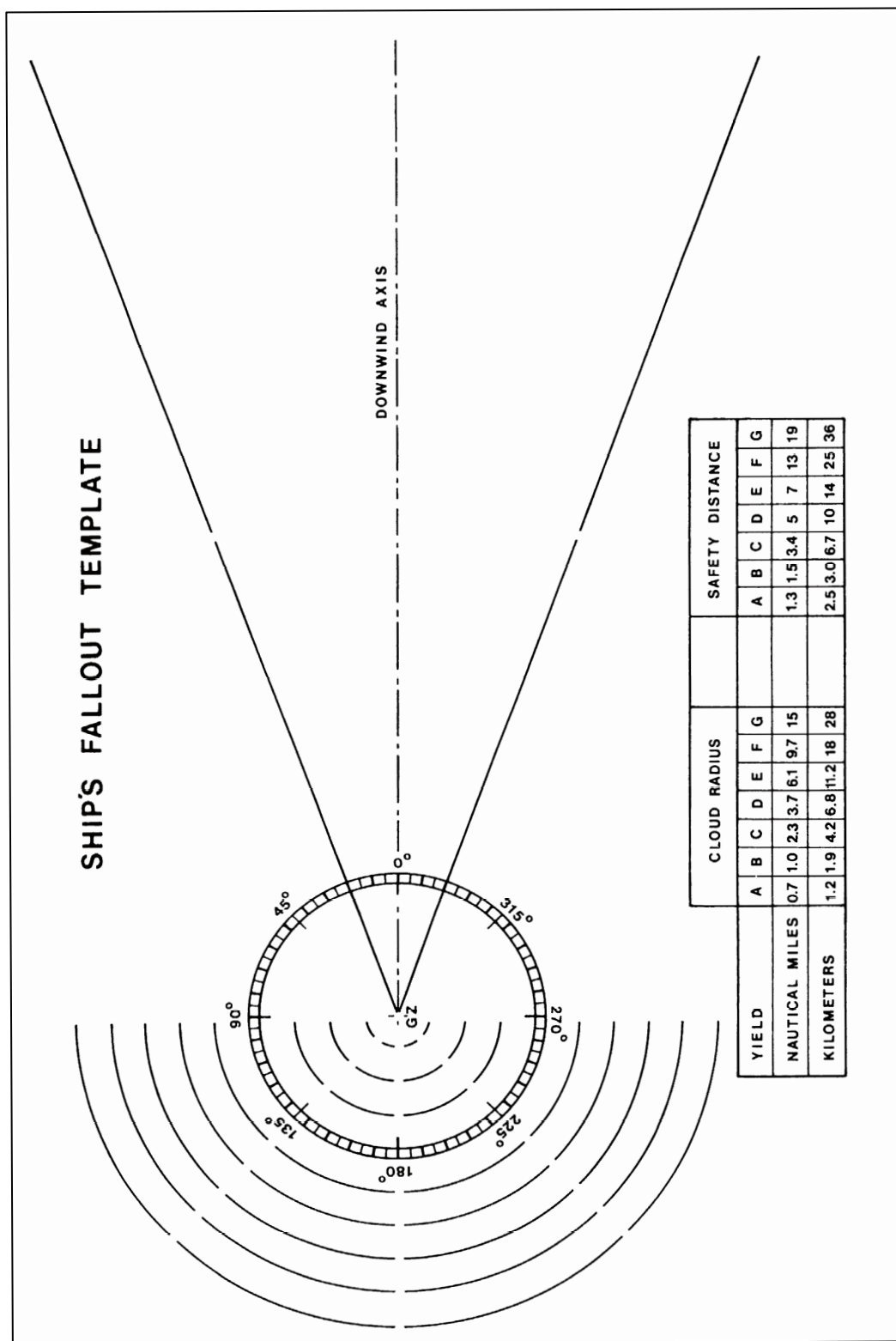

Figure G-18. Ship Fallout Template

(2) Fallout Plotting from the NAV EDM and Observations. Example: A ship has received the NAV EDM. At 201332Z, a nuclear burst is observed from the ship, and based upon the observations taken from the ship, the yield is estimated to be 70 KT and the estimated GZ is 56°00' N-12° 00' E. A NAV NBC1 NUC report is transmitted as required, and the ship will have to prepare a fallout prediction, using the simplified procedures:

(a) Step 1. As the yield is estimated only on the basis of observation, the yield estimation may not be accurate. So, to be on the safe side, the greatest yield group in which the estimated yield is contained should be used. Seventy KT is in yield group DELTA, and the largest yield in this group is 100 KT. Therefore, 100 KT will be used for the fallout prediction.

(b) Step 2. Select the data contained in the DELTA yield group in the NAV EDM: DELTA 122016, meaning that the effective downwind direction is 122° and the effective downwind speed is 16 knots.

(c) Step 3. On the template, draw the GN line from GZ through 122° on the compass rose (see Figure G-19).

(d) Step 4. From the nomogram in Figure G-16, page G-32, determine the downwind distance of Zone 1 to be 30 nautical miles. The Zone II downwind distance is double this distance, or 60 nautical miles from GZ, in effective downwind direction.

(e) Step 5. Using GZ as the center and the Zone I and Zone II distances as radii (to the appropriate chart scale), draw two arcs between the radial lines. From the template, read the cloud radius to be 3.7 nautical miles and draw a semicircle upwind of GZ, using GZ as center and 3.7 nautical miles as radius. The preprinted semicircles may be helpful. From the intersections of the Zone I arc with the radial lines, draw lines to connect with the ends of the semicircle.

(f) Step 6. Determine the area where the deposit of fallout is estimated to take place at a specific time after the detonation. Multiply the effective downwind speed by the time (hours after detonation)—1.5 hours after the burst (H+1.5 hours): 16 knots times 1.5 hours = 24 nautical miles. With GZ as the center and 24 nautical miles as the radius, draw a dotted arc across the fallout plot. This arc represents the middle of the area where the fallout may be expected to reach the surface at H+1.5 hours after the detonation. To allow for finite cloud size, diffusion, and wind fluctuations, a certain distance ahead of and behind this line must be added to determine the area where, in most circumstances, the fallout will be deposited at the surface at H+1.5 hours. This is the safety distance. From the table printed on the template, find the safety distance for yield group DELTA (100 KT) to be 5 nautical miles. Add and subtract 5 nautical miles to and from 24 nautical miles:

$$24 + 5 = 29 \text{ nautical miles, and } 24 - 5 = 19 \text{ nautical miles}$$

Draw two arcs across the fallout pattern, using the two distances as radii and GZ as the center. The area confined by the two arcs and the crosswind boundaries of the fallout area defines the approximate area of fallout deposit at 1.5 hours after the detonation. Complete the fallout prediction plot by indicating the following on the fallout template: NAV EDM used, yield, GZ, and geographic chart number (scaling).

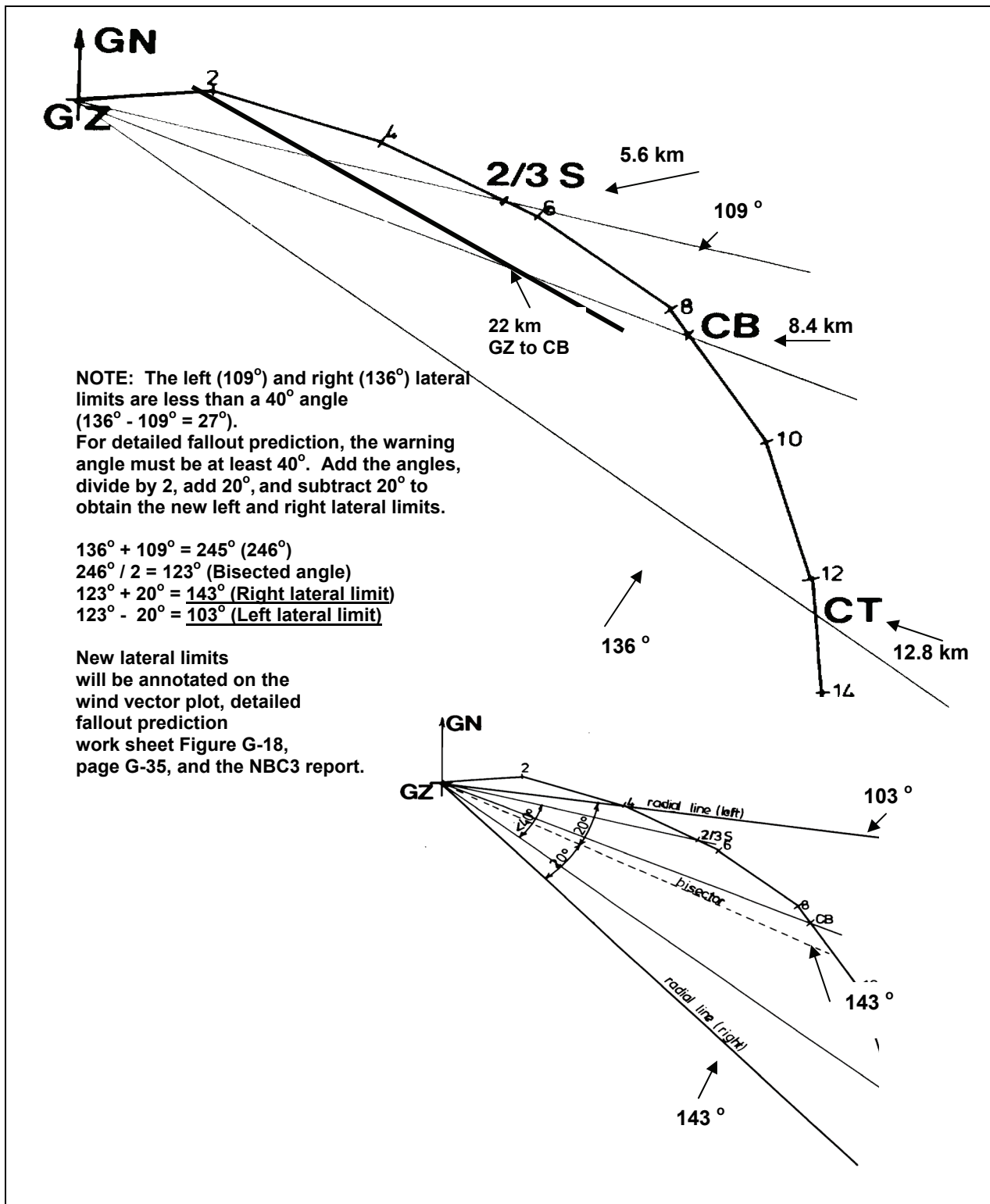

Figure G-19. Wind Vector Plot with Cloud and Stem Radial Lines (50 KT) (Example)

g. Detailed Fallout Prediction.

(1) Purpose. The purpose of the detailed fallout prediction is to provide the subordinate units an immediate warning of the predicted contamination resulting from a nuclear detonation. The commander will use the detailed fallout prediction in the tactical decision-making process.

(2) Procedures. The CBRN cell is responsible for preparing and plotting the detailed fallout predictions. The fallout prediction work sheet provides the CBRN cell with a standard work sheet for recording the nuclear burst (surface) information data. Completing the fallout prediction work sheet is the first step in drawing the prediction. Use the steps listed below to complete the work sheet.

(a) Step 1. Obtain a current wind vector plot. Before any bursts occur, the wind vector plots are drawn. Refer to Appendix D for detailed information regarding wind vector plotting (see Figure G-19, page G-37).

(b) Step 2. Complete a detailed fallout prediction work sheet. Utilizing an NBC2 NUC report, determine the nuclear-burst information. Record this information on the work sheet (see Figure G-20).

- Lines ALFA, BRAVO, and ECHO are transcribed from the NBC2 NUC report.
- Lines CHARLIE and DELTA are used if the enemy burst or friendly burst data is unknown. When enemy or friendly burst information is unknown, assume that a worst case (100 percent fission yield [FY]) scenario has occurred and enter a 1 on line CHARLIE. When the height of burst (HOB) is unknown, enter a 0 (zero) on line DELTA, which represents a worst case HOB.
- A friendly burst with known data information will come from the fire support element (target analyst) delivering the weapon. The data will include the weapon yield, FY/total yield (TY) ratio, HOB, GZ coordinates, DTG of the attack, and strike serial number.

(c) Step 3. Determine the cloud parameters. Utilizing the yield of the weapon from line ECHO and the nomogram (Figure G-21, page G-40), locate the yield on the right- or left-hand scale. Place a straightedge (hairline) on the yield, and align the values on both scales. Read and record all cloud parameter values on lines FOXTROT through JULIET of the fallout prediction work sheet.

NOTE: The following steps are exactly the same as the steps utilized in making an EDM (refer to Appendix D for more information regarding EDMs).

(d) Step 4. Determine the lateral limits of the prediction utilizing the wind vector plot. Mark the points representing the cloud top height and the two-thirds stem height. Draw radial lines from the GZ point through these height points.

NOTE: If the wind vectors between the two-thirds stem height point and the cloud top height point fall outside the radial lines drawn from GZ, expand the angle formed by these two radial lines to include these outside wind vectors.

NUCLEAR FALLOUT PREDICTION WORK SHEET – SURFACE BURST

NOTE: Complete the work sheet to provide information for the NBC3 NUC report. Line out unused units of measure in the far right-hand column.

| | | | |
|----|---|-----------------------|--|
| A. | TOB (DTG) (from the NBC2 NUC report) | <u>120657ZDEC2004</u> | DELTA (DD TTTTZ MMM YYYY) (Local or ZULU time) |
| B. | GZ coordinates (from the NBC2 NUC report) | <u>WB764766</u> | FOXTROT (yy zzzzzz) (Actual or estimated) |
| C. | FY/TY ratio (from target analysis for STRIKWARN only) (If known, enter #; if unknown or for enemy attack, enter 1) | <u>1</u> | |
| D. | HOB (from target analysis for STRIKWARN only) (If known, enter #; if unknown or for enemy attack, enter 0) | <u>0</u> | Meters |
| E. | Yield (from NBC2 NUC report) | <u>50</u> | KT or MT |
| F. | Cloud top height (use Figure G-21, page G-40) | <u>12.8</u> | 10 ³ meters or feet |
| G. | Cloud bottom height (use Figure G-21) | <u>8.4</u> | 10 ³ meters or feet |
| H. | 2/3 stem (Use Figure G-21.) | <u>5.6</u> | 10 ³ meters or feet |
| I. | Stabilized cloud radius (use Figure G-21) | <u>06</u> | PAPAB – rr (KM) (round up to nearest whole number) |
| J. | Time of fall from cloud bottom (Use Figure G-21) | <u>2.38</u> | Hours (round to nearest hundredth) |

NOTE: Plot F, G, and H on the current wind vector plot. Measure the distance from GZ to the cloud bottom height.

| | | | |
|----|--|------------|---|
| K. | Radial line distance from GZ to cloud bottom height | <u>22</u> | KM |
| L. | EWS (from the NBC2 NUC report) $\frac{K}{J} = \frac{22}{2.38}$ | <u>009</u> | PAPAB – sss (KM/H) (round to the nearest whole number) |
| M. | Downwind Distance of Zone I (use Figure G-22, page G-42, with E and L) | <u>022</u> | PAPAB – xxx (KM) (round to nearest whole number) |
| N. | Adjustment calculation of downwind distance of Zone I FY/TY Factor (C) <u>1</u> x HOB (D) <u>1</u> = Use Figure G-23, page G-43. Use Figure G-22, page 42. (If unknown or for enemy attack, enter 1 and 1.) | <u>1</u> | |
| O. | Adjustment of downwind distance of Zone I | <u>022</u> | PAPAB – xxx (KM) (round to nearest whole number) |

NOTE: Ensure that the lateral limit angle (angle between left and right radial lines) is $\geq 40^\circ$. If it is not, add azimuths, divide the sum by 2, and add 20° to each azimuth. These are the new radial lines. Ensure that the new azimuths are entered below.

| | | | |
|----|------------------------------|-------------|-----------------------------------|
| P. | Azimuth of left radial line | <u>0103</u> | PAPAB – dddd (mils or degrees) |
| Q. | Azimuth of right radial line | <u>0143</u> | PAPAB – cccc (mils or degrees) |

| | | | |
|----|--|--------------------------------|---|
| R. | NBC3 NUC Report | | |
| | ALFA (AAA) | <u>N001</u> | (Strike serial number) |
| | DELTA (DD TTTTZ MMM YYYY) | <u>120657ZDEC2004</u> | (Local or ZULU time) |
| | FOXTROT (yy zzzzzz) | <u>WB764766</u> | (Actual or estimated) |
| | PAPAB (sss xxx rr) * (dddd cccc)** | 009 022 06 <u>0103 0143</u> | (Azimuths of radial lines – mils or degrees) |
| | * sss – EWS (KM/H) * xxx – Downwind Distance of ZONE I (KM) * rr – Cloud Radius (KM) ** dddd – Left Radial Line ** cccc – Right Radial Line | | |

Figure G-20. Detailed Fallout Prediction Work Sheet (Example)

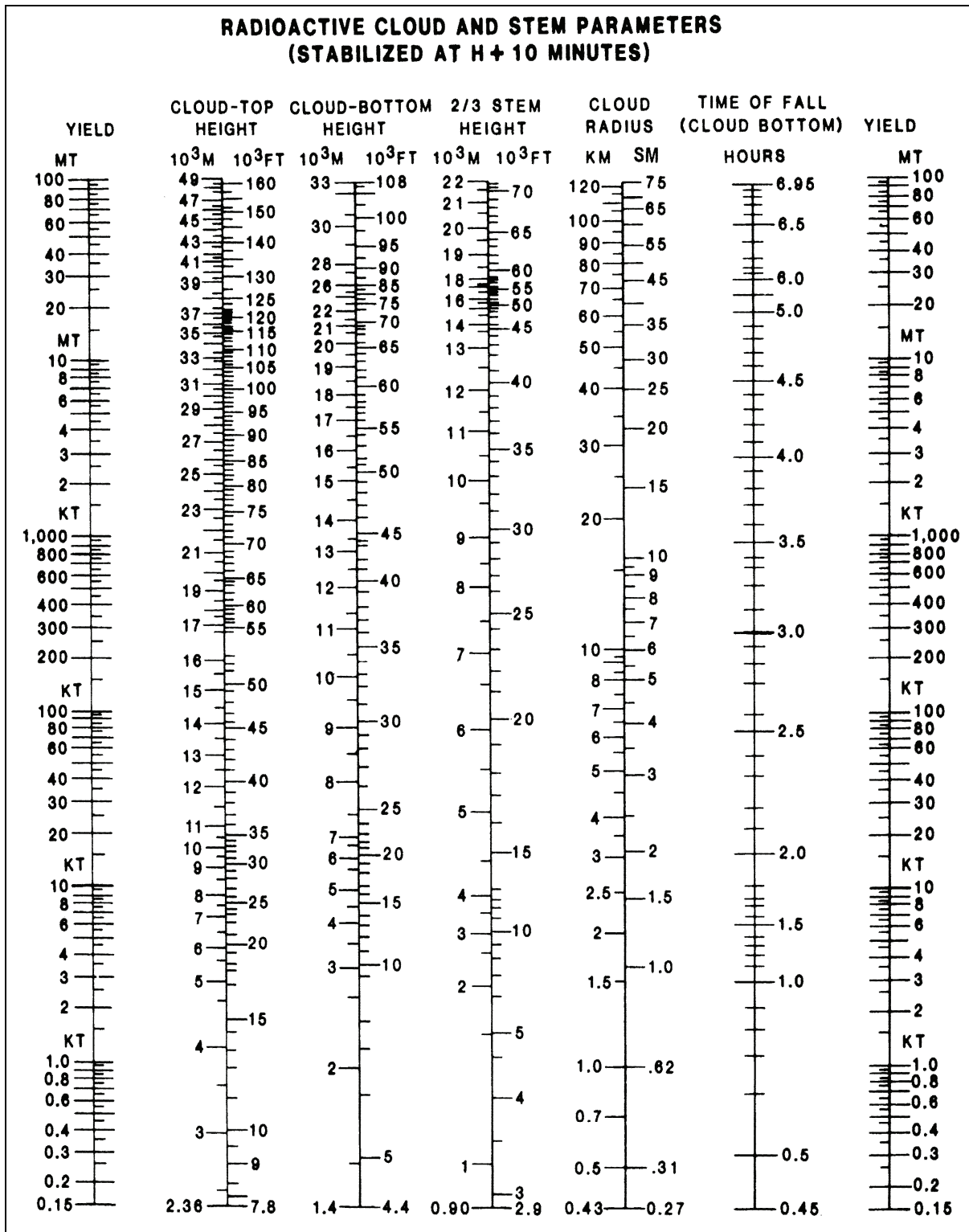

Figure G-21. Stabilized Cloud and Stem Parameters for Detailed Fallout Prediction (Example)

(e) Step 5. Determine the effective wind speed (EWS). Mark the cloud bottom height on the wind vector plot, and measure the length of the radial line (in km) from GZ. Record this value on line KILO of the work sheet. Transfer the values from line KILO and line JULIET to line LIMA. Compute the EWS using the following formula:

$$\text{EWS} = \frac{\text{Radial Line Distance From GZ to CB Height (KM)}}{\text{Time of Fall From CB (HR)}}$$

Round this number to the nearest km. (Example: 21.5 = 22; 22.4 = 22.)

NOTE: If the EWS is less than 8 kph, it is a special case. When the wind speed is less than 8 kph, always use an 8 kph wind speed in Step 6 below.

(f) Step 6. Determine the downwind distance of Zone I and Zone II. Align a straightedge (hairline) from the yield on the right-hand scale (line ECHO of the fallout prediction work sheet) to the EWS on the left-hand scale (line LIMA of the fallout prediction work sheet) using Figure G-22, page G-42. Where the straightedge intersects the center scale, read the downwind distance of Zone I. Record this on line MIKE of the fallout prediction work sheet.

(g) Step 7. Obtain the FY/TY ratio from the nuclear target analyst. The FY/TY ratio is expressed as a percentage. It states the percent of the weapon explosive ability that is contributed by the fission process. The remainder of the weapon yield is derived from fusion. This is significant in the fallout prediction. The fusion portion of the weapon does not create residual contamination. Thus, a weapon with a FY/TY ratio of 0.6 means that 60 percent is fission and 40 percent is fusion. A crude comparison could be that this weapon will make 40 percent less fallout than a weapon with the same size yield that is 100 percent fission. If the FY/TY ratio is known, obtain the FY/TY adjustment factor from the nomogram (Figure G-23, page G-43). The following describes how to use the nomogram:

- Lay a straightedge (hairline) from the TY on the left-hand scale to the value of the FY/TY ratio on the right-hand scale. Where the straightedge intersects with the center scale, read the FY/TY adjustment factor. Record the FY/TY ratio on line NOVEMBER of the work sheet.
- Assume the yield to be 100 percent fission, and use an FY/TY adjustment factor of 1 if the FY/TY ratio is unknown. Record the FY/TY adjustment factor on line NOVEMBER of the work sheet.
- Obtain the HOB adjustment factor from the nomograms (see Figures G-24 and G-25, pages G-44 and G-45) if the HOB is known. To use the nomogram, lay a straightedge (hairline) from the yield on the left-hand scale to the value of the HOB on the center scale. At the intersection of the straightedge with the right-hand scale, read the HOB adjustment factor. Record the HOB adjustment factor on line NOVEMBER of the work sheet.
- Assume a zero HOB, and use an HOB adjustment factor of 1 HOB if HOB is unknown. Record HOB on line NOVEMBER of the work sheet.
- Obtain the adjusted downwind distance of Zone I. Multiply line MIKE by line NOVEMBER; the result will be the adjusted downwind distance of Zone I and is entered on line OSCAR of the work sheet.

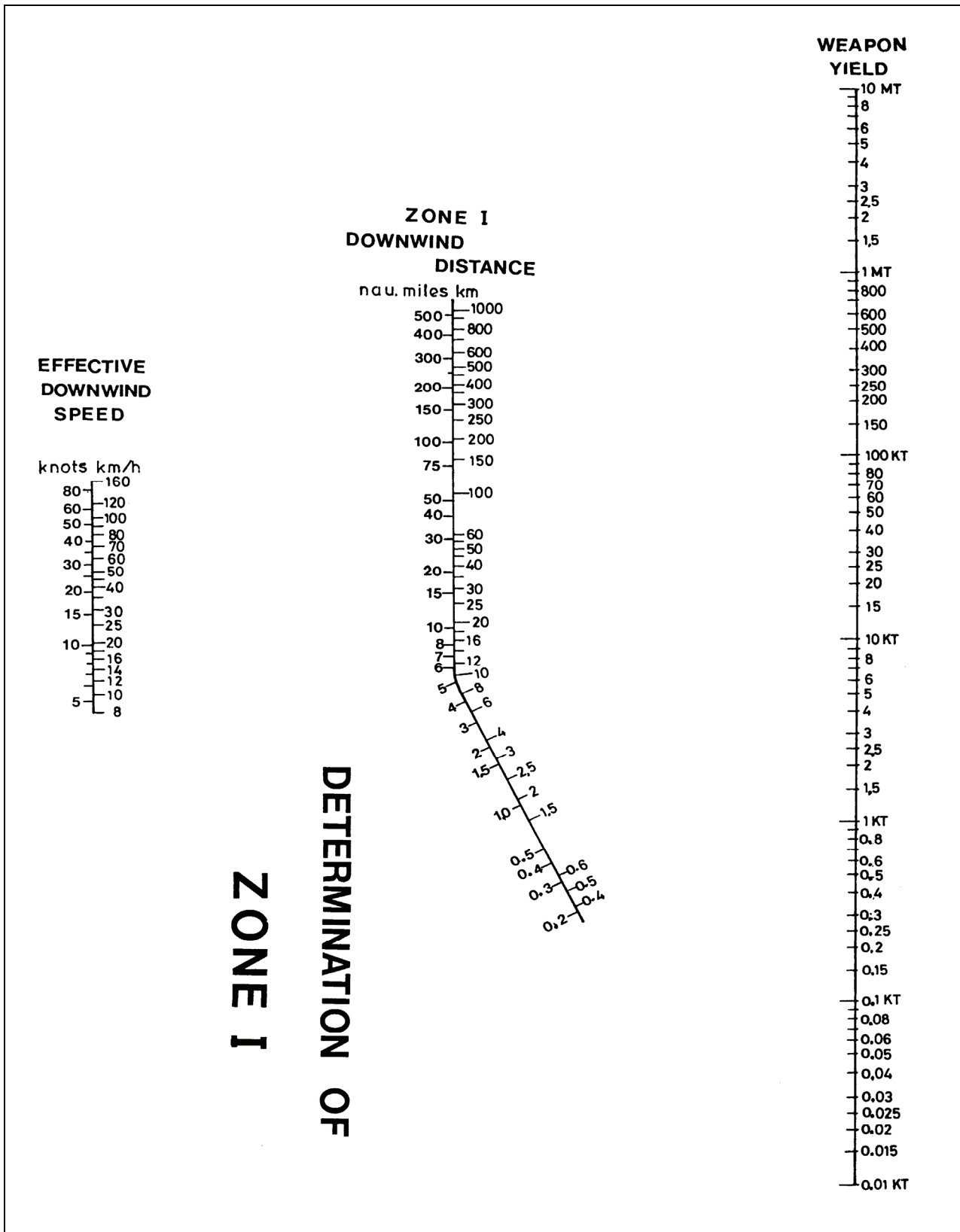

Figure G-22. Determination of Zone I, Downwind Distance (Example)

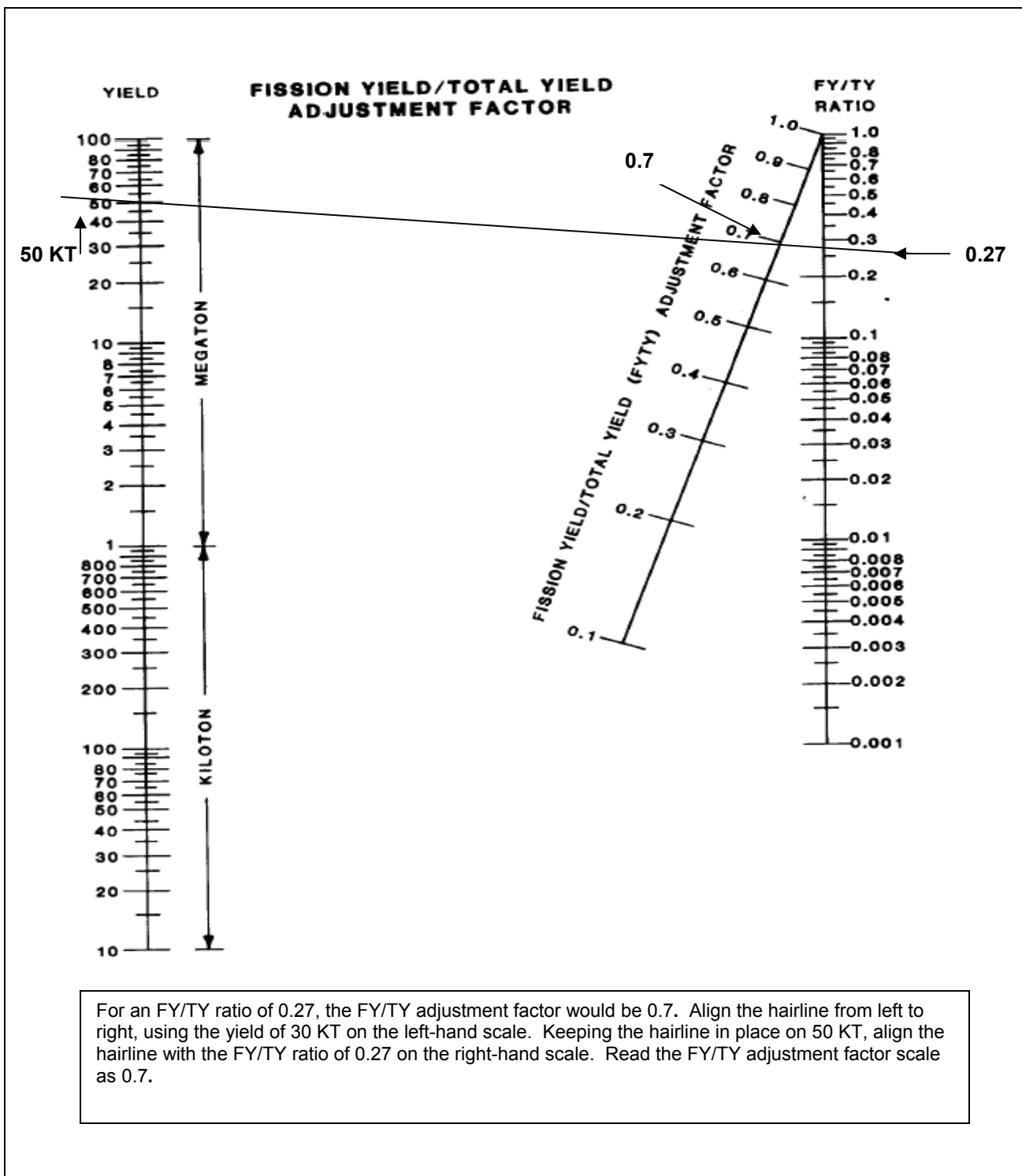

Figure G-23. FY/TY Adjustment Factor (Example)

HEIGHT-OF-BURST ADJUSTMENT FACTOR, KILOTON YIELD ≤ 100 KT

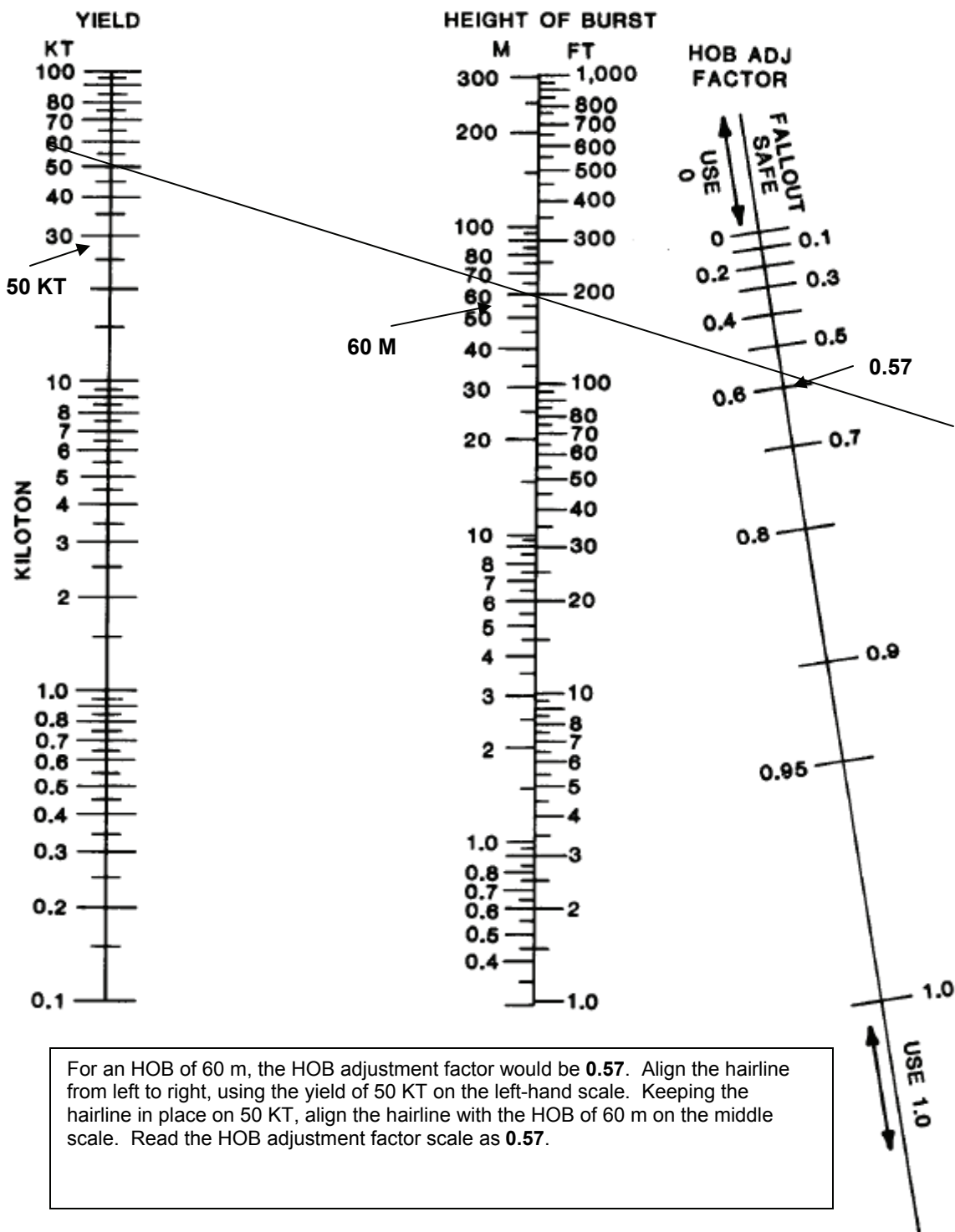

Figure G-24. HOB (Kilaton) Adjustment Factor (Example)

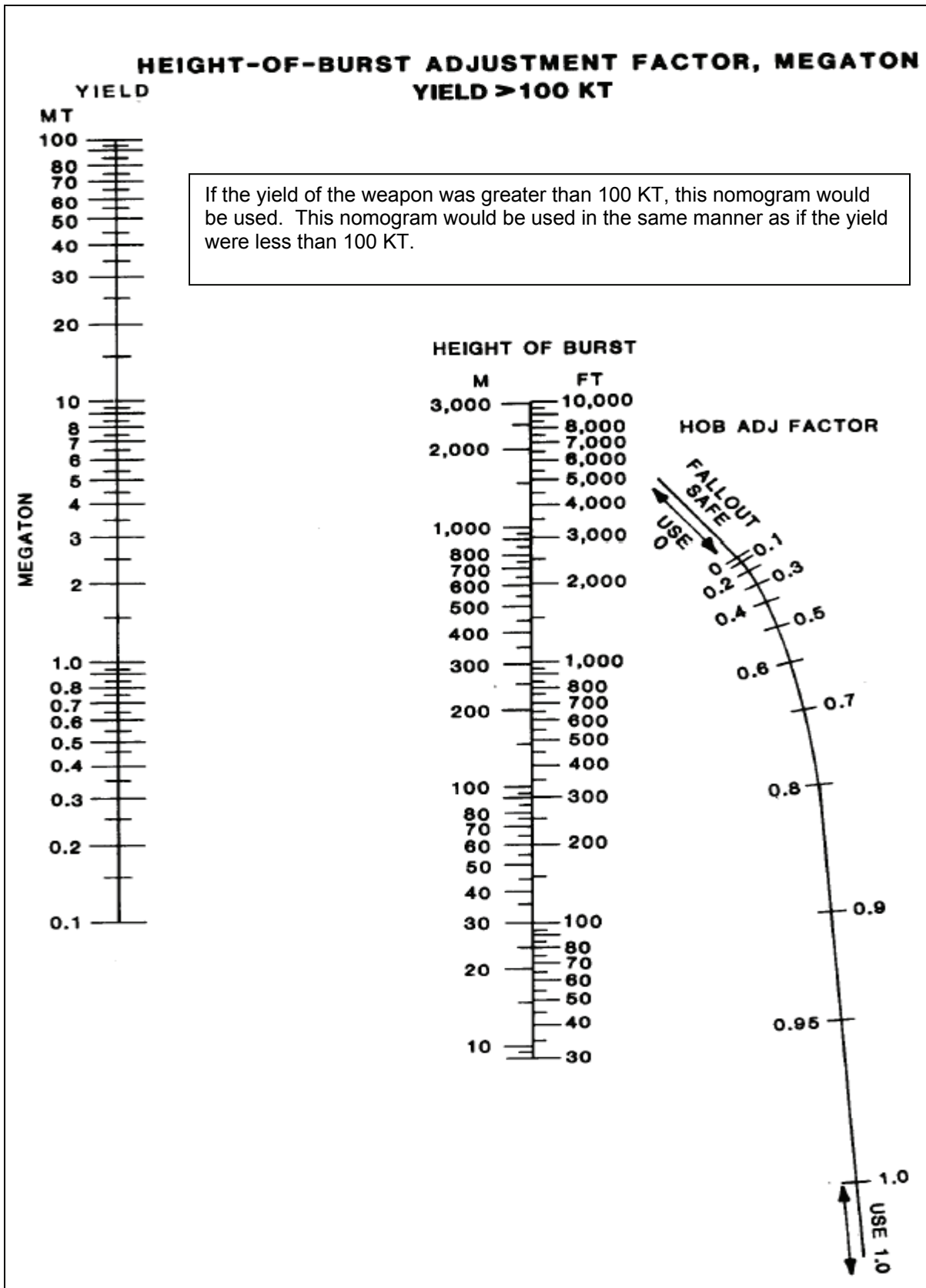

Figure G-25. HOB (Megaton) Adjustment Factor (Example)

NOTE: If the EWS is less than 8 kph, the detailed prediction is now complete. Prepare the NBC3 NUC report (line ROMEO of the work sheet) as described in Step 9. If the wind speed is greater than or equal to 8 kph, go to Step 8.

(h) Step 8. Construct left and right radial lines. Measure the angle formed by the radial lines drawn from GZ to the cloud top height and two-thirds stem height.

NOTE: If the radial lines have been expanded to include vectors between the two-thirds stem height and the cloud top height, this angle must be measured.

- If the angle formed is 40° or greater, measure the azimuths (in mils or degrees from GZ) of the final left and right radial lines and record them on lines PAPA and QUEBEC of the work sheet.

- If the angle formed is less than 40°, bisect the angle (add azimuths together and divide by 2) and expand the angle formed by the two radial lines to 40° (20° on each side of the bisected azimuth). (See note in Figure G-19, page G-37).

(i) Step 9. Prepare the NBC3 NUC report. Complete line ROMEO of the work sheet. The report will always include the following line items:

- Line ALPHA: This line is the strike serial number. The strike serial number is assigned by the CBRN cell at the operations center responsible for the area in which the strike occurs.

- Line DELTA: (DDTTTTZMMMYYYY) This line is the DTG of the burst, with DD (day), TTTT (H-hour) in local or ZULU time (state which), MMM (month), and YYYY (year).

- Line FOXTROT: (yyzzzzzz) This line is the actual or estimated (state which) coordinates of GZ. The letters “yy” represent the appropriate 100,000-meter grid square, and the letters “zzzzzz” represent coordinates of the GZ within this grid square.

- Line PAPAB: (sssxxrr ddddccc) This line is the prediction dimensions and the azimuths of the two radial lines to the nearest mil or degree from GZ. The letters “sss” represent the EWS to the nearest kph. The letters “xxx” represent the downwind distance of Zone I to the nearest km. The letters “rr” represent the radius of the stabilized cloud (GZ circle) to the next higher km if the value is not a whole number. The letters “ddd” represent the azimuth of the left radial line, and the letters “ccc” represent the azimuth of the right radial line (mils or degrees).

- This line will contain only three digits (xxx) when the special case of low winds (less than 8 kph) exists.

7. NBC3 NUC Report

The NBC3 NUC report is vital to effectively disseminating the estimated travel of fallout across the battlespace.

a. General. The NBC3 NUC report reflects the predicted zones of contamination for a nuclear surface burst. It is based on the NBC2 NUC report and a current wind vector plot. Users of the NBC3 NUC reports are not limited to the use of the line items shown in the example (see Figure G-26). Other line items may be added as appropriate.

(1) Purpose. The purpose of the NBC3 NUC report is to report immediate warning of the predicted contamination and hazard areas to higher, subordinate, and adjacent units.

(2) Message Precedence. All other messages, after the initial NBC1 NUC report has been sent, should be given a precedence, which reflects the operational value of the contents. Normally IMMEDIATE would be appropriate.

| NBC3 NUC Report | | | |
|-----------------|--|-------|---|
| Line Item | Description | Cond* | Example |
| ALFA | Strike serial number | M | ALFA/US/A234/001/N// |
| DELTA | DTG of attack or detonation and attack end | M | DELTA/201405ZSEP2005// |
| FOXTROT | Location of attack or event | M | FOXTROT/32UNB058640/EE// |
| GOLF | Delivery and quantity information | O | GOLF/SUS/AIR/1/BOM/4// |
| HOTEL | Type of nuclear burst | O | HOTEL/SURF// |
| NOVEMBER | Estimated nuclear yield, in KT | O | NOVEMBER/50// |
| PAPAB | Detailed fallout hazard prediction parameters | M | PAPAB/019KPH/33KM/5KM/ 272DGG/312DGG// |
| PAPAC | Radar-determined external contour of radioactive cloud | O | PAPAC/32VNJ456280/32VNJ456119/ 32VNJ556182/32VNJ576200/ 32VNJ566217/32VNJ456280// |
| PAPAD | Radar-determined downwind direction of radioactive cloud | O | PAPAD /030DGT// |
| XRAYB* | Predicted contour information | C | |
| YANKEE | Downwind direction and downwind speed | O | YANKEE/270DGT/015KPH// |
| ZULU | Actual weather conditions | O | ZULU/4/10C/7/5/1// |
| GENTEXT | General text | O | |

*The Cond column shows that each line item is operationally determined (O), mandatory (M), or conditional (C).

Figure G-26. Sample NBC3 NUC Report

b. Plotting Detailed Fallout Predictions (NBC3 NUC) (see Figure G-27, page G-48).

(1) Step 1. Identify the map scale to be used. Obtain a sheet of overlay paper or other transparent material. Mark a GZ location and GN.

(2) Step 2. Examine line PAPAB. Starting at the GZ location, draw the left (dddd) and right (ccc) radials line measured from GZ.

(3) Step 3. From line PAPAB, determine the downwind distance of Zone I (xxx).

(a) Starting from GZ, draw an arc between the radial lines with a radius equal to the distance of Zone I. Label this area Zone I.

(b) Draw a second arc between the radial lines at twice the radius as the downwind distance of Zone II. Label this area Zone II.

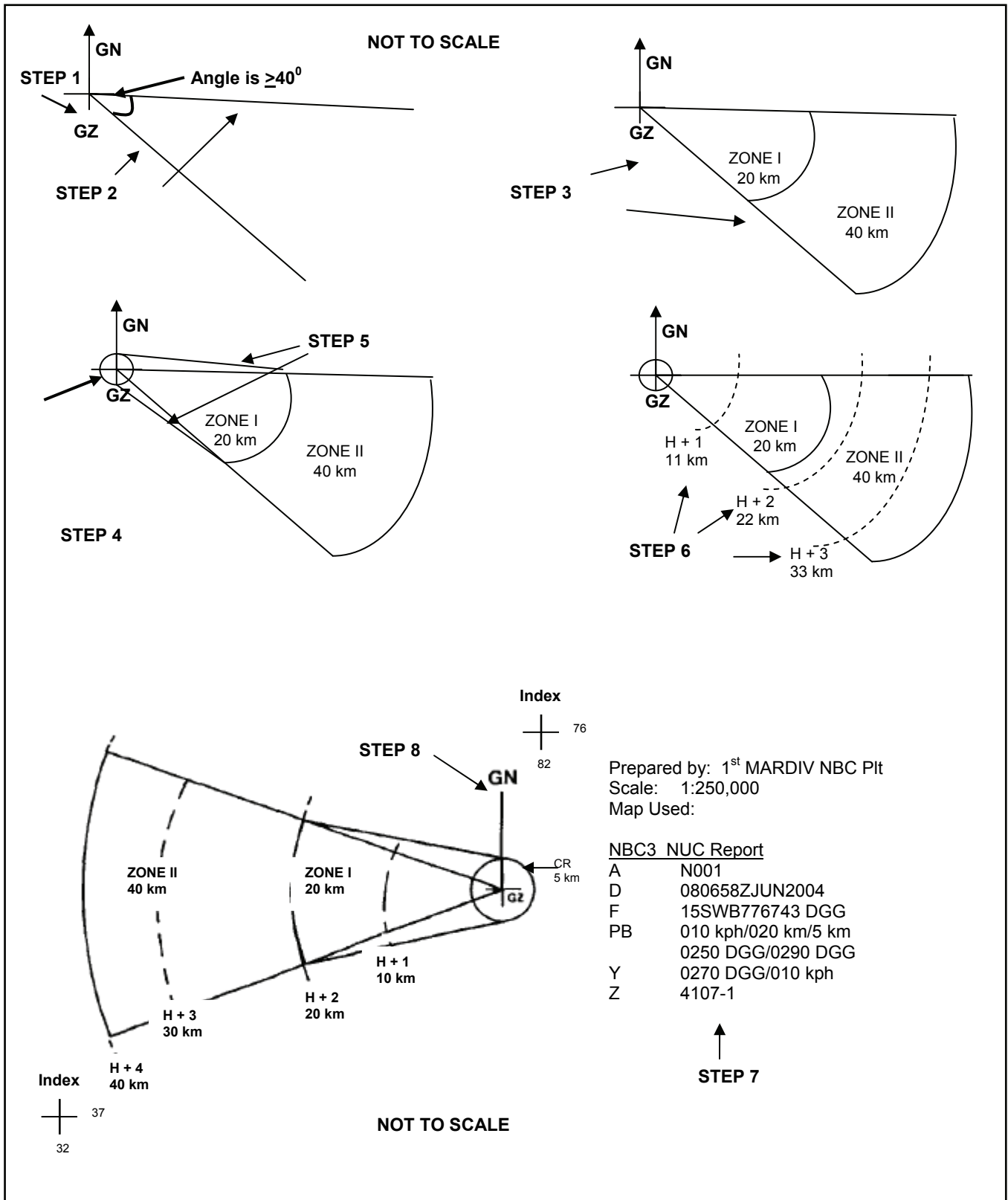

Figure G-27. Detailed Fallout Prediction

(4) Step 4. From line PAPAB, determine the size of the cloud radius (rr). Using GZ as the center, draw a circle with a radius equal to the stabilized cloud radius.

(5) Step 5. Draw tangent lines from the outer edge of the cloud radius to the points of intersection of the radial lines with the Zone I arc.

(6) Step 6. From line PAPAB, determine the EWS (sss).

(a) Beginning at GZ, draw as many dashed time-of-arrival arcs between the radial and tangent lines as will fit inside the prediction within Zones I and II.

(b) Label the dashed arcs as hours after the burst: H+1, H+2, and so on. H+1 is the closest arc to GZ.

(c) If a time-of-arrival arc coincides with a Zone I or II arc, extend the zone boundary with a dashed line.

(7) Step 7. Add marginal information to the plot. This should be all of the known information about the attack (see Figure G-28).

(8) Step 8. Orient the prediction to the map, and evaluate the hazard (see Figure G-27).

NOTE: If the NBC3 NUC report (line PAPAB) only contains Zone I (xxx), follow the steps below (see Figure G-28):

(9) Step 1. Identify the map scale to be used. Obtain a sheet of overlay paper or other transparent material. Mark a GZ. A GN line is not necessary.

(10) Step 2. The three digits shown on line ZULU is the radius of a circle for Zone I. Using the GZ as the center, draw a circle with a radius equal to the Zone I distance. Label this area Zone I. Draw a second circle at twice this radius for Zone II. Label this area Zone II.

(11) Step 3. Add marginal information to the plot. This should be all known information about the attack.

(12) Step 4. Orient the prediction to the map and evaluate the hazard.

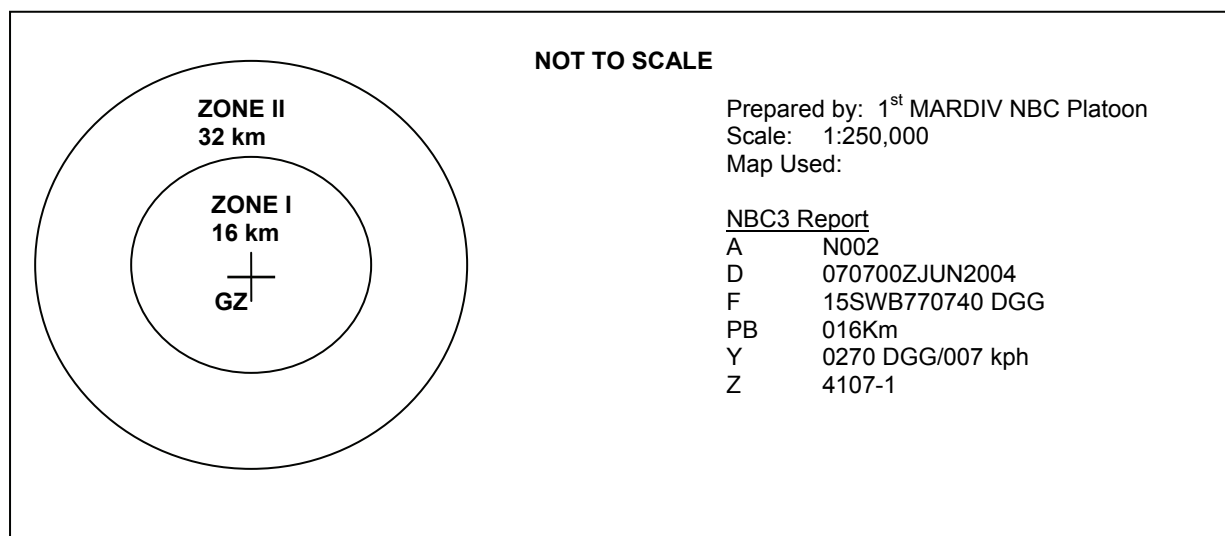

Figure G-28. Example Detailed Fallout Prediction With Wind Speed Less Than 8 kph

c. Contamination Prediction System for Merchant Ships at Sea.

(1) Significance of CBRN Warnings.

(a) Radioactive fallout from nuclear explosions on sea and land targets, particularly from the latter, may affect large areas of adjacent waters.

(b) The areas affected will depend on the prevailing wind conditions, and any ship close to or approaching these areas will be in grave danger. It is therefore essential that the ships should be warned of the fallout hazards and contamination in order that the following may occur:

- Passive-defense measures, such as switching on the wash-down systems, may be taken.
- Course may be altered to avoid the danger zones, if necessary.

(2) MERWARN System to Ships at Sea.

(a) A simplified contamination warning system has been established throughout NATO for broadcasting, via MERCOMMS and coastal radio stations, warnings of a contamination that is dangerous to merchant shipping. This system calls for the origination by NATO naval authorities.

(b) A MERWARN NBC3 NUC report will be issued after a nuclear attack producing fallout. It gives fallout data for a specific explosion or a series of explosions, which will be identified in the report. NBC3 NUC reports are issued as soon as possible after the attack and at 6-hour intervals (to the nearest hour) thereafter for as long as the fallout danger exists. They contain information that enables the ship to plot the danger area.

(c) The standard format of a MERWARN NBC3 NUC report contains lines ALFA, DELTA, FOXTROT, and PAPAB of the military NBC3 NUC report (see Appendix D for additional MERWARN information).

(d) The MERWARN NBC3 NUC report has the following structure:

- MERWARN NBC3 NUC report.

| | |
|---------|---|
| ALFA | Strike serial number (as defined by the naval authority) |
| DELTA | DTG of detonation |
| FOXTROT | Location of attack (LAT and LONG or geographical place name) |
| PAPAB | EWS (3 digits and unit of measurement), downwind distance of Zone I (3 digits and unit of measurement), cloud radius (2 digits and unit of measurement), left and right radial lines of the predicted fallout hazard area (3 digits and unit of measurement each) |

Example:

MERWARN NBC3 NUC Report
ALFA/US/NBCC/02-001/N//

DELTA/021405ZSEP1999//

FOXTROT/451230N014312E/AA//

PAPAB

/012KTS/028NM/02NM/272DGT/312DGT//

- MERWARN NBC3 NUC Report, Plain Language Format: The MERWARN NBC3 standard format may not be suitable after a multiple nuclear attack which produces fallout from several bursts in a large or complex target area. In such cases, warnings will be plain language statements of a more general nature, indicating the area affected and the expected movement of the fallout.

Example:

MERWARN NBC3 NUC Report

ALFA/UK/02-001/N//

DELTA/021405ZSEP1999//

Fallout extends from Glasgow area to eastern Ireland at 021405Z and is spreading westwards at 12 knots. Irish Sea is likely to be affected within an area of 60 nautical miles of the British coast.

(e) MERWARN Diversion Order. In addition to the origination of MERWARN NBC3 NUC messages, naval authorities may, if circumstances dictate, broadcast general diversion orders based on the fallout threat, merchant ships proceeding independently will be passed evasive routing instructions of a more general nature, using the standard naval shipping identifier MERWARN diversion order.

Example:

MERWARN Diversion Order

English Channel closed. All shipping in North Sea remain north of 052 degrees N until 031500ZSEP1999.

(3) Precedence of NBC Messages. All MERWARN NBC messages should be given the precedence FLASH (Z) to ensure the rapid handling on any military circuit between the originating authority and the MERCOMMS and/or coastal radio stations. This precedence should not be used where the rules for the use of the international safety signal (“TTT” for chemical warfare [CW] and “security” for voice circuits) apply.

NOTE: Adjacent MERWARN originators are responsible for relaying information to coast earth stations/coast radio stations under their control as necessary.

(4) Danger Zones. All shipping in waters out to 200 nautical miles from any coast at the outset of war must be regarded as an area of possible fallout danger from nuclear attacks on shore.

(5) Plotting MEWARN NBC3 NUC Report. Plot this report in the same manner as “Fallout Plotting from NAV EDM and Observations” (paragraph 6f[2]), using the ship fallout template (see Figure G-29, page G-52).

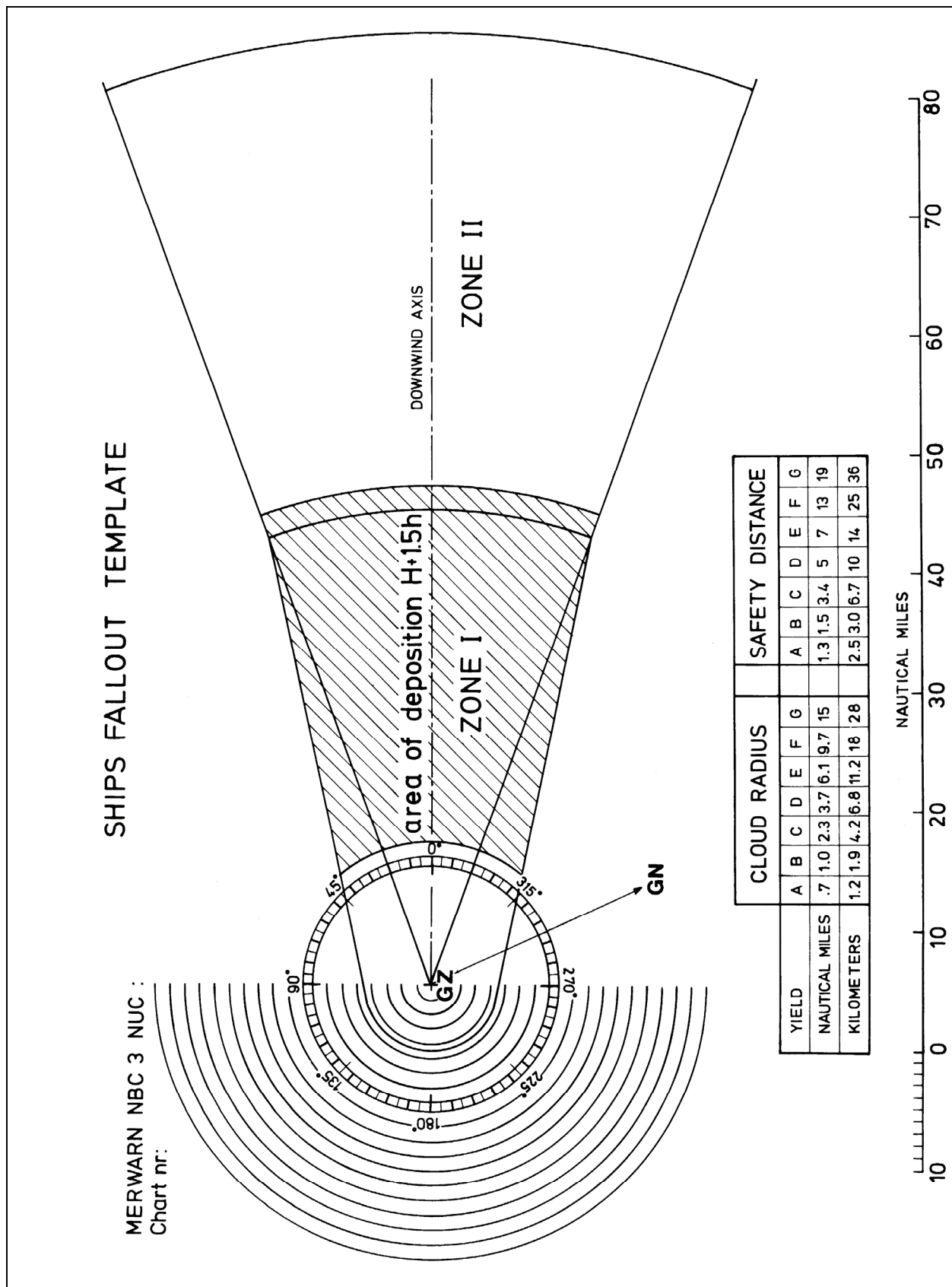

Figure G-29. Shipboard Fallout Template (Example)

d. Time of Completion of Fallout.

(1) Most contaminated particles in a radioactive cloud rise to considerable heights. Therefore, fallout may occur over a large area. It may also last for an extended period of time. A survey conducted before the fallout is complete would be inaccurate because contaminants would still be suspended in the air. For this reason (and the hazard to surveying personnel), nuclear surveys are not conducted before completion of fallout.

(2) An estimate of the time of completion (T_{comp}) of fallout for a particular location may be determined using a mathematical equation. The time (in hours) after a burst when the fallout will be completed at any specific point is approximately 1.25 times the time of fallout arrival (in hours after burst). Add the time (in hours) required for the nuclear cloud to pass over. This is expressed by using the following formula:

$$T_{\text{comp}} = (1.25 \times T_{\text{arrival}}) + \frac{(2 \times \text{cloud radius})}{\text{EWS}}$$

Example: For a given location, the following data has been determined:

- Time of detonation = H.
- Time of arrival = H+2 hours (time of arrival is determined by dividing the distance from GZ to the given point by the EWS).
- Cloud diameter = 4 km (2 x cloud radius) (cloud diameter/radius [rr] is determined from Figure G-20, page G-39, or from line item PAPAB of the NBC3 NUC report).
- EWS = 20 kph (EWS [sss] is determined from Figure G-19, page G-38, or from line item PAPAB of the NBC3 NUC report).

$$T_{\text{comp}} = (1.25 \times 2 \text{ hr}) + \frac{4 \text{ km}}{20 \text{ kph}}$$

$$T_{\text{comp}} = 2.5 \text{ hr} + 0.2 \text{ hr}$$

$$T_{\text{comp}} = 2.7 \text{ hr}$$

Therefore, fallout for the given location is expected to be complete by H+2.7 hours.

NOTE: To convert 2.7 hours into clock time, multiply 0.7 by 60. The product in this example is 42. Therefore, T_{comp} is 2 hours and 42 minutes.

(3) The actual completion of fallout can be determined if a peak NBC4 NUC report is received from the AOI. For detailed information regarding nuclear reconnaissance, monitoring, and survey, refer to *Multiservice Tactics, Techniques, and Procedures for Nuclear, Biological, and Chemical Reconnaissance*.

8. NBC4 NUC Report

The NBC4 NUC report is a key tool used by units to define the type and extent of the contamination.

a. Locating and Reporting Nuclear Contamination.

(1) Fallout predictions provide a means of defining possible areas of a nuclear contamination. Militarily significant fallout is expected to occur only within the predicted area. However, the prediction does not indicate exactly where the fallout will occur or what

the dose rate will be at a specific location. Rainout or washout can also increase nuclear contamination on the ground, creating local hot spots. Areas of neutron-induced radiation can also be caused by low air bursts.

(2) Before planning operations in a nuclear environment, commanders must be aware of these residual contamination hazards. The information required for such planning is derived from the equations and nomograms given in the following sections and in Appendixes J and K. The basic information needed is contained in NBC4 NUC reports. They provide information on the actual measured contamination in the form of dose rates.

b. Message Precedence. All other messages, after the initial NBC1 NUC report has been sent, should be given a precedence, which reflects the operational value of the contents. Normally, IMMEDIATE would be appropriate (see Figure G-30 for a sample NBC4 NUC report).

| NBC4 NUC Report | | | |
|-----------------|---|-------|-----------------------------|
| Line Item | Description | Cond* | Example |
| ALFA | Strike serial number | O | ALFA/US/A234/001/N// |
| KILO | Crater description | O | KILO/UNK// |
| QUEBEC | Location of reading/sample/detection and type of sample/detection | M | QUEBEC/32VNJ481203/GAMMA-// |
| ROMEO | Level of contamination, dose rate trend and decay rate trend | M | ROMEO/7CGH/DECR/DN// |
| SIERRA | DTG of reading or initial detection of contamination | M | SIERRA/202300ZSEP1997// |
| WHISKEY | Sensor information | O | WHISKEY/POS/POS/YES/HIGH// |
| YANKEE | Downwind direction and downwind speed | M | YANKEE/270DGT/015KPH// |
| ZULU | Actual weather conditions | O | ZULU/4/10C/7/5/1// |
| GENTEXT | General text | O | - |

*The Cond column shows that each line item is operationally determined (O) or mandatory (M).

Figure G-30. Sample NBC4 NUC Report

(1) The location is sent as UTM or LAT/LONG grid coordinates; the level of contamination reading is expressed in cGy/h.

(2) Lines QUEBEC, ROMEO, and SIERRA may be repeated as many times as necessary to give a specific picture of the contamination throughout an area. A zero dose rate may also be reported on line ROMEO, and it is an extremely valuable piece of information in determining the extent and duration of the contamination.

(3) Only outside unshielded dose (OD) rates are reported by the unit, and the DTG is reported in Zulu time. Certain abbreviations are associated with the dose rate to describe the circumstances surrounding the contamination. Note that the definition of line

ROMEO includes information on the dose rate trend and the relative or actual radiation decay rate. The dose rate must be reported, while the latter two items are optional. They require evaluation, which may be done above unit level. A monitor cannot provide this information.

c. **Shielding.** Shielding reduces the effects of gamma radiation on personnel and equipment. The denser the material is, the better the shield. Low-density materials are as effective as higher-density materials when the total thickness of the low-density material is increased. It is not possible for gamma radiation to be completely absorbed. However, if enough material is placed between the individual and the radiation source, the dose rate can be reduced to negligible proportions.

(1) **Shielding Principles.**

(a) **Density.** Density is defined as the number of molecules or mass per unit of volume.

(b) **Half-Thickness.** This is the amount of material required to reduce the dose rate by one-half. See Table G-2 for selected half-thicknesses.

Table G-2. Half-Thicknesses ($X \frac{1}{2}$) of Materials

| Material | Half-Thickness (Inches) |
|-----------------|--------------------------------|
| Steel | 0.7 |
| Concrete | 2.2 |
| Earth | 3.3 |
| Wood | 8.8 |

(c) **Total Thickness.** This is the actual thickness of the shielding material.

(d) **Position of the Shield.** The closer the shield is to the source, the better.

(e) **Dose Rate Buildup.** The dose rate buildup is produced by the shield. The shield causes radiation to scatter; therefore, the closer to the shield, the higher the dose rate.

(2) **Shielding Materials.**

(a) **Earth.** Earth is the most common shielding material. About 1 foot of earth makes an adequate shield.

(b) **Concrete.** About 6 to 8 inches of concrete makes a good shield.

(c) **Steel.** Tanks and amtracks are very good shields against radiation.

(d) **Buildings.** Wood or brick buildings make good shields.

(3) **Effectiveness.** The effectiveness of a given material in decreasing radiation intensity is measured in units of half-value layer thickness (half-thickness). This unit is defined as the thickness of any material which reduces the dose rate of gamma radiation to one-half its unshielded value.

NOTE: If personnel are surrounded by a 6-inch concrete wall (half-thickness) and the gamma radiation outside is 200 cGy/h, they would receive gamma radiation at the rate of 100 cGy/h. The addition of another 6 inches reduces the rate to 50 cGy/h. Each succeeding half-thickness of concrete would reduce the radiation.

d. Measuring Nuclear Data.

(1) Measurements of nuclear data must be taken in accordance with the unit SOP. Measurements can be taken directly from an unshielded position if dose rates are low enough or from a shielded position, such as a shelter or vehicle.

(2) When the indirect technique is used, most of the readings are taken inside the vehicle or shelter. However, at least one outside reading is necessary to determine the TF, which relates the readings inside to the unshielded values outside. The latter readings are to be reported since they are necessary for further calculations pertaining to troops in the open or other vehicles or shelters.

(3) To determine the TF, both the inside and outside readings must be taken after fallout is complete. Calculate the TF using the following formula:

$$TF = \frac{\text{inside shielded dose (ID) rate}}{\text{OD rate}}$$

NOTE: The TF is always less than 1. It can be determined from the measurement of the dose.

(4) The readings taken inside the vehicle or shelter represent the ID. These readings must be converted to OD before reporting. Readings are converted using the following formula:

$$OD = ID / TF$$

(5) A precalculated list of TFs is contained in national manuals, an example of which is shown in Table G-3. This information is not used by unit CBRN defense personnel when calculating or reporting OD rates. Its principal use is to establish the relative shielding ability of one shelter, structure, or vehicle as compared to another. It is also used for instructional and practice purposes.

(6) These factors are for the most exposed, occupied location. They are not based on dose rates from fallout; they are based on gamma radiation from cobalt-60. Since cobalt-60 radiation is almost twice as strong as the radiation from fallout, the actual TF should be much lower (more protection).

(7) In some cases the term CF is used. It is always the reciprocal of the TF. The formula to convert a TF to a CF is:

$$CF = \frac{1}{TF} = \frac{OD}{ID}$$

Table G-3. TFs and CFs

| Environmental Shielding | TF | CF | Environmental Shielding | TF | CF |
|--|------|-------|--|---------------|-----------------|
| Vehicles | | | Engineer Equipment | | |
| M1 tank | 0.04 | 25.00 | M9 ACE | 0.3 | 3.33 |
| M48 tank | 0.02 | 50.00 | Grader | 0.8 | 1.25 |
| M60 tank | 0.04 | 25.00 | Bulldozer | 0.5 | 2.00 |
| M2 IFV | 0.20 | 5.00 | Scraper | 0.5 | 2.00 |
| M3 CFV | 0.20 | 5.00 | Structures | | |
| M93 NBC reconnaissance vehicle | 0.20 | 5.00 | Frame house | 0.30–0.8 | 3.33–1.25 |
| M113 armored personnel carrier | 0.30 | 3.33 | Basement | 0.05–0.1 | 20.00–10.00 |
| M109 self-propelled howitzer | 0.20 | 5.00 | Multistory Building (Apartment Type) | | |
| M548 cargo vehicle | 0.70 | 1.43 | Upper stories | 0.01 | 100 |
| M88 recovery vehicle | 0.09 | 11.11 | Lower stories | 0.10 | 10 |
| M577 command post carrier | 0.30 | 3.33 | Concrete Blockhouse Shelter | | |
| M551 armored reconnaissance airborne assault vehicle | 0.20 | 5.00 | 9-in walls | 0.007–0.090 | 142.86–11.11 |
| M728 combat engineer vehicle | 0.04 | 25.00 | 12-in walls | 0.0001–0.03 | 10,000.00–33.33 |
| Helicopters (Parked) | | | 24-in walls | 0.0001–0.0020 | 10,000–500 |
| OH-58 | 0.8 | 1.25 | Shelter, Partly Above Ground | | |
| UH-60 | 0.7 | 1.43 | With 2-ft earth cover | 0.005–0.020 | 200–50.00 |
| CH-47 | 0.6 | 1.67 | With 3-ft earth cover | 0.001–0.005 | 1,000.00–200.00 |
| Trucks | | | Urban areas (in open) | *0.7000 | 1.43* |
| HMMWV | 0.5 | 2.00 | Woods | *0.8000 | 1.25* |
| ¼-ton | 0.8 | 1.25 | Underground shelters (3-ft earth cover) | 0.0002 | 5,000.00 |
| ¾-ton | 0.5 | 2.00 | Foxholes | 0.1000 | 10.00 |
| CUCV | 0.5 | 2.00 | * These factors apply to aerial survey dose rates. | | |
| 2½-ton | 0.5 | 2.00 | | | |
| 4-ton to 7-ton | 0.5 | 2.00 | | | |
| NOTE: For vehicles in which AN/VDR2s have been installed, the users need only verify that the correct attenuation factor (equivalent to the CF) has been entered and then read the OD directly off the display. | | | | | |

e. Surveys.

(1) Air-Ground Correlation Factors (AGCFs). An AGCF is required for calculating surface dose rates from aerial dose rates taken in an aircraft during a survey. The AGCF relates a ground dose rate reading to a reading taken at approximately the same time in an aircraft at survey height over the same point on the surface.

(2) The AGCF is calculated as shown below:

$$\text{AGCF} = \frac{\text{ground dose rate}}{\text{aerial dose rate}}$$

Example: $\frac{\text{surface dose rate}}{\text{aerial dose rate}} = \frac{20 \text{ cGy/h}}{5 \text{ cGy/h}}$

(200 feet survey height)

$$\text{AGCF} = \frac{20 \text{ cGy/h}}{5 \text{ cGy/h}}$$

$$\text{AGCF} = 4$$

(3) By multiplying the readings taken in the aircraft at a survey height by the AGCF, the surface level reading can be approximated. These values are to be reported in the NBC4 NUC report. The formula to determine ground dose rate is:

$$\text{Ground dose rate} = \text{Air dose rate} \times \text{AGCF}$$

f. Reporting Instructions. Monitoring data to be sent to other units/HQ is transmitted as an NBC4 NUC report.

(1) Automatic Reports. According to the SOPs, units in the contaminated area submit certain monitoring reports automatically. These provide the minimum essential information for warning, hazard evaluation, and survey planning. Reports are sent through specified channels to reach the CBRN cell. The automatic reports are the initial, peak, and special reports specified by the CBRN cell or required by commanders for operational purposes.

(2) Initial Report. After noting a dose rate of 1 or more cGy/h outside, defensive measures according to the SOPs are implemented and the unit formats an NBC4 NUC report (Figure G-31) containing the code "INIT" (for initial) in line ROMEO. The first report is used at the CBRN cell to confirm the fallout prediction. The dose rate cannot be converted to H+1 at this time.

| | | |
|----------------------------|----------------------------|----------------------------|
| NBC4 NUC | NBC4 NUC | NBC4 NUC |
| QUEBEC/32UNB156470/GAMMA// | QUEBEC/32UNB156470/GAMMA// | QUEBEC/32UNB156470/GAMMA// |
| ROMEO/1CGH/INIT// | ROMEO/35CGH/PEAK// | ROMEO/25CGH/DECR// |
| SIERRA/021200ZAUG2005// | SIERRA/021400ZAUG2005// | SIERRA/021530ZAUG2005// |

Figure G-31. Sample NBC4 NUC Reports

(3) Peak Report. After the initial contamination is detected, the unit monitor continuously records dose rates according to the time intervals specified in unit SOP. The dose rate rises until it reaches a peak, and then it decreases. In some cases, the dose rate

may fluctuate for a short time before beginning a constant decrease. When the measurement continues to decrease, the monitor takes an inside reading and then an outside reading for the TF calculation. First, the inside reading is recorded. Within 3 minutes, the monitor goes to the outside location. After all information is recorded, the CBRN defense team calculates the TF and applies it to the highest dose rate. It then formats the NBC4 NUC report. The word "PEAK" is used in line ROMEO.

(4) Special Reports. Other standing instructions may establish the requirement for special NBC4 NUC reports. The CBRN cell evaluates these special reports and invites command attention to areas or conditions of serious concern. The operational situation, unit radiation status, and similar considerations determine the criteria for special reports, which cannot be specified here. Generally, this report may be required when the surface dose rate goes above a specified value. When the dose rate increases after showing continuous decrease, a special report must be sent. Special reports may be required after a specified period of time if the unit remains in the area.

(5) Directed Reports. Selected units in the contaminated area will be directed to submit additional NBC4 NUC reports. The CBRN cell uses these reports to evaluate a nuclear-contamination hazard, the decay rate of fallout, and how long the decay rate (and the contamination overlay) will remain valid. They are used to determine the H-hour (if unknown) and the soil type in neutron-induced areas. Reliable calculations are directly related to the precision of the dose rate measurement. Tactical decisions and personnel safety depend on the accuracy of these measurements. The assessment of further development of the contamination situation depends on this data. An error in dose rate measurements means a similar error in all following calculations.

(6) Series Reports. A series report consists of a series of dose rate readings taken at the same location at time intervals specified in the unit SOP after the peak dose rate has been recorded. The location must remain constant. The report contains each reading and the time it was taken. The report contains the word "series" in line GENTEXT.

(7) Summary Reports. The summary report shows the radiation distribution throughout the unit AOR. The locations for the readings are selected by the unit according to the distribution of its elements and the extent or variety of the area terrain. The time each reading was taken is reported. The word "summary" is given in line GENTEXT.

(8) Verification Reports. The verification report is a unit response to a direct request. If data are lacking from a specific location near or in the unit area, the CBRN cell may request a verification report. It may also be requested to confirm abnormal readings reported earlier. A verification report is not a retransmission of the earlier report, but a check of the actual conditions of the area. The unit tasked with the submission of a verification report receives specific instructions as to the location from which a reading is desired. The word "verify" is used in line GENTEXT to indicate a verification report.

(9) Trends. Dose rate trends are—

- (a) INIT—initial reading
- (b) PEAK—peak reading
- (c) DECR—decreasing since last reading
- (d) INCR—increasing since last reading
- (e) SAME—same

9. Evaluation of Nuclear Information

After the NBC4 NUC reports are available, they must be evaluated with regard to the actual hazard encountered by the troops. The aim is to predict the expected dose rates and accumulated dosages for possible missions within the contaminated area. Theoretically, once a nuclear hazard has been identified, the contamination existing at any future time can be calculated using simple decay relationships and other calculations. The following calculations are shown below:

- Calculation of H hour.
 - Decay of fallout.
 - Decay rate (n).
 - Validity time for decay rate (Tp).
 - Normalization factor (NF).
 - Overall correction factor (OCF).
- a. Calculation of H hour or Time of Burst (TOB). Calculate H hour mathematically, using the following procedures:

- Step 1. Set up the formula as follows:

T_1 = Time after H hour at which reading R_a was made.

T_a = Time peak reading was measured.

T_b = Time last reading was measured.

$T_b - T_a$ = interval between readings R_a and R_b .

R_a = Peak reading.

R_b = Last reading.

n = Decay rate.

$$T_1 = \frac{T_b - T_a}{(R_a/R_b)^{1/n-1}}$$

- Step 2. Place known values in the formula.
- Step 3. Divide 4.75 by 3.06 and $T_1 = 1.55$.

b. Fallout Determination of Decay. The dose rate at any location in a fallout area does not remain constant. It decreases with time according to the Kaufmann equation, which describes the decay of fallout after it has completely settled to the ground. Where—

R_2 = Dose rate at the location at the time of reading.

R_1 = Dose rate (normalized to H+1) at the location.

t_1 = H+1.

t_2 = Time, in hours, after H hour that R_2 was measured.

n = Decay rate.

- The dose rate and total dose calculations cannot be performed until the decay rate is known. The true decay rate will not be known immediately. Accurate determination must wait until several sets of NBC4 NUC reports are available.

- The decay rate of fallout depends on many factors. These factors include the following:

- Height and type of burst.

- Type of weapon (fission, fission-fusion, or fission-fusion-fission).

- Type of active materials, construction, and structural materials within the weapon.

- Type and quantity of materials vaporized or sucked up into the fireball.

- “Salting” the weapon to produce a slow decay.

- When fallout overlaps fallout.

- Soil type.

- The decay rate varies with time. Generally, the decay rate becomes slower as time passes.

- The same decay rate may not be present across the entire fallout area. The pattern, as a whole, will have an average value, which may vary from position to position. The amount of variation in the decay rate for fallout is expected to range from 0.2 to 2.0. The lower values are assumed for “salted” weapons.

- Decay calculations are valid only if the dose rate readings are made after the completion of fallout. While fallout is still arriving, the Kaufmann equation is not valid.

- Because of the delay in determining the actual decay rate, an assumed decay rate of $n = 1.2$, referred to as standard decay, is used by all units until informed otherwise by the CBRN cell. When the actual decay rate has been established by the CBRN cell, it will be sent as line ROMEO on the NBC4 or NBC5 NUC report. The assumed normal decay rate of $n = 1.2$ is used in many simplified nuclear calculation procedures. The optimum time of exit calculations are also based on $n = 1.2$.

NOTE: In the equations of the following sections, all times are given in hours after the burst. The information given in corresponding line items of the CBRN messages (e.g., SIERRA) must be converted appropriately when moving from calculation to reporting or vice versa.

c. Determination of Decay Rate.

(1) 7:10 Rule. For every seven-fold increase in time, radiation will decay by a factor of 10.

(2) Standard Decay ($n = 1.2$). When no decay rate is given or there is no way to determine a decay rate, the standard decay rate of 1.2 will be used by the control center in their computations.

(3) Nonstandard Decay (n does not equal 1.2). Anything other than 1.2 is considered nonstandard. Decay rates greater than 1.2 decay faster than standard. Decay rates less than 1.2 decay slower than standard.

(4) Decay Constant (Rate, Exponent) (n). The decay rate (n) is a changing factor we must adjust to throughout CBRN operations. It changes as short-lived fission products die off, with the rate slowing down as time goes on. The decay rate may not be the same from pattern to pattern or from one location to another within the same pattern. There are two methods of determining the decay rate—pocket calculator and graphical. The following steps utilize the calculator method. The Kaufmann equation is the preferred method of determining the decay rate. A scientific calculator is required.

(a) Step 1. From the report, determine the R_a , R_b , T_a , and T_b .

Where—

R_a = Peak dose rate (cGy/h) measured.

R_b = Last measured dose rate (cGy/h) available on the report.

T_a = Time in hours (after H hour) that R_a was measured.

T_b = Time in hours (after H hour) that R_b was measured.

(b) Step 2. Set up the formula as follows:

$$n = \frac{\log(R_a/R_b)}{\log(T_b/T_a)}$$

(c) Step 3. Place known values in the formula.

NOTE: Information was provided from the nuclear data sheet.

$$n = \frac{\log(R_a/R_b)}{\log(T_b/T_a)} = \frac{\log(52/17)}{\log(9/3)} = \frac{\log(3.059)}{\log(3.000)} = \frac{0.486}{0.477} = 1$$

(d) Step 4. Solve for n . The decay rate is rounded to the nearest single decimal place (tenth).

d. Period of Validity for the Decay Rate (n). The period of validity is a mathematical calculation that determines how long the decay rate is valid due to the various aspects discussed earlier regarding the decay of fallout. The period of validity is calculated as follows:

(1) Step 1. From the series report, determine the T_a and T_b . Where—

T_p Period of validity decay rate (n).

3 Constant.

T_a Time in hours (after H hour) that R_a was measured.

T_b Time in hours (after H hour) that R_b was measured.

(2) Step 2. Set up the formula as follows:

$$T_p = 3(T_b - T_a) + T_b$$

(3) Step 3. Place known values in the formula.

(4) Step 4. Solve for T_p .

$$TOB = 090400Z$$

$$T_p = + \underline{24}$$

$$092800 = 100400Z \text{ (DTG)}$$

Example: Given TOB = 010100ZJUN2004, $T_a = 9$, and $T_b = 3$.

NOTE: Information was provided from the nuclear data sheet.

$$T_p = 3(T_b - T_a) + T_b$$

$$T_p = 3(9 - 3) + 9$$

$$T_p = 3(6) + 9$$

$$T_p = 18 + 9 = 27 \text{ hours}$$

$$T_p + TOB = 27 \text{ hours} + 010100ZJUN2004 = 020400ZJUN2004$$

(5) Step 5. Add the T_p value to the TOB. This will give the DTG of when n is no longer valid.

e. Normalizing Factor (NF).

(1) Once the decay rate (n) is determined, the nuclear reading may be normalized to H+1 readings. This normalized reading is commonly referred to as the R_1 reading. Simply stated, it is mathematically determining what the dose rate reading was at any given location 1 hour after the burst.

(2) Survey teams and monitors take readings at various times after the burst. These readings may be 15 minutes or 10 hours after the burst. Any reading that is not recorded 1 hour after a burst (H+1) is commonly referred to as an R_t reading. To perform nuclear calculations and make decisions on the nuclear battlefield, all readings must be represented using the same time reference.

(3) To determine the NF, use the following steps:

(a) Step 1. From the NBC4 NUC report or nuclear data sheets, determine the decay rate, dose rate reading, and time measured of the reading you desire to be normalized to H+1. When normalizing readings from ground survey reports, you must use midtime for your computations. Midtime is simply the middle time between the beginning and end of the ground survey. For example, if a survey starts at 1030 and ends at 1100, the midtime for calculating the NF is 1045.

(b) Step 2. Set up the formula as follows:

$$R_1 = NF \times R_2$$

$$NF = (T_2)^n$$

- R_1 = Normalized dose rate reading at H+1.
 R_2 = Dose rate reading at any other time.
 NF = Normalization factor.
 T_2 = Time reading taken, in hours, after the burst.
 n = Decay rate.

(c) Step 3. Solve for NF.

Example: A peak dose rate of 100 cGy/h was measured at H+2 in a fallout area where the decay rate is 1.2. Normalize the dose rate to a reference time of H+1.

Solution:

Calculate $NF = (T_2)^n$

$$NF = 2^{1.2} = 2.30 \text{ (2.297 rounded to the nearest hundredth)}$$

Calculate $R_1 = NF \times R_2$

$$R_1 = 2.30 \times 100 \text{ cGy/h} = 230 \text{ cGy/h (normalized dose rate reading at H+1)}$$

f. Outside Correlation Factor (OCF). When calculating survey data, combining the NF and CF reduces the number of required calculations. This additional step is called the OCF. To compute the OCF, use the following steps:

- The OCF formula is—

$$\text{Aircraft: } NF \times AGCF = OCF$$

$$\text{Vehicle: } NF \times VCF = OCF$$

- The OCF is rounded to the nearest hundredth.
- The OCF is used instead of the NF. The OCF will convert shielded readings to unshielded readings normalized to H+1. Multiply the OCF by the dose rate reading. This unshielded H+1 reading (R_1) is always rounded to the nearest whole number and written in the “Do Not Use” column of the nuclear data sheet.

10. NBC5 NUC Report

The NBC5 NUC report (Figure G-32) is a vital part of ensuring that the COP is maintained. It provides information vital to the commander.

a. Purpose. The NBC5 NUC report is used to pass along information on areas of actual contamination. This report can include areas of possible contamination, but only if actual contamination coordinates are included in the report.

b. Message Precedence. All other messages, after the initial NBC1 NUC report has been sent, should be given a precedence, which reflects the operational value of the contents. Normally, IMMEDIATE would be appropriate.

| NBC5 NUC Report | | | |
|--|--|-------|---|
| Line Item | Description | Cond* | Example |
| ALFA | Strike serial number | O | ALFA/US/A234/001/N// |
| DELTA | DTG of attack or detonation and attack end | O | DELTA/201405ZSEP2005// |
| OSCAR | Reference DTG for estimated contour lines | M | OSCAR/201505ZSEP2005// |
| XRAYA* | Actual contour information | M | XRAYA/5CGH/32UND620475/ 32UND662522/32UND883583/ 32UND830422/32UND620475// |
| XRAYB* | Predicted contour information | O | XRAYB/75/100CGH/32UND621476/ 32UND621477/32UND622477/ 32UND622476/32UND621476// |
| YANKEE | Downwind direction and downwind speed | O | YANKEE/270DGT/015KPH// |
| ZULU | Actual weather conditions | O | ZULU/4/10C/7/5/1// |
| GENTEXT | General text | O | - |
| *The Cond column shows that each line item is operationally determined (O) or mandatory (M). | | | |

Figure G-32. Sample NBC5 NUC Report

c. Plotting Data and Producing an NBC5 NUC Report.

(1) Contaminated areas are shown on the nuclear contamination situation map, and information about them must be passed to other units and HQ. The most expeditious means for this is the nuclear contamination overlay.

(2) The preparation of such an overlay is described below:

(a) After all available information from monitoring and surveying has been plotted on a map as normalized (H+1, unshielded ground dose rates [R₁]), contour lines for the standard dose rates can be drawn on a nuclear contamination overlay.

(b) When constructing the nuclear contamination overlay, there are factors that locally affect the contamination pattern.

(c) This is particularly true between points in an aerial survey. These include topographic features, such as bluffs or cuts, heavily built-up or wooded areas, and bodies of water. For example, a large river will carry away any fallout landing in it, leaving its path relatively free of contamination. Also, the contamination hazard near a lake will be lower than expected. The fallout particles will sink to the bottom of the lake, and the water

will provide shielding. In wooded or built-up areas, a measure of the reduction of dose rate can be obtained by using the TFs (see Table G-3, page G-57) for these areas.

(d) Dose rate contour lines showing the contamination hazard in an area can be drawn as follows: Count the number of readings taken for the route or leg. Since the aircraft flew at a constant ground speed, taking readings at equal time intervals, the distance covered between any two consecutive readings will be the same. If the route or leg is divided into a number of equal-length segments, the total number of segments will equal the number of time intervals. Each division point on the route or leg will represent a location over which a dose rate reading was taken. The interval between readings equals the length of the course leg or route divided by the number of readings, minus one. For example, if seven readings are taken, the route is divided into only six segments—one less than the number of readings taken by the survey party. The formula is:

$$\text{Interval Distance} = \frac{\text{Route or Course Leg Distance (km)}}{(\text{Number of Readings} - 1)}$$

- Determine the H+1 dose rate contour lines to be plotted (e.g., 20 [30 for NATO], 100, 300, 1,000 cGy/hr). These contour lines may be required for NBC5 report purposes or for anticipated calculations to be made from the data.

1,000 cGy/h = Plotted in red.

300 cGy/h = Plotted in green.

100 cGy/h = Plotted in blue.

20 cGy/h = Plotted in black. (NATO forces use a 30 cGy/h line.)

- Determine the points on the chosen survey routes or on course legs and close to monitoring locations that are providing the desired dose rates.

- Connect all the points having the same dose rates with a smooth line. Use all plotted monitoring data as additional guides in constructing these contours.

- Use care and judgment in plotting these contours and visualize the probable general shape and direction of the pattern. Any dose rates disproportionately higher than other readings in the immediate area indicate possible hot spots. When such readings are reported, that area should be rechecked. If dose rates are confirmed, these hot spots should be plotted and clearly identified. Figure G-33 shows a typical plot that might be developed from survey data.

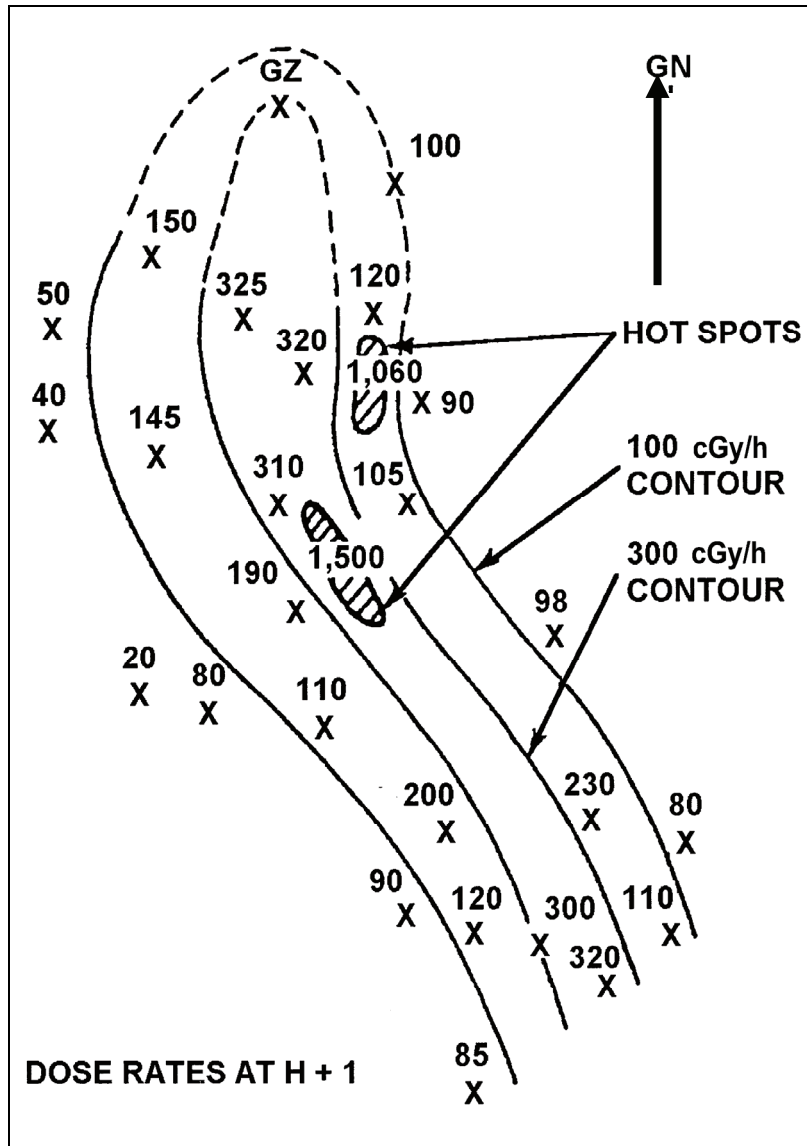

Figure G-33. Sample Fallout Pattern Plotted From Survey Data

• The nuclear contamination overlays (Figure G-34, page G-68) that are used for evaluation purposes must provide the most detailed information possible. The minimum information required is—

- Map designation and orientation data.
- Nuclear burst and GZ identification (lines ALFA and FOXTROT of the NBC2 NUC report).
- H hour (line DELTA of the NBC2 NUC report).
- Reference time (line OSCAR of the NBC5 NUC report).
- Decay rate/soil type.
- Time of preparation and validity time.

—Source of the contamination fallout or neutron-induced contamination.

—Standard dose rate contour lines.

—Additional information, such as the time of completion lines for fallout, may also be included where the unit SOPs require such information.

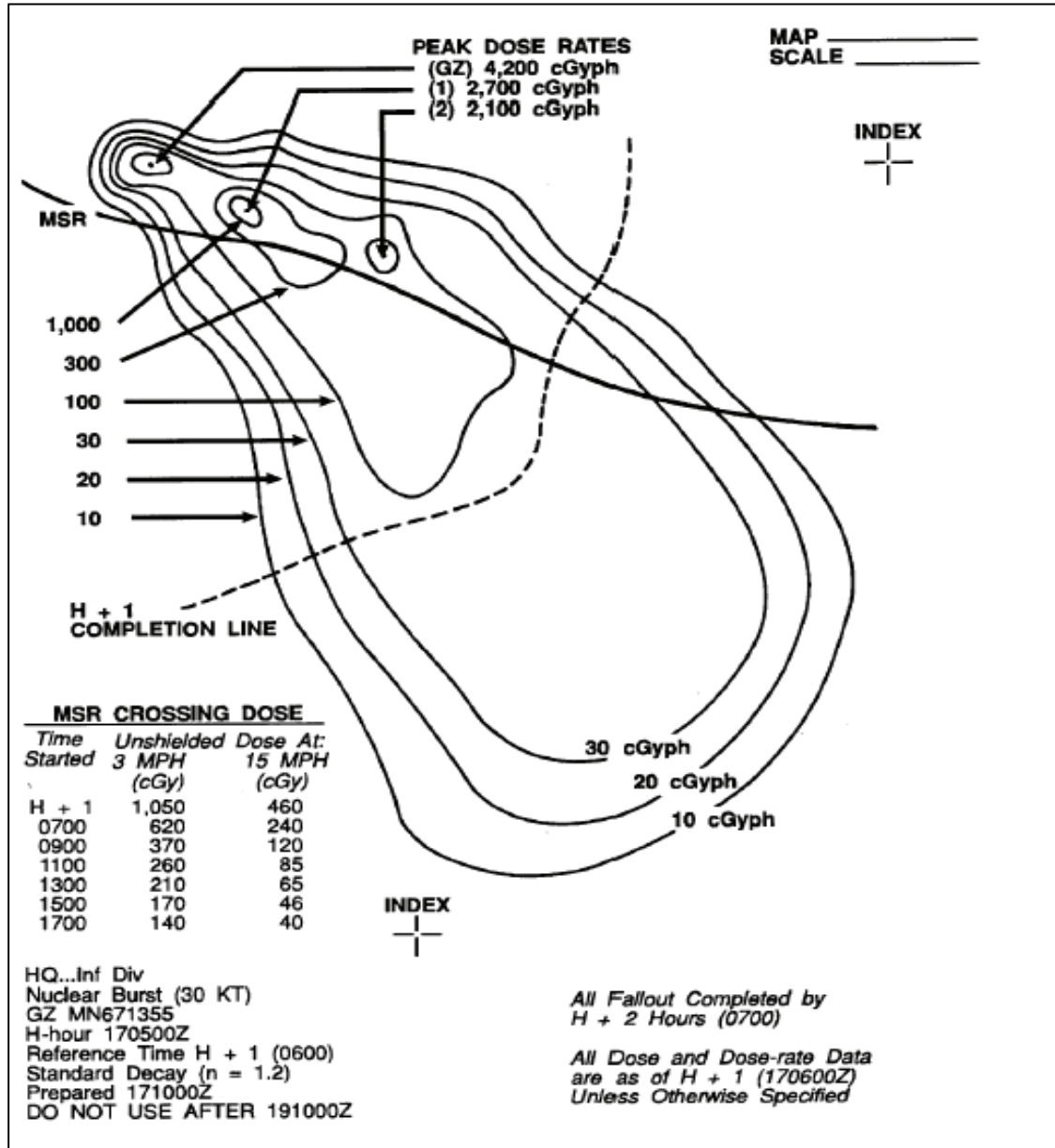

Figure G-34. Sample NBC5 NUC Contamination Overlay

d. Reporting Data.

(1) Electronic communications are not always available. If this is the case, the nuclear contamination overlay must be converted into a series of readings and coordinates for transmission as an NBC5 NUC report. This method has a disadvantage. It requires the addressee to replot the data from the NBC5 NUC report and connect them to produce dose

rate contours, which is a time-consuming process. Staff planners must consider that the shapes of dose rate contours drawn to correspond with a relatively brief series of readings and coordinates can vary significantly.

(2) If electronic communications of the data or communications of the hard copy are not available and if time and distance permit, nuclear contamination overlays are sent by messenger. Data is transmitted manually by the NBC5 NUC report as a last resort.

(3) When the contamination comes from a single burst, the dose rates will be normalized to H+ 1. But if there have been several detonations at different times and no single H+ 1 is possible, the dose rates are reported for a specific time.

(4) On the NBC5 NUC report, a closed contour line on a plot is represented by repeating the first coordinate.

(5) To calculate the dose rates along the contour lines at a later time, use the procedures described in paragraph 10e below and label the contour lines accordingly.

e. Determining the Dose Rate for an Arbitrary Time. The Kaufmann equation can be used as follows:

$R_1 \times T_1^n = R_2 \times T_2^n$ can be mathematically changed to represent the missing (or objective) variable to read: $R_2 = R_1 / (t_2)^n$ or $R_2 = R_1 / NF$.

(1) In this equation—

R_2 = Dose rate at the location at the arbitrary time.

R_1 = Dose rate (normalized to H+1) at the location.

t_1 = H+1.

t_2 = Arbitrary time, in hours, after H hour.

n = Decay rate.

NF = Normalization factor.

NOTE: If R_1 is the normalized dose rate reading at H+1, then t_1 will always be 1. Therefore the equation can be set up as follows:

Dose rate reading at H+1 is 600 cGy/h. Determine the dose at H+12. The decay rate is 1.0.

$R_1 = 600 \text{ cGph}; t_1 = 1 \text{ hr}; t_2 = 12 \text{ hr}; n = 1$

(a) Step 1. Set up the formula.

$R_2 = R_1 / (t_2)^n$ or $R_2 = R_1 / NF$

(b) Step 2. Work the problem.

$R_2 = 600 / (12)^{1.0}$ or $R_2 = 600 / 12$

$R_2 = 600 / (12)$ or $R_2 = 50 \text{ cGy/h}$

$R_2 = 50 \text{ cGy/h}$

(2) The NF graphs found in Appendix J can be utilized to determine the NF for a given time if using the $R_2 = R_1 / NF$ formula only if less than H+12 hours after the burst.

(a) Step 1. Determine the time (in hours and minutes) after the burst that the reading was taken (12 hours).

(b) Step 2. Enter the appropriate figure in Appendix J with the time after burst. Read across to the appropriate decay exponent column, and find the NF (12 hours down and 1.0 across (decay rate down is 12.000)).

(c) Step 3. Divide the dose rate reading by the NF. The product is the arbitrary time dose rate reading ($600 / 12 = 50$ cGy/h).

(3) The decay rate nomograms found in Appendix J can also be used to determine the dose rate at an arbitrary time.

(a) Step 1. Set up a table to properly record the information in the problem.

| R_2 | t_2 | R_1 | n |
|-------|-------|-----------|-----|
| ? | 12 hr | 600 cGy/h | 1.0 |

(b) Step 2. Find the nomogram for fallout decay using a decay rate (n) of 1.0 (see Figure G-35).

(c) Step 3. Align the hairline on the value of 600 cGy/h on the far right-hand R_1 column. Lay the hairline across 12 in the Time column.

(d) Step 4. Holding the hairline straight and steady, read the value in the far left-hand R_t column (R_t is the same as R_2). This answer should be approximately 50 cGy/h.

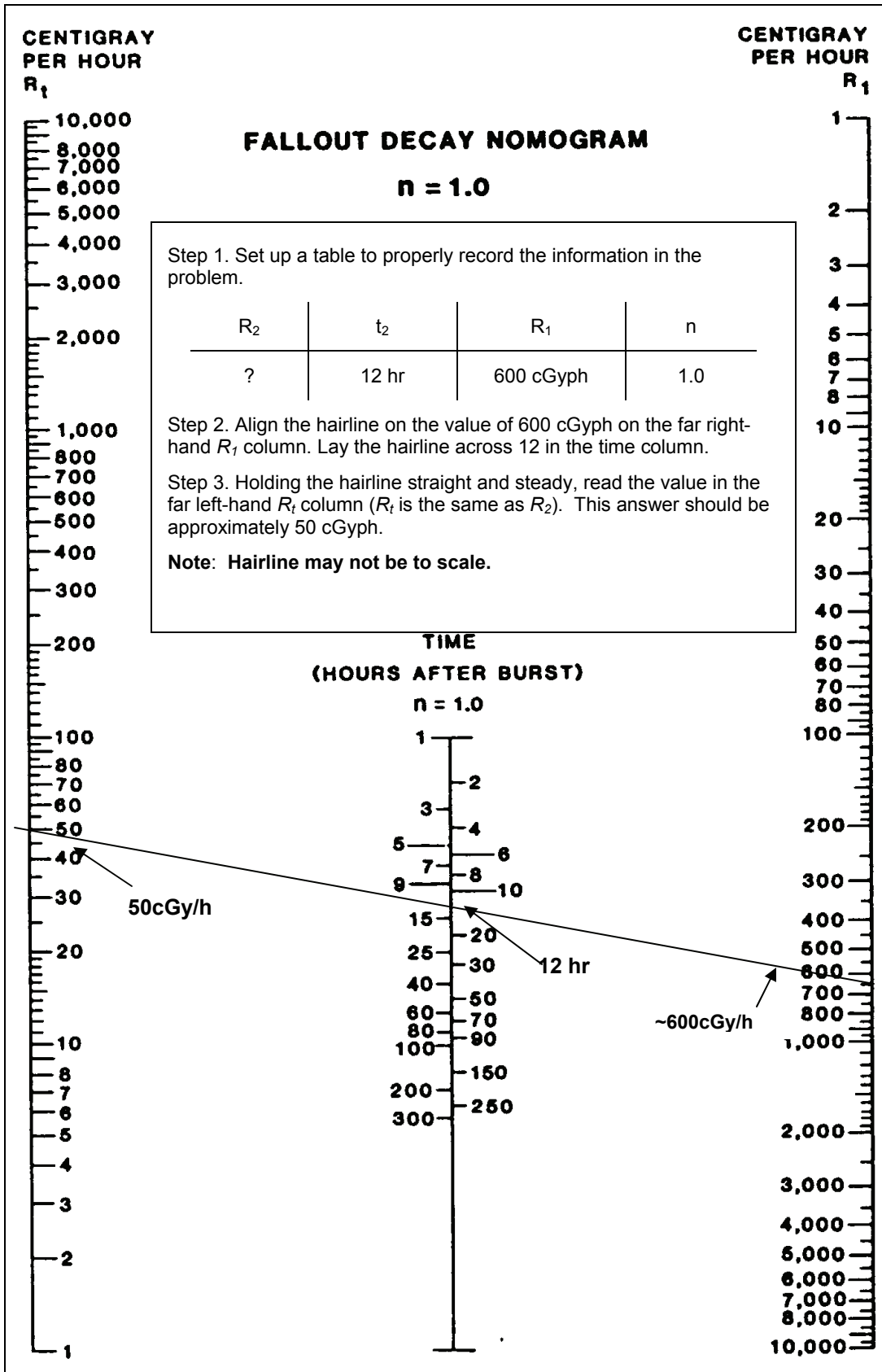

Figure G-35. Determining a Dose Rate at an Arbitrary Time (Example)

f. Determining the Time That the Given Dose Rate is Expected. The Kaufmann equation can also be used as follows:

$R_1 \times T_1^n = R_2 \times T_2^n$ can be mathematically changed to represent the missing (or objective) variable to read: $t_2 = R_1 \times t_1 / R_2$.

(1) In this equation—

R_2 = Dose rate at the location at the arbitrary time.

R_1 = Dose rate (normalized to H+1) at the location.

t_1 = H+1.

t_2 = Arbitrary time, in hours, after H hour.

NOTE: If R_1 is the normalized dose rate reading at H+1, then t_1 will always be 1. Therefore, the equation can be set up as: $t_2 = R_1 / R_2$.

Example: The dose rate reading at H+1 is 1,000 cGy/h. The decay rate is 1.0. Determine the time at which R_2 will be 500cGy/h.

$$R_1 = 1,000 \text{ cGy/h}; R_2 = 500 \text{ cGy/h}$$

(a) Step 1. Set up the formula.

$$t_2 = R_1 / R_2$$

(b) Step 2. Work the problem.

$$t_2 = 1,000/500$$

$$t_2 = 2 \text{ hours}$$

(2) The decay rate nomograms in Appendix J can also be used to determine the dose rate at an arbitrary time.

(a) Step 1. Set up a table to properly record the information in the problem.

| R_2 | t_2 | R_1 | n |
|-----------|-------|-------------|-----|
| 500 cGy/h | ? | 1,000 cGy/h | 1.0 |

(b) Step 2. Find the nomogram for fallout decay using a decay rate (n) of 1.0 (Appendix J).

(c) Step 3. Align the hairline on the value of 1,000 cGy/h on the far right-hand R_1 column. Lay the hairline across to the far left-hand R_t column (R_t is the same as R_2) with 500 cGy/h.

(d) Step 4. Hold the hairline straight and steady, and read the value in the Time column. This answer should be approximately 2 hours.

g. Total Dose Reduction. The primary objective of the commander is to accomplish the mission while keeping the total dose as low as possible. The total dose may be reduced in several ways.

(1) Avoid the area. When the actual measured fallout area cannot be avoided, select the route that has the lowest dose rate. Commit the fewest number of personnel possible to the operation.

(2) Reduce exposure time. Plan operations to minimize the time spent in contaminated areas. Select the route that is fastest and easiest to cross.

(3) Delay the time of entry. If possible, allow the contamination to decay.

(4) Use shielding. All vehicles should have increased shielding. Cross fallout areas on foot as a last resort.

h. Total Dose Procedures. The dose rate of radiation does not directly determine whether or not personnel become casualties. Casualties depend on the total dose received. If dose rates were constant, the total dose would simply be the product of the dose rate and the time spent in the contaminated area (just as in a road movement problem, rate x time = distance). However, the dose rate continually diminishes because of the decay. This makes the calculation more complicated. The actual dose received is always less than the product of the dose rate at the time of the entry times the duration of stay. The total dose, time of entry, and time of stay calculations in the fallout areas are solved in the total dose nomograms.

(1) Using the total dose nomograms in Appendix J, relate the total dose, H+1 dose rate, stay time T_s , and entry time T_e . The index scale is a pivoting line. It is used as an intermediate step between D and R_1 and T_s and T_e . The index scale value can be used to multiply R_1 to find D. The four values on these nomograms are defined below:

D = Total dose in cGy.

R_1 = Dose rate, in cGy/h, one hour after the burst (H+1).

T_s = Stay time, in hours.

T_e = Entry time (hours after H hour).

n = Decay rate.

NOTE: The H+1 dose rate must always be used. Never use a dose rate taken at any other time.

R_1 must be known before the total dose nomograms can be used. If any two of the other three values are known, the nomograms can be used to find the missing piece of information. D and R_1 or T_s and T_e are used together.

(2) When working with total dose nomograms, start the problem on the side of the nomogram where the two known values are located. If D and R_1 are given, start on the left side. If T_s and T_e are given, start on the right side. Never begin a problem by joining D or R_1 with either of the time values. Place a hairline on either side with D and R_1 or T_s and T_e . Align the hairline with the Index line; while holding the hairline in place with the Index value. Enter the nomogram with the remaining side, D and R_1 , or T_s and T_e to determine the missing value.

(3) Example: Given

$$\begin{aligned} R_1 &= 200 \text{ cGy/h} \\ T_e &= H+1.5 \text{ hours} \\ T_s &= 1 \text{ hour} \\ n &= 1.2 \end{aligned}$$

Find

$$D = ?$$

| D | R ₁ | T _s | T _e | n |
|---|----------------|----------------|----------------|-----|
| ? | 200 cGy/h | 1 hr | 1.5 hr | 1.2 |

Solution: 90 cGy.

Select the $n = 1.2$ total dose nomogram. Connect $H+1.5$ hours on the T_e scale with the T_s reading of 1 hour. Pivot the hairline at its point of intersection with the index scale to the 200 cGy/h on the R_1 scale. Read $D = 90$ cGy on the total dose scale. See Figure G-36 for an example.

(4) By 25 hours after the burst, the change in the rate of decay is so low that it is relatively insignificant. Therefore, a different approach is used to estimate the total dose when T_e is greater than 25 hours. In this case, simply multiply the dose rate at the time of entry by the time of stay. This is written “**NOTE: This formula can be modified to determine T_e or T_s as well.**”

$D = R_{T_e} \times T_s$ can be mathematically changed to represent the missing (or objective) variable to read:

$$R_{T_e} = \frac{R_1}{(T_e)^n}$$

D = Total dose (cGy).

R_{T_e} = Dose rate (cGy/h) at time of entry.

T_s = Time of stay (h).

Example: Given—

$$R_1 = 300 \text{ cGy/h}$$

$$T_s = 2 \text{ hours}$$

$$T_e = H+30 \text{ hours}$$

$$n = 1.2$$

Find $D = ?$

(a) Step 1. Set up the formula.

$$D = \frac{R_1}{(T_e)^n} \times 2 = \frac{300 \text{ cGy/h}}{(30)^{1.2}} \times 2$$

(b) Step 2. Work the problem.

$$D = \frac{300 \text{ cGy/h}}{(59.231)} \times 2 = 10 \text{ cGy/h}$$

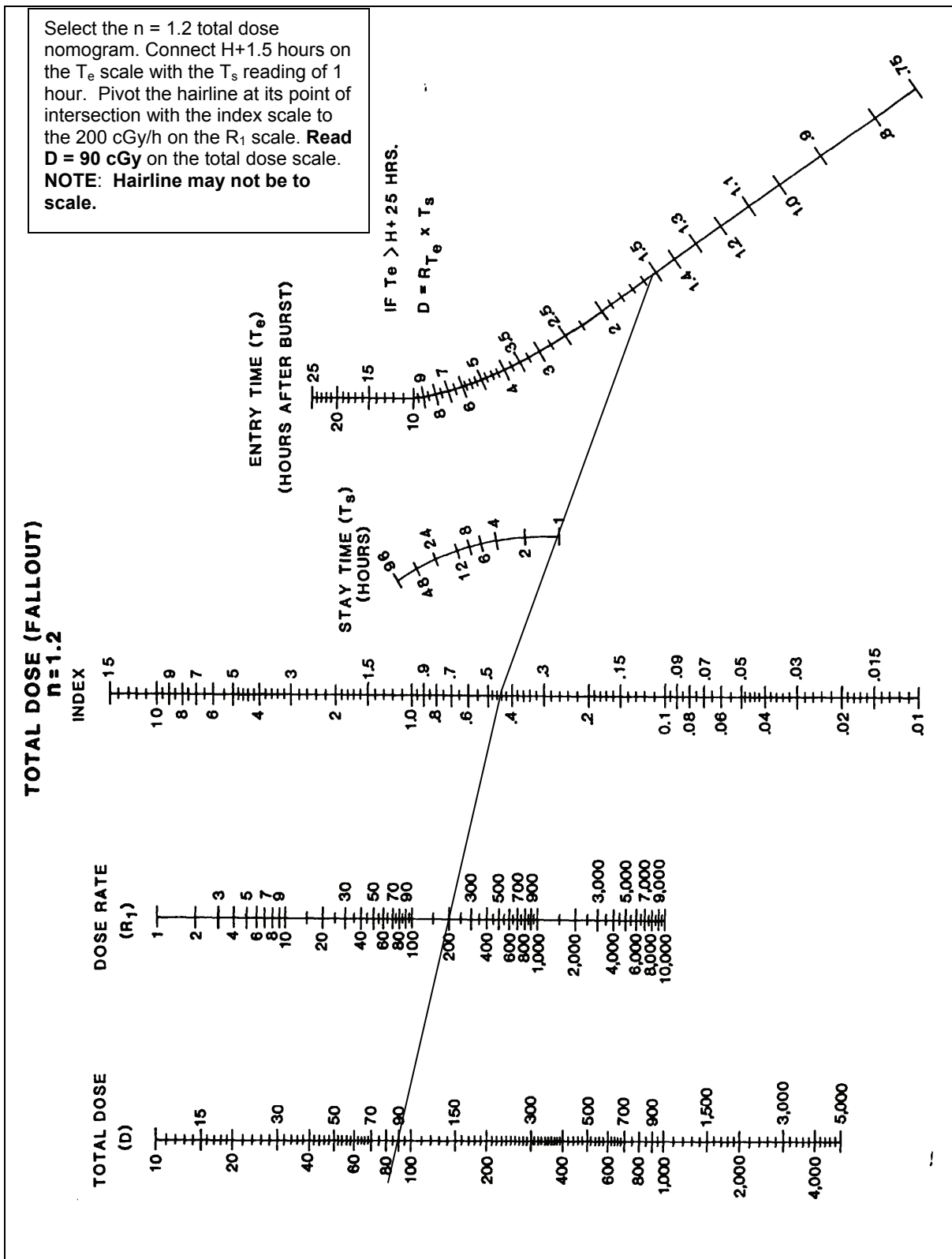

Figure G-36. Total Dose Fallout ($n=1.2$) (Example)

i. Crossing a Fallout Area.

(1) In nuclear operations, it is to be expected that extensive areas will be residually radioactive. It may be necessary to cross an area where there is residual radiation.

(2) When crossing a contaminated area, the dose rate will increase as the center of the area is approached and will decrease as the far side is approached. Therefore, determine an average dose rate for total dose calculations. A reasonable approximation of the average dose rate can be determined using only one-half of the highest dose rate. This is written:

$$R_{\text{avg}} = \frac{R_{\text{max}}}{2}$$

R_{avg} = average dose rate

R_{max} = highest dose rate encountered or expected to be encountered

(3) This calculation is sufficient when looking for a suitable route for crossing a contaminated area or when time is critical.

(4) The effective dose rate for a crossing problem can be treated like the dose rate for a fixed point. Therefore, all follow-on calculations (e.g., accumulated dose, earliest time of entry) for the crossing problem can be done using the same procedures used for a fixed point described earlier. The TF must also be applied as in a stationary situation.

j. Optimum Time of Exit from Fallout Areas.

(1) Nuclear fallout may present a serious hazard to units that remain in the contaminated area. Shelters (such as, field emplacements) are the best protective measures against nuclear radiation for troops in the field. If the shelter provides any appreciable amount of protection, it will be advantageous to remain and improve it rather than to evacuate to an uncontaminated area. If the situation permits and higher HQ approves, the commander may decide to move out of the contaminated area. By evacuating at the optimum exit time, the radiation dose to personnel is kept to a minimum.

(2) To compute the optimum exit time from a fallout area, the time of the detonation, location of an uncontaminated area, average TF, and time required to evacuate must be known.

(3) When moving from an area contaminated by fallout, the unit moves into an uncontaminated location. This will necessitate waiting until fallout is complete at the present positions.

(4) The average TF of the fallout shelters and the vehicles used to leave the contaminated area must be computed. Since all shelters are not the same, an average value should be used. The TF of a vehicle may be estimated. A unit moving on foot will be fully exposed and will have a TF of 1.0.

(5) The time to load vehicles and move out of the contaminated area must be estimated. In order to minimize exposure time, it may be necessary to temporarily abandon nonessential items and recover them at a later time when the dose rate has decreased to an acceptable value. The optimum time of exit (T_{opt}) is calculated as—

$$T_{\text{opt}} = \text{MF} \times T_{\text{ev}}$$

MF is a multiplication factor taken from Figure G-37, page G-78.

T_{ev} is the time required to evacuate the contaminated area.

The following abbreviations are used in the optimum time of exit calculations:

T_{FS} is the average TF for the fallout shelters.

T_{FM} is the average TF after leaving shelters (during movement out of the contaminated area).

TF_{Ratio} is the TF ratio.

(6) Compute the optimum exit time by the following steps:

(a) Step 1. Calculate the TF ratio ($\text{TF}_{\text{Ratio}} = T_{\text{FS}}/T_{\text{FM}}$).

(b) Step 2. Determine the multiplication factor (MF). Enter the vertical axis of Figure G-37, page G-78, with the value obtained for TF_{Ratio} . Move horizontally along this value to the curve. Move straight down, and read the MF from the horizontal axis.

(c) Step 3. Calculate the optimum exit time. Multiply MF by T_{ev} . The product is the optimum time, in hours, after detonation that the unit should leave its shelters and evacuate the area.

(7) Special Considerations.

(a) The unit should evacuate the fallout area as soon as possible when the ratios of TF_{Ratio} are close to or greater than 0.5.

(b) If the optimum time of exit is estimated to be before the actual arrival of fallout, the unit should evacuate the area as soon as possible after the fallout is complete and an uncontaminated area is available.

(c) The unit will receive the smallest dose possible if it leaves the contaminated area at the optimum time of exit. If the commander is willing to accept up to a 10 percent increase in dose, he may leave the shelters any time between one-half and twice the optimum time of exit.

(d) If possible, personnel should improve their shelters while waiting for the optimum time of exit. The estimate of the optimum time of exit should be recalculated if significant improvement is made in the shelters. Improved shelters mean the unit should remain in shelters for a longer period of time to minimize the dose to the personnel.

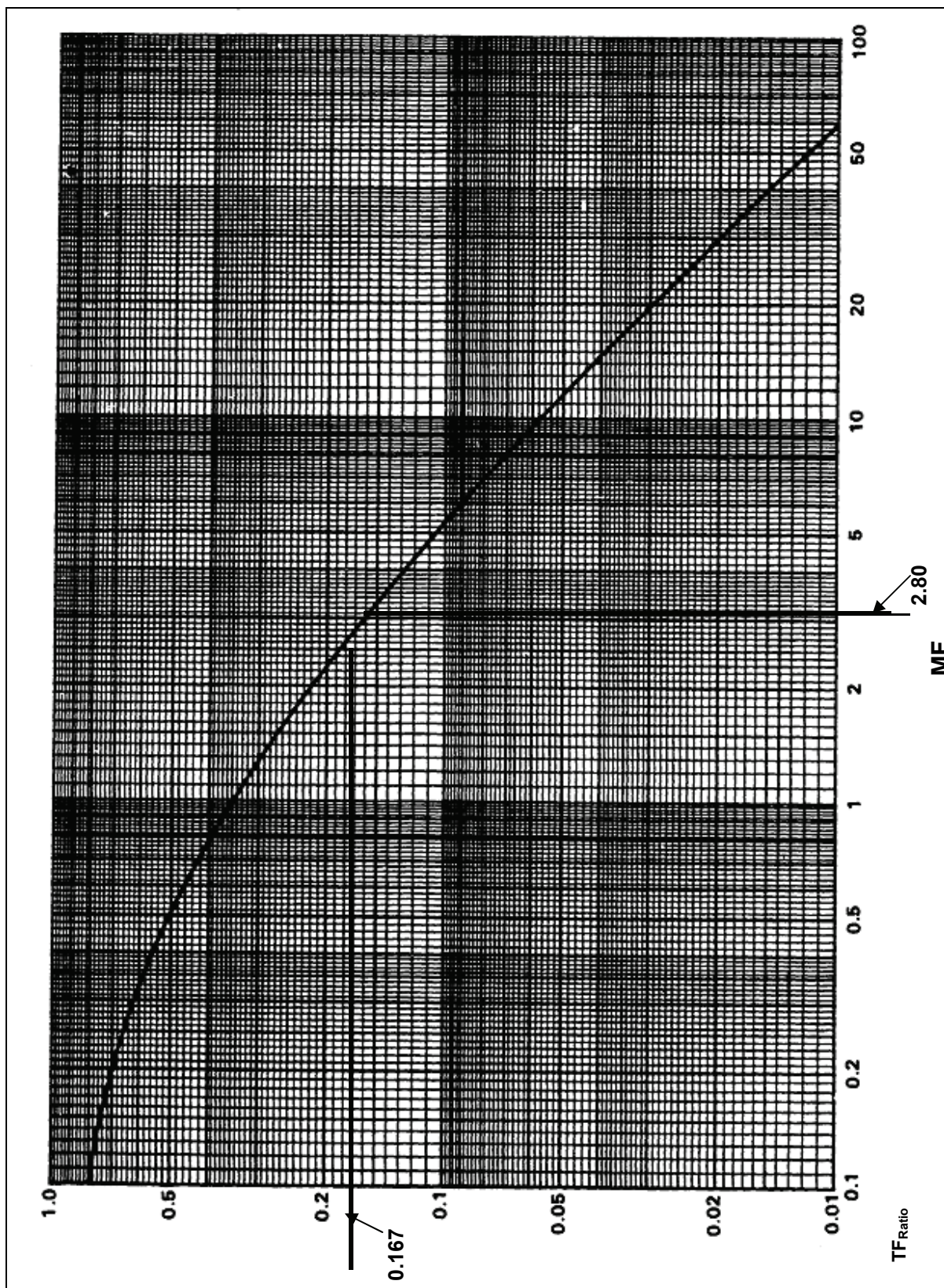

Figure G-37. MF (Example)

k. Neutron-Induced Radiation Areas.

(1) Type of Burst. Neutrons are produced in all nuclear-weapon bursts. Some of these neutrons may be captured by various elements in the soil under the burst. As a result, these elements become radioactive, emitting beta particles and gamma radiation for an extended period of time. Beta particles are a negligible hazard unless the radioactive material makes direct contact with the skin for an extended period of time. Beta particles can cause skin irritations, varying from reddening to open sores. In contrast, gamma radiation readily penetrates the body and can cause radiation injury and even death. To determine the external military hazard posed by induced radiation, an analysis of the dose rate of the emitted gamma radiation must be determined.

(2) Location Data. The location of a suspected, induced radiation area created by an air burst is determined by nuclear-burst data. Weather conditions have no influence on its location or size. Surface winds will not affect the pattern. The pattern, if produced, will always be around GZ. The size of the pattern depends on the yield of the weapon and the HOB. Table G-4 shows the boundaries of the induced area for different yields. Assuming an optimum HOB, the user enters the table with the yield of the weapon. The distance given is the maximum horizontal radius to which a 2-cGy/h dose rate will extend 1 hour after the burst.

Table G-4. Radii of Neutron-Induced Contamination

| Estimated Yield (KT) | Horizontal Radius of 2-cGy/h Dose Rate H+1 (m) |
|----------------------|--|
| 0.1 | 200 |
| 1.0 | 700 |
| 10.0 | 1,000 |
| 100.0 | 1,600 |
| 1,000.0 | 2,000 |

(a) Enter the Keller nomogram (Figure G-38 or G-39, pages G-80 and G-81) with the yield of the weapon to extract the horizontal radius, in meters. The distance given is the maximum horizontal radius to which a 2-cGy/h dose rate will extend 1 hour after the burst.

(b) Enter the radii of the neutron-induced contamination (see Table G-4) with the yield of the weapon to extract the horizontal radius, in meters. The distance given is the maximum horizontal radius to which a 2-cGy/h dose rate will extend 1 hour after the burst.

(c) The following steps should be utilized when plotting neutron-induced radiation areas:

- Step 1. Obtain a clean sheet of overlay paper.
- Step 2. Obtain the nuclear-burst information from the NBC2 NUC report or from the CBRN cell strike serial log. Record the strike serial number, DTG of burst, GZ location, weapon yield, and map scale on the overlay.
- Step 3. Utilize the Keller nomogram or the radii of induced-contamination table to determine the horizontal radius of the 2-cGy/h line.
- Step 4. Select the GZ coordinate.

- Step 5. Draw a circle around the GZ that matches the distance extracted in Step 3 (see Figure G-37, page G-78).

(d) The circular area with a radius as given in Figure G-40, page G-82, around GZ is regarded as contaminated until actual dose rate readings indicate otherwise. The actual area of contamination is usually substantially less, depending on the actual yield and the HOB.

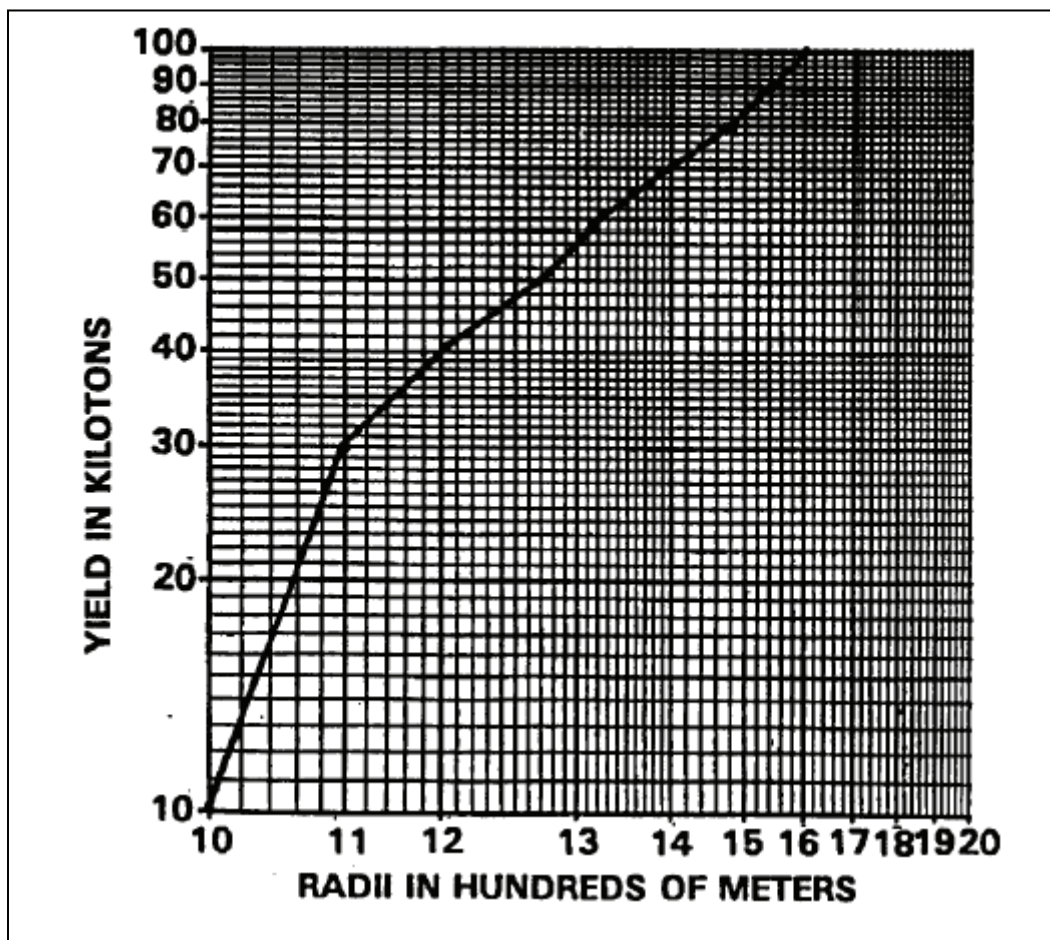

Figure G-38. Keller Nomogram for Neutron-Induced Areas From 10 to 100 Kilotons

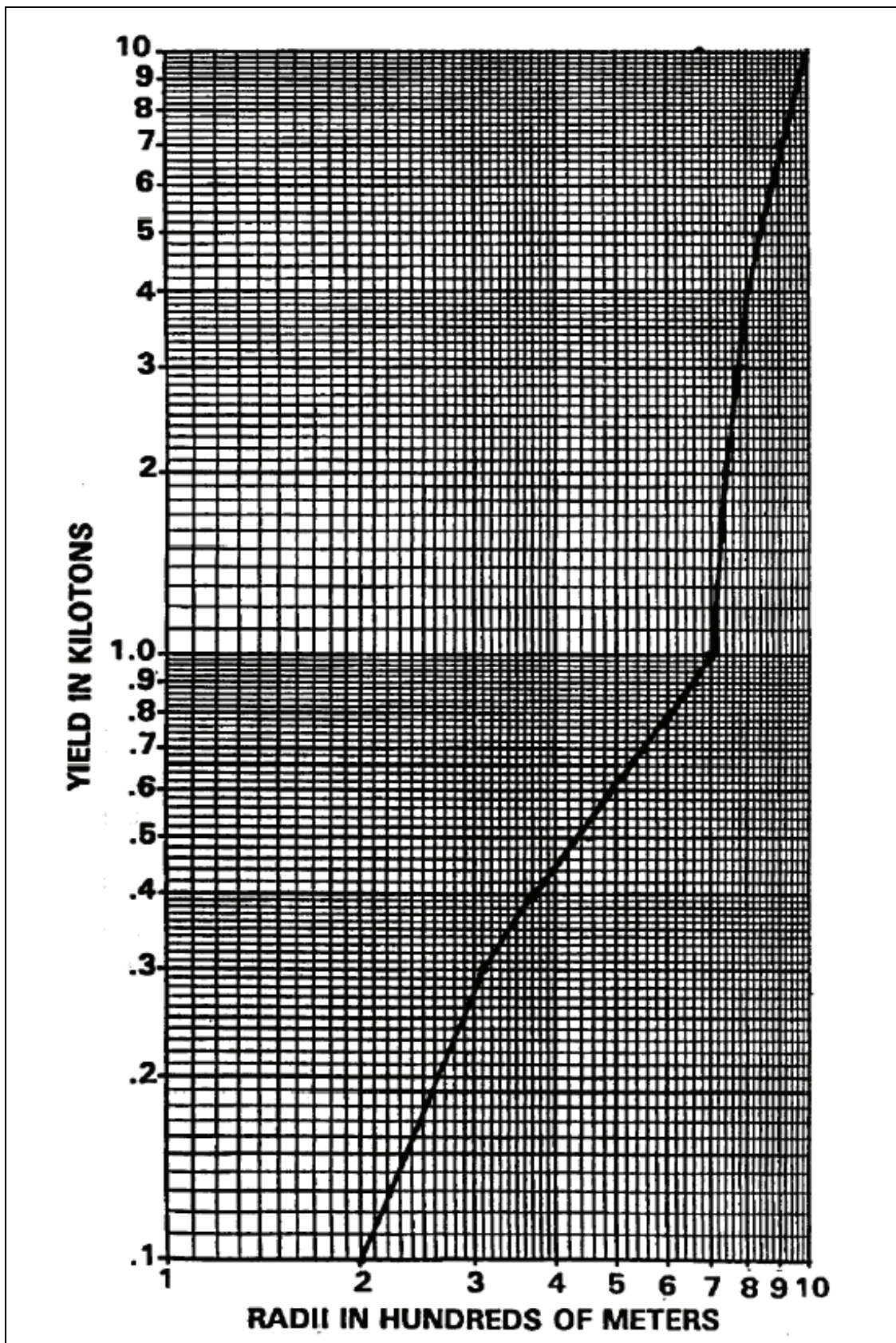

Figure G-39. Keller Nomogram for Neutron-Induced Areas From 0.1 to 10 Kilotons

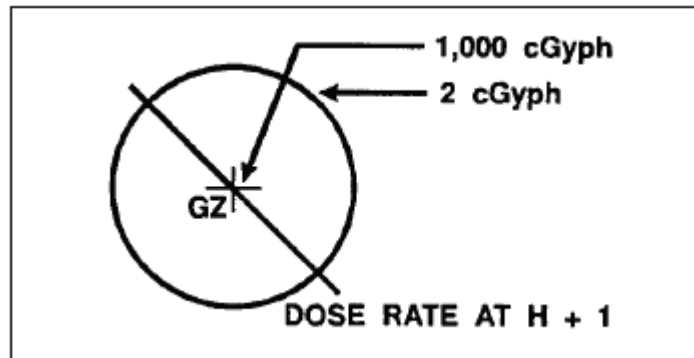

Figure G-40. Example of Plotted Neutron Induced Area

(3) Decay of Induced Radiation.

(a) The soil in the target area is radioactive to a depth of 0.5 meter at GZ. In contrast, fallout is a deposit of radioactive dust on the surface. From this, it can be seen that decontamination of the area is impractical.

(b) The decay characteristics of induced radiation are considerably different from those of the fallout. Fallout is a mixture of many substances, all with different rates of decay. Induced radiation is produced primarily in aluminium, manganese, and sodium.

(c) Other elements, such as silicon, emit so little gamma radiation or decay so fast that they are less important.

(d) During the first 30 minutes after a burst, the principal contributor to induced radiation is radioactive aluminium. Almost all soils contain aluminium. It is one of the most abundant elements in the earth's surface. Radioactive aluminium has a half-life of 2 to 3 seconds. Because of this, almost all the radioactive aluminium has decayed within 30 minutes after the burst.

(e) Most soils also contain significant quantities of manganese. This element decays with a half-life of about 2.6 hours. From 30 minutes after a burst until 10 to 20 hours after the burst, manganese and sodium are the principal contributors to the radiation. After 10 to 20 hours after the burst, sodium (which decays with a half-life of about 15 hours) is the principal source of radiatio.

(f) Soil composition is the most important factor in the decay of induced radiation. Its decay must be considered differently from that of fallout. For fallout, the decay rate is calculated by using the Kaufmann equation. For induced radiation, the percentage (by weight) of elements present in the soil determines the decay rate.

(g) Since soil composition varies widely, even in a localized area, the actual chemical composition of the soil must be known to determine the rate of decay of the induced radiation. The soils are divided into four types (see Table G-5).

(h) Since the actual soil composition will not be known, soil Type II (the slowest decay) is used for all calculations until the CBRN cell advises the use of a different soil type.

Table G-5. Soil Types for Induced Radiation Calculations

| Element | Type I | Type II | Type III | Type IV |
|------------|--------|---------|----------|---------|
| Sodium | - | 1.30 | 0.16 | 0.001 |
| Manganese | 0.008 | 0.01 | 2.94 | 0.006 |
| Aluminum | 2.890 | 6.70 | 18.79 | 0.005 |
| Iron | 3.750 | 2.20 | 10.64 | 46.650 |
| Silicon | 33.100 | 32.00 | 10.23 | 0.004 |
| Titanium | 0.390 | 0.27 | 1.26 | - |
| Calcium | 0.080 | 2.40 | 0.45 | - |
| Potassium | - | 2.70 | 0.88 | 0.001 |
| Hydrogen | 0.390 | 0.70 | 0.94 | 0.001 |
| Boron | - | - | - | - |
| Nitrogen | 0.065 | - | 0.26 | - |
| Sulphur | 0.070 | 0.03 | 0.26 | - |
| Magnesium | 0.050 | 0.60 | 0.34 | - |
| Chromium | 0.008 | - | 0.04 | - |
| Phosphorus | 3.870 | 0.04 | 0.13 | - |
| Carbon | 50.330 | - | 9.36 | - |
| Oxygen | | 50.82 | 43.32 | 53.332 |

(i) Soil type is determined by using engineer soil maps or an NBC4 NUC report and the induced-decay nomograms in Appendix J. The method is basically a process of elimination. The dose rate and the time it was measured are applied to an induced-decay nomogram. This will result in an H+1 or R₁ dose rate. Compare the rates and times with the nomograms until the results have the same R₁.

(4) TFs. TFs for induced areas are determined in the field. The TF in Table G-6 should be used with the greatest reservation. Actual TF in induced areas may be lower by as much as 70 percent because of the technical characteristics of radiation.

Table G-6. TFs for Common Structures

| Structure | Neutrons | Structure | Neutrons |
|---------------------|----------|------------------------------|----------|
| 3 Feet Underground | 0.01 | Concrete Shelter | |
| Frame House | 0.80 | 9-inch walls | 0.50 |
| Basement | 0.80 | 12-inch walls | 0.40 |
| Multifloor Building | N/A | 24-inch walls | 0.20 |
| Upper Floors | 1.00 | Shelter (Partly Aboveground) | |
| Lower Floors | 0.80 | 2 feet of earth cover | 0.08 |
| | | 3 feet of earth cover | 0.05 |

(a) Essentially, the strength of gamma radiation is measured in MeV. Fallout less than 24 hours old has an average energy of 0.67 MeV. Induced radiation emitted from the three principal soil elements has a range of 0.68 to 1.2 MeV.

(b) Because of the unique decay characteristics of induced radiation, the TF must be recalculated frequently (every 4 hours is recommended). This accounts for the changes in the penetration ability of the remaining radiation.

(5) Dose Rate Calculations. The decrease in the dose rate must be calculated before the total dose can be found. This is done with the decay nomograms. Use the residual radiation (induced) decay nomograms in Appendix J for these calculations. They allow the user to predict the dose rate at any time after the burst.

(a) The R_t scale shows H+1 dose rates.

(b) The R_t scale shows the dose rate at other times. This scale shows dose rates at $x t$.

(6) Total Dose Calculations. The nomograms in Appendix J are used for predicting the total dose received in an induced area. This nomogram relates total dose, H+1 dose rate, stay time, and entry time. The two scales to the left of the index line show the total dose and H+1 dose rate. There are two stay-time scales to the right of the index line. The extreme right scale shows entry time. The index line is a pivoting line, which is used as an intermediate step between D and R_1 . R_1 is found by using one of the induced-decay nomograms.

(a) If the soil type is unknown, assume that the soil is Type II. The total dose nomogram (Appendix J) is never used to find R_1 .

(b) The “stay time” T_s must also be calculated. If the soil type is known, the appropriate scale under “stay time” will be used. It is possible to find any one value on the total dose nomogram if the other three are given. The formula for time of stay is calculated as—

Example 1: Given—

$$R_1 = 140 \text{ cGy/h}$$

$$T_e = H + 6 \text{ hours}$$

$$T_s = 1 \text{ hour}$$

Soil Type: II

Find D

Answer: 72 cGy

Solution: On the nomogram (Appendix J) connect H+6 on the T_e scale with 1 hour on the T_s scale (soil Types II and IV) with a hairline. Pin the hairline at the point of intersection with the index scale. Now, pivot the hairline to 140 cGy/h on the R_1 scale. Read 72 cGy on the D scale.

Example 2: Given—

$$R_1 = 300 \text{ cGy/h}$$

$$T_e = H+6 \text{ hours}$$

$$D = 70 \text{ cGy}$$

Soil Type: III

Find T_s

Answer: 1 hour

Solution: On the nomogram (Appendix J) connect 70 cGy on the D scale with 300 cGy/h on the R₁ scale. Pin the hairline at the point of intersection with the index scale. Pivot the hairline to H+6 hours on the T_e scale. Read 1 hour on the T_s scale (soil Types I and III).

(7) Crossing an Induced Radiation Area. If an area must be crossed, the lowest dose rate area consistent with the mission is selected.

(a) When calculating the total dose, it is necessary to determine an average dose rate. Dose rates increase as the center of the area is approached and then decrease beyond the center of the area. The average dose rate represents the mean value that an individual is exposed to during the time of stay. A reasonable approximation of the average dose rate can be obtained by dividing the maximum dose rate predicted to be encountered by two. This is written as—

$$R_{\text{avg}} = \frac{R_{\text{max}}}{2}$$

(b) The time of stay (T_s) must be calculated (see Figure G-41, page G-86). The formula for time of stay is calculated as—

$$T_s = \frac{\text{Distance}}{\text{Speed}}$$

- Step 1. Identify the time of entry (T_e).
- Step 2. Calculate R_{avg} (this will be the R₁ value for the nomogram).
- Step 3. Calculate T_s.
- Step 4. Use the appropriate nomogram (see Figure G-41, page G-86).

Line the T_e and T_s (based on soil type) up.

- Step 5. Pivot the hairline to the R₁ value.
- Step 6. Convert OD to ID to determine the total dose.

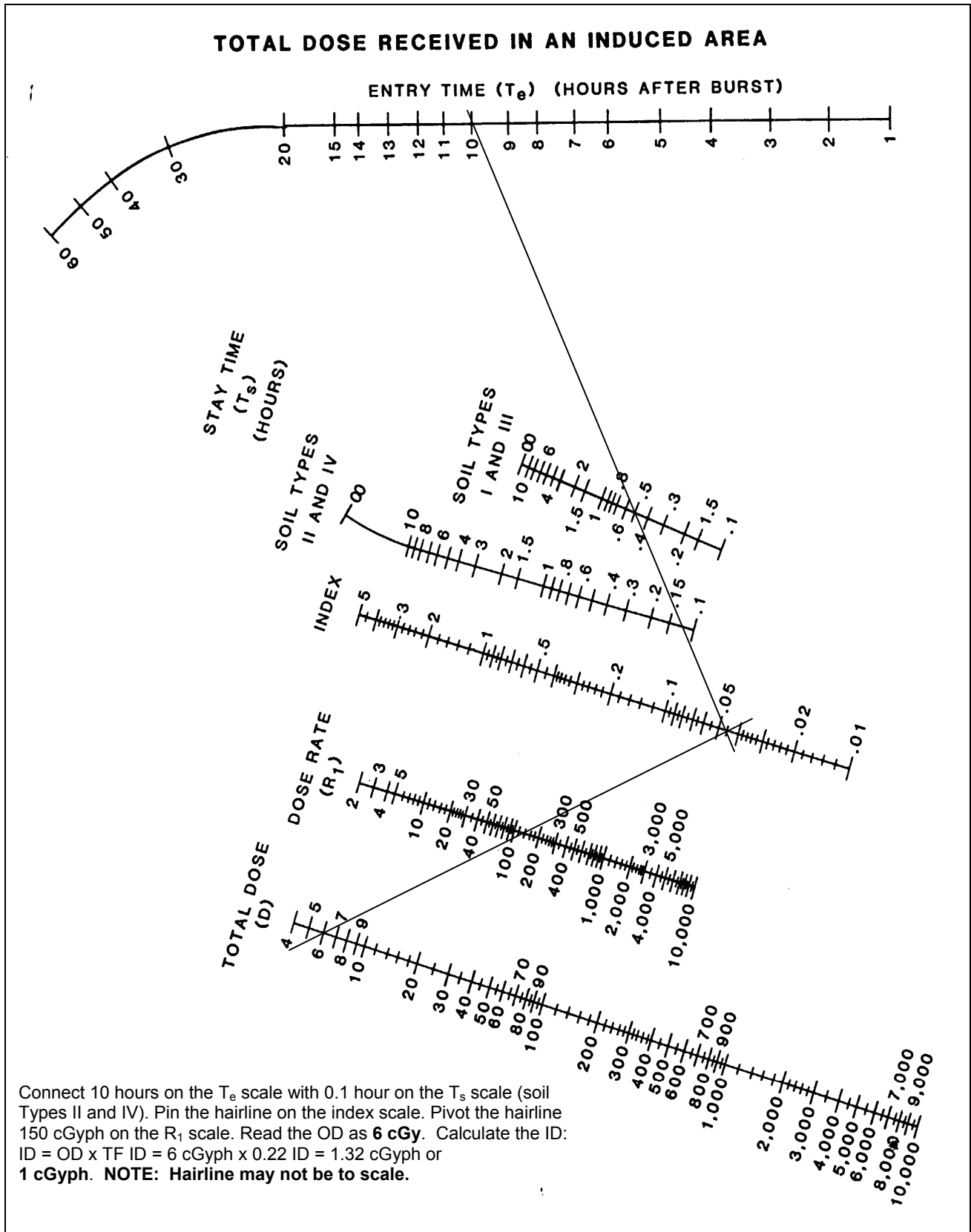

Figure G-41. Total Dose-Induced Radiation (Example)

(8) Determination of Decay Rate for Induced Radiation. Decay characteristics of an induced radiation are considerably different from those of a fallout. The Kaufmann equation may not be applied.

(a) The decay of induced radiation depends on the elements in which it is induced. Soil contains many different elements with varying half-lives, so the decay rate changes in time and must be monitored constantly.

(b) The decay rate (n) at a fixed location can only be determined from consecutive measurements, using the following equation:

$$\frac{1}{t} \times \ln \left(\frac{R_a}{R_a + t} \right)$$

(c) R_a is the dose rate reading in cGy/h at an arbitrary time and $(R_a + t)$ is a second reading taken at the same location after t hours.

(d) Manganese and sodium are two elements with relatively long half-lives that are frequently found in soils. Therefore, they are expected to be the principal sources of radiation after a burst. For sodium, with its half-life of 15 hours, the decay rate is 0.046. For manganese, with its half-life of 2.6 hours, the decay rate is 0.27.

(9) Determination of Dose Rate for Arbitrary Time. The dose rate (R_{1+t}) , in cGy/h, at an arbitrary time (t hours) after a reading is calculated as—

$$R_{1+t} = R_a^{(-n \times t)}$$

R_a is the dose rate at the time (t) of the reading, n is the decay rate at that time, and EXP () is the exponential function (inverse or INV; the argument is the power to which $e=2.71828\dots$ is raised).

(10) Determination of Dose Accumulated in Neutron-Induced Area. The dose D , in cGy, accumulated between entry to and exit from a neutron-induced gamma activity (NIGA) area is found by using the formula—

$$D = R_1/n^{((-n \times t_{in}) - (-n \times t_{out}))}$$

R_1 is the dose rate in cGy/h at the reference time, n is the decay rate at that time, t_{in} and t_{out} are the time of entry and exit from the NIGA area, in hours, after the reference time.

(11) Determination of Earliest Time of Entry. To ensure that a limiting dose (DL) is not accumulated during a stay in an NIGA area, the earliest time of entry (t_{in}) can be determined as follows:

$$T_e = -1/n * (DL/(R * n * (1^{(-n * T_s)}))$$

T_s = Time of stay in the area in hours

R = Dose rate at the reference time H+1

n = Decay rate at that time

(12) Determination of Time of Exit from Neutron-Induced Area Given a Maximum Dosage. If a certain limit DL for the dose accumulated during a stay in an NIGA

area is given, the time (t_{out}) to leave the area can be determined from the following equation:

$$T_{out} = -1/n * n^{((n * T_e) - (n * DL) / R_1)}$$

T_e = Time of entry, in hours, after the reference time at which the dose rate was R_1 and the decay rate was D .

11. NBC6 NUC Report

The NBC6 NUC report (Figure G-42) provides commanders and staff with detailed information that is vital to the operation.

a. Purpose. The NBC6 NUC report is used to provide detailed information on a nuclear attack. The NBC6 NUC report is submitted to higher HQ. It is written in narrative form with as much detail as possible.

b. Message Precedence. All other messages, after the initial NBC1 NUC report has been sent, should be given a precedence, which reflects the operational value of the contents. Normally, IMMEDIATE would be appropriate.

| NBC6 NUC Report | | | |
|--|--|-------|--|
| Line Item | Description | Cond* | Example |
| ALFA | Strike serial number | O | ALFA/US/A234/001/N// |
| DELTA | DTG of attack or detonation and attack end | O | DELTA/201405ZSEP2005// |
| FOXTROT | Location of attack and qualifier | O | FOXTROT/32UNB058640/EE// |
| QUEBEC | Location and type reading/sample/detection | O | QUEBEC/32VNJ481203/GAMMA/-// |
| SIERRA | DTG of reading | O | SIERRA/202300ZSEP2005// |
| GENTEXT | General text | M | GENTEXT/NBCINFO/WEAPON YIELD ESTIMATED FOR EVALUATION OF COLLATERAL DAMAGE PURPOSES ONLY// |
| *The Cond column shows that each line item is operationally determined (O) or mandatory (M). | | | |

Figure G-42. Sample NBC6 NUC Report

(12) Determination of Time of Exit from Neutron-Induced Area Given a Maximum Dosage. If a certain limit DL for the dose accumulated during a stay in an NIGA area is given, the time (t_{out}) to leave the area can be determined from the following equation:

$$T_{out} = -1/n * n^{((-n * T_e) - (n * DL) / R_1)}$$

T_e = Time of entry, in hours, after the reference time at which the dose rate was R_1 and the decay rate was D .

11. NBC6 NUC Report

The NBC6 NUC report (Figure G-42) provides commanders and staff with detailed information that is vital to the operation.

a. Purpose. The NBC6 NUC report is used to provide detailed information on a nuclear attack. The NBC6 NUC report is submitted to higher HQ. It is written in narrative form with as much detail as possible.

b. Message Precedence. All other messages, after the initial NBC1 NUC report has been sent, should be given a precedence, which reflects the operational value of the contents. Normally, IMMEDIATE would be appropriate.

| NBC6 NUC Report | | | |
|--|--|-------|--|
| Line Item | Description | Cond* | Example |
| ALFA | Strike serial number | O | ALFA/US/A234/001/N// |
| DELTA | DTG of attack or detonation and attack end | O | DELTA/201405ZSEP2005// |
| FOXTROT | Location of attack and qualifier | O | FOXTROT/32UNB058640/EE// |
| QUEBEC | Location and type reading/sample/detection | O | QUEBEC/32VNJ481203/GAMMA-// |
| SIERRA | DTG of reading | O | SIERRA/202300ZSEP2005// |
| GENTEXT | General text | M | GENTEXT/NBCINFO/WEAPON YIELD ESTIMATED FOR EVALUATION OF COLLATERAL DAMAGE PURPOSES ONLY// |
| *The Cond column shows that each line item is operationally determined (O) or mandatory (M). | | | |

Figure G-42. Sample NBC6 NUC Report

THIS PAGE IS INTENTIONALLY LEFT BLANK

Appendix H

RELEASE-OTHER-THAN-ATTACK CONTAMINATION AVOIDANCE TACTICS, TECHNIQUES, AND PROCEDURES

1. Background

The ROTA contamination avoidance TTP provides vital SA to the commander when faced with a ROTA incident.

a. General. This appendix covers the procedures to warn and report CBRN releases other than the traditional military CBRN attacks resulting from the offensive use of CBRN weapons. These releases may include, but are not limited to, CBRN or TIM releases due to damaged or destroyed storage bunkers, transport vehicles, storage or production facilities, ammunition supply sites, power plants, etc.

b. Characteristics.

(1) Types of HAZMAT. Most nations in the world have some form of hazardous CB (or radiological) production or storage facilities. Most of these materials are used for peaceful purposes and are considered to be in one of the following categories:

(a) Agricultural. These include insecticides, herbicides, fertilizers, etc.

(b) Industrial. These are chemicals or other substances (biological or radiological) used in manufacturing processes or for cleaning.

(c) Production and Research. These are CBRN materials used in research or produced in a facility.

(2) Detection. Civilian chemical materials or compounds or biological materials may not be detectable by the standard CB detection devices of tactical units. Also, these materials may not be detectable with the human senses and may cause symptoms that are different than symptoms from CBRN agents.

(3) Definitions.

(a) Release Area. This is the predicted area immediately affected by the release.

(b) Hazard Area. This is the predicted area in which unprotected personnel may be affected by CBRN material spreading downwind from the release area. The downwind distance depends on the type of the release, the weather and terrain in the release area, and the area downwind of the release area.

(c) Contaminated Area. This is the area in which CBRN material may, in solid or liquid form, remain at hazardous levels for some time after the release. The actual shape and duration can only be determined by surveys.

(d) Elevated Releases. Any release which, due to fire, momentum, or explosion, is carried more than 50 m above the ground is considered an elevated release.

(e) TIM. TIM is the generic term for toxic (CB) or radioactive substances in a solid, liquid, aerosolised, or gaseous form. These may be used (or stored for use) for industrial, commercial, medical, military, or domestic purposes. TIM may be chemical, biological, or radioactive and may be described as toxic industrial chemical (TIC), toxic industrial biological (TIB), or toxic industrial radiological (TIR).

2. Release-Other-Than-Attack Contamination Avoidance Procedures

Avoidance procedures are broken down into three actions—before, during, and after the attack. The lists given, while not all-encompassing, may assist in developing the unit SOP and directives.

a. Preattack.

(1) Alert subordinate units.

(2) Assess the ability of the MOPP gear to protect against agent or material; request additional protective gear as required.

(3) Specify (commanders) the appropriate MOPP levels; establish automatic masking criteria; and, if MOPP0 is assumed, determine the location for the chemical protective clothing based on the METT-TC.

(4) Continue the mission while ensuring that the following actions are implemented to minimize casualties and damage:

(a) Protect personnel, equipment, munitions, POL, food, and water from the contamination.

(b) Place the detection paper to provide visibility and maximum exposure to liquid agents.

(c) Practice OPSEC, dispersal, and cover and concealment so that the unit may avoid being targeted.

(d) Check to ensure that the chemical detectors and alarms are prepared for use.

(e) Prepare the updated CDMs for each unit.

(5) Determine the decontamination requirements.

b. During Attack.

(1) All personnel automatically mask, sound the alarm, decontaminate themselves (as required), assume MOPP4, and administer self-aid and buddy-aid.

(2) The chain of command and communications are restored and the unit continues the mission.

(3) Adjacent units are immediately warned of the potential downwind vapor hazards.

(4) The unit identifies the type of agent and submits an NBC1 ROTA report as the mission permits.

(5) The unit performs the following actions for attacks that leave liquid or solid contamination on the equipment, personnel, or terrain:

- (a) Conduct personal wipe-down and operator's spray-/wipe-down.
- (b) Warn medical evacuation personnel of the contamination casualties. Wrap and mark the persons killed in action.
- (c) Mark the contaminated area, and relocate to a clean area if the mission allows.
- (d) Determine where and when further decontamination can be accomplished, if necessary.
- (e) Coordinate for decontamination, and resupply protective clothing and decontaminants.
- (f) Ensure that the contaminated battle dress overgarments are exchanged within 24 hours after being contaminated.
- (g) Replace the contaminated protective covers within 24 hours.
- (h) Conduct unmasking procedures, treat casualties, prepare for evacuation (as the mission permits), and ensure the operational status of the service detection systems.
- (i) Receive the NBC2 ROTA report, plot the potential hazard area, and inform the commander.

c. Postattack.

- (1) The unit has undergone decontamination operations, and casualties have been evacuated.
- (2) The unit reorders CBRN defense equipment (i.e., MOPP suits, filters, decontamination kits).
- (3) If the unit has not yet identified what agent was used, continue the effort to identify the agent and source. This will be done by using the following:
 - M8 chemical-agent detection paper.
 - M256A1 chemical-agent detection kit.
 - ICAM or Chemical-Agent Monitor Block II (CAM II [USMC]).
 - Automatic Chemical-Agent Detector Alarm (ACADA).
 - AN/VDR-2 radiac set.
 - AN/PDR-56 radiac set.
 - AN/PDR-77 radiac set.
 - ADM-300 radiac set.
 - DOD biological sampling kit.
 - HAZMAT identification system.
 - Hazardous category, chemical identification system.
 - Samples that are forwarded to the area lab for analysis.

(4) If the unit must continue to operate in or occupy the contaminated area, the unit should do the following:

- Continue efforts to refine the contamination hazard area and extent by continued sampling and detection.
- Adjust or improve the MOPP as required.
- Mark the contaminated areas and identify the “hot spots.”
- Monitor the contamination decay or covering to determine when natural decay may render the area safe.
- Be alert for transient contamination and the spreading or movement of contamination by natural sources (i.e., wind, rain, runoff, rivers) or by human sources (i.e., vehicle traffic, rotor wash).

3. Release-Other-Than-Attack Information Management

Managing ROTA information is crucial for the success of a command. To be useful, the ROTA information must be collected, reported, and evaluated. Once evaluated, it can be used as battlefield intelligence. Obtaining and converting ROTA information into usable intelligence does not just happen. The volume of information that needs to be collected and reported could easily disrupt communications and tactical operations if not properly managed.

a. **Collecting ROTA Information.** The first step in managing ROTA information is to determine what information is available and who is available to collect it. Observer data provides information that a ROTA event (intentionally or accidentally) has occurred. Monitoring, survey, and reconnaissance data provide information on where the hazard is located. Every unit is responsible for observing and recording ROTA events, but only selected units automatically submit NBC1 ROTA reports to the CBRN cell.

b. **Consolidating ROTA Data.**

(1) NBC1 ROTA reports allow the CBRN cell to collect information on where the designated observers have seen a nuclear attack. The CBRN cell then evaluates this information in the form of an NBC2 ROTA report. From the NBC2 ROTA report, a simplified or detailed hazard prediction is made. This prediction (NBC3 ROTA report) is only an estimate of the hazard area. Feedback is needed from the units to determine exactly where the contamination is located. This feedback comes from monitoring, survey, and reconnaissance data (NBC4 ROTA reports). Monitoring and reconnaissance operations give the initial location of CBRN hazards to the CBRN cell. Initial monitoring and reconnaissance reports are generally forwarded through intelligence channels to the CBRN cell. This information may also be sent to the CBRN cell by the use of various DSTs, as discussed in Chapter III.

(2) The CBRN cell then plots the information on the situation map. If more information is required, the CBRN cell directs a unit (picked because of its location and capability) to collect and forward the necessary data. This information could be from additional monitoring reports or a survey of the area in question. Collecting ROTA information is a joint effort of units and the CBRN cell. The unit does the actual collecting of information. The CBRN cell plans for and directs the collection effort. More detailed

information concerning this collection effort is addressed in *Multiservice Tactics, Techniques, and Procedures for Nuclear, Biological, and Chemical Reconnaissance*.

c. Evaluating ROTA Information. After the ROTA information has been collected, it is evaluated. It is then used as battlefield intelligence. The CBRN cell is the primary evaluation center. The units and intermediate HQ use this raw data to develop ROTA intelligence for their own use until detailed results are available from the CBRN cell.

d. Transmitting ROTA Information. The procedures used to transmit ROTA information to and from the CBRN cell are an important part of the IM. The method of transmitting information depends on the tactical situation and mission of the unit. Refer to Chapter III for more detailed information.

4. NBC1 ROTA Report

The NBC1 ROTA report (Figure H1, page H-6) is the most widely used report. The observing unit uses this report to provide ROTA data. All units must be completely familiar with the NBC1 ROTA report format and its information. The unit must prepare this report quickly and accurately and send it to the next higher HQ. Battalion (squadron) or the service equivalent and higher elements decide which NBC1 ROTA reports to forward to the next higher HQ. If several reports are received for the same ROTA event, a consolidated NBC1 ROTA report is forwarded. This reduces the number of reports to a manageable level.

a. Purpose. The purpose of the NBC1 ROTA report is to provide ROTA data.

b. Precedence. The first time a ROTA event occurs, the designated unit will send the NBC1 ROTA report with a FLASH precedence. If a previous NBC1 ROTA report has been forwarded, an IMMEDIATE precedence will be used.

c. Information Included. The report will include lines BRAVO, CHARLIE, GOLF, INDIA, and TANGO and may include line items ALFA, FOXTROT, MIKER, YANKEE, ZULU, and GENTEXT with the information as currently described for CBRN reports. Line CHARLIE provides the same information as line DELTA, except it indicates an observed ROTA event rather than an observed attack. Line GOLF will include the type of delivery if applicable, the ROTA type of container (e.g., bunker, waste, reactor, transport, stockpile), and the size of the release (small, large, or extra large) if appropriate. Line INDIA will indicate the observed release height and indicate the type of release as ROTA nuclear power plant, TIM, or the agent name or identification number. Line INDIA will indicate the material persistency. Additional descriptive entries for a ROTA event can be entered into line MIKER. Line TANGO will indicate a description of the terrain/topography and the vegetation. Lines YANKEE and ZULU may indicate locally observed weather. Line GENTEXT will provide the specific chemical compound or the type of biological agent if available.

d. Preparation. Determine the line items for this report by utilizing the same procedures as the previous contamination avoidance TTP appendixes per the type of attack or event.

| NBC1 ROTA Report | | | |
|--|--|-------|-----------------------------|
| Line Item | Description | Cond* | Example |
| ALFA | Strike serial number | O | |
| BRAVO | Location of observer and direction of attack or event | M | BRAVO/32UNB062634/2500MLG// |
| CHARLIE | DTG of report or observation and end of event | M | CHARLIE/281530ZSEP2005// |
| FOXTROT | Location of attack or event | O | FOXTROT/32UNB058640/EE// |
| GOLF | Delivery and quantity information | M | GOLF/SUS/TPT/1/TNK/SML// |
| INDIA | Release information on CB agent attacks or ROTA events | M | INDIA/SURF/2978/-/ARD// |
| MIKER | Description and status | O | MIKER/LEAK/CONT// |
| TANGO | Terrain/topography and vegetation description | M | TANGO/URBAN/URBAN// |
| YANKEE | Downwind direction and downwind speed | O | YANKEE/270DGT/015KPH// |
| ZULU | Actual weather conditions | O | ZULU/4/10C/7/5/1// |
| GENTEXT | General text | O | |
| *The Cond column shows that each line item is operationally determined (O) or mandatory (M). | | | |

Figure H-1. Sample NBC1 ROTA Report

5. NBC2 ROTA Report

The NBC2 ROTA report reflects the evaluated ROTA data. It is based on one or more NBC1 ROTA reports. Users of the NBC2 ROTA reports are not limited to the use of the line items shown in Figure H-2. Other line items may be added as appropriate.

a. Purpose. The purpose of the NBC2 ROTA report is to pass the evaluated data to the higher, subordinate, and adjacent units.

b. Precedence. All messages after the initial NBC1 ROTA report has been sent, should be given a precedence, which reflects the operational value of the contents. Normally, IMMEDIATE would be appropriate.

c. Preparation. The division (or designated higher HQ) CBRN cell prepares the NBC2 ROTA report, assigns a strike serial number, and disseminates the report to the appropriate unit.

d. Subsequent Data. Subsequent data may be received after the NBC2 ROTA report is sent. Use the same strike serial number and DTG of the attack or incident. Determine the line items for this report utilizing the same procedures as the previous contamination avoidance TTP appendixes per the type of attack or event.

| NBC2 ROTA Report | | | |
|--|--|-------|---|
| Line Item | Description | Cond. | Example |
| ALFA | Strike serial number | M | ALFA/US/WEP/001/RN// |
| CHARLIE | DTG of report /observation and event end | M | CHARLIE/281530ZSEP2005/ 281545ZSEP1997// |
| FOXTROT | Location of attack or event | M | FOXTROT/32UNB058640/EE// |
| GOLF | Delivery and quantity information | M | GOLF/SUS/TPT/1/TNK/1// |
| INDIA | Release information on CB agent attacks or ROTA events | M | INDIA/SURF/2978/-/ARD// |
| MIKER | Description and status | M | MIKER/LEAK/CONT// |
| TANGO | Terrain/topography and vegetation description | M | TANGO/URBAN/URBAN// |
| YANKEE | Downwind direction and downwind speed | O | YANKEE/270DGT/015KPH// |
| ZULU | Actual weather conditions | O | ZULU/4/10C/7/5/1// |
| GENTEXT | General text | O | |
| *The Cond column shows that each line item is operationally determined (O) or mandatory (M). | | | |

Figure H-2. Sample NBC2 ROTA Report

6. NBC3 ROTA Report

The NBC3 ROTA report reflects the predicted areas of contamination. It is based on the NBC2 ROTA report and any current relative data. Users of the NBC3 ROTA reports are not limited to the use of the line items shown in Figure H-3, page H-8. Other line items may be added as appropriate.

a. Purpose. The purpose of the NBC3 ROTA report is to report the immediate warning of the predicted contamination and hazard areas to higher, subordinate, and adjacent units.

b. Precedence. All messages after the initial NBC1 ROTA report has been sent should be given a precedence, which reflects the operational value of the contents. Normally, IMMEDIATE would be appropriate.

c. Preparation. The report will use the information as described in this manual for lines ALFA, CHARLIE, FOXTROT, GOLF, INDIA, PAPAA, PAPAX, YANKEE, ZULU, and GENTEXT. The hazard area location is described in line PAPAX, with the defining release area radius and protective action distance summarized in line PAPAA. Line XRAYA may be used to report contours for the measured areas of air contamination. Determine the line items for this report utilizing the same procedures as the previous contamination avoidance TTP appendixes per the type of attack or event.

| NBC3 ROTA Report | | | |
|--|--|-------|--|
| Line Item | Description | Cond* | Example |
| ALFA | Strike serial number | M | ALFA/US/WEP/001/RN// |
| CHARLIE | DTG of report /observation and event end | M | CHARLIE/281530ZSEP2005// |
| FOXTROT | Location of attack or event | M | FOXTROT/32UNB058640/EE// |
| GOLF | Delivery and quantity information | O | GOLF/SUS/TPT/1/TNK/1// |
| INDIA | Release information on CB agent attacks or ROTA events | M | INDIA/SURF/2978/-/ARD// |
| PAPAA | Predicted attack/release and hazard area | M | PAPAA/1000M*!-/5KM/-// |
| PAPAX** | Hazard area location for weather period | M | PAPAX/081200ZSEP1997/ 32VNJ456280/32VNJ456119/ 32VNJ576200/32VNJ566217/ 32VNJ456280// |
| XRAYB*** | Predicted contour information | C | |
| YANKEE | Downwind direction and downwind speed | O | YANKEE/270DGT/015KPH// |
| ZULU | Actual weather conditions | O | ZULU/4/10C/7/5/1// |
| GENTEXT | General text | O | |
| <p>*The Cond column shows that each line item is operationally determined (O) or mandatory (M).</p> <p>**Line item is repeatable up to three times in order to describe three possible hazard areas corresponding to the time periods from the CDM. A hazard area for a following time period will always include the previous hazard area.</p> <p>***Line item is repeatable up to 50 times to represent multiple contours.</p> | | | |

Figure H-3. Sample NBC3 ROTA Report

d. Types of Releases. There may be chemical, biological, and/or radiological material present in any AO, which will present a hazard to persons if it is released into the atmosphere. Releases may be accidental or intentional. The amount of material released may be small or extremely large. Such ROTA events can be divided into two types based on their origin:

(1) Type N, ROTA Nuclear. Nuclear material can be released into the atmosphere from the core of a nuclear reactor, has been damaged or which has gone out of control. Similar incidents may occur at nuclear-fuel reprocessing or production facilities. Such a release can result in very high levels of radiation, covering distances of hundreds of km.

(2) Type T, TIM. There are five cases of incidents under Type T. These cases include items that may be used or stored for use for industrial, commercial, medical, military, or domestic purposes. TIM may be TIC, TIB, or TIR.

(a) Case 1, Nuclear-Waste or Radiological-Material Storage. Damage to a nuclear-waste or radiological-material storage facility may result in the release of radiological material into the atmosphere. Such a release will result in LLR covering a

fairly short distance, which will be dangerous to anyone remaining in the hazard area for an extended period of time.

(b) Case 2, RDD. The intentional release of large amounts of radiological material can result in hazardous areas extending far downwind.

(c) Case 3, Biological Bunker or Production Facility. Damage to a storage bunker containing biological agents intended for use in BW or to production facilities for such agents containing active agent containers will result in smaller release areas and lower quantities than if agents had been dispersed from a weapon. However, due to the toxicity of such agents and the likelihood of having an elevated plume, dispersed material may travel downwind at hazardous levels for many hours.

(d) Case 4, Chemical Stockpile or TIM Transport/Storage. Damage to stockpiled munitions containing chemical agents will result in considerably smaller quantities of agent released than the intentional use of munitions; therefore, the downwind hazard area will usually be smaller than for a chemical attack. Damage to containers of TIM being transported by road, rail, or boat can result in large quantities released into the atmosphere. However, the toxicity and stability of these materials will be less than for chemical agents and the hazard areas will also be smaller than for a chemical attack. This category also includes small storage quantities and single munitions found leaking on the battlefield.

(e) Case 5, Bulk Chemical Storage. TIC are stored in very large quantities (greater than 1,500 kg) in large tanks, often under pressure and at low temperatures. A catastrophic rupture of such a tank will result in a highly toxic cloud, which usually exhibits dense-gas behavior. This type of release may also occur intentionally by a terrorist or other deliberate action. Such a cloud will not travel with the wind until after its concentration has been reduced considerably, often when it is below toxic levels. In addition to their toxicity, TIC are often corrosive, flammable, explosive, or able to react violently with air or water. These hazards may be greater than the immediate toxic effects.

e. Procedures and Constraints.

(1) Procedures.

(a) Record and update the following information:

- Weather information from relevant CBRN commanders, which may contain forecast data and measured data.

- Weather information from local measurements and observations, which may contain data before and during the cloud passage period.

- A database of local meteorology measured during the cloud passage period

(b) Record the terrain features (wooded areas, mountains, plains, etc.), which may influence the direction and speed of the ROTA clouds.

(c) Generate an NBC3 ROTA report, and consider distribution whenever the threat of a ROTA event is high.

(d) Estimate the MET parameters for the release area and downwind of the release area upon the receipt of an NBC1 or NBC2 ROTA report.

(e) Select (according to the national directives) the weather information to be used, and calculate the predicted downwind hazard area.

(2) Constraints.

(a) When calculating the predicted downwind hazard area from ROTA events, many factors will affect the accuracy of the prediction. Some of these factors include the following:

- Type and amount of CBRN agents or materials.
- Type and amount of delivery or storage systems.
- Type and amount of agent containers.
- Terrain composition.
- Weather.
- Air stability.
- Type of surface.
- Vegetation.
- Surface air temperature.
- Relative humidity.

(b) Some of the above factors are not considered when using the procedures in this appendix or annotated to refer to a previous appendix for appropriate hazard prediction procedures unless evaluated and estimated manually by the user.

(c) The procedures shown in this appendix or annotated to refer to a previous appendix for appropriate hazard prediction procedures are based on the limited amount of information available at the time of the ROTA event.

(d) To be able to make more accurate predictions, more information about the listed factors has to be available and more sophisticated methods have to be used for prediction.

f. ROTA Types and Cases (see Table H-1). A sample decision flowchart for the ROTA types and cases is shown in Figure H-4, page H-12.

Table H-1. ROTA Types and Cases

| Type of Release/ Material Type | Subcategory | Type | Case | Procedures |
|---|-------------------------------------|------|------|----------------------------------|
| Nuclear reactor | | N | - | Refer to Appendix F* |
| TIM | Nuclear waste | T | 1 | 1 km radius |
| | Radiological dispersion | | 2 | Refer to Appendix F* |
| | Biological bunker | | 3 | Refer to Appendix F |
| | Chemical stockpile or TIM transport | | 4 | Refer to Appendix E and the ERG* |
| | Bulk chemical storage | | 5 | 2 km daytime; 6 km nighttime* |
| *Also refer to the hazard prediction for elevated releases. | | | | |

g. Hazard Prediction Methods.

(1) Type N, Releases of Nuclear Fuel from a Nuclear Reactor. Material released from a nuclear-reactor incident will be mostly, or all, particles of nuclear fuel. Since the decay of the particles from a nuclear-reactor accident is different than for nuclear-weapon fallout, the procedures used for the hazard prediction after nuclear detonations cannot be used.

(a) The release may be violent enough to send the nuclear-fuel particles into the upper atmosphere. The hazard area prediction procedures described in Appendix F should be used, assuming a Type P attack. If the release takes more than 5 minutes, the latest arrival time may need to be adjusted for the duration of the release.

(b) Hazard areas for extended duration releases should be recalculated as a Type R attack. The end points of the line are the release location and the current position of the front end of the cloud. Use 1.5 times the mean wind speed. For wind speeds of 10 kph or less, Type P must be used.

(c) If the release is reported as continuous and the reported duration exceeds 2 hours or is not reported, the procedures for Type S should be followed.

(d) If the bulk of the material is elevated to a high altitude, the wind speed and bearing at that height from the CBRN BWM or other appropriate MET data should be used. If the material extends continuously from near the ground to a high elevation (above 50 m), the procedures for an elevated release should also be used.

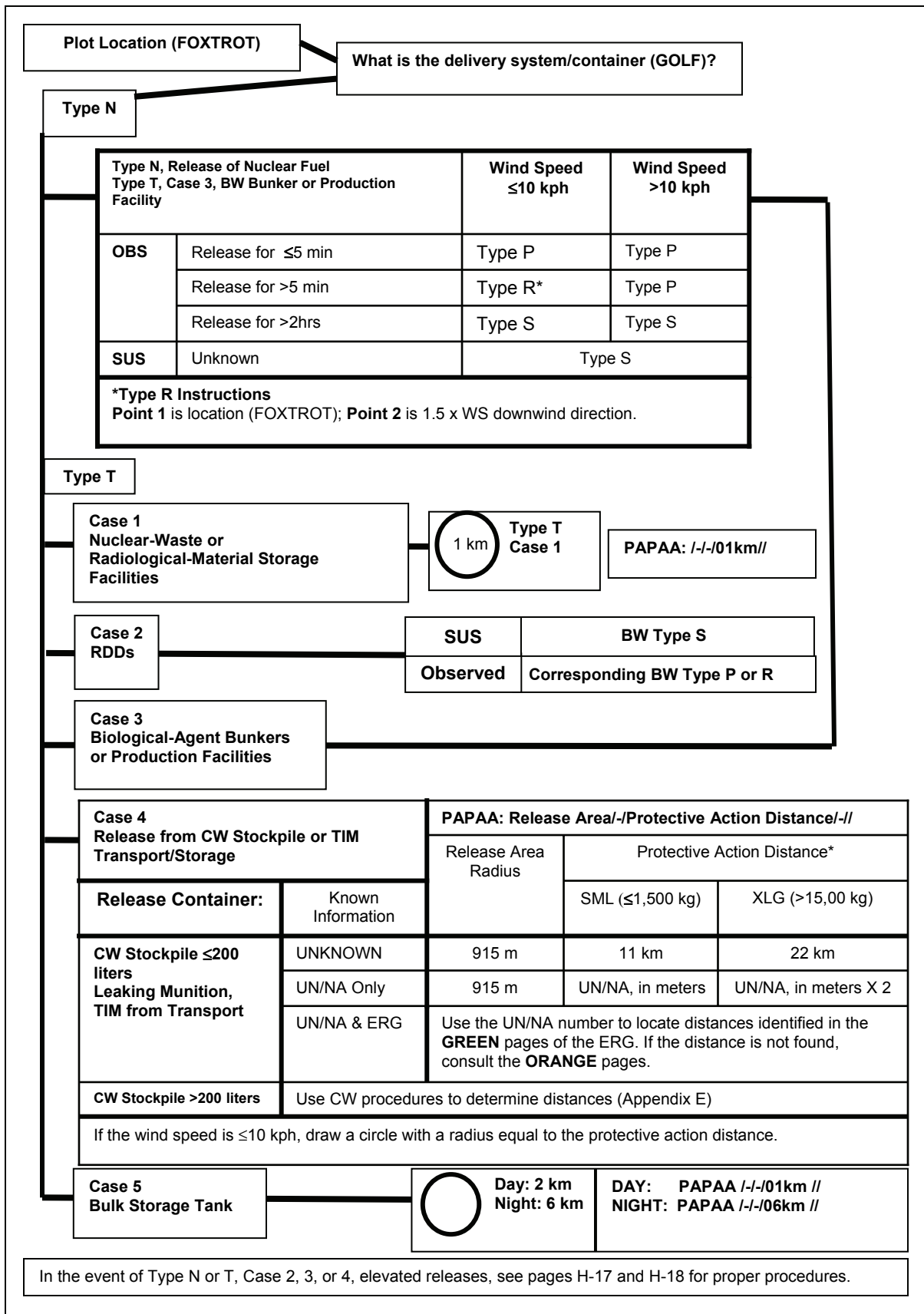

Figure H-4. Sample Decision Flowchart for ROTA Types and Cases

(2) Type T, Releases of TIM. Due to the differences in materials and release types, hazard prediction methodology must be broken down into five cases.

(a) Case 1, Release From Nuclear-Waste or Radiological-Material Storage Facilities. Nuclear waste and radiological materials are usually stored well below ground level, usually in a special lead drum contained in concrete shelters. Damage to such a facility may rupture some of the drums and release the radiological material into the atmosphere over an extended period of time.

- The release area will be localized, and the hazard area is not expected to be very large. However, the cloud may be toxic at low levels for an extended period of time.

- An exclusion zone of a 1-km radius around the suspected radiological hazard should be established.

(b) Case 2, Release From an RDD. If a high level of radiation is detected as a passing cloud, the release will likely have been intentional and involve large quantities of radiological material, which may continue at toxic levels for a considerable downwind distance.

- The cloud of radiological particles will be transported like a biological agent cloud, so the biological procedures from Appendix F for a Type S attack should be used.

- If the radiological release is observed, the corresponding biological attack Type P or R should be used.

(c) Case 3, Release From Biological-Agent Bunkers or Production Facilities. Storage facilities for biological agents usually consist of underground concrete shelters. These shelters are closer to the ground surface. Damage to such a facility may release some biological material from the shelter into the atmosphere as a jet of biological agent, smoke, dust, and soil. The release area will be localized, and the amount of viable agent dispersed will likely be less than that dispersed from an efficient biological weapon. However, since many biological agents require only a few inhaled organisms to affect a person, the downwind distance of the hazard area may still be considerable.

- The biological-hazard area prediction procedures in Appendix F should be used for a Type P attack. If the release takes more than 5 minutes, the latest arrival time may need to be adjusted for the duration of the release. For wind speeds ≤ 10 kph, Type P must be used.

- Hazard areas for extended duration releases should be recalculated as a Type R attack where the end points of the line are the release location and the current position of the front end of the cloud, using 1.5 times the mean wind speed.

- If the release is reported as continuous and the reported duration exceeds 2 hours or is not reported, the procedures for Type S should be followed.

- If the bulk of the material is elevated to a high altitude (above 50 m), the wind speed and bearing at that height from the CBRN BWM or other appropriate MET data should be used. If the material extends continuously from near the ground to a high elevation, the procedures for an elevated release should also be used.

(d) Case 4, Release from a Chemical Stockpile or TIM Transport/Storage. Incidents involving the release of chemical agents from a stockpile of munitions or bulk storage will usually involve only a small number of munitions. In such a case, the downwind hazard will be considerably smaller than that predicted using the procedures in Appendix E. In the case of a chemical-agent release from a large number of munitions or bulk storage of chemical agents, the agent quantity will be sufficient to warrant the use of Appendix E. Because of their lower toxicity and stability, the incidental release of a TIM from transport vehicles is expected to affect an area considerably smaller than that predicted using the chemical-agent procedures. The procedure to use is determined as follows:

- If a chemical stockpile or bulk storage mass is released that exceeds 200 liters, use the procedures in Appendix E for the appropriate agent and persistency.
- If there is a small chemical stockpile mass released or if there is a single leaking munition or TIM release from a transport vehicle, use the following procedure (adapted from the *Emergency Response Guidebook* [ERG]).
 - Release Area. The release area is assumed to be a circle having a radius equal to the isolation distance from the ERG (see Figure H-5). The 4-digit United Nations (UN) or North American (NA) identification number should be annotated on line INDIA. If the identification number or the ERG is not available, use a radius of 915 meters. If the distance is not found in the green section of the ERG, the orange section should be consulted before using the default distance. If more information is available, a different radius may be specified in GENTEXT. Draw the circle of the specified radius, centered at the release location.
 - Protective Action Distance. Obtain the protective action distance from the ERG using the 4-digit UN or NA identification number and the size of the spill as annotated on line GOLF. If the size of the spill is not available, assume large (LRG). If the identification number is not available, use a distance of 11 km. If the distance is not found in the green section of the ERG, the orange section should be consulted before using the default distance. If the spill is greater than 1,500 kg (extra large [XLG]), double the protective action distance.

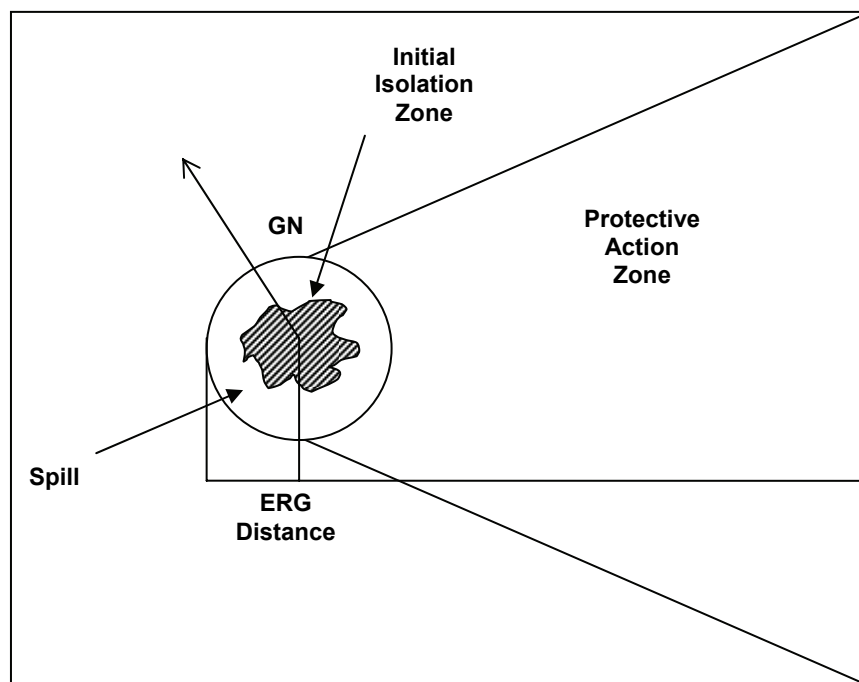

Figure H-5. Type T, Case 4: Small Methyl Isocyanate (UN/NA ID #2480) Spill at Night

- Wind Speed ≤ 10 kph. The wind direction is considered to be variable, so draw another circle of radius equal to the protective action distance, centered at the release location.

- Wind Speed > 10 kph. Draw a line in the downwind direction starting at the release location, of a length equal to the protective action distance. (For the remaining steps, follow the drawing procedures from Appendix E rather than from the ERG.) Draw a line at the end of the downwind direction line, perpendicular to the downwind direction. Extend the downwind direction line in the upwind direction a distance equal to twice the release area radius. Draw two lines from the upwind end of the downwind direction line to the perpendicular line at the other end, which are tangent to the top and bottom of the release area circle (see Figure H-5).

- Elevation. If the bulk of the material is elevated to a high altitude, the wind speed and bearing at that height from the CBRN BWM or other appropriate MET data should be used. If the material extends continuously from near the ground to high elevation (above 50 m), the procedures for an elevated release should also be used.

- Limitations. The initial hazard area is considered valid until additional information is available. When significant changes in weather conditions occur, a recalculation must be carried out (see Appendix E).

(e) Case 5, Release from a Bulk Storage Tank. Chemical storage tanks can contain thousands of liters of TIC. Many of these chemicals exist as gases under atmospheric conditions and are stored as a liquid under high pressure and low temperatures. Some of the chemicals are extremely flammable as a vapor cloud. Damage

to one of these tanks can result in the stored liquid being ejected very quickly as a large pool of very cold liquid. The pool will evaporate to form a vapor cloud, which is denser than the surrounding air due to the lower temperature and differences in molecular weight. This cloud will initially be affected more by gravity than the wind. The cloud will begin to dilute by being mixed with surrounding air. Eventually, the cloud will no longer be denser than the air and will move with the air as any other vapor or aerosol cloud. At this point, however, the cloud concentration will most likely be low enough that it is no longer toxic. So, any prediction procedures must focus on the behavior of the cloud before it has been diluted. This behavior will be different than that predicted by assuming the hazard area with the ERG. A simplified hazard is comprised of a circle, with the release location at its center. The radius of the circle should be 2 km for the daytime and 6 km for nighttime (see Figure H-6).

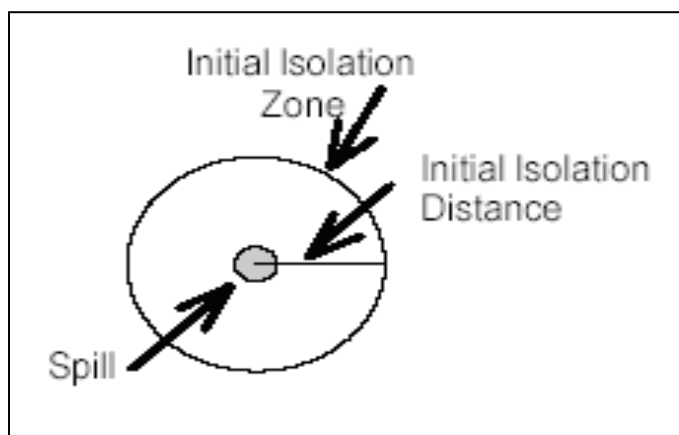

Figure H-6. Type T, Case 5

(3) Hazard Prediction for Elevated Releases.

(a) If the release, momentum, or buoyancy carries the material significantly (>50 m) above the ground surface, the hazard prediction should be repeated using 2,000 m elevation from the CBRN BWM. The hazard area for an elevated release is considered to be a combined hazard area, including spaces in between (see Figure H-7).

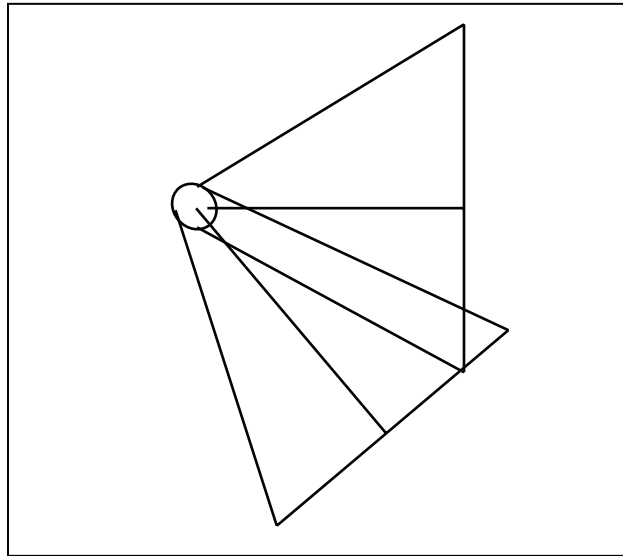

Figure H-7. Type T, Case 4: GB Rocket Stockpile Fire During the Day

(b) If merging or combining hazard regions for elevated releases or changing MET conditions involves two triangular hazard regions having downwind directions that are different by more than 90 degrees, the regions to be merged should be replaced with a circle of a radius equal to the larger of the downwind distances. The time of arrival at a location should be the earliest time resulting from the BWM or CDM.

(c) Changes in MET conditions in the following BWMs should be handled in the same manner as using CDMs.

7. NBC4 ROTA Report

The NBC4 ROTA Report (Figure H-8, page H-18) is utilized to pass subsequent off-target monitoring data or the results of a deliberate directed survey. The report will use the information as described in Chapter III for lines ALFA, INDIA, QUEBEC, ROMEO, SIERRA, TANGO, WHISKEY, YANKEE, and ZULU. Line GENTEXT in this message will provide the initial background reading taken by the survey team for a nuclear or radiological release. Readings for line ROMEO will indicate a reading above the initial reported background reading and measured values for chemical and biological releases. Decimals may be entered into line ROMEO if the reading is below 1 in the relevant unit of measurement recorded (e.g., 0.123456 cGy/h).

a. Purpose. The purpose of the NBC4 ROTA report is to report detection data and pass monitoring and survey results. This report is used for two cases. Case 1 is used if an attack is not observed and the first indication of contamination is by detection. Case 2 is used to report the measured contamination as a part of a survey or monitoring team mission.

b. Precedence. All other messages after the initial NBC1 ROTA report has been sent should be given a precedence, which reflects the operational value of the contents. Normally, IMMEDIATE would be appropriate.

c. Preparation. For detailed information regarding CBRN/ROTA reconnaissance, monitoring, and survey, refer to *Multiservice Tactics, Techniques, and Procedures for Nuclear, Biological, and Chemical Reconnaissance*.

| NBC4 ROTA Report | | | |
|------------------|---|-------|------------------------------|
| Line Item | Description | Cond* | Example |
| ALFA | Strike serial number | O | ALFA/US/WEP/001/RN// |
| INDIA | Release information on CB agent attacks or ROTA events | O | INDIA/SURF/2978/-/SPEC// |
| QUEBEC** | Location of reading/sample/detection and type of sample/detection | M | QUEBEC/32VNJ481203/GAMMA/-// |
| ROMEO** | Level of contamination, dose rate trend and decay rate trend | O | ROMEO/7CGH/DECR/DF// |
| SIERRA** | DTG of reading or initial detection of contamination | M | SIERRA/202300ZSEP1997// |
| TANGO** | Terrain/topography and vegetation description | M | TANGO/URBAN/URBAN// |
| WHISKEY | Sensor information | O | WHISKEY/-/POS/NO/HIGH// |
| YANKEE** | Downwind direction and downwind speed | M | YANKEE/270DGT/015KPH// |
| ZULU** | Actual weather conditions | O | ZULU/4/10C/7/5/1// |
| GENTEXT | General text | O | - |

*The Cond column shows that each line item is operationally determined (O) or mandatory (M).

**Sets QUEBEC, ROMEO, SIERRA, and TANGO are a segment. With the exception of line ROMEO, this segment is mandatory. Line items/segments are repeatable up to 20 times in order to describe multiple detection, monitoring, or survey points.

Figure H-8. Sample NBC4 ROTA Report

8. NBC5 ROTA Report

The NBC5 ROTA Report (Figure H-9) outlines the actual extent of the ROTA ground contamination from the survey data. The report uses information as described above for lines ALFA, CHARLIE, INDIA, YANKEE, ZULU, and GENTEXT. Line OSCAR indicates the time for which the contour is appropriate. Line XRAYA describes the level of the contamination for the contour and the ground contaminated area resulting from any ROTA event, whether it is radiological, biological, or chemical.

a. Purpose. The purpose of the NBC5 ROTA report is to pass information on areas of actual contamination. This report can include areas of possible contamination, but only if the actual contamination coordinates are included in the report.

b. Precedence. All other messages after the initial NBC1 ROTA report has been sent should be given a precedence, which reflects the operational value of the contents. Normally, IMMEDIATE would be appropriate.

| NBC5 ROTA Report | | | |
|--|--|-------|---|
| Line Item | Description | Cond* | Example |
| ALFA | Strike serial number | O | ALFA/US/WEP/001/RN// |
| CHARLIE | DTG of report/observation and event end | O | CHARLIE/281530ZSEP1997// |
| INDIA | Release information on CB agent attacks or ROTA events | M | INDIA/SURF/2978/-/SPEC// |
| OSCAR | Reference DTG for estimated contour lines | M | OSCAR/281830ZSEP1997// |
| XRAYA** | Actual contour information | M | XRAY ALFA /0.003CGH/334015N1064010W/ 334020N1064010W/ 334020N1064020W/ 334015N1064020W/ 334015N1064010W// |
| XRAYB** | Predicted contour information | O | |
| YANKEE | Downwind direction and downwind speed | O | YANKEE/270DGT/015KPH// |
| ZULU | Actual weather conditions | O | ZULU/4/10C/7/5/1// |
| GENTEXT | General text | O | |
| *The Cond column shows that each line item is operationally determined (O) or mandatory (M). | | | |
| **Sets are repeatable up to 50 times to represent multiple contours. | | | |

Figure H-9. Sample NBC5 ROTA Report

c. Preparation.

(1) Contaminated areas are shown on the contamination situation map, and information about them must be passed to the other units and higher HQ. The most expeditious means for this is the contamination overlay.

(2) The preparation of this overlay is described in each respective appendix (e.g., for the chemical contamination overlay, refer to Appendix E). Overlays are preferred for transmission of NBC3 and NBC5 ROTA reports (see Figure H-10, page H-20). They offer the advantages of being readily usable and accurate, and they are in hard copy for future references. Overlays have the disadvantages of requiring special equipment or messengers.

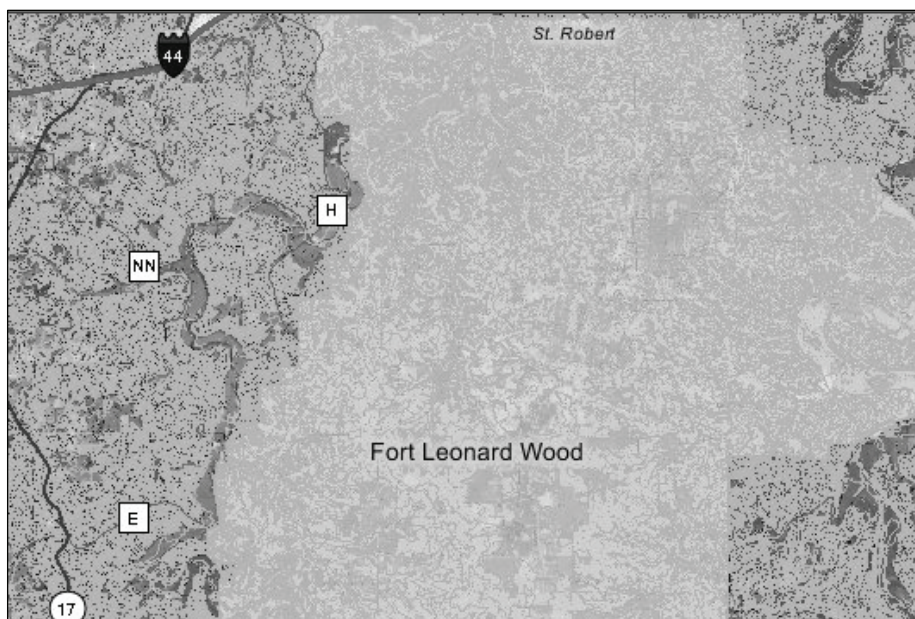

Figure H-10. Sample NBC5 ROTA Report Overlay (Without Marginal Data)

(3) Marginal information that should be included on the overlay includes the following:

- Map name.
- Map number.
- Scale.
- Organization of preparer.
- A legend containing nonstandard symbols/colors.
- Type of report.
- Lines of the report.
- Grid register marks.

d . Reporting Data.

(1) Electronic communications are not always available. If this is the case, the contamination overlay must be converted into a series of readings and coordinates for transmission as an NBC5 ROTA report.

(2) If electronic communications of the data or communications of a hard copy are not available and if time and distance permit, contamination overlays are sent by messenger. Data is transmitted manually by the NBC5 ROTA report as a last resort.

(3) On the NBC5 ROTA report, a closed contour line on a plot is represented by repeating the first coordinate.

9. NBC6 ROTA Report

The NBC6 ROTA report (Figure H-11) will be used to provide specific information (in line GENTEXT) required to produce a more detailed ROTA hazard prediction.

a. Purpose. The purpose of the NBC6 ROTA report is to pass detailed information of a ROTA event.

b. Precedence. All other messages after the initial NBC1 ROTA report has been sent should be given a precedence, which reflects the operational value of the contents. Normally, IMMEDIATE would be appropriate.

c. Preparation. This report summarizes the information concerning a ROTA and is prepared by the reporting unit, service equivalent, or higher organization, but only if requested by higher HQ. It is used as an intelligence tool to help determine the enemy's future intentions.

d. Submission. The NBC6 ROTA report is submitted to the higher HQ. It is written in a narrative form with as much detail as possible.

| NBC6 ROTA Report | | | |
|--|--|-------|--|
| Line Item | Description | Cond* | Example |
| ALFA | Strike serial number | O | ALFA/US/WEP/001/RN// |
| CHARLIE | DTG of report/observation and event end | O | CHARLIE/281530ZSEP1997/ 281545ZSEP1997// |
| FOXTROT | Location of attack or event | O | FOXTROT/32UNB058640/EE// |
| INDIA | Release information on CB agent attacks or ROTA events | O | INDIA/SURF/2978/-/SPEC/-// |
| QUEBEC | Location and type reading/sample/detection | O | QUEBEC/32VNJ481203/GAMMA// |
| SIERRA | DTG of reading | O | SIERRA/282300ZSEP1997// |
| GENTEXT | General text | M | GENTEXT/CBRN INFO/HOSPITAL VEHICLE CARRYING RADIOACTIVE WASTE OVERTURNED ON ROUTE 25// |
| *The Cond column shows that each line item is operationally determined (O) or mandatory (M). | | | |

Figure H-11. Sample NBC6 ROTA Report

THIS PAGE IS INTENTIONALLY LEFT BLANK.

Appendix I

STRIKE WARNING

1. Background

This appendix addresses friendly nuclear attack warning messages and procedures.

2. Friendly Nuclear-Attack Warning

The use of friendly nuclear attack warning is a vital part in the US ability to conduct full-spectrum operations. It ensures the safety of US forces and their allies.

a. Nuclear STRIKWARN. STRIKWARN is a system for the warning of friendly nuclear strikes. This system applies to nuclear strikes that may affect forces operating on land, over land, or at sea. The requirement for a standard warning message and for the delineation of the notification channels is essential to ensure that friendly units get a timely warning of a friendly nuclear strike. This allows personnel and units to take the appropriate measures to protect themselves and their equipment and still be prepared to exploit the weapon effects.

b. Responsibilities. The responsibility for issuing a warning rests with the coordinating commander. The coordinating commander is defined as the regional commander who coordinates the activities of nuclear delivery and supporting units. Commanders authorized to release nuclear strikes will ensure that strikes affecting the safety of adjacent or other commands are coordinated. Commanders must allow sufficient time to permit dissemination of the warnings to personnel so that they can take protective measures, and they must prepare for exploiting the effects of the weapons.

c. Recipients. The commander responsible for disseminating the STRIKWARN must inform the following units:

- (1) Subordinate HQ whose units are likely to be affected by the strike.
- (2) Any land, air, and naval HQ/commands whose units are likely to be affected by the strike.
- (3) Next higher level of command when the units that are not under the command of the coordinating commander are likely to be affected by the strike.
- (4) Each unit concerned, down to the lowest level. Units will be warned by their next higher HQ as to the level of the safety measures they should take, depending on their proximity to the target.

NOTE: Only the information which is of direct interest to the units concerned will be disseminated.

d. Warnings.

(1) Impending STRIKWARN. A warning of an impending strike will be initiated no earlier than is necessary to complete the warning of personnel. Any means of communication chosen by the staff, preferably secure, will be used to ensure that all affected personnel are warned.

(2) Use of Codes. STRIKWARN messages should be classified with regard to current OPSEC instructions. If secure electronic means are not available, the message should be encrypted. Only circuits and coding systems which meet the appropriate security criteria will be used. Messages may be sent in the clear when the coordinating commander determines that safety warnings override security requirements. A warning message will not normally be sent in the clear earlier than 1 hour before the strike or time on target.

(3) Precedence. Messages will be transmitted with the precedence adequate to ensure the timely warning of all personnel expected to be affected by the strike.

(4) Action on Canceled Attacks (Strikes). When strikes are canceled, the units previously warned will be notified in the clear by the most expeditious means. The message will be authenticated. For multiple strikes, all strikes have to be canceled before disseminating cancellation messages. The target number or nickname of the strike should be included.

(5) Other Warnings. Dazzle warnings are to be passed to all flying units or squadrons in the region. For dazzle warnings, only lines ALFA, DELTA, FOXTROT ONE (designated ground zero [DGZ] only), and INDIA are sent.

e. NBC3 Reports. When line HOTEL of the STRIKWARN indicates a surface or subsurface burst, an NBC3 report will be transmitted as soon as possible after the STRIKWARN. The development and transmission of this message is the responsibility of the coordinating commander anytime the analysis indicates that fallout could affect friendly units.

f. Units of Measurement. Standard ground units of measure will be used for the coordinates (UTM grid) and distance (meters). Organizations (e.g., Naval) which use different units (e.g., LAT/LONG) will be responsible for converting the units for retransmission to their subordinate units and for providing warning messages to land forces in ground units when the effects of their weapons may be experienced by those land forces.

g. Line Items Used in STRIKWARN Messages. The list of message line items in Table I-1 provides an overview of the STRIKWARN message format, serves to give the user a total picture of the line items available for the message, and provides the order of use for line items.

Table I-1. Line Items for STRIKWARN Messages

| Line Item | Meaning |
|-------------|--|
| ALFA | STRIKWARN target Identifier (Target number, nickname, or code word) |
| DELTA | DTG of strike or strike cancelled (Multiple bursts: DTG attack will start, followed by DTG attack will end. Single Burst: DTG of attack, followed by DTG after which the attack will be cancelled.) |
| FOXTROT ONE | MSD 1 (Multiple Bursts: UTM grid coordinates of MSD 1 box. Single Burst: MSD 2, three digits, in hundreds of meters, followed by MSD 2 box coordinates.) |
| FOXTROT TWO | MSD 2 (Multiple bursts: UTM grid coordinates of MSD 2 box. Single burst: MSD 2, three digits, in hundreds of meters, followed by MSD 1 box coordinates.) |
| HOTEL | Number of surface bursts (If one or more bursts have less than 99% assurance of being an airburst or if it is a scheduled surface or subsurface burst, the number of surface bursts will be reported on this line.) |
| INDIA | Number of bursts in a multiple strike (Not reported if only one) |
| AKNLDG | Acknowledge requirement |

3. Zones of Warning and Protection Requirements

Zones of warning and protection signify various degrees of danger to US forces.

a. The MSD is equal to the radius of safety (RS) for the yield, plus a buffer distance (BD) related to the dispersion of the weapon system used. When surface bursts are used or an intended air burst having less than 99 percent assurance of no militarily significant fallout, the fallout hazard will be considered. Details will be transmitted in a subsequent NBC3 NUC message if fallout will be a hazard to friendly forces.

b. Commanders will be governed by the safety criteria in JP 3-12.2 or the specific service manual addressing nuclear safety.

c. If a unit commander is unable to evacuate Zone 1, he will immediately require the maximum protection and report through his next higher HQ to the releasing/executing commander.

d. Negligible risk should not normally be exceeded unless significant advantage will be gained.

e. Maximum protection for the ground forces denotes that personnel are in buttoned-up tanks or sheltered in foxholes with an overhead shielding.

f. Minimum protection for ground forces denotes that personnel are prone on open ground with all skin areas covered and with an overall thermal protection at least equal to that provided by a two-layer uniform.

g. Since the least separation distance (LSD) for light aircraft is exceeded by MSD 2, aircraft remaining beyond MSD 2 will avoid significant degradation of the aircraft or pilot performance (except Dazzle) severe enough to prevent mission accomplishment.

h. When a unit receives a STRIKWARN message, the first action is to plot it on the tactical (situation) map. This identifies GZ or DGZ and how far the MSDs extend. The commander can then determine what actions to take. Figure I-1 shows a plotted STRIKWARN for a single burst.

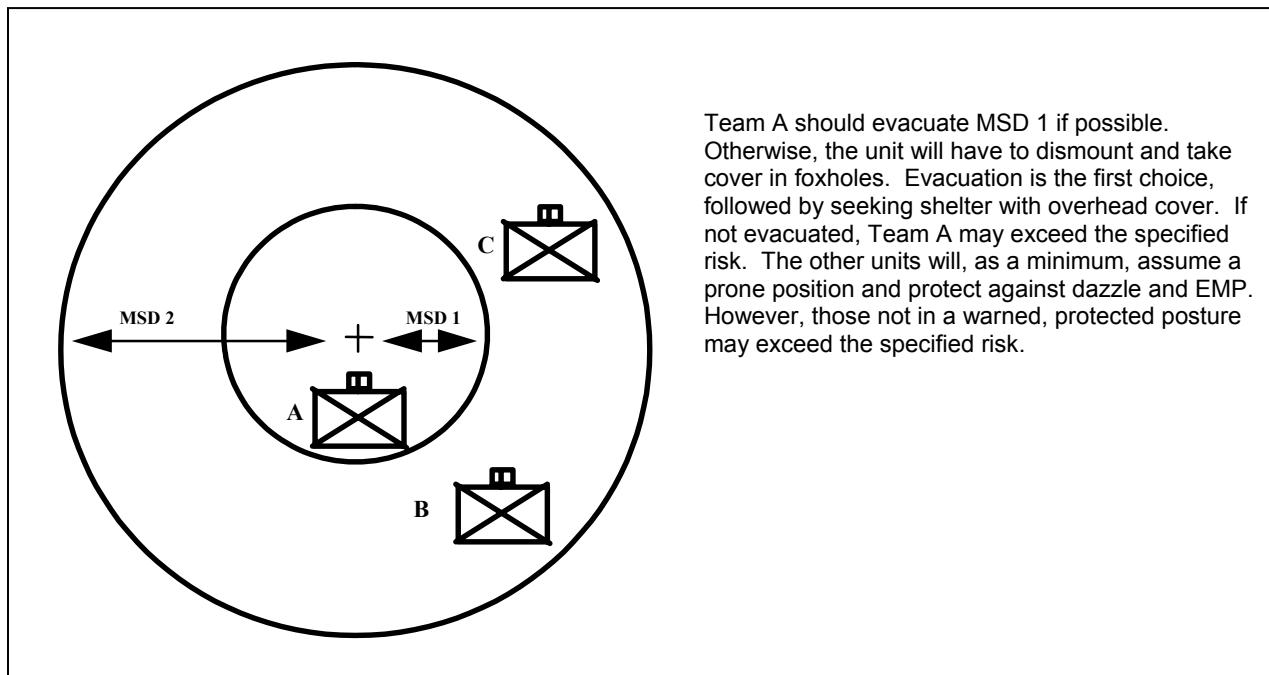

Figure I-1. STRIKWARN Plot Showing MSD 1 and MSD 2, Single-Burst

4. Plotting a STRIKWARN Message

Effectively plotting a STRIKWARN message is paramount to establishing a unit's actions during a friendly nuclear attack.

a. Single Burst (Figure I-1).

(1) Step 1. Locate the GZ grid coordinates from line FOXTROT of the STRIKWARN message, and then plot GZ.

(2) Step 2. Draw MSD circles around GZ. The first 3 digits of line FOXTROT is the radius of the MSD.

(3) Step 3. Label the edge of the circles with the appropriate MSD.

(4) Step 4. Label the marginal information on the map sheet. Marginal information includes STRIKWARN message, NBC3 report, prepared-by unit, and map scale.

b. Multiple Bursts (Figure I-2).

- (1) Step 1. Plot the GZ for each burst from line FOXTROT of the STRIKWARN message.
- (2) Step 2. Construct tangent lines from each point to form a box.
- (3) Step 3. Label MSDs 1 and 2 along the corresponding tangent lines.
- (4) Step 4. Label the marginal information on the map sheet. Marginal information includes STRIKWARN message, NBC3 report, prepared-by unit, and map scale.

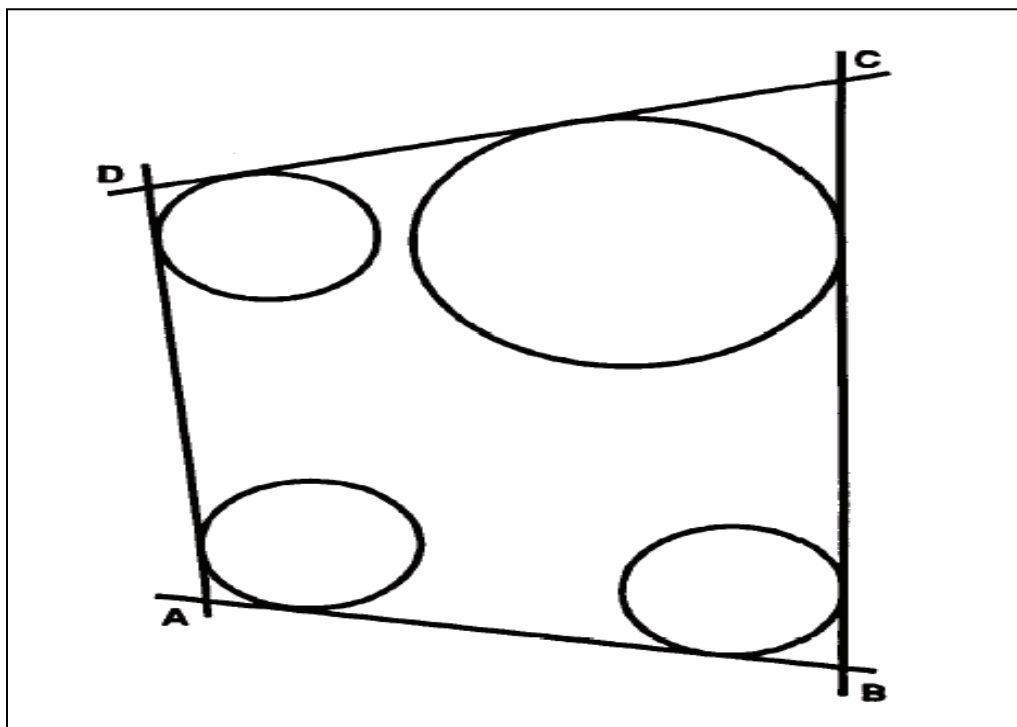

Figure I-2. STRIKWARN Plot Showing Multiple Bursts

THIS PAGE IS INTENTIONALLY LEFT BLANK.

Appendix J

NOMOGRAMS, TABLES, AND GRAPHS

This appendix provides a single reference for nomograms, tables, and graphs. The nomograms, tables, and graphs referenced in earlier appendixes will be found here. The procedures to use them are found in the appropriate appendix.

NOTES:

1. Above 18,000 meters, altitude layers for plotting vector diagrams continue to be at 2,000-meter intervals. However, the map distance factors vary so little that some of the columns in Tables J-1 through J-6 (pages J-1 through J-3) are combined for convenience.
2. Uses for Tables J-7 through J-13 (pages J-4 through J-9) and Figures J-1 through J-54 (pages J-10 through J-62) are referenced throughout the previous chapters and appendixes of this manual.

Table J-1. Map Distance, in cm, Map Scale 1:50,000, Wind Speed in KM/H

| Wind Speed (km/h) | Altitude Layers (Thousands of Meters) | | | | | | | | | | | |
|-------------------|---------------------------------------|------|------|------|------|-------|-------|-------|-------|-------|-------|------|
| | 0-2 | 2-4 | 4-6 | 6-8 | 8-10 | 10-12 | 12-14 | 14-16 | 16-18 | 18-22 | 22-30 | >30 |
| 5 | 6.8 | 5.8 | 5.2 | 5.0 | 4.8 | 4.4 | 4.2 | 4.0 | 3.8 | 3.8 | 3.6 | 3.4 |
| 10 | 13.6 | 11.8 | 10.4 | 10.0 | 9.6 | 9.0 | 8.4 | 8.0 | 7.8 | 7.6 | 7.2 | 6.8 |
| 15 | 20.4 | 17.6 | 15.6 | 15.0 | 14.4 | 13.4 | 12.6 | 12.0 | 11.6 | 11.2 | 10.8 | 10.2 |
| 20 | 27.2 | 23.6 | 20.8 | 20.0 | 19.2 | 18.0 | 16.8 | 16.0 | 15.6 | 15.0 | 14.2 | 13.6 |
| 25 | 34.0 | 29.4 | 26.0 | 25.2 | 24.0 | 22.4 | 21.0 | 20.0 | 19.4 | 18.8 | 17.8 | 17.0 |

Table J-2. Map Distance, in cm, Map Scale 1:50,000, Wind Speed in Knots

| Wind Speed (Knots) | Altitude Layers (Thousands of Meters) | | | | | | | | | | | |
|--------------------|---------------------------------------|------|------|------|------|-------|-------|-------|-------|-------|-------|------|
| | 0-2 | 2-4 | 4-6 | 6-8 | 8-10 | 10-12 | 12-14 | 14-16 | 16-18 | 18-22 | 22-30 | >30 |
| 5 | 12.6 | 11.0 | 9.6 | 9.4 | 9.0 | 8.4 | 7.8 | 7.4 | 7.2 | 7.0 | 6.6 | 6.4 |
| 10 | 25.2 | 21.8 | 19.2 | 18.6 | 17.8 | 16.6 | 15.6 | 14.8 | 14.4 | 14.0 | 13.2 | 12.6 |
| 15 | 37.8 | 32.8 | 28.8 | 28.0 | 26.8 | 25.0 | 23.4 | 22.2 | 21.6 | 20.8 | 19.6 | 19.0 |
| 20 | 50.4 | 43.6 | 38.4 | 37.2 | 35.6 | 33.2 | 31.2 | 29.6 | 28.8 | 27.8 | 26.2 | 25.2 |
| 25 | 63.0 | 54.6 | 48.0 | 46.6 | 44.6 | 41.2 | 39.0 | 37.0 | 36.0 | 34.8 | 32.8 | 31.6 |
| 30 | 65.6 | 65.4 | 57.6 | 55.8 | 53.4 | 49.8 | 46.8 | 44.4 | 43.2 | 41.8 | 39.4 | 37.8 |

Table J-3. Map Distance, in cm, Map Scale 1:100,000, Wind Speed in KM/H

| Wind Speed (km/h) | Altitude Layers (Thousands of Meters) | | | | | | | | | | | |
|-------------------|---------------------------------------|------|------|------|------|-------|-------|-------|-------|-------|-------|------|
| | 0-2 | 2-4 | 4-6 | 6-8 | 8-10 | 10-12 | 12-14 | 14-16 | 16-18 | 18-22 | 22-30 | >30 |
| 5 | 3.4 | 2.9 | 2.6 | 2.5 | 2.4 | 2.2 | 2.1 | 2.0 | 1.9 | 1.9 | 1.8 | 1.7 |
| 10 | 6.8 | 5.9 | 5.2 | 5.0 | 4.8 | 4.5 | 4.2 | 4.0 | 3.9 | 3.8 | 3.6 | 3.4 |
| 15 | 10.2 | 8.8 | 7.8 | 7.5 | 7.2 | 6.7 | 6.3 | 6.0 | 5.8 | 5.6 | 5.4 | 5.1 |
| 20 | 13.6 | 11.8 | 10.4 | 10.0 | 9.6 | 9.0 | 8.4 | 8.0 | 7.8 | 7.5 | 7.1 | 6.8 |
| 25 | 17.0 | 14.7 | 13.0 | 12.6 | 12.0 | 11.2 | 10.5 | 10.0 | 9.7 | 9.4 | 8.9 | 8.5 |
| 30 | 20.4 | 17.7 | 15.6 | 15.1 | 14.4 | 13.4 | 12.6 | 12.0 | 11.7 | 11.3 | 10.7 | 10.2 |
| 35 | 23.8 | 20.6 | 18.1 | 17.6 | 16.8 | 15.7 | 14.7 | 14.0 | 13.6 | 13.1 | 12.5 | 11.9 |
| 40 | 27.2 | 23.6 | 20.7 | 20.1 | 19.2 | 17.9 | 16.8 | 16.0 | 15.6 | 15.0 | 14.3 | 13.6 |
| 45 | 30.6 | 26.5 | 23.3 | 22.6 | 21.6 | 20.2 | 19.0 | 18.0 | 17.5 | 16.9 | 16.1 | 15.3 |
| 50 | 34.0 | 29.5 | 25.9 | 25.1 | 24.0 | 22.4 | 21.1 | 20.0 | 19.4 | 18.8 | 17.9 | 17.0 |

Table J-4. Map Distance, in cm, Map Scale 1:100,000, Wind Speed in Knots

| Wind Speed Knots | Altitude Layers (Thousands of Meters) | | | | | | | | | | | |
|------------------|---------------------------------------|------|------|------|------|-------|-------|-------|-------|-------|-------|------|
| | 0-2 | 2-4 | 4-6 | 6-8 | 8-10 | 10-12 | 12-14 | 14-16 | 16-18 | 18-22 | 22-30 | >30 |
| 5 | 6.3 | 5.5 | 4.8 | 4.7 | 4.5 | 4.2 | 3.9 | 3.7 | 3.6 | 3.5 | 3.3 | 3.2 |
| 10 | 12.6 | 10.9 | 9.6 | 9.3 | 8.9 | 8.3 | 7.8 | 7.4 | 7.2 | 7.0 | 6.6 | 6.3 |
| 15 | 18.9 | 16.4 | 14.4 | 14.0 | 13.4 | 12.5 | 11.7 | 11.1 | 10.8 | 10.4 | 9.8 | 9.5 |
| 20 | 25.2 | 21.8 | 19.2 | 18.6 | 17.8 | 16.6 | 15.6 | 14.8 | 14.4 | 13.9 | 13.1 | 12.6 |
| 25 | 31.5 | 27.3 | 24.0 | 23.3 | 22.3 | 20.6 | 19.5 | 18.5 | 18.0 | 17.4 | 16.4 | 15.8 |
| 30 | 37.8 | 32.7 | 28.8 | 27.9 | 26.7 | 24.9 | 23.4 | 22.2 | 21.6 | 20.9 | 19.7 | 18.9 |
| 35 | 44.1 | 38.2 | 33.6 | 32.6 | 31.2 | 29.1 | 27.3 | 25.9 | 25.2 | 24.3 | 22.9 | 22.1 |
| 40 | 50.4 | 43.6 | 38.4 | 37.2 | 35.6 | 33.2 | 31.2 | 29.6 | 28.8 | 27.8 | 26.2 | 25.2 |
| 45 | 56.7 | 49.1 | 43.2 | 41.9 | 40.1 | 37.4 | 35.1 | 33.3 | 32.4 | 31.3 | 29.5 | 28.4 |
| 50 | 63.0 | 54.5 | 48.0 | 46.5 | 44.5 | 41.5 | 39.0 | 37.0 | 36.0 | 34.8 | 32.8 | 31.5 |

Table J-5. Map Distance, in cm, Map Scale 1:250,000, Wind Speed in KM/H

| Wind Speed (km/h) | Altitude Layers (Thousands of Meters) | | | | | | | | | | | |
|-------------------|---------------------------------------|------|------|------|------|-------|-------|-------|-------|-------|-------|------|
| | 0-2 | 2-4 | 4-6 | 6-8 | 8-10 | 10-12 | 12-14 | 14-16 | 16-18 | 18-22 | 22-30 | >30 |
| 5 | 1.4 | 1.2 | 1.0 | 1.0 | 1.0 | 0.9 | 0.8 | 0.8 | 0.8 | 0.8 | 0.7 | 0.7 |
| 10 | 2.7 | 2.4 | 2.1 | 2.0 | 1.9 | 1.8 | 1.7 | 1.6 | 1.6 | 1.5 | 1.4 | 1.4 |
| 15 | 4.1 | 3.5 | 3.1 | 3.0 | 2.9 | 2.7 | 2.5 | 2.4 | 2.3 | 2.3 | 2.1 | 2.0 |
| 20 | 5.4 | 4.7 | 4.1 | 4.0 | 3.8 | 3.6 | 3.4 | 3.2 | 3.1 | 3.0 | 2.9 | 2.7 |
| 25 | 6.8 | 5.9 | 5.2 | 5.0 | 4.8 | 4.5 | 4.2 | 4.0 | 3.9 | 3.8 | 3.6 | 3.4 |
| 30 | 8.2 | 7.1 | 6.2 | 6.0 | 5.8 | 5.4 | 5.1 | 4.8 | 4.7 | 4.5 | 4.3 | 4.1 |
| 35 | 9.5 | 8.2 | 7.3 | 7.0 | 6.7 | 6.3 | 5.9 | 5.6 | 5.4 | 5.3 | 5.0 | 4.8 |
| 40 | 10.9 | 9.4 | 8.3 | 8.0 | 7.7 | 7.2 | 6.7 | 6.4 | 6.2 | 6.0 | 5.7 | 5.4 |
| 45 | 12.2 | 10.6 | 9.3 | 9.0 | 8.6 | 8.1 | 7.6 | 7.2 | 7.0 | 6.8 | 6.4 | 6.1 |
| 50 | 13.6 | 11.8 | 10.4 | 10.0 | 9.6 | 9.0 | 8.4 | 8.0 | 7.8 | 7.5 | 7.1 | 6.8 |
| 55 | 15.0 | 12.9 | 11.4 | 11.0 | 10.6 | 9.9 | 9.3 | 8.8 | 8.6 | 8.3 | 7.9 | 7.5 |
| 60 | 16.3 | 14.1 | 12.4 | 12.0 | 11.5 | 10.8 | 10.1 | 9.6 | 9.3 | 9.0 | 8.6 | 8.2 |
| 75 | 20.4 | 17.7 | 15.5 | 15.1 | 14.4 | 13.4 | 12.6 | 12.0 | 11.7 | 11.3 | 10.7 | 10.2 |
| 100 | 27.2 | 23.5 | 20.7 | 20.1 | 19.2 | 17.9 | 16.9 | 16.0 | 15.6 | 15.0 | 14.3 | 13.6 |

Table J-6. Map Distance, in cm, Map Scale 1:250,000, Wind Speed in Knots

| Wind Speed Knots | Altitude Layers (Thousands of Meters) | | | | | | | | | | | |
|------------------|---------------------------------------|------|------|------|------|-------|-------|-------|-------|-------|-------|------|
| | 0-2 | 2-4 | 4-6 | 6-8 | 8-10 | 10-12 | 12-14 | 14-16 | 16-18 | 18-22 | 22-30 | >30 |
| 5 | 2.5 | 2.2 | 1.9 | 1.9 | 1.8 | 1.7 | 1.6 | 1.5 | 1.4 | 1.4 | 1.3 | 1.3 |
| 10 | 5.0 | 4.4 | 3.8 | 3.7 | 3.6 | 3.3 | 3.1 | 3.0 | 2.9 | 2.8 | 2.6 | 2.5 |
| 15 | 7.6 | 6.5 | 5.8 | 5.6 | 5.3 | 5.0 | 4.7 | 4.4 | 4.3 | 4.2 | 3.9 | 3.8 |
| 20 | 10.1 | 8.7 | 7.7 | 7.4 | 7.1 | 6.6 | 6.2 | 5.9 | 5.8 | 5.6 | 5.2 | 5.0 |
| 25 | 12.6 | 10.9 | 9.6 | 9.3 | 8.9 | 8.3 | 7.8 | 7.4 | 7.2 | 7.0 | 6.6 | 6.3 |
| 30 | 15.1 | 13.1 | 11.5 | 11.2 | 10.7 | 10.0 | 9.4 | 8.9 | 8.6 | 8.3 | 7.9 | 7.6 |
| 35 | 17.6 | 15.3 | 13.4 | 13.0 | 12.5 | 11.6 | 10.9 | 10.4 | 10.1 | 9.7 | 9.2 | 8.8 |
| 40 | 20.2 | 17.4 | 15.4 | 14.9 | 14.2 | 13.3 | 12.5 | 11.8 | 11.5 | 11.1 | 10.5 | 10.1 |
| 45 | 22.7 | 19.6 | 17.3 | 16.7 | 16.0 | 14.9 | 14.0 | 13.3 | 13.0 | 12.5 | 11.8 | 11.3 |
| 50 | 25.2 | 21.8 | 19.2 | 18.6 | 17.8 | 16.6 | 15.6 | 14.8 | 14.4 | 13.9 | 13.1 | 12.6 |
| 55 | 27.7 | 24.0 | 21.1 | 20.5 | 19.6 | 18.3 | 17.2 | 16.3 | 15.8 | 15.3 | 14.4 | 13.9 |
| 60 | 30.2 | 26.2 | 23.0 | 22.3 | 21.4 | 19.9 | 18.7 | 17.8 | 17.3 | 16.7 | 15.7 | 15.1 |
| 75 | 37.8 | 32.7 | 28.8 | 27.9 | 26.7 | 24.9 | 23.4 | 22.2 | 21.6 | 20.9 | 19.7 | 18.9 |
| 100 | 50.4 | 43.6 | 38.4 | 37.2 | 35.6 | 33.2 | 31.2 | 29.6 | 28.8 | 27.8 | 26.2 | 25.2 |

Table J-7. Conversion Table, Degrees to Mils

| Degrees | Mils | Degrees | Mils | Degrees | Mils | Degrees | Mils |
|----------------|-------------|----------------|-------------|----------------|-------------|----------------|-------------|
| 1 | 17.78 | 65 | 1,155.55 | 165 | 2,933.33 | 265 | 4,711.11 |
| 2 | 35.55 | 70 | 1,244.44 | 170 | 3,022.22 | 270 | 4,800.00 |
| 3 | 53.33 | 75 | 1,333.33 | 175 | 3,111.11 | 275 | 4,888.89 |
| 4 | 71.11 | 80 | 1,422.22 | 180 | 3,200.00 | 280 | 4,977.78 |
| 5 | 88.89 | 85 | 1,511.11 | 185 | 3,288.89 | 285 | 5,066.67 |
| 6 | 106.67 | 90 | 1,600.00 | 190 | 3,377.78 | 290 | 5,155.55 |
| 7 | 124.44 | 95 | 1,688.89 | 195 | 3,466.67 | 295 | 5,244.44 |
| 8 | 142.22 | 100 | 1,777.78 | 200 | 3,555.55 | 300 | 5,333.33 |
| 9 | 160.00 | 105 | 1,866.67 | 205 | 3,644.44 | 305 | 5,422.22 |
| 10 | 177.78 | 110 | 1,955.55 | 210 | 3,733.33 | 310 | 5,511.11 |
| 15 | 266.67 | 115 | 2,044.44 | 215 | 3,822.22 | 315 | 5,600.00 |
| 20 | 355.55 | 120 | 2,133.33 | 220 | 3,911.11 | 320 | 5,688.89 |
| 25 | 444.44 | 125 | 2,222.22 | 225 | 4,000.00 | 325 | 5,777.78 |
| 30 | 533.33 | 130 | 2,311.11 | 230 | 4,088.89 | 330 | 5,866.67 |
| 35 | 622.22 | 135 | 2,400.00 | 235 | 4,177.78 | 335 | 5,955.55 |
| 40 | 711.11 | 140 | 2,488.89 | 240 | 4,266.67 | 340 | 6,044.44 |
| 45 | 800.00 | 145 | 2,577.78 | 245 | 4,355.55 | 345 | 6,133.33 |
| 50 | 888.89 | 150 | 2,666.67 | 250 | 4,444.44 | 350 | 6,222.22 |
| 55 | 977.78 | 155 | 2,755.55 | 255 | 4,533.33 | 355 | 6,311.11 |
| 60 | 1,066.67 | 160 | 2,844.44 | 260 | 4,622.22 | 360 | 6,400.00 |

Table J-8. Conversion Table and Distance Conversion Factors

| To convert | To | Multiply by |
|-------------------|----------------|--------------------|
| kilometers | miles | 0.62 |
| kilometers | nautical miles | 0.54 |
| miles | kilometers | 1.61 |
| miles | nautical miles | 0.87 |
| nautical miles | kilometers | 1.85 |
| nautical miles | miles | 1.15 |
| meters | feet | 3.28 |
| feet | meters | 0.30 |
| mph | km/h | 1.61 |
| mph | knots | 0.87 |
| mph | m/sec | 0.45 |
| mph | ft/sec | 1.47 |
| km/h | mph | 0.62 |
| km/h | knots | 0.54 |
| km/h | m/sec | 0.28 |
| km/h | ft/sec | 0.91 |
| knots | km/h | 1.85 |
| knots | mph | 1.15 |
| knots | m/sec | 0.51 |
| knots | ft/sec | 1.69 |
| m/sec | km/h | 3.60 |
| m/sec | mph | 2.24 |
| m/sec | knots | 1.94 |
| m/sec | ft/sec | 3.28 |
| ft/sec | km/h | 1.10 |
| ft/sec | mph | 0.68 |
| ft/sec | knots | 0.59 |
| ft/sec | m/s | 0.30 |
| kilograms | pounds | 2.20 |
| pounds | kilograms | 0.45 |
| gallons | litres | 3.79 |
| litres | gallons | 0.26 |

Table J-9. TFs/PFs

| Environmental Shielding | TF | PF |
|---|-----------|-----------|
| Armoured Vehicles: | | |
| M1 Tank | 0.0400 | 25.0000 |
| M48 Tank | 0.0200 | 50.0000 |
| M60 Tank | 0.0400 | 25.0000 |
| M2 IFV | 0.2000 | 5.0000 |
| M3 CFV | 0.2000 | 5.0000 |
| M113 Armored Personnel Carrier | 0.3000 | 3.3300 |
| M109 Special-Purpose Howitzer | 0.2000 | 5.0000 |
| M548 Cargo Vehicle | 0.7000 | 1.4300 |
| M88 Recovery Vehicle | 0.0900 | 11.1100 |
| M577 Command Post Carrier | 0.3000 | 3.3300 |
| M551 Armored Recon Airborne Assault Vehicle | 0.2000 | 5.0000 |
| M728 Combat Engineer Vehicle | 0.0400 | 25.0000 |
| Trucks: | | |
| ¼-ton | 0.8000 | 1.2500 |
| ¾-ton | 0.6000 | 1.6700 |
| 2½-ton | 0.6000 | 1.6700 |
| 4 to 7-ton | 0.5000 | 2.0000 |
| Structures: | | |
| <u>Multistory Building:</u> | | |
| Top floor | 0.0100 | 100.0000 |
| Lower floor | 0.1000 | 10.0000 |
| <u>Frame house:</u> | | |
| First floor | 0.6000 | 1.6700 |
| Basement | 0.1000 | 10.0000 |
| Urban Areas (In Open) | *0.7000 | *1.4300 |
| Woods | *0.8000 | *1.2500 |
| Underground shelters | 0.0002 | 10.0000 |
| Foxholes | 0.1000 | 10.0000 |
| *These factors apply to aerial survey dose rates. | | |

Table J-10. Normalizing Factors (Correction to H+1 Hour)

| Time After Burst | Decay Exponent (n) | | | | | | | |
|------------------|--------------------|-------|--------|--------|--------|--------|--------|---------|
| | 0.600 | 0.800 | 1.000 | 1.200 | 1.400 | 1.600 | 1.800 | 2.000 |
| 10 min | 0.341 | 0.238 | 0.167 | 0.116 | 0.081 | 0.057 | 0.040 | 0.028 |
| 20 min | 0.517 | 0.415 | 0.333 | 0.268 | 0.215 | 0.172 | 0.138 | 0.111 |
| 30 min | 0.660 | 0.574 | 0.500 | 0.435 | 0.379 | 0.330 | 0.287 | 0.250 |
| 40 min | 0.784 | 0.723 | 0.667 | 0.615 | 0.567 | 0.523 | 0.482 | 0.444 |
| 50 min | 0.896 | 0.864 | 0.833 | 0.803 | 0.775 | 0.747 | 0.720 | 0.694 |
| 1 hr 0 min | 1.000 | 1.000 | 1.000 | 1.000 | 1.000 | 1.000 | 1.000 | 1.000 |
| 1 hr 10 min | 1.090 | 1.130 | 1.160 | 1.200 | 1.240 | 1.280 | 1.320 | 1.360 |
| 1 hr 20 min | 1.180 | 1.250 | 1.330 | 1.410 | 1.490 | 1.580 | 1.670 | 1.770 |
| 1 hr 30 min | 1.270 | 1.380 | 1.500 | 1.620 | 1.760 | 1.910 | 2.070 | 2.250 |
| 1 hr 40 min | 1.350 | 1.500 | 1.660 | 1.840 | 2.040 | 2.260 | 2.500 | 2.770 |
| 1 hr 50 min | 1.430 | 1.620 | 1.830 | 2.070 | 2.330 | 2.630 | 2.970 | 3.360 |
| 2 hr 0 min | 1.510 | 1.740 | 2.000 | 2.290 | 2.630 | 3.030 | 3.480 | 4.000 |
| 2 hr 15 min | 1.620 | 1.910 | 2.250 | 2.640 | 3.110 | 3.660 | 4.300 | 5.060 |
| 2 hr 30 min | 1.730 | 2.080 | 2.500 | 3.000 | 3.600 | 4.330 | 5.200 | 6.250 |
| 2 hr 45 min | 1.830 | 2.240 | 2.750 | 3.360 | 4.120 | 5.040 | 6.170 | 7.560 |
| 3 hr 0 min | 1.930 | 2.400 | 3.000 | 3.730 | 4.650 | 5.800 | 7.220 | 9.000 |
| 3 hr 15 min | 2.020 | 2.560 | 3.250 | 4.110 | 5.200 | 6.590 | 8.340 | 10.560 |
| 3 hr 30 min | 2.120 | 2.720 | 3.500 | 4.490 | 5.770 | 7.420 | 9.530 | 12.250 |
| 3 hr 45 min | 2.210 | 2.870 | 3.750 | 4.880 | 6.360 | 8.280 | 10.790 | 14.060 |
| 4 hr 0 min | 2.290 | 3.030 | 4.000 | 5.270 | 6.960 | 9.190 | 12.120 | 16.000 |
| 4 hr 20 min | 2.410 | 3.230 | 4.330 | 5.810 | 7.790 | 10.440 | 14.000 | 18.770 |
| 4 hr 40 min | 2.520 | 3.420 | 4.660 | 6.350 | 8.640 | 11.760 | 16.000 | 21.770 |
| 5 hr 0 min | 2.620 | 3.620 | 5.000 | 6.890 | 9.510 | 13.130 | 18.110 | 25.000 |
| 5 hr 20 min | 2.730 | 3.810 | 5.330 | 7.450 | 10.410 | 14.560 | 20.350 | 28.440 |
| 5 hr 40 min | 2.830 | 4.000 | 5.660 | 8.010 | 11.340 | 16.040 | 22.690 | 32.110 |
| 6 hr 0 min | 2.930 | 4.190 | 6.000 | 8.580 | 12.280 | 17.580 | 25.150 | 36.000 |
| 6 hr 20 min | 3.020 | 4.370 | 6.330 | 9.160 | 13.250 | 19.170 | 27.720 | 40.110 |
| 6 hr 40 min | 3.120 | 4.560 | 6.660 | 9.740 | 14.230 | 20.800 | 30.410 | 44.440 |
| 7 hr 0 min | 3.210 | 4.740 | 7.000 | 10.330 | 15.240 | 22.490 | 33.200 | 49.000 |
| 7 hr 20 min | 3.300 | 4.920 | 7.330 | 10.920 | 16.270 | 24.230 | 36.100 | 53.770 |
| 7 hr 40 min | 3.390 | 5.100 | 7.660 | 11.520 | 17.310 | 26.020 | 39.110 | 58.770 |
| 8 hr 0 min | 3.480 | 5.270 | 8.000 | 12.120 | 18.370 | 27.850 | 42.220 | 64.000 |
| 9 hr 0 min | 3.730 | 5.800 | 9.000 | 13.960 | 21.670 | 33.630 | 52.190 | 81.000 |
| 10 hr 0 min | 3.980 | 6.310 | 10.000 | 15.840 | 25.110 | 39.810 | 63.090 | 100.000 |
| 11 hr 0 min | 4.210 | 6.800 | 11.000 | 17.760 | 28.700 | 46.360 | 74.900 | 121.000 |
| 12 hr 0 min | 4.440 | 7.300 | 12.000 | 19.720 | 32.420 | 53.290 | 87.600 | 144.000 |

Table J-11. Determination of Stability Category

| Morning (AM) | | | | Afternoon (PM) | | | |
|---------------------|--|------------------------------|----------|---------------------|--|------------------------------|----------|
| Sun Elevation Angle | Condition of Sky | | | Sun Elevation Angle | Condition of Sky | | |
| | No clouds/ Less than half covered | More than half covered | Overcast | | No clouds/ Less than half covered | More than half covered | Overcast |
| <4° | S | S | N | >46° | U | U | N |
| > 4°-32° | N | N | N | > 35°-46° | U | N | N |
| > 32°-40° | U | N | N | > 12°-35° | N | N | N |
| >40° | U | U | N | > 5°-12° | S | N | N |
| U = Unstable | N = Neutral | S = Stable | | <5° | S | S | N |

Enter with:

- Time of day.
- Degree of cloud cover.
- Sun elevation angle (night, >4°).

NOTES:

- The stability category found in this table must be adjusted by using Table J-12.
- The sun elevation table contains basic information. Nations may convert the table into a suitable format for their own use.

Table J-12. Stability Category Adjustment

| Specific Ground (Terrain) and Weather Influences | Stability Category | | |
|--|--------------------|---|---|
| | U | N | S |
| Dry to slightly moist surface | U | N | S |
| Wet surface (i.e., after continuous rain or dew) | N | N | S |
| Frozen surface or partly covered with snow, ice, or frost. | N | S | S |
| Surface completely covered with snow | S | S | S |
| Continuous rainfall | N | N | N |
| Haze or mist (visibility 1–4 km) | N | N | S |
| Fog (visibility less than 1 km) | N | S | S |
| Downwind speed more than 18 kph | N | N | N |

This table is used for the adjustment of the stability category found in Table J-11, taking into account influences of surface and weather. All eight conditions of terrain and weather listed in Table J-12 must be checked, and in case of doubt, the most stable category is to be chosen.

Table J-13. Radioactive Cloud and Stem Parameters (Stabilized at H+10 Minutes)

| Yield (KT) | Cloud Top Height Km 1,000 ft | | Cloud Bottom Height Km 1,000 ft | | 2/3 Stem Height Km 1,000 ft | | Cloud Radius Km mi | | Time of Fall (Cloud Bottom) Hours* |
|---------------|---------------------------------|-------|---------------------------------------|------|--------------------------------|------|--------------------------|------|--|
| | Km | ft | Km | ft | Km | ft | Km | mi | |
| 0.15 | 2.4 | 7.9 | 1.3 | 4.3 | 0.9 | 2.9 | 0.4 | 0.2 | 0.4 |
| 0.20 | 2.6 | 8.5 | 1.4 | 4.6 | 0.9 | 3.1 | 0.5 | 0.3 | 0.4 |
| 0.30 | 2.8 | 9.2 | 1.5 | 4.9 | 1.0 | 3.3 | 0.6 | 0.4 | 0.4 |
| 0.40 | 3.0 | 9.8 | 1.6 | 5.3 | 1.1 | 3.5 | 0.7 | 0.4 | 0.5 |
| 0.50 | 3.2 | 11.0 | 1.7 | 5.6 | 1.1 | 3.7 | 0.7 | 0.4 | 0.5 |
| 0.60 | 3.3 | 11.0 | 1.8 | 5.9 | 1.2 | 3.9 | 0.8 | 0.5 | 0.5 |
| 0.70 | 3.4 | 11.0 | 1.8 | 5.9 | 1.2 | 3.9 | 0.8 | 0.5 | 0.5 |
| 0.80 | 3.5 | 11.0 | 1.9 | 6.2 | 1.3 | 4.1 | 0.9 | 0.6 | 0.5 |
| 0.90 | 3.6 | 12.0 | 2.0 | 6.6 | 1.3 | 4.4 | 0.9 | 0.6 | 0.5 |
| 1.00 | 3.7 | 12.0 | 2.0 | 6.6 | 1.3 | 1.1 | 1.0 | 0.6 | 0.5 |
| 2.00 | 4.4 | 14.0 | 2.3 | 7.5 | 1.5 | 2.0 | 1.3 | 0.8 | 0.6 |
| 3.00 | 5.1 | 17.0 | 2.8 | 9.2 | 1.9 | 3.1 | 1.5 | 0.9 | 0.7 |
| 4.00 | 5.7 | 19.0 | 3.3 | 11.0 | 2.2 | 7.3 | 1.7 | 1.1 | 0.8 |
| 5.00 | 6.3 | 21.0 | 3.6 | 12.0 | 2.4 | 8.0 | 1.9 | 1.2 | 0.9 |
| 6.00 | 6.7 | 22.0 | 4.0 | 13.0 | 2.7 | 8.7 | 2.1 | 1.3 | 1.0 |
| 7.00 | 7.2 | 24.0 | 4.3 | 14.0 | 2.9 | 9.3 | 2.2 | 1.4 | 1.0 |
| 8.00 | 7.5 | 25.0 | 4.6 | 15.0 | 3.1 | 10.0 | 2.3 | 1.4 | 1.1 |
| 9.00 | 7.9 | 26.0 | 4.8 | 16.0 | 3.2 | 11.0 | 2.4 | 1.5 | 1.1 |
| 10.00 | 8.2 | 27.0 | 5.1 | 17.0 | 3.4 | 11.0 | 2.6 | 1.6 | 1.1 |
| 20.00 | 11.0 | 36.0 | 7.2 | 24.0 | 4.8 | 16.0 | 3.4 | 2.1 | 1.5 |
| 30.00 | 12.0 | 39.0 | 7.6 | 25.0 | 5.1 | 17.0 | 4.0 | 2.5 | 1.6 |
| 40.00 | 12.0 | 39.0 | 8.0 | 26.0 | 5.3 | 17.0 | 4.6 | 2.9 | 1.6 |
| 50.00 | 13.0 | 43.0 | 8.3 | 27.0 | 5.5 | 18.0 | 5.0 | 3.1 | 1.7 |
| 60.00 | 13.0 | 43.0 | 8.5 | 28.0 | 5.7 | 19.0 | 5.4 | 3.4 | 1.7 |
| 70.00 | 14.0 | 46.0 | 8.7 | 29.0 | 5.8 | 19.0 | 5.8 | 3.6 | 1.8 |
| 80.00 | 14.0 | 46.0 | 8.9 | 29.0 | 5.9 | 19.0 | 6.1 | 3.8 | 1.8 |
| 90.00 | 14.0 | 46.0 | 9.1 | 30.0 | 6.1 | 20.0 | 6.4 | 4.0 | 1.8 |
| 100.00 | 14.0 | 46.0 | 9.3 | 31.0 | 6.2 | 21.0 | 6.7 | 4.2 | 1.9 |
| 200.00 | 16.0 | 53.0 | 10.0 | 33.0 | 6.7 | 22.0 | 9.0 | 5.6 | 2.0 |
| 300.00 | 17.0 | 56.0 | 11.0 | 36.0 | 7.3 | 24.0 | 11.0 | 6.8 | 2.1 |
| 400.00 | 18.0 | 59.0 | 12.0 | 39.0 | 8.0 | 26.0 | 12.0 | 7.5 | 2.3 |
| 500.00 | 19.0 | 62.0 | 12.0 | 39.0 | 8.0 | 26.0 | 13.0 | 8.1 | 2.3 |
| 600.00 | 20.0 | 66.0 | 12.0 | 39.0 | 8.0 | 26.0 | 14.0 | 8.7 | 2.3 |
| 700.00 | 20.0 | 66.0 | 13.0 | 43.0 | 8.7 | 29.0 | 15.0 | 9.3 | 2.4 |
| 800.00 | 21.0 | 69.0 | 13.0 | 43.0 | 8.7 | 29.0 | 16.0 | 9.9 | 2.4 |
| 900.00 | 21.0 | 69.0 | 13.0 | 43.0 | 8.7 | 29.0 | 17.0 | 11.0 | 2.4 |
| MT 1.00 | 22.0 | 72.0 | 13.0 | 43.0 | 8.7 | 29.0 | 18.0 | 11.0 | 2.4 |
| 2.00 | 24.0 | 79.0 | 15.0 | 49.0 | 10.0 | 33.0 | 24.0 | 15.0 | 2.7 |
| 3.00 | 26.0 | 85.0 | 16.0 | 53.0 | 11.0 | 35.0 | 28.0 | 17.0 | 2.9 |
| 4.00 | 28.0 | 92.0 | 17.0 | 56.0 | 11.0 | 37.0 | 32.0 | 20.0 | 2.9 |
| 5.00 | 28.0 | 95.0 | 17.0 | 56.0 | 11.0 | 37.0 | 35.0 | 22.0 | 2.9 |
| 6.00 | 30.0 | 98.0 | 18.0 | 59.0 | 12.0 | 39.0 | 37.0 | 23.0 | 3.1 |
| 7.00 | 31.0 | 102.0 | 18.0 | 59.0 | 12.0 | 39.0 | 40.0 | 25.0 | 3.1 |
| 8.00 | 31.0 | 102.0 | 19.0 | 62.0 | 13.0 | 41.0 | 42.0 | 26.0 | 3.3 |
| 9.00 | 32.0 | 105.0 | 19.0 | 62.0 | 13.0 | 41.0 | 44.0 | 27.0 | 3.3 |
| 10.00 | 33.0 | 108.0 | 19.0 | 62.0 | 13.0 | 41.0 | 46.0 | 29.0 | 3.3 |
| 20.00 | 37.0 | 121.0 | 21.0 | 69.0 | 14.0 | 46.0 | 62.0 | 39.0 | 3.6 |
| 30.00 | 40.0 | 131.0 | 23.0 | 75.0 | 15.0 | 50.0 | 74.0 | 46.0 | 3.8 |
| 40.00 | 42.0 | 138.0 | 24.0 | 79.0 | 16.0 | 53.0 | 83.0 | 52.0 | 4.0 |
| 50.00 | 43.0 | 141.0 | 25.0 | 82.0 | 17.0 | 55.0 | 91.0 | 57.0 | 4.1 |
| 60.00 | 45.0 | 148.0 | 26.0 | 85.0 | 17.0 | 57.0 | 99.0 | 62.0 | 4.1 |
| 70.00 | 46.0 | 151.0 | 26.0 | 85.0 | 17.0 | 57.0 | 105.0 | 65.0 | 4.1 |
| 80.00 | 47.0 | 154.0 | 27.0 | 89.0 | 18.0 | 59.0 | 111.0 | 69.0 | 4.3 |
| 90.00 | 48.0 | 158.0 | 27.0 | 89.0 | 18.0 | 59.0 | 117.0 | 73.0 | 4.3 |
| 100.00 | 49.0 | 161.0 | 28.0 | 92.0 | 19.0 | 61.0 | 122.0 | 76.0 | 4.5 |

NOTE: 0.1 hour equals 6 minutes.

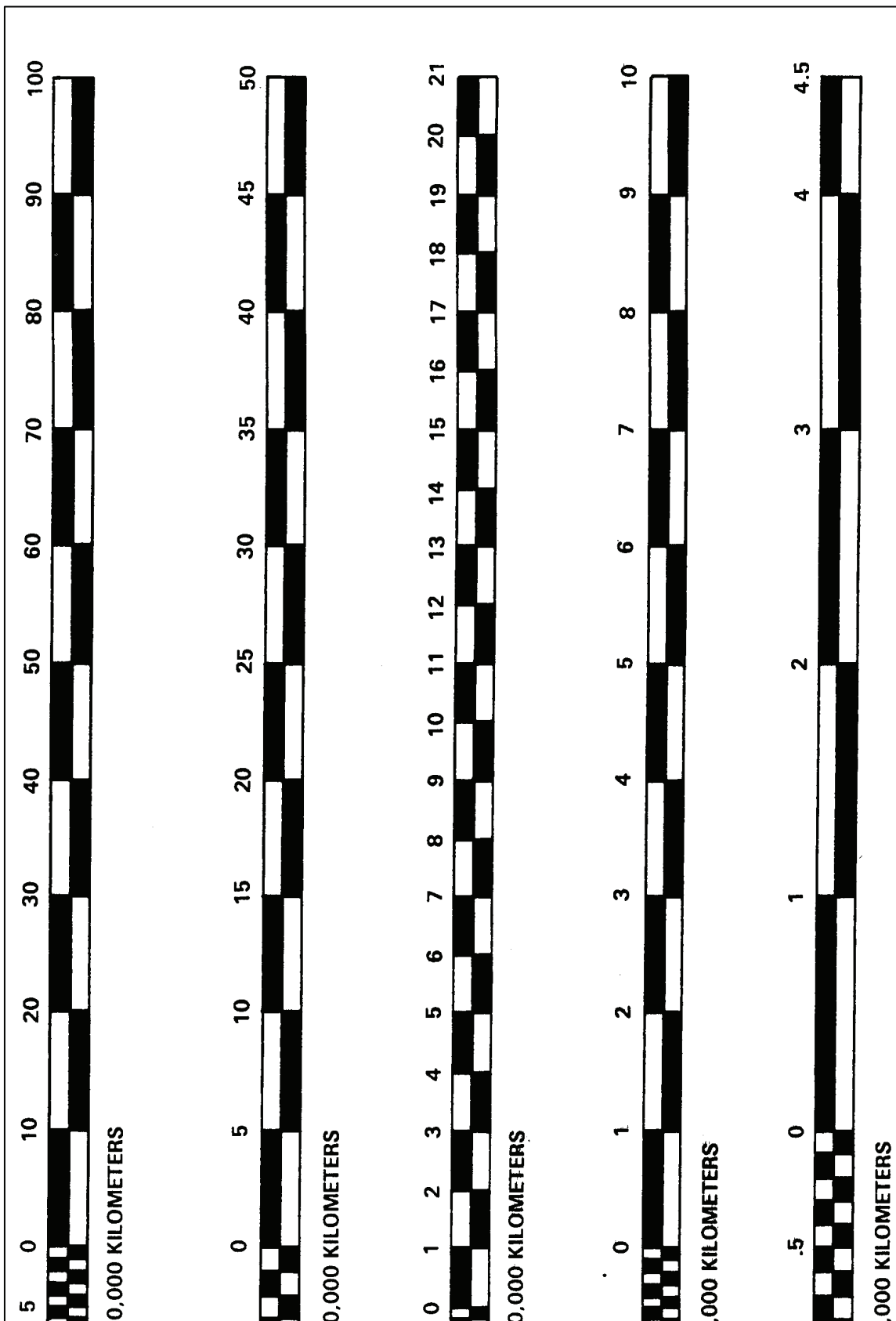

Figure J-1. Map Scales

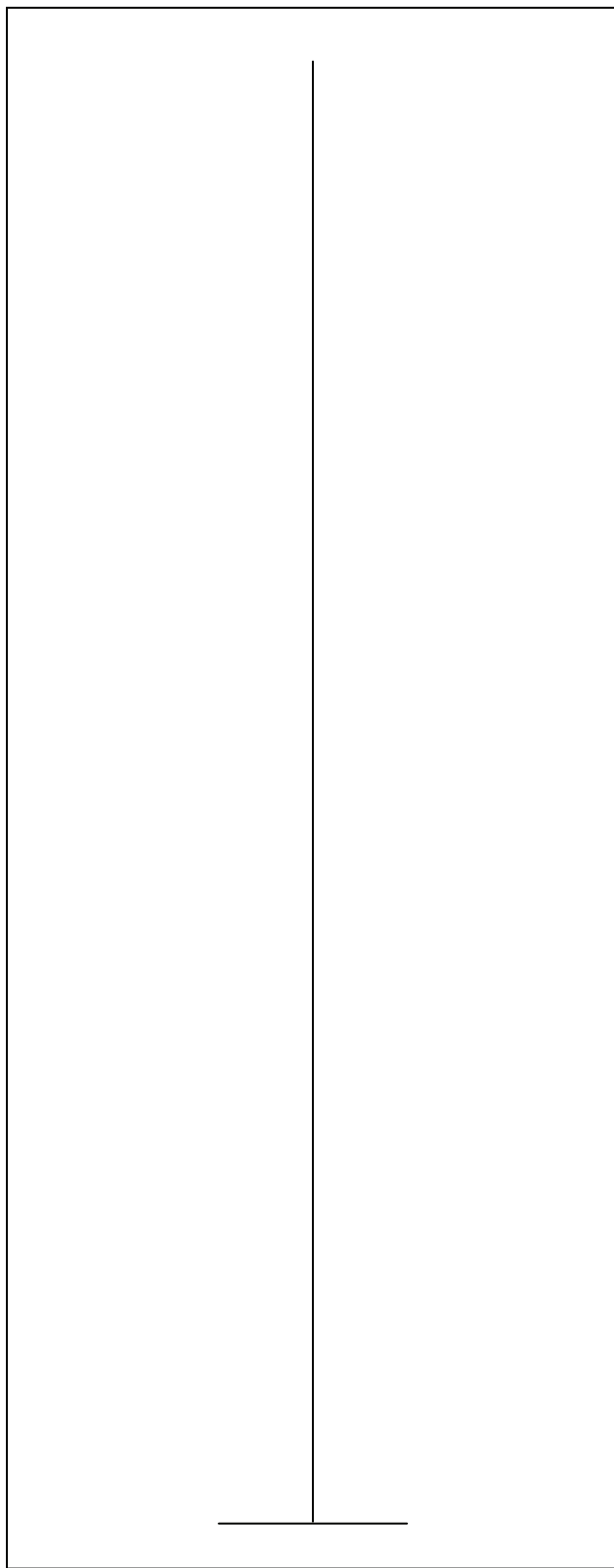

Figure J-2. Hairline

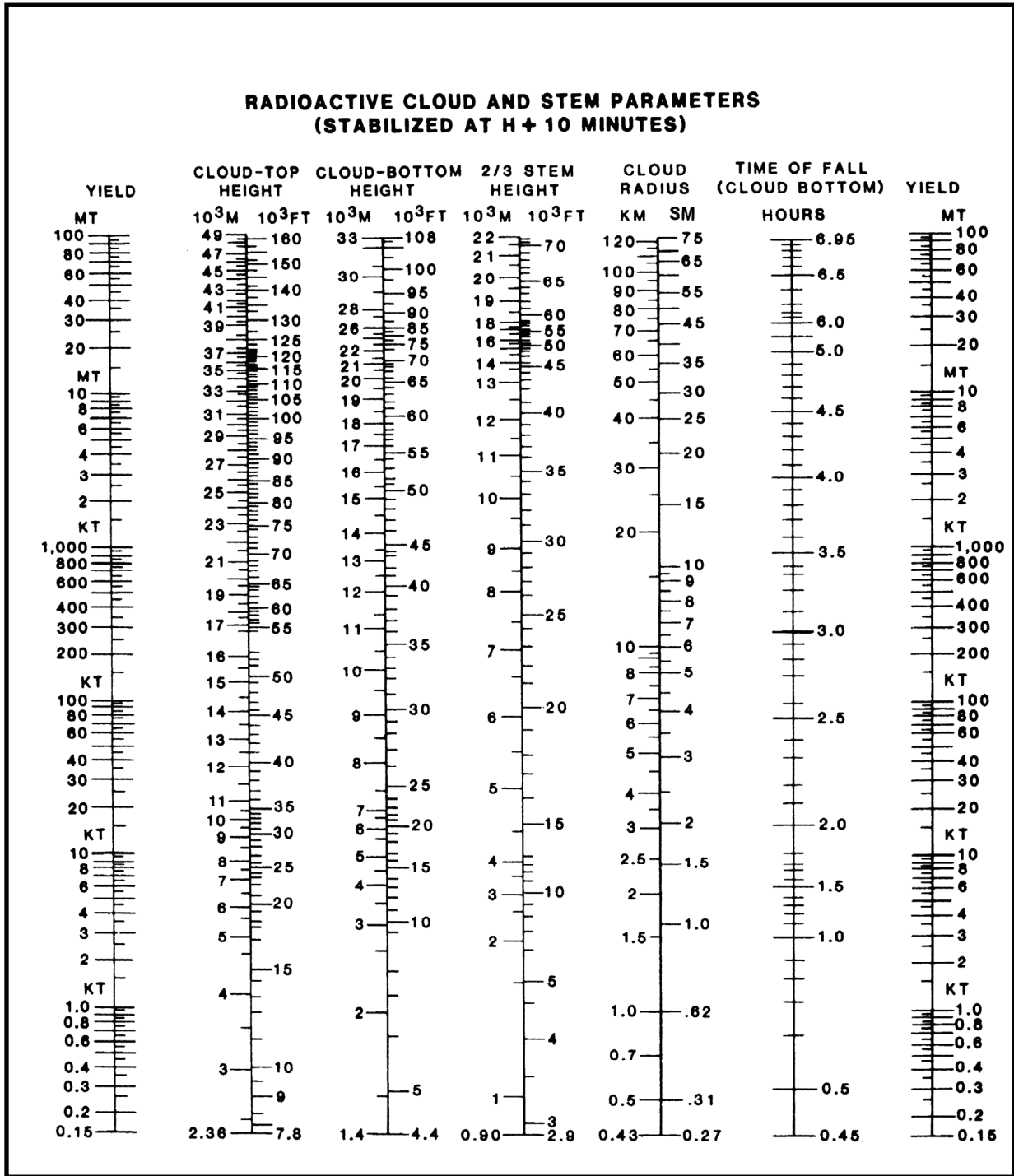

Figure J-3. Radioactive Cloud and Stem Parameters Nomogram (Stabilized at H+10 Minutes)

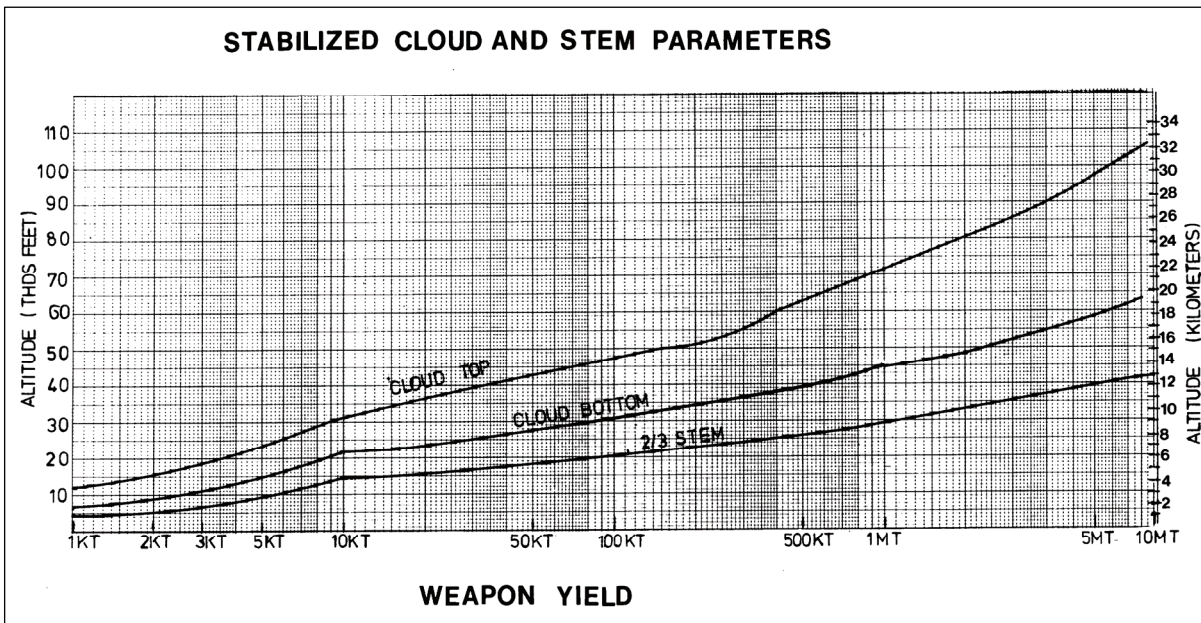

Figure J-4. Radioactive Cloud and Stem Parameters (Graph)

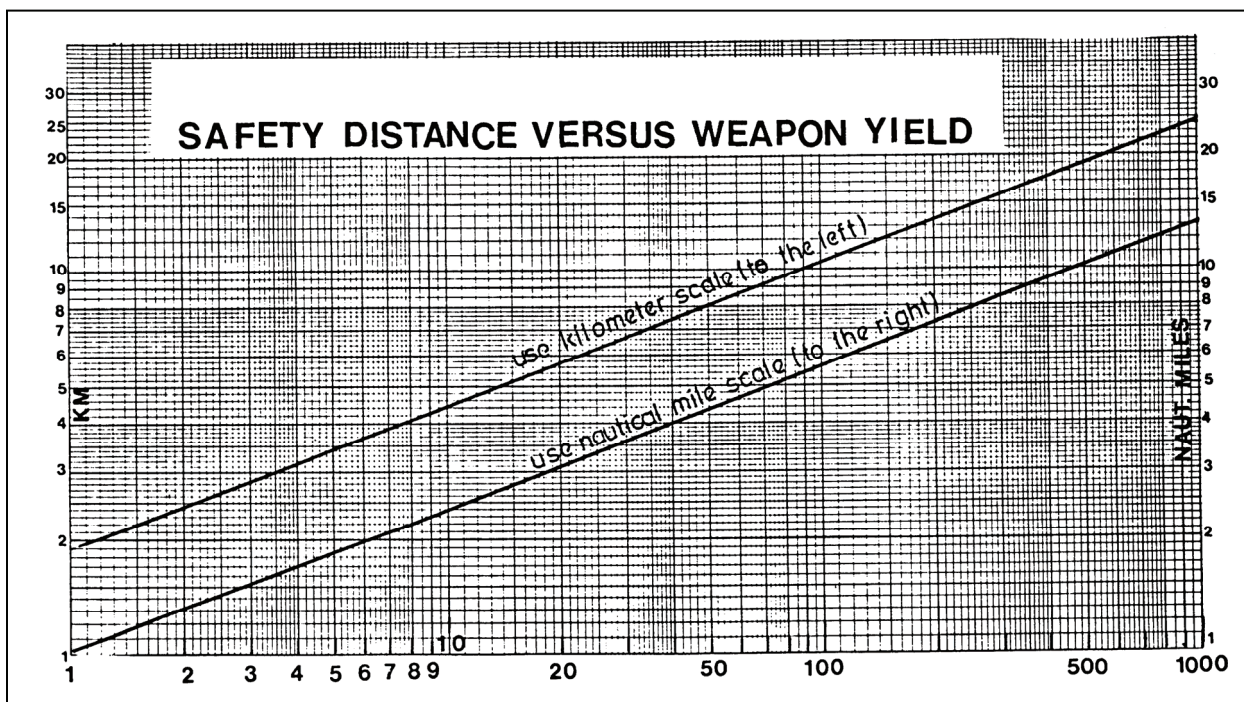

Figure J-5. Safety Distance as a Function of Weapon Yield

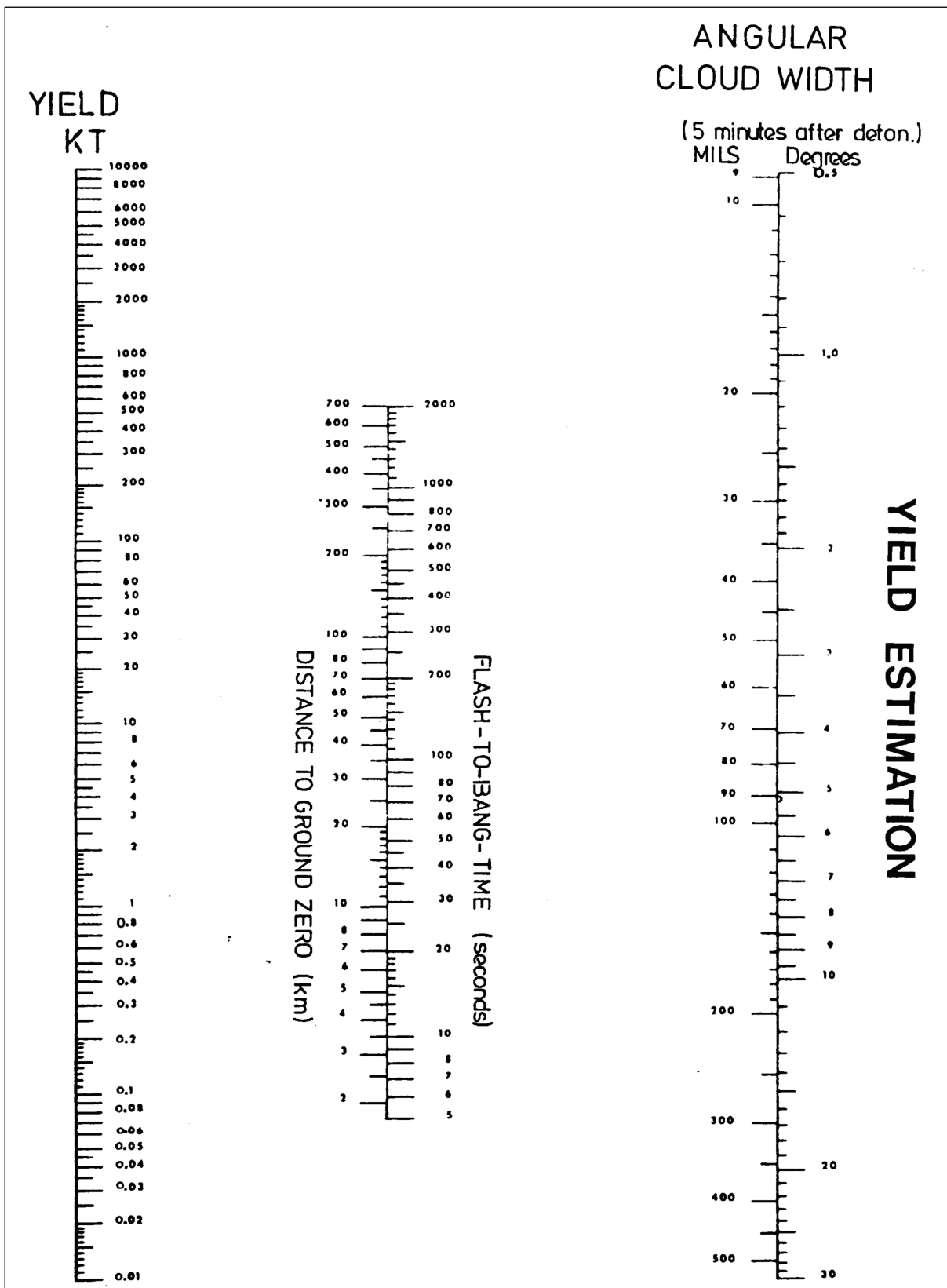

Figure J-6. Yield Estimation, Angular Cloud Width and Flash-to-Bang Time/Distance to GZ

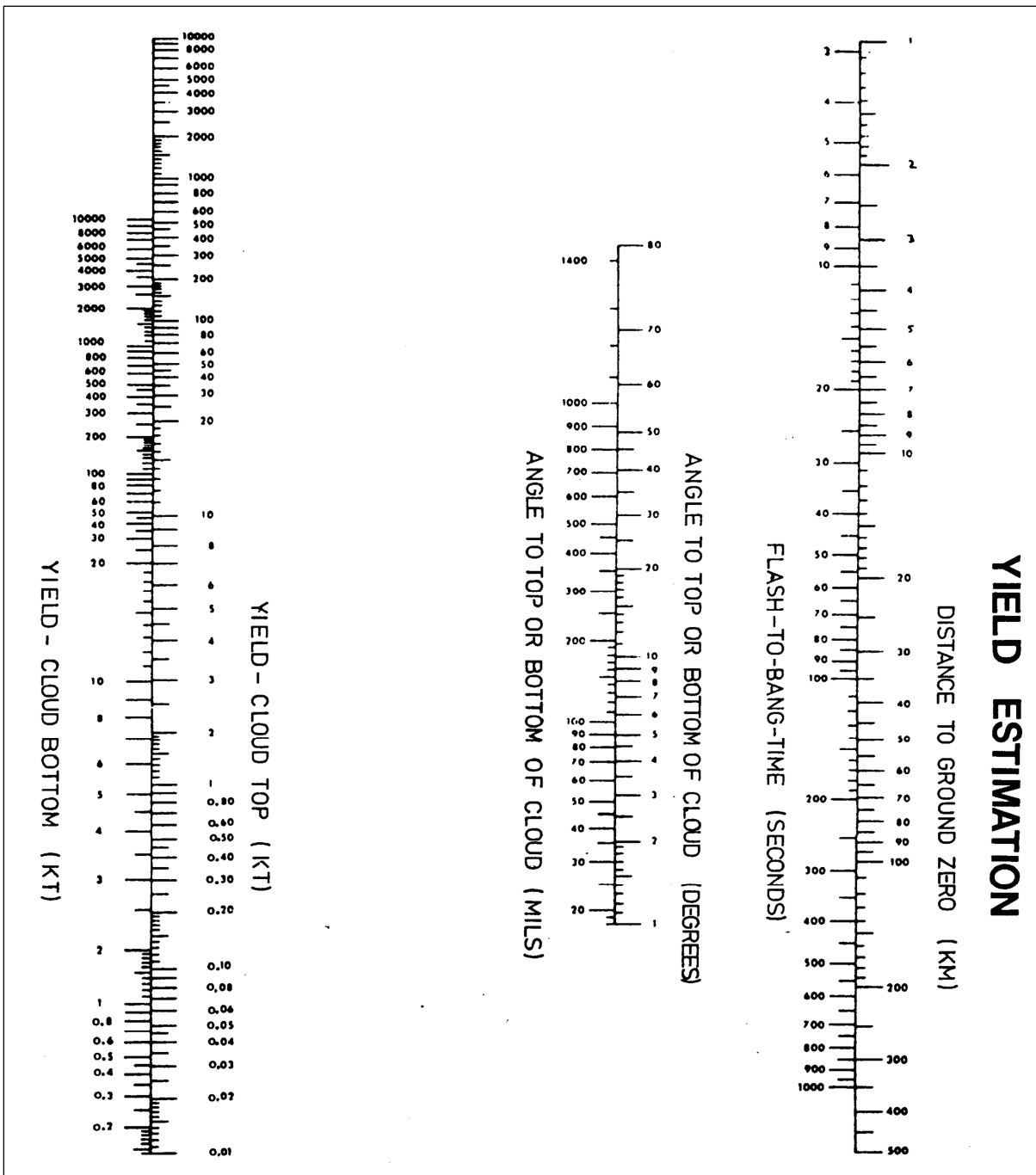

Figure J-7. Yield Estimation, Angle to Top/Bottom of Cloud and Flash-to-Bang Time/Distance to GZ

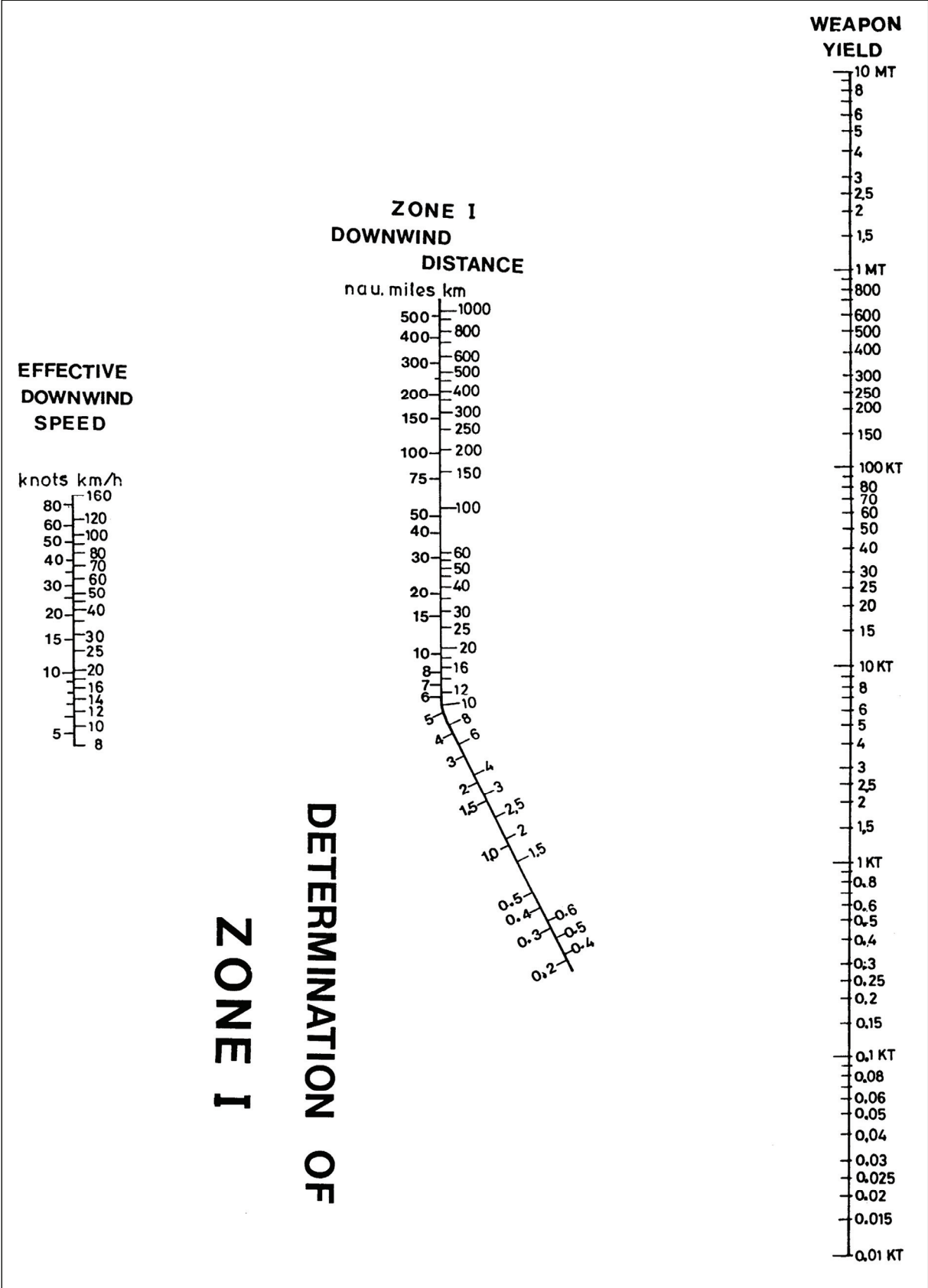

Figure J-8. Determination of Zone I, Downwind Distance

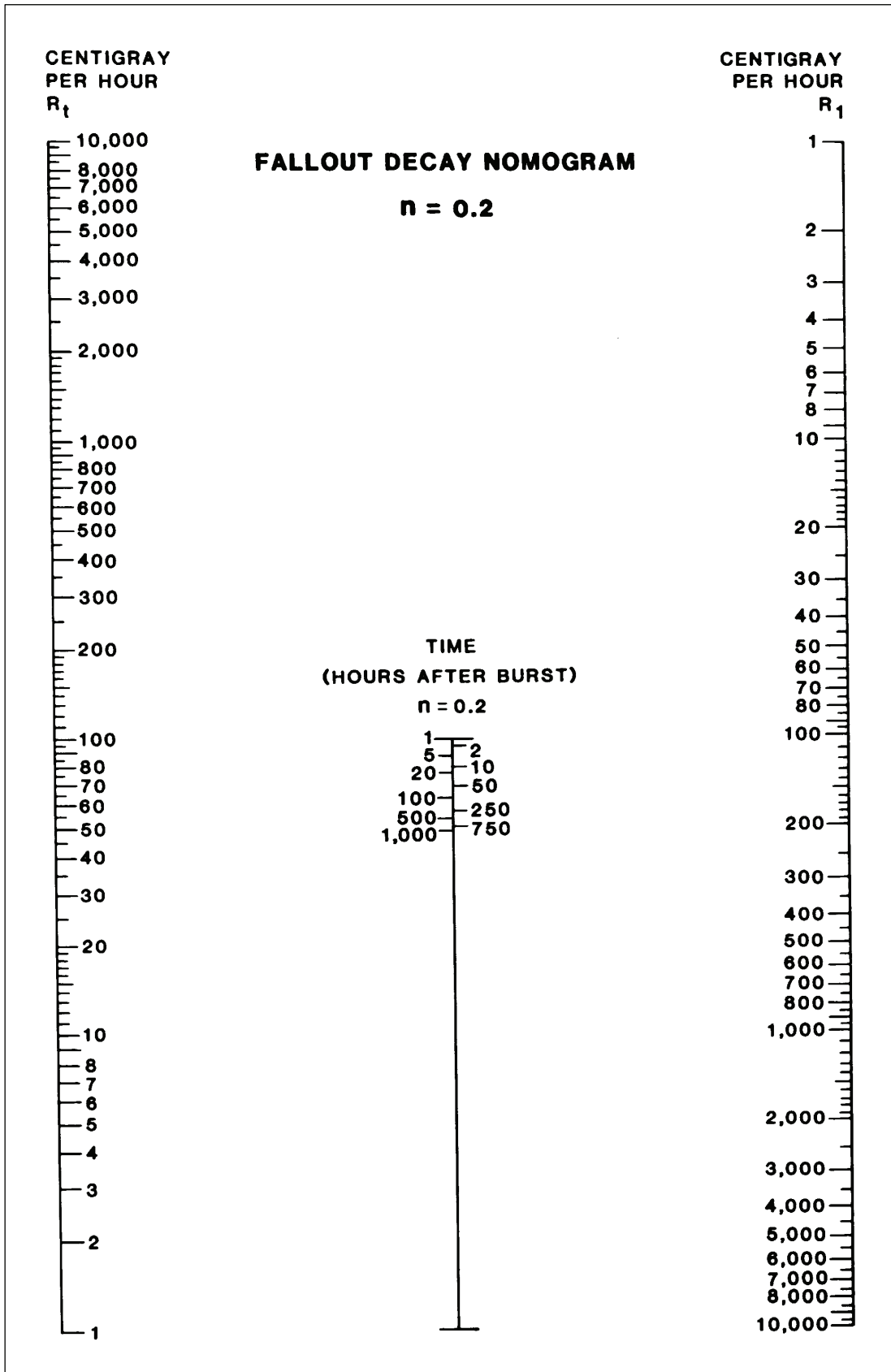

Figure J-9. Fallout Decay Nomogram (n=0.2)

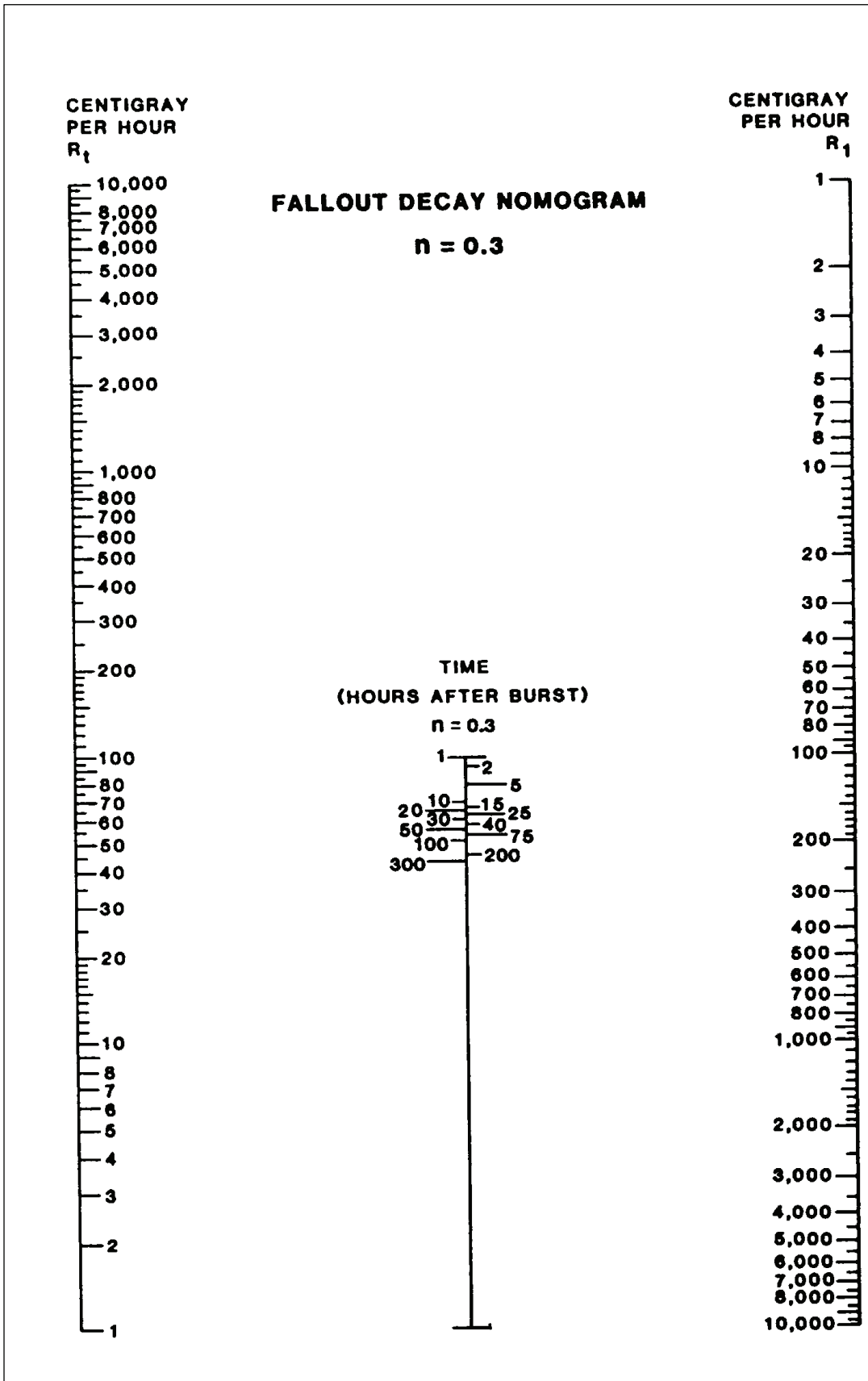

Figure J-10. Fallout Decay Nomogram (n=0.3)

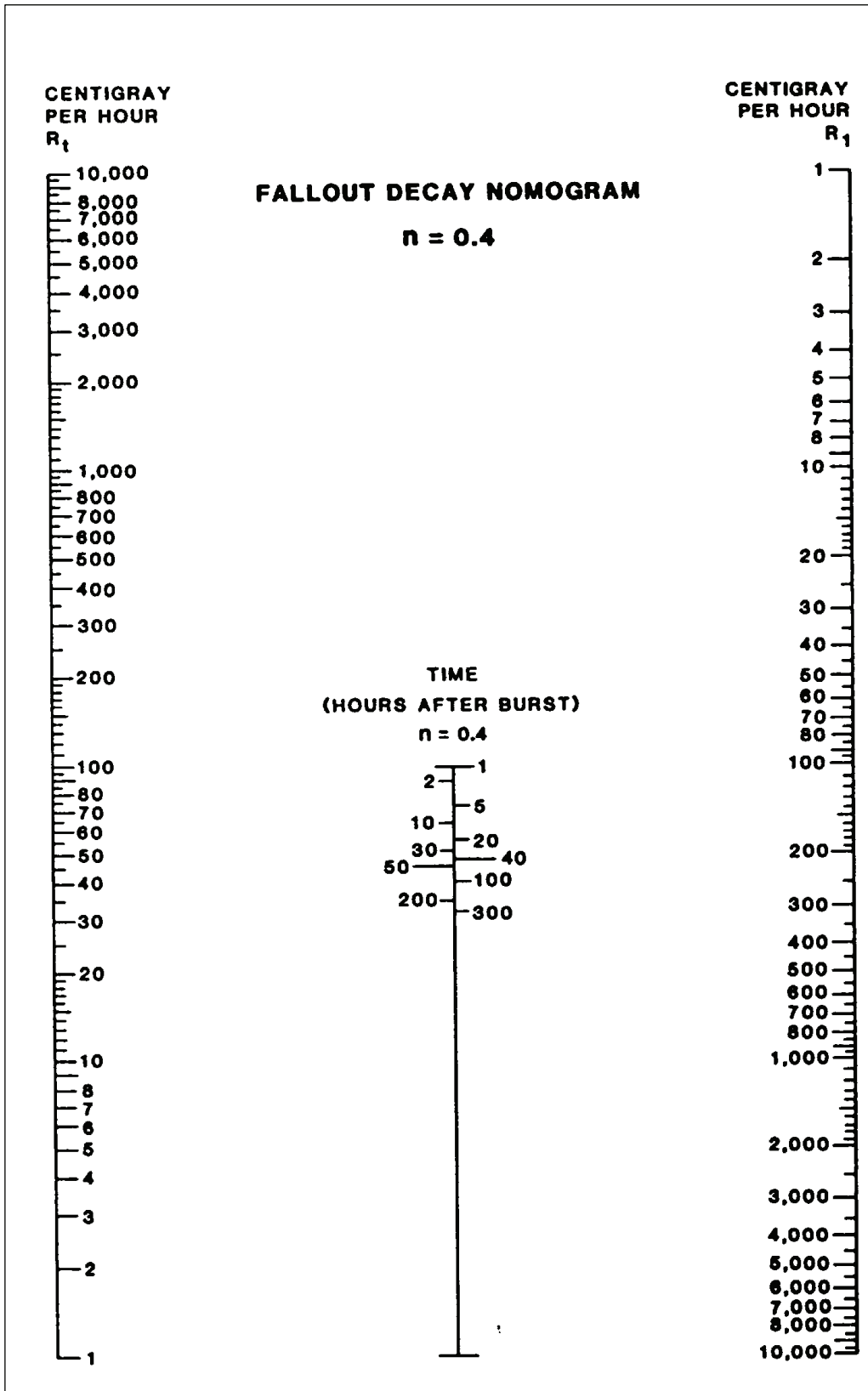

Figure J-11. Fallout Decay Nomogram (n=0.4)

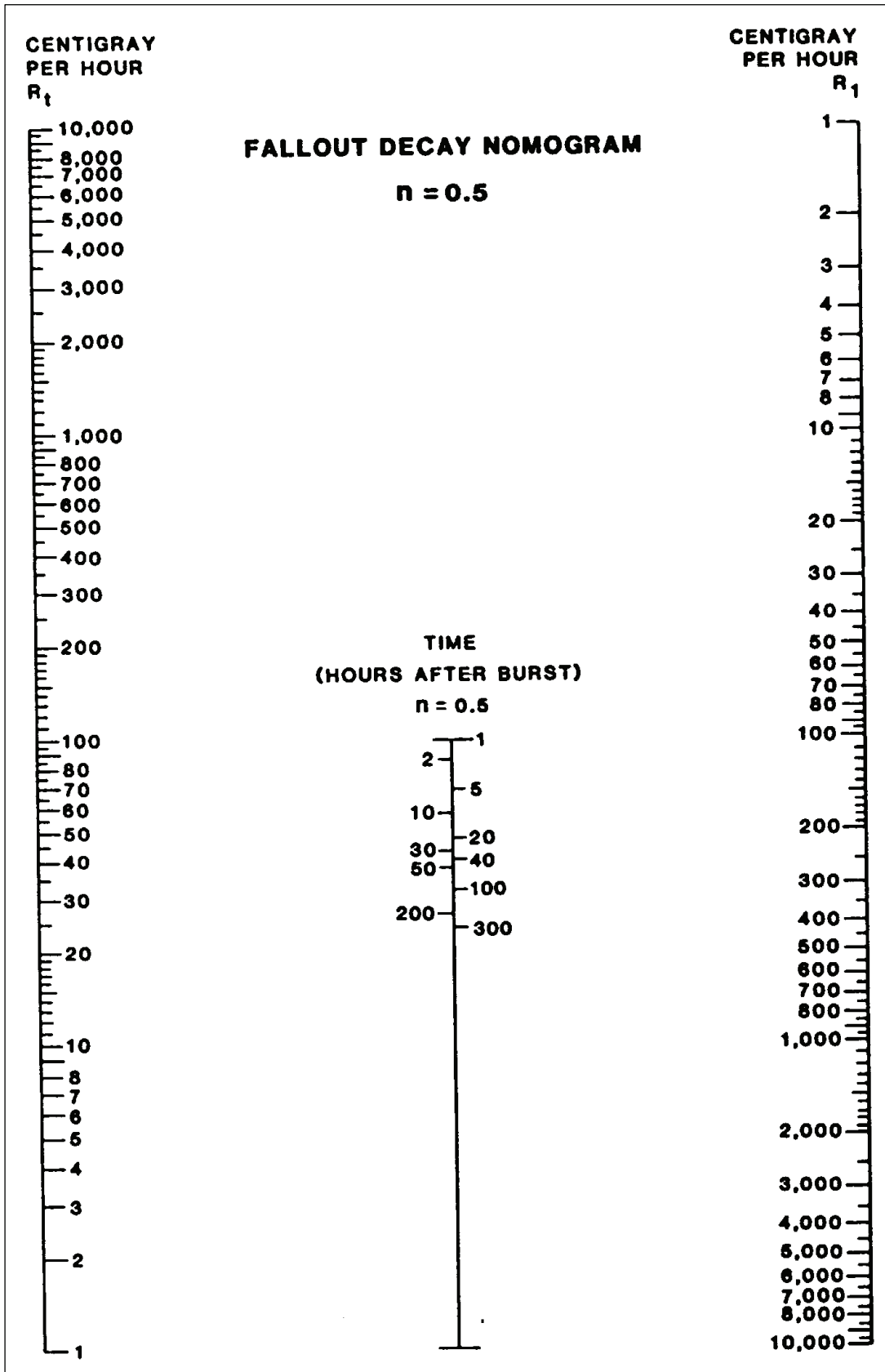

Figure J-12. Fallout Decay Nomogram (n=0.5)

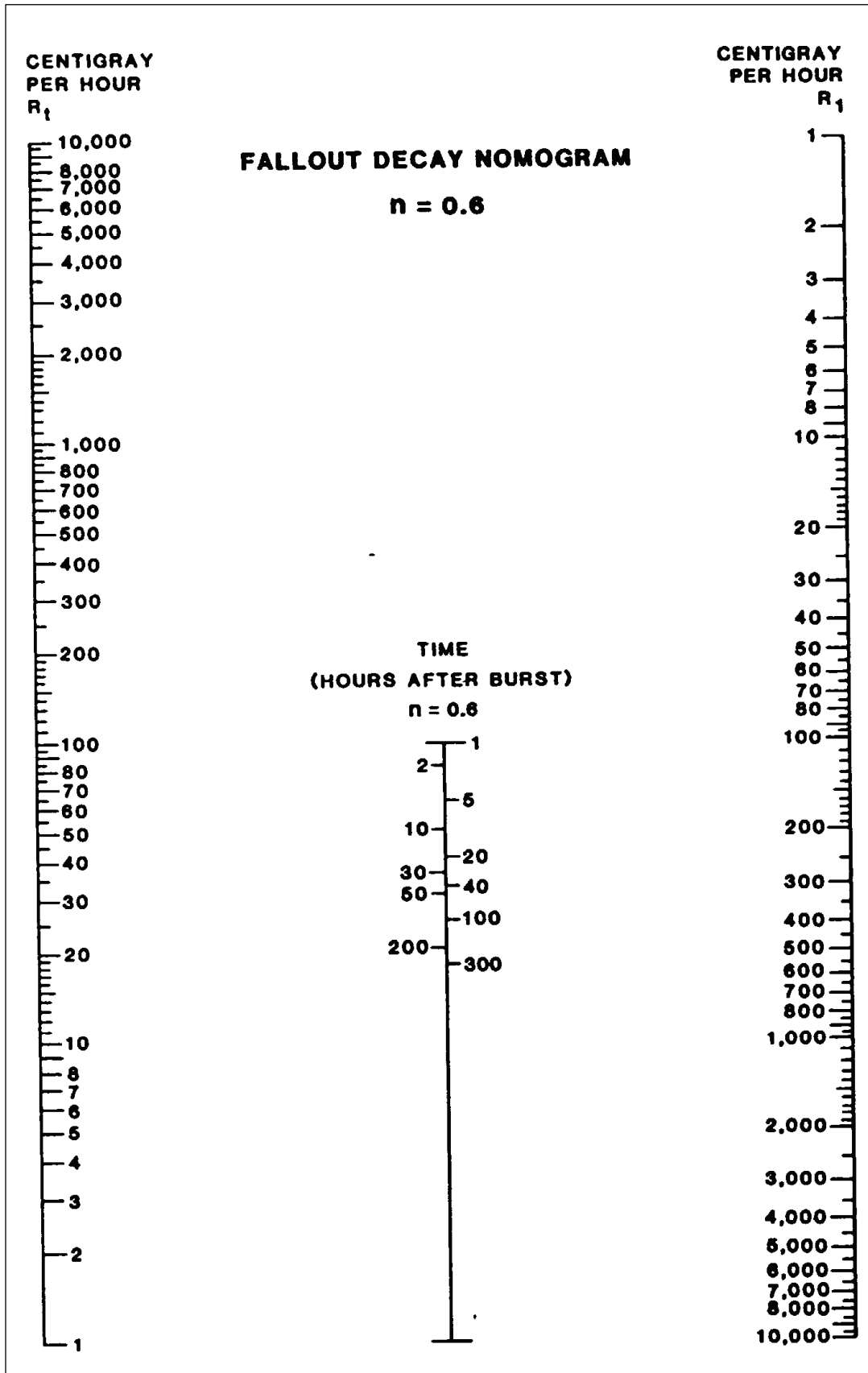

Figure J-13. Fallout Decay Nomogram (n=0.6)

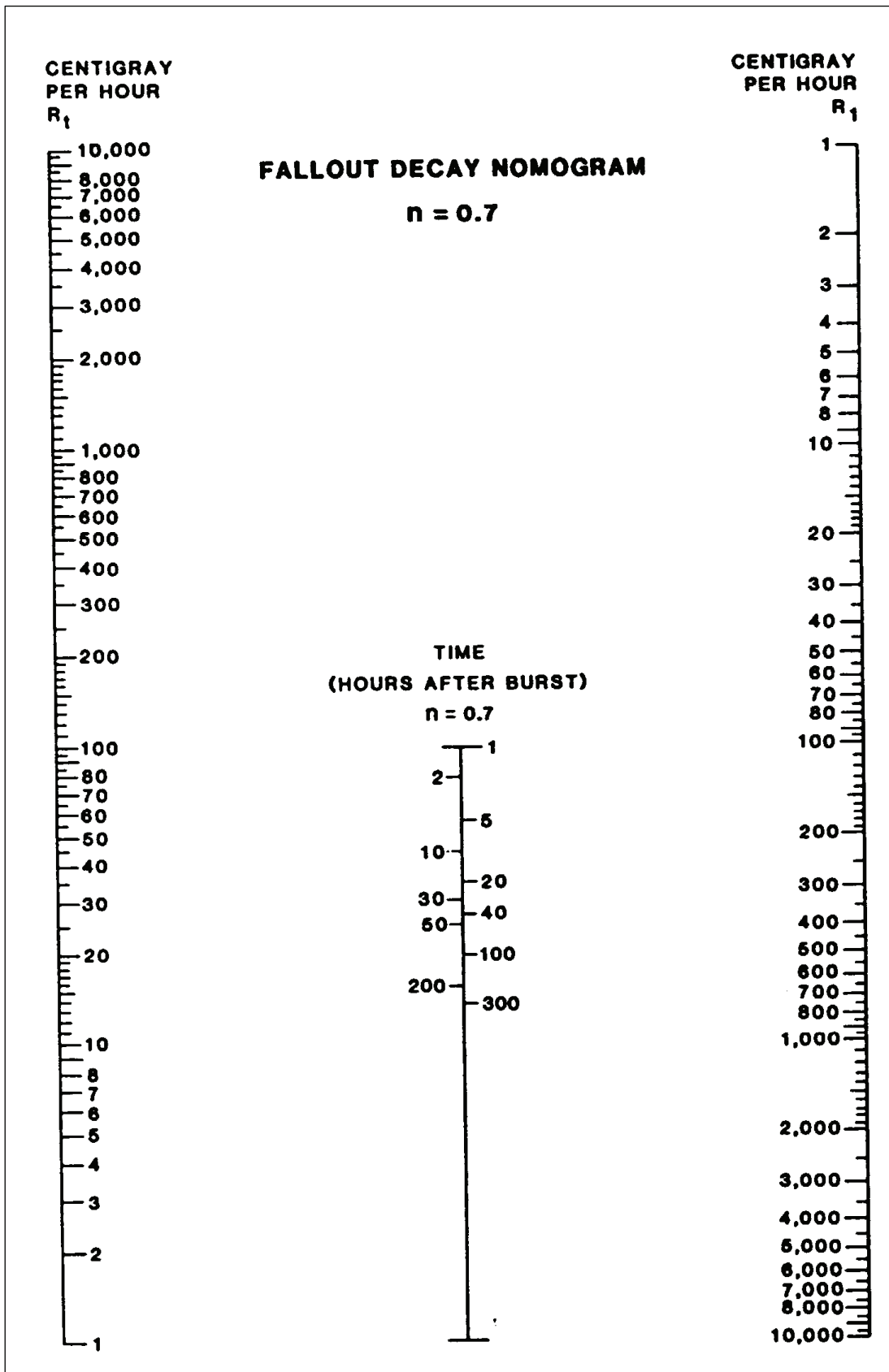

Figure J-14. Fallout Decay Nomogram (n=0.7)

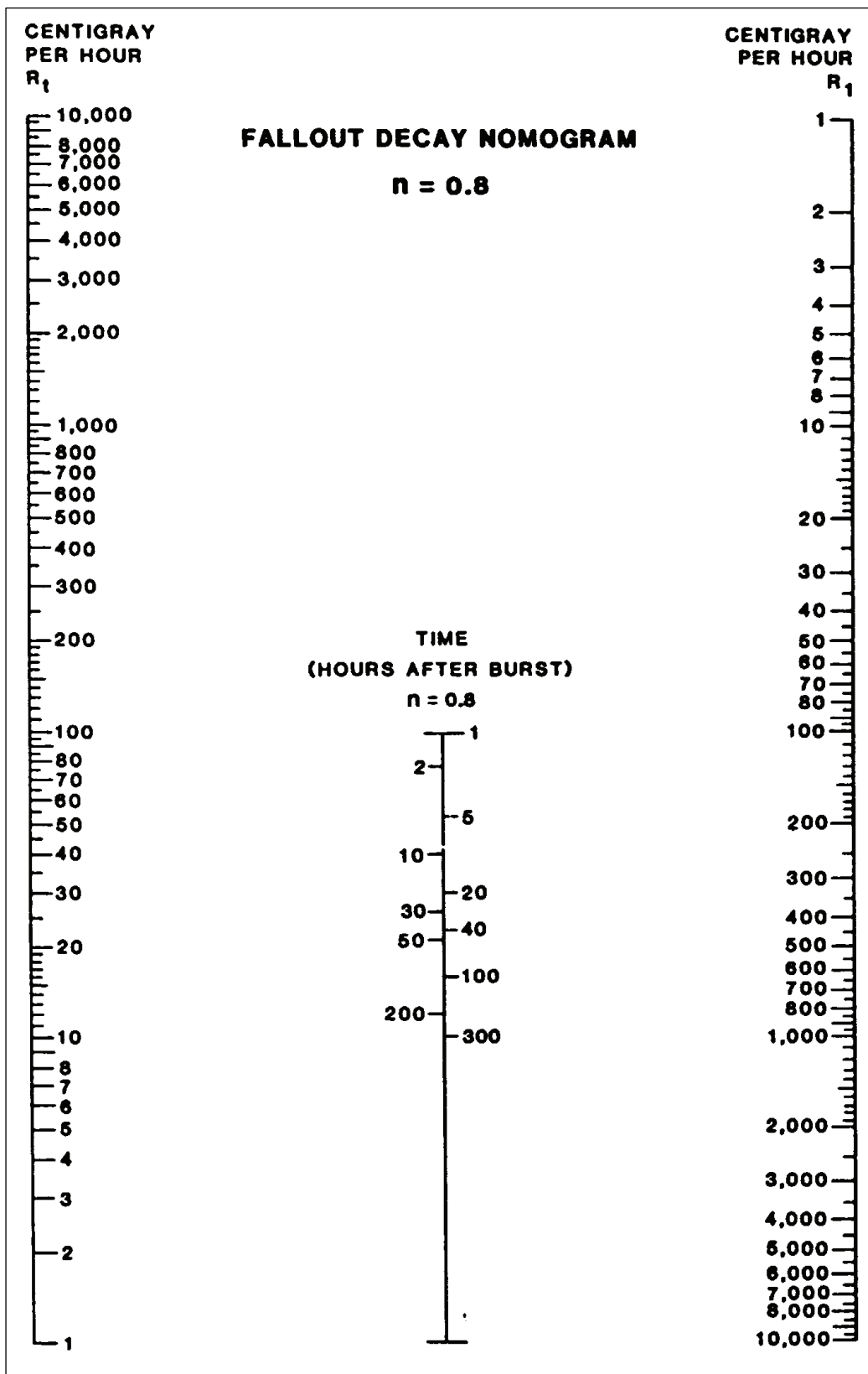

Figure J-15. Fallout Decay Nomogram (n=0.8)

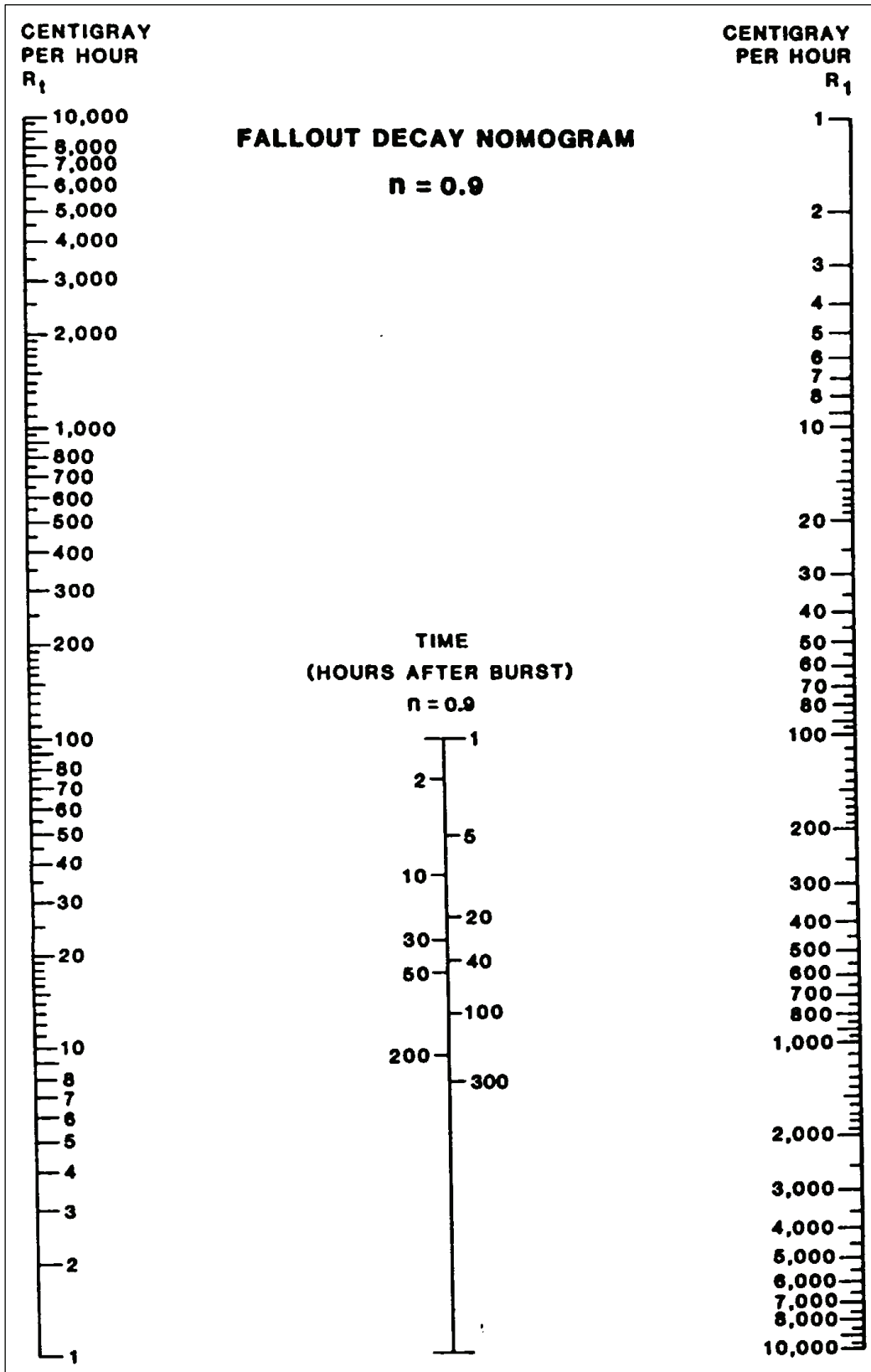

Figure J-16. Fallout Decay Nomogram (n=0.9)

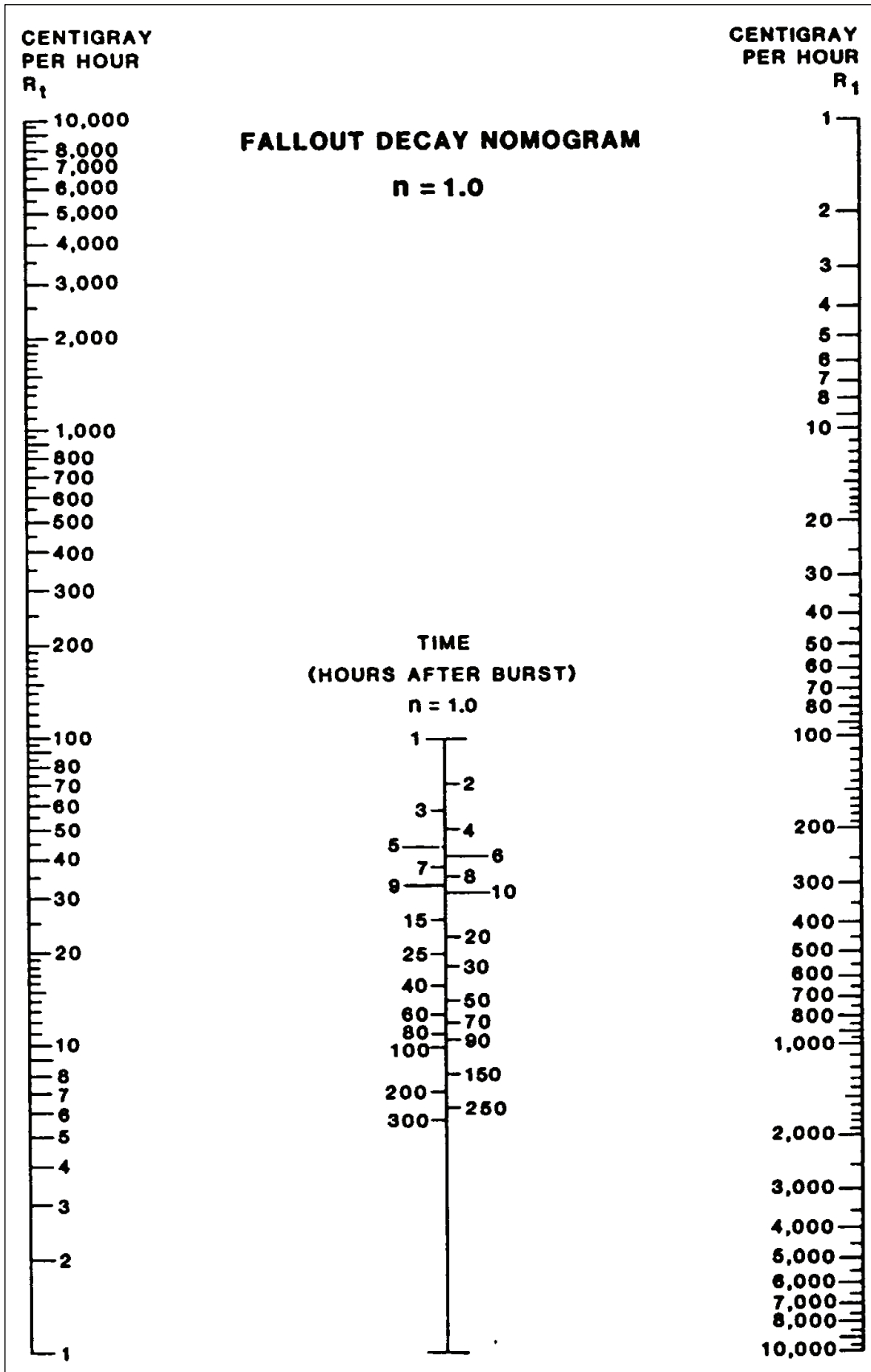

Figure J-17. Fallout Decay Nomogram (n=1.0)

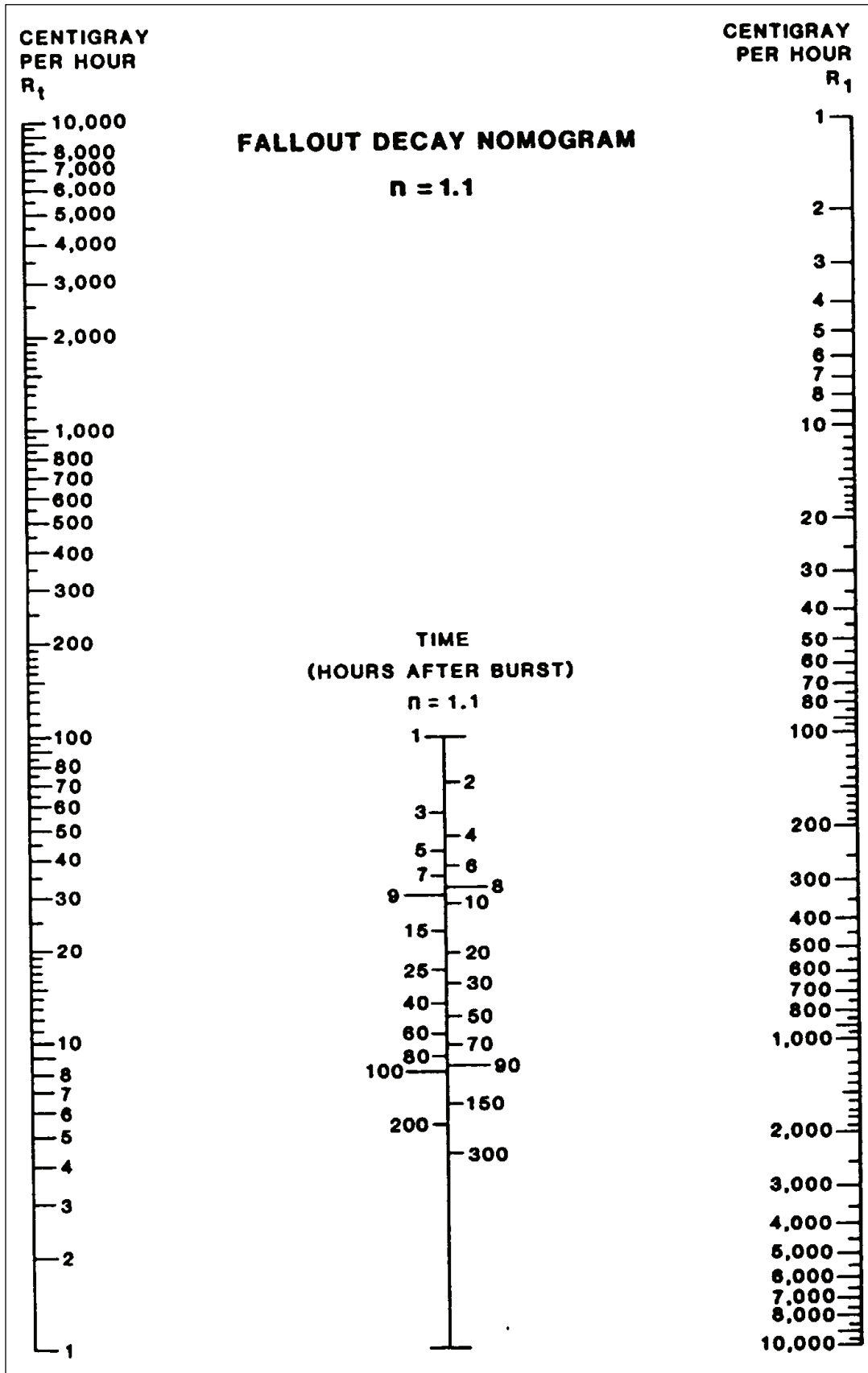

Figure J-18. Fallout Decay Nomogram (n=1.1)

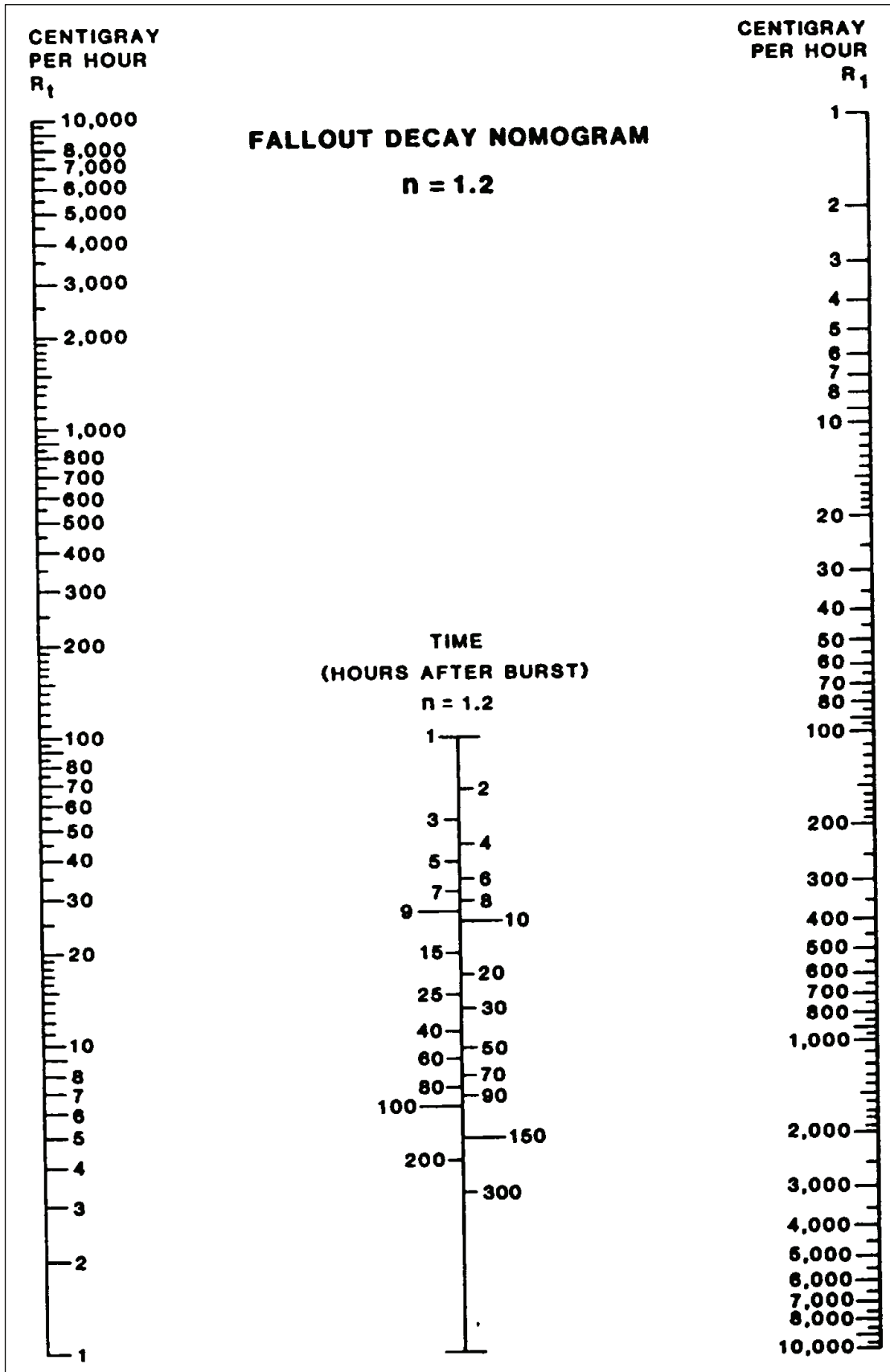

Figure J-19. Fallout Decay Nomogram (n=1.2)

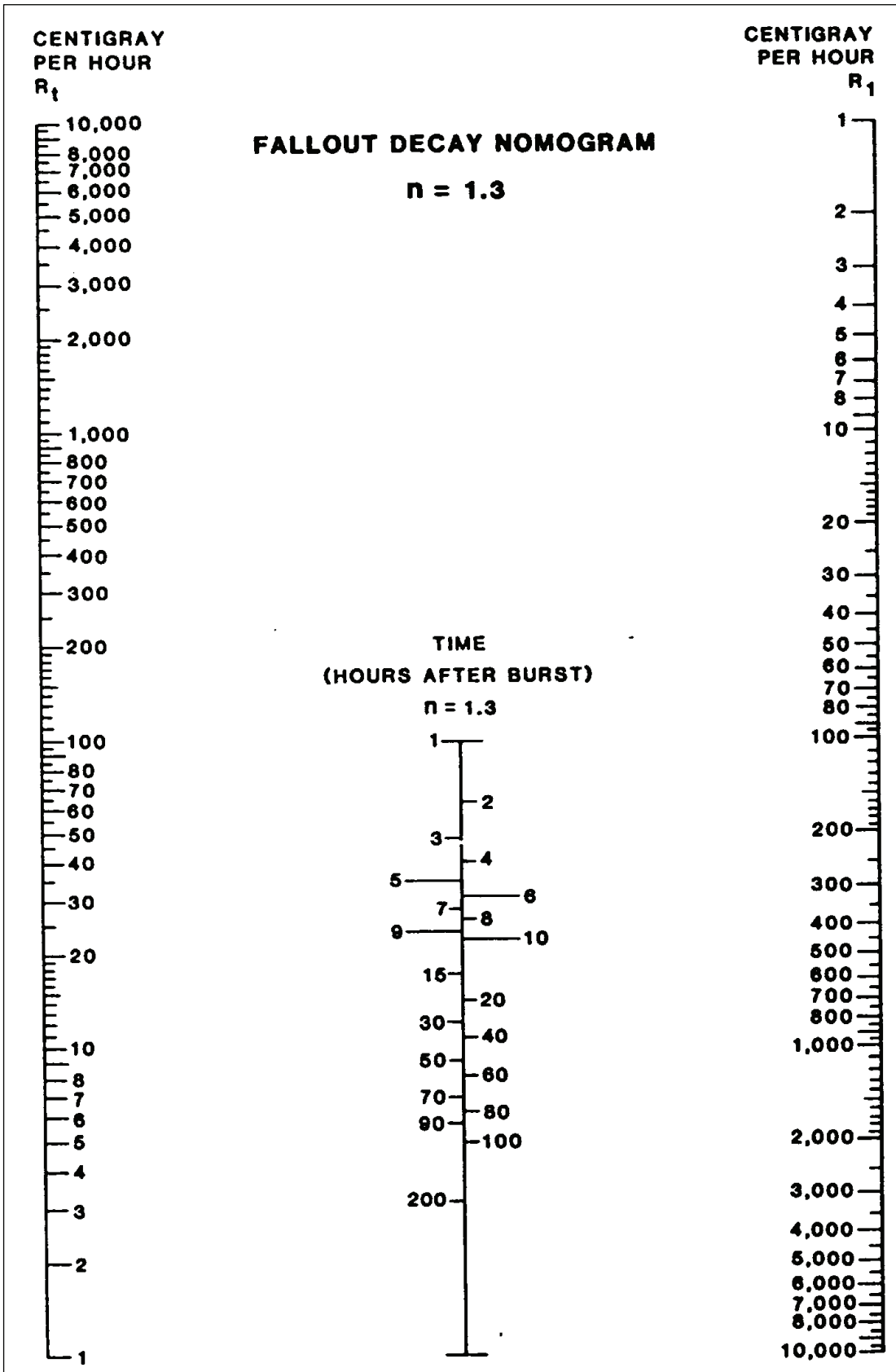

Figure J-20. Fallout Decay Nomogram (n=1.3)

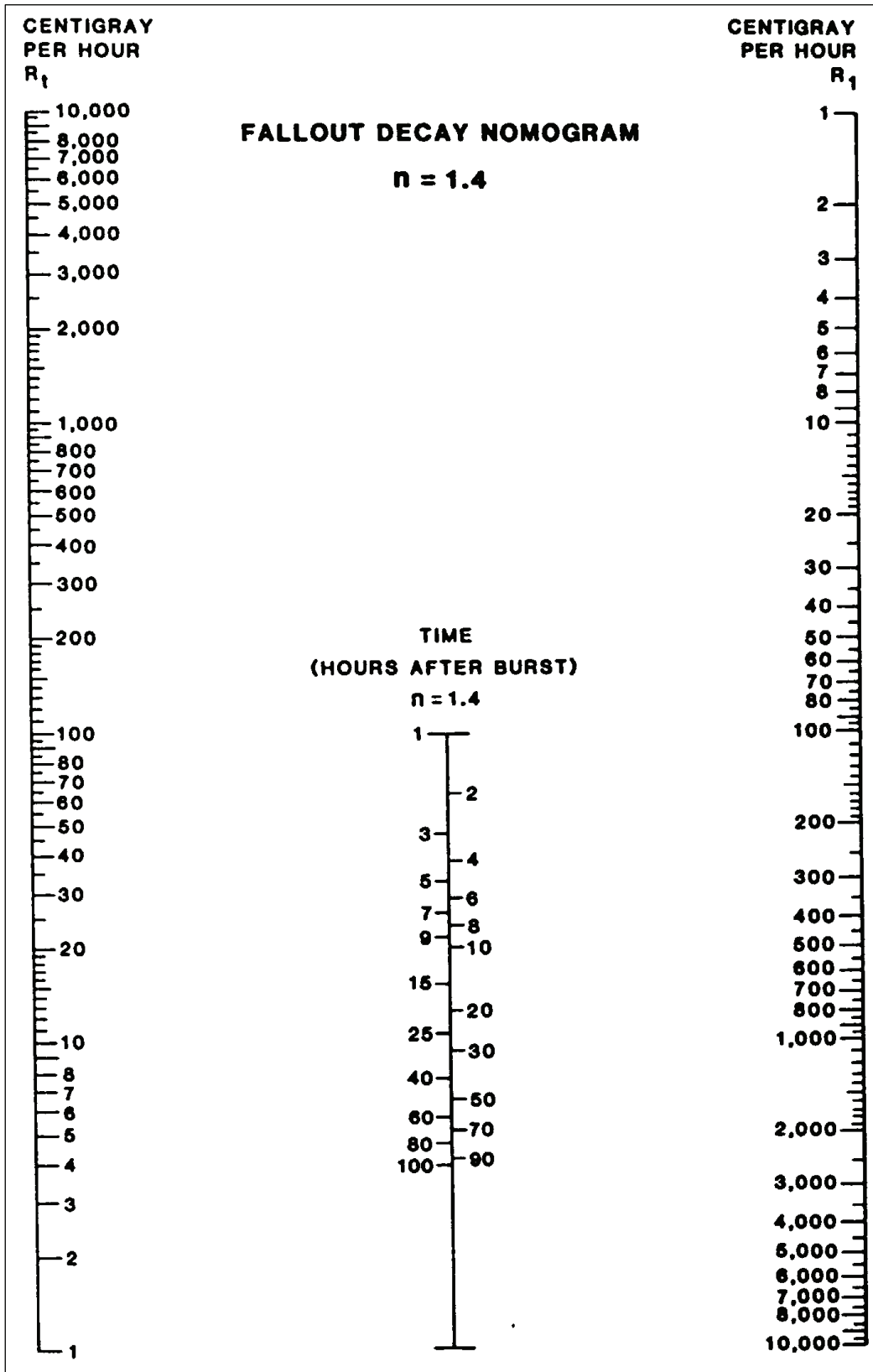

Figure J-21. Fallout Decay Nomogram ($n=1.4$)

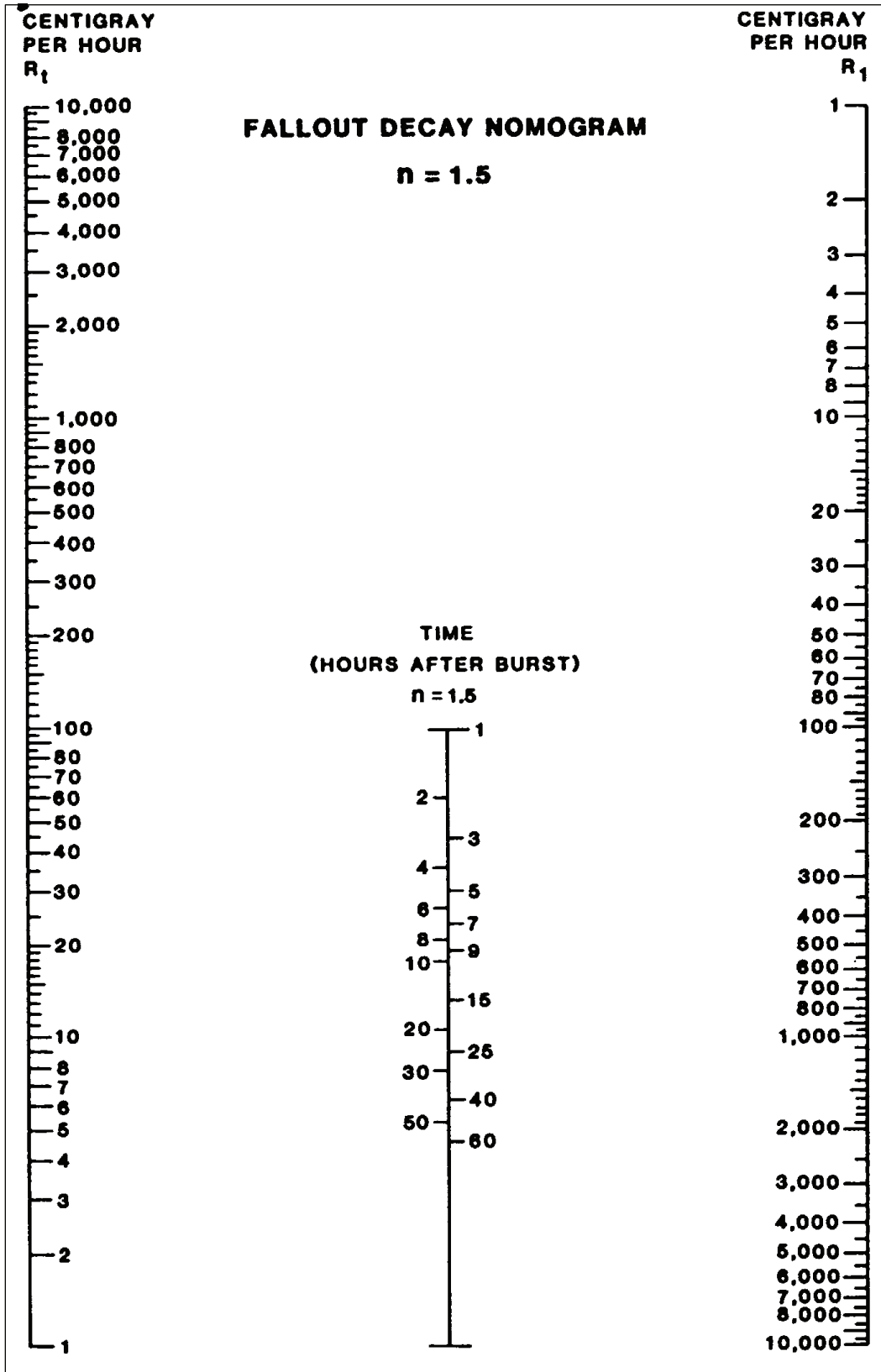

Figure J-22. Fallout Decay Nomogram (n=1.5)

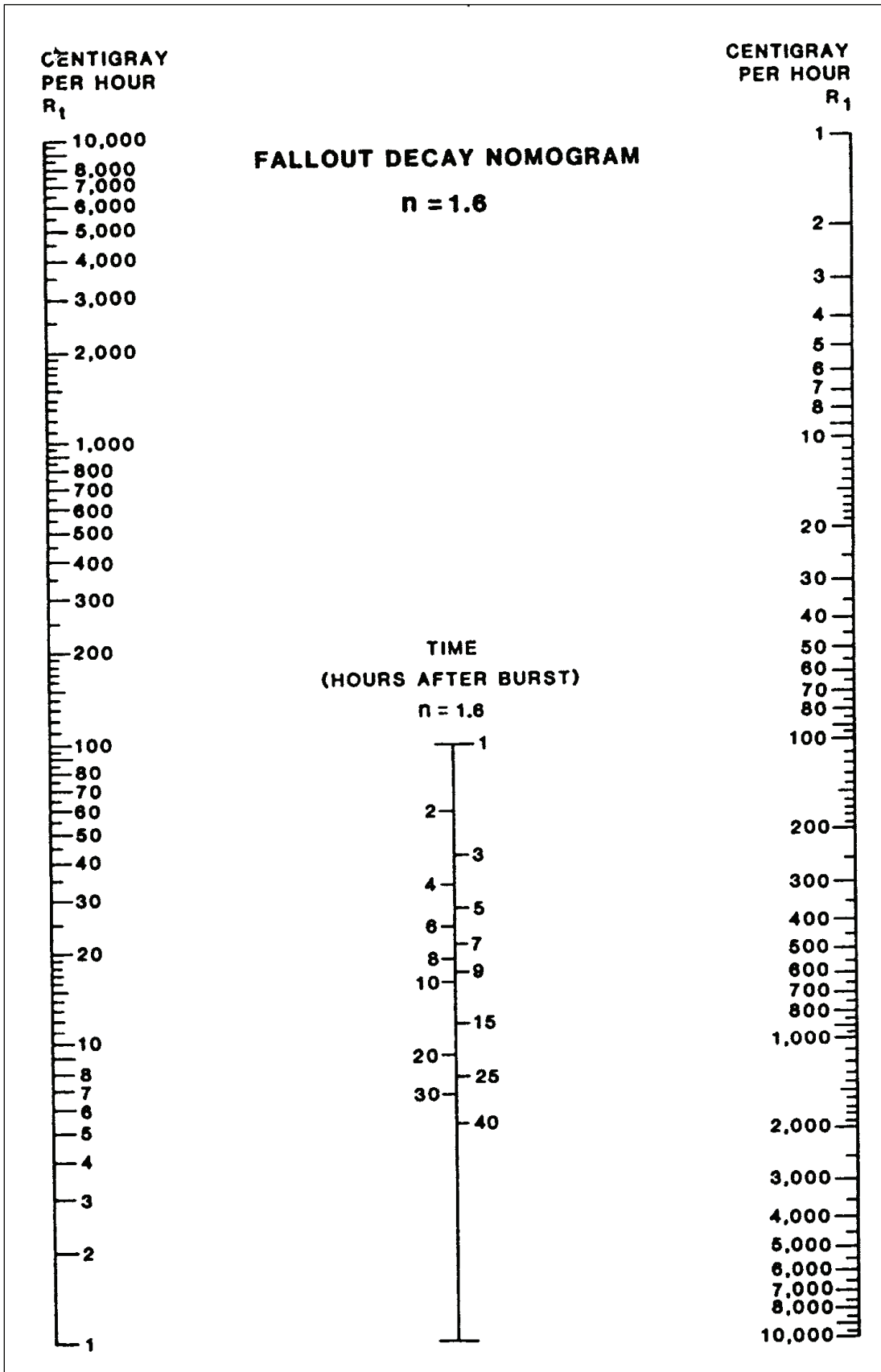

Figure J-23. Fallout Decay Nomogram (n=1.6)

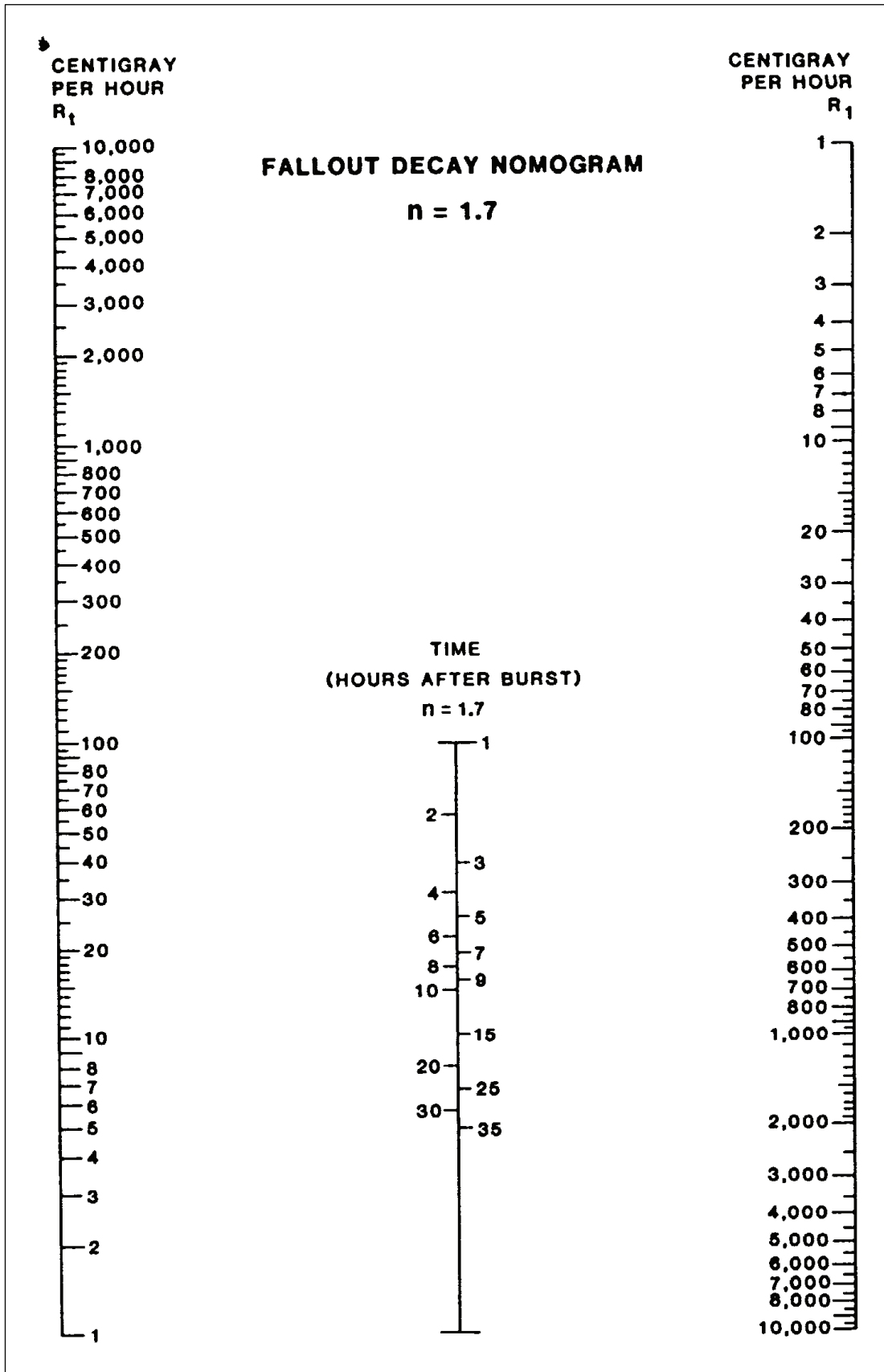

Figure J-24. Fallout Decay Nomogram (n=1.7)

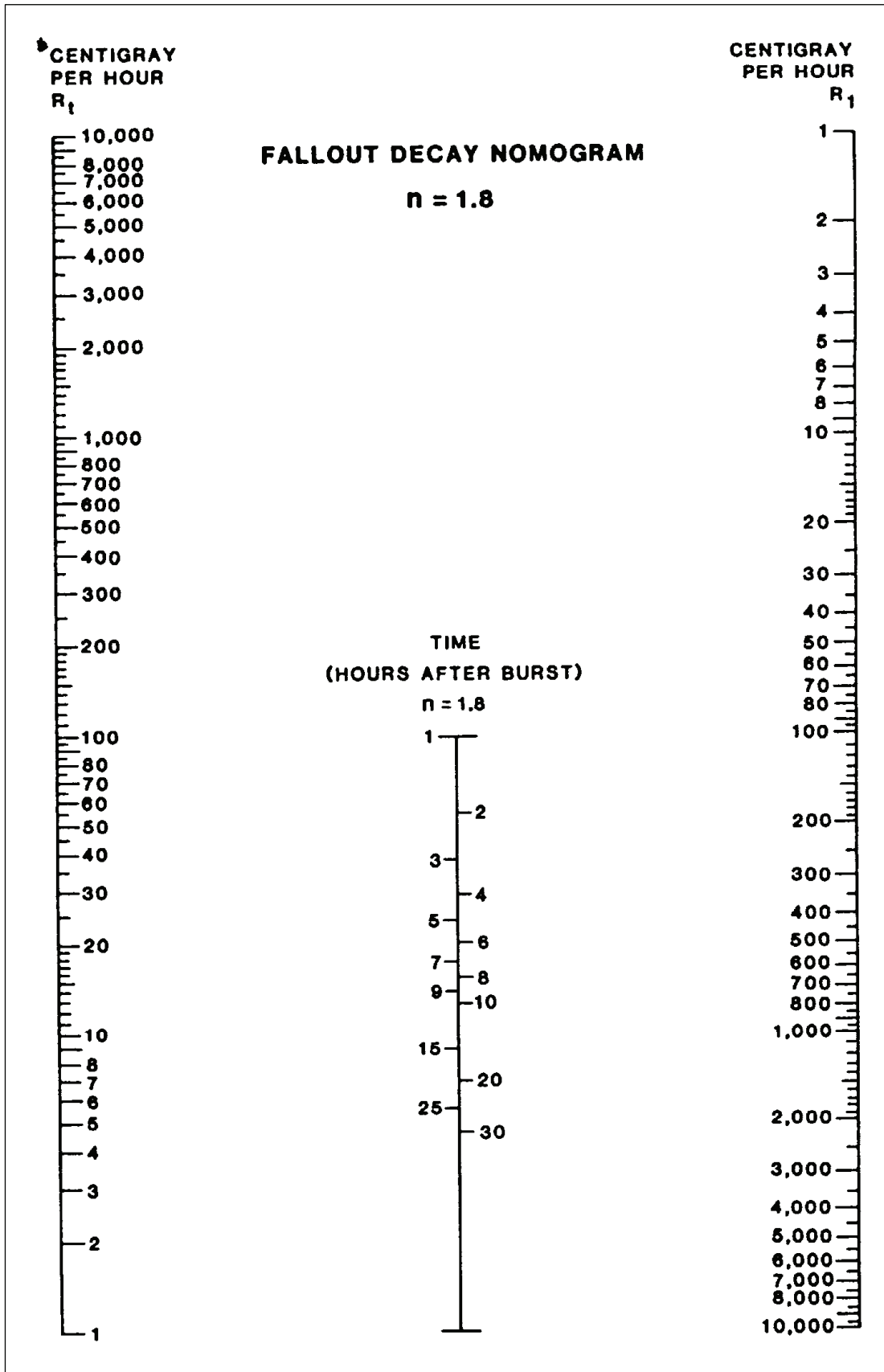

Figure J-25. Fallout Decay Nomogram (n=1.8)

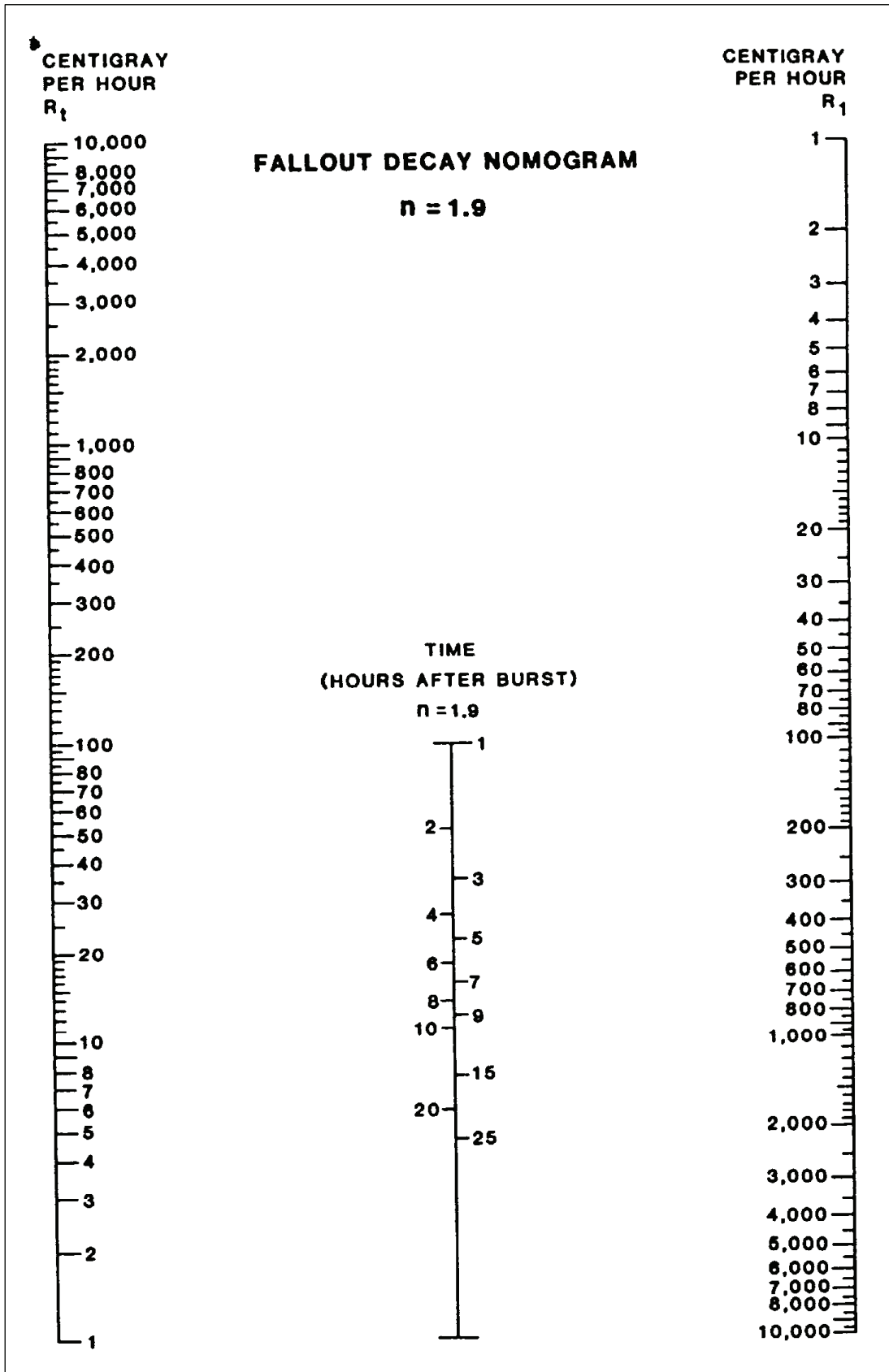

Figure J-26. Fallout Decay Nomogram (n=1.9)

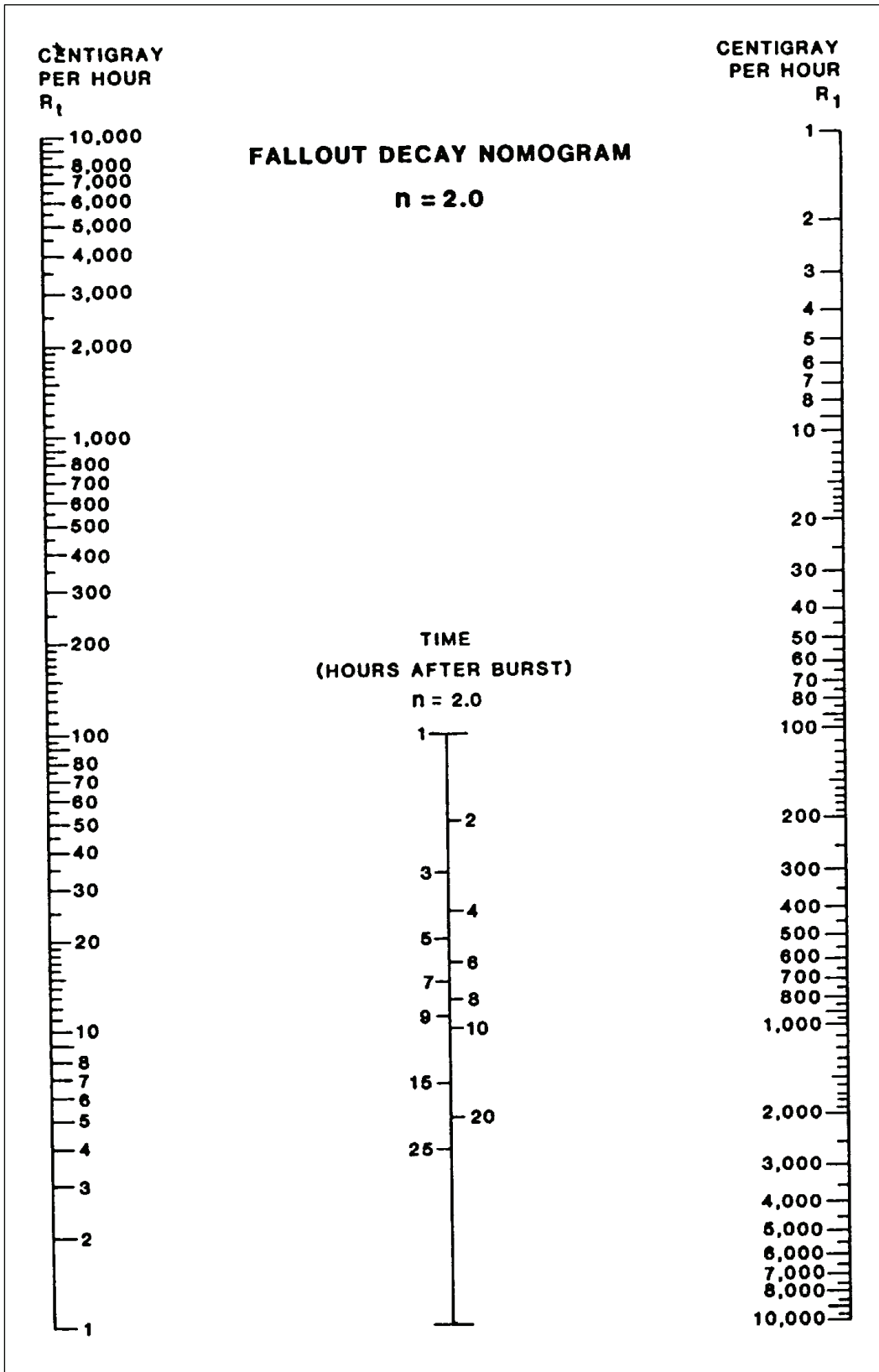

Figure J-27. Fallout Decay Nomogram (n=2.0)

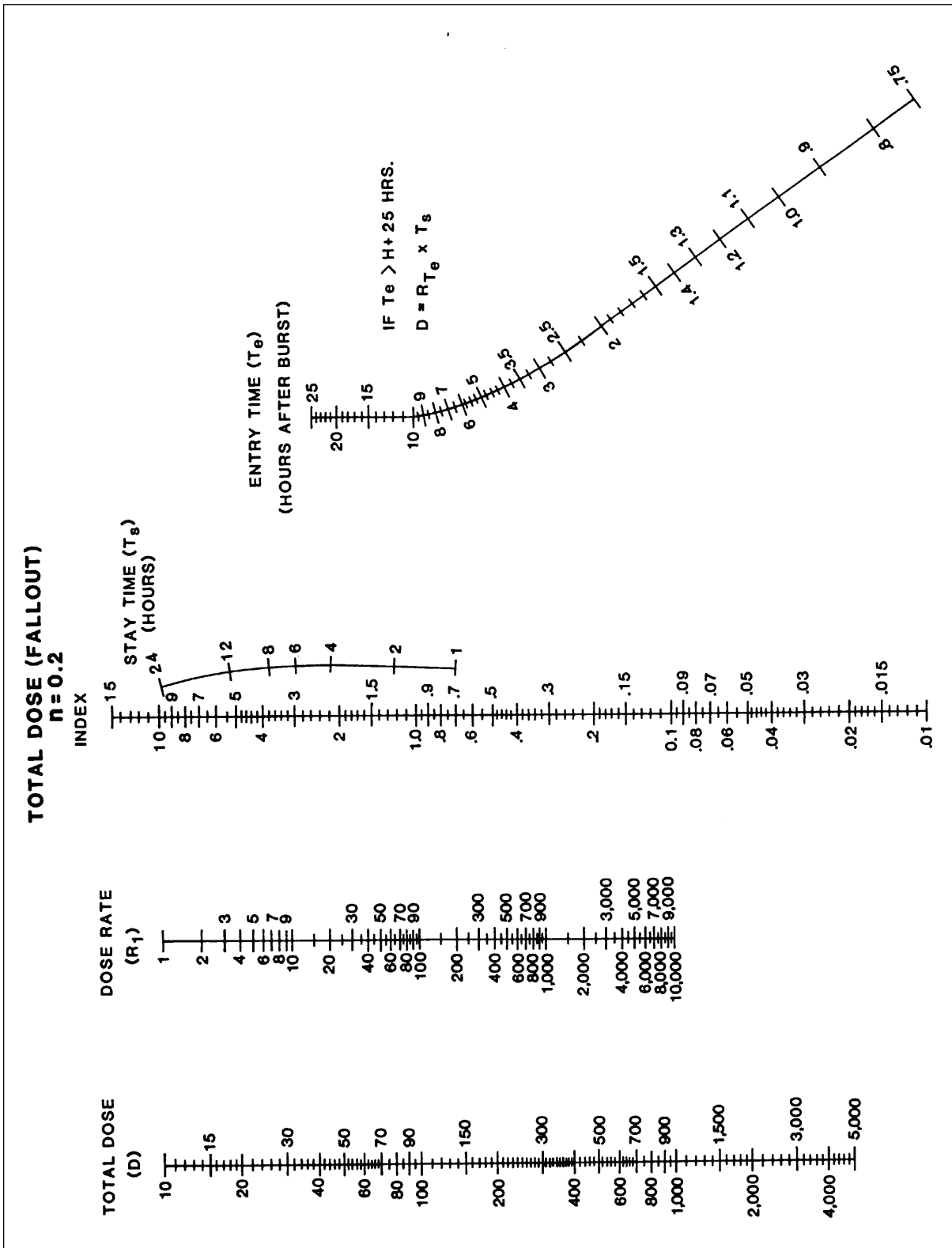

Figure J-28. Total Dose (Fallout) (n=0.2)

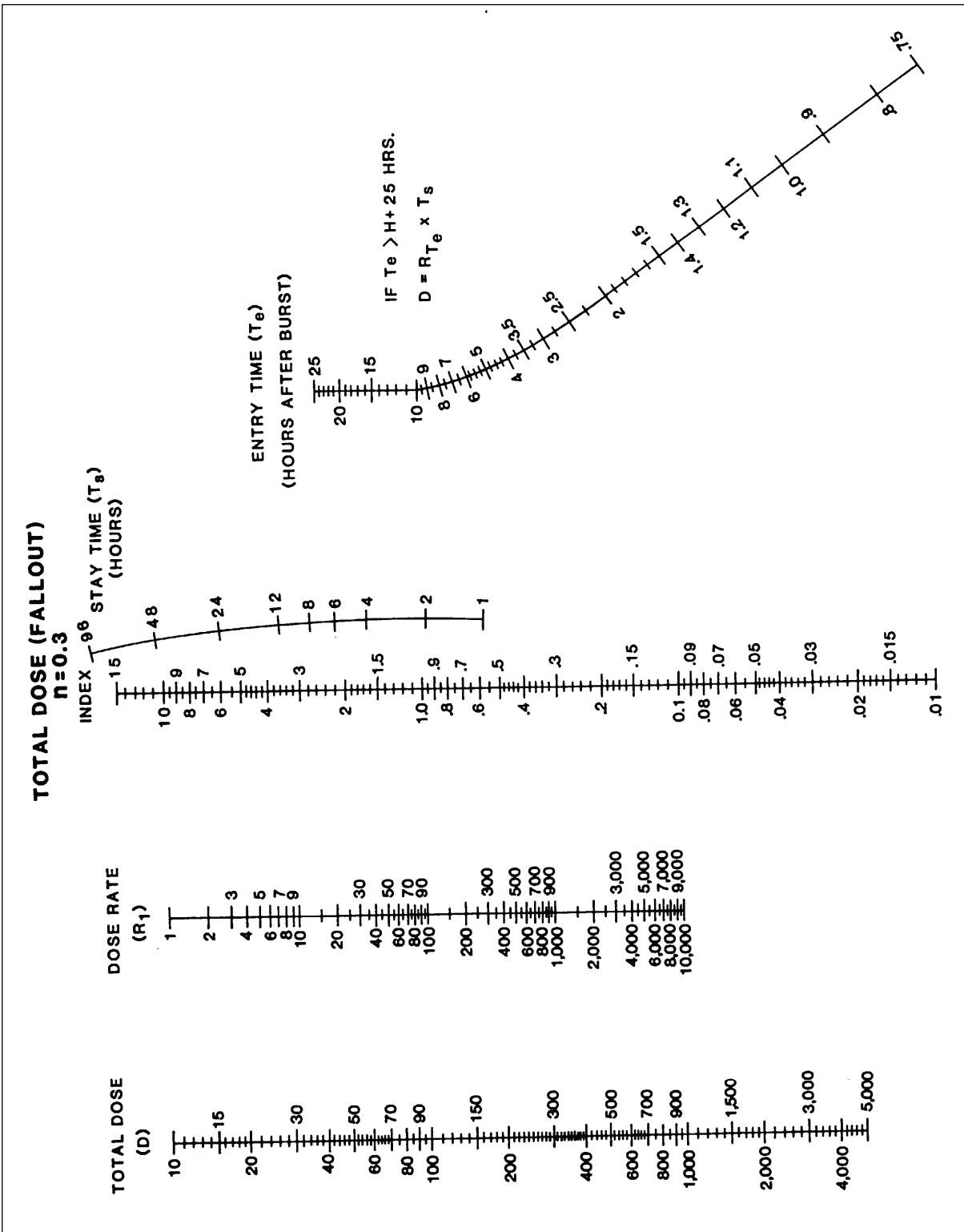

Figure J-29. Total Dose (Fallout) (n=0.3)

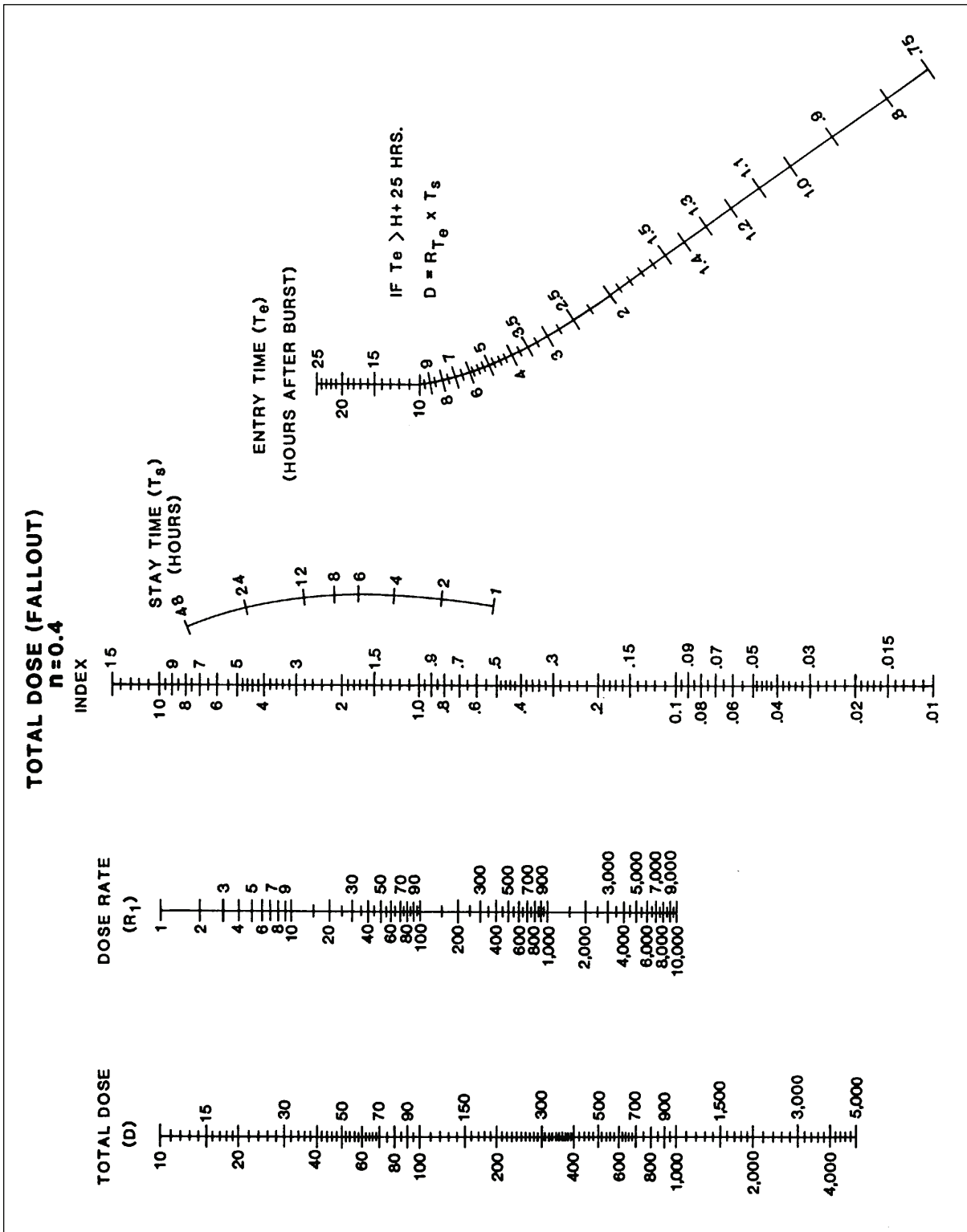

Figure J-30. Total Dose (Fallout) (n=0.4)

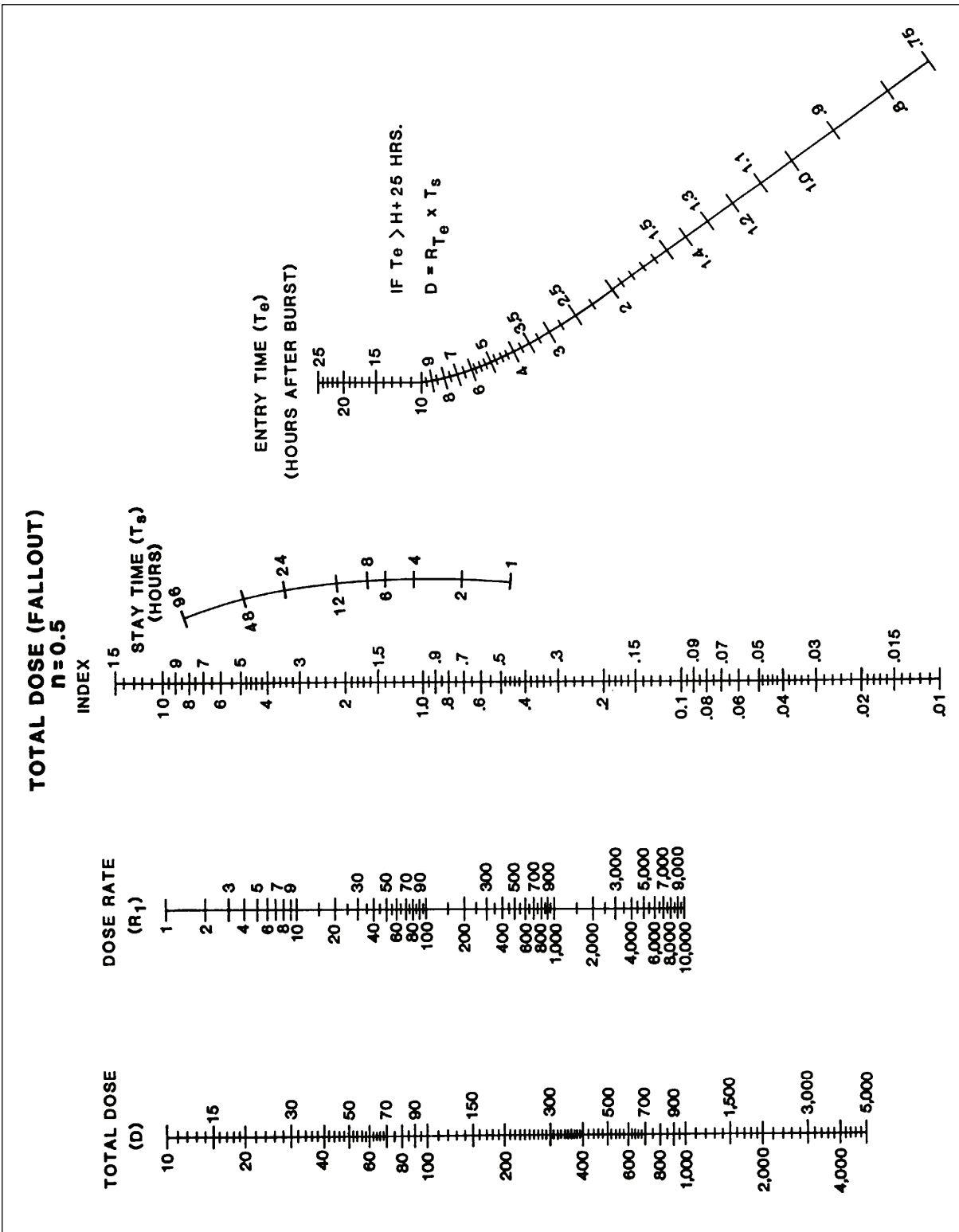

Figure J-31. Total Dose (Fallout) (n=0.5)

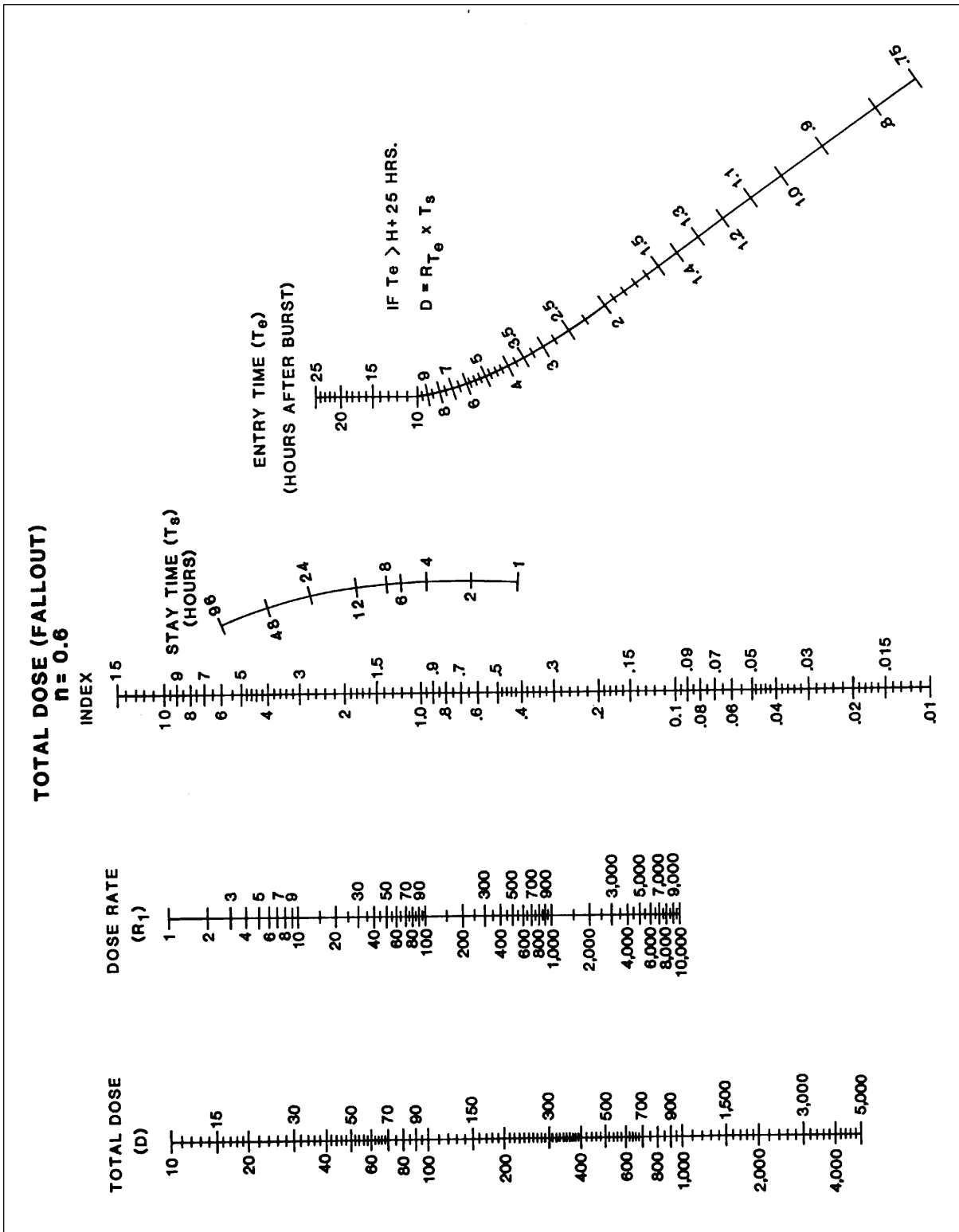

Figure J-32. Total Dose (Fallout) (n=0.6)

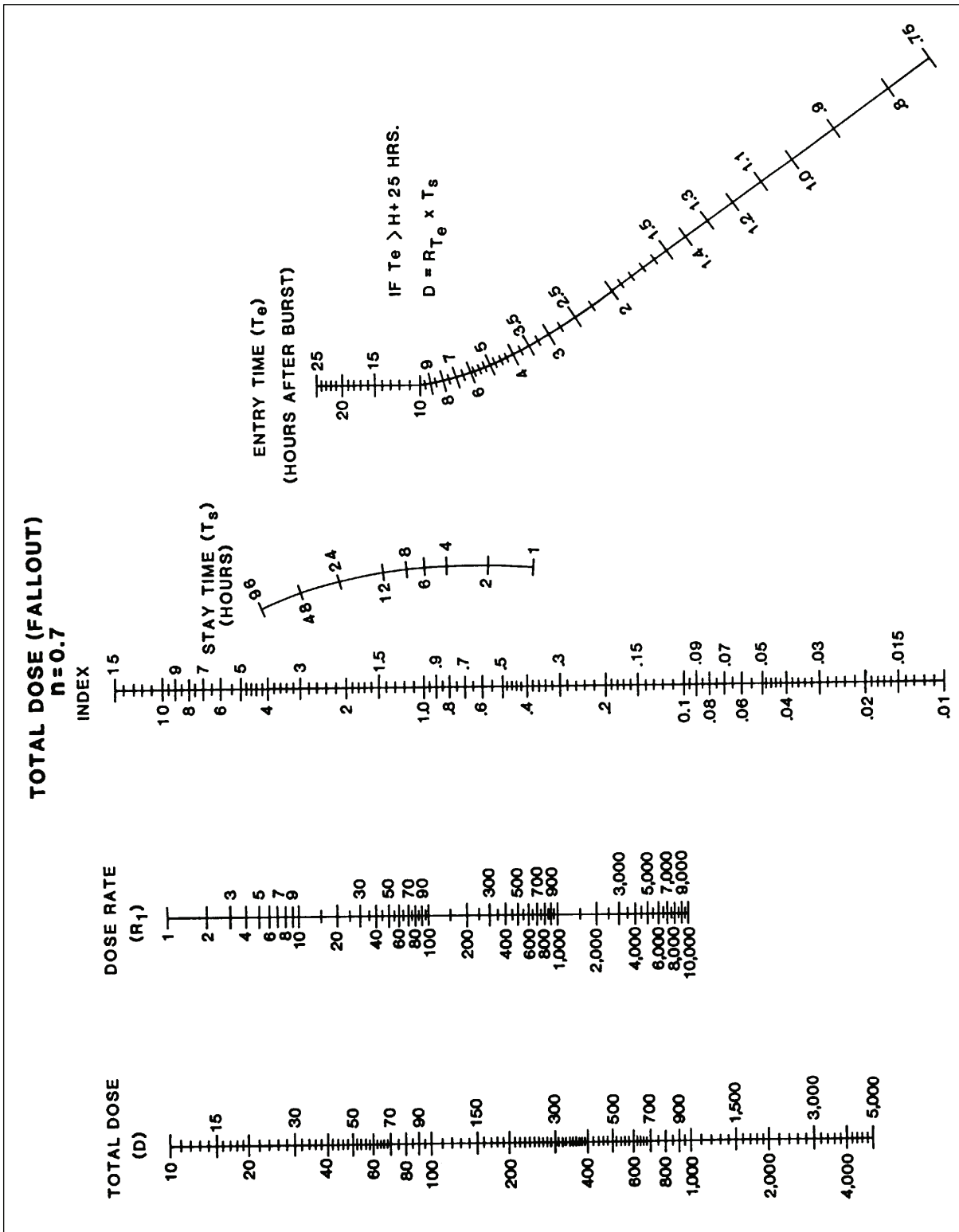

Figure J-33. Total Dose (Fallout) (n=0.7)

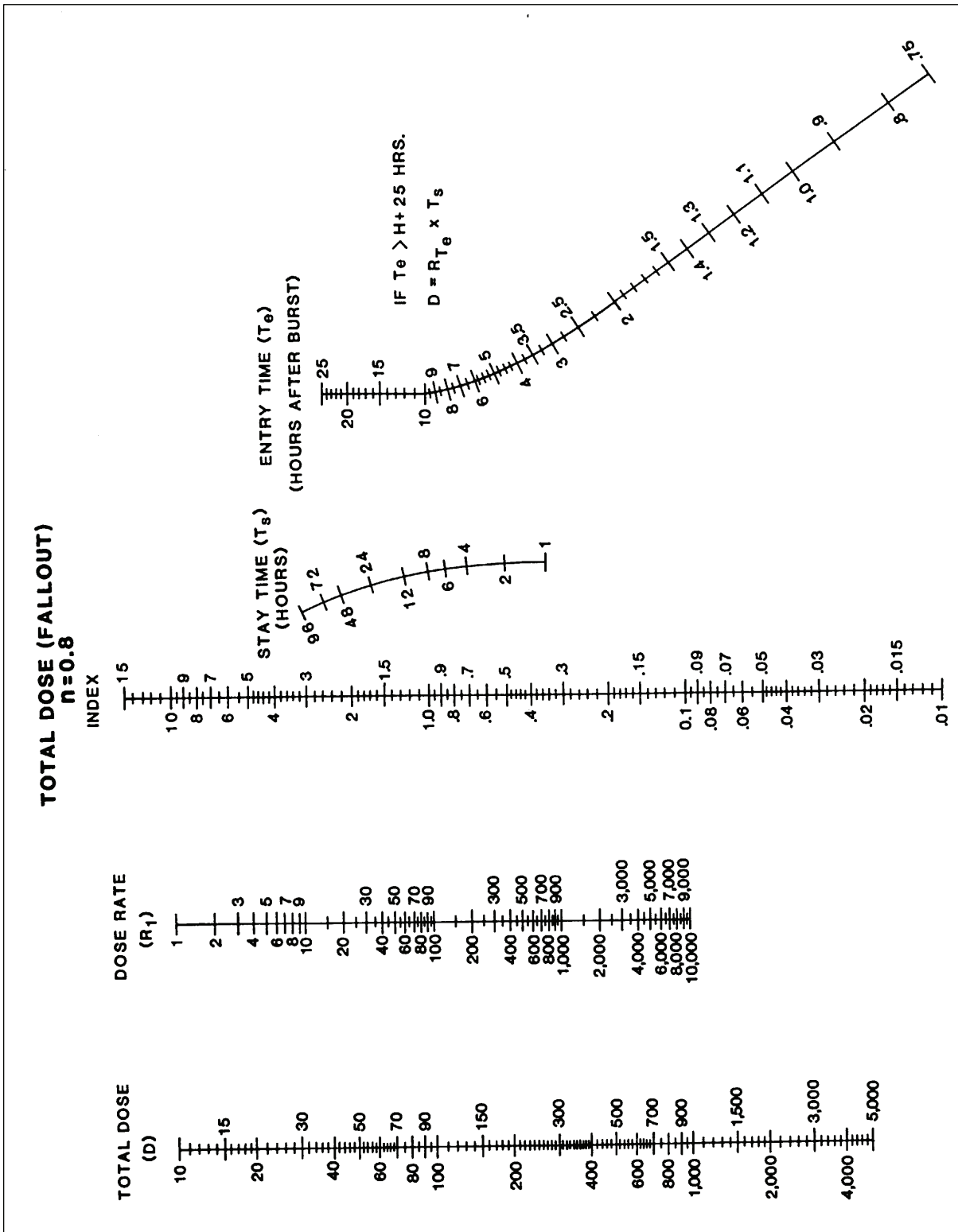

Figure J-34. Total Dose (Fallout) (n=0.8)

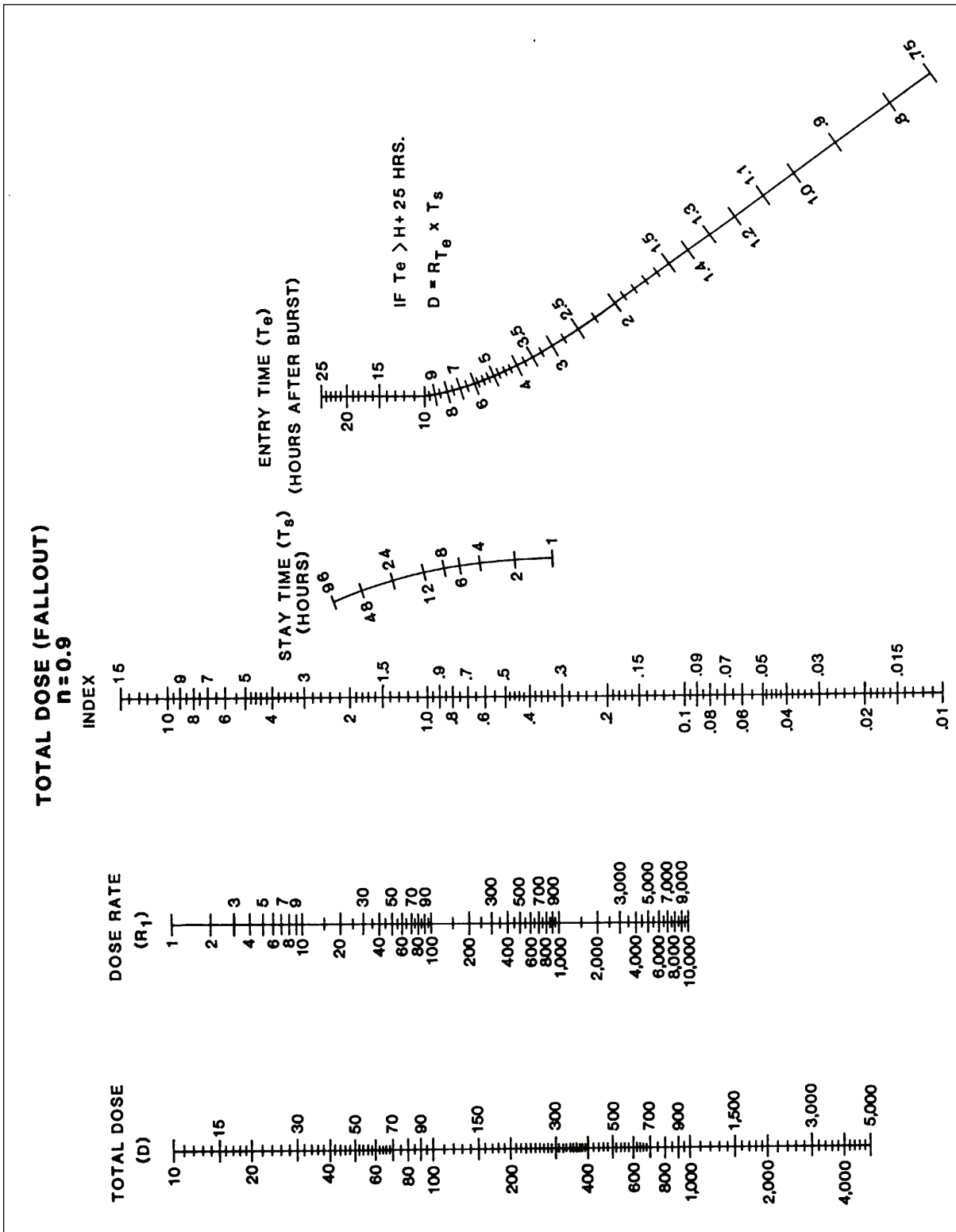

Figure J-35. Total Dose (Fallout) (n=0.9)

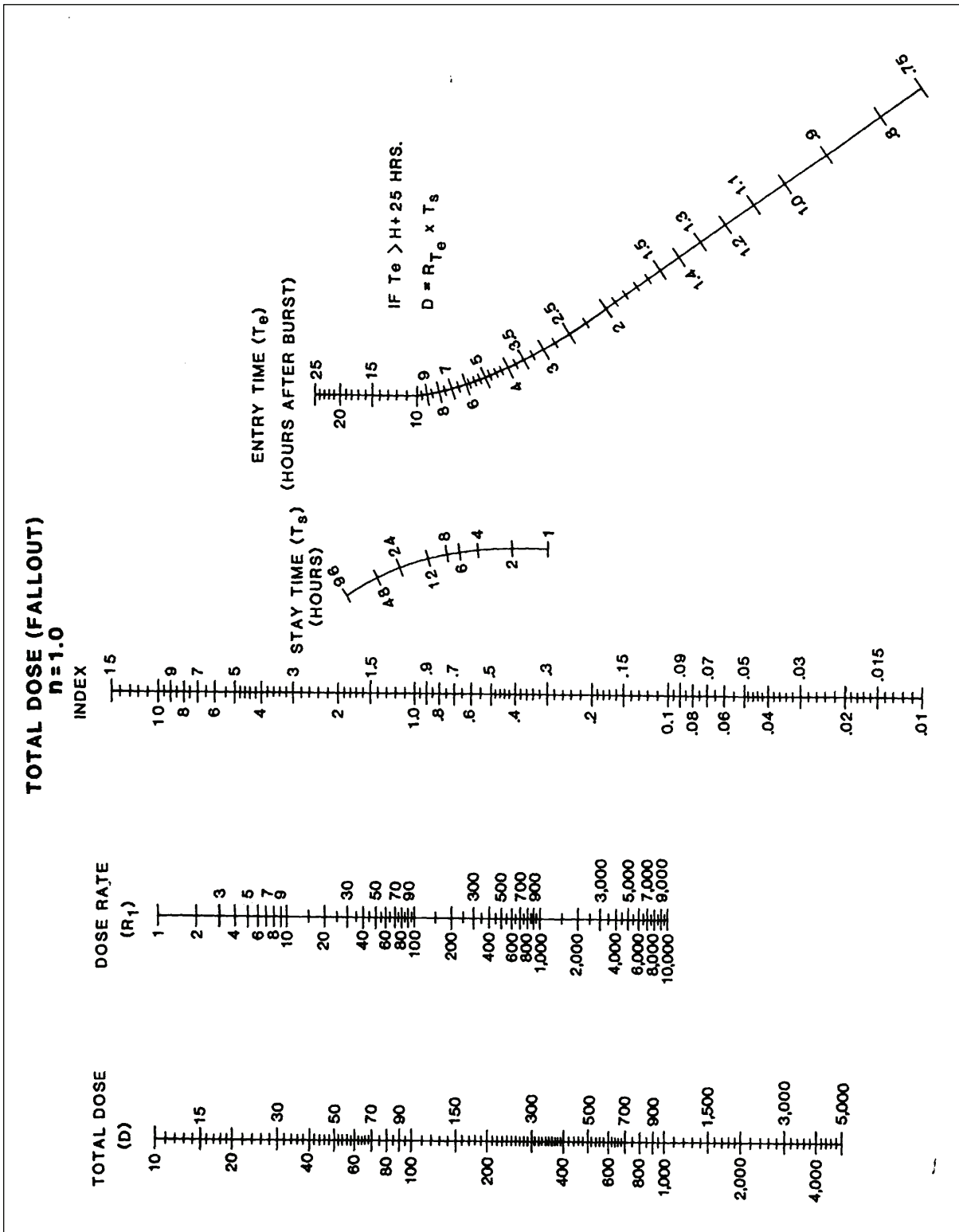

Figure J-36. Total Dose (Fallout) (n=1.0)

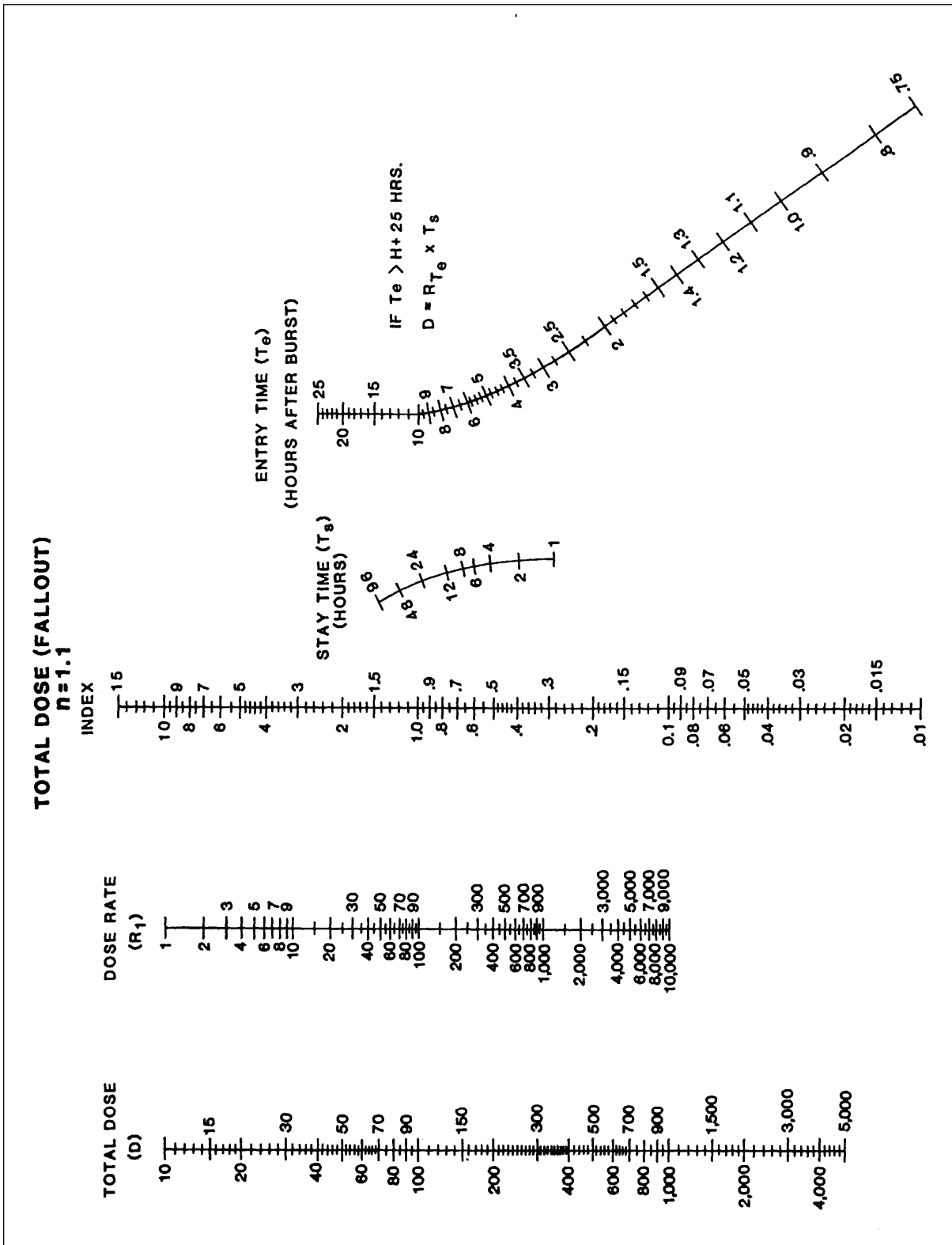

Figure J-37. Total Dose (Fallout) (n=1.1)

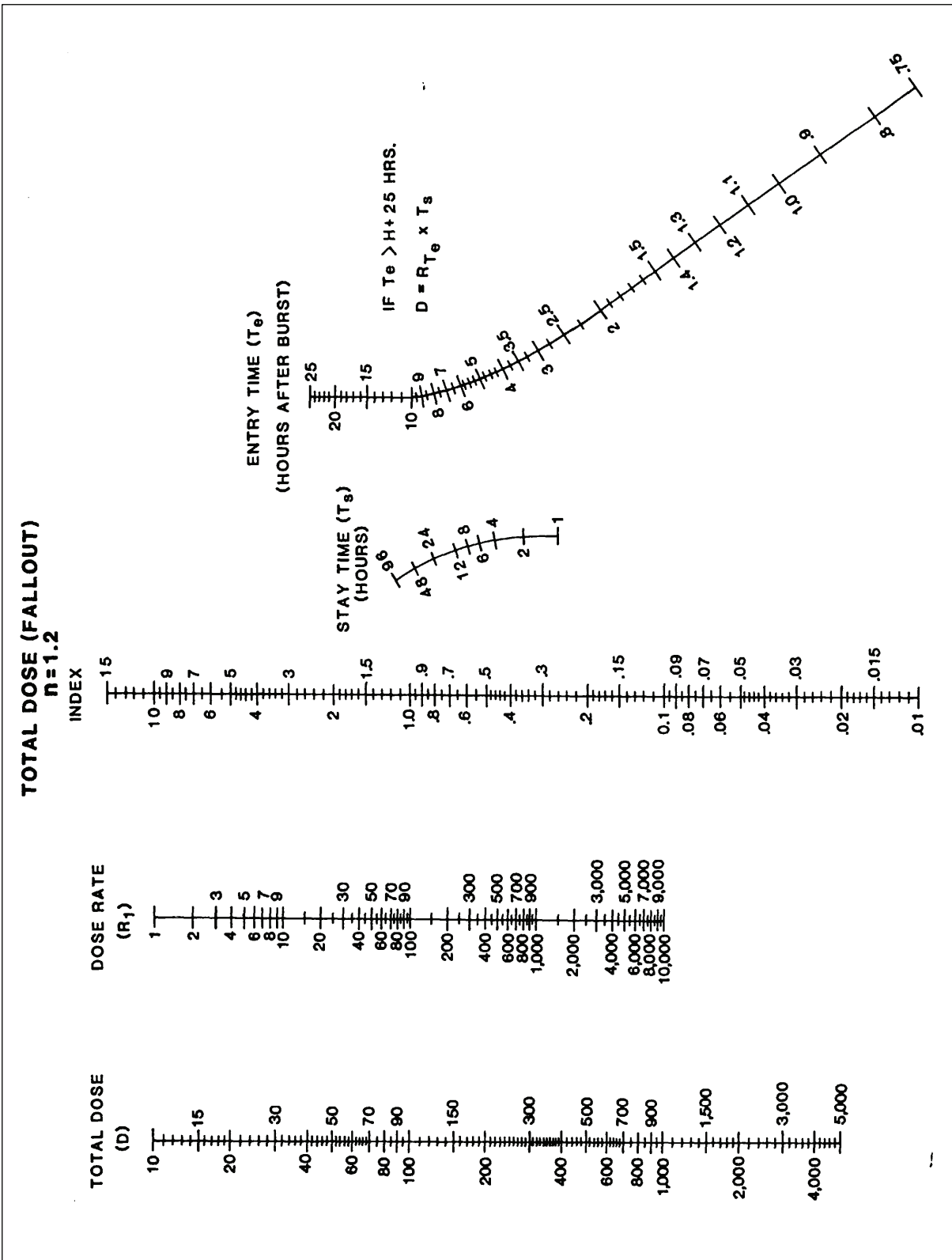

Figure J-38. Total Dose (Fallout) (n=1.2)

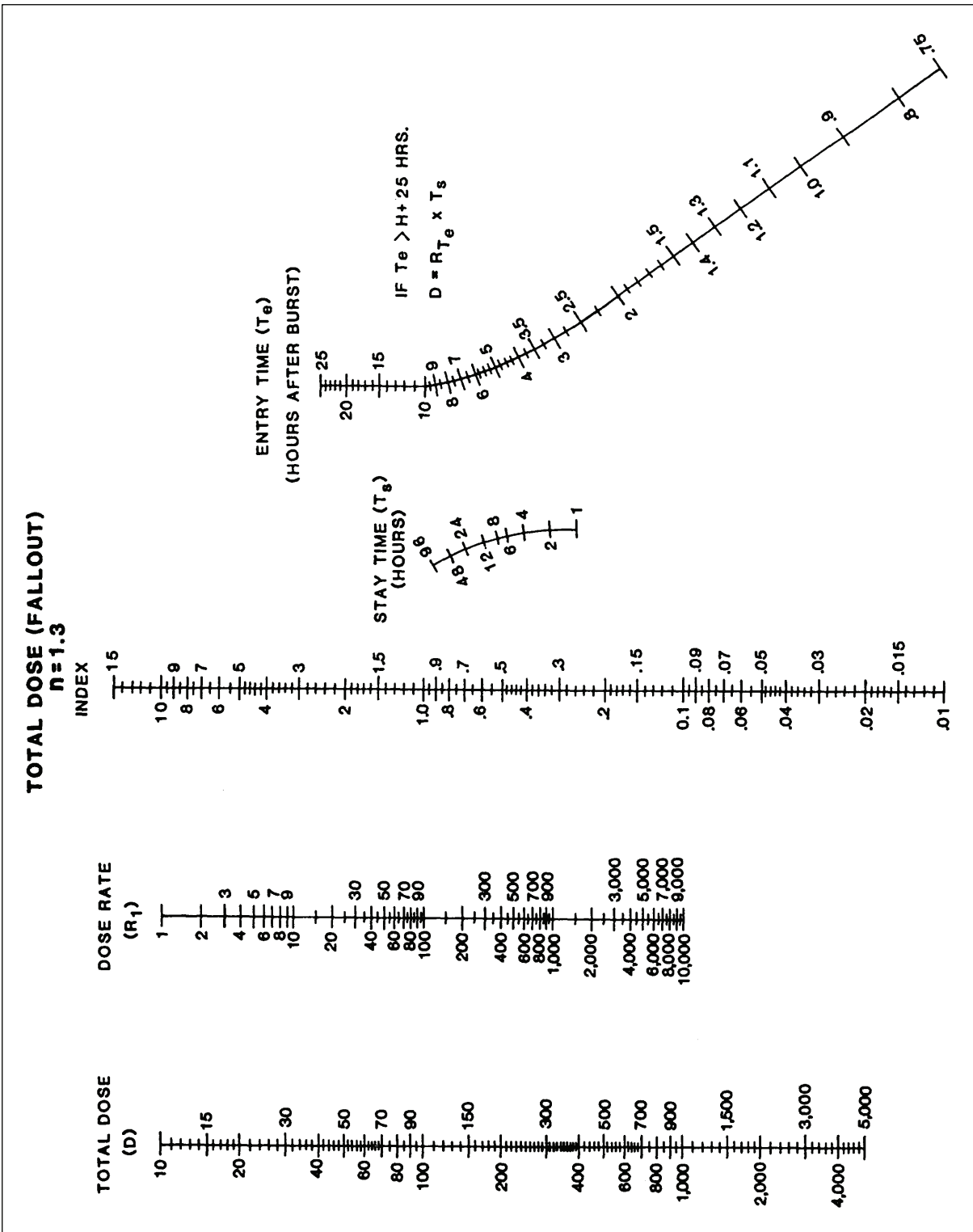

Figure J-39. Total Dose (Fallout) (n=1.3)

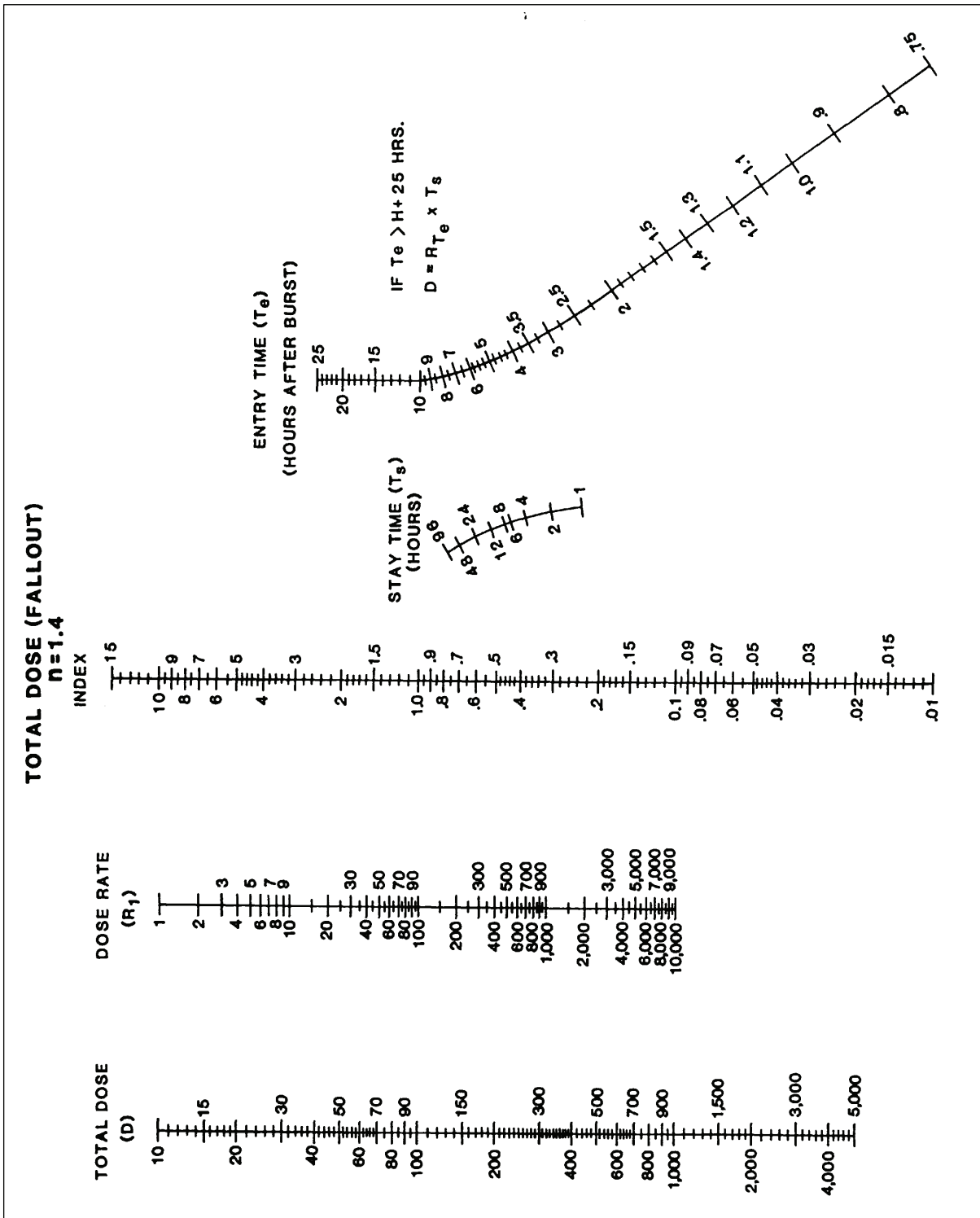

Figure J-40. Total Dose (Fallout) (n=1.4)

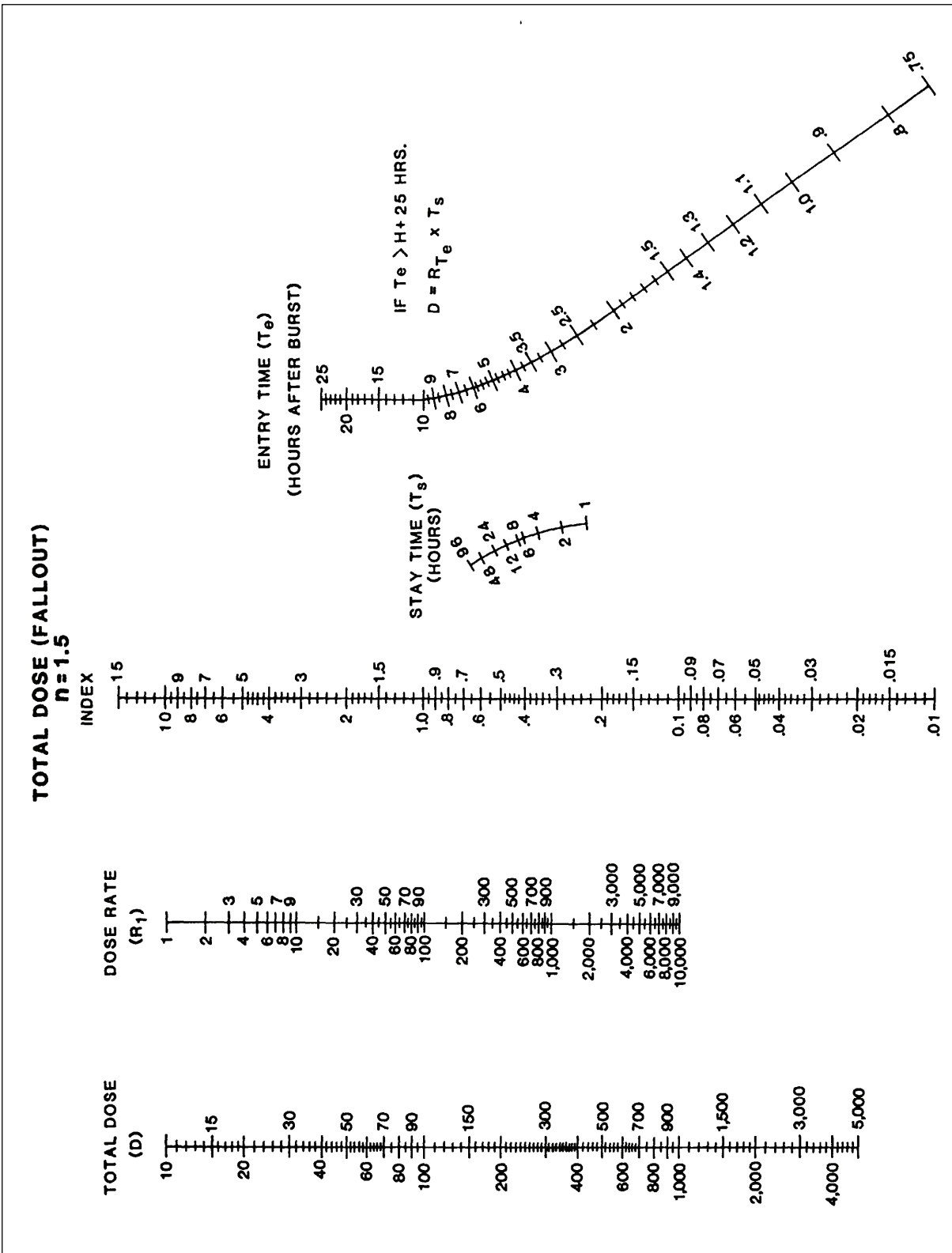

Figure J-41. Total Dose (Fallout) (n=1.5)

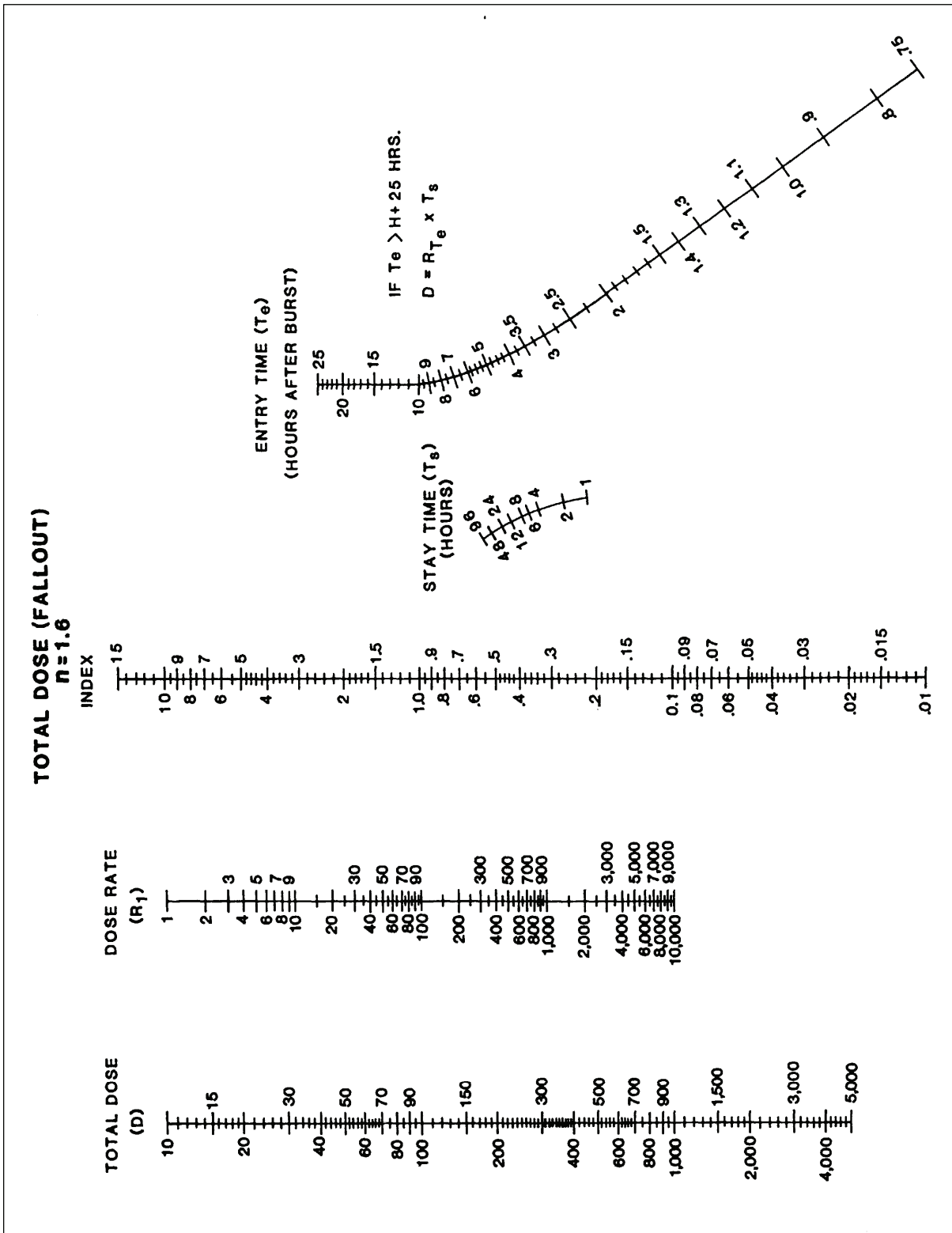

Figure J-42. Total Dose (Fallout) (n=1.6)

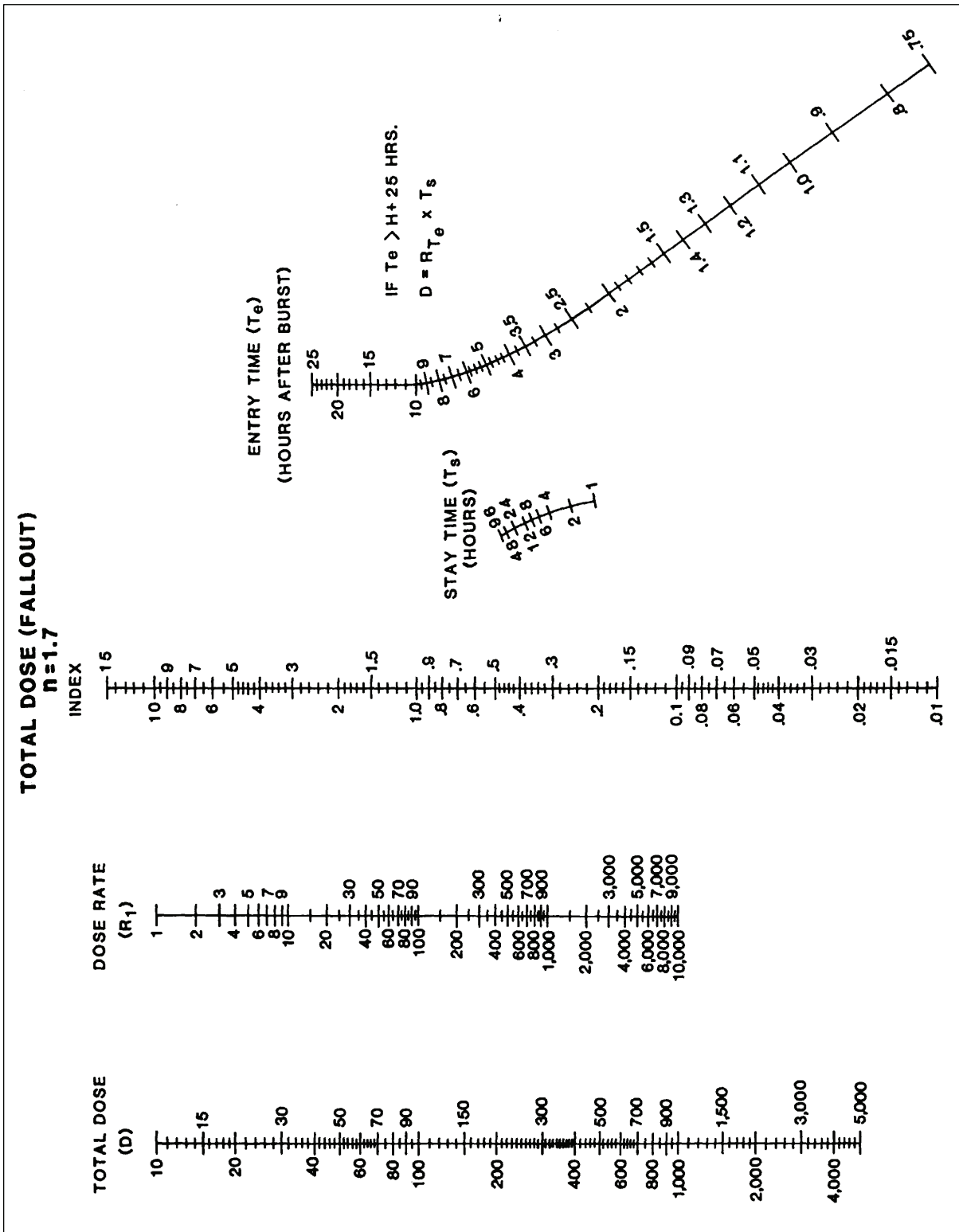

Figure J-43. Total Dose (Fallout) (n=1.7)

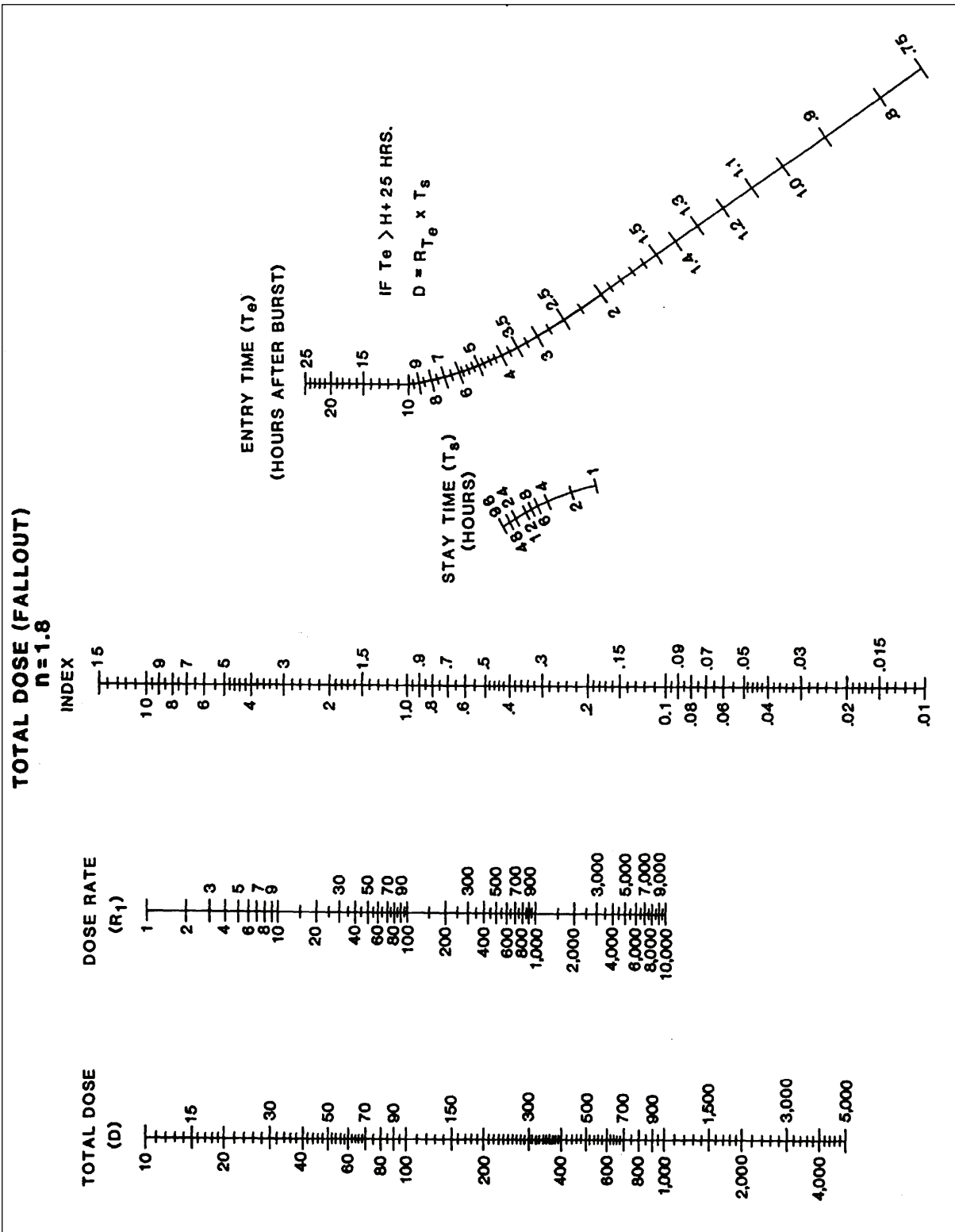

Figure J-44. Total Dose (Fallout) (n=1.8)

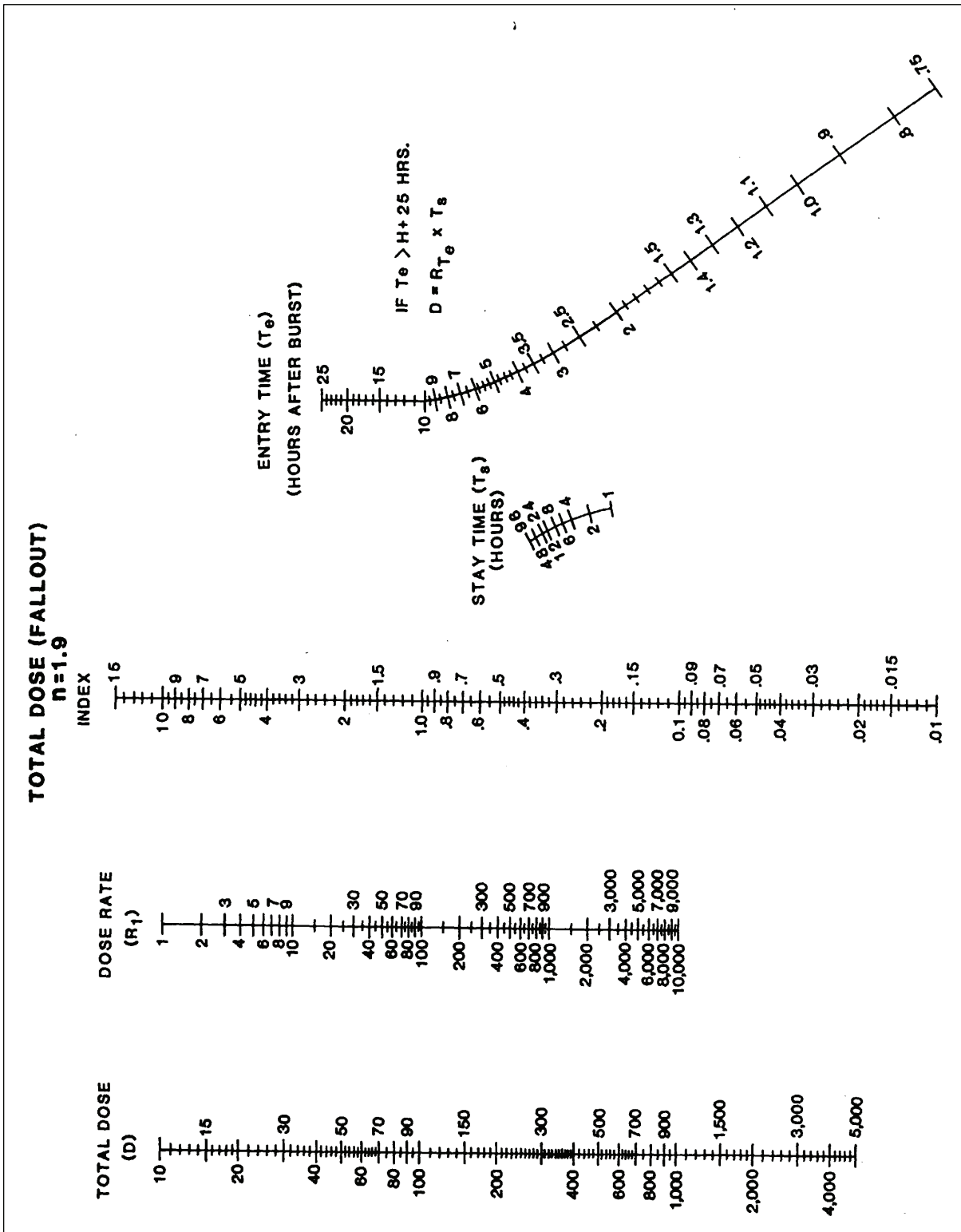

Figure J-45. Total Dose (Fallout) (n=1.9)

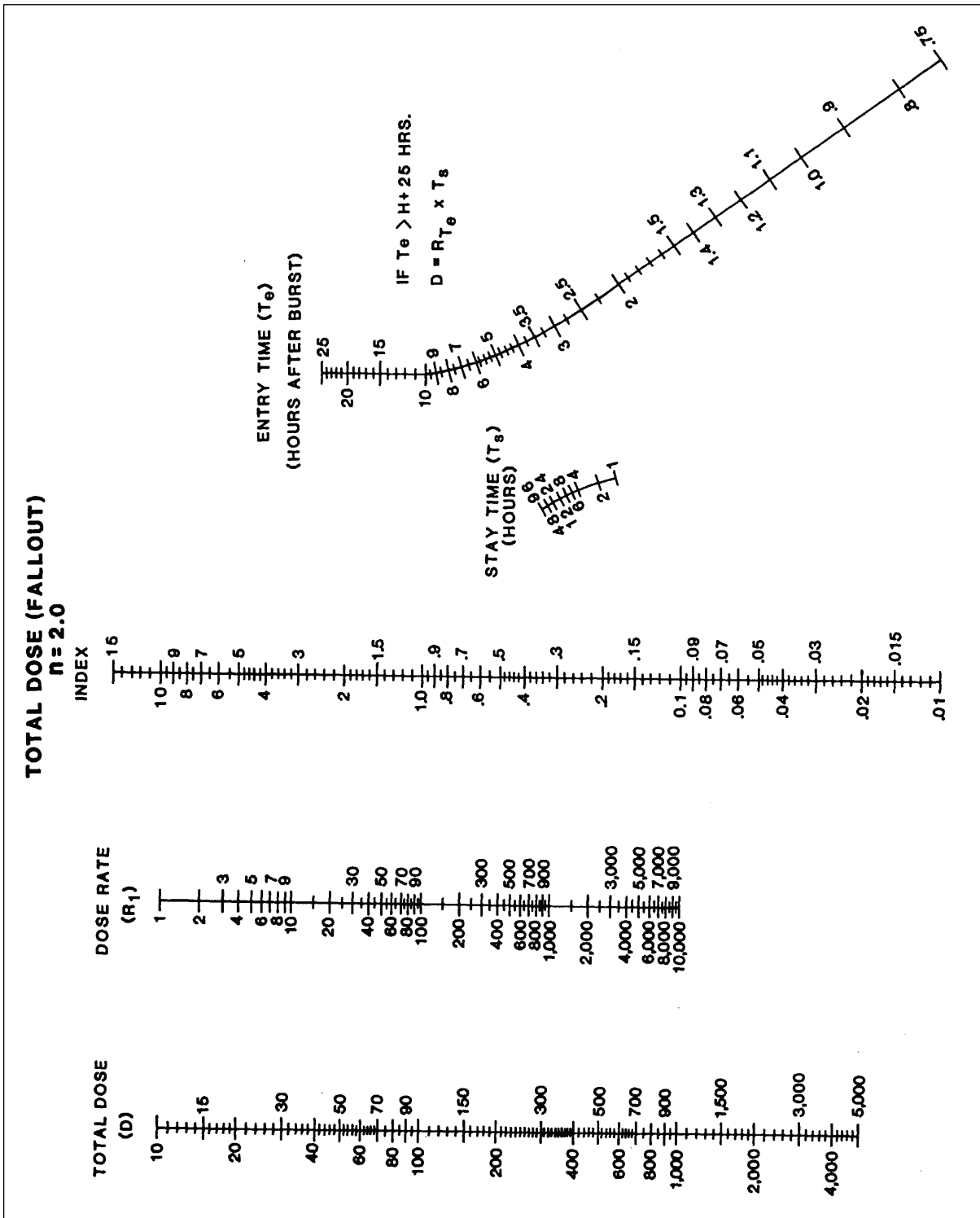

Figure J-46. Total Dose (Fallout) (n=2.0)

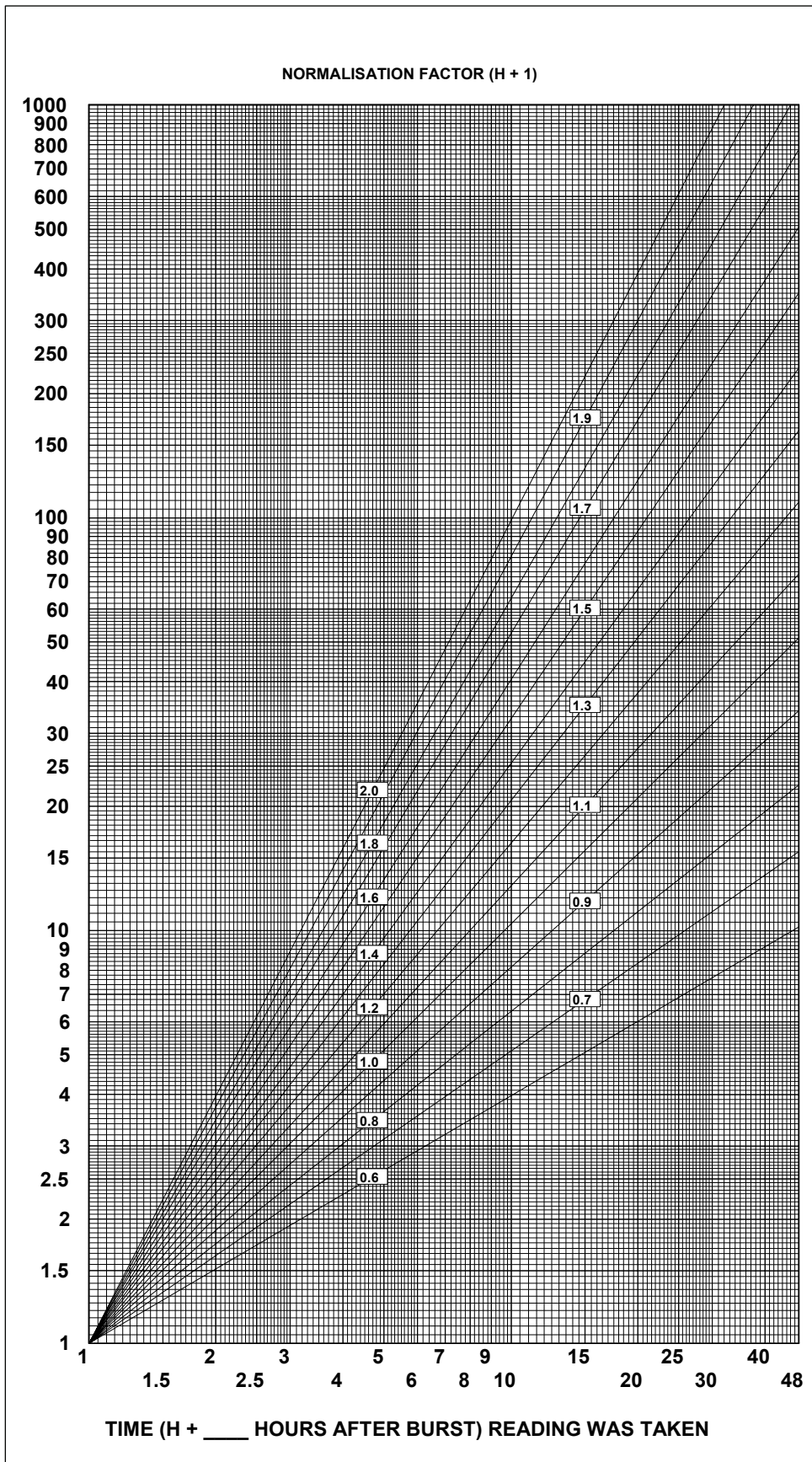

Figure J-47. Graphical Method for Determining Normalization Factor (H+1)

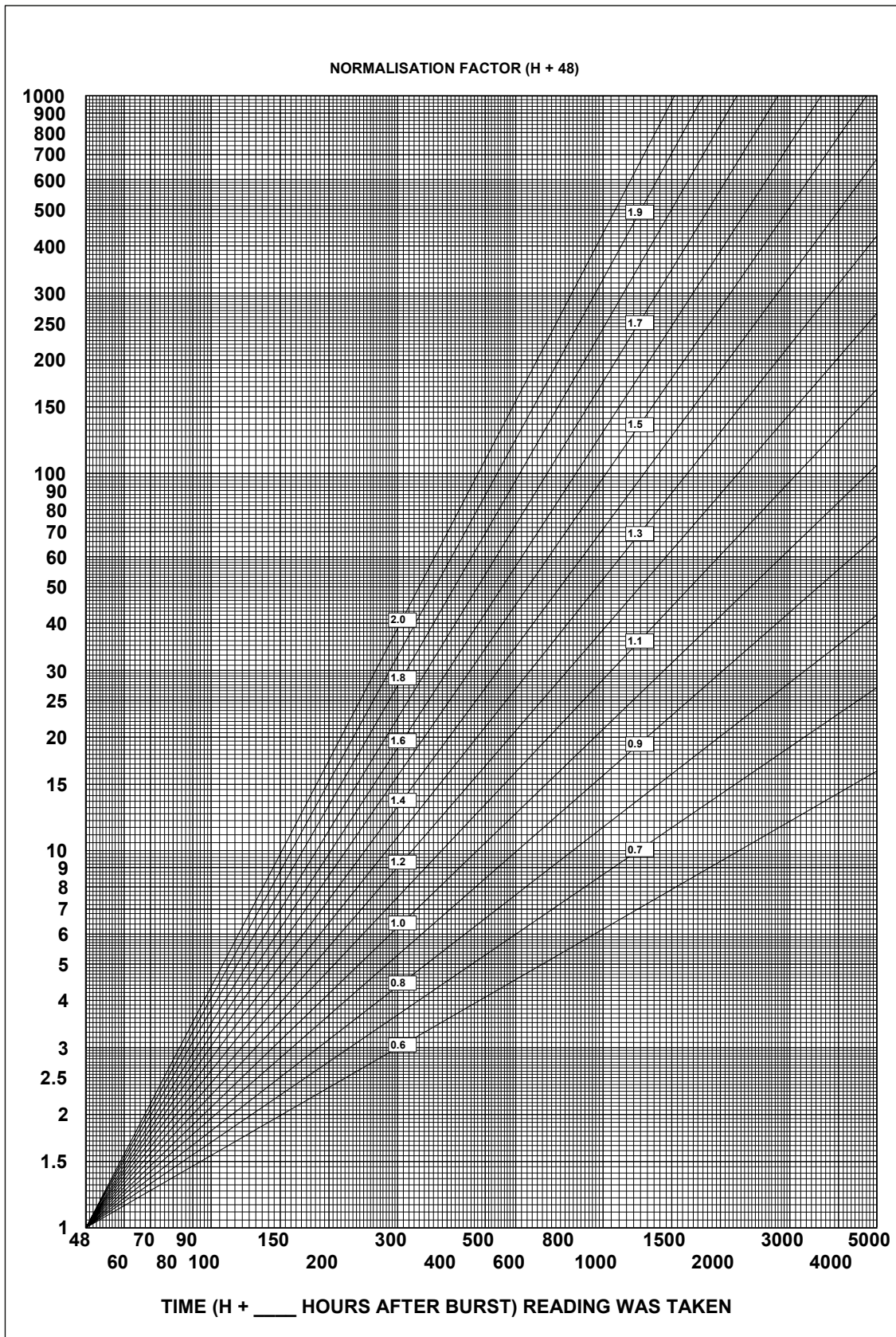

Figure J-48. Graphical Method for Determining Normalization Factor (H+48)

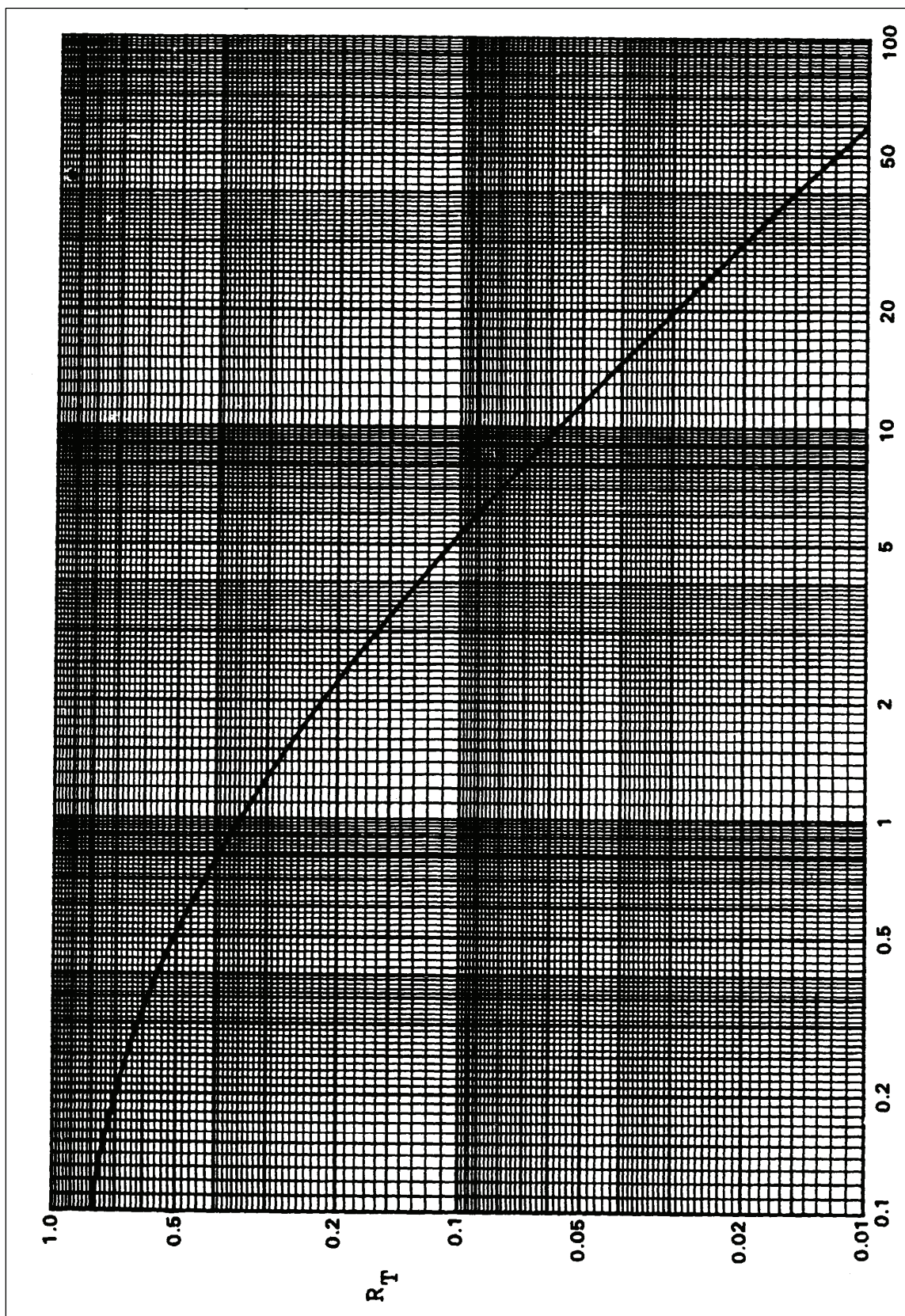

Figure J-49. Multiplication Factor

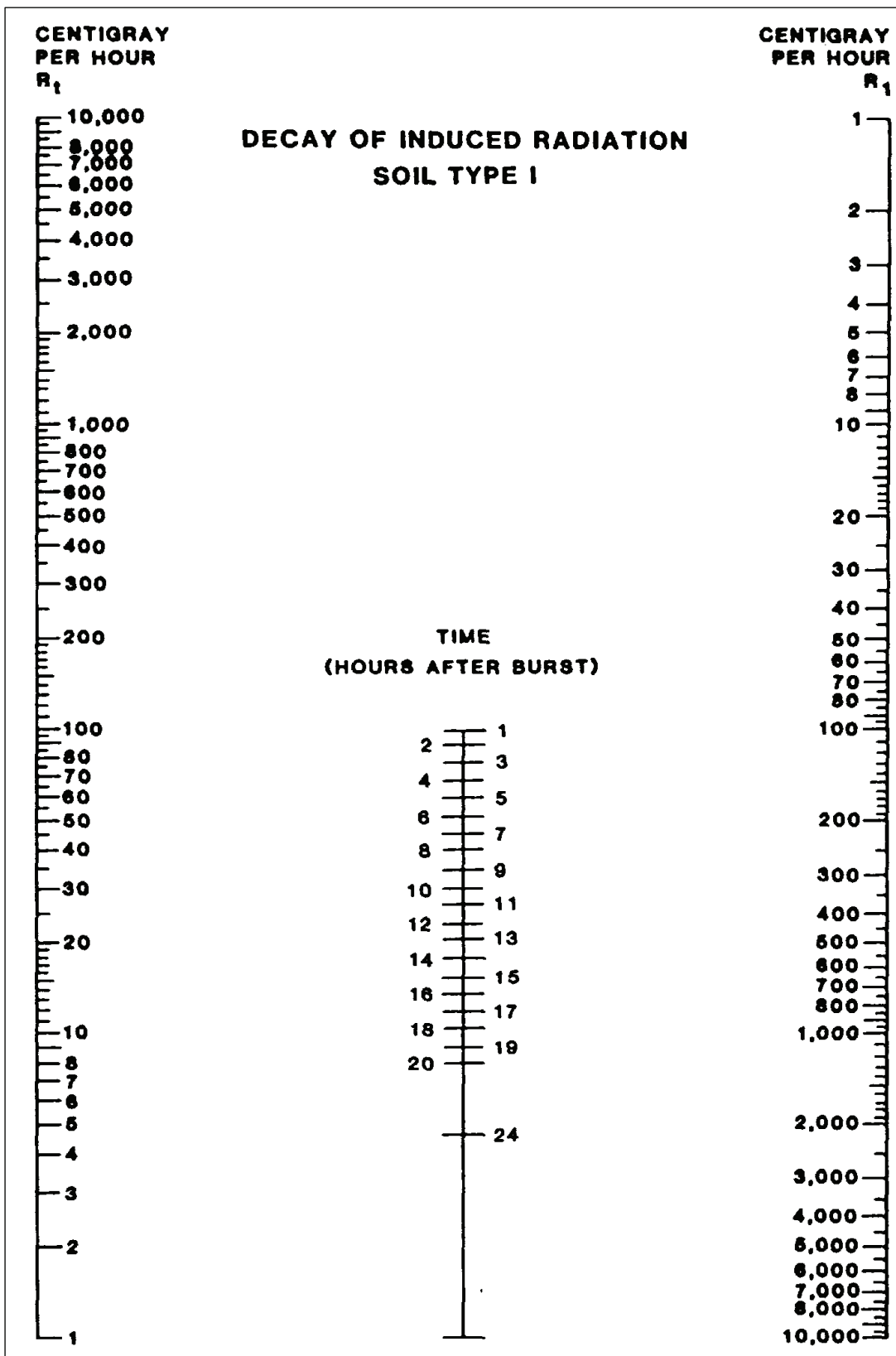

Figure J-50. Decay of Induced Radiation (Soil Type I)

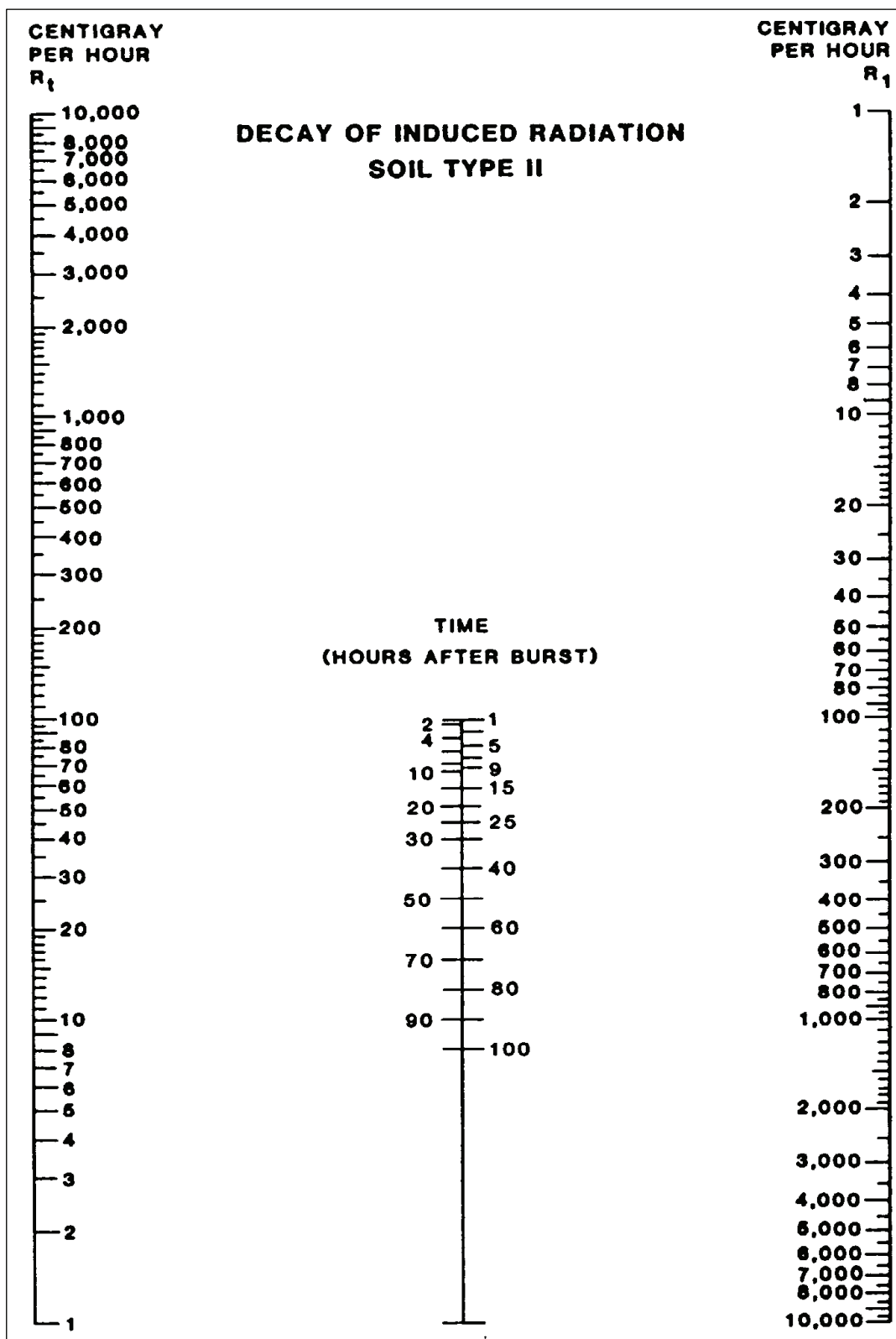

Figure J-51. Decay of Induced Radiation (Soil Type II)

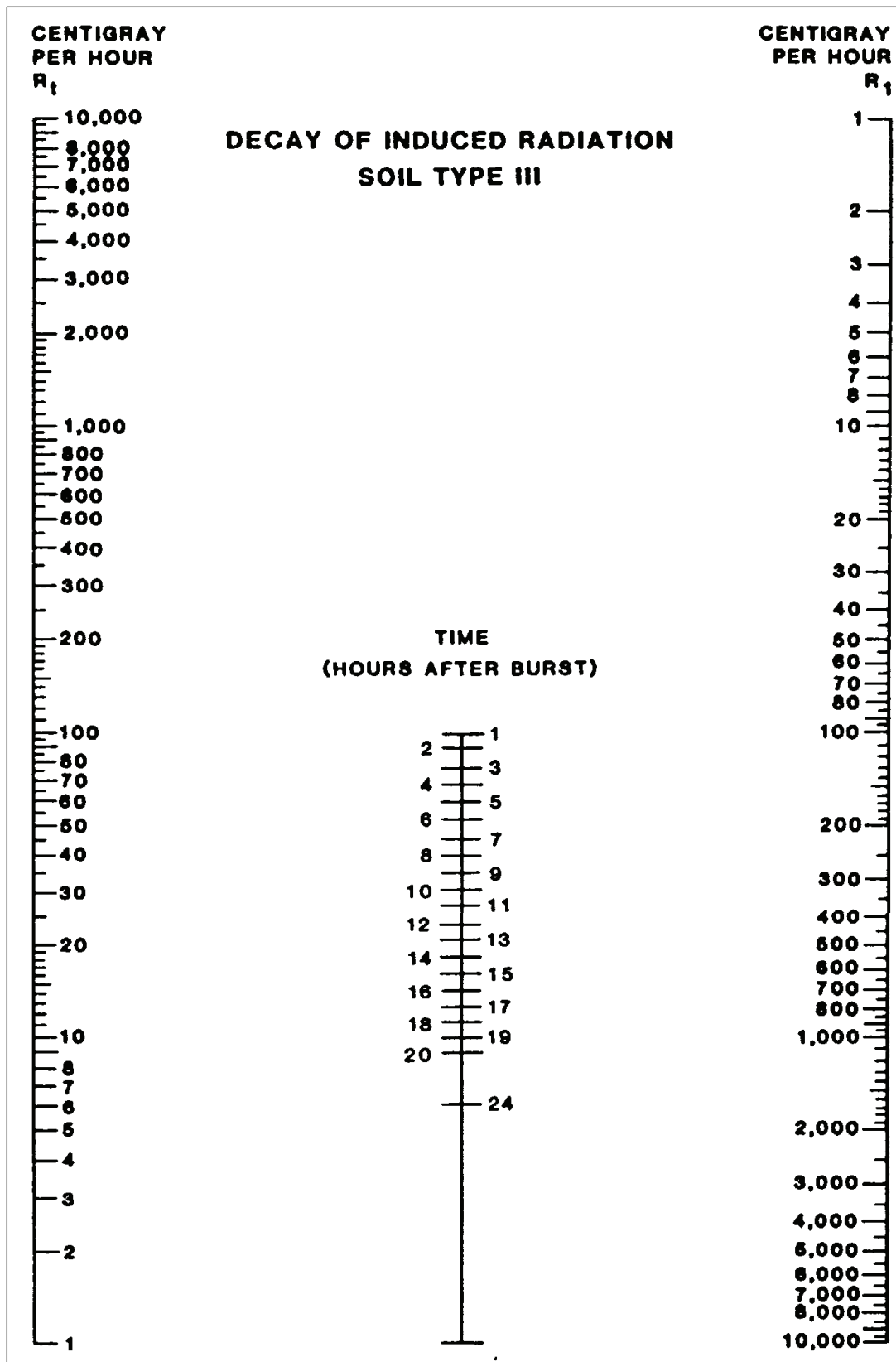

Figure J-52. Decay of Induced Radiation (Soil Type III)

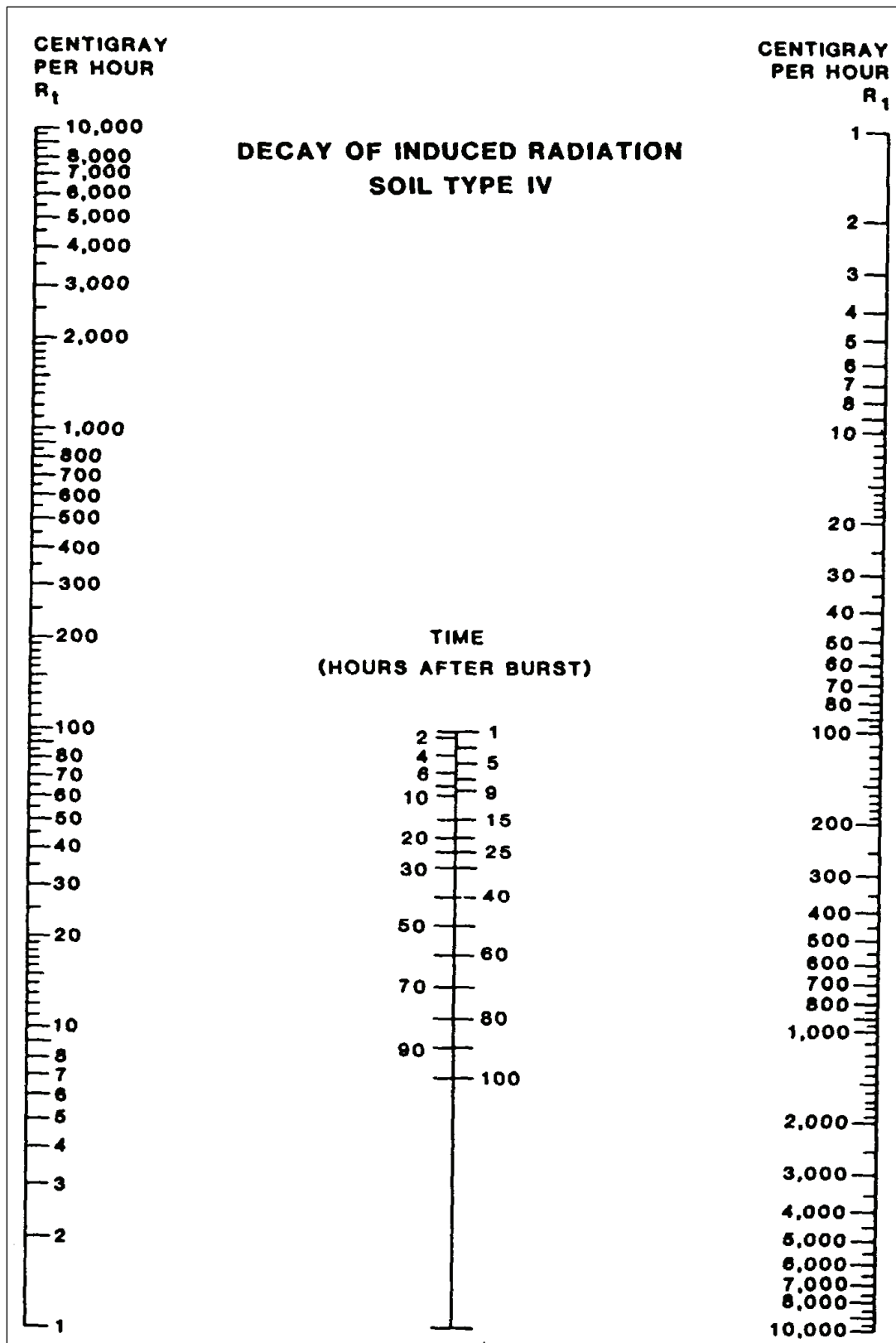

Figure J-53. Decay of Induced Radiation (Soil Type IV)

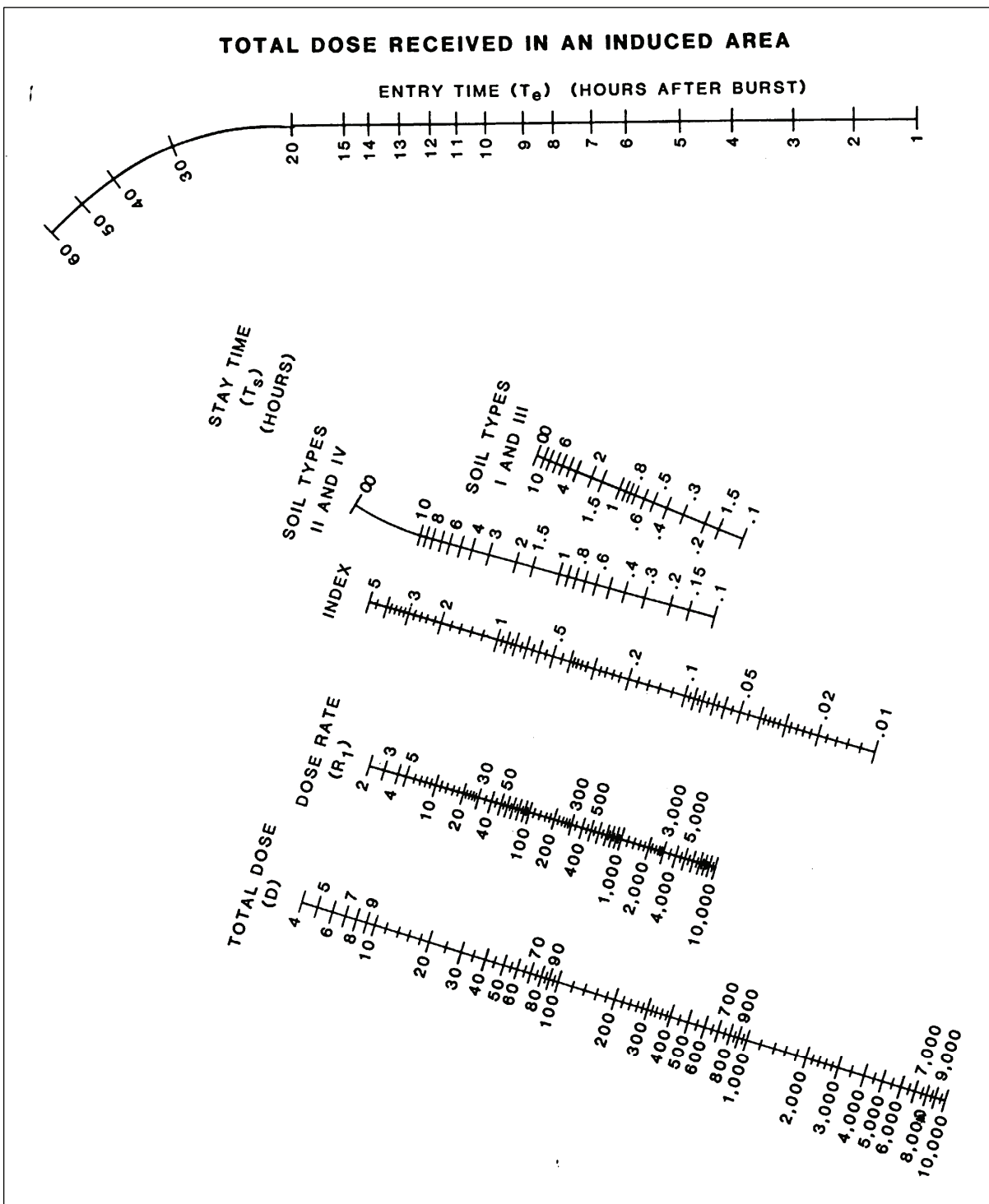

Figure J-54. Total Dose (Induced Radiation)

Appendix K

CALCULATIONS

This appendix provides a single reference location for CBRN hazard prediction-related calculations.

Downwind travel distance:

$$d_1 = u_1 * t_1$$

$$d_2 = 2u_2$$

$$d_3 = 2u_3$$

Total Downwind Distance:

$$DA = d_1 + d_2 + d_3$$

Leading and Trailing Edge:

$$DL = 1.5 * DA \text{ (Leading Edge, in KM)}$$

$$DT = 0.5 * DA \text{ (Trailing Edge, in KM)}$$

Initial Hazard Area (BIO only):

$$H_1 = A + d_1 \text{ or } A + (u_1 * t_1)$$

The following are calculations contained in Appendix G for nuclear contamination avoidance TTP:

Polar Plot Method for Determining GZ:

$$0.35 \text{ kmph} \times \text{time(s)} = \text{Distance to GZ, in km}$$

M4A1 Calculator:

$$\text{Covert degrees to mils (17.8 x degrees = mils)}$$

Yield Estimation:

$$\text{Yield 1} + \text{yield 2} = \text{sum yield} / 2 = \text{average yield}$$

Time of Arrival of Fallout:

$$\frac{\text{distance from GZ (km)}}{\text{effective wind speed in (kph)}} = \text{time of arrival}$$

Detailed Fallout Prediction:

$$\text{Effective Wind Speed} = \frac{\text{Radial Line Distance From GZ to CB Height (KM)}}{\text{Time of Fall from CB (HR)}}$$

Time of Completion of Fallout:

$$T_{comp} = 1.25 \times T_{arrival} + \frac{2 \times \text{Cloud radius}}{\text{Effective wind speed}}$$

Measuring Nuclear Data:

$$\text{Transmission Factor (TF)} = \frac{\text{Inside dose rate}}{\text{Outside dose rate}}$$

Outside Dose Rate: $OD = ID/TF$

Correlation Factor: $(CF) = \frac{1}{TF} = \frac{OD}{ID}$

Air-Ground Correlation Factor (AGCF) = $\frac{\text{Ground dose rate}}{\text{Aerial dose rate}}$

Ground dose rate = Air dose rate x AGCF

Calculation of H Hour or TOB:

$$T_1 = \frac{T_b - T_a}{(R_a/R_b)^{1/n-1}}$$

Decay of Fallout:

$$R_1 \times t_1^n = R_2 \times t_2^n$$

Decay Rate

$$n = \frac{\log(R_a/R_b)}{\log(T_b/T_a)}$$

Period of Validity for the Decay Rate (n):

$$T_p = 3(T_b - T_a) + T_b$$

Normalizing Factor (NF)

$$R_1 = NF \times R_2$$

$$NF = (T_2)^n$$

Overall Correction Factor (OCF):

$$NF \times AGCF = OCF \text{ or } NF \times VCF = OCF.$$

Plotting Data and Producing a NBC5 NUC Report

$$\text{Interval Distance} = \frac{\text{Route or Course Leg Distance (km)}}{\text{Number of Readings}-1}$$

Dose Rate for an Arbitrary Time (Kaufmann equation can be used as follows)

$$R_1 \times t_1^n = R_2 \times t_2^n \text{ (can be mathematically changed to represent the missing (or objective) variable to read: } R_2 = R_1 / (t_2)^n \text{ or } R_2 = R_1 / NF)$$

Time at Which a Given Dose Rate is to be Expected (Kaufmann equation can be used as follows)

$$R_1 \times t_1^n = R_2 \times t_2^n \text{ (can be mathematically changed to represent the missing (or objective) variable to read: } t_2 = R_1 \times t_1 / R_2)$$

NOTE: If R_1 is the normalized dose rate reading at H+1, then t_1 will always be 1. Therefore, the equation can be set up as: $t_2 = R_1 / R_2$. This equation can only be utilized per the validity time for the decay rate.

Total Dose Procedures:

$$D = R_{Te} \times T_s \text{ (can be mathematically changed to represent the missing (or objective) variable to read: } R_{Te} = \frac{R_l}{(T_e)^n}$$

$$D = \frac{R_l}{(T_e)^n} \times T_s$$

Crossing a Fallout Area:

$$R_{avg} = \frac{R_{max}}{2}$$

Optimum Time of Exit from Fallout Areas:

$$T_{opt} = MF \times T_{ev}$$

$$TF_{Ratio} = T_{FS} / T_{FM}$$

Neutron-Induced Radiation Areas:

Crossing an Induced-Radiation Area:

$$R_{avg} = \frac{R_{max}}{2}$$

$$T_s = \frac{distance}{speed}$$

$$ID = OD \times TF$$

Decay Rate for Induced Radiation:

$$\frac{1}{t} \times \left[\frac{R_a}{R_a + 1} \right]$$

Dose Rate for an Arbitrary Time:

$$R_1 + t = R_a * \text{EXP}(-n * t)$$

Dose Accumulated in a Neutron-Induced Area:

$$D = R_1/n * (\text{EXP}(-n * t_{in}) - \text{EXP}(-n * t_{out}))$$

Time of Exit from a Neutron-Induced Area Given a Maximum Dosage:

$$T_{out} = -1/n * \ln(\text{EXP}(-n * T_e) - (n * DL) / R_1)$$

Earliest Time of Entry:

$$T_e = -1/n * (DL / (R * n * (1 - \exp(-n * T_s))))$$

Appendix L

REPRODUCIBLE EXAMPLE FORMS

This appendix contains the following reproducible forms:

Nuclear Data Sheet—Monitoring or Point Technique
Nuclear Data Sheet—Route or Course Leg Technique
Chemical/Biological or ROTA Data Sheet—Monitoring or Survey
EDM Work Sheet
Nuclear Fallout Prediction Work Sheet—Surface Burst
Unit Radiation Dose Record
CBRN/TIM/ROTA Sample Documentation
NBC1 Observer's Initial or Follow-Up Report
NBC2 Evaluated Data Report
NBC3 Immediate Warning of Predicted Contamination and Hazard Areas
NBC4 Reconnaissance/Sampling/Monitor/Survey Results
NBC5 Actual Contamination Area Report
NBC6 Detailed Information of CBRN/TIM/ROTA Attack/Incident
Biological Integrated Detection System (BIDS) Incident Report (BIR)

| CHEMICAL / BIOLOGICAL or ROTA * DATA SHEET- MONITORING OR SURVEY <small>* ROTA in this case encompasses TIC/TIB.</small> | | DATE | PAGE NO. | NO. OF PAGES | |
|--|---|---|----------|--------------|-------------------|
| UNIT DESIGNATION | | MONITOR OR SURVEY TEAM MEMBER (Print Name) | | | |
| MAP USED | | MONITOR OR SURVEY TEAM NUMBER | | | |
| LOCATION / TIME OF TEST OR INDICATION | TYPE OF DETECTOR USED (SPECIFY WHICH TYPE) | | | | AGENT DETECTED |
| | PAPER | ALARM | KIT | OTHER | |
| | | | | | |
| | | | | | |
| | | | | | |
| | | | | | |
| | | | | | |
| | | | | | |
| | | | | | |
| | | | | | |
| | | | | | |
| | | | | | |
| | | | | | |
| | | | | | |
| | | | | | |
| REMARKS | | | | | |

SAMPLE

| EFFECTIVE DOWNWIND MESSAGE WORKSHEET | | | | | | | | | | |
|---|------------|---------------------------|------------------------------|--------------------------|--------------------------------------|--|--|--|--|--------------------|
| For use of this form, see FM 3-11.3; the proponent agency is TRADOC | | | | | | | | | | |
| TIME OF WIND MEASUREMENT (DATE-TIME GROUP) <u>DD DDDD</u> | | | | | | | | | | |
| MESSAGE LINE | YIELD (KT) | CLOUD-TOP HEIGHT (METERS) | CLOUD-BOTTOM HEIGHT (METERS) | 2/3 STEM HEIGHT (METERS) | ① DISTANCE OF GZ/CB RADIAL LINE (KM) | ① WIND SPEED-sss (KMPH) ① x 1 = sss TIME OF FALL ROUND OFF TO NEAREST KILOMETER PER HOUR | ② AZIMUTH OF GZ/CT RADIAL LINE (DEGREES) | ③ AZIMUTH OF GZ/2/3 STEM RADIAL LINE (DEGREES) | EFFECTIVE DOWNWIND DIRECTION-ddd (DEGREES) SUM OF | WARNING AREA ANGLE |
| A | 2 | 4,900 | 2,600 | 1,700 | | X 1.136 = | | | ② + ③ = ② AND ③ = $\frac{ddd^t}{2}$ | |
| B | 5 | 7,100 | 4,400 | 2,800 | | X 0.758 = | | | = 2 = | |
| C | 30 | 11,600 | 7,700 | 5,100 | | X 0.455 = | | | = 2 = | |
| D | 100 | 14,400 | 9,300 | 6,200 | | X 0.385 = | | | = 2 = | |
| E | 300 | 16,700 | 11,000 | 7,400 | | X 0.333 = | | | = 2 = | |
| F | 1,000 | 21,600 | 13,500 | 9,000 | | X 0.286 = | | | = 2 = | |
| G | 3,000 | 26,250 | 15,800 | 10,500 | | X 0.250 = | | | = 2 = | |

| | |
|-----------------------------------|--------|
| EFFECTIVE DOWNWIND MESSAGE | |
| ZULU | DDtttt |
| ALFA | ddssss |
| BRAVO | ddssss |
| CHARLIE | ddssss |
| DELTA | ddssss |
| ECHO | ddssss |
| FOXTROT | ddssss |
| GOLF | ddssss |

When the azimuth of the ground zero/cloud-top radial line ② or the azimuth of the ground zero/2/3 stem radial line ③ falls in the first quadrant (0° to 90°) and the other falls in the fourth quadrant (270° to 360°), result of ②+③ will be the back azimuth of the effective downwind direction. In this case, determine ddd by the following method: If result is greater than 180°, subtract 180°; if result is less than 180°, add 180°. Enter in the effective downwind message.

DA FORM 1971-3-R, SEP 94 EDITION OF SEP 94 IS OBSOLETE AFD V2.00

NUCLEAR FALLOUT PREDICTION WORK SHEET – SURFACE BURST

NOTE: Complete Work Sheet to determine NBC3 NUC Report. (Line out unused unit of measure in far right hand column.)

| | | | |
|----|---|-------|---|
| A. | Time of burst (DTG) (From NBC2 NUC Report) | _____ | DELTA (DD TTTTZ MMM YYYY) (local or Zulu time) |
| B. | GZ Coordinates (from NBC2 NUC Report) | _____ | FOXTROT (yy zzzzzz) (Actual or Estimated) |
| C. | FY/TY Ratio (from target analysis for friendly weapons only) (If known, enter #, If unknown or For enemy attack, enter "1"). | _____ | |
| D. | HOB (from target analysis for friendly weapons only) (If known, enter #, If unknown or For enemy attack, enter "0"). | _____ | Meters |
| E. | Yield (from NBC2 NUC Report) | _____ | KT or MT |
| F. | Cloud Top Height (Use Figure J-3 on page J-11.) | _____ | 10 ³ meters or feet |
| G. | Cloud Bottom Height (Use Figure J-3 on page J-11.) | _____ | 10 ³ meters or feet |
| H. | 2/3 Stem (Use Figure J-3 on page J-11.) | _____ | 10 ³ meters or feet |
| I. | Stabilized Cloud Radius (Use Figure J-3 on page J-11.) | _____ | PAPA BRAVO – rr (km) |
| J. | Time of Fall from Cloud Bottom (Use Fig. J-3 on p. J-11.) | _____ | Hours |

NOTE: Plot F, G, and H on the current wind vector plot. Measure the distance from GZ to the cloud bottom height.

| | | | |
|----|---|-------|---------------------------|
| K. | Radial Line Distance from GZ to Cloud Bottom Height | _____ | KM |
| L. | Effective Wind Speed $\frac{K}{J} = \text{_____} = \text{_____}$ | _____ | PAPA BRAVO – sss (kph) |
| M. | Downwind Distance of ZONE I (Use Fig. J-8 or p. J-15) with E. and L.) | _____ | PAPA BRAVO – xxx (km) |
| N. | Adjustment Calculation of Downwind Distance of ZONE I FY/TY Factor (C.) _____ x HOB (D.) _____ = Use Fig. J- on p. J-. Use Fig. J- / on p. J- / . (If unknown or For enemy attack, enter "1" and "1".) | _____ | |
| O. | Adjustment of Downwind Distance of ZONE I | _____ | PAPA BRAVO – xxx (KM) |

NOTE: Ensure that lateral limit angle (angle between Left and Right Radial Lines) is $\geq 40^\circ$. If not, then, add azimuths; divide sum by 2; add 20° to each azimuth. These are the new radial lines. Ensure that the new azimuths are entered below.

| | | | |
|----|--|-------|--|
| P. | Azimuth of Left Radial Line | _____ | PAPA BRAVO – dddd (mils or degrees) |
| Q. | Azimuth of Right Radial Line | _____ | PAPA BRAVO – cccc (mils or degrees) |
| R. | NBC-3 (NUC) Report | | |
| | ALFA (AAA) | _____ | (Strike Serial Number) |
| | DELTA (DD TTTTZ MMM YYYY) | _____ | (Local or Zulu time) |
| | FOXTROT (yy zzzzzz) | _____ | (Actual or Estimated) |
| | (sss xxx rr) * | _____ | (Azimuths of Radial Lines – |
| | PAPA BRAVO (dddd cccc)** | _____ | Mils or Degrees) |
| | * sss – Effective Wind Speed (KMPH) * xxx – Downwind Distance of ZONE I (KM) | | |
| | * rr – Cloud Radius (KM) | | |
| | **dddd – Left Radial Line **cccc – Right Radial Line | | |

UNIT RADIATION DOSE RECORD

| Unit: | | Date: | | | | | | |
|--|--------------------|--------------|----------------|--------------|-------|-------|-----------------------------|--|
| Element | Previous Exposure | New Exposure | Total Exposure | RES Category | | | | |
| | | | | | | | | |
| | | | | | | | | |
| | | | | | | | | |
| | | | | | | | | |
| | | | | | | | | |
| | | | | | | | | |
| | | | | | | | | |
| | | | | | | | | |
| | | | | | | | | |
| | | | | | | | | |
| | | | | | | | | |
| | | | | | | | | |
| | | | | | | | | |
| | | | | | | | | |
| | | | | | | | | |
| | | | | | | | | |
| | | | | | | | | |
| | | | | | | | | |
| | | | | | | | | |
| Radiation status category of Unit | Number of Elements | | | | | | Category Total ¹ | Overall RES ² |
| | 2 | 3 | 4 | 5 | 6 | 7 | | |
| | Sum of RES Numbers | | | | | | Radiation Status Categories | |
| RES-0 | 0 | 0-1 | 0-1 | 0-2 | 0-2 | 0-3 | RES - 0 | 0 = (no exposure) |
| RES-1 | 1-2 | 2-4 | 2-5 | 3-7 | 3-8 | 4-10 | RES - 1 | 1 = Greater than 0cGy, but less than or equal to 70cGy |
| RES-2 | 3-4 | 5-7 | 6-9 | 8-12 | 9-14 | 11-17 | RES - 2 | 2 = Greater than 70cGy, but less than or equal 125cGy |
| RES-3 | 5-6 | 8-9 | 10-12 | 13-15 | 15-18 | 18-21 | RES - 3 | 3 = Greater than 125cGy |
| <p>NOTE: For Category Total, see 1 below. For Overall Unit RES, see 2 below.</p> <p>¹ To determine Category Total, add total number of RESs (0,1,2, 3 for each element) "RES Category" column.</p> <p>² To determine Overall RES, Determine total number of elements. Enter the number of elements and continue down that column to locate the category total (Note 1) range, then read the RES category to the left or right.</p> <p>Example: A Unit had five (5) elements with a total RES Category of 11. Enter "5" as the number of elements. Using this column, locate "11". "11" is between the range of "8-12"; read left or right: Overall RES would be RES-2.</p> | | | | | | | | |

| CBRN / TIM SAMPLE DOCUMENTATION DATA SHEET | | | DATE | | | | PAGE NO. | | NO. OF PAGES | |
|--|--|----------|--------------------------|-----------|------|-------|----------|----------------------------------|-------------------------|-------------------------|
| UNIT DESIGNATION | TEAM NUMBER | | TEAM MEMBER (Print Name) | | | | MAP USED | | | |
| | AN/VDR-2 | M8 Paper | M256A1 | M88 ACADA | TCAM | JBPDS | OTHER | ** AGENT DETECTED (or Dose Rate) | ***AGENT IDENTIFICATION | **** SAMPLE DESCRIPTION |
| LOCATION | *TIME OF DETECTOR ALERT (SPECIFY WHICH TYPE) | | | | | | | | | |
| | | | | | | | | **** Sample ID #: | | |
| | | | | | | | | **** Sample ID #: | | |
| | | | | | | | | **** Sample ID #: | | |
| | | | | | | | | **** Sample ID #: | | |
| | | | | | | | | **** Sample ID #: | | |
| | | | | | | | | **** Sample ID #: | | |
| | | | | | | | | **** Sample ID #: | | |
| | | | | | | | | **** Sample ID #: | | |
| | | | | | | | | **** Sample ID #: | | |
| | | | | | | | | **** Sample ID #: | | |

SAMPLE

| | | | |
|--|---|--|--|
| <p>NOTES:</p> <p>* Enter time of test or indication under appropriate piece of detection equipment.</p> <p>** If BIO, determine detection by: -Type of Agent Detected: (T / C / S / B / N)</p> <p>-Confidence Level: (0 / 1 / 2 / 3 / 4 / 5 / 6 / 7 / 8 / 9 / 10)</p> <p>For radiation detection enter Dose Rate (cGy/hr).</p> <p>*** If BIO, determine Identification by: -Agent Code or Negative (N).</p> <p>**** If sample collected: -Enter Sample ID # -Enter Sample Description (Liquid, Solid, Vapor) (e.g. Solid-vegetation)</p> <p>REMARKS:</p> | <p><u>Route / Destination:</u></p> | <p><u>MET Data (if applicable):</u></p> <p>Wind Speed (MPH):</p> | <p><u>Correlation Factor Data</u></p> <p>Inside Dose Rate:</p> |
| | <p>Distance (Km):</p> | <p>Wind Direction (DEG):</p> | <p>Outside Dose Rate:</p> |
| | <p>Speed (Km/hr) or Time interval used (Sec/Min):</p> | <p>Temp (C):</p> | <p>Means of Delivery of Agent:</p> |
| | | <p>Humidity (%):</p> | <p>Terrain Description:</p> |
| <p>SAMPLE</p> | | | |

CBRN WARNING AND REPORTING SYSTEM (CBRNWRS)**LINE ITEMS**

| Line: | MEANING: |
|-----------------|---|
| ALFA | Strike Serial Number |
| BRAVO | Location of observer and direction of attack or event |
| CHARLIE | DTG of report or observation and end of event |
| DELTA | DTG of attack or detonation and attack end |
| FOXTROT | Location of attack or event |
| GENTEXT | General text |
| GOLF | Delivery and quantity information |
| HOTEL | Type of nuclear burst |
| INDIA | Release information on biological/chemical agent attacks or ROTA events |
| JULIET | Flash-To-Bang Time in Seconds |
| KILO | Crater description |
| LIMA | Nuclear burst angular cloud width at H+5 minutes |
| MIKE | Stabilised cloud measurement at H+10 minutes |
| MIKER | Description and status of a ROTA event |
| NOVEMBER | Estimated nuclear yield in kilotons |
| OSCAR | Reference DTG for estimated contour lines |
| PAPAA | Predicted attack/release and hazard area |
| PAPAB | Detailed fallout hazard prediction parameters |
| PAPAC | Radar determined external contour of radioactive cloud |
| PAPAD | Radar determined downwind direction of radioactive cloud |
| PAPAX | Hazard area location for weather period |
| QUEBEC | Location of reading/sample/detection and type of sample/detection |
| ROMEO | Level of contamination, dose rate trend & decay rate trend |
| SIERRA | DTG of reading or initial detection of contamination |
| TANGO | Terrain/topography and vegetation description |
| WHISKEY | Sensor information |
| XRAYA | Actual contour information |
| XRAYB | Predicted contour information |
| YANKEE | Downwind direction and downwind speed |
| ZULU | Actual weather conditions |

NBC1 REPORT TEMPLATES

| NBC1 NUC Report | | | |
|-----------------|--|---------------------------------------|----------|
| From: | | To: | |
| Precedence: | | Security Classification: | |
| DTG Sent: | | Category of Report: Initial Follow-up | |
| Line Item | Description | Cond | Template |
| ALFA | Strike Serial Number | O | |
| BRAVO | Location of Observer and Direction of Attack or Event | M | |
| DELTA | DTG of Attack or Detonation and Attack End | M | |
| FOXTROT | Location of Attack or Event | O | |
| GOLF | Delivery and Quantity Information | M | |
| HOTEL | Type of Nuclear Burst | M | |
| JULIET | Flash-to-Bang Time in seconds | O | |
| LIMA | Nuclear Burst Angular Cloud Width at H+5 Minutes | O | |
| MIKE | Stabilized Cloud Measurement at H+10 Minutes | O | |
| PAPAC | Radar Determined External Contour of Radioactive Cloud | O | |
| PAPAD | Radar Determined Downwind Direction of Radioactive Cloud | O | |
| YANKEE | Downwind Direction and Downwind Speed | O | |
| ZULU | Actual Weather Conditions | O | |
| GENTEXT | General Text | O | |

*The "Cond" column in the examples shows that each line item is operationally determined (O) or mandatory (M).

| NBC1 CHEM/BIO Report | | | |
|----------------------|---|---------------------------------------|----------|
| From: | | To: | |
| Precedence: | | Security Classification: | |
| DTG Sent: | | Category of Report: Initial Follow-up | |
| Line Item | Description | Cond | Template |
| ALFA | Strike Serial Number | C | |
| BRAVO | Location of Observer and Direction of Attack or Event | M | |
| DELTA | DTG of Attack or Detonation and Attack End | M | |
| FOXTROT | Location of Attack or Event | O | |
| GOLF | Delivery and Quantity Information | M | |
| INDIA | Release Information on Biological/Chemical Agent Attacks or ROTA events | M | |
| TANGO | Terrain/Topography and Vegetation Description | M | |
| YANKEE | Downwind Direction and Downwind Speed | O | |
| ZULU | Actual Weather Conditions | O | |
| GENTEXT | General Text | O | |

* The "Cond" column in the examples shows that each line item is operationally determined (O) or mandatory (M).

| NBC1 ROTA Report | | | |
|------------------|---|---------------------------------------|----------|
| From: | | To: | |
| Precedence: | | Security Classification: | |
| DTG Sent: | | Category of Report: Initial Follow-up | |
| Line Item | Description | Cond | Template |
| ALFA | Strike Serial Number | O | |
| BRAVO | Location of Observer and Direction of Attack or Event | M | |
| CHARLIE | DTG of Report or Observation and End of Event | M | |
| FOXTROT | Location of Attack or Event | O | |
| GOLF | Delivery and Quantity Information | M | |
| INDIA | Release Information on Biological/Chemical Agent Attacks or ROTA events | M | |
| MIKER | Description and Status | O | |
| TANGO | Terrain/Topography and Vegetation Description | M | |
| YANKEE | Downwind Direction and Downwind Speed | O | |
| ZULU | Actual Weather Conditions | O | |
| GENTEXT | General Text | O | |

*The "Cond" column in the examples shows that each line item is operationally determined (O) or mandatory (M).

NBC2 REPORT TEMPLATES

| NBC2 NUC Report | | | |
|-----------------|--|---------------------------------------|----------|
| From: | | To: | |
| Precedence: | | Security Classification: | |
| DTG Sent: | | Category of Report: Initial Follow-up | |
| Line Item | Description | Cond | Template |
| ALFA | Strike Serial Number | M | |
| DELTA | DTG of Attack or Detonation and Attack End | M | |
| FOXTROT | Location of Attack or Event | M | |
| GOLF | Delivery and Quantity Information | M | |
| HOTEL | Type of Nuclear Burst | M | |
| NOVEMBER | Estimated Nuclear Yield in KT | M | |
| YANKEE | Downwind Direction and Downwind Speed | O | |
| ZULU | Actual Weather Conditions | O | |
| GENTEXT | General Text | O | |

*The "Cond" column in the examples shows that each line item is operationally determined (O) or mandatory (M).

| NBC2 CHEM/BIO Report | | | |
|----------------------|---|---------------------------------------|----------|
| From: | | To: | |
| Precedence: | | Security Classification: | |
| DTG Sent: | | Category of Report: Initial Follow-up | |
| Line Item | Description | Cond | Template |
| ALFA | Strike Serial Number | M | |
| DELTA | DTG of Attack or Detonation and Attack End | M | |
| FOXTROT | Location of Attack or Event | M | |
| GOLF | Delivery and Quantity Information | M | |
| INDIA | Release Information on Biological/Chemical Agent Attacks or ROTA events | M | |
| TANGO | Terrain/Topography and Vegetation Description | M | |
| YANKEE | Downwind Direction and Downwind Speed | O | |
| ZULU | Actual Weather Conditions | O | |
| GENTEXT | General Text | O | |

* The "Cond." column in the examples shows that each line item is operationally determined (O) or mandatory (M).

| NBC2 ROTA Report | | | |
|------------------|---|---------------------------------------|----------|
| From: | | To: | |
| Precedence: | | Security Classification: | |
| DTG Sent: | | Category of Report: Initial Follow-up | |
| Line Item | Description | Cond | Template |
| ALFA | Strike Serial Number | M | |
| CHARLIE | DTG of Report /Observation and Event End | M | |
| FOXTROT | Location of Attack or Event | M | |
| GOLF | Delivery and Quantity Information | M | |
| INDIA | Release Information on Biological/Chemical Agent Attacks or ROTA events | M | |
| MIKER | Description and Status | M | |
| TANGO | Terrain/Topography and Vegetation Description | M | |
| YANKEE | Downwind Direction and Downwind Speed | O | |
| ZULU | Actual Weather Conditions | O | |
| GENTEXT | General Text | O | |

* The "Cond" column in the examples shows that each line item is operationally determined (O) or mandatory (M).

NBC3 REPORT TEMPLATES

| NBC3 NUC Report | | | |
|-----------------|--|---------------------------------------|----------|
| From: | | To: | |
| Precedence: | | Security Classification: | |
| DTG Sent: | | Category of Report: Initial Follow-up | |
| Line Item | Description | Cond | Template |
| ALFA | Strike Serial Number | M | |
| DELTA | DTG of Attack or Detonation and Attack End | M | |
| FOXTROT | Location of Attack or Event | M | |
| GOLF | Delivery and Quantity Information | O | |
| HOTEL | Type of Nuclear Burst | O | |
| NOVEMBER | Estimated Nuclear Yield in KT | O | |
| PAPAB | Detailed Fallout Hazard Prediction Parameters | M | |
| PAPAC | Radar Determined External Contour of Radioactive Cloud | O | |
| PAPAD | Radar Determined Downwind Direction of Radioactive Cloud | O | |
| XRAYB** | Predicted Contour Information | C | |
| YANKEE | Downwind Direction and Downwind Speed | O | |
| ZULU | Actual Weather Conditions | O | |
| GENTEXT | General Text | O | |

** Line Item is repeatable up to 50 times to represent multiple contours
The "Cond" column in the examples shows that each set is operationally determined (O), conditional (C) or mandatory (M)

| NBC3 CHEM/BIO Report | | | |
|----------------------|---|---------------------------------------|----------|
| From: | | To: | |
| Precedence: | | Security Classification: | |
| DTG Sent: | | Category of Report: Initial Follow-up | |
| Line Item | Description | Cond | Template |
| ALFA | Strike Serial Number | M | |
| DELTA | DTG of Attack or Detonation and Attack End | M | |
| FOXTROT | Location of Attack or Event | M | |
| GOLF | Delivery and Quantity Information | O | |
| INDIA | Release Information on Biological/Chemical Agent Attacks or ROTA events | M | |
| PAPAA | Predicted Attack/Release and Hazard Area | M | |
| PAPAX* | Hazard Area Location for Weather Period | M | |
| XRAYB** | Predicted Contour Information | C | |
| YANKEE | Downwind Direction and Downwind Speed | O | |
| ZULU | Actual Weather Conditions | O | |
| GENTEXT | General Text | O | |

* Line item is repeatable up to 3 times in order to describe three possible hazard areas corresponding to the time periods from the CDM. A hazard area for a following time period will always include the previous hazard area.

** Line item is repeatable up to 50 times to represent multiple contours. The "Cond" column in the examples shows that each set is operationally determined (O), conditional (C) or mandatory (M).

| NBC3 ROTA Report | | | |
|------------------|---|---------------------------------------|----------|
| From: | | To: | |
| Precedence: | | Security Classification: | |
| DTG Sent: | | Category of Report: Initial Follow-up | |
| Line Item | Description | Cond | Template |
| ALFA | Strike Serial Number | M | |
| CHARLIE | DTG of Report /Observation and Event End | M | |
| FOXTROT | Location of Attack or Event | M | |
| GOLF | Delivery and Quantity Information | O | |
| INDIA | Release Information on Biological/Chemical Agent Attacks or ROTA events | M | |
| PAPAA | Predicted Attack/Release and Hazard Area | M | |
| PAPAX* | Hazard Area Location for Weather Period | M | |
| XRAYB** | Predicted Contour Information | C | |
| YANKEE | Downwind Direction and Downwind Speed | O | |
| ZULU | Actual Weather Conditions | O | |
| GENTEXT | General Text | O | |

* Line item is repeatable up to 3 times in order to describe three possible hazard areas corresponding to the time periods from the CDM. A hazard area for a following time period will always include the previous hazard area.

** Line item is repeatable up to 50 times to represent multiple contours
The "Cond" column in the examples shows that each set is operationally determined (O), conditional (C), or mandatory (M).

NBC4 REPORT TEMPLATES

| NBC4 NUC Report | | | |
|-----------------|---|---------------------------------------|----------|
| From: | | To: | |
| Precedence: | | Security Classification: | |
| DTG Sent: | | Category of Report: Initial Follow-up | |
| Line Item | Description | Cond | Template |
| ALFA | Strike Serial Number | O | |
| KILO | Crater Description | O | |
| QUEBEC* | Location of Reading/Sample/Detection and Type of Sample/Detection | M | |
| ROMEO* | Level of Contamination, Dose Rate Trend and Decay Rate Trend | M | |
| SIERRA* | DTG of Reading or Initial Detection of Contamination | M | |
| WHISKEY | Sensor Information | O | |
| YANKEE* | Downwind Direction and Downwind Speed | M | |
| ZULU* | Actual Weather Conditions | O | |
| GENTEXT | General Text | O | |

* The "Cond" column in the examples shows that each line item is operationally determined (O) or mandatory (M).

* Line items QUEBEC, ROMEO, SIERRA and TANGO are a segment. With exclusion of line item ROMEO, this segment is mandatory. Line items/segments are repeatable up to 20 times in order to describe multiple detection, monitoring, or survey points.

| NBC4 CHEM/BIO Report | | | |
|----------------------|---|---------------------------------------|----------|
| From: | | To: | |
| Precedence: | | Security Classification: | |
| DTG Sent: | | Category of Report: Initial Follow-up | |
| Line Item | Description | Cond | Template |
| ALFA | Strike Serial Number | O | |
| INDIA | Release Information on Biological/Chemical Agent Attacks or ROTA events | O | |
| QUEBEC* | Location of Reading/Sample/Detection and Type of Sample/Detection | M | |
| ROMEO* | Level of Contamination, Dose Rate Trend and Decay Rate Trend | O | |
| SIERRA* | DTG of Reading or Initial Detection of Contamination | M | |
| TANGO* | Terrain/Topography and Vegetation Description | M | |
| WHISKEY | Sensor Information | O | |
| YANKEE* | Downwind Direction and Downwind Speed | M | |
| ZULU* | Actual Weather Conditions | O | |
| GENTEXT | General Text | O | |

* The "Cond" column in the examples shows that each line item is operationally determined (O) or mandatory (M).

* Line items QUEBEC, ROMEO, SIERRA and TANGO are a segment. With exclusion of line item ROMEO, this segment is mandatory. Line items/segments are repeatable up to 20 times in order to describe multiple detection, monitoring, or survey points.

| NBC4 ROTA Report | | | |
|------------------|---|---------------------------------------|----------|
| From: | | To: | |
| Precedence: | | Security Classification: | |
| DTG Sent: | | Category of Report: Initial Follow-up | |
| Line Item | Description | Cond | Template |
| ALFA | Strike Serial Number | O | |
| INDIA | Release Information on Biological/Chemical Agent Attacks or ROTA events | O | |
| QUEBEC* | Location of Reading/Sample/Detection and Type of Sample/Detection | M | |
| ROMEO* | Level of Contamination, Dose Rate Trend and Decay Rate Trend | O | |
| SIERRA* | DTG of Reading or Initial Detection of Contamination | M | |
| TANGO* | Terrain/Topography and Vegetation Description | M | |
| WHISKEY | Sensor Information | O | |
| YANKEE* | Downwind Direction and Downwind Speed | M | |
| ZULU* | Actual Weather Conditions | O | |
| GENTEXT | General Text | O | |

* The "Cond" column in the examples shows that each line item is operationally determined (O) or, mandatory (M).

* Line items QUEBEC, ROMEO, SIERRA and TANGO are a segment. With exclusion of line item ROMEO, this segment is mandatory. Line items/segments are repeatable up to 20 times in order to describe multiple detection, monitoring, or survey points.

NBC5 REPORT TEMPLATES

| NBC5 NUC Report | | | |
|-----------------|--|---------------------------------------|----------|
| From: | | To: | |
| Precedence: | | Security Classification: | |
| DTG Sent: | | Category of Report: Initial Follow-up | |
| Line Item | Description | Cond | Template |
| ALFA | Strike Serial Number | O | |
| DELTA | DTG of Attack or Detonation and Attack End | O | |
| OSCAR | Reference DTG for Estimated Contour Lines | M | |
| XRAYA* | Actual Contour Information | M | |
| XRAYB* | Predicted Contour Information | O | |
| YANKEE | Downwind Direction and Downwind Speed | O | |
| ZULU | Actual Weather Conditions | O | |
| GENTEXT | General Text | O | |

The "Cond" column in the examples shows that each line item is operationally determined (O) or mandatory (M).

* Sets are repeatable up to 50 times to represent multiple contours.

| NBC5 CHEM/BIO Report | | | |
|----------------------|---|---------------------------------------|----------|
| From: | | To: | |
| Precedence: | | Security Classification: | |
| DTG Sent: | | Category of Report: Initial Follow-up | |
| Line Item | Description | Cond. | Template |
| ALFA | Strike Serial Number | O | |
| DELTA | DTG of Attack or Detonation and Attack End | O | |
| INDIA | Release Information on Biological/Chemical Agent Attacks or ROTA events | M | |
| OSCAR | Reference DTG for Estimated Contour Lines | M | |
| XRAYA* | Actual Contour Information | M | |
| XRAYB* | Predicted Contour Information | O | |
| YANKEE | Downwind Direction and Downwind Speed | O | |
| ZULU | Actual Weather Conditions | O | |
| GENTEXT | General Text | O | |

The "Cond." column in the examples shows that each line item is operationally determined (O) or mandatory (M).

* Sets are repeatable up to 50 times to represent multiple contours

| NBC5 ROTA Report | | | |
|------------------|---|---------------------------------------|----------|
| From: | | To: | |
| Precedence: | | Security Classification: | |
| DTG Sent: | | Category of Report: Initial Follow-up | |
| Line Item | Description | Cond | Template |
| ALFA | Strike Serial Number | O | |
| CHARLIE | DTG of Report/Observation and Event end | O | |
| INDIA | Release Information on Biological/Chemical Agent Attacks or ROTA events | M | |
| OSCAR | Reference DTG for Estimated Contour Lines | M | |
| XRAYA* | Actual Contour Information | M | |
| XRAYB* | Predicted Contour Information | O | |
| YANKEE | Downwind Direction and Downwind Speed | O | |
| ZULU | Actual Weather Conditions | O | |
| GENTEXT | General Text | O | |

The "Cond." column in the examples shows that each line item is operationally determined (O) or mandatory (M).

* Sets are repeatable up to 50 times to represent multiple contours.

NBC6 REPORT TEMPLATES

| NBC6 NUC Report | | | |
|-----------------|--|---------------------------------------|----------|
| From: | | To: | |
| Precedence: | | Security Classification: | |
| DTG Sent: | | Category of Report: Initial Follow-up | |
| Line Item | Description | Cond | Template |
| ALFA | Strike Serial Number | O | |
| DELTA | DTG of Attack or Detonation and Attack End | O | |
| FOXTROT | Location of Attack and Qualifier | O | |
| QUEBEC* | Location & Type Reading /Sample /Detection | O | |
| SIERRA | DTG of Reading | O | |
| GENTEXT | General Text | M | |

* The "Cond" column in the examples shows that each line item is operationally determined (O) or mandatory (M).

* Line Item QUEBEC, is repeatable up to 20 times in order to describe multiple detection, monitoring or survey points.

| NBC6 CHEM/BIO Report | | | |
|----------------------|---|---------------------------------------|----------|
| From: | | To: | |
| Precedence: | | Security Classification: | |
| DTG Sent: | | Category of Report: Initial Follow-up | |
| Line Item | Description | Cond | Template |
| ALFA | Strike Serial Number | O | |
| DELTA | DTG of Attack or Detonation and Attack End | O | |
| FOXTROT | Location of Attack and Qualifier | O | |
| INDIA | Release Information on Biological/Chemical Agent Attacks or ROTA events | O | |
| QUEBEC * | Location & Type Reading /Sample /Detection | O | |
| SIERRA | DTG of Reading | O | |
| GENTEXT | General Text | M | |

* The "Cond." column in the examples shows that each line item is operationally determined (O) or mandatory (M).

* Line Item QUEBEC, is repeatable up to 20 times in order to describe multiple detection, monitoring or survey points.

| NBC6 ROTA Report | | | |
|------------------|---|---------------------------------------|----------|
| From: | | To: | |
| Precedence: | | Security Classification: | |
| DTG Sent: | | Category of Report: Initial Follow-up | |
| Line Item | Description | Cond | Template |
| ALFA | Strike Serial Number | O | |
| CHARLIE | DTG of Report /Observation and Event End | O | |
| FOXTROT | Location of Attack or Event | O | |
| INDIA | Release Information on Biological/Chemical Agent Attacks or ROTA events | O | |
| QUEBEC* | Location & Type Reading /Sample /Detection | O | |
| SIERRA | DTG of Reading | O | |
| GENTEXT | General Text | M | |

- * The "Cond" column in the examples shows that each line item is operationally determined (O) or mandatory (M).
- * Line item QUEBEC is repeatable up to 20 times in order to describe multiple detection, monitoring, or survey points.

BIDS/JSLBNCRS/NBCRV Number: _____

19 Digit Sample Identification Number: _____

1. Detection Time
 - a. DTG
 - b. Background Sample
 - c. Command Directed Sample
2. MET Data
 - a. Elevation
 - b. Direction
 - c. Wind Speed
 - d. Temperature
 - e. Relative Humidity
3. Identification
 - a. DTG
 - b. Agent Code
 - c. Negative
4. Mode of Operation
 - a. Standard
 - b. Single Sample
 - c. Periodic
 - d. Degraded
 - e. Extreme Cold

SAMPLE

Biological Incident Report

THIS PAGE IS INTENTIONALLY LEFT BLANK.

REFERENCES

Department of Defense

DODD 2000.12, *DOD Antiterrorism/Force Protection (AT/FP) Program*, 13 April 1999.

DODI 2000.16, *DOD Antiterrorism Standards*, 14 June 2001.

Joint

JP 1, *Joint Warfare of the Armed Forces of the United States*, 14 November 2000.

JP 1-01, *Joint Publication System: Joint Doctrine and Joint Tactics, Techniques, and Procedures Development Program*, Change 1, 5 July 2000.

JP 1-02, *Department of Defense Dictionary of Military and Associated Terms*, 12 April 2001.

JP 2-01.3, *Joint Tactics, Techniques, and Procedures for Joint Intelligence Preparation of the Battlespace*, Final Coordination, 24 May 2000.

JP 3-0, *Doctrine for Joint Operations*, 10 September 2001.

JP 3-01, *Joint Doctrine for Countering Air and Missile Threats*, 19 October 1999.

JP 3-01.5, *Doctrine for Joint Theater Missile Defense*, 22 February 1996.

JP 3-07, *Joint Doctrine for Military Operations Other Than War*, 16 June 1995.

JP 3-07.2, *Joint Tactics, Techniques, and Procedures for Antiterrorism*, 17 March 1998.

JP 3-10, *Joint Doctrine for Rear Area Operations*, 28 May 1996.

JP 3-10.1, *Joint Tactics, Techniques, and Procedures for Base Defense*, 23 July 1996.

JP 3-11, *Joint Doctrine for Operations in Nuclear, Biological, and Chemical (NBC) Environments*, 11 July 2000.

JP 3-12, *Doctrine for Joint Nuclear Operations*, 15 December 1995.

JP 3-12.1, *Doctrine for Joint Theater Nuclear Operations*, 9 February 1996.

JP 3-12.2, *Nuclear Weapons Employment and Effects Data*, 20 December 1995.

JP 3-12.3, *Nuclear Weapons Employment Effects Data (Notional)*, 14 February 1996.

JP 4-06, *Joint Tactics, Techniques, and Procedures for Mortuary Affairs in Joint Operations*, 28 August 1996.

JP 5-0, *Doctrine for Planning Joint Operations*, 13 April 1995.

JP 5-00.2, *Joint Task Force (JTF) Planning Guidance and Procedures*, 13 January 1999.

JP 5-03.1, *Joint Operation Planning and Execution System Volume I: (Planning Policies and Procedures)*, 9 August 1993.

JP 5.03.2, *Joint Operation Planning and Execution System (JOPES), Volume II*, 10 March 1992 (U).

Multiservice

- FM 3-11.5/MCWP 3-37.3/NWP 3-11.26/AFTTP(I) 3-2.60, *Multiservice Tactics, Techniques, and Procedures for Chemical, Biological, Radiological, and Nuclear Decontamination*, to be published within 6 months.
- FM 3-6/AFM 105-7/FMFM 7-11-H, *Field Behavior of NBC Agents (Including Smoke and Incendiaries)*, 3 November 1986.
- FM 3-11/MCWP 3-37.1/NWP 3-11/AFTTP(I) 3-2.42, *Multiservice Tactics, Techniques, and Procedures for Nuclear, Biological, and Chemical Defense Operations*, 10 March 2003.
- FM 3-11.4/MCWP 3-37.2/NTTP 3-11.27/AFTTP(I) 3-2.46, *Multiservice Tactics, Techniques, and Procedures for Nuclear, Biological, and Chemical (NBC) Protection*, 2 June 2003.
- FM 3-11.9/MCRP 3-37.1A/NTTP 3-11.28/AFTTP(I) 3-2.54, *Multiservice Tactics, Techniques, and Procedures for Nuclear, Biological, and Chemical Vulnerability Assessment*, 28 December 2004.
- FM 3-11.14/MCRP 3-37.1B/NTRP 3-11.32/AFTTP(I) 3-2.55, *Potential Military Chemical/Biological Agents and Compounds*, 10 January 2005.
- FM 3-11.19/MCWP 3-37.4/NTTP 3-11.29/AFTTP(I) 3-2.44, *Multiservice Tactics, Techniques, and Procedures for Nuclear, Biological, and Chemical Reconnaissance*, 30 July 2004.
- FM 3-11.34/MCWP 3-37.5/NTTP 3-11.23/AFTTP(I) 3-2.33, *Multi-Service Procedures for Nuclear, Biological, and Chemical Defense of Theater Fixed Sites, Ports and Airfields*, 29 September 2000.
- FM 3-11.86/MCRP 3-37.1C/NTTP 3-11.31/AFTTP(I) 3-2.52, *Multi-Service Tactics, Techniques, and Procedures for Biological Surveillance*, 04 October 2004.
- FM 4-02.283/NTRP 4-02.21/AFMAN 44-161(I)/MCRP 4-11.1B, *Treatment of Nuclear and Radiological Casualties*, 20 December 2001.
- FM 4-25.11/NTRP 4-02.1.1/AFMAN 44-163(I)/MCRP 3-02G, *First Aid*, 23 December 2002.
- FM 8-9/NAVMED P-5059/AFJMAN 44-151(V1,V2,V3), *NATO Handbook on the Medical Aspects of NBC Defensive Operations AMEDP-6(B) (Part I-Nuclear, Part II-Biological, Part III- Chemical)*, 1 February 1996.
- FM 8-284/NAVMED P-5042/AFMAN(I) 44-156/MCRP 4-11.1C, *Treatment of Biological Warfare Agent Casualties*, 17 July 2000.
- FM 8-285/NAVMED P-5041/AFJMAN 44-149/FMFM 11-11, *Treatment of Chemical Agent Casualties and Conventional Military Chemical Injuries*, 22 December 1995.

Army

- DA Form 12-99-R, *Initial Distribution Requirements for Publications*, April 1996.
- DA Form 1971-3-R, *Effective Downwind Message Worksheet*, September 1994.
- FM 3-0, *Operations*, 14 June 2001.
- FM 3-7, *NBC Field Handbook*, 29 September 1994.
- FM 3-13, *Information Operations: Doctrine, Tactics, Techniques, and Procedures*, 28 November 2003.

FM 3-90, *Tactics*, 4 July 2001.

FM 3-101, *Chemical Staffs and Units*, 19 November 1993.

FM 4-02, *Force Health Protection in a Global Environment*, 13 February 2003.

FM 4-02.7, *Health Service Support in a Nuclear, Biological, and Chemical Environment*, 1 October 2002.

FM 4-02.33, *Control of Communicable Diseases Manual (18th Edition)*, 1 June 2005.

FM 21-10, *Field Hygiene and Sanitation*, 21 June 2000.

FM 34-130, *Intelligence Preparation of the Battlefield*, 8 July 1994.

FM 100-7, *DECISIVE FORCE: The Army in Theater Operations*, 31 May 1995.

FM 101-5, *Staff Organization and Operations*, 31 May 1997.

TM 11-6665-251-10, *Operator's Manual for Radiac Set AN/VDR-2*, 1 March 1988.

USAMRIID, *Medical Management of Biological Casualties Handbook*, February 2001.

Air Force

AFDD-1, *Air Force Basic Doctrine*, September 1997.

AFDD-2-1.8, *Counter Nuclear, Biological, and Chemical (NBC) Operations*, 16 August 2000.

AFH 32-4001, USAF, *Ability to Survive and Operate Procedures in a Nuclear, Biological, and Chemical Environment, Volume 4*, 1 March 1998.

AFH 32-4004, *Emergency Response Operations*, 1 December 1995.

AFH 32-4014, *USAF Operations in a Chemical and Biological (CB) Warfare Environment, Planning and Analysis, Volume 1*, 1 March 1998.

AFH 32-4014, *USAF Operations in a Chemical and Biological Warfare Environment, CB Hazards, Volume 2*, 1 December 1997.

AFH 32-4014, *USAF Operations in a Chemical and Biological (CB) Warfare Environment, Defense Equipment, Volume 3*, 1 February 1998.

AFH 32-4014, *USAF Ability to Survive and Operate Procedures in a Nuclear, Biological, and Chemical (NBC) Environment, Volume 4*, 1 March 1998.

AFI 32-4001, *Disaster Preparedness Planning and Operations*, 28 August 2002.

AFI 32-4004, *Emergency Response Operations*, 1 December 1995.

AFMAN 10-2602, *Nuclear, Biological, Chemical, and Conventional (NBCC) Defense Operations and Standards*, 29 May 2003.

AFMAN 32-4005, *Personnel Protection and Attack Actions*, 30 October 2001.

AFMAN 32-4017, *Civil Engineer Readiness Technician's Manual for Nuclear, Biological, and Chemical Defense*, 29 May 2003.

AFPAM 32-4019, *Chemical-Biological Warfare Commander's Guide*, 1 April 1998.

AFPD 10-26, *Counter-Nuclear, Biological, and Chemical Operational Preparedness*, 6 February 2001.

AFPD 32-40, *Disaster Preparedness*, 7 May 1997.

US Air Force Engineering Support Activity, *Chemical and Biological Defense Concept of Operations*, January 1998.

US Air Force Institute for National Security Studies, *Countering the Proliferation and Use of Weapons of Mass Destruction*, 1998.

Marine Corps

MCWP 3-37, *Marine Air-Ground Task Force (MAGTF) Nuclear, Biological, and Chemical Defensive Operations*, September 1998.

MCWP 3-40.2, *Information Management*, January 2002.

Navy

Naval Doctrine Command, *US Navy, Executive Summary, Multinational Maritime Operations*, 1996.

Naval Doctrine Publication 1, *Naval Warfare*, Washington, DC: Department of the Navy, 28 March 1994.

Naval Doctrine Publication 2, *Naval Intelligence*, Washington, DC: Department of the Navy, 30 September 1994.

Naval Doctrine Publication 4, *Naval Logistics*, Washington, DC: Department of the Navy, 20 February 2000.

Navy Warfare Publication 3-20.31, *Ship Survivability*, January 2000.

Trainee Guide, Disaster Preparedness Operations Specialist, US Navy Detachment, Fort Leonard Wood, MO, June 1998.

NATO Standardization Agreements (STANAG) and Publications

STANAG 2002, *Warning Signs for the Marking of Contaminated or Dangerous Land Areas, Complete Equipment, Supplies, and Stores*, 29 January 1999.

STANAG 2047(Ed 6), *Emergency Alarms of Hazard or Attack (NBC or Air Attack Only)*, 27 March 1985.

STANAG 2083 (Ed 5), *Commander's Guide on Nuclear Radiation Exposure of Groups*, 24 June 1994.

STANAG 2103, *Reporting Nuclear Detonations, Biological and Chemical Attacks, and Predicting the Warning of Associated Hazards and Hazard Areas (Allied Tactical Publication (ATP)45(B)*, 1 July 2001.

STANAG 2112, *NBC Reconnaissance*, 6 March 1998.

STANAG 2133(SD6), *Vulnerability Analysis of Chemical and Biological Hazards*, October 2000.

STANAG 2353, *Evaluation of NBC Defense Capability*, 24 March 2000.

STANAG 2473(Ed. 1), *Commander's Guide on Low Level Radiation (LLR) Exposure in Military Operations*, 03 May 2000.

STANAG 2984(Ed. 5), *Graduated Levels of NBC Threat and Associated Protection*,

21 March 2001.

Other Sources

Allied Engineering Publication (AEP) (10), *Sampling and Identification of CB Agents*, February 2000.

Department of Transportation, *2000 Emergency Response Guidebook, A Guide for First Responders During the Initial Phase of a Dangerous Goods/ Hazardous Materials Incident*.

Emergency Response Guidebook 2004.

Joint Vision 2020, June 2000.

Medical Management of Radiological Casualties Handbook, Second Edition, April 2003.

Presidential Decision Directive (PDD)/National Security Council (NSC) 39, *US Government Policy on Counterterrorism*, 21 June 1995.

THIS PAGE IS INTENTIONALLY LEFT BLANK.

GLOSSARY

PART I—ABBREVIATIONS AND ACRONYMS

A

| | |
|---------------|--|
| ACADA | automatic chemical-agent detection and alarm |
| ACCA | aircrew contamination control area |
| ACPL | agent containing particles per liter |
| ADA | air defense artillery |
| admin | administrative |
| ADP | automatic data processing |
| AEP | Allied Engineering publication |
| AFB | Air Force base |
| AFCESA | Air Force Civil Engineer Support Agency |
| AFDD | Air Force doctrine document |
| AFH | Air Force handbook |
| AFI | Air Force instruction |
| AFJMAN | Air Force joint manual |
| AFM | Air Force manual |
| AFMAN | Air Force manual |
| AFPAM | Air Force pamphlet |
| AFPD | Air Force policy directive |
| AFR | Air Force regulation |
| AFRRI | Armed Forces Radiobiology Research Institute |
| AFTTP | Air Force tactics, techniques, and procedures (interservice) |
| AGCF | air-ground correlation factor |
| AIR | aircraft |
| AL | Alabama |
| ALARA | as low as reasonably achievable |
| ALP | Alpha |
| AM | ante meridiem |
| AO | area of operations |
| AOI | area of interest |
| AOR | area of responsibility |
| APC | armored personnel carrier |
| ATP | allied tactical publication |
| ATTN | attention |
| AWS | Air Weather Service |

B

| | |
|-------------|--|
| B | biological attack; top of inversion layer less than 400 meters |
| BAC | bacterial |
| BACK | background |
| BD | buffer distance |
| BDA | battle damage assessment |
| BDM | basic downwind message |

| | |
|-------------------------|--|
| BDRD | Biological Defense Research Directorate |
| BIDS | Biological Integrated Detection System |
| BIO | biological |
| BIR | biological integrated detection system incident report |
| BL | blister agent |
| BLOD | blood agent |
| BM | battle management |
| BML | bomblets |
| BOM | bomb |
| Bq | Becquerel |
| bq/m² | Becquerel per square meter |
| bq/m³ | Becquerel per cubic meter |
| BTL | pressurized gas bottle |
| BUK | bunker |
| BW | biological warfare |
| BWF | basic wind forecast |
| BWM | basic wind message |
| BWR | basic wind report |
| BZ | quinuclidinyl benzilate |
| C | |
| c | centi |
| C | Celsius; chemical attack; conditional; top of inversion layer less than 200 meters |
| C2 | command and control |
| C4I | command, control, communications, computers, and intelligence |
| CA | civil affairs; California |
| CAM | chemical-agent monitor |
| CAM II | Chemical-Agent Monitor Block II (USMC) |
| CAN | cannon |
| CB | chemical-biological; toxic |
| CBRN | chemical, biological, radiological, and nuclear |
| CBRNWRS | Chemical, Biological, Radiological, and Nuclear Warning and Reporting System |
| CCA | contamination control area |
| cccc | right radial |
| CCIR | commander's critical information requirement |
| CDF | chemical downwind forecast |
| CDM | chemical downwind message |
| CDR | chemical downwind report |
| CENTCOM | Central Command |
| CES | cesium |
| CF | correlation factor |
| CFM | cubic feet per minute |
| CFR | Code of Federal Regulations |
| CFU | colony-forming unit(s) |
| CG | commanding general; phosgene (choking agent) |

| | |
|-----------------|--|
| cGy | centigray |
| cGyph | centigray per hour |
| CHEM | chemical |
| CHEMTREC | Chemical Transportation Emergency Center |
| CHOK | choking agent |
| Ci | Curie |
| CI | combat ineffective |
| CJCS | Commander of the Joint Chiefs of Staff |
| CK | cyanogen chloride (blood agent) |
| CLA | chlamydia |
| CLOUD | visible cloud |
| CLS | contracted logistics support |
| cm | centimeter(s) |
| CM | consequence management |
| CMOC | civil-military operations center |
| COA | course of action |
| COB | cobalt |
| COCOM | combatant command (command authority) |
| COG | center of gravity |
| COLPRO | collective protection |
| COMM | communications; commercial |
| COMSEC | communications security |
| CON | generic storage container |
| CONUS | continental United States |
| COP | common operational picture |
| COTS | commercial off-the-shelf |
| CP | collection point |
| CPDS | chemical prediction data sheet |
| CPE | collective protection equipment |
| CRS | chronic radiation syndrome |
| CS | o-chlorobenzylidene malononitrile (a tear agent) |
| CSH | centisievert(s) per hour |
| CSS | combat service support |
| CST | civil support team |
| CSV | centisievert(s) |
| CT | cloud top |
| CW | chemical warfare |
| CX | phosgene oxime |

D

| | |
|---------------|--|
| D | total dose in centigrays |
| DA | Department of the Army; total downwind distance, in kilometers |
| DA PAM | Department of the Army pamphlet |
| DAY | day(s) |
| DD | day |
| ddd | effective downward direction |
| dddd | left radial |

| | |
|---------------|---|
| DE | extended distance, in kilometers, traveled within the third nuclear, biological, and chemical downwind report 2-hour period |
| DECR | decreasing |
| DEG | degree(s) |
| deton | detonation |
| DFU | dry filter unit |
| DGG | degrees/grid north |
| DGM | degrees/magnetic north |
| DGT | degrees/true north |
| DGZ | designated ground zero |
| DHD | downwind hazard distance |
| DHHS | Department of Health and Human Services |
| DKIE | decontaminating kit, individual equipment |
| DL | limiting dose |
| DMS | defense message system |
| DNA EM | Defense Nuclear Agency Effects Manual |
| DOD | Department of Defense |
| DODD | Department of Defense directive |
| DODI | Department of Defense instruction |
| DOT | Department of Transportation |
| DP | di-phosgene |
| DRM | nominal 55-gallon storage drum |
| DSM | decision support matrix |
| DSN | Defense Switched Network |
| DST | decision support tools |
| DT | demanding task |
| DTG | date-time group |
| DTRA | Defense Threat Reduction Center |
| DU | depleted uranium |
| E | |
| ECP | entry control point |
| EDF | effective downwind forecast |
| EDM | effective downwind message |
| EDR | effective downwind report |
| EMP | electromagnetic pulse |
| EMS | emergency medical services |
| EMT | emergency medical technician |
| EOC | emergency operations center |
| EOD | explosive ordnance disposal |
| EPA | Environmental Protection Agency |
| EPW | enemy prisoner of war |
| ERG | Emergency Response Guidebook |
| EWO | electronic warfare officer |
| EWS | effective wind speed |

| | |
|----------------|--|
| F | |
| F | Fahrenheit |
| FBI | Federal Bureau of Investigation |
| FEMA | Federal Emergency Management Agency |
| FF | fresh reactor fuel |
| FFR | for future reference |
| FIDLER | field instrument for detection of low-energy radiation |
| FIRE | burning fire |
| FL | Florida; nuclear weapon fallout |
| FM | field manual |
| FMFM | Fleet Marine Force manual |
| FNMOCC | Fleet Numerical Meteorology and Oceanography Center |
| FP | force protection |
| FPCON | force protection condition |
| FRAGORD | fragmentary order |
| FROG | free rocket over ground |
| FSTR | full-spectrum threat response |
| FSU | former Soviet Union |
| ft | foot; feet |
| FY | fission yield |
| | |
| G | |
| g | gram(s) |
| G | G agent, giga |
| GA | tabun (nerve agent) |
| GAM | Gamma |
| GB | sarin (nerve agent) |
| GCCS | Global Command and Control System |
| GD | soman (nerve agent) |
| GEN | generator (aerosol) |
| GENTEXT | general text |
| GF | cyclosarin (nerve agent) |
| GM | Geiger-Mueller counter |
| GMT | Greenwich mean time |
| GN | grid north |
| GOTS | government off-the-shelf |
| Gy | gray |
| GZ | ground zero |

| | |
|---------------|--|
| H | |
| H | mustard agent |
| ha | hectares |
| HAZMAT | hazardous materials |
| HD | distilled mustard (blister agent) |
| HHA | handheld assay |
| HI | Hawaii |
| HIL | hill |
| HL | mustard (lewisite) |
| hm | hectometer(s) |
| HN | host nation; nitrogen mustard (blister agent) (HN-1, HN-2, HN-3) |
| HOB | height of burst |
| HQ | headquarters |
| HR | hour(s) |
| HSS | health service support |
| HT | mustard-T mixture |
| HVAC | heating, ventilation, and air conditioning |
| HVT | high-value target |
| I | |
| IBADS | Interim Biological Agent Detection System |
| ICAM | improved chemical-agent monitor |
| ICS | incident command system |
| ICTXX | incapacitating dosage xx |
| ID | inside shielded dose rate |
| IDXX | incapacitating dose xx |
| IED | improvised explosive device; initial explosive device |
| IIR | intelligence information report |
| IM | information management |
| INCP | incapacitating agent |
| INCR | increasing |
| INIT | initial |
| INSUM | intelligence summary |
| IO | iodine |
| IPB | intelligence preparation of the battlespace |
| IPDS | improved point detection system |
| IPE | individual protective equipment |
| IR | intelligence requirement |
| IRT | initial response team; irritant |
| ISR | intelligence, surveillance, and reconnaissance |
| IT | Italy |
| J | |
| JBPDS | Joint Biological Point Detection System |
| JF | joint force |

JFC joint force commander
JIPB joint intelligence preparation of the battlespace
JMETL joint mission-essential task list
JOC joint operations center
JP joint publication
JRO joint requirements office
JSLIST joint service lightweight integrated suit technology
JTF joint task force
JULLS Joint Universal Lessons-Learned System
JWARN joint warning and reporting network

K

k kilo
kf kilofeet
kg kilogram(s)
km kilometer(s)
kph kilometers per hour
KT kiloton(s)
kt knots

L

L lewisite (blister agent)
LAT latitude
LCTXX lethal dosage xx
LDXX lethal dose xx
LEAK continuous flow from damaged pipe container
LI latent ineffectiveness
LIQ liquid
LLR low-level radiation
LNO liaison officer
LOAC law of armed conflict
LOC line of communications
LONG longitude
LSD least separation distance

M

m meter(s)
m² square meters
M mandatory; mega
MADCP mortuary affairs decontamination collection point
MANSCEN Maneuver Support Center
MCCDC Marine Corps Combat Development Command
mcg microgram(s)
MCRP Marine Corps reference publication
MCTXX eye-effecting dosage xx (miosis)
MCWP Marine Corps warfighting publication
MD Maryland
MEDSURV medical surveillance

| | |
|-----------------------------|---|
| MERCOMMS | merchant ship communications system |
| MERWARN | Merchant Warning System |
| MET | meteorological |
| METT-T | mission, enemy, terrain and weather, troops and support available—time available |
| METT-TC | mission, enemy, terrain and weather, troops available and support available, time available, and civil considerations |
| MeV | million electron volts |
| MF | multiplication factor |
| mg | milligram(s) |
| mg/L | milligrams per liter |
| mg/m² | milligrams per square meter |
| mg/m³ | milligrams per cubic meter |
| mg-min/m³ | milligrams per minute, cubed |
| mgy | milligray(s) |
| mL | milliliter(s) |
| Mi | micro |
| MIJI | meaconing, intrusion, jamming, or interference |
| MILSTRIP | Military Standard Requisitioning and Issue Procedures |
| min | minute(s) |
| MLG | mils/grid north |
| MLM | mils/magnetic north |
| MLR | multiple launch rocket |
| MLRS | Multiple Launch Rocket System |
| MLT | mils/true north |
| mm | millimeter(s) |
| MMM | month(s) |
| MNE | mine (nuclear, biological, and/or chemical-filled only) |
| MO | Missouri |
| MOA | memorandum of agreement |
| MOB | main operations base |
| mon | month(s) |
| MOOTW | military operations other than war |
| MOPP | mission-oriented protective posture |
| MOR | mortar |
| MOU | memorandum of understanding |
| MPDS | manned point detection system |
| mph | miles per hour |
| mps | miles per second |
| mrad | millirads |
| MSD | minimum safe distance |
| MSDS | manned standoff detection system |
| MSEL | master scenario events list |
| MSH | millisievert(s) per hour |
| MSL | missile |
| mSv | millisievert(s) |
| MSVY | manned survey |
| Mt | megaton(s) |
| MTF | medical treatment facility |

| | |
|----------------------|---|
| MTTP | multiservice tactics, techniques, and procedures |
| N | |
| n | nano; decay rate; number of half-thicknesses contained in the total thickness of shielding material |
| N | nuclear attack; neutral |
| NA | North American; not applicable |
| NAAK | nerve-agent antidote kit |
| NAI | named area of interest |
| NATO | North Atlantic Treaty Organization |
| NAV | Navy |
| NAVFAC | Naval facility |
| NAVMED | Naval Medical Command |
| NAVMEDCOMINST | Navy medical command instruction |
| NBC | nuclear, biological, and chemical |
| NBCC | nuclear, biological, chemical, and conventional |
| NBC-IST | nuclear, biological, and chemical installation support team |
| NBCRS | Nuclear, Biological, and Chemical Reconnaissance System |
| NBCWRS | Nuclear, Biological, and Chemical Warning and Reporting System |
| NCO | noncommissioned officer |
| NCOIC | noncommissioned officer in charge |
| NCS | Naval Control of Shipping |
| NEHC | Navy Environmental Health Center |
| NEO | noncombatant evacuation operation |
| NEPMU | Navy environmental and preventive medicine unit |
| NERV | nerve agent |
| NEU | neutron |
| NF | normalization factor |
| NIGA | neutron-induced gamma activity |
| NIL | no agent detected |
| NLT | not later than |
| NM | nautical mile(s) |
| NMRC | Navy Medical Research Center |
| NOFORN | not releasable to foreign nationals |
| NOP | Naval Oceanography Program |
| NP | nonpersistent |
| NRC | National Response Center |
| NSC | National Security Council |
| NSN | National Stock Number |
| NSTM | Naval Ships technical manual |
| NTTP | Navy tactics, techniques, and procedures |
| NUC | nuclear |
| NVD | night vision device |
| NWDC | Navy Warfare Development Command |
| NWP | Naval warfare publication |

| | |
|----------------|--|
| O | |
| O | operationally determined |
| OCF | overall correlation factor |
| OD | outside unshielded dose rate |
| OEG | operational exposure guide |
| OF | spent reactor fuel |
| OIC | officer in charge |
| OOTW | operations other than war |
| OPCEN | operations center |
| OPCON | operational control |
| OCONUS | outside the continental United States |
| OPLAN | operation plan |
| OPNAV | Office of the Chief of Naval Operations |
| OPORD | operation order |
| OPR | office of primary responsibility |
| OPREP | operational report |
| OPSEC | operations security |
| OPTEMPO | operating tempo |
| OSC | operations support center |
| OTH | other |
| OTR | other agent |
| | |
| P | |
| p | pico |
| P | persistent; peta |
| PA | public address |
| PCR | polymerase chain reaction |
| PD | performance decrement; partially degraded |
| PDD | Presidential decision directive |
| PEAK | peak |
| PENT | penetrating agent |
| PF | protection factor |
| PIR | priority intelligence requirements |
| PLT | plant; platoon |
| PM | post meridiem |
| PMCS | preventive-maintenance checks and services |
| POC | point of contact |
| POL | petroleum, oil, and lubricants |
| POOL | large quantity of still liquid |
| ppb | parts per billion |
| PPE | personal protective equipment |
| ppm | parts per million |
| PS | chloropicrin |
| psi | pounds per square inch |
| PSYOP | psychological operations |
| PU | plutonium |
| PVNTMED | preventive medicine |

| | |
|----------------|--|
| R | |
| R | shielded dose rate |
| R&S | reconnaissance and surveillance |
| Ra | peak reading |
| RAI | radioactive iodine |
| Rb | last reading |
| RB | biological release other than attack |
| RC | chemical release other than attack |
| RCA | riot control agent |
| RCT | reactor |
| RDD | radiological dispersal device |
| RDECOM | Research Development and Engineering Command |
| RES | radiation exposure status |
| RFI | request for information |
| RI | Rhode Island |
| RIC | rickettsiae |
| RKT | rocket |
| RLD | railroad car |
| RM | risk management |
| RN | nuclear release other than attack |
| RNP | release other than attack nuclear power plant |
| Ro | unshielded dose rate |
| ROC | regional operations center |
| ROE | rules of engagement |
| ROTA | release other than attack |
| rr | radius |
| RS | radius of safety |
| RSCAAL | remote-sensing, chemical-agent alarm |
| RU | unidentified release other than attack |
| RV | radius of vulnerability |
| | |
| S | |
| S | stable |
| SA | situational awareness; arsin |
| SALUTE | size, activity, location, unit, time, and equipment |
| SBCCOM | United States Army Soldier and Biological Chemical Command |
| | |
| SCBA | self-contained breathing apparatus |
| SCRUB | scrubby vegetation |
| SEA | sea |
| sec | second(s) |
| SHL | shell |
| SHP | ship |
| SIC | signal indicator code |
| SIP | shelter in place |
| SIPRNET | Secure Internet Protocol Router Network |
| SIR | special information requirement |

| | |
|----------------------|--|
| SITREP | situation report |
| SM | statute mile(s) |
| SMART | special medical augmentation response team |
| SME | subject matter expert |
| SML | less than 200 liters or 200 kilograms |
| SOF | special operations forces |
| SOP | standard operating procedure |
| SPILL | small quantity of still liquid |
| SPR | spray (tank) |
| SRD | secret, restricted data |
| SSM | surface-to-surface missile |
| SSN | strike serial number |
| sss | effective wind speed |
| STANAG | standardization agreement |
| STB | super tropical bleach |
| STK | stockpile |
| STRIKWARN | strike warning |
| STU-III | secure telephone |
| Sv | sievert |
| SWO | staff weather officer |
| SYSCON | systems control |
| T | |
| T | thickened; tera |
| T₁ | time after H hour at which peak reading was made |
| T_a | time of peak reading |
| TA | target acquisition |
| TAP | threat assessment and planning |
| TAM | theater air and missile |
| Tb | time of last reading |
| T comp | time of completion |
| TEL | transporter-erector-launcher |
| TEU | technical escort unit |
| TF | transmission factor |
| TFA | toxic-free area |
| TG | tear gas |
| TGD | thickened soman |
| TIB | toxic industrial biological |
| TIC | toxic industrial chemical |
| TIM | toxic industrial material |
| TIR | toxic industrial radiological |
| TM | technical manual |
| TNK | tank |
| T opt | optimum time of exit |
| TOB | time of burst |
| TOR | torpedo |
| TOX | toxin |
| TP | validity time for decay rate |

| | |
|------------------|--|
| TPFDL | time-phased force and deployment list |
| TPT | transport |
| TRADOC | United States Army Training and Doctrine Command |
| TTP | tactics, techniques, and procedures |
| TTTT | hour(s) |
| TX | Texas |
| TY | total yield |
| U | |
| U | unstable |
| UIC | unit identification code |
| UJTL | Universal Joint Task List |
| UMPDS | unmanned point detection system |
| UMSDS | unmanned standoff detection system |
| UMSVY | unmanned survey |
| UN | United Nations |
| UNK | unknown |
| US | United States |
| USA | United States Army |
| USACHPPM | United States Army Center for Health Promotion and Preventive Medicine |
| USACMLS | United States Army Chemical School |
| USAF | United States Air Force |
| USAMEDCOM | United States Army Medical Command |
| USAMRICD | United States Army Medical Research Institute for Chemical Defense |
| USAMRIID | United States Army Medical Research Institute of Infectious Diseases |
| USCG | United States Coast Guard |
| USG | United States government |
| USMC | United States Marine Corps |
| USMTF | United States message text format |
| USN | United States Navy |
| usv | microsievert(s) |
| UT | undemanding task |
| UTM | universal transverse mercator |
| UV | ultraviolet |
| UXO | unexploded ordnance |
| V | |
| V | V agent |
| VA | Virginia; vulnerability assessment |
| VALLEY | valley |
| VAP | vapor |
| VB | vapor barrier |
| VCF | vehicle correlation factor |
| VEG | vegetation |
| VHA | vapor hazard area |

VIR viral
VMT vomiting agent
VX nerve agent

W

WARNORD warning order
WATER water sample
wk week(s)
WMD weapon of mass destruction
WMD-CST weapon of mass destruction–civil support team
WOODS wooded terrain
WST waste

X
X total thickness of shielding material
X^{1/2} half-thickness
XLG extra large; more than 1,500 liters or kilograms
xxx downwind distance to nearest kilometer

Y
yd yard(s)
yy grid square
YYYY year

Z
zzzzzz coordinates of ground zero

PART II – TERMS AND DEFINITIONS

Aerosol. A liquid or solid composed of finely divided particles suspended in a gaseous medium. Examples of common aerosols are mist, fog, and smoke. (JP 1-02)

Avoidance. Individual and/or unit measures taken to avoid or minimize nuclear, biological, and chemical (NBC) attacks and reduce the effects of NBC hazards. (JP 1-02)

Biological agent. A microorganism that causes disease in personnel, plants, or animals or causes the deterioration of materiel. (JP 1-02)

Biological defense. The methods, plans, and procedures involved in establishing and executing defensive measures against attacks using biological agents. (JP 1-02)

Biological threat. A threat that consists of biological material planned to be deployed to produce casualties in personnel or animals or damage plants. (JP 1-02)

Biological weapon. An item of materiel which projects, disperses, or disseminates a biological agent including arthropod vectors. (JP 1-02)

Blister agent. A chemical agent which injures the eyes and lungs and burns or blisters the skin. Also called vesicant agent. (JP 1-02)

Blood agent. A chemical compound, including the cyanide group, that affects bodily function by preventing the normal utilization of oxygen by body tissues. (JP 1-02)

Chemical agent. Any toxic chemical intended for use in military operations. (JP 1-02)

Chemical ammunition. A type of ammunition, the filler of which is primarily a chemical agent. (JP 1-02)

Chemical defense. The methods, plans, and procedures involved in establishing and executing defensive measures against attack utilizing chemical agents. (JP 1-02)

Chemical dose. The amount of chemical agent, expressed in milligrams, that is taken or absorbed by the body. (JP 1-02)

Chemical environment. Conditions found in an area resulting from direct or persisting effects of chemical weapons. (JP 1-02)

Collective nuclear, biological, and chemical protection. Protection provided to a group of individuals in a nuclear, biological, and chemical environment which permits relaxation of individual nuclear, biological, and chemical protection. (JP 1-02)

Combatant command. A unified or specified command with a broad continuing mission under a single commander established and so designated by the President, through the Secretary of Defense and with the advice and assistance of the Chairman of the Joint Chiefs of Staff. Combatant commands typically have geographic or functional responsibilities. (JP 1-02)

Contamination. (1) The deposit, absorption, or adsorption of radioactive material, or of biological or chemical agents on or by structures, areas, personnel, or objects. (2) Food and/or water made unfit for consumption by humans or animals because of the presence of environmental chemicals, radioactive elements, bacteria or organisms, the byproduct of the growth of bacteria or organisms, the decomposing material (to include the food substance itself), or waste in the food or water. (JP 1-02)

Contamination control. Procedures to avoid, reduce, remove, or render harmless (temporarily or permanently) nuclear, biological, and chemical contamination for the purpose of maintaining or enhancing the efficient conduct of military operations. (JP 1-02)

Decontamination. The process of making any person, object, or area safe by absorbing, destroying, neutralizing, making harmless, or removing chemical or biological agents, or by removing radioactive material clinging to or around it. (JP 1-02)

Detection. In nuclear, biological, and chemical (NBC) environments, the act of locating NBC hazards by use of NBC detectors or monitoring and/or survey teams. (JP 1-02)

Host nation support. Civil and/or military assistance rendered by a nation to foreign forces within its territory during peacetime, crises, or emergencies, or war based on agreements mutually concluded between nations. Also called HNS. (JP 1-02)

Identification. 1. The process of determining the friendly or hostile character of an unknown detected contact. 2. In arms control, the process of determining which nation is responsible for the detected violations of any arms control measure. 3. In ground combat operations, discrimination between recognizable objects as being friendly or enemy, or the name that belongs to the object as a member of a class. Also called ID. (JP 1-02)

Individual protection. Actions taken by individuals to survive and continue the mission under nuclear, biological, and chemical conditions. (JP 1-02)

Individual protective equipment. In nuclear, biological, and chemical warfare, the personal clothing and equipment required to protect an individual from biological and chemical hazards and some nuclear effects. (JP 1-02)

Mission-oriented protective posture. A flexible system of protection against nuclear, biological, and chemical contamination. This posture requires personnel to wear only that protective clothing and equipment (mission-oriented protective posture gear) appropriate to the threat level, work rate imposed by the mission, temperature, and humidity. Also called MOPP. (JP 1-02)

Mission-oriented protective posture gear. Military term for individual protective equipment including suit, boots, gloves, mask with hood, first aid treatments, and decontamination kits issued to soldiers. Also called MOPP gear. (JP 1-02)

Nerve agent. A potentially lethal chemical agent which interferes with the transmission of nerve impulses. (JP 1-02)

Nonpersistent agent. A chemical agent that when released dissipates and/or loses its ability to cause casualties after 10 to 15 minutes. (JP 1-02)

Nuclear, biological, and chemical-capable nation. A nation that has the capability to produce and employ one or more types of nuclear, biological, and chemical weapons across the full range of military operations and at any level of war in order to achieve political and military objectives. (JP 1-02)

Nuclear, biological, and chemical defense. Defensive measures that enable friendly forces to survive, fight, and win against enemy use of nuclear, biological, or chemical (NBC) weapons and agents. US forces apply NBC defensive measures before and during integrated warfare. In integrated warfare, opposing forces employ nonconventional weapons along with conventional weapons (NBC weapons are nonconventional). (JP 1-02)

Nuclear, biological, and chemical environment. Environments in which there is deliberate or accidental employment, or threat of employment, of nuclear, biological, or chemical weapons; deliberate or accidental attacks or contamination with toxic industrial materials, including toxic industrial chemicals; or deliberate or accidental attacks or contamination with radiological (radioactive) materials. (JP 1-02)

Nuclear defense. The methods, plans, and procedures involved in establishing and exercising defensive measures against the effects of an attack by nuclear weapons or radiological warfare agents. It encompasses both the training for, and the implementation of, these methods, plans, and procedures. (JP 1-02)

Persistency. In biological or chemical warfare, the characteristic of an agent which pertains to the duration of its effectiveness under determined conditions after its dispersal. (JP 1-02)

Persistent agent. A chemical agent that, when released, remains able to cause casualties for more than 24 hours to several days or weeks. (JP 1-02)

Protection. Measures that are taken to keep nuclear, biological, and chemical hazards from having an adverse effect on personnel, equipment, or critical assets and facilities. Protection consists of five groups of activities: hardening of positions, protecting personnel, assuming mission-oriented protective posture, using physical defense measures, and reacting to attack. (JP 1-02)

Protective mask. A protective ensemble designed protect the wearer's face and eyes and prevent the breathing of air contaminated with chemical and/or biological agents. (JP 1-02)

Residual Contamination. Contamination which remains after steps have been taken to remove it. These steps may consist of nothing more than allowing the contamination to decay normally. (JP 1-02)

Survey. The directed effort to determine the location and the nature of a chemical, biological, and radiological hazard in an area. (JP 1-02)

Toxic chemical. Any chemical which, through its chemical action on life processes, can cause death, temporary incapacitation, or permanent harm to humans or animals. This includes all such chemicals, regardless of their origin or of their method of production, and regardless of whether they are produced in facilities, in munitions or elsewhere. (JP 1-02)

Toxic industrial biological—Biological materials (bacteria, viruses, and toxins) found in medical research or pharmaceutical and other manufacturing processes that are toxic to humans and animals or cause damage to plants. (FM 4-02.7)

Toxic Industrial Chemical. Chemical compounds used or produced in industrial processes that are toxic to humans and animals, or cause damage to plants. (FM 4-02.7)

Toxic Industrial Materials. Toxic industrial materials may be toxic industrial chemical (TIC), toxic industrial biological (TIB), and toxic industrial radiological (TIR) materials. (FM 4-02.7)

Toxic Industrial Radiological. Radiation emitting materials used in research, power generation, medical treatment, and other non-weapon developmental activities that are harmful to humans and animals if released outside their controlled environments. (FM 4-02.7)

Weapons of mass destruction. Weapons that are capable of a high order of destruction and/or of being used in such a manner as to destroy large numbers of people. Weapons of mass destruction can be high explosives or nuclear, chemical, biological, and radiological weapons, but exclude the means of transporting or propelling the weapon where such means is a separable and divisible part of the weapon. Also called WMD. (JP 1-02)

Index

A

absorption C-15, C-16, C-17, C-18, D-6

air stability III-14, D-3, D-5, D-19, D-32, D-34, D-35, E-9, E-11, E-12, E-13, E-15, E-16, E-17, E-28, E-42, E-43, E-44, H-10

Air Weather Service See AWS (AWS)

americium C-15, C-17

atmospheric stability D-5, D-33

avoidance procedures A-1, E-1, F-1, F-2, F-3, F-4, F-5, G-2, H-2

AWS D-9, D-11, D-25, D-31

B

basic wind forecast See BWF

basic wind message See BWM

basic wind report See BWR

battle management I-7, I-9

biological contamination III-20, F-1

biological agent dissemination I-13, F-1

biological incident report See BIR

BIR L-26, L-1

BWF II-7, III-7, D-8, D-16, D-21

BWM II-7, III-7, D-8, D-16, D-21, D-26, G-23, H-13, H-14, H-16, H-17,

BWR II-7, III-7, D-8, D-9, D-10, D-16, D-17, D-21

C

CBRN

avoidance II-1, III-1, III-20, A-2, D-1

battle management I-7, I-8

checklists III-20, A-1, A-2, A-3, A-4, A-5, A-6

defense I-1, I-3, I-4, I-7, I-8, I-9, I-10, I-11, I-12, I-14, I-16, II-4, II-6, III-1, III-3, A-1, B-1, D-1, E-3, F-8, F-9, G-12, G-14, G-60, G-62, H-3

information flow II-4

operations I-11, A-1, A-3, A-4, A-5, A-6, G-66

reports II-5, III-4, III-5, H-4

CBRN warning I-9, III-1, A-1, B-2, B-4, B-6, B-49, L-10

CBRNWRS I-5, I-7, I-8, I-11, II-1, II-2, III-1, III-2, III-3, III-4, III-5, A-1, A-3, B-1, B-2, B-4, B-5, F-1, F-4, G-4, L-10

CDR II-8, III-7, D-9, D-10, D-11, D-16, D-27, D-29, D-30, E-29, F-12, F-13, F-14, F-15, F-16, F-18, F-19, F-21, F-22, F-24, F-25, F-26,

cesium III-15, III-16

Chemical, Biological, Radiological, and Nuclear Warning and Reporting System See CBRNWRS

chemical contamination III-7, III-20, E-1, E-5, E-41, H-20

chemical downwind report See CDR

chronic radiation syndrome See CRS

cloud coverage III-14, D-4, E-48, J-7

cold weather D-2,

common operational picture See COP

contamination avoidance I-1, I-2, I-3, I-4, I-5, III-20, A-1, E-1, F-1, G-1, H-1, H-2, H-5, H-6, H-7, K-1,

conversion table J-3, J-4

COP I-1, II-1, II-2, II-3, II-4, II-6, III-1, III-4, G-89

CRS C-5, G-51

D

decay of induced radiation G-89, G-94, J-57, J-58, J-60

depleted uranium See DU

detailed fallout prediction B-3, G-17, G-25, G-36, G-39, G-40, G-41, G-46, G-48, G-49, K-2

desert operations D-3

diffusion D-4, D-5, D-32, D-33, D-34

DU C-3, C-15, C-16, C-17, C-18

E

EDF II-7, III-7, D-9, D-15, D-26

EDM II-8, III-6, B-5, B-9, D-15, D-26,
D-27, D-28, G-14, G-23, G-24, G-25,
G-26, G-27, G-28, G-29, G-33, G-34,
G-36, G-51

EDR II-7, III-8, III-7, D-7, D-8, D-9, D-10,
D-17, D-25

effective downwind forecast See EDF

effective downwind message See EDM

effective downwind report See EDR

Emergency Response Guidebook See ERG

ERG III-9, H-10, H-12, H-14, H-15, H-16

exposure control C-1, C-2

F

fallout

- area D-1, D-8, D-9, D-25, G-1, G-23, G-24, G-33, G-34, G-65, G-66, G-69, G-78, G-81, G-82, K-3
- decay G-75, G-77, J-16, J-17, J-18, J-19, J-20, J-21, J-22, J-23, J-24, J-25, J-26, J-27, J-28, J-29, J-30, J-31, J-32, J-33, J-34
- total dose G-80

force protection See FP

FP I-7, II-1, II-9

G

ground zero III-2, I-2, J-13, J-14, K-1

H

hydrolysis D-6, D-7, D-8

I

individual protective equipment See IPE

Information Management II-2, II-4, III-1,
C-2, G-5, H-3

Iodine

IPE I-13, A-3, C-6, G-4, G-5

L

LLR C-3, C-4, C-5, C-13, H-9

low level radiation See LLR

M

map scales J-9

memorandum of agreement See MOA

memorandum of understanding See MOU

meteorological reports D-1, D-8

mission oriented protective posture See MOPP

MOA A-2

MOPP II-3, A-1, A-3, A-4, A-5, B-1, C-6,
E-1, E-2, E-3, E-5, F-8, H-2, H-3, H-4, J-13

MOU A-2, A-6

mountain operations D-3

N

NBC Reports II-1, II-4, III-1, III-2, III-3,
III-4, III-5, A-4, B-3, B-5, B-6

normalizing factors J-6

nuclear

- yield calculator G-9, G-19
- attack warning I-1
- strike warning I-1

O

operational elements I-1, I-2

operational exposure guidance See OEG

OEG C-2, C-4, C-6, C-8, G-1

P

phosphorus C-17, G-90

plutonium C-15, C-17, III-15

precipitation III-14, D-2, D-5, D-8, D-32,
G-1

Q

quality factor C-19

R

radiation type C-19

radiation dispersal device See RDD

radioactive material C-3, C-6, C-15, C-19

radiological

- hazards I-14, III-20, C-1, C-2, C-16, H-13
- exposure C-2, C-6, G-3

radium C-17, C-18

relative humidity III-14, D-4, D-5, E-48,
H-10, L-25,
RDD C-5, C-6, C-16, D-9, H-9, H-13
release other than attack (ROTA) types
H-10, H-11, H-12

S

shielding values G-59
simplified fallout prediction G-25, G-27,
G-28
stability category III-14, D-30, D-31, D-32,
D-33, E-13, E-15, E-16, E-17, E-28, E-
37, E-38, E-43, E-44, E-48, E-52, J-7
strike warning See STRIKWARN
STRIKWARN III-7, III-8, G-40, I-1, I-2, I-
3, I-4, I-5, I-6
strontium C-18

T

TF G-60, G-61, G-62, G-70, G-81, G-82, G-
90, G-91, G-93, G-94, J-5, K-2, K-4
thorium-232 C-18
transmission factors See TF
tritium C-18

U

unexploded ordnance See UXO
uranium C-3, C-16, C-17, C-18, C-19
UXO A-4

V

vapor concentration D-5, D-7, D-8
vulnerability assessment II-5, III-20
vulnerability reduction I-6

W

weather effects D-1, D-3, D-4, D-5,
wind speed and direction D-2, D-31

Y

yield estimation G-3, G-17, G-19, G-20, G-
22, G-33, J-13, J-14, K-1

THIS PAGE IS INTENTIONALLY LEFT BLANK.

**FM 3-11.3
MCWP 3-37.2A
NTTP 3-11.25
AFTTP(I) 3-2.56
2 February 2006**

By Order of the Secretary of the Army:

Official:

**PETER J. SCHOOMAKER
General, United States Army
Chief of Staff**

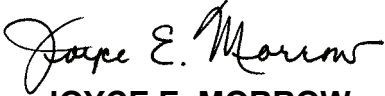
**JOYCE E. MORROW
Administrative Assistant
to the Secretary of the Army
0613002**

DISTRIBUTION:

Active Army, Army National Guard, and US Army Reserve: To be distributed in accordance with the initial distribution number 113829, requirements for FM 3-11.3.

By Order of the Secretary of the Air Force

**BENTLEY B. RAYBURN
Major General, USAF
Commander
Headquarters Air Force Doctrine Center**

Air Force Distribution: F

THIS PAGE IS INTENTIONALLY LEFT BLANK

THIS PAGE IS INTENTIONALLY LEFT BLANK

THIS PAGE IS INTENTIONALLY LEFT BLANK

