

FM 3-04.104

Forward Arming and Refueling Point

Tactics, Techniques, and Procedures

August 2006

DISTRIBUTION RESTRICTION: Approved for public release; distribution is unlimited.

HEADQUARTERS, DEPARTMENT OF THE ARMY

This publication is available at
Army Knowledge Online (www.us.army.mil) and
General Dennis J. Reimer Training and Doctrine
Digital Library at (www.train.army.mil).

Tactics, Techniques, and Procedures for Forward Arming and Refueling Point

Contents

	Page
PREFACE	viii
Chapter 1 INTRODUCTION	1-1
Definition	1-1
Purpose	1-1
Organization	1-1
Planning Factors	1-3
Personnel	1-4
Tactical Enablers	1-5
Threat	1-5
Chapter 2 COMMAND, CONTROL, AND COMMUNICATION	2-1
Command and Control	2-1
Aircraft Control	2-1
Traffic Layout	2-3
Radio Communications	2-5
Chapter 3 FORWARD ARMING AND REFUELING POINT UTILIZATION	3-1
Section I – Employment Factors	3-1
Types of Forward Arming and Refueling Points	3-1
Site Selection	3-2
Engineering Considerations	3-3
Movement Plan	3-3
Emplacement	3-4
Security	3-20
Relocation	3-20
Damaged or Destroyed Assets	3-21
Section II – Forward Arming and Refueling Point Equipment	3-21
Forward Area Refueling Equipment	3-21
Advanced Aviation Forward Area Refueling System	3-22
Heavy Expanded Mobility Tactical Truck Tanker Aviation Refueling System	3-24
Support Equipment	3-26
Personnel Refueling Requirements	3-27
Refueling Nozzles	3-28
Equipment Setup	3-31

Distribution Restriction: Approved for public release; distribution is unlimited.

Contents

	Section III – Ammunition Operations, Equipment, and Storage	3-32
	Ammunition Storage	3-32
	Ammunition Safety Procedures	3-32
	Section IV – Arming Operations	3-34
	Armament Pad Setup	3-34
	Personnel Requirements	3-35
	Simultaneous Arming and Refueling	3-35
	Section VI – Aircraft Flow and Mix	3-36
	Limitations	3-36
	Aircraft Mix	3-37
	Section V – Training	3-37
	Qualification Training	3-37
	Training Realism	3-38
	Operation Skills	3-38
	Individual and Collective Training	3-38
Chapter 4	SUSTAINMENT	4-1
	Considerations	4-1
	Resupply	4-1
	Class III Requirements	4-3
	Class V Requirements	4-4
	Argon Gas	4-4
	Transportation	4-6
	Nonlinear/Noncontiguous Battlefield Operations	4-7
Chapter 5	OPERATIONAL ENVIRONMENTS	5-1
	Night Operations	5-1
	Desert Operations	5-2
	Winter Operations	5-4
Chapter 6	ENVIRONMENTAL PROTECTION CONSIDERATIONS	6-1
	Army Environmental Management Policy	6-1
	Liability	6-2
	Spill Definitions	6-2
	Spill Discovery	6-3
	Assessment	6-3
	Spill Cleanup	6-4
	Spill Kits	6-4
	Reacting to a Small Primary Spill	6-5
	Reacting to a Small/Large Spill	6-6
Appendix A	STANDARD HAND AND ARM SIGNALS	A-1
Appendix B	SAMPLE FORWARD ARMING AND REFUELING POINT STANDING OPERATING PROCEDURE	B-1
Appendix C	LOAD PLANS	C-1
Appendix D	MULTIPLE FORWARD ARMING AND REFUELING POINT OPERATIONS	D-1
Appendix E	FORWARD ARMING AND REFUELING POINT SAFETY REQUIREMENTS	E-1
Appendix F	ARMAMENT CONFIGURATIONS FOR THE AH-64 AND OH-58D	F-1
Appendix G	TROOP LEADING PROCEDURES	G-1
Appendix H	HAZARDOUS MATERIAL/HAZARDOUS WASTES SUPPLIES	H-1
	GLOSSARY	Glossary-1

REFERENCES	References-1
INDEX	Index-1

Figures

Figure 1-1. Sample structure for a forward support company	1-2
Figure 1-2. Aviation support battalion	1-2
Figure 1-3. Aviation support battalion (support of combat aviation brigade).....	1-3
Figure 2-1. Air traffic services company in general support aviation battalion	2-2
Figure 2-2. AN/TSQ-198 tactical terminal control system	2-2
Figure 2-3. Traffic layout at a forward arming and refueling point.....	2-3
Figure 2-4. Forward arming and refueling point layout for simultaneous operations	2-4
Figure 3-1. Rolling forward arming and refueling point.....	3-2
Figure 3-2. Typical disposition of theater and division class III/V products	3-5
Figure 3-3. Heavy expanded mobility tactical truck forward arming and refueling point layout	3-8
Figure 3-4. Configuration of the extended range fuel system (fat cow).....	3-10
Figure 3-5. Gear board	3-10
Figure 3-6. Refueling point setups	3-11
Figure 3-7. Extended range fuel system layout configuration	3-11
Figure 3-8. Extended range fuel system II functional components	3-12
Figure 3-9. Forward area refueling equipment kit assembly	3-12
Figure 3-10. Configuring the forward area refueling equipment components	3-13
Figure 3-11. Heavy expanded mobility tactical truck tanker aviation refueling system configuration and additional components for CH-53 forward arming and refueling point.....	3-14
Figure 3-12. Heavy expanded mobility tactical truck tanker aviation refueling system configuration and additional components for KC-130 forward arming and refueling point.....	3-15
Figure 3-13. Heavy expanded mobility tactical truck tanker aviation refueling system configuration and additional components for C-17 forward arming and refueling point.....	3-16
Figure 3-14. Example of a site layout for a volcano arming point.....	3-19
Figure 3-15. Advanced aviation forward area refueling system	3-22
Figure 3-16. Advanced aviation forward area refueling system layout.....	3-23
Figure 3-17. Forward area refueling equipment setup under various wind conditions.....	3-24
Figure 3-18. Unisex connections	3-25
Figure 3-19. Heavy expanded mobility tactical truck tanker aviation refueling system components and layout.....	3-25
Figure 3-20. Closed circuit refueling open-port (gravity-fill) nozzle adapter	3-29
Figure 3-21. Model 125-1000 closed-circuit refueling nozzle	3-30
Figure 3-22. Recirculation nozzle	3-30
Figure 3-23. D-1 center-point refueling nozzle	3-30
Figure 3-24. Two typical layouts for helicopter rear points	3-34
Figure 3-25. Three-dimensional view of a helicopter rear point plan	3-35

Figure 3-26. Simultaneous rearming and refueling forward arming and refueling point layout.....	3-36
Figure 4-1. Flow of class III/IV supplies.....	4-3
Figure 4-2. Formulas for calculating class III (JP8).....	4-4
Figure 4-3. Air-to-air stinger launcher	4-5
Figure 4-4. Basic charging unit.....	4-5
Figure 5-1. T-Formation forward area refueling equipment/advanced aviation forward area refueling system setup.....	5-3
Figure 6-1. Spill kit	6-5
Figure 6-2. Digging a dike/berm	6-6
Figure A-1. Position of ground guide for a rotary-wing aircraft	A-1
Figure A-2. Proceed to next ground guide	A-1
Figure A-3. This way.....	A-1
Figure A-4. Move ahead.....	A-2
Figure A-5. Turn to left (port).....	A-2
Figure A-6. Turn to right (starboard).....	A-2
Figure A-7. Landing directions	A-2
Figure A-8. Move upward	A-3
Figure A-9. Hover	A-3
Figure A-10. Move downward	A-3
Figure A-11. Move to right.....	A-3
Figure A-12. Move to left	A-3
Figure A-13. Slow down	A-3
Figure A-14. Stop	A-4
Figure A-15. Brakes.....	A-4
Figure A-16. Fire.....	A-4
Figure A-17. Engage rotor(s).....	A-4
Figure A-18. Start engine(s).....	A-5
Figure A-19. Wave-off	A-5
Figure A-20. Affirmative (all clear).....	A-5
Figure A-21. Negative (not clear)	A-5
Figure A-22. Move back	A-6
Figure A-23. Land.....	A-6
Figure A-24. Tail to right (starboard)	A-6
Figure A-25. Tail to left (port)	A-6
Figure A-26. Clearance for personnel to approach aircraft.....	A-7
Figure A-27. Personnel approach the aircraft (given by ground crewmember).....	A-7
Figure A-28. Up hook	A-7
Figure A-29. Down hook.....	A-7
Figure A-30. Slow down engine(s) on indicated side	A-8
Figure A-31. Cut engine(s) or stop rotor(s)	A-8
Figure A-32. Connect auxiliary power unit	A-8

Contents

Figure A-33. Disconnect auxiliary power unit	A-8
Figure A-34. Insert chocks/chocks inserted.....	A-9
Figure A-35. Remove chocks.....	A-9
Figure A-36. Hook up load	A-9
Figure A-37. Release load	A-9
Figure A-38. Load has not been released	A-10
Figure A-39. Cut cable	A-10
Figure A-40. Winch up	A-10
Figure A-41. Winch down.....	A-10
Figure A-42. Lock wings/helicopter blades	A-11
Figure A-43. Install.....	A-11
Figure A-44. Remove.....	A-11
Figure A-45. Remove blade tie-downs	A-11
Figure A-46. Droop stops out.....	A-12
Figure A-47. Droop stops in	A-12
Figure A-48. Ground hand signals	A-13
Figure B-1. Example of a forward arming and refueling operations annex to a tactical A-standing operation procedure.....	B-1
Figure C-1. M978 heavy expanded mobility tactical truck tanker	C-1
Figure C-2. M977 heavy expanded mobility tactical truck cargo vehicle.....	C-2
Figure C-3. M989A1 heavy expanded mobility tactical truck.....	C-2
Figure C-4. Suggested ammunition load plan 1	C-3
Figure C-5. Suggested ammunition load plan 2	C-3
Figure C-6. Suggested ammunition load plan 3	C-4
Figure C-7. Load plan key.....	C-4
Figure D-1. Multiple forward arming and refueling point operations.....	D-1
Figure D-2. Suggested forward arming and refueling point schedule	D-2
Figure E-1. Forward arming and refueling point requirements	E-1
Figure F-1. AH-64 armament configurations	F-1
Figure F-2. OH-58D authorized armament configurations	F-2
Figure G-1. Critical elements of the forward arming and refueling point planning sequence	G-1

Tables

Table 3-1. Portable fire extinguisher types.....	3-27
Table 3-2. Common items used during helicopter rearm operations.....	3-33
Table 3-3. Minimum safe distances (in feet) between rearm points and ready ammunition storage area.....	3-33
Table 4-1. Cargo capacity comparison in rounds.....	4-1
Table 4-2. Fuel Consumption Rates.....	4-3
Table 4-3. Round-trip travel times.....	4-7

Preface

This FM describes forward arming and refueling point (FARP) operations. It provides aviation commanders, staff elements, and Class III and V personnel with a comprehensive view of the purpose, organization, and operation of the FARP. It also describes planning considerations for setup of the FARP as well as transportation planning for Class III and V products.

This FM primarily applies to aviation unit commanders, their staffs, and Class III and V personnel operating a FARP. It applies to aviation units operating on the battlefield. The principles contained herein apply to all aviation units that may be involved in forward arming and refueling missions.

The Combined Arms Support Command is the proponent for operations and military occupational specialties (MOSSs) related to fueling and ammunition operations. This FM provides tactics, techniques, and procedures for arming and refueling of Army aircraft.

Units must refer to FM 10-67-1 for greater detail and applicable checklists. FM 10-67-1 consolidates and supersedes FMs 10-18, 10-20, 10-68, 10-69, 10-70-1, and 10-71. Units ensure that FARP personnel have the most current version of FM 10-67-1 available during FARP operations.

For ammunition operations, the user should refer to FM 4-30.1.

Other technical manuals (TMs) are cited in this appendix, and these are available at www.logsa.army.mil.

This publication applies to the Active Army, the Army National Guard/Army National Guard of the United States, and the United States Army Reserve unless otherwise stated.

The proponent of this publication is Headquarters, United States Army Training and Doctrine Command. Send comments and recommendations on Department of the Army (DA) Form 2028 (Recommended Changes to publications and Blank Forms) or automated link (<http://www.usapa.army.mil/da2028/daform2028.asp>) to Commander, United States Army Aviation Warfighting Center (USAAWC), ATTN: ATZQ-TD-D, Fort Rucker, Alabama 36362-5263. Comments may be e-mailed to the Directorate of Training and Doctrine (DOTD) at av.doctrine@us.army.mil.

Unless this publication states otherwise, masculine nouns and pronouns do not refer exclusively to men.

This publication has been reviewed for operations security considerations.

Chapter 1

Introduction

The forward arming and refueling point (FARP) is vital to the success of the aviation combat mission. Attack, air assault, and support aviation units all depend on the FARP to provide fuel and ammunition where and when they are needed. This chapter defines the FARP and discusses its purpose. It also discusses organization, planning factors, personnel, tactical enablers, and the threat.

DEFINITION

1-1. A FARP is a temporary facility—organized, equipped, and deployed by an aviation commander, and normally located in the main battle area closer to the area where operations are being conducted than the aviation unit's combat service area—to provide fuel and ammunition necessary for the employment of aviation maneuver units in combat. The forward arming and refueling point permits combat aircraft to rapidly refuel and rearm simultaneously.

PURPOSE

1-2. The FARP increases the time on station and extends the range of aircraft for the commander by reducing the turnaround time associated with refueling and rearming. FARPs thereby give the commander more time to apply continuous pressure on the enemy. They are usually employed when the turnaround time at the unit trains is too long or when time on station must be optimized. FARPs also are employed in support of deep attacks or special operations when the distance covered exceeds the normal range of the aircraft. Additionally, FARPs are employed during rapid advances when field trains are unable to keep pace. The most efficient use of a FARP is simultaneous arming and refueling.

Contents	
Definition	1-1
Purpose.....	1-1
Organization	1-1
Planning factors	1-3
Personnel.....	1-4
Tactical enablers	1-5
Threat	1-5

ORGANIZATION

1-3. Under the combat aviation brigade (CAB), aviation battalions have forward support companies (FSCs)/distribution (DISTRO) companies and maintenance personnel. The attack reconnaissance battalion (ARB) is assigned Class III/V (89B-ammunition specialists) assets under the FSC structure and armament personnel are assigned under the component repair platoon. The assault helicopter battalion (AHB) and the general support aviation battalion (GSAB) are assigned Class III and Class V (89B-ammunition specialists) assets under the FSC, armament personnel are not required. The aviation support battalion (ASB) is assigned Class III assets under the DISTRO and armament personnel are assigned under the component repair platoon. These structures allow commanders and platoon leaders the ability to task organize FARP operations. Task organizing Class III/V assets at the unit level may present some challenges, if proper coordination is not taken and necessary resources are not available.

FORWARD SUPPORT COMPANY

1-4. The ARB, AHB, and GSAB FSC have a headquarters platoon, field feeding, DISTRO platoon, and ground maintenance platoon. The DISTRO section provides aircraft refuel capability, ammunition

Chapter 1

specialists (89B), water, and transportation. Also, with proper coordination the ARB, AHB, and GSAB can be augmented by the ASB. (See figure 1-1 for general structure of a FSC.)

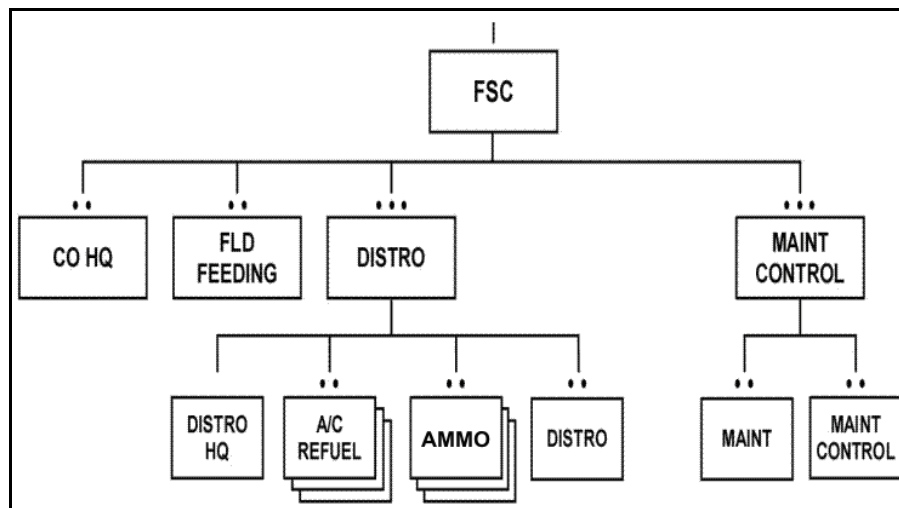

Figure 1-1. Sample structure of a forward support company

AVIATION SUPPORT BATTALION ORGANIZATION

1-5. The ASB (figure 1-2) consists of four companies—the headquarters and support company (HSC), the DISTRO company, the network signal company and the aviation support company (ASC). The ASB provides aviation and ground field maintenance, network communications, resupply, and medical support. The HSC provides medical support and conducts field-ground maintenance and recovery. The DISTRO company functions as a supply support activity and distributes supplies to subordinate units of the CAB. The network signal company provides network and signal support to the CAB headquarters. The ASC provides intermediate maintenance and support for on-aircraft and critical off-aircraft field level maintenance and the maintenance of unmanned aerial systems. The ASC also conducts battle damage assessment (BDA) and repair and provides backup support to the aviation maintenance company (AMC).

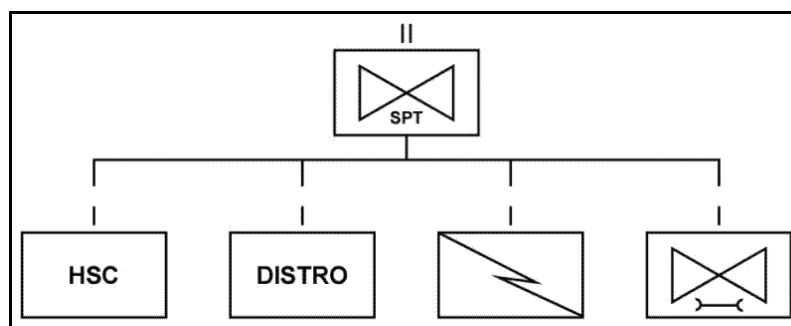

Figure 1-2. Aviation support battalion

1-6. The DISTRO company provides logistics support for the aviation brigade. The DISTRO company receives, temporarily stores, and issues bulk Class III. It also establishes and operates Class III (aviation fuel) transload sites in the brigade support area (BSA) to resupply brigade operations. Using the brigade/battalion rear FARP, the DISTRO company provides fuel to all brigade aircraft. Figure 1-3, page 1-3, shows the unit organization of the ASB in support of the aviation brigade.

1-7. The ASC provides armament personnel to FSCs upon request. The additional armament personnel will assist the FSCs with arming and dearming operations to fulfill mission requirements and provides the FSC advanced field maintenance support.

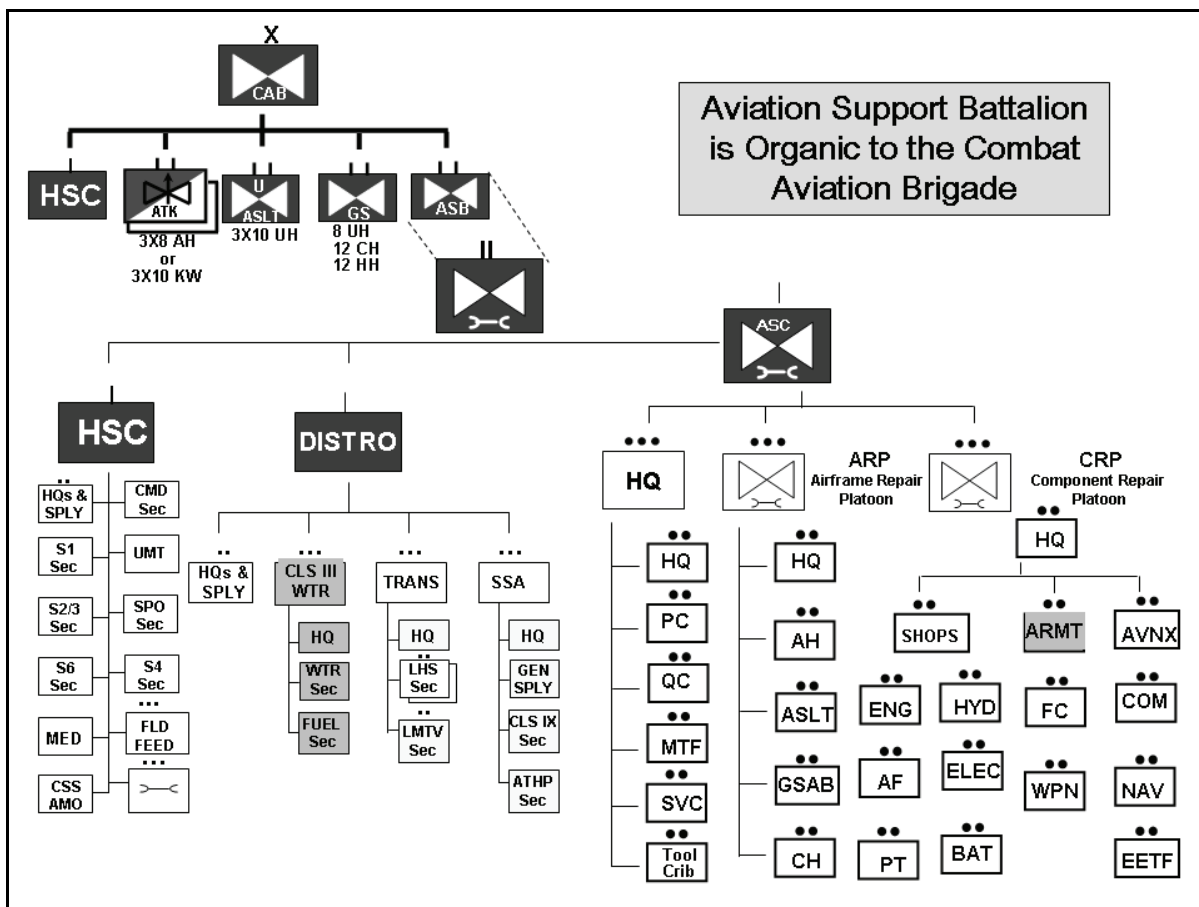

Figure 1-3. Aviation support battalion (support of combat aviation brigade)

PLANNING FACTORS

- 1-8. The following basic principles should be satisfied when planning a FARP to support aviation units:
- The FARP should meet unit mission requirements.
 - The FARP should provide support throughout the battlefield under all conditions.
 - The FARP should avoid threat observation and engagement.

PLANNING CONSIDERATIONS

1-9. The intensity of the battle will affect FARP activities. The commander should be aware of the following planning considerations:

- Command, control, and communication (C3).
- Terrain analysis (maps, overlays, databases, software).
- Weather analysis.
- Analysis of other characteristics of the battlefield.
- Wet or dry cross-country mobility
- Transportation systems (road and bridge information).
- Vegetation type and distribution.
- Surface drainage and configuration.
- Surface materials (soils).
- Ground water.

Chapter 1

- Manmade structures.
- Obstacles (placed by the enemy).
- Higher operation tempo.
- Distance between the battle positions and logistics trains.
- FARP location.
- Flight time to and from FARP position.
- Threat.
- Availability of cover and concealment.
- Road conditions.
- Availability of higher-echelon throughput of Class III/V.
- Distance to Class III/V distribution points.
- FARP mobility and ability to displace rapidly.
- Armed escort for Fat Cow/Wet Hawk operation.
- Minimum personnel and equipment. (It may be impractical to use aircraft assets to transport materials handling equipment (MHE). However, the absence of MHE can seriously degrade the ammunition-handling and breakdown capability of the FARP (Department of the Army Pamphlet [DA PAM] 385-64).
- Effective camouflage.
- Survivability.

FIGHTER MANAGEMENT/CREW ENDURANCE

1-10. Managing crew endurance is a command function that is an integral part of the risk management process. Using the chain of command, experience and judgment, the commander must make the decision as to who is best capable of performing the mission. This does not relieve individuals from informing the commander when they feel they are incapable of completing the mission due to fatigue. When everyone is tired from extended operations, it takes a cooperative effort from all team members to insure that personnel and assets are not expended uselessly. The following definitions are provided to support the fighter management process:

- **Fighter management.** Management of human resources to maximize combat effectiveness by providing for individual rejuvenation, both physically and mentally, from stress or fatigue resulting from work activities and environmental factors.
- **Non-Aviation Related Duties.** Any military duties not defined as aviation-related duties or flight duty.
- **Rest Period.** Off-duty personal time that precedes or follows a duty period. The rest period begins when the soldier has completed all job-related tasks associated with the mission and/or has been released from duty to individually manage his/her own time.
- **Reverse Cycle.** A duty period that changes the normal circadian rhythm. Reverse cycle is when the individual is required to alter the normal duty schedule by 6 hours or more.

1-11. The primary factor in effective fighter management/crew endurance is scheduling. Proper prior planning ensures that the proper crew mix is available at optimum performance levels for the mission. Fighter management is first and foremost a risk management tool for commanders. As a risk management tool, the fighter management program provides guidance for high operating tempo (OPTEMPO) operations and ensures risk decisions are made at the proper command levels. The final authority for fighter management decisions lies with the brigade commander.

PERSONNEL

1-12. Personnel allocations for the FARP include military occupational specialties (MOSs) 92F, 89B, 15J, 15X, and 15Y. Petroleum specialists, MOS 92F, transport Class III and fuels aircraft. Ammunition specialists, MOS 89B, transport, unpack, maintain, and account for ammunition. Aircraft armament

repairers, MOSs 15J/X/Y, repair fire control systems and arm observation helicopter (OH)-58D, attack helicopter (AH)-64A, and AH-64D aircraft, respectively. As required, commanders augment the FARP with other medical, BDA/maintenance teams, and security forces.

1-13. In the ARB, AHB, and GSABs MOSs 92F and 89B are assigned to the battalion's FSC. ASB MOSs 92F and 89B are assigned to the DISTRO companies. MOSs 15J, 15X, and 15Y are assigned to the aircraft component repair section of the aviation maintenance company/troop (AMC/T). Commanders should ensure command and control (C2) is established before FARP personnel depart from area of operation (AO).

1-14. The increased tempo of operations and/or density of traffic may require air traffic services (ATS) assets. In such cases, the commander or his representative may request from the GSAB a tactical aviation control team (TACT) consisting of four MOS 15Q, Air Traffic Control Operators. TACTs are also available from the Airfield Operations Detachments (AODs) at the theater areas of operation.

TACTICAL ENABLERS

AIR DEFENSE

1-15. The aviation unit commander occasionally uses other elements such as air defense (AD) depending on the mission requirements. AD support is staffed through air defense artillery (ADA) headquarters. The Operations Staff Officer (S-3) coordinates and supervises the support and activities of the AD force throughout the operation. Based on the commander's priorities, the AD officer and the S-3 allocate specific AD weapons and designate the positions that the weapons will occupy.

1-16. The FARP has a limited organic AD capability. The firepower of the FARP includes M240 machine gun, semiautomatic weapons, and other small arms. These weapons can make a difference during an air attack. Small arms fire may not destroy attacking enemy aircraft; however, they may distract pilots long enough for them to miss their target.

FIELD ARTILLERY

1-17. The CAB supports the maneuver brigade combat teams (BCTs). The aviation brigade's fire support officer (FSO) coordinates with the BCT or fires brigade FSO for fire support. The battalion FSO will coordinate with the aviation brigade FSO to ensure requirements are relayed to the BCT or fires brigade FSO. The aviation battalion S-3 designates the locations of the FARPs. The S-3 should provide the FSC leadership and the FSO these locations along with the projected movement time to the locations so that the FSO can plan a schedule of fires to protect the FARP.

INTELLIGENCE

1-18. To defeat the enemy, the aviation commander must "see" the battlefield better than his opponent. He must know as much as possible about the enemy, weather, and terrain. This intelligence helps the commander make decisions, issue orders, and successfully employ his forces on the battlefield. It also helps the commander determine the best locations for his FARPs. The Intelligence Staff Officer (S-2) is the intelligence coordinator for the battalion. He collects, processes, and interprets information from subordinate units. Appendix G shows the critical elements that must be considered during FARP planning.

1-19. The FSC commander/platoon leader must keep abreast of the intelligence situation so that he can anticipate and plan for future FARP operations. Armed with up-to-date intelligence, the platoon leader can help the S-3 determine how to best support the mission. Current knowledge of the enemy will help the FSC leadership avoid threat targeting of the FARP through sensor weapons.

THREAT

1-20. The threat can neutralize aviation force effectiveness by preventing aircraft from arming and refueling. Therefore, the FARP will be a high-priority target for the enemy. Class III/V stocks in the AO

Chapter 1

will likely be subject to chemical, biological, radiological, and nuclear (CBRN) ground, tactical air, air assault, and artillery attacks. Local sympathizers and insurgents may even harass FARP operations.

1-21. Units fight as they train and must regard force protection as a priority. Aviation units that do not spend adequate time training on force protection measures are often unsuccessful at repelling threat assaults.

Chapter 2

Command, Control, and Communications

One of the most difficult aspects of FARP operations is C3 with other elements in the aviation unit without compromising the FARP. This chapter discusses the C3 responsibilities of the commander and his staff relative to the FARP. It also includes modes and methods for aircraft control into, within, and out of the FARP.

COMMAND AND CONTROL

2-1. The commander is responsible for the overall success of the FARP. Based on the factors of mission, enemy, terrain and weather, troops available, time available, civilian considerations (METT-TC), the commander decides how his FARP assets will be used to support his operational intent.

2-2. The Executive Officer (XO) is the principal assistant to the commander. He must be prepared to assume command at any time. The XO supervises the S-3 and Logistics Staff Officer (S-4) as they coordinate the logistics support for the unit.

2-3. The S-3 formulates the commander's plan, which includes the FARP, to accomplish the mission. The S-3 consults with the S-4 and the HSC commander to ensure that the plan can be supported logistically.

2-4. The S-4 calculates the fuel and ammunition required for the mission and plans the distribution of these supplies. He then coordinates these requirements with higher headquarters.

2-5. The FSC commander is responsible for accomplishing the FARP mission. He assists the S-3 in formulating the FARP plan and coordinates fuel and ammunition needs with the S-4.

2-6. A safety officer (SO) will certify the FARP prior to use. If a SO is not available, a pilot of the first aircraft in the FARP will certify the FARP according to the FARP checklist that is provided by the FARP noncommissioned officer in charge (NCOIC).

Contents	
Command and Control	2-1
Aircraft Control	2-1
TrafficLayout.....	2-3
Radio Communications.....	2-5

AIRCRAFT CONTROL

2-7. The control of aircraft within the FARP is critical to safety and overall efficiency of the operation. The proximity of the FARP to the battlefield may restrict the use of radars for positive aircraft control. The most effective means of control will be a thorough briefing and a well-written and rehearsed standing operating procedure (SOP) that outlines the FARP procedures to be followed by both aircrews and FARP personnel. Additionally, offset, low-output nondirectional radio beacons and global positioning system (GPS) may be a low risk method for locating FARPs. Also, various signaling methods may be used to maintain procedural aircraft control.

AIR TRAFFIC SERVICES

2-8. The use of ATS in a FARP is METT-TC dependent. Under some circumstances, such as during situations other than war, ATS units can provide the aviation commander with a greater measure of safety and synchronization. However, ATS should be considered in the planning for FARP operations.

2-9. One ATS company will be assigned to each CAB GSAB (figure 2-1, page 2-2) to provide a full range of terminal and en route ATS for the division areas of operation. The airfield operations

Chapter 2

detachment (AOD) has like capabilities at the theater level. The ATS company or AOD TACT is best suited for FARP operations. A TACT can manage the flow of airborne and taxiing aircraft for a faster, safer, and more efficient operation, with a minimal footprint on the FARP area.

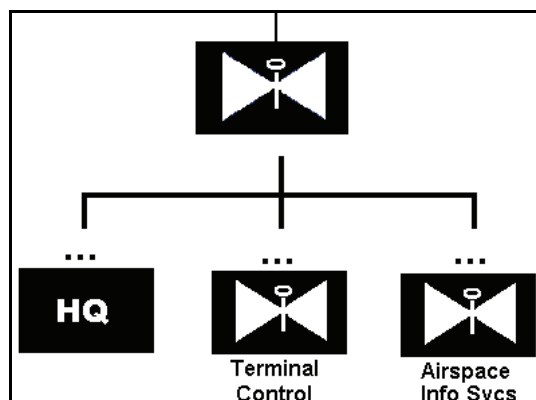

Figure 2-1. Air traffic services company in general support aviation battalion

2-10. Each TACT is equipped with the AN/TSQ-198 Tactical Terminal Control System (TTCS) (figure 2-2) and the AN/TRN-30(V)1 Tactical Nondirectional Radio Beacon (TNDB). The TTCS is a high mobility multipurpose wheeled vehicle (HMMWV)-mounted air traffic control system used to provide arrival/departure information, limited weather, wind direction, and speed information, and sequencing instructions. The TTCS is equipped to provide secure ultra high frequency-amplitude modulation (UHF-AM), very high frequency-amplitude modulation (VHF-AM), very high frequency-frequency modulation (VHF-FM), and high frequency-automated link establishment (HF-ALE) ground-to-air and ground-to-ground voice and data communications. Recent upgrades provide a satellite communication capability. The TTCS communications system can also convert to a battery-operated, man-pack configuration for dismounted and remote operations. A multi-color, light signal gun is available for no-radio or noise discipline operations. The TNDB, operated continuously or by demand-activation, provides automatic direction finder-equipped aircraft a means to electronically locate a landing area, such as a FARP, out to 25 nautical miles. A nonprecision instrument approach procedure may be developed for the TNDB to safely recover aircraft during marginal and less than visual meteorological conditions. The TTCS and mission equipment are sling loadable by a UH-60 or larger helicopter and can be transported by a single C-130 aircraft sortie.

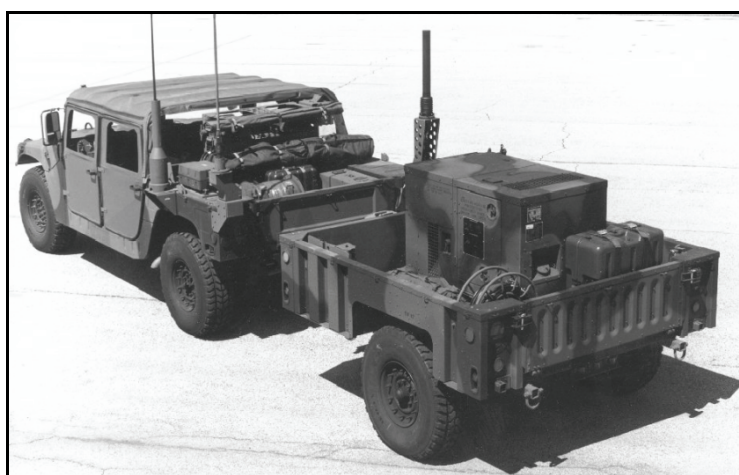

Figure 2-2. AN/TSQ-198 tactical terminal control system

TRAFFIC LAYOUT

2-11. Standard marker panels on departure and arrival points will improve the procedural control of aircraft. Engineer tape, chemical lights, or beanbag lights can be used at night to indicate the desired direction of aircraft movement or the location of ground guides. The aircraft should move to the ground guide's location for arming and refueling. After the aircraft has been serviced, the ground guide should direct it toward the departure end of the FARP. Additional aircraft control can be achieved by maintaining section integrity during FARP operations. Selected waiting areas and separate ingress and egress routes also improve aircraft control. As much as possible, the unit safety officer should be involved in planning safe routes in and out of the FARP and establishing checkpoints along the routes. Figure 2-3 shows an example traffic layout at the FARP. Figure 2-4, page 2-4, shows the FARP layout for simultaneous operations.

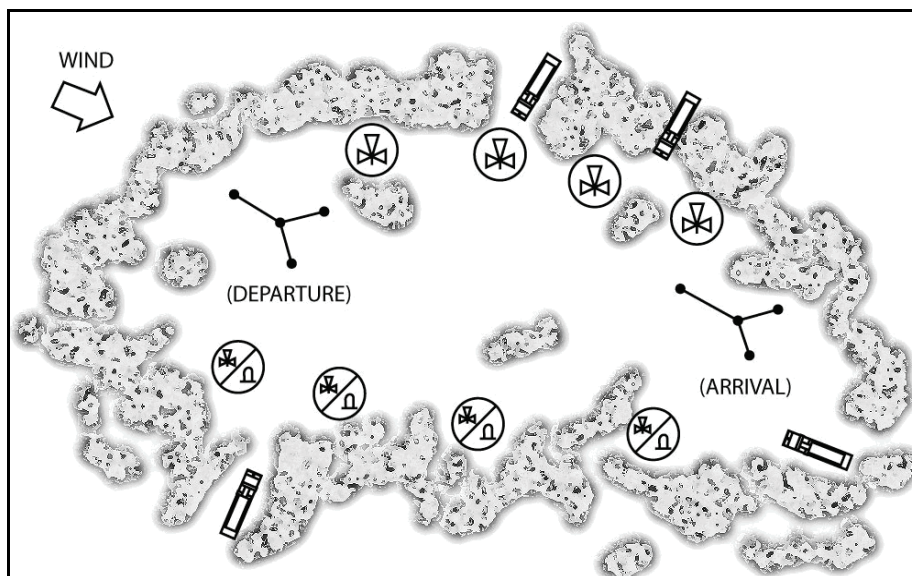

Figure 2-3. Traffic layout at a forward arming and refueling point

CAUTION

If marker panels and engineer tape are used, they must be properly secured to prevent foreign object damage (FOD) to aircraft.

VISUAL SIGNALS

2-12. Visual signals include hand and arm signals, pyrotechnic, signal flags, marker panels, and light signals (see FM 21-60). Ground guides will normally control the movement of aircraft within the FARP. Because ground guides may direct other allied aircraft, they must use standard hand and arm signals. These signals are shown in appendix A.

Pyrotechnic

2-13. Smoke is not the preferred visual signal, but it has several advantages. For instance, it can indicate wind direction. Different colors can indicate the current situation of the FARP or the availability of Class III/V products. Smoke also has some disadvantages, such as day use only, obscures obstacles, and can compromise the FARP location.

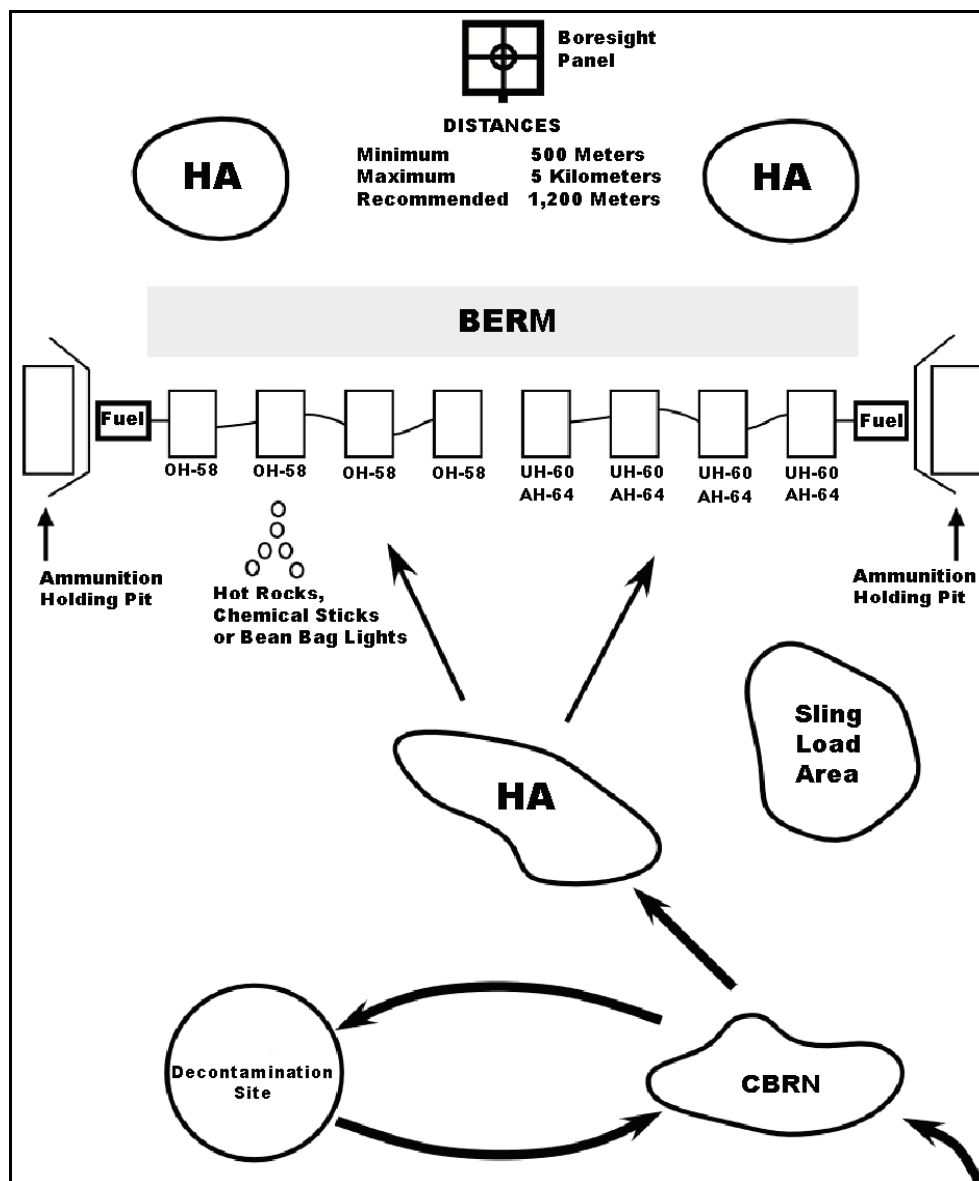

Figure 2-4. Forward arming and refueling point layout for simultaneous operations

Light and Flags

2-14. Flashlights and light wands are other types of visual signals. The flashlight can be used with color-coded disks to relay information. A separate colored disk, which is easily seen at night, can indicate the FARP situation or supply availability. During the day, signal flags of different colors can serve the same purpose. Flashlights can be used with hand and arm signals. Sites should be concealed that limit enemy ability to detect FARP light sources. FARP personnel maintain light discipline until aircraft arrive. Personnel use light wands with hand-and-arm signals to mark departure, landing, and arming and refueling points.

2-15. Chemical lights come in a variety of colors to include infrared (IR), which can be seen only through night vision devices (NVDs). They can be used in the same manner as flashlights and light wands. An effective technique for lighting the landing area using chemical lights is to dig a shallow trench in the shape of the landing area and place chemical or beanbag lights in the trench. The landing area can be seen only at a certain angle from the air. On the ground, the landing area is difficult to see.

Arming Signals

2-16. In peacetime, aircrews turn off the anticollision light to signal the ground crew to begin arming. As an alternate combat signal, aircrews may employ hand-and-arm signals during the day and cockpit navigation lights at night to signal the start of arming. Ground personnel can talk via intercom to the aircrew with the helmet assembly, rearming refueling personnel (HARRP) (Common Table of Allowances [CTA] 50-900) with communications (HGU-24/P).

RADIO COMMUNICATIONS

2-17. The use of radios must be kept to a minimum to reduce the enemy's ability to target and engage electronic emissions. However, each FARP (active and silent) should have two FM radios capable of secure voice or secure data burst transmissions. This allows simultaneous monitoring of both the command and administrative and logistics networks. The internal network (alternate network) would provide FARP personnel with information about the current status of inbound aircraft and ammunition requirements. The command-designated network would provide information that may affect the FARP's operation. Because FM radios are limited by line of sight and range, the distance and/or location of the FARP may prevent FARP personnel from monitoring and/or transmitting on the designated command frequency. In such cases, using aircraft as retransmission or relay is an option as long as the factors of METT-TC are considered. These radios should be used to transmit only when—

- The FARP is under attack.
- The FARP relocates or ceases operations.
- The FARP is not operational at the scheduled time.
- A request is made to resupply Class III/V products.
- The status of the FARP changes. (In this case, the radio is used to report damage or contamination.)

2-18. The tactical situation and SOP will dictate the use of radio frequencies. When possible, outbound aircraft should relay critical messages from the FARP to unit headquarters or unit trains. This will help prevent the enemy from electronically pinpointing the FARP's location for attack. FARP reports and other communications should be made in person.

This page intentionally left blank.

Chapter 3

Forward Arming and Refueling Point Utilization

The FSC/DISTRO must be prepared to sustain aviation forces with fuel and ammunition during maneuver and tactical enabler missions. The success of the aviation mission is directly related to the effectiveness of the FARP and the personnel who run it. This success depends on planning and coordination before FARP operations begin. This chapter discusses employment factors, refueling and arming operations, aircraft flow and mix, and training.

SECTION I – EMPLOYMENT FACTORS

TYPES OF FORWARD ARMING AND REFUELING POINTS

ACTIVE

3-1. The active FARP is normally located in the main battle area closer to the area where operations are being conducted. It provides fuel and ammunition necessary for the employment of aviation maneuver units in combat. The active FARP conducts refueling and rearming operations and permits combat aircraft to rapidly refuel and rearm simultaneously.

SILENT

3-2. For longer missions, units employ a FARP with additional displaced FARPs (called silent FARPs until activated) waiting to assume the mission at preplanned times or decision points (DPs). The silent FARP has all equipment and personnel at the future site, but it is not operational.

JUMP

3-3. A jump FARP may be necessary if the enemy occupies the roads in the area. Air-emplaced jump FARPs support limited resupply behind enemy lines and support mobile strikes involving major air assaults. The jump FARP is employed for a special mission. It is composed of a forward area refueling equipment (FARE), 500-gallon collapsible fuel drums, and/or ammunition (as the mission dictates). The jump FARP is transported and emplaced by ground or air and employed when dictated by time or geographical constraints. It allows the uninterrupted support of attack elements during FARP relocation and resupply.

ROLLING

3-4. The rolling FARP allows aircraft providing convoy security for fuel tankers, ammunition, supplies, and FARP movement to refuel and or rearm at the convoy's location. This minimizes the compromising of security by reducing the travel times associated with returning to the FARP. If time allows, a map reconnaissance of the route should be conducted (figure 3-1, page 3-2).

Contents	
Section I – Employment Factors	3-1
Section II – Forward Arming and Refueling Point Equipment.....	3-21
Section III – Ammunition Operations, Equipment, and Storage	3-32
Section IV – Arming Operations	3-34
Section V – Aircraft Flow and Mix	3-36
Section VI – Training	3-37

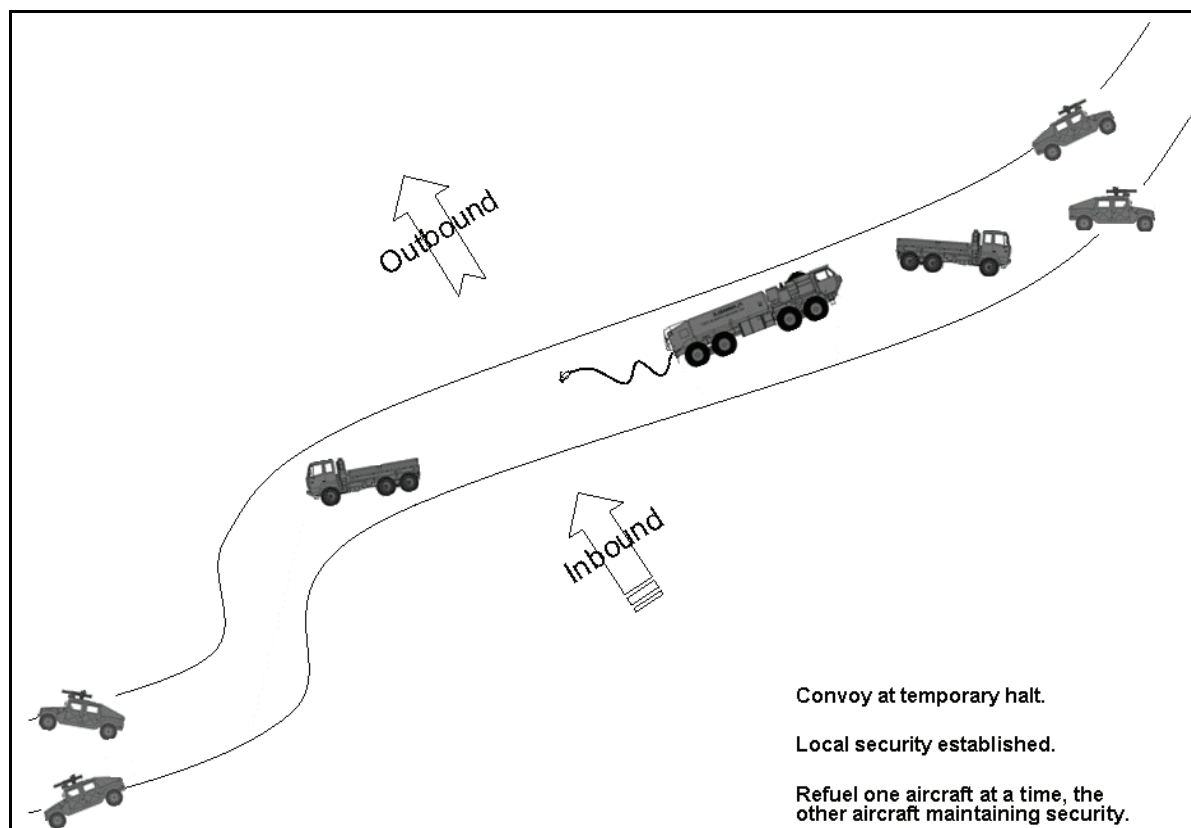

Figure 3-1. Rolling forward arming and refueling point

3-5. The security configuration of the rolling FARP should remain the same as the convoy security. As the convoy comes to a temporary halt, block the road from any traffic entering at each end of the convoy posting armed lead and trail vehicles during the FARP operation. The inner vehicles will provide left and right flank security giving the FARP operation a 360-degree perimeter security.

3-6. Taking into consideration the selected aircraft landing area, determine positions of refueling and rearm point. Ensure 100 feet separation from aircraft to nearest vehicle. Break down ammunition and prepare the load depending on the needs of the aircraft, and reposition vehicle to parking location. Place fuel hose in position. One aircraft will land on the hard surface road for refuel/rearm operations as the other aircraft maintains aerial security. After the first aircraft has rearmed/refueled it will resume aerial security as the second aircraft lands for rearm/refuel. FARP personnel must take safety into consideration because of the hasty nature of this type FARP.

SITE SELECTION

3-7. If time allows, a map reconnaissance and a survey of the proposed site should be conducted before a FARP site is selected. A site survey is critically important; maps may not be current and sites are not always as they are depicted on the map. For example, an open field on a map may actually be overgrown with trees.

3-8. Once ordered to relocate, the FARP elements should begin an orderly movement. After the FARP has been moved, no evidence should remain that the area was ever occupied.

3-9. The advance party breaks down one unit, consisting of one heavy expanded mobility tactical truck (HEMTT) or one FARE/advanced aviation forward area refueling system (AAFARS). Next, it rolls up and packs hoses and refuels the tanker if fuel is available. The advance party then transports, when possible, enough ammunition for two mission loads per aircraft, rolls up the camouflage nets, and sets up

a convoy. The advance party, equipped with CBRN detection equipment, and a security team should be sent to the proposed site to determine its suitability. If the site is not suitable for FARP operations, then time would be available to move the FARP to an alternate location. If the site is usable, the advance party will identify areas for the placement of equipment. Appendix B shows an example of a FARP operations annex to a tactical SOP

3-10. When the convoy is ready, the advance party moves out to the new location. Upon arrival, personnel establish security, conduct a CBRN survey, reconnoiter the site, and perform other tasks outlined in the unit SOP and the applicable Army training and evaluation program publication. If the site is unsuitable or the enemy is nearby, the advance party reports this information to the tactical operations center (TOC). The advance party then requests to move to the alternate site and notifies the remaining FARP elements. When the site is deemed suitable, the advance party:

- Determines the landing direction.
- Determines and marks refuel and rearm points, truck emplacements, and ammunition emplacements.
- Sets up the equipment.

3-11. When the rest of the FARP personnel and equipment arrive, the advance party should guide each vehicle into its position. When determining the site location, the FARP officer in charge (OIC) will take into consideration the following:

- Tactical dispersion of aircraft and vehicles, such as ingress and egress routes.
- Brownout condition.
- Tree lines.
- Vegetation, such as scrub brush, small trees, and dried grass and leaves.
- Shadows.
- Built-up areas.
- Weather condition, such as fog, cloud cover, rain, snow, and prevailing winds.
- Gullies that could fill quickly during flash floods.
- Marsh areas.
- Site is clear of debris, such as sticks, stones, and other potential flying objects.
- Use of pierced steel planking or other suitable material.

ENGINEERING CONSIDERATIONS

3-12. With the advent of airpower and its associated support requirements, engineers have acquired a mission to support aviation assets. If engineer assets are available, they can increase the mobility, counter-mobility, survivability, and sustainment of the FARP. Engineer support is requested through the S-3 at the brigade/battalion responsible for the sector where the FARP will be located. The engineer staff officer will recommend changes about the priority of engineer support to the brigade commander.

MOVEMENT PLAN

3-13. Detailed planning of the move will improve the accuracy of the FARP's operational time. Planning should include details about individual vehicle and trailer load plans. Standard load plans do not exist for current equipment because equipment varies in each unit's modified table of organization and equipment (MTOE); although the Army is moving toward standardizing MTOEs of like battalions. Additionally, the varying Class V requirements for different missions will greatly affect vehicle load plans. Appendix C contains suggested load plans.

3-14. In a FARP convoy, the platoon should use concealed routes as much as possible. Leaders should be aware and knowledgeable of improvised explosive devices (IEDs). They should brief the convoy on the seriousness of their threat. If the FARP is attacked from the air while moving, vehicles should turn 90 degrees from the direction of the attack. (Aircraft normally attack parallel to the movement of a convoy.) This countermeasure quickly removes vehicles from the line of fire.

Chapter 3

3-15. Air guards should be posted on vehicles and in dismounted positions to warn of approaching aircraft. They should be rotated often because scanning for long periods dulls an individual's ability to spot approaching aircraft. Vehicle horns are the standard method of warning for an air attack.

EMPLACEMENT

MISSION, ENEMY, TERRAIN AND WEATHER, TROOPS AVAILABLE, TIME AVAILABLE, CIVILIAN CONSIDERATIONS

3-16. The FARP location is METT-TC dependent and a function of the battalion S-3. The FARP should be located as close to the AO as the tactical situation permits. The intent is to reduce the distance or time traveled for the aircraft, thereby increasing aircraft time on station while simultaneously striking a balance that exposes the FARP to the least possible risk. Aviation's ability to move quickly also requires that the FARP be able to move quickly to maintain support.

Mission

3-17. Today's missions are focused on noncontiguous battlefields. The paragraphs below give guidance for future FARP operations on a linear, nonlinear, or noncontiguous battlefield.

3-18. The employment of the FARPS is METT-C dependent. Commanders can employ and configure their assets as the mission dictates to complete the mission requirements. The commander can choose to have one large FARP or several small FARPs. The attack battalion can employ three FARPs under the modular design (three sections of Class III and three sections of armament personnel) and so can the remaining battalions (three sections of Class III-rapid refueling points, rocket and missile armament not required). Each battalion owns a FSC that is modular (three sections), except for the ASB, which has a distribution section. The CAB in its entirety can setup a maximum of 12 FARPs and one ASB refuel point to operate in a division area, supporting three BCTs. Also, the attack, assault, and GSABs can be augmented by the ASB and the use of Fat Cow (extended range fuel system [ERFS]/ERFS II) and Fat Hawk/Wet Hawk operations to enhance Class III/V requirements. In most other circumstances, aircraft could rearm and refuel at FARPs within the close area. If a FARP must be located behind enemy lines, the following factors should be considered:

- The composition of the FARP should be austere.
- Security will be limited because the FARP will be emplaced for a very short time.
- A thorough map reconnaissance and intelligence update must be accomplished for the area.
- A helicopter with a sling load cannot fly nap-of-the-earth (NOE), which puts it at greater risk and broadcasts the unit's intentions.

3-19. The FARP is located as close to the AO as the tactical situation permits. It is usually located as far forward as 18 to 25 kilometers (METT-TC dependent) behind the forward line of own troops (FLOT) or METT-TC dependent on a nonlinear battlefield. This distance increases aircraft time on station by reducing the travel times associated with refueling. If possible, the FARP is kept outside the threat of medium-range artillery. Movement and resupply of the FARP are conducted by ground or aerial means. The FARP should remain in one location for only 3 to 6 hours; however, these times may be reduced by the factors of METT-TC. The size of the FARP will depend on the number of aircraft that will use the FARP and the type of refueling equipment (FARE/AAFARS or HEMTT) that is available. Four to eight refueling points are normally sufficient for continuous mission sustainment. Appendix D provides multiple FARP missions and schedules.

3-20. The aviation brigade provides rapid reaction force that can quickly shift its effort and engage enemy forces in the rear area. Depending on their distance from other supply facilities, aviation units in the rear may require FARP support. A FARP located in the rear will probably remain in one location longer than the recommended 3 to 6 hours. If so, the FARP must be hardened and have adequate security. Movement and resupply of the FARP can be accomplished by ground or aerial means.

3-21. Ground and air maneuver forces strike decisive blows. Ammunition palletized load system (PLS) trucks with mission-configured loads push supplies down to the close area where FARP elements meet them at logistics release points (LRPs). When possible, the FSC commander coordinates for direct delivery to the silent FARP to avoid transloading. Units travel to supply points for fuel or receive throughput from higher echelon 5,000-gallon tankers for transloading. Mobile strikes, operations in deep areas, special operations, and air assaults characterize these operations. The aviation brigade's aircraft conduct operations in deep areas using extended-range fuel tanks so that only Class V FARP support may be necessary behind enemy lines. Special operations aircraft also may require Class V support. Air assault mission aircraft often employ extended-range fuel tanks but may need limited Class V support for armed aircraft providing assault security.

3-22. Air-emplaced jump FARPs support aviation brigade reaction aviation forces as they attack Level III rear threats to sustainment. Airheads and base camps support stability and reconstruction operations and initial deployment aviation needs at intermediate support bases. Cargo helicopter (CH)-47D and utility helicopter (UH)-60A/L aircraft conduct air movement to supplement ground-emplaced FARP activities and emplace jump FARPs supporting aerial resupply of ground forces in shaping operations in deep areas. The versatility of the aviation brigade makes it ideally suited to support sustainment operations. The ARB usually emplaces a FARP using its combat trains. At this site, rearming and refueling operations take place for a specific mission. When that mission is complete, the air assets transition to the fixed FARP site in the rear to reconfigure ammunition loads, refuel, and perform the required maintenance in preparation for other missions. Figure 3-2 shows a typical disposition of theater and division Class III/V products.

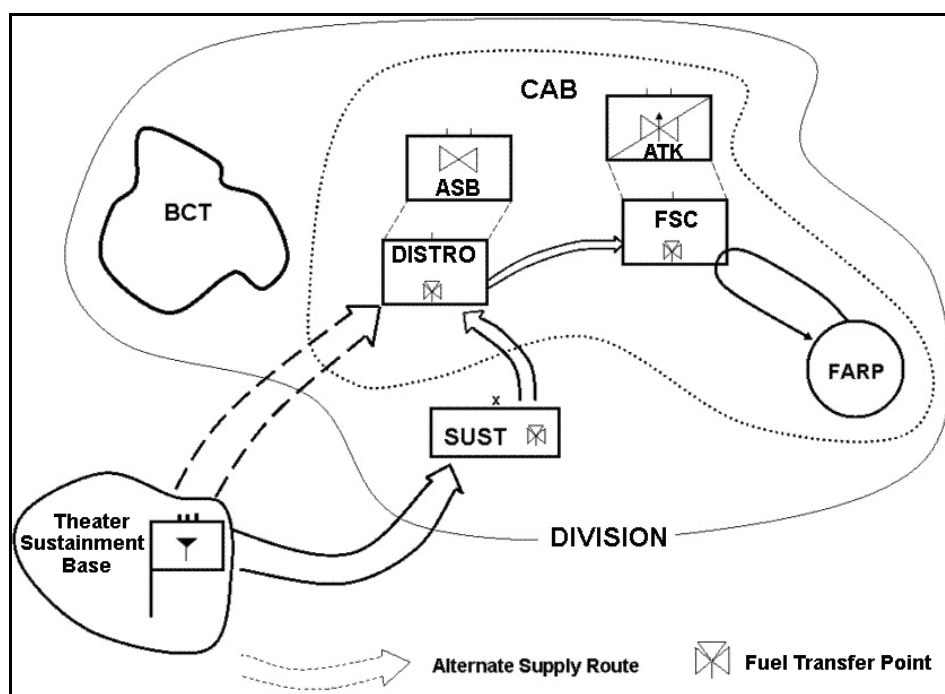

Figure 3-2. Typical disposition of theater and division class III/V products

Enemy

3-23. The S-2 is responsible for determining the type of threat the FARP is likely to encounter in a certain location. This includes the enemy's capabilities, posture, and weapon systems. For example, a FARP located in the close area may encounter an enemy reconnaissance element. A FARP in the rear area may be the target of special operations forces. The S-2 also determines the type of intelligence-gathering devices and sensors that the enemy has oriented at the proposed FARP location.

Chapter 3

Terrain and Weather

3-24. During terrain analysis the following effects must be taken into consideration, including weather:

- Tactical dispersment of aircraft and vehicles.
- Terrain folds and reverse slopes for cover and concealment.
- Ground main supply routes.
- Air avenues of approach, such as ingress and egress.
- Sand.
- Snow.
- Heat.
- Flash floods.
- Gullies filling with water.
- Tornadoes.
- Lightning.
- Wind.

3-25. Terrain in the urban environment is severely limited and suitable FARP locations are rare. Aviation units must take a detailed look at urban areas and locate potential sites for FARP operations. Leaders should take the following into consideration:

- City maps.
- Overhead imagery.
- Reconnaissance flights.
- City parks, parking lots, stadium fields, and athletic fields.
- Major highways and large multi-lane roads.
- Lighting.
- Increased security.
- Civilian activity.
- Hazards to FARP operations, such as antennas, light poles, debris, and wires.
- Buildings.

Note. Consider placing the FARP on a hard surface to minimize the possibilities of a brown out condition.

Troops Available

3-26. The FSC commander must determine if enough troops are available to operate the desired size and number of FARPs and to complete resupply deliveries in the allotted time. Also, the proper personnel skills must be available in the proper numbers. For example, MOSs 15J, 15X, and 15Y personnel are school-trained to arm and repair weapon systems. Other personnel at unit level must be cross-trained to fuel aircraft and load weapon systems, but they cannot be cross-trained to perform specific repair functions. Depending on the location of the FARP, the number of soldiers required to provide security will vary. In most cases, the FARP will provide its own security.

Time Available

3-27. Mission duration is a critical planning factor. Longer missions require either multiple FARPs for different phases of the mission or a mid-mission FARP displacement combined with Class III/V throughput to a new FARP location.

3-28. Planners must consider how long it will take to drive or fly to the proposed FARP site. They must allow sufficient time for FARP setup and consider how far the FARP is from the supply points. They

either plan supply throughput or arrange for a second silent FARP to go active to support the next phase of the mission.

Civilian Considerations

3-29. Civil considerations relate to civilian populations, cultures, organizations, and leaders within the AO. Commanders consider the natural environment, to include cultural sites, in all operations directly or indirectly affecting civilian populations. Commanders include civilian political, economic, and information matters as well as more immediate civilian activities and attitudes.

3-30. At the operational level, civil considerations include the interaction between military operations and the other instruments of national power. Civil considerations at the tactical level generally focus on the immediate impact of civilians on the current operation; however, they also consider larger, long-term diplomatic, economic, and informational issues. Civil considerations can tax the resources of tactical commanders while shaping force activities. Civil considerations define missions to support civil authorities.

3-31. Political boundaries of nations, provinces, and towns are important civil considerations. Conflict often develops across boundaries, and boundaries may impose limits on friendly action. Boundaries, whether official or not, determine which civilian leaders and institutions can influence a situation. These considerations can be important at all levels.

3-32. The local population and displaced persons influence commanders' decisions. Their presence and the need to address their control, protection, and welfare affect the choice of courses of action and the allocation of resources. In stability operations and support operations, these people are a central feature of AOs.

GROUND VEHICLES

3-33. FARPs are normally emplaced using ground vehicles that carry bulk quantities of Class III/V products. Ground vehicles are the primary means of displacing and resupplying the FARP. Ground mobility offers the advantages of moving and positioning large amounts of bulk petroleum, oils, and lubricants (POL). However, ground-mobile FARPs have several disadvantages when emplacing FARPs, such as limited rapid positioning of FARPs, subject to road and traffic conditions, and vehicle accessibility terrain limits. At mission completion, empty vehicles must return to distant supply points before they are available to emplace a new FARP. The same vehicles transporting the FARP normally accomplish resupply. If a single vehicle is lost, the success of the mission may be jeopardized. Therefore, a backup operation must be planned.

3-34. The advantages of using small ground vehicles, such as the HMMWV, as a FARE platform to emplace the FARP are mobility, maneuverability, and ease of concealment. The disadvantage is that additional support is required to complete the FARP package.

3-35. The 3/4-ton trailer offers the FARP a tremendous capability. The entire FARE system (pump and filter/separator) can be bolted to the frame. When set up, this system provides an extremely mobile refueling capability. The system is light enough to be transported by HMMWV or sling load by UH-60. To complete the FARP package, fuel and ammunition can be emplaced by air or ground.

3-36. Another advantage of the HMMWV is that it can transport ammunition from the cargo truck to the armament pad. It can also move the 500-gallon collapsible fuel drums around the FARP, if the collapsible fuel drum tow assembly is available.

3-37. The HEMTT (M977) and the HEMTT tanker (M978) are the primary movers of Class III/V supplies to the FARP (figure 3-3, page 3-8). The M977 can carry 22,000 pounds of cargo. An onboard crane mounted on the rear of the vehicle has a 2,500-pound lift capability. The crane enables the HEMTT to load and off-load ammunition without the need for MHE. The M978 tanker holds 2,500 gallons of fuel and provides two refueling points. When paired with the HEMTT tanker aviation refueling system (HTARS) and the AAFARS (see AAFARS, B-7), the M978 can simultaneously refuel four aircraft. When two M978 trucks are positioned properly you can run an eight-point refueling operation. Leadership must

Chapter 3

ensure that proper manning and equipment assets are forecasted. The heavy expanded mobility ammunition trailer (HEMAT) (M989) is used with the M977 or M978. It can carry 22,000 pounds of ammunition. The HEMAT can also carry four 500-gallon collapsible drums or two 600-gallon pods of fuel. Generally, one armament HEMTT with HEMAT can support up to four OH-58D or three AH-64 aircraft.

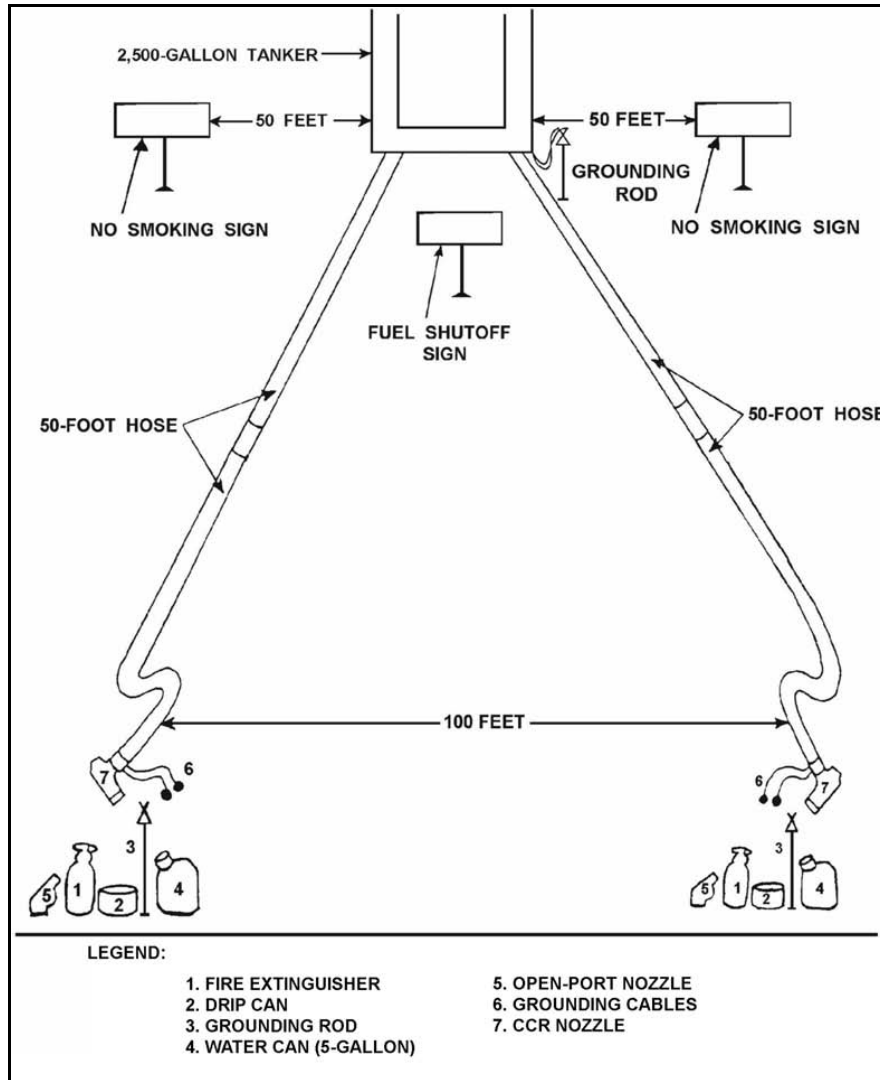

Figure 3-3. Heavy expanded mobility tactical truck forward arming and refueling point layout

3-38. The 5-ton truck can transport either ammunition or fuel. When it transports fuel, the truck is normally set up with a tank pump unit (TPU) consisting of two 600-gallon fuel pods and refueling equipment for two fuel points. The 5-ton truck also can tow a 1 1/2-ton trailer with either a 600-gallon fuel pod or a 500-gallon fuel drum, or the trailer can be used to transport ammunition.

AIRCRAFT DELIVERY

3-39. Emplacing FARPs by air offers three major advantages.

- The FARP can move about the battlefield much faster by air than by ground.
- Nearly every open field becomes a potential FARP site.
- It is generally more practical, from a threat perspective, to air emplace FARPs in support of shaping operations in deep areas.

3-40. Air emplacement of the FARP has the following disadvantages:

- Aerial emplacement depends on availability of supporting aircraft. If the enemy is advancing and no utility or heavy helicopters are available for FARP displacement, the entire FARP can be lost.
- Requires dedicated aircraft to move bulk quantities of Class III/V products and MHE.
- Additional aircraft traffic could compromise the FARP's location, increasing the likelihood of an enemy attack.
- Aircraft that are sling loading equipment and supplies cannot fly NOE and are more visible to enemy sensors and missiles.
- If the FARP is contaminated by CBRN attacks, it cannot be moved until it has been decontaminated or the commander must accept the contamination of support aircraft and the spread of contamination to clean areas.

Jump Forward Arming and Refueling Point

3-41. Two UH-60s can deliver an austere jump FARP to its new location. One UH-60 can carry up to two 500-gallon collapsible fuel drums and part of the FARP crew. The other UH-60 transports the rest of the FARP and sling loads the FARE or the AAFARS, which may be mounted on a 3/4-ton trailer. If the FARE or AAFARS is mounted on the trailer and the sides of the trailer are built up with wood, to include a cover, then some ammunition can also be transported. This ensures that the jump FARP will have some ammunition as well as fuel at the scheduled time. The UH-60s can then transport the bulk of the ammunition required for the mission in a second lift as well as additional fuel drums. A UH-60 can sling load three Hellfire pallets at once for a total of 27 missiles.

Fat Cow

3-42. The CH-47's ERFS or ERFS II, better known as Fat Cow, is a modular, interconnectable system. The primary mission is to provide a safe and convenient means of increasing the range and endurance of the CH-47D helicopter to include worldwide self-deployment capability and transporting fuel for forward area refueling operations.

3-43. The operational advantages of the Fat Cow are the following:

- The CH-47 is an instant FARP. Once the CH-47 is on the ground, the system can be rapidly employed.
- The Fat Cow is especially useful for deep operations.
- When refueling operations are completed, FARP equipment is packed up, the CH-47 takes off, and the site is cleared within minutes.
- The Fat Cow may also be pressure refueled for faster turnaround missions.

3-44. The operational disadvantages of the Fat Cow are the following:

- A safety hazard may be created if the blades are turning on the aircraft during refueling.
- Due to additional weight of fuel, the CH-47 fuel burn rate increases tremendously.
- The signature of the CH-47 makes the operation vulnerable to detection and attack.

Extended Range Fuel System

3-45. This system can provide up to 2,320 gallons of fuel to refuel other aircraft. When using the FARE or AAFARS with the CH-47 aircraft, two refueling points can be employed at approximately 200 feet apart. Any additional distance can be obtained by adding fittings and hoses.

3-46. Figure 3-4, page 3-10, shows the configuration of the ERFS for the CH-47. With the ERFS, little space for cargo and passengers remains. Each side of the aircraft can seat four people. Figure 3-5, page 3-10, shows the proper placement for the rest of the required equipment to include the FARE/AAFARS. With a Army Command seats out waiver, units can transport additional FARP or security personnel. (See Army Regulation [AR] 95-1.)

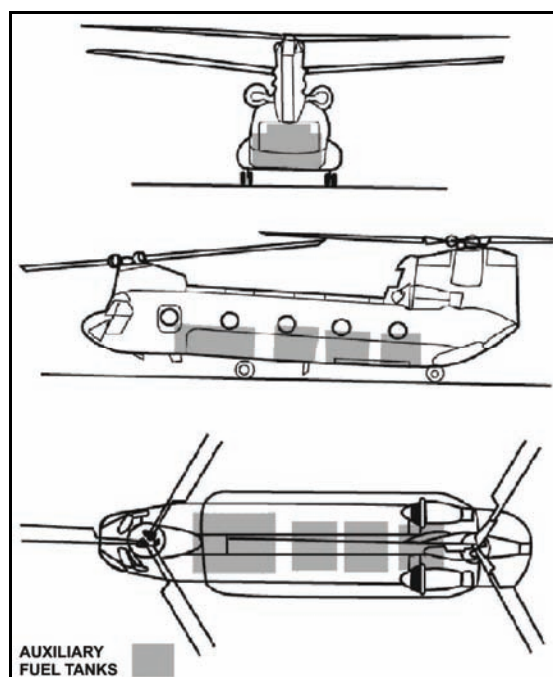

Figure 3-4. Configuration of the extended range fuel system (fat cow)

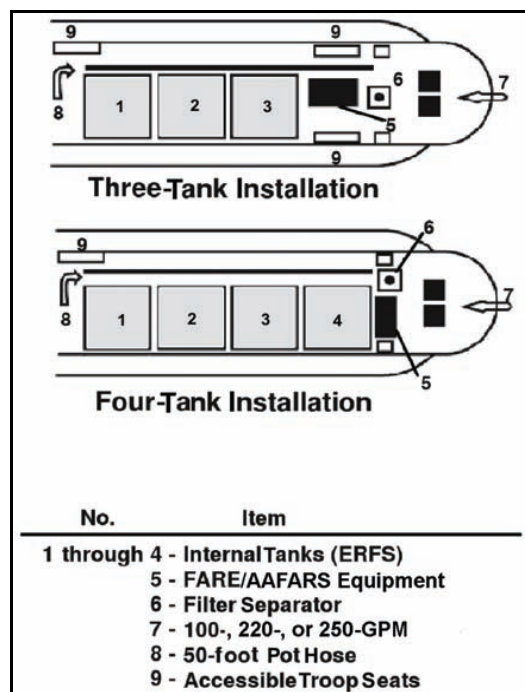

Figure 3-5. Gear board

Note: The ERFS is airworthy when it is installed, operated, and maintained as described in Technical Manual (TM) 55-1560-307-13&P. With this configuration, however, fuel can leak into the cabin and a catastrophic incident can occur in case of a hard landing or an accident. When the noncrashworthy ERFS is installed, the potential for fires during a crash increases.

Forward Arming and Refueling Point Utilization

3-47. After the aircraft lands, the fuel pods can be used to set up refueling points quickly. Figure 3-6 shows how the refueling points may be set up. However, the actual setup will depend on the equipment available.

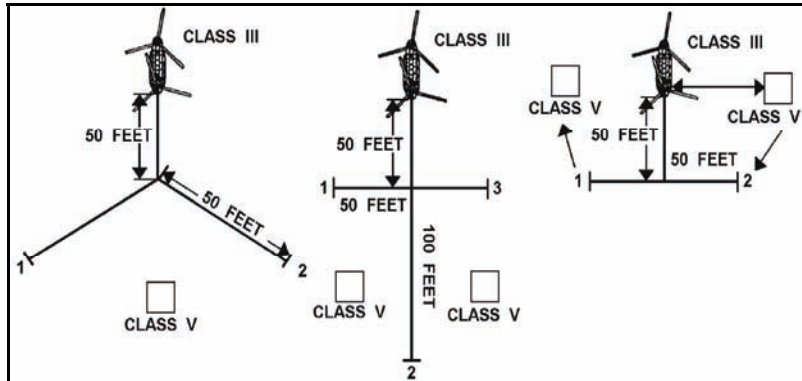

Figure 3-6. Refueling point setups

3-48. Figure 3-7 shows how the refueling points may be set up.

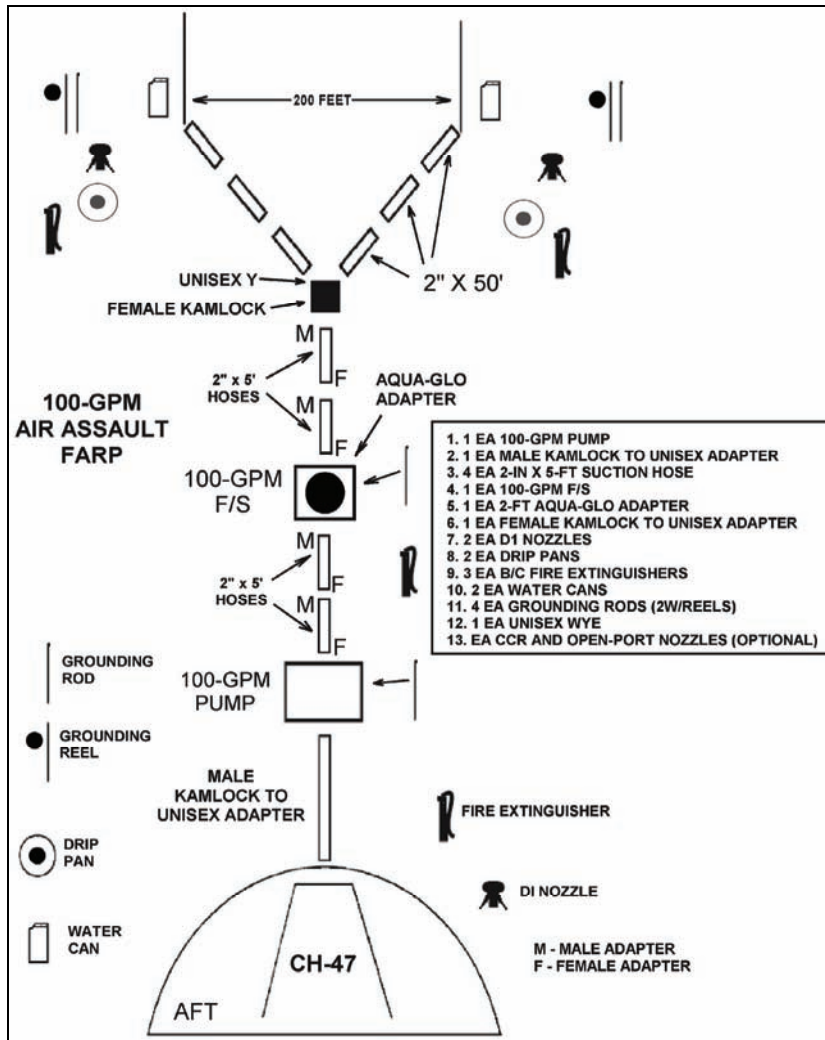

Figure 3-7. Extended range fuel system layout configuration

Chapter 3

Extended Range Fuel System II

3-49. ERFS II is an autonomous system (figure 3-8); the power to operate both types of pumps is supplied by the helicopter electrical system. Unlike the ERFS, the FARE transfer is accomplished by a pump rated at 120 gallons per minute (GPM) located on the aft tank of the ERFS II (figure 3-9). The pump supplies two refueling points 200 feet from the helicopter (figure 3-10, page 3-13). The ERFS II provides the CH-47D with up to 2,400 U.S. gallons of auxiliary fuel for worldwide self-deployment or tactical forward area refueling. For mission flexibility, one, two, or three tanks (each with a capacity of approximately 800 U.S. gallons) can be installed. Regardless of configuration, the principles of operation remain the same. (See TMs 1-1560-312-10 and 1-1520-240-10.)

Note: The ERFS II is crashworthy and ballistically self-sealing when it is installed, operated, and maintained as described in TM 1-1560-312-10.

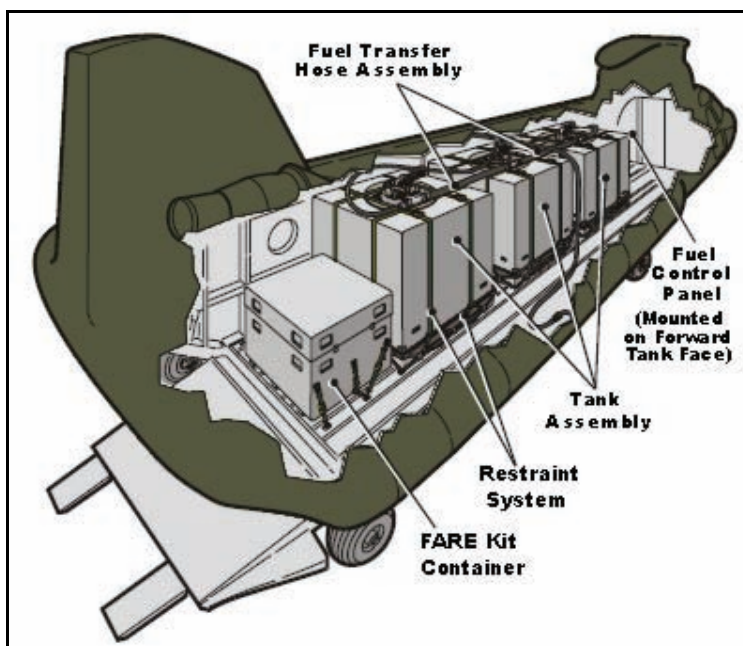

Figure 3-8. Extended range fuel system II functional components



Figure 3-9. Forward area refueling equipment kit assembly

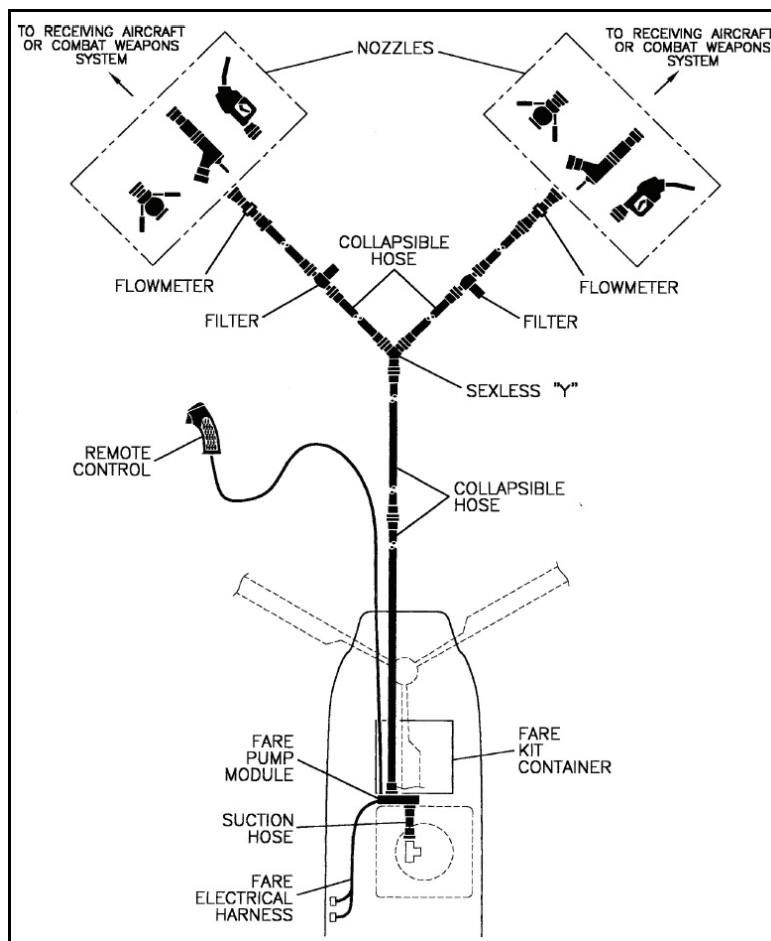

Figure 3-10. Configuring the forward area refueling equipment components

Wet Hawk/Fat Hawk

3-50. Similar refueling operations can be accomplished with the UH-60. The FARE is carried inside the aircraft while the two 500-gallon drums are sling loaded. Advantages and disadvantages that apply to this operation also apply to the ERFS operation. (Refer to TM 55-1560-307-13&P for additional information.)

- A Wet Hawk is a UH-60 that provides fuel to another aircraft from its own internal or external fuel tanks via a micro-FARE system.
- A Fat Hawk is a UH-60 that provides both fuel and ammunition.
- The absence of an external load increases UH-60 survivability, reduces emplacement time, and limits enemy capability to target the FARP.
- Normal operations consists of two external stores support system (ESSS) equipped UH-60 aircraft with full crew, three to four POL personnel, a combat lifesaver/medic, security personnel, armament personnel, and armament and refuel equipment to support the mission.

JOINT AIRCRAFT ASSETS AVAILABLE FOR REFUEL AND RESUPPLY

3-51. If the brigade or battalion assembly area (AA) is located at an airfield base camp or forward operating base or if an austere airfield is available, units may be able to request joint fixed-wing refuel/resupply support.

3-52. Marine Corps CH-53s have a unique refueling capability that can support supply points, operations in deep areas, and other specialized mission applications. Marine Corps CH-53 units are equipped with

Chapter 3

the tactical bulk fuel delivery system (TBFDS) that includes one to three 800-gallon internal fuel tanks and a 120-GPM refueling system, allowing transport of 800, 1,600, or 2,400 gallons of fuel. However, the fuel system is tied into the aircraft's main fuel tanks, allowing delivery of additional fuel. Because the CH-53 can air refuel, it can quickly join with a KC-130 at altitudes as low as 500 feet above ground level to replenish TBFDS tanks and rejoin the ground FARP or fuel supply location to replenish additional aircraft (figure 3-11).

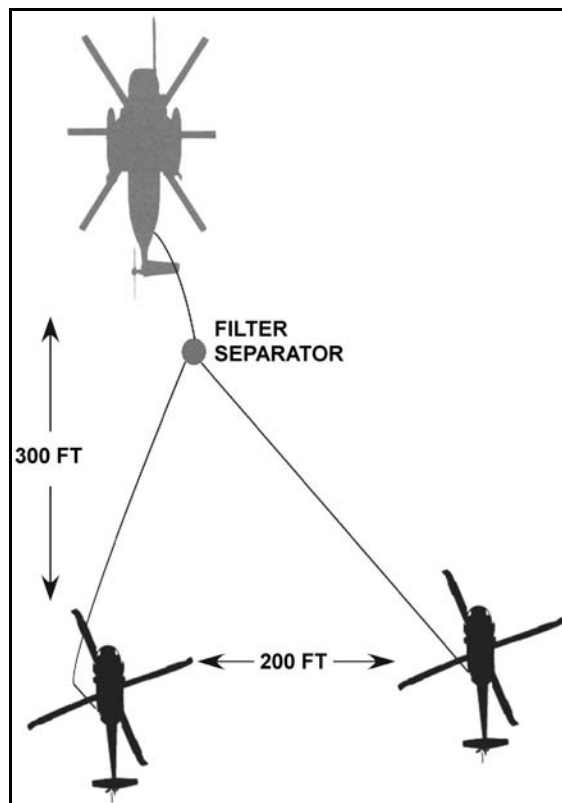

Figure 3-11. Heavy expanded mobility tactical truck tanker aviation refueling system configuration and additional components for CH-53 forward arming and refueling point

3-53. The Marine Corps KC-130F/R/T/J models are equipped for airborne refueling but also rapid ground refueling of Marine or, in this case, Army helicopters and ground vehicles. Aircraft refuel from wing fuel and pods mounted under the wings. They also can carry a 3,600-gallon stainless steel tank inside the cargo compartment for additional fuel delivery. Older model KC-130s require this cargo compartment tank for refueling and can only transport 5,588 gallons in wing and wing-pod fuel tanks. The new KC-130J can deliver up to 8,455 gallons from wing pods and wing fuel and an additional 3,600 gallons from the cargo compartment tank. It can also refuel without the cargo compartment tank, allowing palletized ammunition and other supplies to be transported. It has its own pumps and hoses that can dispense up to 300 GPM from each pod (figure 3-12, page 3-15).

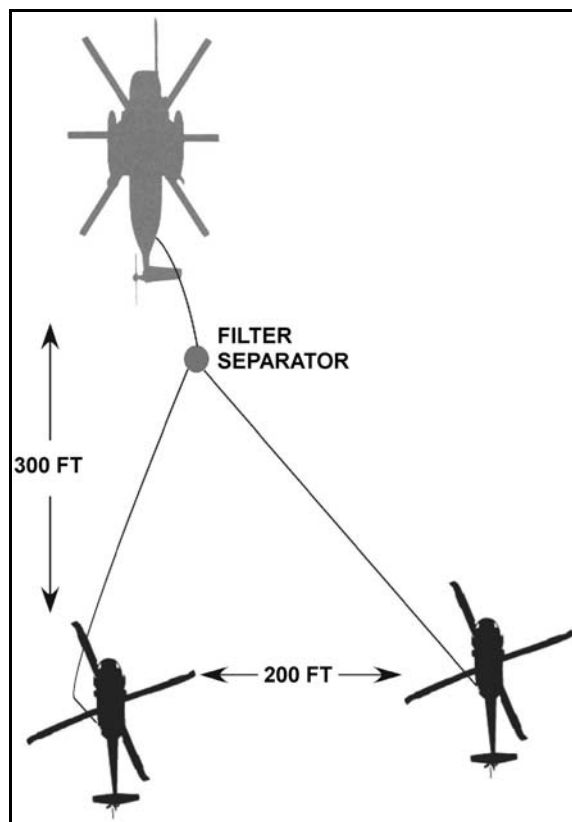

Figure 3-12. Heavy expanded mobility tactical truck tanker aviation refueling system configuration and additional components for KC-130 forward arming and refueling point

3-54. The United States Air Force (USAF) C-17 also can function as a tanker providing fuel to ground receivers using HTARS. The receivers can be Army aircraft, trucks, bladders, or other equipment. The C-17 can deliver fuel through either one or both of its single-point receptacles. The C-17 booster pumps defuel the aircraft using the HTARS and additional Army components. Aircraft can defuel at a rate of 520 GPM, depending on the number of booster pumps (figure 3-13, page 3-16).

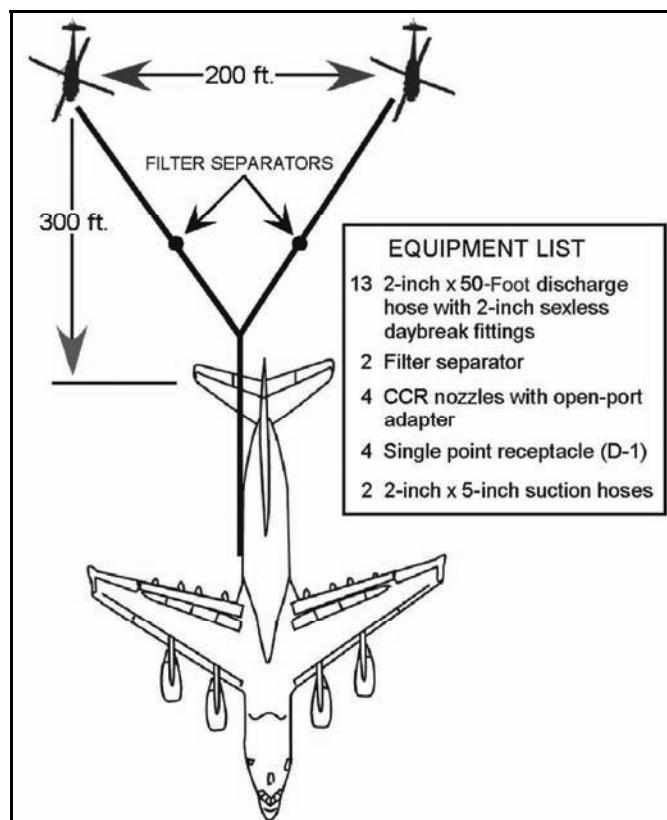

Figure 3-13. Heavy expanded mobility tactical truck tanker aviation refueling system configuration and additional components for C-17 forward arming and refueling point

SITE CONSIDERATIONS

3-55. The KC-130 or C-17 can operate from small airfields with limited supporting infrastructure. The airfield runway must be 3,000- to 5,000-foot long and 90-foot wide. The KC-130 and C-17 do not require paved runways. Graded and compacted gravel or clay will suffice. However, if KC-130 or C-17 resupply becomes a primary means of resupply for a forward operating base or base camp airfield—such as occurred in Afghanistan—runway repair requirements will increase, dictating engineer augmentation.

3-56. The CH-53 TBFDS does not require a runway. It requires a large relatively flat area similar in size to that required for CH-47 Fat Cow refueling.

EQUIPMENT LAYOUT

3-57. The CH-53 TBFDS has enough hoses to refuel two aircraft or refuel vehicles located 200 feet away. Hoses run out of the cargo compartment in the form of a “V” in the same manner as a CH-47 Fat Cow. The TBFDS uses the standard D-1 nozzle compatible with Army and other joint aircraft. Army aircraft must approach Marine Corps refueling points hovering at a 45-degree angle with the aircraft fuel port facing the nozzle.

3-58. Marine KC-130s have organic refuel equipment and compatible D-1 nozzles as they perform the same ground mission for Marine helicopters and fixed-wing aircraft. Fuel in the wing-mounted external fuel tanks and internal 3,600-gallon stainless steel tank (if installed) can be dispensed for rapid ground refueling. The aircraft external fuel pods use ram-air turbine-driven fuel boost pumps in each pod.

3-59. Required equipment for the C-17 includes the HTARS, two 100-GPM filter separators, five fire extinguishers, four water cans, and spill containers. Post operation evacuation of fuel lines requires a 100-

GPM pump. FARP or FARE personnel configure the HTARS and additional components as figure 3-12 shows. They lay out the system to achieve minimum safe distance between aircraft.

3-60. To connect system components for the C-17; starting at the supply aircraft, FARP or FARE/AAFARS personnel—

- Connect using a single-point nozzle (D-1 type) and perform a locked nozzle check.
- Connect a 2-inch by 50-foot discharge hose to the nozzle, using the sexless dry break fitting.
- Install a T-fitting to the end of the discharge hose.
- Connect a 2-inch by 50-foot discharge hose to both remaining ends of the T-fitting.
- Connect a 100-GPM filter/separator, after these lengths of hose.

3-61. Lay out the remainder of the HTARS into a modified configuration, resulting in two refueling points, separated by at least 200 feet between points and 300 feet from the C-17. At each refueling point, FARP or FARE personnel—

- Connect the applicable closed-circuit refueling (CCR) or D-1 nozzle.
- Ensure that the sexless fitting valves are in the open position.
- Attempt to manually disconnect the dry break connection after opening each valve. Properly assembled hardware will not disconnect; if it does disconnect, replace the faulty connection.

GROUNDING AND OTHER EQUIPMENT FOR THE C-17, KC-130, OR CH-53

3-62. FARP or FARE personnel—

- Drive a grounding rod into the ground 10 feet from the end of each dispensing hose.
- Loop the dispensing hose back to the ground rod, and hang the nozzle on the ground-rod hanger.
- Connect the clip of the nozzle grounding wire to the ground rod at each point.
- Place a fire extinguisher, a spill container, and a 5-gallon can of water at each point.
- Place a grounding rod at the filter/separator, and connect using the filter/separator grounding wire.
- Place a fire extinguisher at the filter/separators.

OPERATION

3-63. One critical aspect of refueling operation with other service aircraft is that their rules and regulations differ from and supersede the Army's. For instance, Marine doctrine prohibits simultaneous arming and refueling and requires a separation distance of at least 300 feet from separate arming and refueling activities. In addition, while hot refueling is permissible, hot refueling with explosive ordnance on board is not authorized unless approved by Headquarters, U.S. Marine Corps, and Naval Air Systems Command.

3-64. In wartime, attack units may be authorized to refuel while armed. In peace and lesser contingencies, units must disarm, then refuel, then rearm. This restriction effectively requires aircraft to shut down after refueling to preserve onboard fuel. Marine Corps aircraft use jet propulsion fuel, type 5 (JP5). The USAF and Army use jet propulsion fuel, type 8 (JP8). This disparity poses no problem for Army aircraft.

3-65. Unless Marine Corps or USAF regulations supersede the Army's, operate the system in compliance with safety procedures and follow these steps:

- Refuelers guide aircraft into position using coordinated signals; they check with the pilot to ensure that all armaments are on safe.
- Aircrew members, except the pilot, should assist with refueling or as fire guards.
- Refuelers place fire extinguishers near the aircraft and within reach of fuel fill points.
- Refuelers ground the aircraft.
- Refuelers bond the nozzle to the aircraft. They insert the bonding plug into the aircraft plug receiver or attach the nozzle bonding cable clip to bare metal on the aircraft.

Chapter 3

- After bonding the nozzle, refuelers remove the nozzle dust cap and open the fill port.
- Refuelers verify that all valves are open.
- Refuelers signal the refueling supervisor that the point is ready to fuel and open the nozzle and refuel. They do not leave the nozzle at any time during the refueling. They stop the flow of fuel if there is any emergency at the refueling point.
- After the receiving aircraft is full, refuelers shut off the nozzle, disconnect the nozzle from the aircraft, and replace the fuel fill port cover and the nozzle dust cap.
- Refuelers unplug the nozzle-bonding plug and return the nozzle to the nozzle hanger.

3-66. For C-17 refueling, refuelers use a FARE pump to evacuate fuel lines and recover components as follows:

- Close the D-1 nozzle.
- Install the FARE pump 10 feet away from the single point receptacle (SPR) panel.
- Reverse the flow direction of each filter/separator.
- Start the pump and run at idle.
- Recover hoses, starting at the refueling point.
- Stop the pump and disconnect from the tanker aircraft.

ADVANTAGES/DISADVANTAGES

3-67. The advantages of the CH-53 TBFDS, KC-130, or C-17 FARP are the following:

- Ability to deliver bulk fuel to remote areas using small airfields with unimproved runways (no runway for CH-53) and little supporting infrastructure.
- Ability to provide substantial fuel and be set up and operational quickly.
- Useful for selected operations in deep areas using intermediate staging bases or forward operating bases.
- Ability of the CH-53 TBFDS to aerial refuel and rapidly return with additional fuel.
- Ability of joint fixed-wing aircraft can also transport ammunition in the cargo compartment for substantial resupply capability.

3-68. The disadvantages of the CH-53 TBFDS, KC-130, or C-17 FARP are the following:

- It requires diversion of these aircraft from other valuable missions.
- Because of other priorities and the airspace control order (ACO)/air tasking order process, it may require substantial time to request and get approval for such missions.
- The KC-130 or C-17 requires a 3,000-foot by 90-foot minimum runway for landing. Engineer requirements can be extensive if the runway is dirt or clay, and the unit anticipates repeated use.
- The aviation unit operating the FARP must transport personnel and equipment to the FARP site. Marine CH-53s or KC-130s may wish to provide their own refuelers/operators.
- Marine Corps' aircraft refueling regulations prohibit simultaneous arming and refueling activities.

VOLCANO ARMING OPERATIONS

3-69. UH-60 aircraft equipped with the Volcano system require arming in a manner similar to attack reconnaissance helicopters. However, AHBs AMC/Ts lack the arming personnel organic to attack reconnaissance HSCs. Therefore, units must use crew chiefs, combat engineers, or other trained personnel to load and arm Volcano canisters. This level of training is essential for safe arming operations. If the unit forecasts operations, it should request additional engineer personnel for the duration of the operation.

3-70. Loading and arming can occur in the unit AA or near the rapid refuel point. FM 20-32 specifies that, because of more than 1,200 pounds of explosives in 160 mine canisters on fully loaded Volcano aircraft, loading aircraft should position at least 1,000 meters from command posts (CPs), major routes,

and nonessential personnel. If positioning proves impractical in combat, units should exercise feasible caution and avoid potential sources of secondary explosions such as fuel storage areas.

3-71. The total weight of the armed air Volcano system is 2,886 kilograms (more than 6,350 pounds). Because fully loaded Volcano aircraft approach maximum gross weight, ground conditions should be firm or steel/wood planking landing pad should be provided. Armed aircraft should avoid refueling near (within 375 meters) other aircraft. Simultaneous arming and refueling is not necessary or recommended. Obstacles should not hinder takeoff at high gross weight.

3-72. Figure 3-14 shows an example of a site layout for Volcano arming. As with normal FARP operations, fire extinguishers and grounding rods must be available at the arming point. Arming personnel dig a dud pit where they place damaged or misfired canisters. Personnel store live canisters to the front left and right of the aircraft and spent canisters to the rear left and right, taking care to avoid the tail rotor. Personnel and vehicles must avoid areas directly adjacent to the M139 dispensers. Accidental discharge could strike personnel, and mine arming would occur within 2.5 minutes. If such discharge occurs, the aircraft and loading personnel should reposition at least 640 meters away and loading personnel should notify explosive ordnance disposal (EOD) personnel. That distance extends to 1,000 meters if a fire occurs near the live canisters and personnel are unable to extinguish it in a reasonable time.

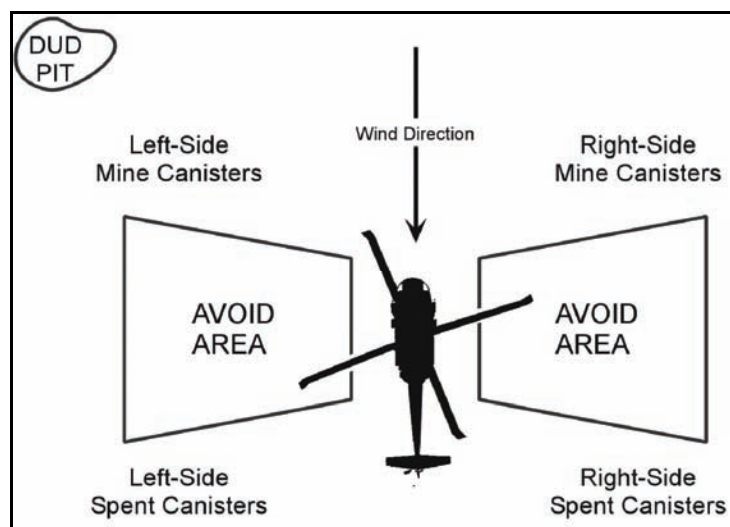

Figure 3-14. Example of a site layout for a volcano arming point

3-73. Each launcher rack functions as a carrier and launcher platform for a 40-mine canister. Aircraft can mount up to four M139 dispenser racks, two on each side of the UH-60. Loaders insert canisters into the 40 keyholes, rows 1 through 4 from bottom to top and columns 1 through 10 from left to right. This loading sequence can be important if the rack carries less than a full load of mines. As loaders insert the mine canisters, a green latch latches the canister to the rack and a red latch arms the canister. The rack has two electric receptacles—one for the power connector and one for the launcher rack cable running to the dispensing control unit.

3-74. After mission completion, aircraft return to the arming point to disarm the users—

- Discard spent canisters at least 30 meters to the left or right rear of the aircraft at the 4- and 8-o'clock positions.
- Return live canisters to ammunition supply points (ASPs) for future use or repackaging.

3-75. Place misfired canisters in the dud pit and contact EOD. The most efficient use of assets combines ground and air capabilities. When time is critical, the FARE/AAFARS, limited quantities of Class III/V products, and required personnel can be aeri ally emplaced. The remaining Class III/V products, MHE, and support personnel can then be moved to the site with ground transportation. The FARP should only be aeri ally resupplied when the expenditure rate exceeds the organic ground support capability of the unit or when the enemy occupies ground resupply routes. Cargo or utility aircraft could temporarily augment

Chapter 3

ground vehicles until the supply flow returns to normal or the enemy no longer threatens the supply routes.

SECURITY

3-76. The FARP should have enough organic security to defend itself against the anticipated threat. Too much security equipment will hinder the movement of the FARP. Adequate security will most often have to be attached to the FARP and will not be organic. For example, a short duration FARP (less than 6 hours) trades security for “austereness.” Long duration “rear area” FARPS will require attached security. Nonlinear battlefields are the same way. However, inadequate security will rob the FARP of its ability to protect itself long enough to move.

3-77. The MP may be tasked to provide detail security to key facilities, assets, and personnel. Other types of critical site security include ASPs; deep-water ports; POL terminals and pipelines; trains and railways; and air bases. The MP may provide convoy security for top-priority units transporting especially critical supplies to combat forces (see FM 3-19.1).

3-78. The unit must coordinate with the operational brigade responsible for the sector in which the FARP is located for AD and, if necessary, ground security to protect the FARP. Normally, the FARP will be integrated into the aviation brigade's AD umbrella. The supported brigade or division may provide Stinger assets for FARP AD. AD assets must be in positions that protect the FARP from aerial attack. For example, the Stinger should be placed 3 kilometers from the FARP. If the FARP is designated a priority target, then division AD assets—such as Bradley M6 Linebacker, short-range air defense (SHORAD), combined arms for air defense (CAFAD), and other forward area weapon systems—are employed near the FARP. These AD assets should cover friendly ingress and egress routes. Checkpoints should be established for friendly aircraft using the FARP to provide positive identification to AD teams. Stinger assets also should be employed to protect the FARP during convoys.

3-79. The advance party may include Stinger assets, CBRN attack monitoring and warning equipment and personnel, and crew-served weapons. The first asset that should be employed is the CBRN attack monitoring and warning equipment. Monitoring equipment must be placed upwind of the FARP site. Using light antitank (AT) weapons can provide a limited AT capability. If available, electronic early warning systems should be placed on likely avenues of approach not covered by listening or observation posts. Quick reaction forces may be formed from attack helicopters in or near the FARP. A quick reaction force may also be formed from nonflying members of the unit that have been organized into a UH-60 transportable quick reaction team.

3-80. If the FARP is attacked, FARP personnel must be able to execute a scatter plan, which includes movement to rallying points. These points increase personnel survivability and allow personnel to regain control of the situation.

RELOCATION

3-81. Several factors should be considered when determining the relocation of a FARP. By definition, the FARP should be temporary, not staying anywhere longer than 3 to 6 hours (unless it is hardened and located in a secure area such as an airhead). When the battle lines are changing rapidly or when the rear area threat dictates, the FARP must be moved often. Otherwise frequent movement of the FARP may not be necessary. Where air parity or enemy air superiority exists, the FARP must be moved often. The FARP should be moved only after it fulfills the support requirements of mission aircraft or if compromised.

Note. If CBRN contaminants exist, equipment should be decontaminated before it is moved from the FARP site.

3-82. A FARP may be relocated for any of the following reasons:

- The FARP comes under attack.

- The order to relocate is received by radio, face-to-face message, or by last unit occupying the FARP.
- A preplanned relocation time has been set.
- A preplanned relocation occurs after a specific event (a decision or target point); for example, after the FARP has serviced a specific company or a specific number of aircraft.

3-83. The message to relocate a FARP is passed in fragmentary order (FRAGO) format and should contain, as a minimum, the following information:

- Eight-digit grid coordinates of the next site and alternate site.
- Time the FARP is to be mission ready.
- Fuel and ammunition requirements.
- Passage-of-lines contacts, frequencies, call signs, and ingress and egress points.
- Enemy situation at the next site.
- March table or movement overlay.
- An LRP to the FRAGO.

3-84. The remaining FARP elements will break down the remaining points. The sequence of the breakdown events will be mission-dependent and SOP-driven. When personnel arrive at the new site, they move into new locations as directed by the advance party and set up the arming and refueling points.

DAMAGED OR DESTROYED ASSETS

3-85. Once the location of the FARP has been compromised, the site must be vacated. The nature of the compromise will determine what can be taken from the site. The refueling equipment must be saved if possible. Without the FARE/AAFARS or HEMTT tankers, getting the fuel out of storage tanks and tankers into aircraft will be difficult. Higher echelon 5,000-gallon semitrailers may need to replace destroyed HEMTT tankers.

3-86. At a minimum, FSC commander should ensure the following actions take place when damaged or destroyed assets occur:

- Report injuries of personnel.
- Report damaged vehicles.
- Report damage to supplies.
- Coordinate with S-4.
- Replace equipment.
- Inform higher headquarters of any changes of FARP site.
- Request emergency support, such as boring equipment or using another battalion's FARP.
- Request alternate arming and refueling instructions.
- Destroy extra equipment according to SOP.
- Inform FARP personnel of priorities.

SECTION II – FORWARD ARMING AND REFUELING POINT EQUIPMENT

FORWARD AREA REFUELING EQUIPMENT

Note. The FARE system is an antiquated system, but will remain in this book until all systems are replaced with the AAFARS, 4930-01-495-0024 and exhausted from the Army's inventory.

3-87. Equipment at the refueling site for the FARE system (national stock number [NSN] 4930-00-133-3041) consists of a pump assembly, a filter/separator, hoses, nozzles, grounding equipment, and valves. Other support equipment that is not a component of the FARE includes the fuel source and the fuel sampling kit.

Chapter 3

3-88. This pump assembly has two hose connections and is rated at 100 GPM. When two hoses are used, actual flow rate may be as low as 50 GPM.

3-89. The filter/seperator provided with the FARE is rated at 100 GPM. It has a working pressure of 75 pounds per square inch (psi).

3-90. Hoses, nozzles, grounding equipment, and valves must be available to support the FARE setup that is envisioned, (that is, the one-point or two-point setup).

3-91. Support equipment includes items such as fire extinguishers, grounding rods, waste cans, 5-gallon water cans, and absorbent material. The FARE system without a fuel source weighs 340 pounds and occupies 64 cubic feet.

3-92. The fuel source is usually 500-gallon collapsible drums. However, other sources may be used. They include 600-gallon pods, 1,200-gallon TPU, 3,000 or 10,000-gallon collapsible tanks, 2,500-gallon HEMTT tanker, 5,000-gallon semitrailer, railroad tank cars, and USAF cargo plane fuel tanks. The fuel sampling kit that should be used is Aqua-Glo Series III (NSN 6630-00-706-2302).

3-93. Skilled, experienced personnel can set up a FARE within 15 minutes of its delivery to a site. The ammunition portion of the FARE can be set up within 45 minutes of delivery to a site. This time includes the unpacking of ammunition. (See FM 10-67-1.)

ADVANCED AVIATION FORWARD AREA REFUELING SYSTEM

3-94. The AAFARS (figure 3-15 and figure 3-16, page 3-23) is a two-man portable system. Its components include a 220-GPM diesel engine pump, a standard element separator, lightweight suction/discharge hoses, and dry-break couplings. The AAFARS is a four-point refuel system providing a minimum of 55 GPM at each refuel point simultaneously. A distance of 100 feet separates each refueling point. There is only a 2-3 GPM pressure drop to the last point of the system. The primary fuel source is the 500-gallon collapsible drum although, like the FARE, the system is compatible with other fuel sources. The key AAFARS function is to simultaneously refuel four helicopters in tactical locations using center point refueling (D-1 nozzle), CCR, or open-port nozzles. The system interfaces with existing Army, USAF, Navy, and Marine Corps aircraft and is interoperable with North Atlantic Treaty Organization (NATO) and other joint, interagency, and multinational nation refuel equipment.

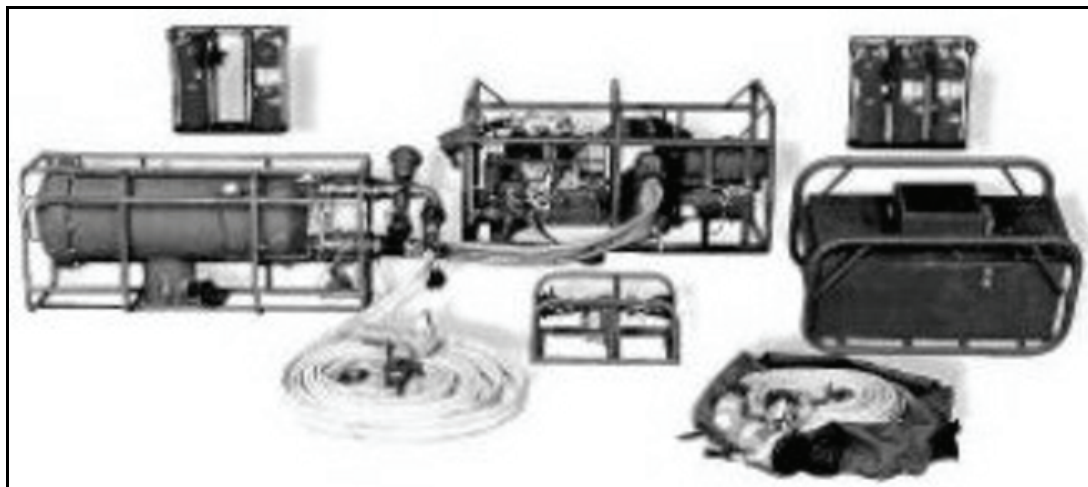

Figure 3-15. Advanced aviation forward area refueling system

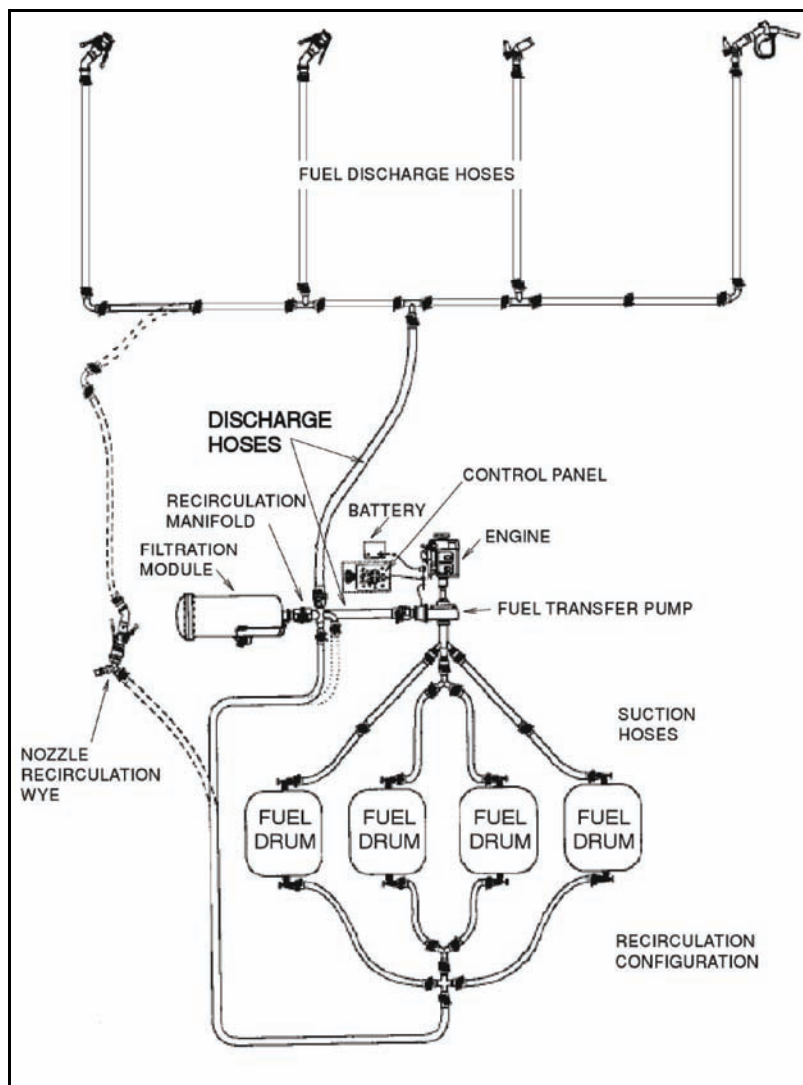

Figure 3-16. Advanced aviation forward area refueling system layout

3-95. The setup of the FARE/AAFARS system should take advantage of terrain features, achieve maximum dispersion, avoid obstacles, and accommodate the type of aircraft the FARP will service. When planning the layout of the FARE/AAFARS system, personnel must consider the minimum spacing required between aircraft during refueling. The spacing will depend on the type of aircraft and its rotor size. Proper spacing reduces the possibility of collision and prevents damage caused by rotor wash. The minimum rotor hub to rotor hub spacing for all helicopters, except the CH-47, is 100 feet. When CH-47s land side by side to refuel, the minimum rotor hub to rotor hub spacing is 180 feet. When they land nose to tail, the minimum spacing required is 140 feet.

3-96. If the area has a prevailing wind pattern, the refueling system should be placed at a right angle to the wind. Thus helicopters can land, refuel, and take off into the wind. The refueling points should also be laid out on the higher portion of a sloped site, not in a hollow or valley. Fuel vapors are heavier than air, and they flow downhill. Also, the fuel source should be kept downwind of the aircraft's exhaust to reduce the explosion hazard. These same considerations apply to any FARP set up with the FARE/AAFARS, 5,000-gallon semitrailer tanker, or HEMTT. Aircraft movement should be limited in desert and snow environments where wind and rotor wash may cause brownout or whiteout. Special considerations will be necessary when aircrews are operating with NVDs. Figure 3-17, page 3-24, shows a FARE/AAFARS setup under various wind conditions.

Chapter 3

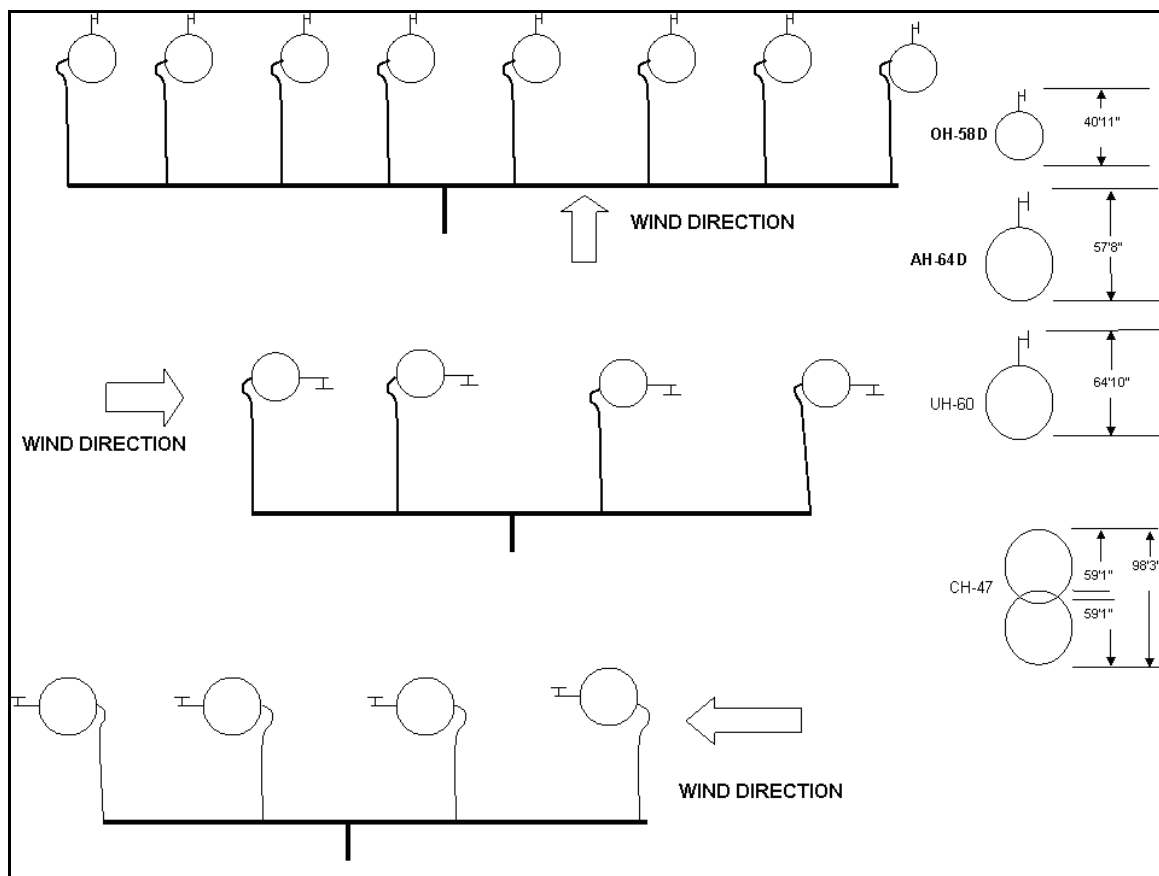

Figure 3-17. Forward area refueling equipment setup under various wind conditions

HEAVY EXPANDED MOBILITY TACTICAL TRUCK TANKER AVIATION REFUELING SYSTEM

CHARACTERISTICS

3-97. The HTARS is a kit that consists of enough hoses, fittings, and nozzles to expand the HEMTT tankers capability to hot refuel up to four helicopters simultaneously using the on-board fuel-servicing pump. The equipment is lightweight, has manually operated controls, and is equipped with valve and swivel adapters that allow connections between camlock and unisex type fittings. See figure 3-18, page 3-25 for unisex connections. This equipment can be used in forward areas. It can be transported in the storage box of the HEMTT tanker.



Figure 3-18. Unisex connections

EQUIPMENT

3-98. The HTARS (NSN 4930-01-269-2273) consists of discharge hoses, valves and fittings, nozzles, and overpack spares. The components of the system are shown in figure 3-19.

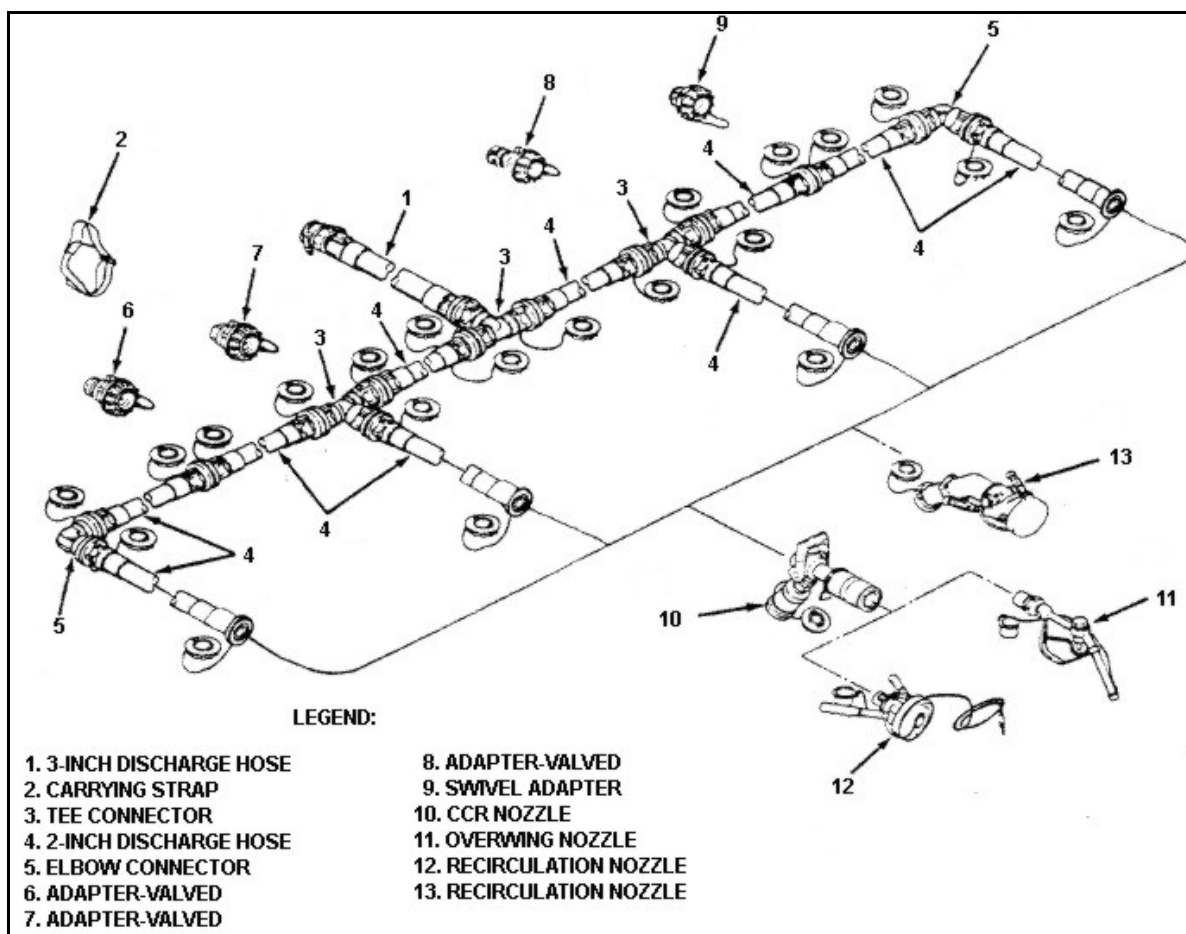

Figure 3-19. Heavy expanded mobility tactical truck tanker aviation refueling system components and layout

Chapter 3

DISCHARGE HOSES

3-99. The system consists of both 2- and 3-inch discharge hoses. One 3-inch by 50-foot hose is used to connect the HTARS to the HEMTT tanker. Ten 2-inch by 50-foot discharge hoses transfer the fuel from the HEMTT tanker to the aircraft. Six hoses are used in the manifold and one in each of the four issue lines. There are 11 carrying straps for easy handling of rolled hoses.

VALVES AND FITTINGS

3-100. The following valves and fittings are components of the HTARS:

- Three T-connectors with a flow control handle to open and close the valve. The T-connector splits the flow of fuel.
- Two elbow connectors to direct the flow of fuel.
- Three valved adapters to connect threaded and unisex parts as well as camlock and unisex parts.
- One swivel adapter to connect camlock and unisex parts.

NOZZLES

3-101. The HTARS is equipped with four types of nozzles. There are four CCR nozzles with unisex adapters used with this system. Four overwing nozzles can be mated to the CCR nozzles to perform open-port refueling. The system has one recirculation nozzle that can be connected to the HEMTT tanker to recirculate fuel in the system. It is equipped with a fuel sample port to obtain a sample of fuel. The recirculation nozzle mates to the CCR nozzle. There are four D-1 nozzles to equip the system for centerpoint refueling.

OVERPACK SPARES

3-102. Each system has one overpack spare with additional parts and accessories. The following parts are in the overpack spares: one T-connector, one 2-inch by 50-foot discharge hose, one carrying strap for easier handling of the rolled hoses, 10 dust seals, two dust caps, and four grounding rods.

OTHER REQUIRED ITEMS

3-103. Other items of equipment are required to conduct aircraft refueling operations with the HTARS. A minimum of five fire extinguishers are required—one to be within reach of the on-board pump and one at each refueling point. The signs described in Chapter 2 will need to be posted at the refueling site. Also, water cans and spill containers will need to be available.

SUPPORT EQUIPMENT

3-104. A fire extinguisher (table 3-1, page 3-27) must be located at each refueling nozzle and at the pump and filter assembly. A water can and a waste fuel pan should be located at each refueling point. This would enable operators to wash fuel off skin and clothes, wash dirt off fuel nozzles, and contain fuel if a spill occurs.

Table 3-1. Portable fire extinguisher types

TYPE	AGENT	EFFECT	USE	EXPELLANT	ELECTRICAL CONDUCTOR	SUBJECT TO FREEZING
Soda-acid	Water	Cooling and quenching	Class A	CO ₂ gas from chemical reaction	Yes	Yes
Antifreeze	Calcium chloride	Cooling and quenching	Class A	Stored pressure, cartridge, or chemicals	Yes	No
Loaded stream	Alkali-metal salts	Cooling, quenching and retarding.	Class A Class B	Cartridge or chemicals	Yes	No
Carbon dioxide	Gas and dry ice	Diluting or smothering	Class B Class C	Self-contained pressure	No	No
Dry chemical	Treated sodium bicarbonate	Smothering	Class B Class C	Gas or cartridge	No	No
BCF	Bromochlorodi-fluoromethane	Interference with chemical chain reaction of fire	Class A Class B Class C	Self-contained pressure	No	No
Purple K	Potassium bi-carbonate	Smothering	Class B Class C	CO ₂ gas	No	No

3-105. A waste fuel pan is required to limit fuel spillage. Fuel spills will be recovered; contaminated soil will be dug up and placed in containers. The containers will be disposed of according to the unit SOP. If the spillage is 50 liters (13.2 gallons) or more, the local facility engineers must be notified. The spillage will also be reported to the environmental protection person, who will determine the actions necessary to retrieve the spillage. Unit SOPs will include a waste fuel plan for all refueling operations during peacetime.

WARNING

All fuel spills will be considered a fire and an environmental hazard.

PERSONNEL REFUELING REQUIREMENTS

3-106. During refueling, one person operates the fuel nozzle, the second remains at the emergency fuel shutoff valve, and the third mans a suitable fire extinguisher. The third person stands outside the main rotor disk of the aircraft at a point where he can see both the pilot at the controls and the refueler with the nozzle. This person may be from the FARP or one of the aircraft crewmembers. Additional personnel may be supplemented from existing assets, or, in a combat situation, METT-TC may override the availability of a third person to operate the fire extinguisher. (See FM 10-67-1.)

3-107. The refueler must wear protective clothing. This clothing consists of a uniform, a helmet, goggles, hearing protection, gloves, and leather boots. Each item is briefly discussed below.

3-108. The uniform is a serviceable, fire retardant flight suit or battle dress uniform. It will be worn with the sleeves rolled down.

Chapter 3

3-109. The HARRP (CTA 50-900) is the authorized helmet. Two versions are available for issue—HGU-24/P (communications-equipped) and HGU-25/P (aural protector only). The helmets are provided in four hat sizes and include eye protection. The cranial impact shells are available in seven different colors and can be used to differentiate between the functions of personnel in the FARP (for example, POL, ammunition, medical, and maintenance personnel). The decision to use different colored cranial impact shells will depend on the factors of METT-TC. If the HARRP is not available, a motorcycle helmet, a flight helmet, a Kevlar helmet, or an infantry helmet is acceptable.

3-110. Sun, wind, and dust goggles (CTA 50-900) will be worn if the HARRP or flight helmet is not available. Ensure goggles are “Splash Proof.” Splash proof goggles will save the unit time and money that’s required to order replacement goggles, due to sand and dust.

3-111. Earplugs, ear protectors, or both will be worn for hearing protection.

3-112. Gloves must be worn at all times during refueling operations. If they become saturated with fuel, they should be replaced. CTA 50-900 lists specific gloves that are authorized for refueling operations.

3-113. The standard rubber-soled, leather combat boots will be worn. Boots will not have heel or toe taps or cleats. Any metal on the sole, to include exposed nails on a worn-down sole, could cause a spark on contact with a hard surface. Fuel vapors are heavier than air; a spark at ground level could cause a fire.

3-114. If a fuel handler's clothes become soaked with fuel, the fuel handler should—

- Discontinue the refueling operation and leave the area immediately.
- Wet clothes with water before taking them off. (If water is not available, the fuel handler should hold onto a grounding rod to prevent sparks when removing his clothes.)
- Wash fuel off the skin with soap and water as soon as possible.

WARNING

If fuel is splashed in the eyes, flush eyes with water and seek medical attention immediately. If fuel is swallowed, seek medical attention immediately.

WARNING

Entering a warm room wearing fuel- soaked clothing can be dangerous. The chance of a fire starting because of static electricity is increased.

REFUELING NOZZLES

3-115. Refueling can be accomplished with the aircraft engines running (hot or rapid refuel) or with the engines off (cold). In a field environment, a unit will normally use the "hot" refueling method. The two hot methods of refueling an aircraft are open-port refueling and CCR.

Note. POL handlers should be aware that the rate at which fuel is pumped differs with each type of aircraft.

OPEN-PORT REFUELING

3-116. Open-port refueling is accomplished with an automotive type nozzle (figure 3-20), which is inserted into a fill port of a larger diameter. It is not as fast or as safe as CCR. The larger port allows fuel vapors to escape. Also, airborne dust, dirt, rain, snow, and ice can get into the fill port during refueling; therefore, the quality of the fuel could be degraded. Spills from overflowing tanks also are more likely. Rapid refueling by the open-port method is restricted to combat or vital training. In these cases, the aviation unit commander makes the final decision. Simultaneous arming and open-port refueling activities will only be conducted when the combat situation and benefits of reduced ground time outweigh the risks involved.

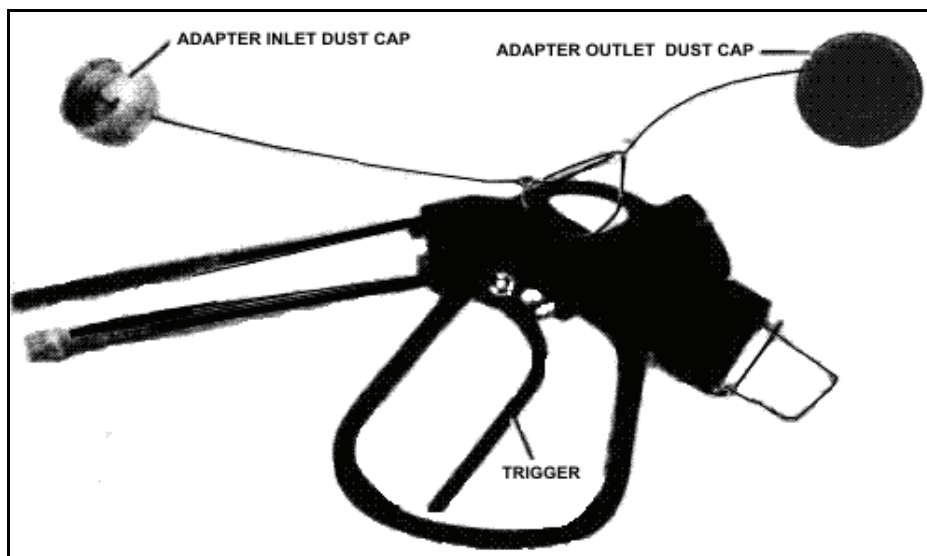

Figure 3-20. Closed circuit refueling open-port (gravity-fill) nozzle adapter

WARNING

As aircraft move through the air, they build up static electricity. Static electricity also builds up on refueling equipment as fuel passes through the hoses. The refueler must ground the aircraft, fuel nozzle, and pump assembly to prevent sparks and explosions. Static electricity buildup is greater in cool, dry air than in warm, moist air.

CLOSED-CIRCUIT REFUELING

3-117. CCR is accomplished with a nozzle (figure 3-21, page 3-30) that mates with and locks into the fuel tank. This connection prevents fuel spills and vapors from escaping at the aircraft fill port and reduces fuel contamination.

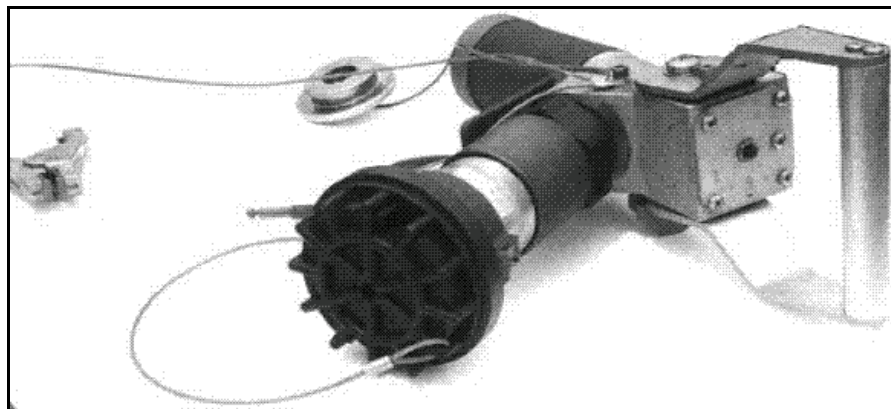

Figure 3-21. Model 125-1000 closed-circuit refueling nozzle

3-118. The Army has two systems—the CCR system and the D-1 pressure system (also called the center point system). The D-1 pressure system components, except for the receiver, are mounted on the M970 (5,000-gallon semitrailer tanker) and M978 HEMTT (2,500-gallon tank vehicle). The system includes a recirculation nozzle (figure 3-22).

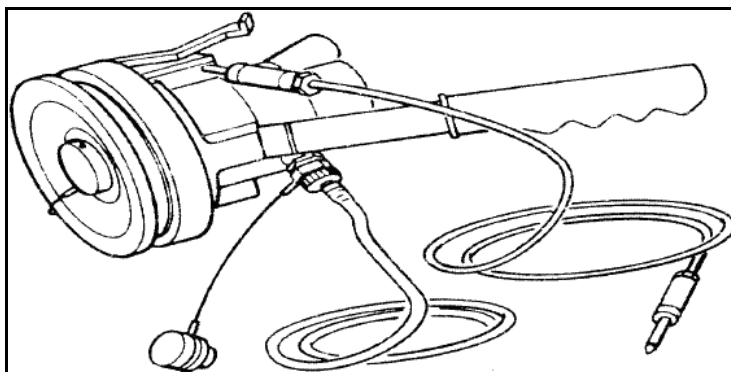

Figure 3-22. Recirculation nozzle

3-119. The main difference between the CCR nozzle and the D-1 nozzle is that the D-1 nozzle (figure 3-23) provides a higher fuel flow rate. Also, the CCR nozzle can be adapted to open-port refueling; the D-1 nozzle cannot. The CCR nozzle is 2 inches wide. The D-1 nozzle is either 2 1/2 inches or 3 inches wide. The CCR provides 100 GPM compared to 150 to 200 GPM for the 2 1/2-inch D-1 nozzle and 300 GPM for the 3-inch D-1 nozzle. (See FM 10-67-1.)

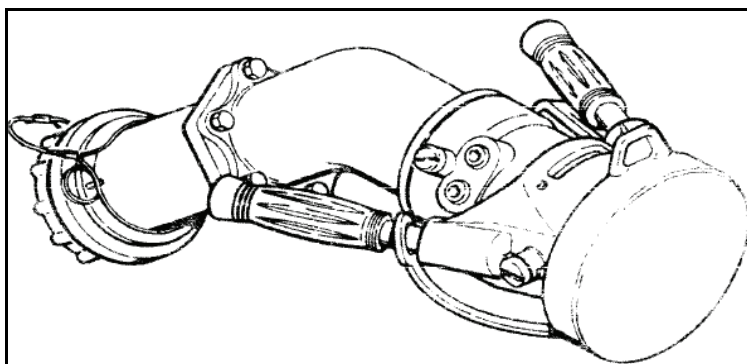

Figure 3-23. D-1 center-point refueling nozzle

Note. The pilot is normally responsible for monitoring the fuel gauge and signaling the refueler when to stop refueling the aircraft.

Note. A 15-psi differential return pressure restricts the fuel flow rate of the AH-64 to 56 GPM during CCR.

EQUIPMENT SETUP

3-120. The following checks must be made to ensure that the refueling equipment is set up properly:

- Check pump assembly and filter/separator for proper grounding.
- Check pump engine for oil leaks and oil level.
- Check filter/separator pressure differential indicators.
- Replace filter elements and drain accumulated water from pump assembly, as necessary.
- Ensure couplings are properly seated and free of cracks.
- Ensure sandbags are used to elevate the couplings.
- Check exterior of the hoses for signs of blistering, saturation, and nicks or cuts.
- Check the hose for weak or soft spots within 12 inches of the couplings.
- Test hose at normal operating pressure.
- Check hose for abnormal twisting or ballooning.
- Ensure nozzles have serviceable couplings and dust covers.
- Ensure refuel points have all required nozzles to conduct closed-circuit and open-port refueling operations.
- Check nozzle filter screen daily.
- Ensure each nozzle has two ground wires. One has an alligator clip on the end of it; it is the grounding cable. The other wire has a plug; it is the bonding wire. These wires are used to connect the aircraft to a 5-foot grounding rod.
- Ensure the nozzle is kept off the ground by hanging it on the grounding rod. See appendix E for FARP safety requirements.
- Ensure dust cap or plug are never removed from an opening until it is ready to be coupled to the next piece of equipment.
- Ensure equipment is drained immediately after uncoupling.
- Ensure removed caps and plugs are coupled together to keep them clean.

WARNING

As an aircraft moves through the air, static electricity builds up on it. Static electricity also builds up on the refueling equipment when fuel is pumped through the hoses. The aircraft, fuel nozzle, and pump assembly must be grounded to prevent sparks and explosions. Static electricity buildup is greater in cool, dry air than in warm, moist air. Care must be taken not to damage the aircraft port.

SECTION III – AMMUNITION OPERATIONS, EQUIPMENT, AND STORAGE**AMMUNITION STORAGE**

3-121. The ready ammunition storage area (RASA) contains the ammunition required to support the arming of aircraft. Ready ammunition is that quantity of ammunition required to support the mission beyond the amount needed for one load. The RASA requires separate areas for the assembling and disassembling of rockets, aircraft flares, and malfunctioned ammunition. More information is contained in AR 385-64.

3-122. The basic load storage area (BLSA) is a separate area from the RASA. The BLSA contains the specific quantity of ammunition required and authorized to be on hand at the unit to support three days of combat. A basic load includes a variety of ammunition such as small arms, grenades, and mines in addition to aircraft specific ammunition.

3-123. Personnel store ammunition by lot number at all locations so that all lots on hand can be properly accounted. Ammunition handlers should consider the following procedures:

- Ensure ammunition accountability.
- Maintain accurate lot number records.
- Ensure lot is not mixed at the RASA, the BLSA, or on the rearm pads.
- Improvise means of transporting ready ammunition to the rearm pads.
- Ensure rated load weight of the trailer or cart is not exceeded.
- Secure and balance the load to prevent the ammunition from tumbling or the vehicle from tipping over.
- Cover the trailer or cart to protect the ammunition in inclement weather.

AMMUNITION SAFETY PROCEDURES

3-124. All personnel must observe required safety procedures to prevent the accidental firing of ammunition or propellants. Improper handling or stray electricity may cause ammunition to explode and result in loss of life or serious injury to personnel.

3-125. Fin protector springs are designed to short-circuit the igniter leads, thus preventing accidental ignition. The shorting wire clips and fin protectors must be installed on all rockets immediately after an aircraft launcher is unloaded and when the rockets are not in a launcher. A sufficient quantity of clips and protectors must be on hand at each rearm pad. Therefore, personnel should not discard the clips and protectors once an aircraft is armed. Also, personnel should remember that the wires and clips can cause FOD to aircraft if they are not properly secured.

3-126. Complete rounds, rocket motors, or fuze-warhead combinations that have been dropped may cause the fuze or warhead to function prematurely. This may result in the loss of a life or an aircraft. Rocket motors and complete rockets that have been dropped from higher than 2 feet, whether crated or uncrated, must be turned in to the supporting ASP. DA Form 581 (Request for Issue and Turn-in of Ammunition) must reflect the reason for the rejection.

3-127. Personnel must assemble rockets according to the instructions in TM 9-1340-222-20. Returned unfired rockets and rockets remaining in aircraft launchers after a mission must be retorqued before the next mission.

3-128. In base camps or semipermanent training facilities, units should build barricades around the RASA, the BLSA, and the rearm pads. Barricades should be at least 3-feet thick to effectively reduce hazards from a fire or an explosion. Rocket motors may go off, so point rockets away from aircraft, personnel, and built-up areas and towards berms, barricades, and open spaces.

3-129. Ammunition should be protected from the weather. If ammunition is covered in a high-temperature environment, it is important to ensure that the covering does not create excessive heating of

the ammunition. As was learned in Southwest Asia, dark covers placed directly on pallets of ammunition can create temperatures up to 180 degrees Fahrenheit. Missile systems especially can be damaged by these high temperatures. The covering selected for use in high-temperature environments should shade the ammunition and provide for air circulation.

3-130. Rockets should not be stored on top of one another. The weight will damage the bottom layers. If rockets need to be unpacked, they should be stored on racks built at the site. Rockets should not be stacked directly on the ground. Wooden pallets are practical to place under the rockets since they allow air to circulate. The rockets should be blocked to keep them from rolling off the stack.

3-131. For maximum safety, the amount of ammunition stored at the RASA and the rearm pads should be kept to a minimum. The following limits— designed to meet operational needs—should not be exceeded:

- Each rearm pad is limited to the ammunition required to fully arm one aircraft plus the number of rockets required for a second load. This facilitates switching the missile launcher for rocket launchers if the mission dictates.
- The ammunition for a second aircraft should be stored off the pad, properly covered, and barricaded.
- The RASA is limited to 2,000 pounds of net explosive weight (NEW) per cubicle. The following example illustrates this limitation: 1,340 of H490 (10 pounds NEW) = 200 rounds per cubicle (200 x 10 = 2,000). The NEW is computed based on the weight of the explosive filler in the item of ammunition. In the case of rockets, the NEW is the combined explosive weight; that is, the amount of explosive filler and the propellant in the motor. Table 3-2 shows the common items used during helicopter rearm operations. Table 3-3 shows the minimum distances permitted between rearm points, RASAs, and nonammunition related activities that require safety distances. Inhabited buildings also include tents used as living quarters.

Note: When completing these calculations, refer to TM 9-1340-222-20.

Table 3-2. Common items used during helicopter rearm operations

ITEM	NET EXPLOSIVE WEIGHT
Hellfire missile	34.4 pounds
Rocket, 2.75-in, high explosive (HE) (H489 or H490)	10.0 pounds
Rocket, 2.75-in, HE (H488 or H534)	11.0 pounds
Cartridge, 30mm, HE (B130 or B131)	.058 ounces
Cartridge, 20mm, HE (A653)	.028 ounces
.50 caliber, all brass	.121 ounces
.50 caliber, all steel	.111 ounces

Table 3-3. Minimum safe distances (in feet) between rearm points and ready ammunition storage area

From	To	Barricaded	Unbarricaded
	Rearm Point	100-180*	100-180*
Rearm Point	Inhabited buildings and unarmed aircraft	400	800
	Public Highways	240	480
	POL storage or refuel facilities	450	800

Chapter 3

From	To	Barricaded	Unbarricaded
	Rearm Point	75	140
Ready Ammunition	Inhabited buildings and unarmed aircraft	505	1,010
	Public Highways	305	610
	POL storage or refuel facilities	50	1,010

*Distance based on rotor clearance

SECTION IV – ARMING OPERATIONS

ARMAMENT PAD SETUP

3-132. The setup of the armament pad will affect overall aircraft turnaround times. During combat missions, enough ammunition for at least one arming sequence should be placed on the armament pad before the aircraft arrive. The ammunition should be laid out in the order it will be loaded. A full load of ammunition must be ready to load in case the aircraft has expended its entire initial load. Figure 3-24 shows two typical layouts for helicopter rearm points, and figure 3-25, page 3-35, shows a three-dimensional view of one plan.

WARNING

An aircraft is positioned so that its weapons are not pointed toward the fuel source, ammunition holding area (HA), or troop sleeping tent in case a weapon discharges by accident. FARP personnel will not walk in front of aircraft weapons systems.

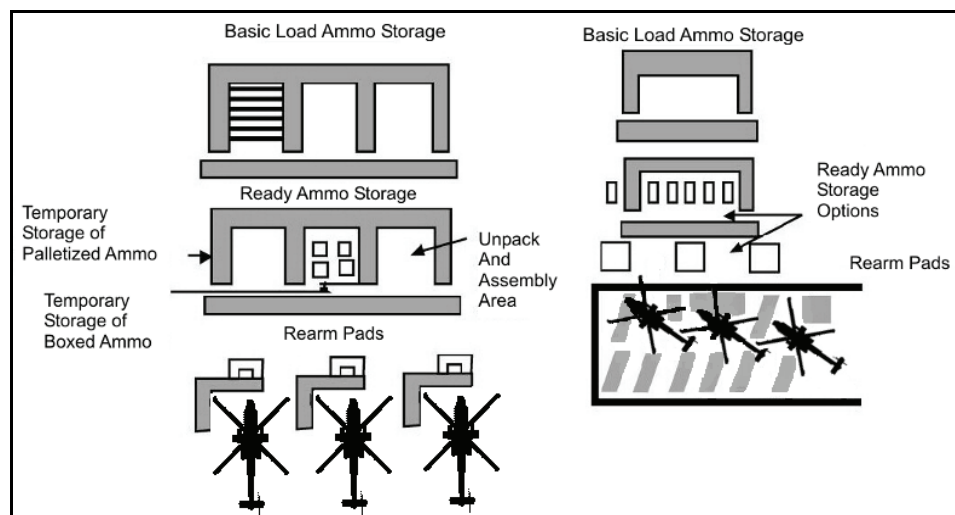

Figure 3-24. Two typical layouts for helicopter rearm points

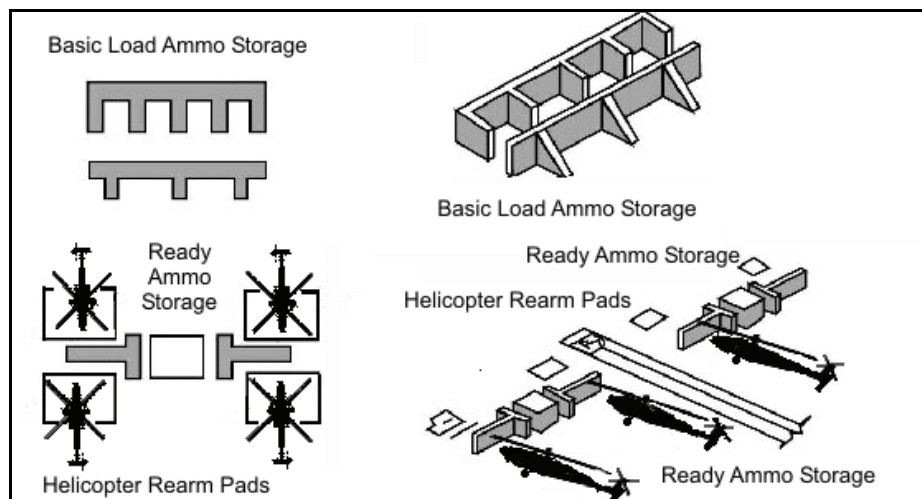

Figure 3-25. Three-dimensional view of a helicopter rearm point plan

PERSONNEL REQUIREMENTS

3-133. The weight of the ammunition containers and Hellfire missiles requires that two people load the aircraft weapon systems. Two personnel are required to upload/download the turret system. When a full complement of ammunition types is required, the safest approach is to load the turret weapon system first, followed by the inboard wing stores. The authorized armament configurations for the AH-64 and OH-58D are in appendix F. Arming instructions are in the appropriate aircraft operator's manual.

3-134. A FARP with eight service points theoretically requires at least 10 refuelers—8 to refuel aircraft and 2 manning the emergency shut-off valves. It also requires 12 arming personnel (2 per service point). This requirement can overextend the FSC's Class III/V personnel especially if there is a need for a second silent or resupplying FARP.

3-135. One solution is cross training personnel to assist in multiple FARP functions. Units can train 89Bs, 92Fs, and copilots to assist in arming functions. At a 50-gallon-per-minute rate, a 92F can finish refueling in as little as 6 minutes and then assist in arming.

3-136. If aircraft are in the FARP up to 40 minutes, pilots and copilots may stretch by alternately leaving the aircraft. They can assist some arming functions such as lifting Hellfire missiles and loading rockets. Units also can arrange UH-60 transport of FARP personnel, minus drivers, to other FARPs.

SIMULTANEOUS ARMING AND REFUELING

3-137. Minimizing aircraft ground time in the FARP is important for two reasons. First, aircraft are extremely vulnerable on the ground. Second, the longer it takes to service aircraft, the less time they are on the battlefield. Depending on task organization and the number of mission-capable aircraft, FARPs require eight armament/refuel points. This quantity supports simultaneous servicing of most company-sized organizations. Each HEMTT tanker and upcoming AAFARS can service up to four refuel points. Extra refuel hose capacity allows units to cross-level fuel from HEMTT tankers to 500-gallon drums without interrupting aircraft refueling. With sufficient drums in place, as fuel gets low, units can transfer tanker fuel to drums, allowing tankers to go for top off. This practice is a good strategy as the FARP prepares to displace and needs fuel resupply at the next location. An alternate strategy is to initially locate all filled drums at the silent FARP, thereby allowing tankers from the initial location to resupply without a lull in the next FARP's mission. Simultaneous arming and refueling minimizes ground time. However, simultaneous rearming and refueling is risky and the aviation commander must ensure that his personnel receive training to accomplish the tasks. This SOP requirement must be a well-rehearsed team effort.

Chapter 3

3-138. Arming the weapon systems is most efficiently accomplished in a specific sequence. Initially, the weapon systems must be inspected for safe operation, starting with the outboard weapon systems and moving inboard. The system is left on and a stray current check is conducted on the rocket pod. The turret weapon system and the wing stores opposite the refueling port are the only weapon systems that should be armed while the aircraft is being refueled. Once the refueling is completed, the inboard weapon systems are loaded, followed by the outboard weapon systems on the refueling port side of the aircraft. The necessary maintenance equipment must be brought to the FARP to maintain the weapon systems. For example, materials for cleaning weapons, oils for lubricating weapons, tools for removing hung rockets, and a multimeter for conducting stray current checks should be available.

3-139. When planning the number of rearm and refuel points for a FARP, the platoon leader should consider how aircraft armament problems will be addressed. For example, one aircraft with a maintenance problem can tie up a refueling and rearming pad and degrade the FARP operation. An example of a simultaneous rearming and refueling FARP layout is shown in figure 3-26.

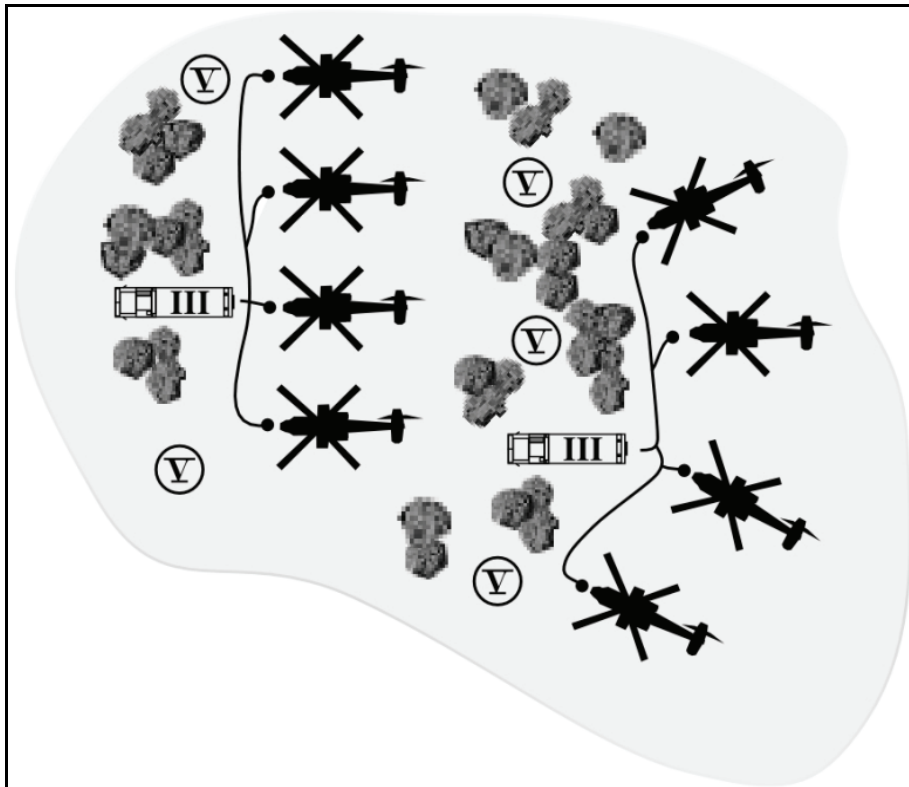

Figure 3-26. Simultaneous rearming and refueling forward arming and refueling point layout

CAUTION

Weapon systems should be safed before the aircraft is refueled.

SECTION V – AIRCRAFT FLOW AND MIX

LIMITATIONS

3-140. A successful FARP operation is characterized by rapid turnaround times. However, there are several factors that can either degrade efficiency or increase turnaround times. These factors include crew

size, night operations, CBRN environment, weapons and ordnance mix, attrition, and maintenance problems.

3-141. Rapid turnaround times cannot be accomplished unless sufficient personnel are available to service the mission aircraft. Separating the available personnel and equipment into more than one FARP requires careful planning. During the day, under ideal conditions, a well-trained crew of two can fully arm the AH-64 aircraft in about 40 minutes. However, a crew of four can substantially improve these times.

3-142. Personnel shortages may require members of the aircrew to assist in arming and refueling. At least two people are needed to load the turret ammunition and Hellfire missiles.

3-143. When arming turret weapons at night, personnel will need NVDs or supplemental lighting such as flashlights. Also, arming times will be 3 to 8 minutes longer at night, especially under low-light conditions.

3-144. The wearing of chemical protective clothing will increase refueling times by 2 to 4 minutes and rearming times by 2 to 6 minutes. Fatigue increases the longer a soldier remains under mission-oriented protective posture (MOPP) conditions. Personnel must remember to drink more water when in MOPP to reduce the possibility of heat injuries.

3-145. Weapons and ordnance mix could be a limiting factor. For example, an AH-64 may have a weapons load of two Hellfire missile launchers and two 19-tube rocket launchers. A mission change may require that AH-64s be set up for Hellfire heavy (four Hellfire missile launchers). The two 19-tube rocket launchers would then have to be removed and replaced with Hellfire missile launchers. The equipment and tools to accomplish this must be at the FARP. In addition, the launchers may have to be bore sighted, which requires special equipment. Therefore, this time-consuming changeover must be in the commander's mission-support decision matrix.

3-146. Aircraft with armament and/or maintenance problems may interrupt the flow of FARP operations. Provisions in the FARP site selection and planning process should include a maintenance pad. The maintenance pad should be positioned away from the arming and refueling area to keep the aircraft flow constant.

AIRCRAFT MIX

3-147. As a planning guide, refueling points should number half as many as there are aircraft in the troop, company, or platoon using the FARP. For example, there should be at least two refueling points to support the 2:2 mix. The FARP site should be large enough to set up two separate arming points to maintain attack section integrity during arming and refueling. Typically, ARB/attack reconnaissance squadrons (ARs) rotate companies through the FARP to support the battalion's continuous or phased attack. Tests show that well-trained crews require up to 40 minutes to fully arm an AH-64. This means it is critical to maintain company integrity at the FARP. Otherwise, platoons and teams waiting for open armament/refuel points may not be able to rejoin already serviced aircraft in the battle for another 40 minutes. Meanwhile, other companies begin to arrive at the FARP creating additional backlog and less time on station. When possible, all company aircraft must arm and refuel at the same time. The order in which sections are serviced is not important. However, the attack team that returns to the FARP with the least unexpended ammunition should perform an over-watch while other aircraft refuel and rearm.

SECTION VI – TRAINING

QUALIFICATION TRAINING

3-148. The commander must ensure that all personnel are thoroughly trained in handling ammunition before they attempt any FARP operations. The different arming configurations of aircraft require armament personnel to be trained in the handling, loading, and arming of all armament systems. One solution is cross training personnel to assist in multiple FARP functions. Units can train 89Bs, 92Fs, and

Chapter 3

copilots to assist in arming functions. A 92F and 89B, upon completion of their mission, can assist in arming, such as lifting Hellfire missiles and loading rockets.

TRAINING REALISM

3-149. The training program must be as realistic as possible. All facets of the FARP's operation—from site preparation to rapid displacement—must be practiced and conducted under combat-like condition. FARP personnel should be trained to operate around the clock and under varying levels of MOPP.

3-150. Commanders must provide soldiers with the quality of training required to do their jobs. Realistic training benefits the commander as well as FARP personnel. The commander will know from observing the training how long rearming really takes, and he can then plan accordingly. In addition, realistic training can surface problems that may have been ignored otherwise. For example, attack reconnaissance units have vehicles and aircraft with limited personnel- and equipment-carrying capacities. These kinds of problems can hinder the efficiency of the FARP.

OPERATION SKILLS

3-151. A successful FARP operation is the final product of a series of progressive skill-building programs to include the cross-training of assigned and attached personnel. Coordinated operations are achieved by integrating team training with programs that emphasize personal skill development. Training progresses as individuals are integrated into operational teams.

3-152. The commander must evaluate the FARP team's ability to deploy and operate. Weak areas will require specific training to bring the operation up to the required standards. The evaluation process should be continuous so that the capabilities and limitations of the FARP are known. Therefore, a training program should be developed to meet specific unit needs.

INDIVIDUAL AND COLLECTIVE TRAINING

3-153. FARP operations will be successful when all FARP personnel are trained to operate as a team. Individual and collective training should not be limited to just arming and refueling activities. All FARP personnel should be trained in firefighting and rescue procedures according to FM 10-67-1. Also, FARP personnel should be trained in receiving and preparing Class III/V helicopter external sling loads. FM 10-450-3 describes the procedures for sling load training.

3-154. Every team member should be proficient in day and night land navigation. Because night relocation of the FARP is common, night land navigation skills should be emphasized. Team members must receive standardized NVD training as required.

3-155. Team members should have extensive driver training and know how to accomplish operator maintenance procedures using the appropriate vehicle operator's manual. Delivering the product to the FARP is just as important as operating the FARP. Team members must also be able to check fuel quality using the visual sample, Aqua Glo, and American Petroleum Institute gravity testing methods.

3-156. Team members should be trained in CBRN detection and decontamination. This training will reemphasize FARP vulnerability to direct CBRN attack and cross contamination from aircraft. It stresses the need for FARP operations in MOPP gear to survive and continue the mission.

3-157. Personnel must be able to recognize any aircraft that may use the FARP. They should be able to identify all Army, Navy, USAF, Marine, and allied aircraft and at a minimum know the proper refuel procedures for each aircraft. If extensive use of the FARP by other than Army aircraft is anticipated, the supported aircraft team leader should provide a subject matter expert to the FARP to oversee refuel/rearm procedures.

3-158. Personnel should be proficient in self-aid and buddy-aid (Combat Life Saver Qualified) procedures. They also should be familiar with medical evacuation request procedures. All personnel

Forward Arming and Refueling Point Utilization

should attend escape and evasion courses. To maintain security rotation, unit should train and provide a large number of crew served weapon operators to support the FARP operation.

This page intentionally left blank.

Chapter 4

Sustainment

FARP operations require close staff coordination. The battalion staff must anticipate and coordinate the unit's Class III/V needs with higher echelons. The CAB must coordinate and rely on support from the division's sustainment brigade or theater sustainment base. This chapter discusses Class III/V considerations, resupply, and requirements. It also discusses argon gas, transportation planning, rear operations, and nonlinear/noncontiguous battlefield operations.

CONSIDERATIONS

4-1. The following are considerations for sustainment of FARP operations:

- Availability of higher echelon support.
- Sustainment units support for aviation mission (Class III/V).
- Location on the battlefield.
- Duration of the mission.
- Aircraft configurations/ammunition mix. Table 4-1 shows the cargo capacities for various types of vehicles.
- MHE transportation requirements (for example, the variable reach forklift may require a flatbed trailer).

Contents	
Considerations	4-1
Resupply	4-1
Class III Requirements	4-3
Class V Requirements	4-4
Argon Gas	4-4
Transportation	4-6
Nonlinear/Noncontiguous Battlefield Operations	4-7

Table 4-1. Cargo capacity comparison in rounds

Munition	HEMTT	HEMAT	5-ton short bed	5-ton long bed	1-½-ton trailer
Hellfire	36	36	27	45	9
Stinger	54	72	36	54	9
Hydra 2.75-inch	240	240	180	300	60
30-mm	10,368	10,368	10,560	10,560	2,640
.50 caliber	152,582	54,142	24,610	24,610	7,792

RESUPPLY

4-2. Resupply operations must keep pace with the tempo of the battle. However, resupply is best accomplished during lulls in combat or when vehicles can be protected from enemy observation and indirect fires. Resupply actions should start as soon as the operation permits. These actions are affected by unit resupply time and capability, current situation, expected usage rates, and/or mission changes.

4-3. Periodic status reports on bulk POL are processed from the FSC commander through the unit S-4 and then sent to the division materiel management center to forecast user needs. Bulk Class III is provided by elements of the theater sustainment base in the theater area support. An emergency reserve of Class III

Chapter 4

is maintained at the division sustainment brigade Class III supply point in the division support area (DSA). The theater delivers Class III supplies, using throughput distribution, as far forward as the BSA. However, the supplies may be delivered farther to the combat trains (FARP) in specific situations. The aviation unit will use its vehicles to transport the fuel from the transfer point to the FARP. The Class III transfer points should be located with the division Class III supply point and the BSA Class III transfer point. Aviation units in the theater rear area will receive Class III from the theater sustainment base. The two methods used to distribute Class III are unit distribution and supply point distribution.

UNIT DISTRIBUTION

4-4. This method is used when the issuing agency delivers supplies to the receiving unit. Throughput distribution is a type of unit distribution used by the theater sustainment base or division sustainment brigade to deliver Class III. Unit distribution is the preferred method of distribution, and it is normally the method associated with getting supplies to the BSA.

SUPPLY POINT DISTRIBUTION

4-5. This method is used when the receiving unit is issued Class III supplies at a distribution point. The unit moves the supplies with its organic transport vehicles.

4-6. If demand exceeds the unit's supply capabilities, limited aerial resupply may be available from other division sustainment brigade or theater sustainment base. During emergencies, the theater may deliver supplies as far forward as the battalion trains area; however, this will require extensive coordination. Figure 4-1 shows the flow of Class III supplies.

4-7. The supplying unit tests fuel. In addition, the receiving unit also must test it. POL products should not be transloaded between carriers if it can be avoided.

4-8. The battalion S-4 normally uses DA Form 581 to request ammunition. The form is forwarded to the appropriate materiel management center or designated ammunition transfer point (ATP) representative. Once the request has been authenticated to ensure that they are consistent with the controlled supply rate, the supplying unit issues ammunition to aviation unit trucks via supply point distribution at either the ATP or the division ASP.

4-9. Within the division's CAB, the ASB DISTRO company and the individual battalion's FSC can operate one ATP. The division sustainment brigade provides an additional ATP, which is located in the division area. The ATPs normally are located in the DSA, and they contain high tonnage, high-usage ammunition to support all the division units, such as BCTs and CABs operating in the division area. The ammunition is transported to the ATP via throughput distribution from the theater. It is then transferred to the battalion trucks or off-loaded for future transfer. All other ammunition is kept in the ASP in the theater area or at the division sustainment brigade, within the division. Figure 4-1, page 4-3, shows the flow of Class V supplies.

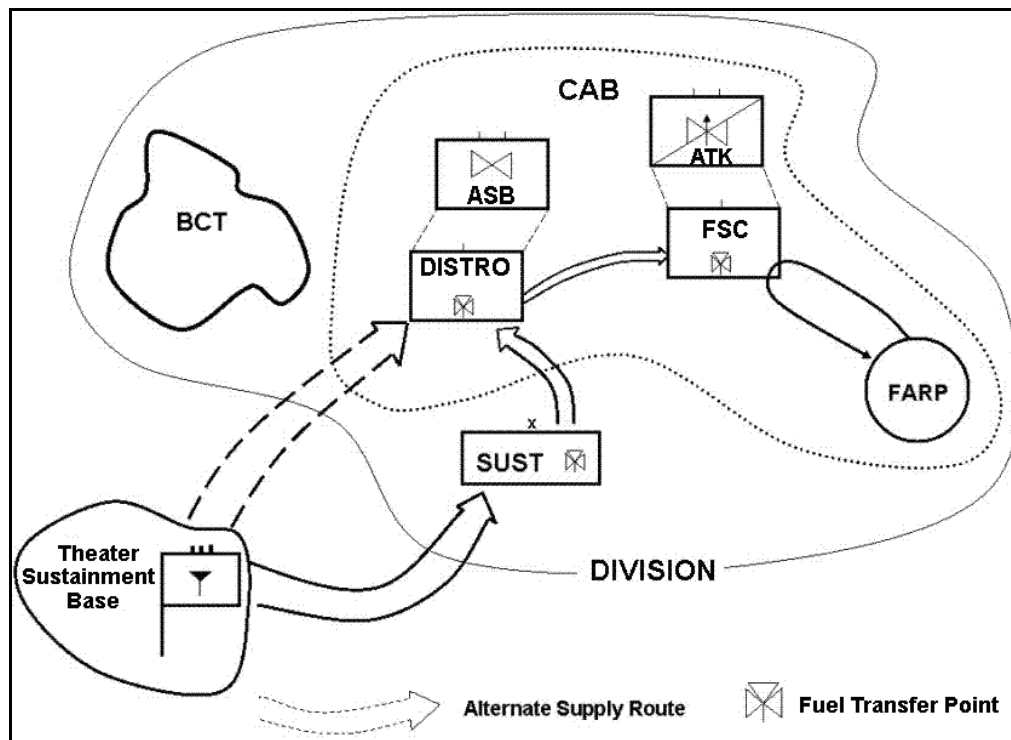

Figure 4-1. Flow of class III/IV supplies

CLASS III REQUIREMENTS

4-10. Two factors determine the amount of fuel required in the FARP. The first is the total number of aircraft to be supported. For planning purposes, 100 percent availability must be assumed. This will provide fuel for unplanned aircraft that may need support. The second and probably the most important factor is the expected duration of the mission. The mission fuel requirement can then be calculated as “mission duration multiplied by number of aircraft multiplied by fuel consumption in gallons per hour (GPH).” Supply Bulletin (SB) 710-2 contains more information about fuel consumption rates. Table 4-2 shows the fuel consumption rates for helicopters that may need fuel in the FARP.

Table 4-2. Fuel Consumption Rates

HELICOPTER	CAPACITY (In Gallons)	CONSUMPTION RATE (Gallons per Hour)
		JP8
AH-64A	370	178.94
AH-64D	370	178.94
CH-47D	1,030	522.78
OH-58D	112	49.25
UH-60A/L	362	181.00

4-11. Figure 4-2, page 4-4, shows how to calculate the mission's Class III (JP8) requirement for an AH-64 ARB. The mission is expected to last 3 hours.

Chapter 4

<p>(Hours for mission) x (Number of Aircraft by Type) x 181 GPH = xxxx (Hours for mission) x (Number of Aircraft by Type) x 49 GPH = xxxx (Hours for mission) x (Number of Aircraft by Type) x 179 GPH = xxxx Total = xxxx</p>

<p>3 hours x 3 (UH-60) x 181 GPH = 1,629 gallons 3 hours x 13 (OH-58D) x 49 GPH = 1,755 gallons 3 hours x 18 (AH-64) x 179 GPH = 9,666 gallons Total = 17,705 gallons</p>
--

Figure 4-2. Formulas for calculating class III (JP8)

4-12. Once the fuel requirements have been calculated, the transportation assets needed to move that fuel can be determined. The example above assumes that the FSC of an ARB has seven mission-capable HEMTT tankers, as authorized on the table of organization and equipment (TOE). Because each HEMTT tanker holds 2,500 gallons of fuel, eight HEMTT tankers would be required to support the battalion.

Note. Fuel capacities for HEMTT tankers will vary depending on operational and environmental conditions.

4-13. If fuel shortages occur during the mission, the turnaround times to resupply points become a critical planning factor. If supplies are flown in, planning may include support for those CH-47s or UH-60s carrying supplies.

CLASS V REQUIREMENTS

4-14. The battalion S-4 is responsible for calculating the amount of ammunition needed for the mission. He bases his figures on the S-3's plan. To calculate Class V requirements during aerial gunnery refer to FM 3-04.140. For combat operations, wartime policy (AR 710-2) for units will be used to calculate required supply rate (RSR). Once the Class V requirements have been determined, these figures can be used to calculate how much transportation will be required.

4-15. The approximate number of vehicles needed to transport the Class V products can be calculated using Table 4-1. Appendix C contains suggested load plans. The example assumes that the FSC in an ARB has six mission-capable cargo HEMTTs, as authorized on the TOE. Seven HEMTTs with trailers are required to support the Hellfire needs of the AH-64 battalion. The 30-millimeter cannon would require one more HEMTT with trailer for a total of eight HEMTTs with trailers. The example illustrates that the Class V requirements exceed the transport capability of the unit and that thorough planning and prior coordination are needed to ensure that the Class V requirements at the FARP are met.

ARGON GAS

4-16. The OH-58D air-to-air stinger system (figure 4-3, page 4-5) requires argon gas for missile seeker cooling. A fully charged coolant bottle (6,000 psi) will provide forty 45-second engagements or ten 3-minute engagements. Based on the mission and the anticipated usage a 3-day supply of argon should be on hand. (See TM 1-1520-248-10). The bottles must be removed for recharging when—

- The pressure reads below 4,500 psi during preventive maintenance checks and services (PMCS).
- An argon sensor message on the terminal display indicates a pressure of about 3,500 psi or less. (Bottles may be usable between 3,000 and 3,500 psi, depending on the outside temperature.)

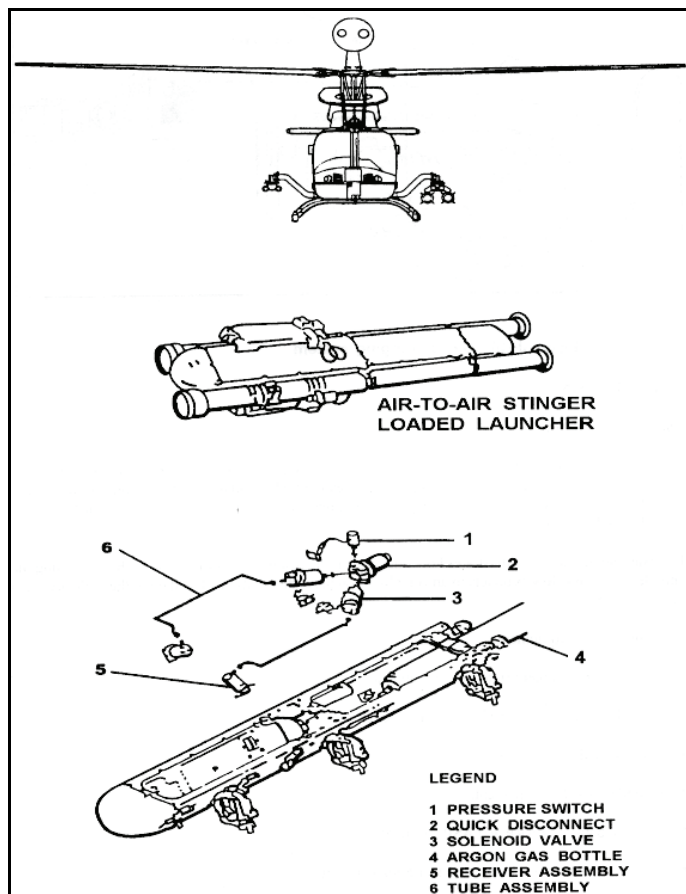

Figure 4-3. Air-to-air stinger launcher

4-17. Figure 4-4 shows the components necessary to charge an argon bottle. They are briefly described below.

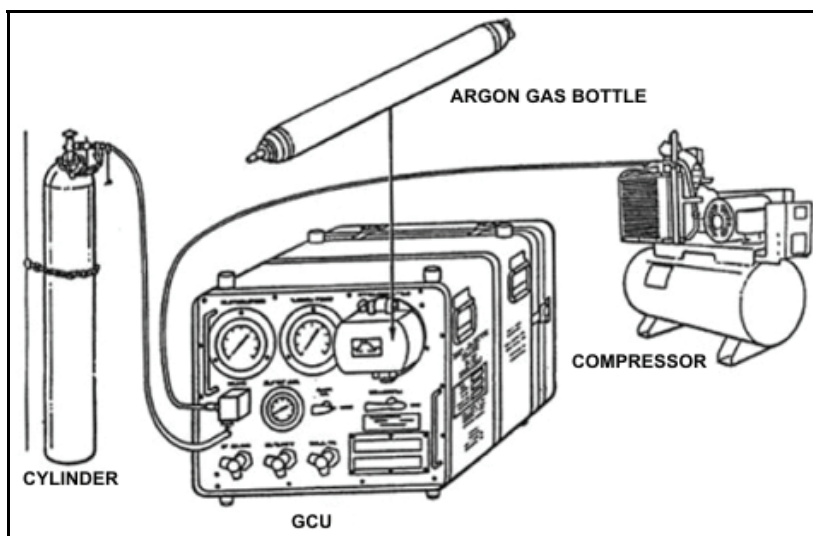

Figure 4-4. Basic charging unit

Chapter 4

ARGON GAS BOTTLE

4-18. This bottle is used to store argon gas in the fire unit (launcher). It is 31.5 inches long and 3 inches in diameter. The weight of the bottle when full of argon gas is 10.5 pounds. Its capacity is 2 liters.

ARGON RESUPPLY CYLINDER

4-19. This is the argon source used to recharge the bottles. It is 51 inches long and 9.24 inches in diameter. The weight of the cylinder when full of argon gas is 378 pounds. Its capacity is 43.26 liters.

GAS CHARGING UNIT

4-20. The gas charging unit (GCU) is the mechanism by which argon gas is transferred from the supply cylinder to the bottles at the requisite pressure. The GCU can provide 97 to 125 psi and be operated off the air brake of a tactical vehicle.

AIR COMPRESSOR

4-21. An air compressor may also be used to power the GCU if the GCU can provide 97 to 125 psi. Two GCU systems are assigned to the ASC. Empty bottles will be transported to the rear to be recharged. An additional GCU will be located at the ASP or ATP. When the 89B makes an ammunition resupply run, the 89B can get the bottles recharged at the same time and location. Another option is to have a task-organized section from the ASC move forward to support the FARP.

TRANSPORTATION

PLANNING CONSIDERATIONS

4-22. When the demand is greater than the support capability, resupply turnaround times become critical considerations during the planning sequence. The distance between the FARP and the resupply point can directly affect continuous FARP operations. If it takes too long to get supplies, the unit's mission could be jeopardized because of a Class III or Class V shortage.

4-23. The example in Table 4-3, page 4-7, illustrates how time critical the resupply effort is to the FARP, assuming that the theater sustainment base or division sustainment brigade does not deliver Class III/V products to an ATP by throughput distribution. The data in the table are based on the following assumptions:

- TOE equipment assigned.
- OPTEMPO (intense commitment).
- Maximum speed on primary roads during day is 30 kilometers per hour (kph); night is 16 kph.
- Maximum speed on secondary roads during day is 21 kph; night is 16 kph.
- Vehicles will travel on primary roads 25 percent of the time.
- Vehicles will travel on secondary roads 75 percent of the time. For example, daytime speed is $.75 \times 21 \text{ kph} + .25 \times 30 \text{ kph} = 23.25 \text{ kph}$; nighttime speed is $.75 \times 16 \text{ kph} + .25 \times 16 \text{ kph} = 16 \text{ kph}$.
- Distance between FARP and ASP should not be more than 30 to 50 kilometers.
- ASP service time is varies.
- Round-trip travel times.

Table 4-3. Round-trip travel times

DISTANCE (Kilometers)	DAY (Hours)	NIGHT (Hours)
30	3.6	5.25
40	4.4	6.5
50	5.3	7.75

PLANNING OPTIONS

4-24. Several transportation options are available to the commander. All available unit vehicles can be used, not just the FSC vehicles. FARP vehicles may have to preposition Class III (collapsible drums) and Class V and then be sent immediately to the ASP or ATP for resupply. Utility or cargo aircraft may have to transport the shortfall to the FARP.

4-25. A potential solution to Class V transportation shortfalls is PLS ammunition throughput. Theater and division ammunition units employ PLS trucks and hydraulically off-loading flat racks. Units can coordinate throughput to battalion AAs or future FARP locations. An ideal situation would be to place eight flat racks near the eight armament pads in a silent FARP location. This act would simplify silent FARP setup with available personnel.

NONLINEAR/NONCONTIGUOUS BATTLEFIELD OPERATIONS

4-26. A nonlinear/noncontiguous battlefield may have extremely long supply lines. To ease the Class III/V logistics problems, the FARP may be located and operated out of a fixed base or an airhead and rely on the throughput of assets from higher echelons. Locating the FARP at a fixed base or an airhead will give it more security from the effects of any drastic changes in the battle direction. If a FARP is located outside a fixed base, the distance between it and the BSA and the lack of secure routes may require air assets to accomplish the resupply mission.

This page intentionally left blank.

Chapter 5

Operational Environments

Successful FARP operations under varied environmental conditions require prior planning and training. Different environments require different considerations. This chapter discusses considerations for night, desert, and winter FARP operations.

NIGHT OPERATIONS

5-1. The unit should establish a detailed SOP for night operations because of limited visibility. Delays will occur because of low-light levels. Light discipline is extremely important, and personnel must guard against the tendency to ignore it.

5-2. Once the FARP is in position, it should remain blacked out until friendly aircraft arrive. Arriving aircraft should use a prearranged signal to let FARP personnel know that friendly aircraft are present. Aviators should be able to navigate to the FARP by using maps, GPS devices, or Doppler navigation systems. Once in the area, the aircraft should transmit a simple, short message. For example, using a single word from the phonetic alphabet such as "Bravo" is sufficient. Use of the phonetic alphabet would alert FARP personnel that friendly aircraft are nearby and that they can safely turn on the site location markers.

Contents	
Night Operations	5-1
Desert Operations	5-2
Winter Operations	5-4

5-3. The location of the FARP can be marked in several ways. If aircrews are equipped with NVDs, a low-level IR light source may be used. Alternate marking techniques include a flashlight with colored lens, chemical lights, or colored beanbag lights. If the existing light level is high, such as during a full moon, engineer tape or other high-contrast materials that are staked to the ground may adequately mark the site.

5-4. During arming and refueling operations, artificial lights may be needed because of the low natural light level. Color-coded, low-intensity light sources may be used to indicate direction, takeoff and landing areas, and pad sites.

Note. Only red lights should be used to mark obstacles.

5-5. The use of artificial lights in the FARP poses several problems. The FARP will probably be in total darkness until aircraft arrive. When personnel start working with lights, their night visual acuity may be impaired. FARP personnel will be constantly adjusting from a no-light to a low-light working environment. Each time the light level changes, FARP personnel may need time for their night vision to readapt.

5-6. The glow from a chemical light when placed nearby can disturb a worker's vision. Objects may be blurred when looked at closely. Artificial light sources are a problem because they cannot be placed to adequately illuminate the work and leave both hands free.

5-7. To overcome the low-light limitations, FARP personnel may use NVDs. However, their use requires extensive training or aircraft turnaround times will increase. NVDs may be the best choice for night FARP operations. They have advantages and disadvantages.

Chapter 5

- 5-8. The following are advantages for using NVDs:
- Passive lighting greatly reduces the enemy's ability to detect the FARP.
 - Aircrews and FARP personnel will be using systems that are compatible, and FARP lighting will not interfere with aircraft night sight systems.
 - The same signals, such as hand and arm signals and flags, can be used during the day and at night.
- 5-9. The following are disadvantages for using NVDs:
- Green chemical lights are difficult to see while using NVDs.
 - Minimum focus distance is 10 inches; therefore, objects any closer will be blurred.
 - Close work space around weapon systems may impair the individual's efficiency.
 - NVDs may not be compatible with current CBRN equipment.
 - The unit may not have enough NVDs to support both aircrew and FARP personnel.

DESERT OPERATIONS

5-10. The desert environment poses many difficult problems for FARP operations. Adequate water supplies should be available. Aircrews and ground personnel will perspire profusely. To prevent heat casualties or extensive dehydration, each individual must drink plenty of water—up to 5 gallons every 24 hours. Factors to be considered are terrain, mobility, communications, flying techniques, high-density altitude, and FARE/AAFARS systems.

DESERT TERRAIN

5-11. The desert has many different types of sand. Sand may be as fine as talcum powder or as coarse as gravel. Off-road vehicle mobility will be affected by the type of sand. In many areas, a crust may form on the surface of the sand. If the crust is dark-colored, the sand is very coarse. In such situations, the light sand has been blown away, leaving a gravel and sand mix. This surface crust may become so hard that a helicopter could land with almost no dust signature. Using hard surfaces is critical for eliminating brownout conditions (see rolling FARP, paragraph 3-4).

5-12. The flat terrain and poor relief of the desert create serious navigational problems. Therefore, FARPs must be established in easily recognizable positions. The use of NVDs will assist in locating FARP positions. Night navigation equipment, such as a GPS, makes desert navigation easier.

5-13. Desert activities can be observed from as far away as 10 kilometers. From a vantage point of high ground, activity can be observed from as far away as 20 kilometers. The FARP will be a target of opportunity for any enemy who can see it without cover and concealment; the FARP must have AD protection.

MOBILITY

5-14. The easiest and fastest way to establish a FARP in the desert is to sling load it into position. Two FARE/AAFARS systems oriented into the prevailing wind and set up in a T-formation, as shown in figure 5-1 (page 5-2), will allow for adequate separation from the turning rotors. This system can support four refueling points. The FARP should be positioned to facilitate ground vehicle support. This eases the strain of trying to aeri ally support the FARP.

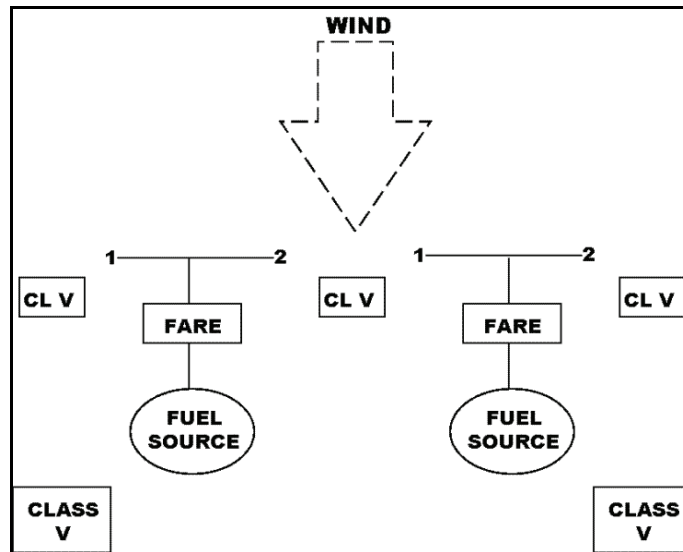

Figure 5-1. T-Formation forward area refueling equipment/advanced aviation forward area refueling system setup

COMMUNICATIONS

5-15. Electronic communication capabilities will vary from day to day. Communicating with an element more than 25 kilometers away may require a relay station.

FLYING TECHNIQUES

5-16. The dust signatures of aircraft operating in the desert will be reduced if airspeed is kept above 40 knots. In-ground effect hovering should not be attempted. Instead, approaches should be planned and executed to the ground. Correct desert flying techniques will help ensure that the aircrew maintains visual contact with the ground.

HIGH-DENSITY ALTITUDE

5-17. High-density altitudes will affect most desert operations. High-density altitudes will degrade aircraft performance. For example, in the early morning when density altitude is lowest, the UH-60 may be able to carry two full 500-gallon collapsible fuel drums. By noon, the UH-60 may only be able to carry one collapsible fuel drum. An attack helicopter may have to carry less than a full load of ammunition and/or fuel. In either case, more frequent trips to the FARP will be necessary. The FARP must be logistically prepared for them.

FORWARD AREA REFUELING EQUIPMENT SYSTEMS

5-18. FARE as well as AAFARS will function well in a desert environment, but they must be dug in or sandbagged. For optimum performance, the fuel source (500-gallon collapsible drum) should be at a level equal to or higher than the pump. All small engine-driven equipment must be protected from blowing sand to prevent mechanical problems. In a desert environment, special attention should be given to FARP equipment. The following procedures will help ensure the continued operation of the FARE/AAFARS system:

- Replace filter/separator elements when contaminated or when the pressure differential indicator shows that they must be changed.

Chapter 5

- Change or clean oil filters according to operator's manual.
- Clean all small engine air filters
- Operate generators according to operator's manual.

ADDITIONAL CONDITIONS AND CHARACTERISTICS

5-19. Other conditions and characteristics peculiar to the desert that all personnel should be aware of are listed below.

- Visual illusions (mirages) will affect all personnel.
- Dust storms will restrict the ability to see and breathe.
- Preventive maintenance checks and services should be performed twice a day.
- Continued exposure to bright sunlight will cause severe eyestrain or sun blindness unless personnel take proper preventive measures.
- Light can be seen for great distances over flat terrain. A pink filter can be seen more than 5 miles away by someone using a NVD.
- Ground vehicles are easy to identify in the desert. Silhouettes and shadows are easily detected because they contrast with the lighter natural background.
- In sandy areas, turret weapon systems will need frequent cleaning and a light coat of lubricant. The use of lubricants without proper cleaning will cause a buildup of sand in the gear mechanism. This will cause weapons to jam. Optical sights should be protected from blowing sand that could scar the glass window of the telescopic sight unit (TSU).

WINTER OPERATIONS

5-20. Aviation units must be prepared to operate in cold environments. Low temperatures, fog, freezing rain, snow, ice, frozen ground, and, at times, muddy ground characterize the winter battlefield. FARP operations are difficult under these conditions. Detailed planning and training are necessary to overcome them.

5-21. Snow, ice, and mud may reduce vehicle mobility on the winter battlefield, complicating FARP displacement. Commanders should plan for aerial displacement when possible. If ground displacement is necessary, more time for movement should be allowed. Regardless of the displacement method used, the breakdown and setup of the FARP will take more time on the winter battlefield than in other environments.

5-22. Low temperatures will make it difficult for FARP personnel to keep warm and function. Windchill caused by helicopter rotor wash will result in cold injuries even when air temperatures are not very cold. Fuel accidentally spilled on bare skin or soaked into clothing will have a cooling effect as it evaporates, increasing the probability of cold injury. Personnel handling cold ammunition will need mittens or other protection. They also will need a lighter pair of gloves when manual dexterity is needed to perform delicate operations. Commanders should ensure that FARP personnel are properly equipped and trained to function in a cold environment.

5-23. Marking the FARP for aircraft control requires special consideration on the winter battlefield. Engineer tape cannot be used on snow as a marker for aircraft control. Marker panels can quickly become obscured by falling snow. Hand and arm signals, flashlights, or smoke may be used, depending on weather conditions. Maneuvering aircraft on loose snow surfaces may cause clouds of blowing snow, which can partially or totally obscure ground guides or other control measures. Blowing snow could cause aircrews to become disoriented and lose aircraft control. These problems can be reduced by packing the snow or by spraying the snow surface with water to form a crust of ice.

5-24. Camouflage of the FARP on the winter battlefield can be difficult, particularly where there is complete snow cover. The use of white covers and snow as camouflage is a possible solution. The best

solution, however, is to avoid open snowfields when selecting FARP locations. Instead, the FARP should be located near partially wooded or urban areas.

5-25. Electrically grounding FARP equipment and aircraft is another problem. Frozen ground makes the emplacement of grounding rods difficult and reduces the effectiveness of the electrical ground. To emplace a grounding rod, a hole must be dug, drilled, blasted, or melted and the rod placed in the hole. To ensure the proper flow of electricity, paper or other absorbent material is filled in around the rod and then soaked with salt water.

5-26. Maintenance requirements for aircraft and FARP equipment will be increased on the winter battlefield. When aircraft icing occurs, FARP personnel may have to deice the aircraft. In cases of extremely thick ice, a Herman Nelson heater or an aviation ground power unit may be the only effective deicing equipment available. At times, ammunition can freeze. Deice caps for the Hellfire missile are available. They are fitted over the seeker to prevent it from freezing. Rocket pod covers also are available. These covers fit snugly over the rockets, and the rockets can be fired through them. All of the FARP equipment must be "winterized" with additional antifreeze or low-temperature lubricants.

Note. Static electricity is more prevalent in cold environments because of low humidity.

This page intentionally left blank.

Chapter 6

Environmental Protection Considerations

While the commander's responsibilities extend across every aspect of the mission, there is one area of responsibility that impacts virtually every action and operation—the environment. Accomplishing the mission always has been and always will be the top priority. However, successfully blending the military mission with the environmental challenge is now equally important. Conserving, protecting, and restoring our natural and cultural resources is the first line of defense for the heritage of future generations and the Army's mission.

ARMY ENVIRONMENTAL MANAGEMENT POLICY

6-1. The Army Chief of Staff and the Secretary of the Army, as stated below, have endorsed the Army Environmental Management Policy. "Protection of precious environmental resources is the duty of every member of the Total Army. Charged with the stewardship of over 20 million acres of land, we must never lose sight of our responsibility to preserve and protect the resources that have been entrusted to our care. . . ." The guiding principle is that work and actions must be environmentally sustainable; meeting current needs without compromising the integrity of the environment for future generations. As a basis to our Environmental Management Policy we must:

- Integrate environmental consideration into all of our activities.
- Allocate resources and training to protect our environment.
- Ensure that installation operations are environmentally acceptable and enhance the life of military and civilian members.
- Minimize the generation of waste.
- Clean up sites of past contamination.

6-2. Personnel must comply with the following references for the environmental policy to be effective:

- AR 200-1.
- AR 200-3.
- AR 200-4.
- DA PAM 200-1.
- *YOU SPILL, YOU DIG!*, An Environmental Handbook for Deployment, published by U.S. Army Corp of Engineers, Europe District. The website for the handbook is <https://www.denix.osd.mil/denix/Public/News/Army/Dig/cover.html>.

Contents	
Army Environmental Management	
Policy	6-1
Liability	6-2
Spill Definitions	6-2
Spill Discovery	6-3
Assessment	6-3
Spill Cleanup	6-4
Spill Kits	6-4
Reacting to a Small Primary Spill	6-5
Reacting to a Small/Large Spill	6-6

Chapter 6

6-3. "All of us, Total Army members and leaders, military and civilian, must ensure that we are well aware of our responsibilities as we set the standard for the Department of Defense and the Nation in meeting the environmental challenges of the 1990s and beyond."

*-The Department of the Army
Environmental Management Policy
Memorandum, 17 July 1990*

LIABILITY

6-4. Several civil and criminal penalties are associated with improper environmental management. The commander has ultimate responsibility and therefore should familiarize himself with the laws. Some of these are—

- Hazardous Materials Transportation Act.
- Occupational Safety and Health Act.
- Clean Air Act.
- Toxic Substances Control Act.
- Resource Conservation and Recovery Act.
- Safe Drinking Water Act.

6-5. Maximum penalties vary by statute and include fines ranging from \$10,000 to \$25,000 per day of violation and imprisonment from 1 to 15 years. In case of a civil enforcement, the installation and its budget would suffer the consequences of enforcement. As far as personal liability, the commander must understand that direct participation in the violation of an environmental statute is but one theory of liability that could subject him to prosecution in the Federal district court.

6-6. The commander should act promptly to correct environmental violations. Failure to promptly correct environment violations could result in prosecution even though the commander had no direct or indirect involvement in the violation. If violations of the law do occur, the best course of action (COA) for the commander is to inform the appropriate regulatory authorities immediately and engage in good faith efforts to comply.

SPILL DEFINITIONS

6-7. A spill is broadly defined as a release of any kind of a petroleum product or hazardous substance to the environment. Spill reaction is based largely on the nature of the material spilled. Three types of spills are small priming spills, small spills, and large spills.

- A small priming spill covers less than 18 inches in all directions.
- A small spill extends less than 10 feet in any direction, covers less than 50 square feet, and is not continuous.
- A large spill extends farther than 10 feet in any direction, covers an area in excess of 50 feet, or is continuous; for example, a leaking tank.

6-8. For purposes of reporting to federal, state, and local authorities, an oil spill is defined as any spill that reaches a stream, creek, river, or any other body of water in harmful quantities. Additionally, any oil spill that could possibly come into contact with the aqua line of the local water table will be reported. Harmful quantities violate applicable water quality standards or cause a film or sheen upon, or discoloration of, the surface of the water or adjoining shorelines. They also cause a sludge or emulsion to be deposited beneath the surface of the water or upon adjoining shorelines.

6-9. The information relative to spill size and reportable spills discussed in this chapter applies only to oil spills and not to hazardous substances. The commander or on-site coordinator is the only person authorized to report spills. He will report all spills of any kind that he deems significant, including any spill that results in fire or explosion.

SPILL DISCOVERY

6-10. The initial component in the spill-response plan is discovery. The primary responsibility of a discoverer is to notify the proper authorities, who are trained and equipped to deal with an environmental incident. When a spill is discovered, the person discovering the spill will—

- Use personal protective equipment, including gloves, goggles and suits.
- Extinguish all cigarettes.
- Do the spill drill—REACT! A helpful reminder is to:
 - Remove the source.
 - Envelop the spill.
 - Absorb/accumulate.
 - Containerize the hazardous waste (HW).
 - Transmit a report.

6-11. Defensive actions should begin as soon as possible to prevent or minimize damage to public health and welfare or to the environment. Some general actions are—

- Eliminate sources of sparks or flames.
- Control the source of the discharge.
- Place physical barriers, such as berms or dikes, to deter the spread of the oil.
- Prevent the discharge of contaminated water into storm drains or the sewer system.
- Recover the oil or minimize its effects.
- Place recovered oil and contaminated absorbents, such as rags, in Department of Transportation (DOT)-approved containers for disposal as HW.

ASSESSMENT

6-12. During every step of the spill-response process each responding individual will continually assess the situation and make decisions on the next appropriate action to be taken. Upon initial discovery the discoverer and/or the supervisor will provide the following information:

- Time and type of incident.
- Name and quantity of spilled material involved (to the extent known) and the rate of release.
- Direction of the spill vapor or smoke release.
- Fire and/or explosion possibility.
- Coverage area of spill and the intensity of any fire or explosion.
- Extent of injuries, if any.
- Status of cleanup.
- Whether spill team is on-site or en route.
- Whether spill team is adequate.
- Estimated time to completion.
- Name of on-scene commander and how to contact him.

6-13. The commander or on-site coordinator will determine the appropriate response based upon the potential risks associated with the spill and whether an imminent or actual threat exists to human health or

Chapter 6

the environment. The appropriate notifications will be made and the response team will be mobilized to control, contain, and clean up any spilled material if the following situations occur:

- The spill could result in the release of flammable or combustible liquids or vapors thus causing a fire or gas explosion hazard.
- The spill could cause the release of toxic liquid or fumes.
- The spill can be contained on the site, but the potential exists for ground water contamination.
- The spill cannot be contained on the site, resulting in off-site soil contamination and/or surface-water contamination.

SPILL CLEANUP

6-14. Specific actions to be taken for oil spills—small priming spill, small spill, and larger spill—are discussed below. The commander or on-site coordinator will direct cleanup operations.

SMALL PRIMING SPILL

6-15. A fireguard will be posted at the spill until the vapors have dissipated.

SMALL SPILL

6-16. Operations in the area will be stopped and a fireguard posted. If the fuel spill is on concrete or a similar hard surface, an absorbent cleaning agent will be used to clean up the spill. After the spill is cleaned up, the absorbent material will be placed in a closed metal container until it can be burned. If aviation gasoline (AVGAS) or jet propulsion fuel, type 4 (JP4) has been spilled, do not use rags to absorb the spill. If the fuel is spilled on the ground or on a hard surface and is well removed from operational areas, the spill area will be roped off until the fuel has evaporated and the vapors have dispersed. Operations will cease and personnel will not be allowed in the area until the fuel is vapor-free.

LARGE SPILL

6-17. The fire department will be called immediately, and the flow of fuel will be stopped. After all safety precautions have been taken, personnel will consider—

- Removing aircraft and personnel from the spill area.
- Removing refueling vehicles from the spill area.
- Shutting engines off.
- Blanketing large fuel spills with foam.

Note. The fire chief will direct subsequent recovery of fuels. The area must not be used for operations until it is declared free of fuel and fuel vapors.

SPILL KITS

6-18. Spill kits (figure 6-1, page 6-5) should be maintained in and around all locations where hazardous material (HM)/HW are stored, handled or disposed of. Various types of kits can be ordered through the Army Supply System (see Appendix H) and should include rubber gloves, safety goggles, putty, rubber mallet, wooden plugs, absorbent booms, absorbent pads, plastic bags, and in some cases a disposal barrel.



Figure 6-1. Spill kit.

REACTING TO A SMALL PRIMARY SPILL

6-19. By REACTing quickly, personnel eliminate hazards that could cause injury. This also give the spill less of a chance to seep into the ground, which makes cleanup easier and helps protect water resources. After personnel have protected themselves from exposure, they will—

- **Remove the source**
 - If it is dripping: stop the drip with a wooden plug or putty.
 - If it is from a leaky connection: tighten the connection or replace the broken parts.
- **Envelop the spill.**
 - If it is flowing, put an absorbent sock or pad down to catch the flow.
 - Use your shovel to build a small dam or berm.
- **Absorb/accumulate.**
 - On a hard surface put down dry sweep.
 - On a gravel or mud surface, lay an absorbent sock or pad on the spill.
- **Containerize it.**
 - Place used absorbent material in a plastic bag or container.
 - Use your on-vehicle equipment shovel or entrenching tool to dig up the contaminated soil and place it in a container or plastic bag. Be sure to bring the container or bag to a proper HW collection point.
- **Transmit a report.**
 - Tell your boss or supervisor what you spilled and what you did about it.
 - Report regulatory enforcement actions and reportable spills through command channels, according to DA PAM 200-1.

Chapter 6

REACTING TO A SMALL/LARGE SPILL

6-20. After personnel have protected themselves from exposure, they will—

- **Remove the Source.**
 - Attempt to stop the flow from the container.
 - Place the leaking container into another container or try to catch the leak with another container
 - Secure the area.

- **Envelop the spill.**
 - Break out the nearest spill response kit.
 - Put the booms at the bottom of the flow or
 - Dig a dike/berm (figure 6-2) to stop the flow into streams.



Figure 6-2. Digging a dike/berm.

- **Absorb/accumulate.** Place appropriate absorbent material (dry sweep, pads) on the spill in the middle of the boomed-off area.
- **Containerize the HW.** Use a shovel to place contaminated materials (including soil, booms, pads or other materials) in a plastic bag or a waste drum.
- **Transmit a report.** If a spill is too large to handle alone—REACT as best you can and get help!

Appendix A

Standard Hand and Arm Signals

This appendix implements portions of Standardization Agreements (STANAGs) 3117 and 2999 (Allied Tactical Publication-49[D], Volumes 1 & II). See FM 3-04.140, figure 3-1 for arming hand signals. Figures A-1 through A-48 show standard hand and arm signals.

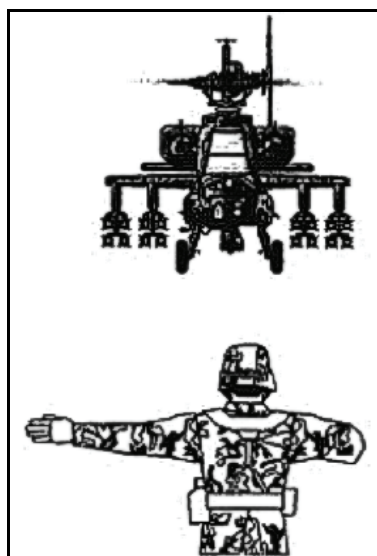

Figure A-1. Position of ground guide for a rotary-wing aircraft



Figure A-3. This way
Arms above head in vertical position with palms facing inward.



Figure A-2. Proceed to next ground guide
Both arms extended on same side of shoulder level to indicate direction of next ground guide.

Appendix A



Figure A-4. Move ahead

Arms a little apart with palms facing backward and repeatedly moved upward and backward from shoulder height. Indicate the aircraft speed desired by rapidity of arm motions.

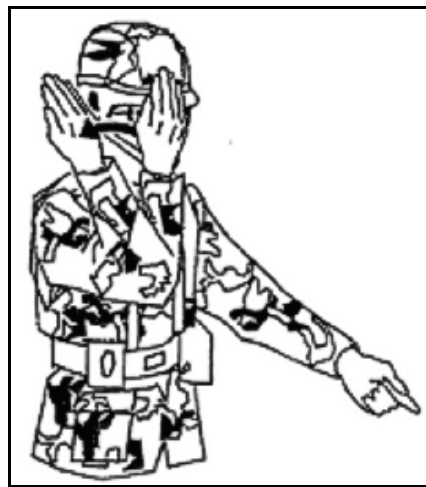

Figure A-6. Turn to right (starboard)

Position left arm down and point to right wheel or skid; move right arm repeatedly upward and backward. Indicate rate of turn by rapidity of arm motions.



Figure A-5. Turn to left (port)

Position right arm down, and point to left wheel or skid; move left arm repeatedly upward and backward. Indicate rate of turn by rapidity of arm motions.

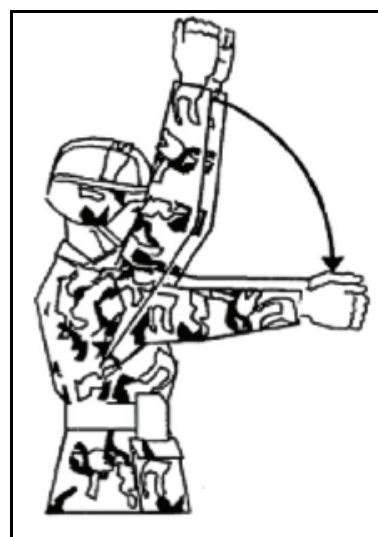

Figure A-7. Landing directions

Ground guide stands with arms raised vertically above head and facing toward the point where the aircraft is to land. The arms are lowered repeatedly from a vertical to a horizontal position, stopping finally in the horizontal position.

Standard Hand and Arm Signals

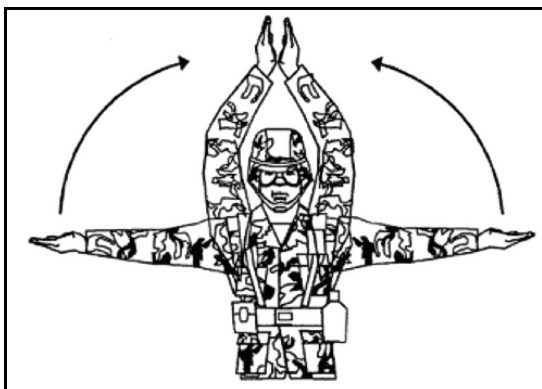

Figure A-8. Move upward

Extend arms horizontally to the side, beckoning upward with palms turned up. Indicate rate of ascent by speed of movement.

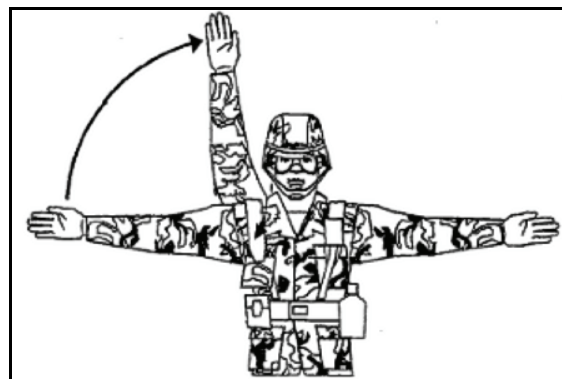

Figure A-11. Move to right

Left arm extended horizontally sideways in direction of movement and right arm swung over the head in same direction in a repeating movement.



Figure A-9. Hover

Extend arms horizontally sideways with palms turned down.

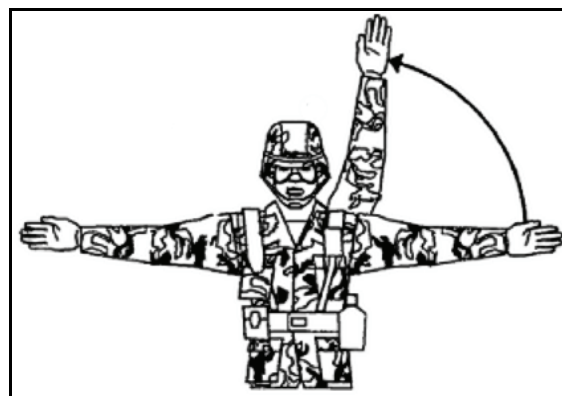

Figure A-12. Move to left

Right arm extended horizontally sideways in direction of movement and left arm swung over the head in same direction in a repeating movement.



Figure A-10. Move downward

Extend arms horizontally to the side, beckoning downward with palms turned down. Indicate rate of descent by rapidity of arm motions.



Figure A-13. Slow down

Arms down with palms toward ground and then move up and down several times.

Appendix A



Figure A-14. Stop

Cross arms above head with palms facing forward.

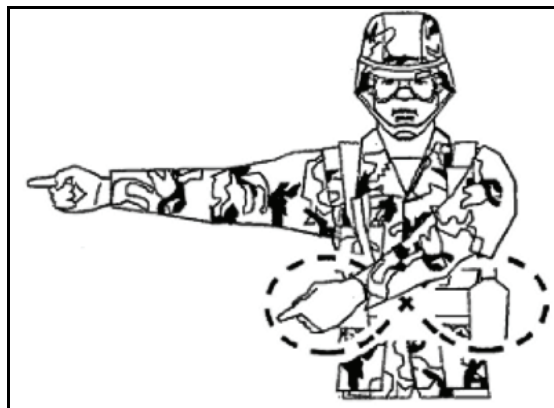

Figure A-16. Fire

Make rapid horizontal figure-eight motion at waist level with either arm, pointing at source of fire with the other.



Figure A-15. Brakes

On (Day). Arms above head, open palms, and fingers with palms toward aircraft, and then fist closed.

On (Night). Arms above head and then wands crossed.

Off (Day). Reverse of above.

Off (Night). Crossed wands and then uncrossed.



Figure A-17. Engage rotor(s)

Circular motion in horizontal plane with right hand above head.

Standard Hand and Arm Signals



Figure A-18. Start engine(s)
Day. Left hand overhead with appropriate number of fingers extended to indicate the number of the engine to be started and circular motion of right hand at head level. Night. Similar to day signal except that the wand in the left hand will be flashed indicating the engine to be started.



Figure A-20. Affirmative (all clear)
Hand raised with thumb up.



Figure A-19. Wave-off
Waving of arms over the head.



Figure A-21. Negative (not clear)
Arm held out, hand below waist level, and thumb turned down.

Appendix A

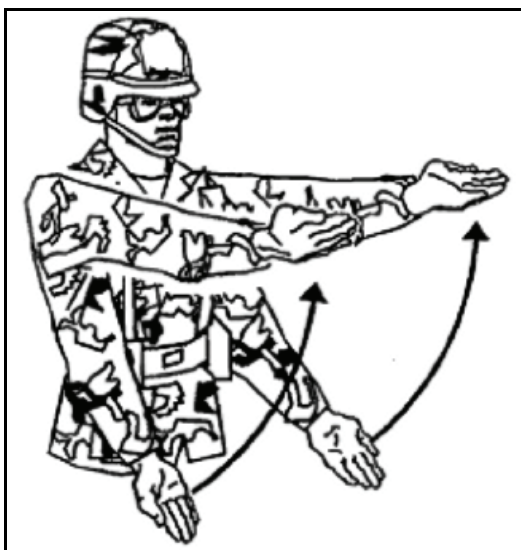

Figure A-22. Move back
Hold hands down by side; face palms forward; and, with elbows straight, repeatedly move arms forward and upward to shoulder height.



Figure A-24. Tail to right (starboard)
Point left arm down, and move right arm from overhead vertical position to horizontal forward position. Repeat right arm movement.



Figure A-23. Land
Cross hands and extend arms downward in front of the body.



Figure A-25. Tail to left (port)
Point right arm down, and move left arm from overhead vertical position to horizontal forward position. Repeat left arm movement.

Standard Hand and Arm Signals



Figure A-26. Clearance for personnel to approach aircraft
A beckoning motion with right hand at eye level.



Figure A-28. Up hook
Right fist, thumb extended upward, raised suddenly to meet horizontal palm of left hand.

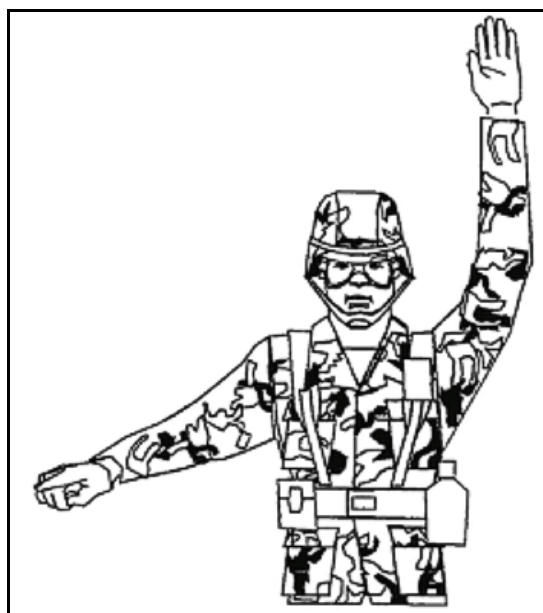

Figure A-27. Personnel approach the aircraft (given by ground crewmember)
Left hand raised vertically overhead with palm toward aircraft. The right hand indicates the persons concerned and gestures toward aircraft.



Figure A-29. Down hook
Right fist, thumb extended downward, lowered suddenly to meet horizontal pain of left hand.

Appendix A

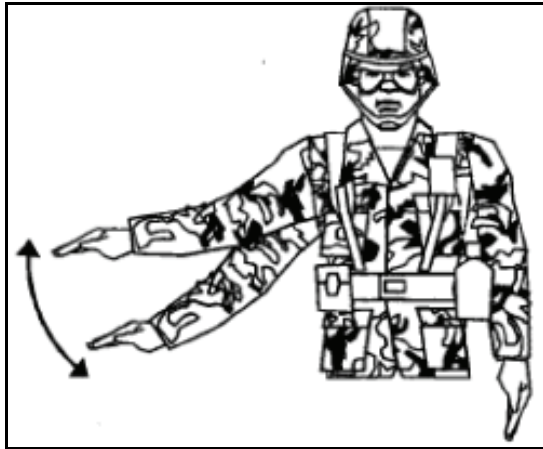

Figure A-30. Slow down engine(s) on indicated side

Arms down with palms toward ground and then either right or left arm waved up and down to indicate the left- or right-side engines, respectively, should be slowed down.



Figure A-31. Cut engine(s) or stop rotor(s)

Either arm or hand level with shoulder with palm down; draw the extended hand across neck in a "throat-cutting" motion.



Figure A-32. Connect auxiliary power unit

Day. Extend hands overhead; push first two fingers of right hand into fist of left hand. Night. Same movement with the left-hand lighted wand vertical and the right-hand lighted wand horizontal.

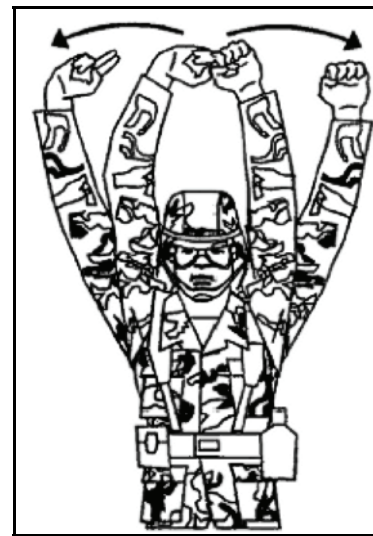

Figure A-33. Disconnect auxiliary power unit

Day. Extend hands overhead; pull first two fingers of right hand away from left fist. Night. Same movement except that left-hand lighted wand is vertical and right-hand lighted wand is horizontal.

Standard Hand and Arm Signals



Figure A-34. Insert chocks/chocks inserted
Arms down, fists closed, and thumbs extended inward. Swing arms from extended position inward.

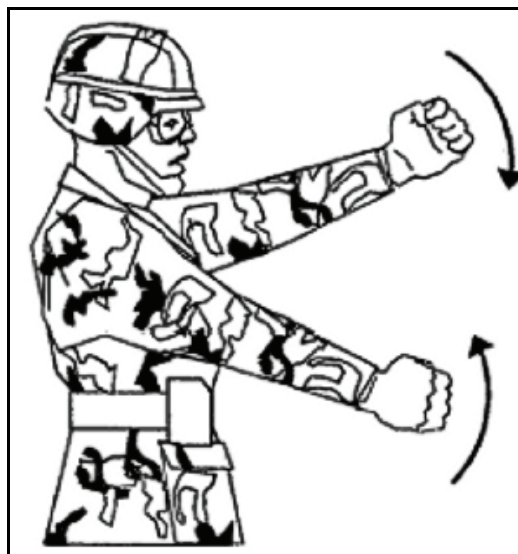

Figure A-36. Hook up load
Rope climbing motion with hands.

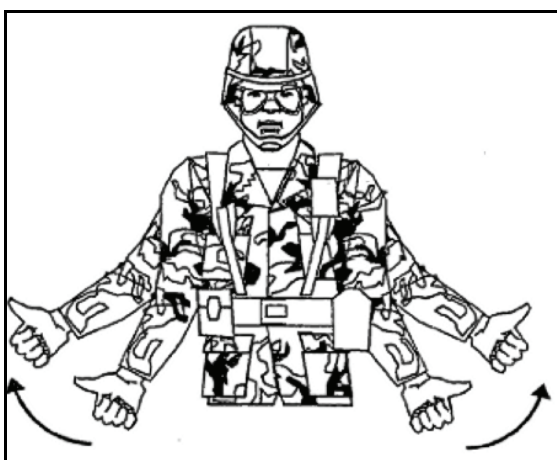

Figure A-35. Remove chocks
Arms down, fists closed, and thumbs extended outward. Swing arms outward.



Figure A-37. Release load
Left arm forward horizontally with fists clenched; extended right hand making horizontal slicing motion below left arm with palm down.

Appendix A



Figure A-38. Load has not been released

Bend left arm horizontally across chest with fist clenched and palm turned down; open right hand pointed up vertically to center of left fist.

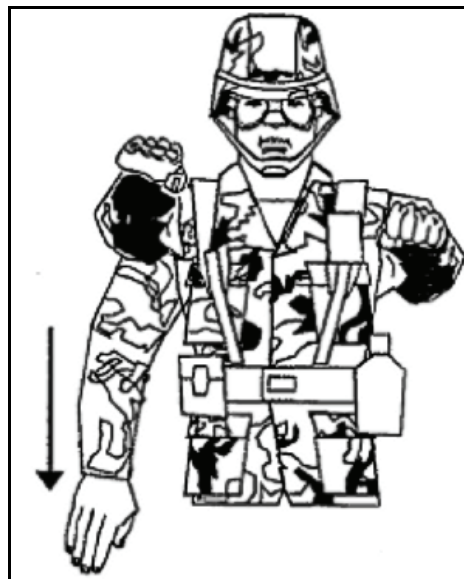

Figure A-40. Winch up

Extend left arm horizontally in front of body with fist clenched; extend right arm forward with palms turned up and make an upward motion.



Figure A-39. Cut cable

A signal similar to "release load" except that the left hand has the palm turned down and not clenched. Rapid repetition of right-hand movement indicates urgency.

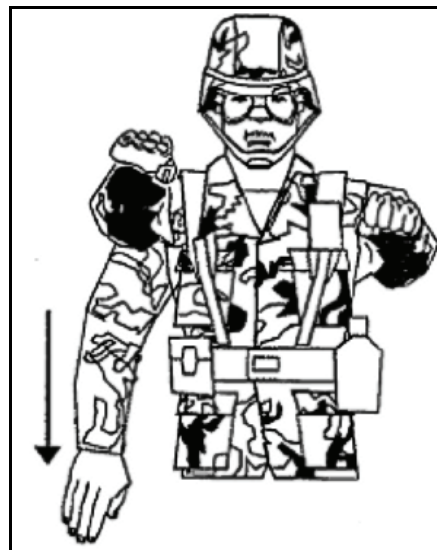

Figure A-41. Winch down

Extend left arm horizontally in front of body with fist clenched; extend right arm forward with palm turned down and make a downward motion.

Standard Hand and Arm Signals



Figure A-42. Lock wings/helicopter blades
Hit right elbow with palm of left hand



Figure A-44. Remove
Day. With arms and hands in "install-downlocks" position, the right hand unclasp the left forearm.
Night. Similar to the day signal except that the right wand is placed against the left forearm. (Downlocks/Undercarriage Pins)

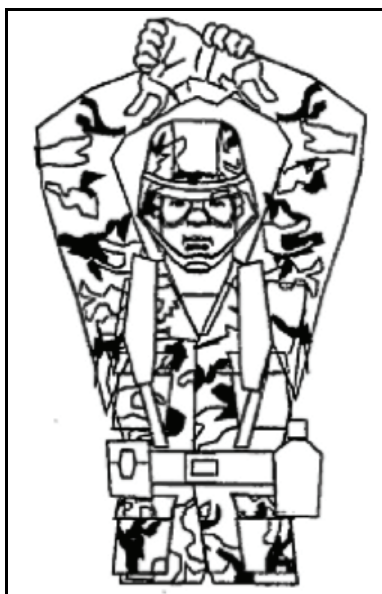

Figure A-43. Install
Day. With arms above head, the right hand clasps left forearm and the left fist is clenched.
Night. Similar to the day signal, except that the right wand is placed against the left forearm. The wand in the left hand is held vertically. (Downlocks/Undercarriage Pins)



Figure A-45. Remove blade tie-downs
Left hand above head and right hand pointing to individual boots for removal.

Appendix A

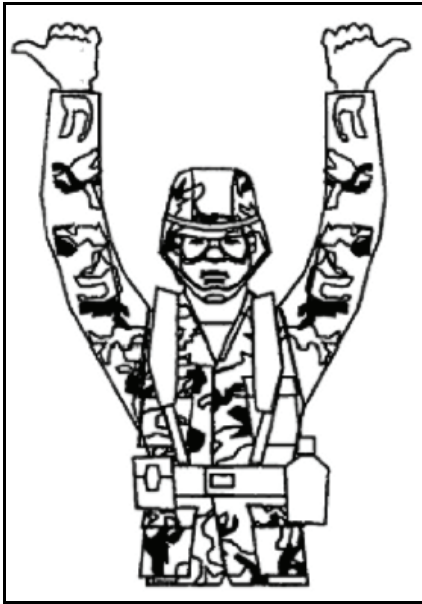

Figure A-46. Droop stops out
When rotor starts to “run down,” ground guide stands with both hands raised above head, fists closed, and thumbs pointing out.



Figure A-47. Droop stops in
When droop stops go in, ground guide turns thumbs inward.

Standard Hand and Arm Signals

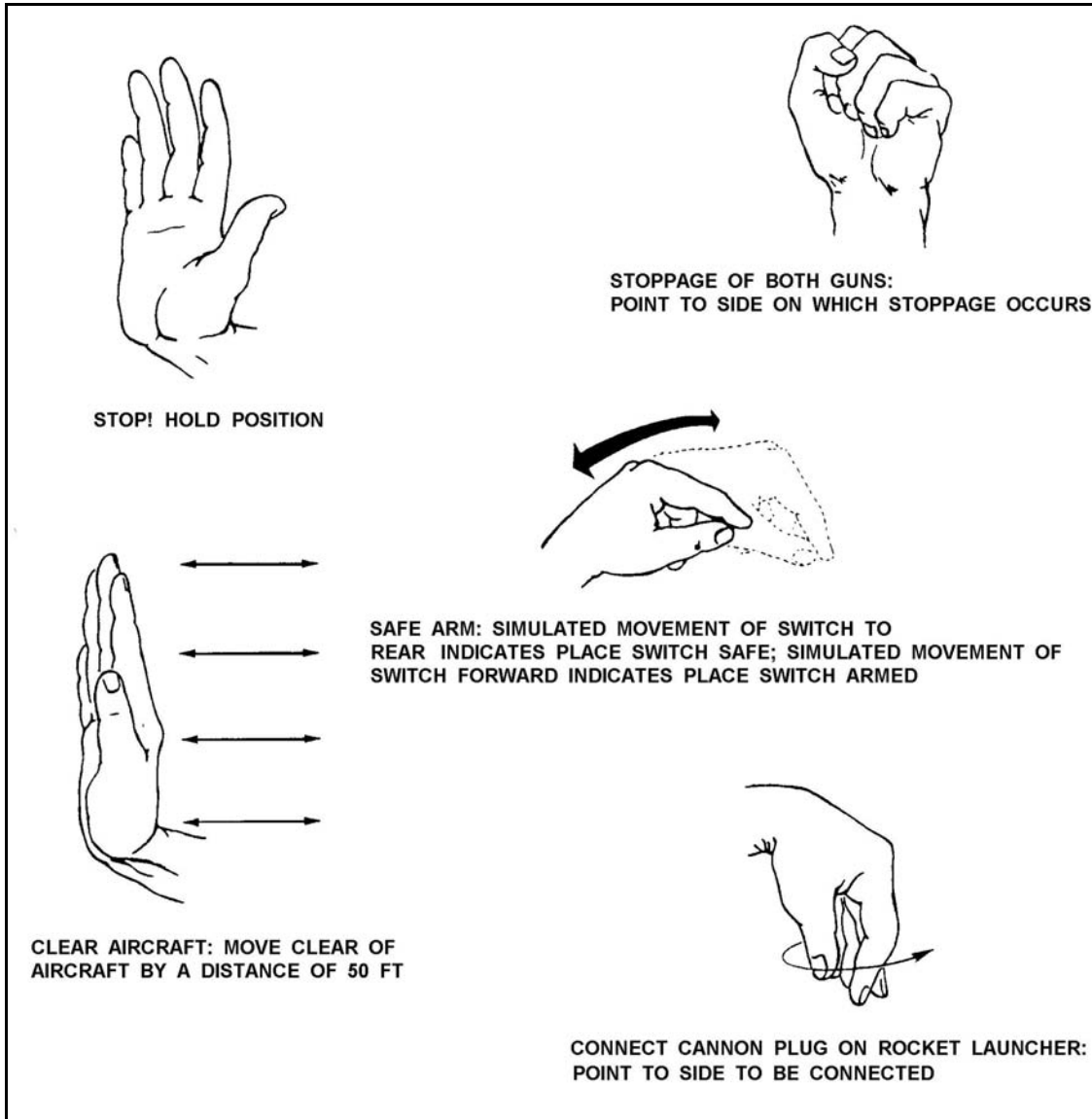

Figure A-48. Ground hand signals

Appendix A

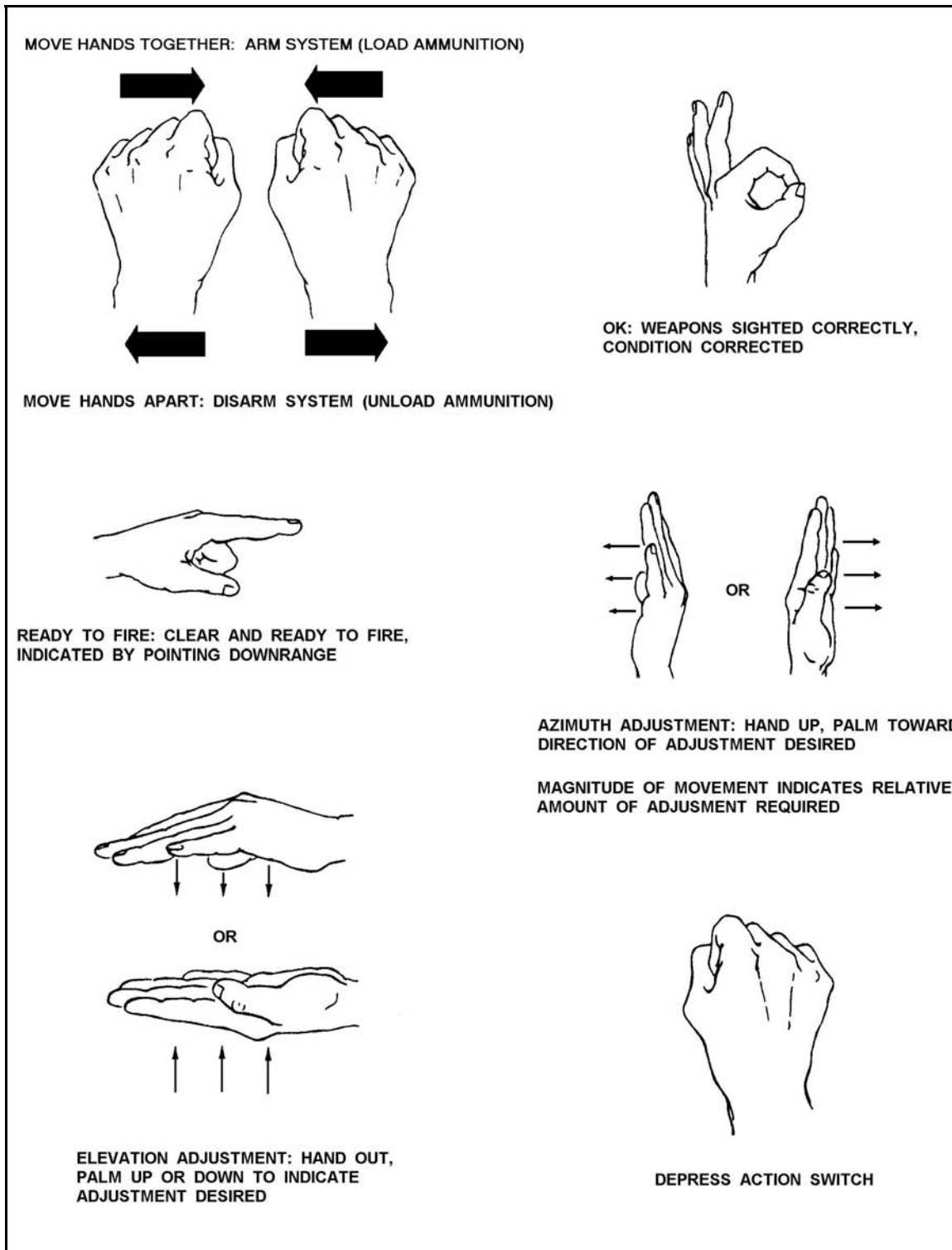

Figure A-48. Ground hand signals (concluded)

Appendix B

Sample Forward Arming and Refueling Point Standing Operating Procedure

Forward arming and refueling point operations should be an integral part of the unit's SOP. Figure B-1 is an example of a FARP operations annex to a tactical SOP.

<p>1. EQUIPMENT.</p> <p>a. HEMTT FARP. Two HEMTTs will be placed on-line, and one will remain in reserve. Figure 1 shows the layout of a HEMTT FARP. The FARE or AAFARS FARP will be configured similarly to the HEMTT FARP as shown in Figure 2. They use at least eight points or as needed to support simultaneous refueling of an attack helicopter company or troop.</p> <p>b. FARP Layout. The standard FARP layout for simultaneous rearming and refueling operations will be configured as shown in Figure 3.</p> <p>2. SITE SELECTION. FARP personnel—</p> <p>a. Use tree lines, vegetation, terrain folds, and reverse slopes to mask the FARP.</p> <p>b. Do not collocate the FARP with the TOC or unit trains.</p> <p>c. Consider the following:</p> <ul style="list-style-type: none"> • The number and type of aircraft to be refueled. • The minimum spacing requirement of 100 feet between refueling points (180 feet for CH-47). • Adequate obstacle clearance for a safe takeoff and landing. • Designated HAs for waiting aircraft. <p>3. WORK PRIORITIES.</p> <p>a. Security. FARP personnel—</p> <ul style="list-style-type: none"> • Establish a perimeter and prepare fighting positions and range cards. • Sweep the site for CBRN contamination and set up CBRN equipment. • Reconnoiter the site for appropriate refuel and rearm points. • Setup crew-served and AD weapons to protect the site. <p>NOTE: FARP personnel must maintain security throughout occupation of the site unless other personnel are attached specifically to provide security.</p> <p style="text-align: center;">1</p>
--

Figure B-1. Example of a forward arming and refueling operations annex to a tactical standing operation procedure

Appendix B

b. Communications. Upon arrival, the FARP NCOIC will establish communications with the TOC, giving the closing report and anticipated time of operation. This communication will be on a secure FM from a location other than the FARP. Inbound or outbound aircraft can relay critical messages from the FARP to the TOC. This reduces the chances of enemy detection by radio transmission. FARP personnel use the FARP radio only under the following circumstances:

- Requesting resupply.
- Reporting that the site is under attack.
- Reporting that the FARP is not operational.
- Reporting a serious FARP incident such as a fire or an aircraft accident.

c. Setup. FARP personnel will—

- Establish positions of refuel and rearm points (100 feet separation for all aircraft except the CH-47).
- Break down ammunition and prepare the aircraft standard loads and another load in the RASA.
- Reposition vehicles into final parking locations.
- Camouflage vehicles and equipment.
- Perform PMCS on vehicles, radios, CBRN equipment, weapons, and platoon equipment.

d. Resupply. FARP personnel resupply ammunition and fuel as necessary. After ammunition trucks offload, depending on the FARP's expected duration of operation, vehicles may need to depart for resupply of Class V. HEMTT tankers may transload into other tankers as they become empty or can fill empty 500-gallon drums. This practice allows these vehicles to go for additional Class III at distribution points or LRPs. In all cases, personnel diverted to resupply vehicles are not available to assist in arming and refueling. With a silent FARP prepared to assume the mission, the initial FARP vehicles can resupply without disrupting the mission.

e. Mess, Personal Hygiene, and Rest. These are accomplished after mission-essential duties are completed.

4. AIRCRAFT PROCEDURES. Unit SOPs and orders specify procedures. The following provides recommendations and describes standard signals.

a. Landing.

(1) When 5 kilometers from the FARP, the air mission commander will make a call in the blind on the administrative/logistics frequency stating that he is inbound to the FARP. An example of a call is "T14 (FARP), this is T56 (air mission commander) with five on blue." The air mission commander is telling the FARP that five aircraft are inbound on the Blue route. This alerts the FARP and other aircraft of his intentions. The FARP does not reply unless the area is not safe or secure. Terms that violate operations security (OPSEC) will not be used, for example, "aircraft," "inbound," "outbound," and "FARP."

(2) Aircraft will be flown at NOE within 3 kilometers of the FARP. Approaching aircraft must maintain visual contact with departing aircraft.

Figure B-1. Example of a forward arming and refueling operations annex to a tactical standing operation procedure (continued)

Sample Forward Arming and Refueling Point Standing Operating Procedure

b. Positioning.

(1) FARP personnel will use standard hand and arm signals (Appendix A) to assist pilots in positioning aircraft into refuel and rearm points.

(2) Pilots will not point aircraft weapons at personnel or equipment after aircraft depart the "Y" for refueling or rearming.

(3) Pilots will position their aircraft at the refuel points so that the CCR nozzle is on the right side of the aircraft.

5. REFUELING PROCEDURES. An inspection of fuel and equipment will be conducted according to regulations and the unit accident prevention program. Authority to conduct open-port refueling rests with the commander.

WARNING

Exercise the following precautionary measures if wearing the Extended Cold Weather Clothing System (ECWCS) while performing aircraft arming and refueling operations:

- Fuel handlers wearing ECWCS should ground/bond themselves to the aircraft, truck, or refueling component for several seconds before fuel/defuel operations.
- Do not remove ECWCS within 50 feet of fueling operations or near flammable vapor-air mixture.
- Rinse fuel-soaked ECWCS with water before removal.

a. Hot Refueling. FARP personnel—

- Ensure that a 100-foot separation exists between refueling points.
- Ensure that armament systems are on SAFE or OFF.
- Stabilize the aircraft at flat pitch and deplane all passengers before conducting refueling operations. Although no transmissions are permitted except during an emergency, monitor all communications.
- Ground the closed circuit refueling nozzle (when used) to a grounding rod and bond it to the aircraft.
- Ensure that the cap is secured and the grounding cable is disconnected before the aircraft takes off.
- Turn the strobe lights off before refueling the aircraft and back on before it takes off (day only).

NOTE: FARP personnel and crew chiefs will wear protective equipment, including eye and hearing protection and gloves while refueling operations are being conducted. The fire extinguisher will be manned by FARP personnel or by a crewmember.

Figure B-1. Example of a forward arming and refueling operations annex to a tactical standing operation procedure (continued)

Appendix B

b. Emergency Procedures. FARP personnel take the following actions:

- The POL operator will immediately shut down the pump on the tanker or the pump on the FARE/AAFARS or HEMTT.
- Whoever is tending the nozzle will remove it from the aircraft and, if the fire is small, attempt to put it out using the available fire extinguishers. The first priority is crew safety.
- Aircraft that are not directly involved will be flown to their respective HAs.
- If the situation permits, every attempt will be made to remove the tanker from the scene of the fire. If time permits, ensure that all butterfly valves and elbow couplers are closed on the FARE/AAFARS with the 500-gallon collapsible drums (if one is in use).
- At the first opportunity, notify the TOC and maintain communications between the FARP and the TOC by whatever means available.
- After all of the above procedures are complete, personnel will move to a safe distance.

6. REARMING OPERATIONS. The standard refueling/rearming line will consist of four/eight points and the maintenance point. The maintenance point will be located where it will not interfere with normal operations.

a. Maintenance point. This point will be equipped as follows:

- One fire extinguisher and a ground rod with cable.
- One metric (for AH-64) and one standard toolbox.
- Two pallets for down-loading rockets, .50 caliber and 30mm ammunition.
- Special tools as determined by the maintenance OIC.
- Spare parts.

b. Rearm points. Each rearm point will be equipped as follows:

- One standard toolbox.
- One metric toolbox (AH-64).
- One fire extinguisher and a grounding rod with cable.
- One up loader/downloader (AH-64).
- One wing mike cord.
- Two pallets for rockets.

c. Personnel Requirements. Each FARP will include the following:

- One noncommissioned officer (NCO).
- One line safety officer.
- One OIC.
- Two 92F/pad (minimum)
- Three armament personnel (preferred); two armament personnel (minimum) for each rearm pad. **Note:** On scout aircraft when cross training has been completed between MOSSs, 1 armament and 1 fuel handler are all that is required.
- A contact team (maintenance point only).

Figure B-1. Example of a forward arming and refueling operations annex to a tactical standing operation procedure (continued)

Sample Forward Arming and Refueling Point Standing Operating Procedure

d. Procedures. Aircraft will be safed, armed, or disarmed according to the appropriate aircraft operator's manual.

(1) When all armament switches on the aircraft are off, the pilot will turn off the anticollision light. No radio transmissions will be made during loading/downloading operations.

(2) After the anticollision light is off, armament personnel will ground the airframe and install the wing store jettison pins and chock the wheels, as applicable. Then they will plug in their headsets and establish communication with the aircrew. No radio transmissions will be made during loading/downloading operations.

(3) The aircrew will assist and monitor armament personnel conducting loading/downloading operations.

(4) Ground crews will load subsystems inboard to outboard, remaining clear of the front of the systems and the back-blast areas. If simultaneous refueling is conducted, ground crews will load the off-side first.

(5) When the loading is completed, the ground crew removes all safety pins and moves away from the aircraft.

(6) The pilot will turn on the anticollision light after the weapon system is armed. He will then depart the rear point.

d. Aircraft Departure. The departure heading will be as briefed; or right turns will be executed after the takeoff. All takeoffs will be at minimum airspeed. Vehicles or other aircraft will not be over-flown.

7. AIRCRAFT CONTROL AND SAFETY

a. Safety. All safety aspects must be considered during the planning and execution phases of the air assault FARP mission; and special safety considerations must be given night operations. The unit commander sets the safety limitations depending on the actual mission; however, safety will not be sacrificed for mission completion during training. The following actions will be taken at the FARP:

NOTE: Any incident involving a fire or suspected fuel contamination will close the FARP until the safety officer has investigated the incident and authorizes further operations.

- Refuel nozzles will be marked with a red/orange light source attached to the grounding rod.
- The landing area will be marked with either beanbag lights or chemical lights. Hot rocks that have been heated in cans may also be used for easier forward looking infrared (FLIR) detection.
- While in the FARP, aircraft position lights will be placed on steady bright or dim. However, they will be turned off if the tactical situation requires it or if NVDs are in use.

Figure B-1. Example of a forward arming and refueling operations annex to a tactical standing operation procedure (continued)

Appendix B

- Ground guides will guide aircraft into and out of refueling points using white wands or chemical lights in a color other than green. Ground guides will not stand in front of the aircraft weapon system at any time.
- Aircraft position lights will be flashed to alert ground guide that the aircraft is ready to refuel or to depart.
- The pilot will signal to the refueler to stop refueling the aircraft.
- Radio transmissions will not be made within 100 feet of refuel or rearm points.
- Pilots will ensure that personnel are clear and all grounding clips and cables are removed prior to takeoff.

b. Emergency Procedures During Nontactical Situations.

- (1) **Fire in the refueling area.** In case of fire in the refueling area, personnel should—
 - Stop refueling at all points.
 - Turn all pumps off.
 - Close all valves.
 - Evacuate personnel from the area.
 - Evacuate aircraft from the area.
 - Attempt to fight the fire.
 - Notify higher command, if possible.
- (2) **Fire on supported aircraft.** In case of fire on board supported aircraft, personnel should—
 - Stop refueling at all points.
 - Turn all pumps off.
 - Close all valves.
 - Evacuate personnel from the aircraft that is on fire.
 - Attempt to shut down the aircraft that is on fire.
 - Evacuate all other aircraft from the area.
 - Attempt to fight the fire.
 - Notify higher command, if possible.
- (3) **Fire on FARP aircraft.** In case of fire on board FARP aircraft, personnel should—
 - Stop refueling at all points.
 - Turn all pumps off.
 - Close all valves.
 - Evacuate personnel from the aircraft that is on fire.
 - Attempt to shut down the aircraft that is on fire.
 - Evacuate all other aircraft from the area.
 - Attempt to fight the fire.
 - Notify higher command, if possible.
- (4) **Fuel leaks.** In case of fuel leaks, personnel should—
 - Stop refueling at the affected refueling point.

Figure B-1. Example of a forward arming and refueling operations annex to a tactical standing operation procedure (continued)

Sample Forward Arming and Refueling Point Standing Operating Procedure

- Turn all pumps off.
- Turn the valves to the leak off.
- Repair or replace the affected pieces.
- Open valves and start the pumps.
- Check for additional leaks.
- Proceed with refueling operations.

c. Emergency Procedures During Tactical Situations. If the FARP site is under attack or under a threat of being overrun—

- Stop refueling.
- Evacuate supported aircraft.
- Disconnect aircraft or vehicle being fueled from the fuel supply source/system by disconnecting the 50-foot pot hose from the side of the aircraft or port of the vehicle.
- Abandon the system, such as FARE/AAFARS and evacuate the FARP area.

NOTE: The mission commander will brief all personnel on emergency procedures before the FARP mission begins.

8. EXTENDED RANGE FUEL SYSTEM (FAT COW) OPERATIONS.

a. Storage. FARP personnel will—

- Defuel fuel tanks according to TM 55-1560-307-13&P and the unit SOP.
- Secure all 600-gallon tanks on an asphalt or concrete hardstand that is away from aircraft and ground vehicle operation.
- Statically ground all tanks at the storage area.
- Empty the 600-gallon tanks before storage (except for residual fuel in the bottom of the tanks).
- Drain all fuel supply lines of excess fuel before storage.
- Store all ERFS equipment, such as the pump board, fuel lines, and tie-down straps, in the ERFS storage cases provided by the shipping facility. Ensure that the storage area is enclosed and well-ventilated.

b. Preventive Maintenance Checks and Services. All PMCS criteria for the ERFS are covered in TM 55-1560-307-13&P. FARP personnel will—

- Develop a program for PMCS storage when the ERFS is not installed on the aircraft.
- Conduct a monthly PMCS and an inventory each ERFS system.
- Record PMCS, faults, and corrective actions on DA Form 2404 (Equipment Inspections and Maintenance Worksheet).

c. Installation and Operation. TMs 1-1520-240-10 and 55-1560-307-13&P cover the installation, operation, and PMCS of the ERFS.

(1) When the ERFS is installed on the aircraft, enter the following statement on the DA Form 2408-13-1 (Aircraft Maintenance and Inspection Record): “Aircraft allowed to operate with ERFS installed according to TM 55-1560-307-13&P, dated 11 December 1990”. This entry will be carried forward daily until the ERFS is removed.

Figure B-1. Example of a forward arming and refueling operations annex to a tactical standing operation procedure (continued)

Appendix B

(2) All system faults will be recorded on DA Form 2408-13-3 (Aircraft Technical Inspection Worksheet).

(3) When the ERFS is removed, all faults will be reentered from the aircraft logbook to the ERFS' existing or new DA Form 2404.

d. Mission Equipment. Equipment requirements are divided between two sections. The unit assigned the mission will supply one or more CH-47s, the ERFS system with FARE/AAFARS attachments, and one 50-foot suction hose (pot hose). It will also supply one grounding rod with a grounding cable for the aircraft and all the necessary ground covers, tie-down ropes, and aviation life support equipment. The POL section will supply all of the items shown in Figure 4 and one extra 100-GPM pump, one of each type of refueling nozzle, and one 50-foot refueling hose.

NOTE: The mission unit will install the required number of tanks according to TM 55-1560-307-13&P and Figure 5. If the mission is conducted at extended ranges, this includes the installation of the ERFS fuel management control panel (FMCP).

(1) **Hoses and fittings.** The Army uses the unisex (dry-lock) fitting. The unisex is the preferred fitting because it reduces fuel spillage during assembly and disassembly and it is self-grounded when connected. These fittings are used with the AAFARS, which are the same fittings used with the HTARS hoses.

(2) **Pump system.** If the 250-GPM self-contained pump system is used, the filter separator can be dropped from the equipment list and the pump placed in the 100-GPM position (Figure 4). The size of the pump prevents a spare pump from being loaded.

(3) **Nozzles.** Two types of nozzles are used. The D-1 single-point nozzle is used on CH-47, UH-60, and AH-64 aircraft, and CCR nozzles with attachments are used OH-58D aircraft, unless the D-1 is specified.

e. Site Selection.

(1) The landing zone (LZ) must be large enough to accommodate FARP aircraft with no less than 150 feet between supported aircraft refueling points.

(2) Multiship FARP aircraft will be separated with no less than 300 feet between aircraft. This allows for the 150-foot separation between supported aircraft refueling points.

(3) The FARP site may also serve as the AA and takeoff area for the supported units.

(4) An additional site should be considered if the current site is also being used for rearming.

Figure B-1. Example of a forward arming and refueling operations annex to a tactical standing operation procedure (continued)

Sample Forward Arming and Refueling Point Standing Operating Procedure

(5) Planners should consider the tactical advantages of the site to include the distance to the FARP, stability of the FARP, the required time on station, camouflage, and security requirements. They should also consider wind direction and the type of aircraft to be refueled.

f. Site Layout. For daytime operations, the landing point will be designated and marked with standard visual signals and markers. For night operations, the landing point will be designated and marked with a chemical lights or tactical "Y".

(1) Refueling points and equipment will be set up as shown in Figure 4.

(2) The extra 100-GPM pump will be placed beside the operating pump.

(3) For ease of replacement, all spare pieces of equipment will be placed so they are readily accessible.

(4) Each FARP aircraft will be grounded to its own grounding point.

(5) The 100-GPM pumps and filter separator will be grounded as shown in Figure 4.

(6) Emergency equipment, such as a 5-gallon water can and a fire extinguisher will be placed at the pump station and the refueling points.

g. Fire Extinguishers. All fire extinguishers must have current inspection tags and seals. Authorized fire extinguishers include the following:

- Twenty-pound Halon 1211.
- Twenty-pound (KH CO³) Purple K.
- Fifteen-pound CO².

h. Blade Ropes and Tail Cone Covers.

(1) **Blade ropes.** Crew chiefs install and secure at least one blade rope per rotor system on ERFS aircraft.

(2) **Tail cone covers.** Crew chiefs install engine tail-cone covers on ERFS aircraft to prevent engine foreign-object damage and keep rotors from turning.

i. Crew Duties.

(1) **Pilot in command.**

(a) The pilot in command (PC) of the supporting aircraft is in charge of the FARP operation. He directs all operations and monitors the safety of the FARP setup and refueling operations. He ensures that the FARP is set up according to the SOP and that all required points are grounded. An Air Assault FARP reference checklist (Enclosure 1) may be used upon arrival at the site.

Figure B-1. Example of a forward arming and refueling operations annex to a tactical standing operation procedure (continued)

Appendix B

(b) The PC's station is at the fuel pump, which enables him to monitor all phases of the operation. The PC is responsible for turning off the fuel supply at the pump in the event of a mishap or an emergency.

(2) **Copilot.** The copilot will assist in marshaling and fire guard duties and any other duty that the PC assigns.

(3) **Flight engineer.** The flight engineer (FE) is responsible for safely loading the aircraft before the mission and unloading it after the aircraft is shut down. He also controls the fuel flow from inside the aircraft. In addition, the FE is responsible for cutting off the fuel supply from inside the aircraft in case of a mishap or an emergency.

(4) **Crew chief.** The crew chief will assist in setting up the refueling points. He will also assist with marshaling and fire guard duties.

(5) **POL refuelers.** Refuelers are responsible for setting up the FARP and conducting refueling operations.

j. **Standard Flight Equipment.** Crew members will use standard flight equipment. POL refuelers will use safety equipment and clothing as stated in the SOP and the appropriate regulations.

k. FARP Operations.

(1) **Aircraft position.** When aircraft arrive at the refueling point, there will be assigned personnel on the ground who positions the first aircraft at the first point and the second aircraft at the second point. This procedure continues in chalk order for all aircraft. All aircraft will remain in position until they all have been refueled, and then they will be repositioned to the assembly/takeoff area.

(2) **Fuel transfer.** Fuel will be transferred from the internal tanks in the same manner as if the tanks were being self-deployed. A Fuel Transfer Checklist is included in Enclosure 2. Four-tank fuel transfer will be completed as follows: To maintain the aircraft center-of-gravity, complete fuel transfer in the following sequence:

- Four-tanks: 4, 1, 3, and 2
- Three-tanks: 3, 1, and 2.

(3) **Auxiliary power unit (APU).** The aircraft APU will not be operated during refueling operations.

(4) **Mission operation checklist.** Refer to TM 55-1560-307-13&P for proper ERFs operation and fuel transfer procedures. A mission operation checklist is shown in Enclosure 3.

l. **Environmental Factors.** Environmental factors, such as local water tables, wildlife, and agriculture, will be considered during the planning and execution of the air assault FARP mission.

Figure B-1. Example of a forward arming and refueling operations annex to a tactical standing operation procedure (continued)

Sample Forward Arming and Refueling Point Standing Operating Procedure

9. AQUA-GLO TEST PREPARATION PROCEDURES. FARP personnel will follow the guidance in the applicable TMs for the conduct of Aqua-Glo testing. These procedures are briefly listed below but may not be all-inclusive due to the changes in FM 10-67-1.

a. Put a fully charged battery into the meter assembly. (A fully charged battery will operate the ultraviolet light for about 1 hour. About 30 tests can be performed on one charge.)

b. Turn the ultraviolet lamp assembly upside down and open the test pad slot. Using tweezers take the recalibration standard pad and put it, colored side in toward the lamp, in the test pad slot. Do not touch the pad with your fingers; always handle it with the tweezers. Turn the lamp assembly right side up.

c. Slide the meter assembly into the tracks on the ultraviolet lamp assembly.

d. Recalibrate the meter assembly after each battery change and before each working day as follows:

(1) Turn the ultraviolet lamp on by pushing the lamp switch to ON and by holding the switch down for 10 seconds. When the switch is pushed down, a high-pitched sound is emitted that should drop to a low-pitched sound when the pressure on the switch is released. These sounds indicate that the lamp is on. If the pitch of the sound does not drop when the pressure is released on the switch, the battery needs to be recharged.

CAUTION

Do not leave the switch in the ON position if the red battery test indicator light stays on. If you do, the battery will be ruined and cannot be recharged. If the red light stays on, remove the battery and recharge it. Tester can be connected to vehicle for operation or recharge.

(2) Move the lever on the lamp assembly across its scale to the set number indicated on the recalibration standard pad. For example, if the set number on the pad is 5.3, move the lever to 5.3. Hold the hooded meter switch button in for about 30 seconds until the pointer above the meter scale becomes steady and holds its position.

(3) If the meter pointer does not point to zero, unscrew the plug screw on the side of the meter. Use the small screwdriver provided with the kit to adjust the meter so that the pointer points to zero.

(4) Take the recalibration standard pad out of the test pad slot, using the tweezers, and put it back in the kit pocket.

e. Wipe the green glass light filters with a clean, soft cloth or paper towel.

Figure B-1. Example of a forward arming and refueling operations annex to a tactical standing operation procedure (continued)

Appendix B

10. FUEL SAMPLING PROCEDURES.

a. Couple the detector pad holder assembly, with the toggle valve closed (parallel to the line), to the sampling coupler. The detector pad holder assembly includes plastic tubing, detector pad holder, toggle valve, and sampling coupler.

b. Flush the detector pad assembly as follows:

- Put the end of the plastic tubing in a container that will hold more than a gallon of fuel.
- Open the toggle valve by turning the handle up (at a right angle to the line).
- Let about a gallon of fuel flow through the assembly into the container.
- Close the toggle valve and uncouple the detector pad assembly.

c. Unscrew the two halves of the detector pad holder. Using the tweezers, take a detector pad out of its envelope and put it, yellow side out, in the recess in the outlet side of the pad holder. Screw the pad holder assembly back together. Do not open the pad envelope until you are ready to put the pad in the holder. Do not touch the pad with your fingers; always use the tweezers. The pad can absorb moisture from the air and from skin, causing the test results to be false.

d. Couple the detector pad holder assembly back to the sampling coupler, with the toggle valve closed, and put the end of the plastic tubing into the neck of the plastic sampling bottle.

e. Open the toggle valve and allow 500 milliliters of fuel to flow into the sample bottle. Close the valve.

f. Uncouple the detector pad holder assembly from the sampling coupler, and unscrew the detector pad holder. Slip one prong of the tweezers into the notch in the pad holder, and lift the test pad out.

g. Press the wet test pad between dry paper towels or blotters to remove the excess fuel. Press down on the pad firmly, move the pad with the tweezers to a dry place on the towel or blotter, and press again. Do this several times.

11. FUEL TEST PROCEDURES.

a. Use the tweezers to lift the damp test pad off the towel or blotter, and put it in the test pad slot in the bottom of the ultraviolet lamp assembly. Ensure that the yellow side faces the ultraviolet lamp.

b. Turn on the lamp.

c. Push in on the hooded button of the meter assembly with your left hand. While watching the meter scale, move the lever of the ultraviolet lamp assembly with your right hand until the meter points to zero.

Figure B-1. Example of a forward arming and refueling operations annex to a tactical standing operation procedure (continued)

Sample Forward Arming and Refueling Point Standing Operating Procedure

d. Release pressure on the hooded button and shut off the lamp switch as soon as the meter pointer settles to zero. The meter pointer should stabilize in about one minute.

e. Take the reading from the scale behind the lever at the point where the lever is. With a 500-milliliter sample, this scale reads directly into parts per million (ppm) of water in the fuel. If the reading is 9 ppm or below, the test is finished and the fuel may be used. If the reading is 10 ppm (the lever is at 10) and the meter will not point to zero, follow these procedures:

(1) Repeat the procedures in paragraph 10a through d.

(2) Open the toggle valve and allow 100 milliliters of fuel to flow into the sample bottle. Close the valve.

(3) Repeat the procedures in paragraph 11 and then a through d above.

f. Take the reading from the scale behind the point where the lever is. Multiply that reading by 5 to find the ppm of water in the sample. For example, if the scale reading is 3, there are 15 ppm of water in the fuel. (The maximum reading with the Aqua-Glo test for a 100-milliliter sample is 60 (5 times 12). A 100-milliliter sample is the smallest that will give an accurate test result.

g. Take the fuel and the fuel system equipment out of service immediately if the fuel on retest shows more than 10 ppm of water. Follow the guidance in FM 10-67-1 for inspecting and testing the fuel and equipment.

Figure B-1. Example of a forward arming and refueling operations annex to a tactical standing operation procedure (continued)

Appendix B

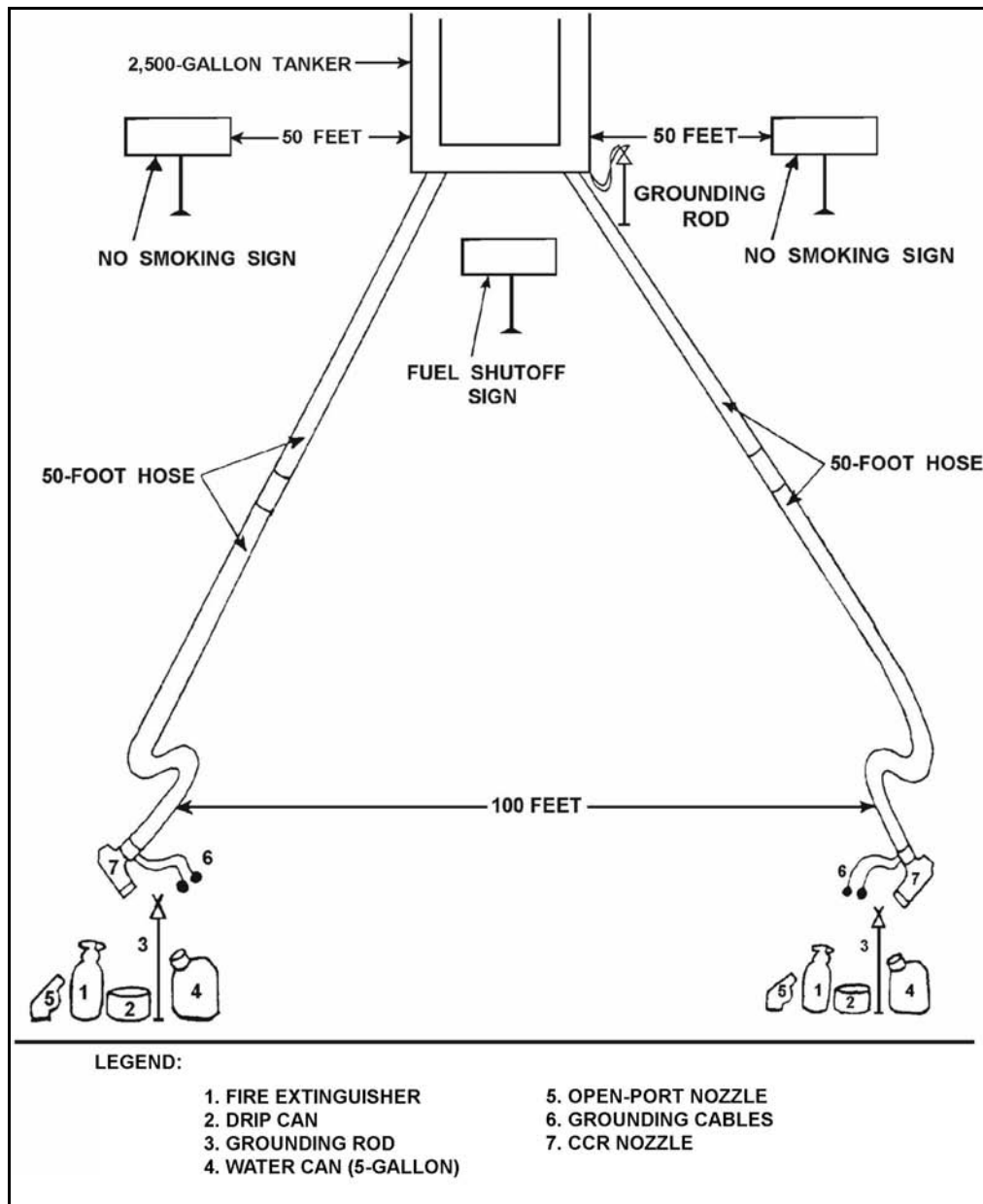

Figure 1. Heavy expanded mobility tactical truck forward arming and refueling point two-point layout

14

Figure B-1. Example of a forward arming and refueling operations annex to a tactical standing operation procedure (continued)

Sample Forward Arming and Refueling Point Standing Operating Procedure

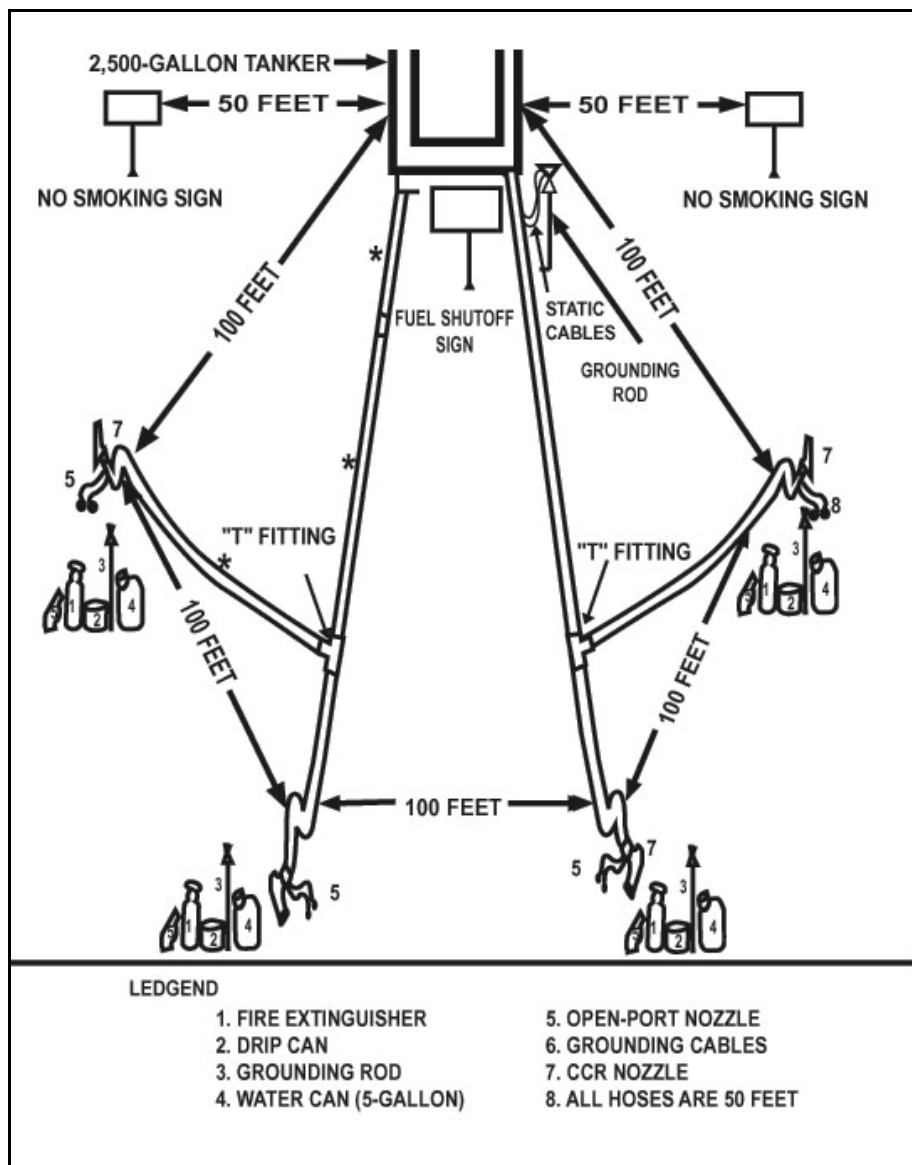

Figure 2. Heavy expanded mobility tactical truck forward arming and refueling point four-point layout

Figure B-1. Example of a forward arming and refueling operations annex to a tactical standing operation procedure (continued)

Appendix B

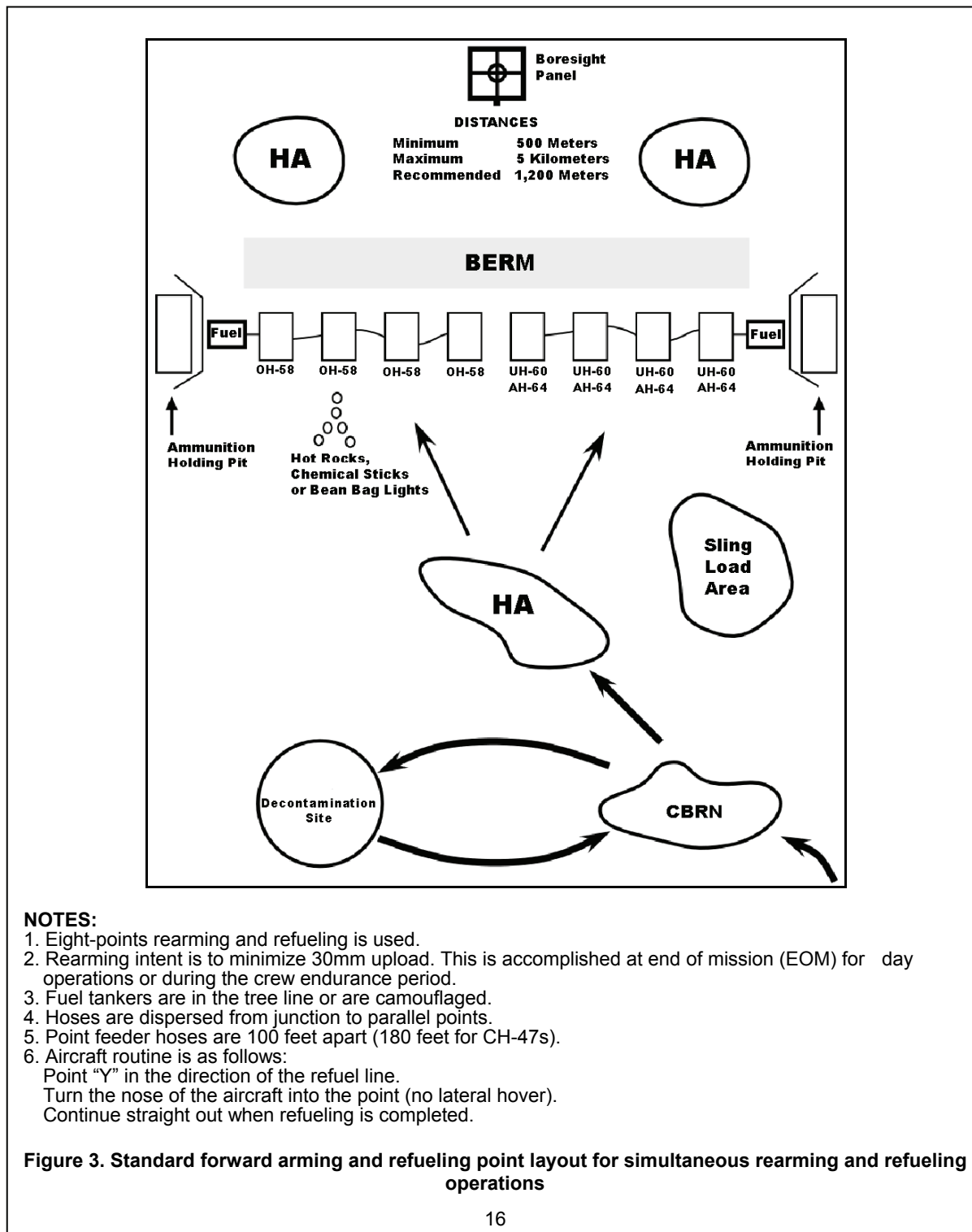

Figure B-1. Example of a forward arming and refueling operations annex to a tactical standing operation procedure (continued)

Sample Forward Arming and Refueling Point Standing Operating Procedure

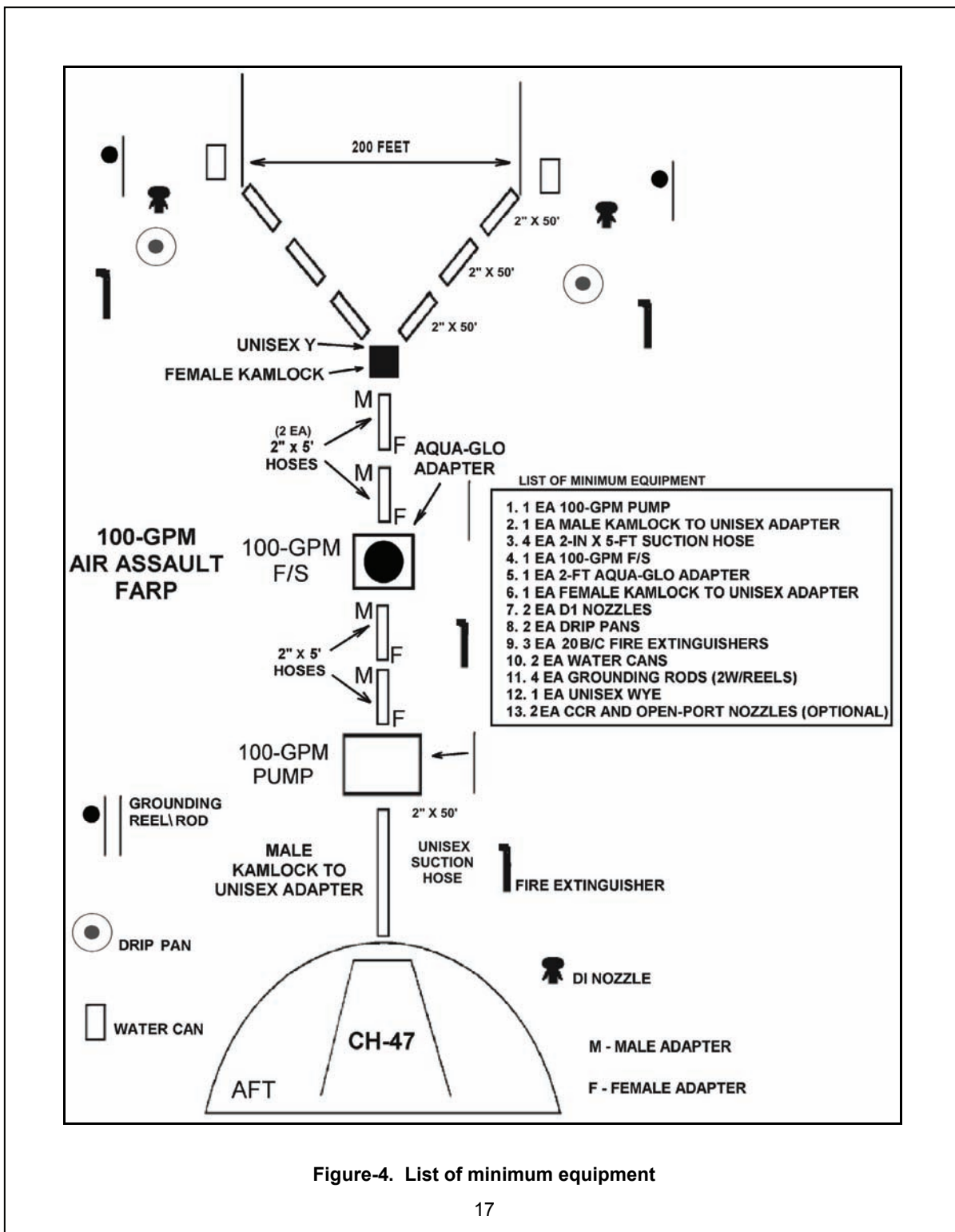

Figure-4. List of minimum equipment

Figure B-1. Example of a forward arming and refueling operations annex to a tactical standing operation procedure (continued)

Appendix B

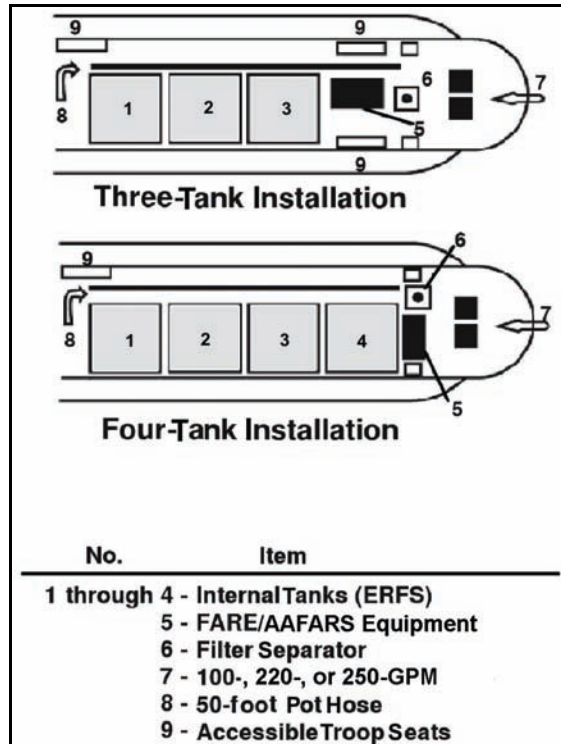

Figure 5. Extended range fuel system tank installation

Figure B-1. Example of a forward arming and refueling operations annex to a tactical standing operation procedure (continued)

Sample Forward Arming and Refueling Point Standing Operating Procedure

1. Ensure that aircraft to be fueled can land into the wind.

2. Conduct a normal engine shutdown.

NOTE: POL personnel may start unloading and setting up equipment. Unless' the chief engineer is needed during the shutdown phase, he may assist with the FARP layout.

3. Stop engines after two minutes.

4. Ensure that the PC/FE secures the aircraft (APU to stop).

5. Ensure that the PC observes and directs the FARP site layout.

6. Ensure that the PC inspects the FARP site layout. (A safety inspection should be conducted to ensure the proper installation of FARP equipment.)

7. Check the FARP system under pressure for leaks.

8. Take a fuel sample using Aqua-Glo test procedures.

9. Record the fuel sample reading.

10. Brief FARP personnel and place them in position.

11. Commence refueling operations.

NOTE: Anyone observing an unsafe practice or procedure will alert FARP personnel. All refueling operations will cease immediately.

Enclosure 1. AIR ASSAULT FARP REFERENCE INSTRUCTIONS UPON ARRIVAL AT SITE

Figure B-1. Example of a forward arming and refueling operations annex to a tactical standing operation procedure (continued)

Appendix B

NOTE 1: To maintain aircraft center of gravity, the tank burn sequence should be 4, 1, 3, 2.

NOTE 2: After all of the aircraft ground checks have been completed, ensure that there is positive fuel flow from the ERFS to the aircraft.

1. Open the cam lever for the appropriate tank.*
2. Turn the forward auxiliary fuel switches off.
3. Turn the aft auxiliary fuel switches off.
4. Place the fuel selector switch to the main tank having the lowest amount of fuel.
5. Initiate fuel transfer when the main fuel tanks on the aircraft have decreased 1,000 pounds or sooner.
6. Turn Pumps #1 and #3 on and hold. (Allow at least a 1-second delay between each pump switch actuation.)*
7. Turn Pumps #2 and #4 on if faster fuel transfer is desired. *
8. Check all hoses and fittings for leaks.*

NOTE: Do not use liquid level indicators for continuous fuel quantity readings during flight.

9. Monitor the fuel levels in the main tanks. Turn all fuel pumps off when the main fuel tanks indicate 1,600 pounds. *
10. Transfer fuel until the low-level warning lights illuminate. Fuel pumps will shut off automatically. Confirm that the fuel pumps are off.*
11. Ensure that the cam lever is closed for the affected tank. *
12. After the refueling operation is complete, verify that all fuel pumps are off and all tank cam levers are closed.*

*These steps require a response from the FE or crew chief when called for by the pilot.

Enclosure 2. EXTENDED RANGE FUEL SYSTEM FUEL TRANSFER SYSTEM INSTRUCTIONS

Figure B-1. Example of a forward arming and refueling operations annex to a tactical standing operation procedure (continued)

Sample Forward Arming and Refueling Point Standing Operating Procedure

1. Before applying electrical power for system operation, perform the checks and services listed in the PMCS, Table 2-6, TM 55-1560-307-13&P.
2. Check all fuel manifold lines, electrical lines, grounding cables, and vent lines for installation, security, and chafing.
3. Check the tank tie-down strap for security and chafing.
4. Check to ensure that the ERFs tank is properly serviced (maximum of 580 gallons per tank). Confirm that the vent lines are uncapped when fuel is in the tank.
5. Take a fuel sample from each tank.
6. Apply power to the ERFs with the APU or with the aircraft engines running.
7. Open the appropriate tank cam levers (dump valves) one at a time.
8. Perform power-on checks as follows:
 - a. Check the operation of the press-to-test indicator lights.
 - b. Turn on Pump #1 and hold it on until the pump engages. Ensure that the ON light illuminates and the pump is running. Turn Pump #1 off, and ensure that the pump shuts off.
 - c. Check to ensure that each pump switch remains engaged after the pressure switch indicates that all pumps are operating. Allow at least a 10-second delay between each pump switch actuation. Turn all pump switches off when the fuel transfer is verified.
 - d. Ensure that the press-to-test fuel low-level light indicates one minute of fuel remains in the tank.
 - e. Turn the override switch to ON, then momentarily turn on anyone pump. Check to ensure that the pump is operative. If it is not, the override switch is defective.
 - f. Check to ensure that all system circuit breakers are in when the power is on.
 - g. Check the entire system for fuel leaks.
 - h. Verify that all pump switches are off.
 - i. Close all tank cam levers.

Enclosure 3. EXTENDED RANGE FUEL SYSTEM MISSION OPERATIONAL PREFLIGHT INSPECTION

Figure B-1. Example of a forward arming and refueling operations annex to a tactical standing operation procedure (continued)

This page intentionally left blank.

Appendix C

Load Plans

Three primary ground vehicles are used to support FARP operations—M978 HEMTT tanker, M977 HEMTT cargo vehicle, and M989A1 HEMAT. Efficient loading of these vehicles will facilitate smooth operations and help ensure adequate support for the mission.

HEAVY EXPANDED MOBILITY TACTICAL TRUCK TANKER

C-1. The HEMTT tanker can carry 2,500 gallons, of which 2,250 gallons are usable. When paired with the HTARS/AAFARS, the HEMTT tanker can simultaneously refuel four aircraft. Figure C-1 shows the front and rear views of the M978 HEMTT tanker.

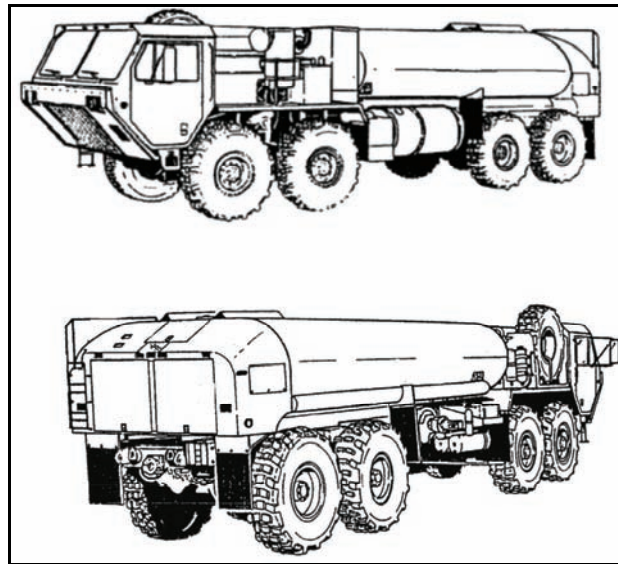

Figure C-1. M978 heavy expanded mobility tactical truck tanker

HEAVY EXPANDED MOBILITY TACTICAL TRUCK CARGO VEHICLE

C-2. The HEMTT cargo vehicle is equipped with a materiel-handling crane with a 2,500-pound load capacity at a 19-foot boom radius. The 18-foot cargo body can carry 22,000 pounds. When carrying ammunition, this truck will cube out before it weighs out. Figure C-2, page C-2, shows the front and rear views of the M977 HEMTT cargo vehicle.

Appendix C

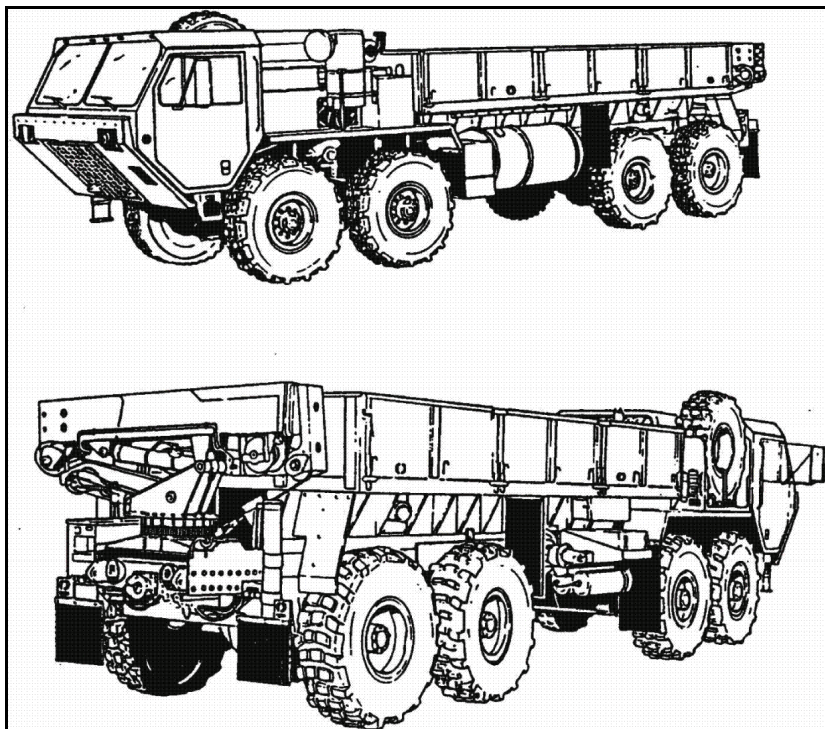

Figure C-2. M977 heavy expanded mobility tactical truck cargo vehicle

HEAVY EXPANDED MOBILITY AMMUNITION TRAILER

C-3. The HEMTT is the prime mover for the HEMAT. The HEMAT can carry 22,000 pounds. Figure C-3 shows the M989A1 HEMAT. Figures C-4 and C-5 (page C-3) and Figure C-6 (page C-4) show suggested ammunition load plans. Figure C-7, page C-4, is the essential load plan key for figures C-4 through C-6.

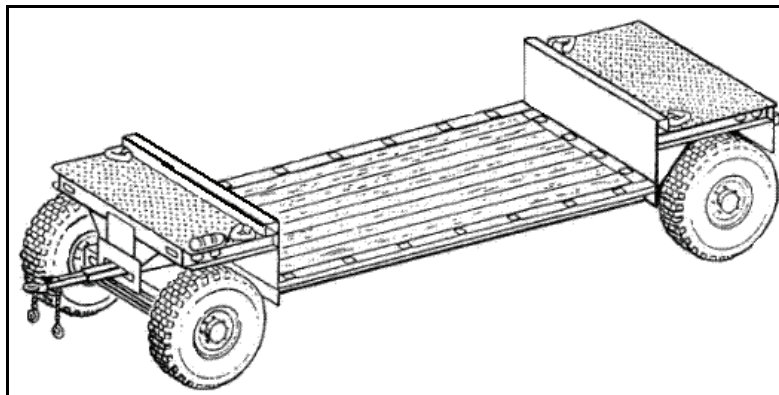

Figure C-3. M989A1 heavy expanded mobility tactical truck

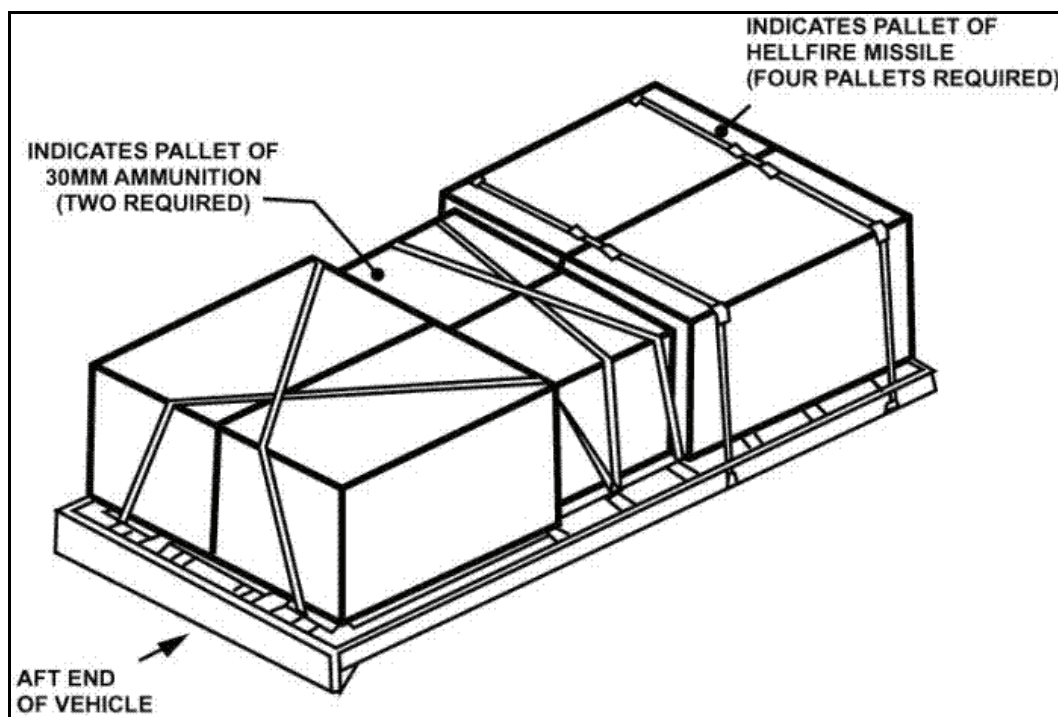

Figure C-4. Suggested ammunition load plan 1

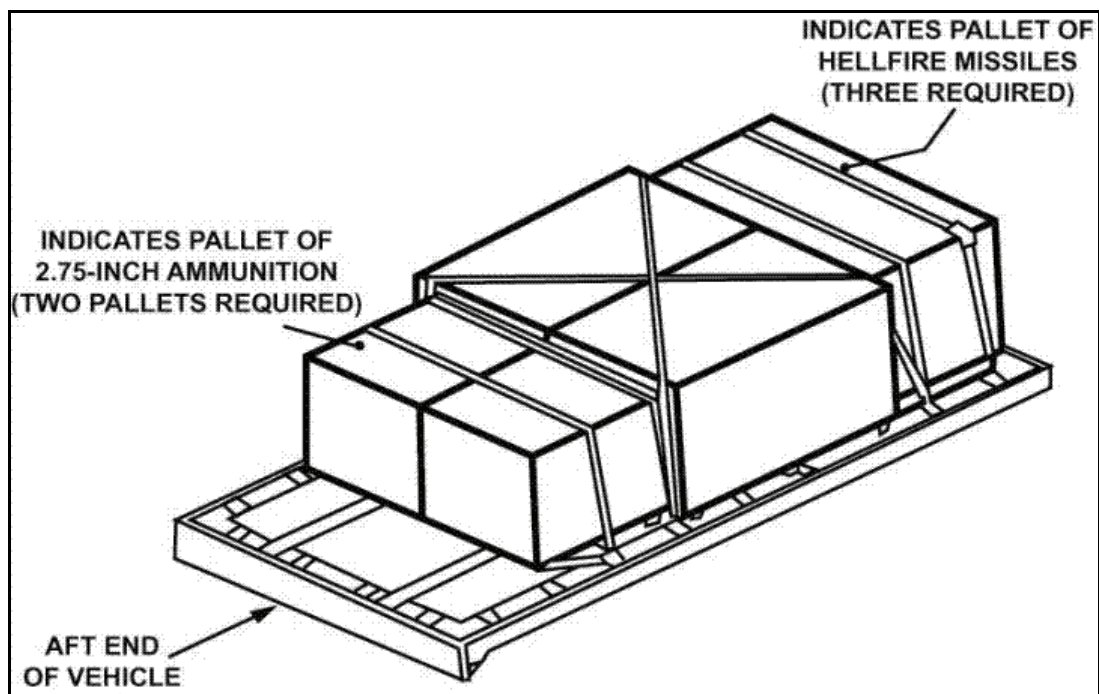

Figure C-5. Suggested ammunition load plan 2

Appendix C

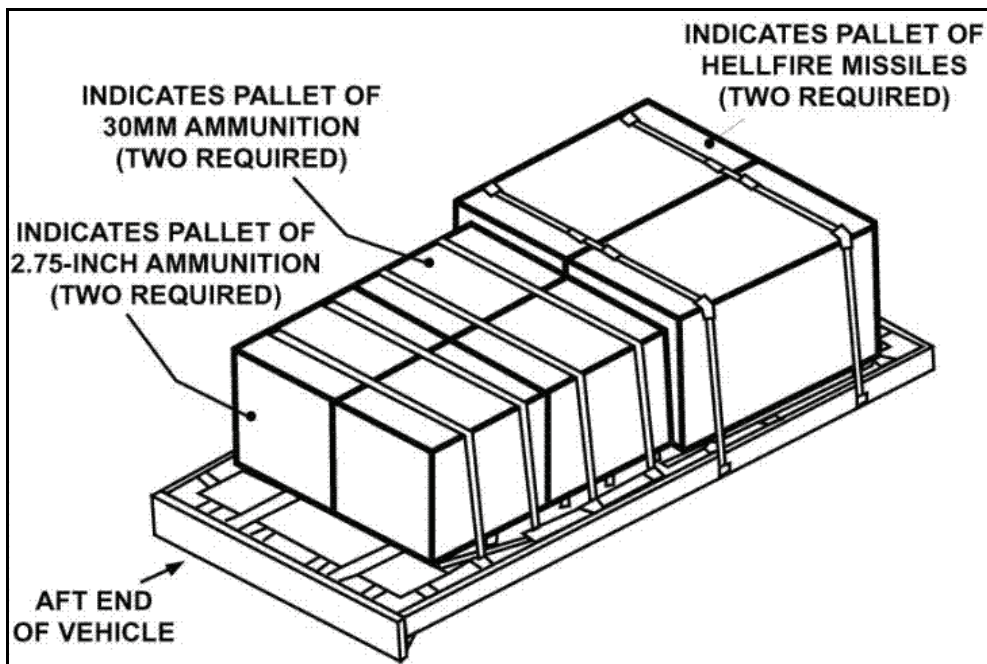

Figure C-6. Suggested ammunition load plan 3

Load Plan 1		
Item	Quantity	Approximate Weight (pounds)
30mm Pallet	2	7,472
Hellfire Pallet	4	7,200
	Total Weight	14,672
Load Plan 2		
Item	Quantity	Approximate Weight (pounds)
2.75-inch Rocket Pallet	2	5,032
Hellfire Pallet	3	5,400
	Total Weight	10,432
Load Plan 3		
Item	Quantity	Approximate Weight (pounds)
Hellfire Pallet	2	3,600
30mm Pallet	2	7,472
2.75-inch Rocket Pallet	2	5,032
	Total Weight	16,104

Note. Units that have aircraft weapons systems that fire .50-caliber ammunition; will configure Load Plan 1 and 3 to meet unit requirements.

Figure C-7. Load plan key

Appendix D

Multiple Forward Arming and Refueling Point Operations

Army doctrine dictates that combat operations be conducted 24 hours a day in any weather. Therefore, FARP operations must be scheduled to provide around-the-clock support. The best way to provide 24-hour support is to employ a two FARP sequence. A schedule that includes two or more FARPs ensures that one FARP is always active, reduces personnel fatigue, and facilitates efficient resupply. This appendix describes multiple FARP operations.

MISSION

D-1. The degree of air superiority and the factors of METT-TC will determine the number of FARPs and the number of refueling points at each FARP. Multiple FARP operations may be necessary. To accomplish this, assets should be arranged to set up two or three independent and mobile FARP operations. The ideal situation would include an active FARP, a silent or relocating FARP preparing to go active, and a rapid reaction air emplaced jump FARP on standby.

D-2. The mode of transportation is determined by the availability of assets and the urgency of the mission. No FARP should stop operation until another FARP becomes operational unless the tactical situation demands otherwise. Splitting Class III/V personnel and equipment into three independent FARPs will be difficult. The organization of each FARP will depend on the mission and the way the commander wants to employ his FARPs. Figure D-1 shows multiple FARP operations.

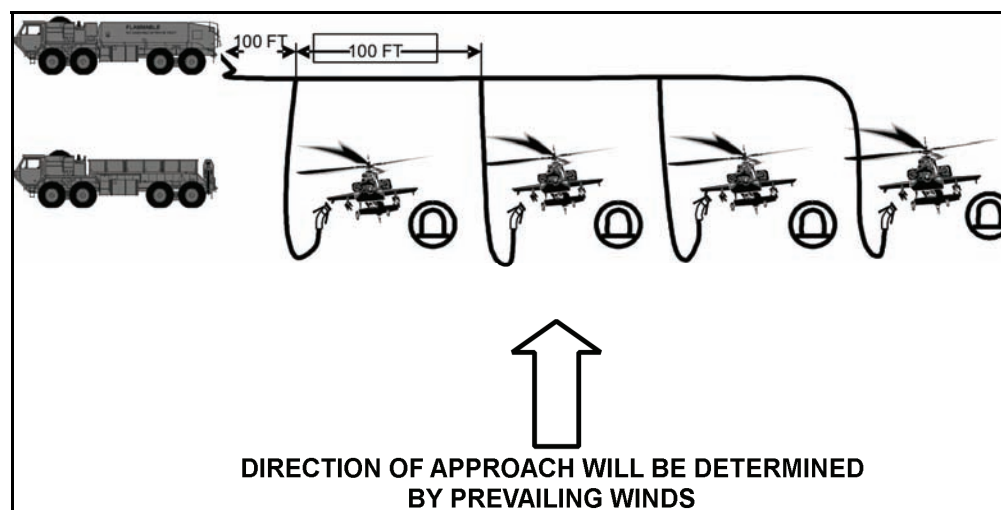

Figure D-1. Multiple forward arming and refueling point operations

D-3. The timing of supplies must be coordinated when multiple FARPs are used. If Class III/V supplies are being pushed forward, the FARP should stop receiving supplies at a designated time. The time should be based on estimated Class III/V usage rates and should allow the FARP to use all of its supplies. Any Class III/V products not used should be transported to the new site. Otherwise, the supplies should be

Appendix D

camouflaged and picked up later. The supplies should be destroyed only as a last resort. TM 750-244-3 provides guidance on the destruction of assets.

D-4. A typical ground-emplaced mobile FARP consists of a HEMTT, HTARS, FARE or AAFARS, a HEMTT cargo truck with trailer, and a HMMWV. This mobile FARP can rearm and refuel four aircraft simultaneously. This FARP will have 9 personnel—two personnel per pad at four pads and one personnel on the truck. This package will support a short duration four-point FARP with no security. The HMMWV is used to lead vehicles to planned FARP locations. This FARP can be done twice, which would provide eight refueling points. When the mobile FARP requires additional Class III or Class V products, it may proceed to the battalion trains area for resupply or it may be aurally resupplied. The silent FARP is identically configured and prepared to assume operations.

D-5. In this example, the mission is to deploy two FARPs forward to support a continuous attack, making the transition to a phased attack of a different target. The S-3 designates two primary sites and their alternates. The scheduled operational times for FARP 1 are 1930. The operational times for FARP 2 are 1,400 and 2,000. In this example, the transition to phased attack requires one of the FARP teams to further split to allow drivers to travel to supply points and/or throughput LRP.

SUGGESTED SCHEDULE

D-6. Figure D-2 illustrates a suggested FARP schedule. It assumes that when one FARP is active, a second silent FARP is inactive. This example also illustrates how a mission change to phased attack would require both FARPs to operate simultaneously.

	Team 1 (Platoon Sgt leads) FARP	Team 2 (Platoon Leader leads) FARP
0800	FARP 1 ACTIVE, Supports A Co	Shuts down old FARP 2; drives to resupply point
0900	FARP 1 ACTIVE, Supports B Co	Drives to resupply point/LRP
1000	FARP 1 ACTIVE, Supports C Co	Arrives at resupply point/LRP; loads/transloads
1100	FARP 1 ACTIVE, Supports A Co	Drives to FARP 2 location
1200	FARP 1 ACTIVE, Supports B Co	Drives to & arrives at FARP 2 location; sets up
1300	FARP 1 ACTIVE, Supports C Co	Continues setup, priority-of-work tasks
1400	Shuts down FARP; drives to resupply points/LRPs	FARP 2 ACTIVE. Supports A Co; offloads Class V trucks; prepares to go to supply point
1500	Drives to resupply points/LRPs	FARP 2 ACTIVE. Supports B Co; platoon leader prepares to split his team; transloads fuel into empty tankers/drums
1600	Arrives at resupply points/LRPs, loads/transloads	Team 2A: Supports C Co. in FARP 2; Team 2B: takes offloaded trucks/tankers and drives to LRPs
1700	Drives to new FARP 1 location	Team 2A: Supports A Co. in old FARP 2; Team 2B: arrives at LRPs, loads/transloads
1800	Arrives at new FARP 1 location; off-loads/ sets up	Team 2A: Supports B Co. in old FARP 2, Team 2B: loaded trucks return to new FARP site
1900	Continues setup, priority of work FARP 1 ACTIVE	Team 2A: Services C Co. in old FARP 2; tears down, moves to new FARP/LRP; Team 2B: loaded trucks arrive/set up new FARP
2000	FARP 1 ACTIVE, Supports A Co	FARP 2 ACTIVE. Supports B Co. (phased attack)
2100	FARP 1 ACTIVE, Supports C Co	FARP 2 ACTIVE. Continues offload of Class V
2200	FARP 1 ACTIVE, Supports A Co	FARP 2 ACTIVE. Supports B Co. (phased attack)

Figure D-2. Suggested forward arming and refueling point schedule

Appendix E

Forward Arming and Refueling Point Safety Requirements

Figure E-1 gives the FARP requirements for safety equipment, nozzles and hoses, aircraft control and equipment, site preparation, before-refueling operations, and site operations.

SAFETY EQUIPMENT
a. Fire extinguishers are present, one for the pump assembly and one for each refueling nozzle. (FM 10-67-1)
b. Fire extinguishers meet the requirements. (FM 10-67-1)
c. Sufficient water is available to wash fuel spills from personnel or to wet fuel-soaked clothing before removing the clothing. (FM 10-67-1)
d. POL handlers are wearing protective clothing. (FM 10-67-1)
e. Explosion-proof flashlights are available for night operations. (FM 10-67-1)
f. NO SMOKING, DANGER, PASSENGER MARSHALING AREA, RESTRICTED AREA, ALARM, and EMERGENCY SHUTOFF signs are posted. (FM 10-67-1)
g. Ignition sources are collected outside the dispensing area. (FM 10-67-1)
h. Grounding rods are being used at pump-filter separator locations and at each dispensing point nozzle. (FM 10-67-1)
i. Grounding rods conform to specifications. (FM 10-67-1)
NOZZLES AND HOSES
a. Each nozzle has proper grounding cable and handling wire attached. (FM 10-67-1)
b. Both closed-circuit and open-port nozzles are available for use. (FM 10-67-1)
c. Dust covers are attached to the nozzle and are used. (FM 10-67-1)
d. The hose has been tested at normal operating pressure with the nozzle closed. (FM 10-67-1)
e. The dispensing hose is long enough to allow minimum required distance between aircraft. (FM 10-67-1)
f. Hoses show signs of blistering, saturation, nicks, or cuts. (FM 10-67-1)
g. Hose nozzle screens are clean. (FM 10-67-1)
h. The hoses are configured in a curved pattern. (FM 3-04.104)
AIRCRAFT CONTROL AND EQUIPMENT
a. The parking area for each fuel dispensing point is clearly marked. (FM 10-67-1)
b. A trained air traffic controller or pathfinder is available at each refueling site (nontactical environment). (FM 10-67-1)
c. The FARP has two-way radio communications with aircraft before and immediately after refueling (nontactical environment). (FM 10-67-1)
d. The refueling site is equipped with a lighting system for night operations. (FM 10-67-1)
SITE PREPARATION
a. The size of the site is adequate for the operation. (FM 10-67-1)
b. The area has been cleared of loose sticks, stones, and other debris that might cause FOD. (FM 10-67-1)
c. The layout ensures proper spacing between aircraft refueling points. (FM 10-67-1)
d. All pieces of equipment and materiel that can be camouflaged are covered with appropriate camouflage. (FM 10-67-1)
e. Vehicles are using one set or existing track marks to reduce the number of tracks. (FM 3-04.104)
f. The selected FARP area and perimeter have been secured. (FM 3-04.104)
g. The vehicles are emplaced to allow timely exit. (FM 3-04.104)

Figure E-1. Forward arming and refueling point requirements

Appendix E

BEFORE-REFUELING OPERATIONS
a. Sufficient personnel are assigned to the equipment—a fireguard, one person to operate the pump, and one person to operate each nozzle. (FM 10-67-1)
b. A fuel sample has been taken from each dispensing nozzle and each fuel source. (FM 10-67-1)
c. The complete system has been checked for proper operation, pressure, and leaks. (FM 10-67-1)
SITE OPERATION
a. There are established communication means to control traffic at refueling locations. (FM 10-67-1)
b. Passengers have been briefed about proper dismounting/mounting procedures, and they go to the marshaling area while the aircraft is refueling. (FM 10-67-1)
c. Ground guides are provided for aircraft. (FM 10-67-1)
d. Ground guides use proper marshaling signals. (FM 10-67-1)
e. Nonessential personnel deplane before refueling. (FM 10-67-1)
f. The fire extinguisher is carried from its position by the grounding rod to the side of the aircraft by the refueling port. (FM 10-67-1)
g. Refueling personnel ensure that all radios are turned off except the radio used to monitor air traffic. (FM 10-67-1)
h. Refueling personnel ensure that armament aboard the aircraft is set on SAFE. (FM 10-67-1)
i. Aircraft are properly grounded before they are refueled. (FM 10-67-1)
j. The nozzle is bonded to the aircraft before the refueling cap is opened. (FM 10-67-1)
k. The dust cap is replaced on the nozzle after each refueling. (FM 10-67-1)
l. Nozzles are replaced on the nozzle hanger (grounding rod) after use. (FM 10-67-1)
m. The nozzle grounding cable is attached to the grounding rod when not in use. (FM 10-67-1)
n. If tank vehicles are used as the fuel source for rapid refueling, the refueling will be properly conducted. (FM 10-67-1)
o. Refueling personnel are familiar with emergency fire and rescue procedures. (FM 10-67-1)
p. Refueling personnel are familiar with procedures in case of a fuel spill. (FM 10-67-1)
q. A copy of the unit's refueling SOP is available, and POL personnel are familiar with its contents. (AR 385-95)
r. Appropriate measures are in place to facilitate reconstitution and recovery of FARP assets in case of damage. (FM 3-04.104)

Figure E-1. Forward arming and refueling point requirements (concluded)

Appendix F

Armament Configurations for the AH-64 and OH-58D

The authorized armament configurations for the AH-64 and OH-58D are shown in figure F-1 and figure F-2, page F-2.

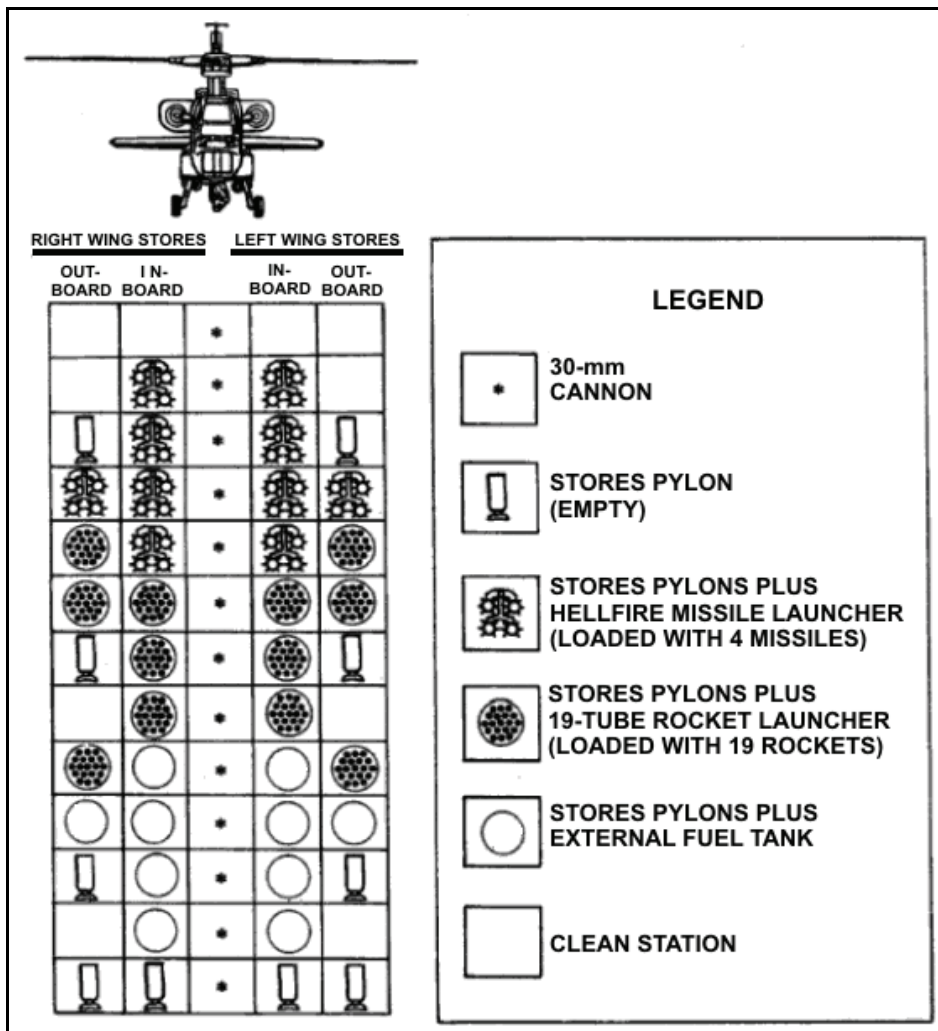

Figure F-1. AH-64 armament configurations

Appendix F

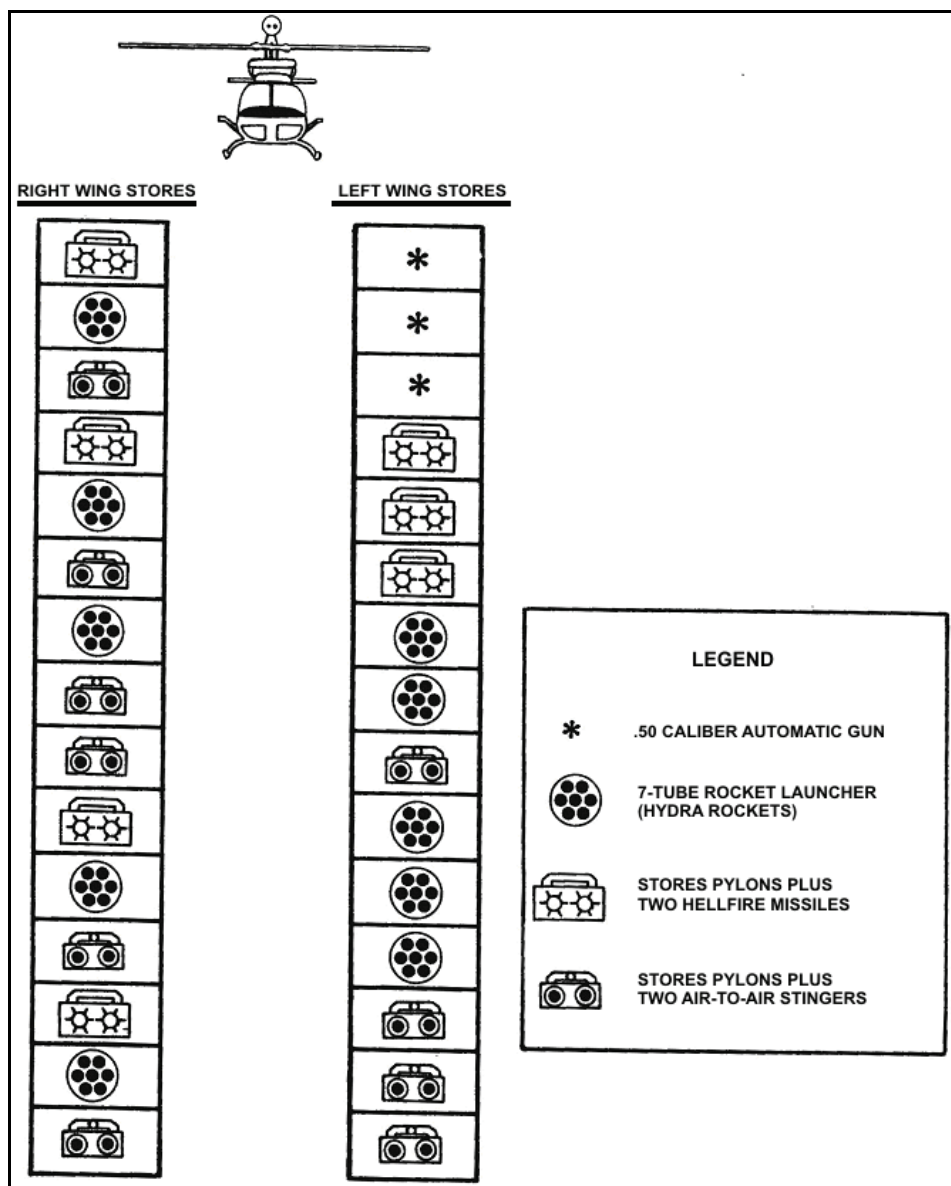

Figure F-2. OH-58D authorized armament configurations

Appendix G

Troop Leading Procedures

The FARP mission requires that certain critical elements be considered during the planning, preparation, and execution phases of the operation. Subordinate leaders will use troop leading procedures to implement the commander's intent (refer to FM 5-0, chapter 4). Figure G-1 outlines these elements.

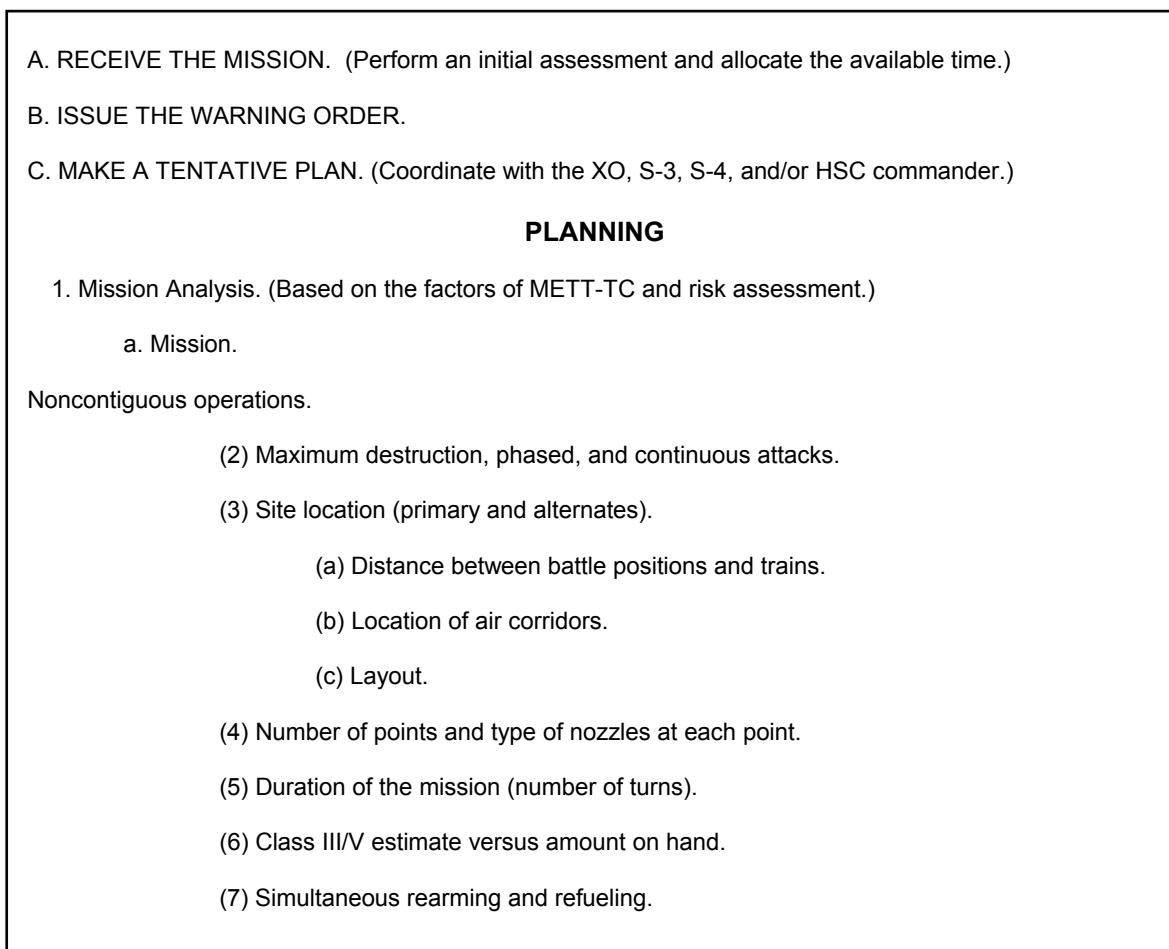

Figure G-1. Critical elements of the forward arming and refueling point planning sequence

Appendix G

- (8) Resupply.
- (9) Certification and safety of FARP plan.
- b. Enemy.
 - (1) Threat briefing from the S-2.
 - (2) Threat weapon system ranges (artillery).
 - (3) CBRN threat.
 - (4) Critical elements of the FARP planning sequence
- c. Terrain and Weather. (Use of terrain to hide aircraft and FARP signature)
- d. Troops Available. (Enough troops available to support the mission)
- e. Time Available. (Duration of mission versus security and Class III/V requirements)
- f. Civilian Considerations. (Civilian populations, cultures, organizations, and leaders within the AO.)
- 2. COA Development. (Analyze relative combat power, generate options, array forces, develop the concept of operations, assign responsibilities, and prepare COA statement and sketch.)
 - a. Emplacement Plan.
 - (1) Air and Ground.
 - (2) Resupply Route Clearance.
 - b. Movement Plan.
 - (1) Major Supply Route Clearance.
 - (2) Advance and/or Quarters Parties.
 - (3) Movement of Assets (separate serials).
 - (4) Convoy Briefing.
 - c. Security Plan.
 - (1) ADA.
 - (2) CBRN (M8 alarms and so forth).
 - (3) Perimeter.
 - d. Site Layout.
 - (1) Sketch or Diagram.
 - (2) Availability of FARP Site Layout to Personnel Before the Mission Begins.
 - (3) Traffic Pattern and Pad Locations.

Figure G-1. Critical elements of the forward arming and refueling point planning sequence (continued)

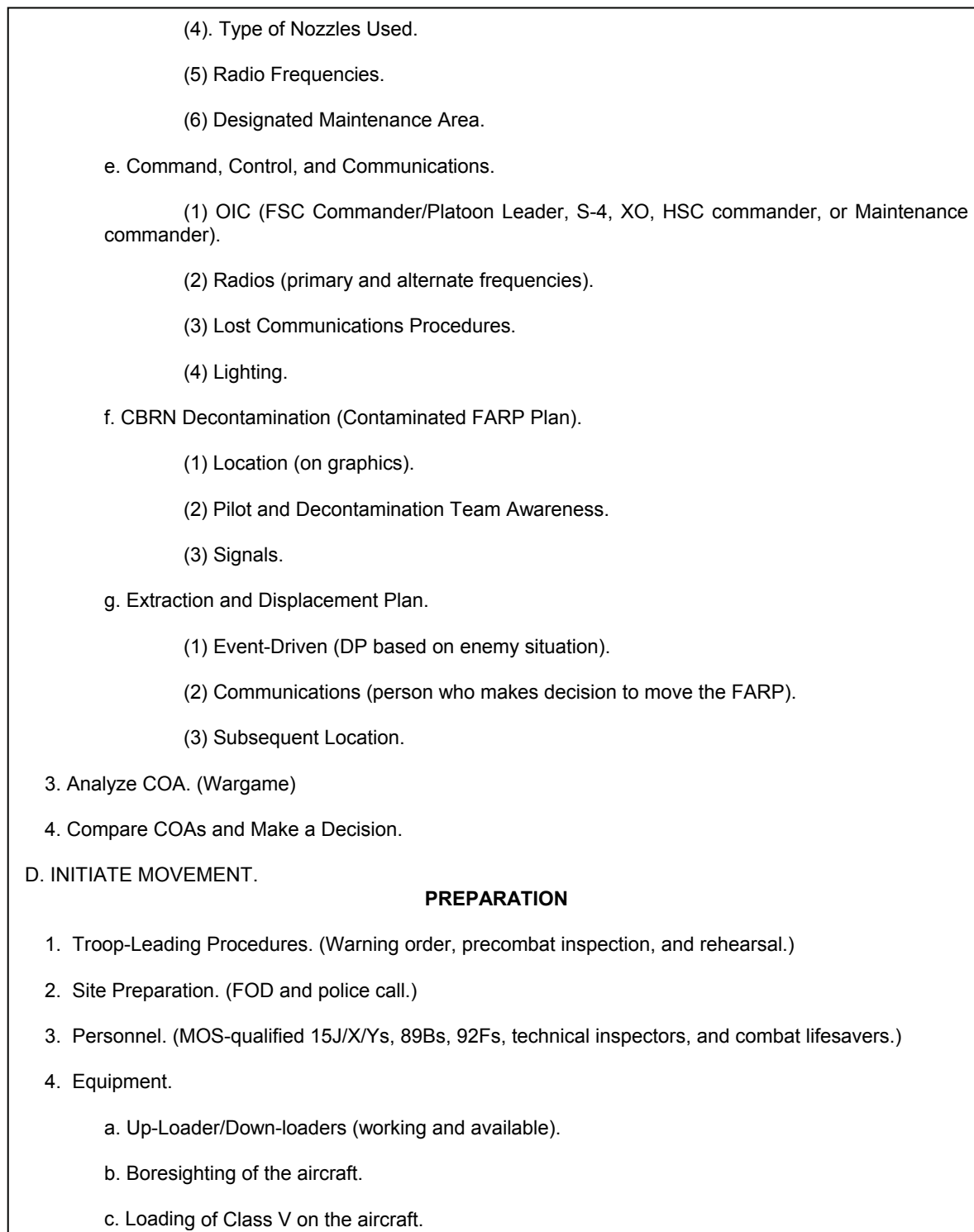

Figure G-1. Critical elements of the forward arming and refueling point planning sequence (continued)

Appendix G

5. Briefing for the Platoon and Noncommissioned Officers.

- a. Mission.
- b. Friendly Situation.
- c. Enemy Situation.
- d. Graphics on Maps.

6. Compliance with Standard Operating Procedures.

E. CONDUCT RECONNAISSANCE.

- 1. Site Preparation. (FOD and police call.)

F. COMPLETE THE PLAN.

G. ISSUE ORDER.

- 1. Normally Verbally
- 2. Supplemented by graphics and other control measures. (Sand table, detailed sketch, maps, and other products to depict the AO and situation.)
- 3. Security around AO.

H. SUPERVISE AND REFINE.

- 1. Confirmation Brief. (Ensure subordinate leaders understand the commander's intent.)
- 2. Backbrief. (Planning versus reacting.)
- 3. Combined Arms Rehearsal. (Requires considerable resources, but provides the most planning and training benefit.)
- 4. Support Rehearsal. (Typically involves coordination and procedure drills for aviation, fire, combat service, engineer support, or casualty evacuation.)
- 5. Battle Drills or SOP Rehearsal. (A collective action rapidly executed without applying a deliberate decision making process; ensures that all parties understand techniques and procedures.)

EXECUTION

- 1. Planning Versus Reacting.
- 2. Enforcing FARP Turnaround Times.
- 3. Gathering and Compiling Class III/IV Premission and Postmission Statistics.
- 4. Ensuring Safe Operations.

Figure G-1. Critical elements of the forward arming and refueling point planning sequence (concluded)

Appendix H

Hazardous Material/Hazardous Wastes Supplies

The supplies listed below can be ordered through the Army Supply System.

CONTAINERS (DOT OR EQUIVALENT)

NSN ITEM

8105-00-848-9631 Bag. Polyolefin. 5 ml. 36 x 54 inch

8125-00-174-0852 Bottle. Plastic 1 gal. (Polyethylene)

8125-00-731-6016 Bottle. Plastic 13 gal.

8125-00-888-7069 Bottle. Plastic 5 gal.

8110-00-254-5719 Drum. Steel. 1 gal.

8100-00-128-6819 1 gal. steel drum (17C)*

8110-00-254-5722 4 gal. steel drum*

8110-00-282-2520 5 gal. steel drum (17C)*

8110-00-254-5713 Drum, steel, 6 gal. (w/Ring)*

8110-01-204-8697 Pail shipping steel 5 gal. (DOT 17E)*

8110-00-519-5618 Drum steel 10 gallon (DOT 17C)*

8110-00735-4643 19 gal. steel drum (17C)*

8110-00-366-6809 30 gal. steel drum (17C)*

8110-00-030-7779 30 gallon steel drum*

8110-00-030-7780 50 gal. steel drum (17C)*

8110-00-823-8121 55 gal. steel drum (17M)*

8110-00-030-9783 Drum steel 55 gal. (Bung & Vent) (DOT 17E)*

8110-01-282-7615 Drum polyethylene 55 gal*

8110-01-101-4055 85 gal. steel Disposal drum (no lining)*

*Refers to Open Top Containers

Appendix H

8110-01-101-4056 85 gal. steel Recovery drum 8Expoxy Phenolic lining)*

8110-01-101-4055 Drum HM*

*Refers to Open Top Containers

For Bung Container refer to Federal Logistics or contact your Assistant Chief of Staff for Logistics (G-4)

ABSORBENT

NSN ITEM

7930-00-296-1272 Clay ground (UL-bag)

1939-01-154-7001 Non Skid Absorbent (UL-40 bag skid)

5640-00-801-4176 Insulation Thermal Vermiculite (UI bag) (packaging material)

4235-01-423-1466 Loose Absorbent 1 CF Bag (4 ea. per box)

4235-01-423-0711 Loose Absorbent 2 CF Bag (3 ea. per case)

4235-01-423-1463 Pads, 18 x 18 x 3 in. (30 ea. per box)

4235-01-423-1465 Socks, 4 in. x 8 ft. (10 ea. per box)

4235-01-423-1467 Socks, 2 in. x 10 ft. (20 per box)

4235-01-423-2787 Boom w/ clamps, 10 in. x 10 ft.

SPILL KITS

NSN ITEM

4235-01-432-7909 Includes: 4 ea. 18 in. x 18 in. pads, 2ea. 2 in. x 5 ft. socks, 1 ea. 3/4 CF bags, 2 ea. waste disposal bags, 1 ea. water resistant nylon tote bag

4235-01-432-7912 Includes: 25 gal. drum with seven 8x18x3-in. pads, one 4-in.x8-ft. sock, two 4-in.x4-ft. socks, one 3/-cu. ft. bag, two Tyvek suits, two pair nitrile gloves, one pair safety goggles and three disposable bags.

4235-01-423-7214 Includes: 55-gal drum with fifteen 18x18x3-in. pads, two 4-in.x8-ft. socks, two 4-in.x4-ft. socks, three 3/4-cu. ft. bags, three Tyvek suits, three pair nitrile gloves, three pair safety goggles and five disposal bags.

4235-01-423-7221 Includes: 55-gal drum with ten 18x18x3-in. pads, five 2x10-ft. socks, five 3/4-cu. ft. bags, two quarts of emulsifier, two pair nitrile gloves, one folding shovel, one 3.5-gal. bucket, two Tyvek suits, two pair safety goggles, one scoop, five disposal bags.

Glossary

SECTION I – ACRONYMS AND ABBREVIATIONS

AA	assembly area
AAFARS	advanced aviation forward area refueling system
ACO	airspace control order
AD	air defense
ADA	air defense artillery
AF	Airframe (see Figure 1-3)
AH	attack helicopter
AMC	aviation maintenance company
AMC/T	aviation maintenance company/troop
AO	area of operations
AOD	airfield operations detachment
APU	auxiliary power unit
AR	Army regulation
ARB	attack reconnaissance battalion
ARMT	Armament (see figure 1-3)
ARS	attack reconnaissance squadron
ASB	aviation support battalion
ASC	aviation support company
ASP	ammunition supply point
AT	antitank
ATHP	ammunition transfer holding point
ATP	ammunition transfer point (see figure 1-3)
ATS	air traffic services
ATTN	attention
AVGAS	aviation gasoline
AVNX	avionics (see figure 1-3)
BAT	battery (see figure 1-3)
BCT	brigade combat team
BDA	battle damage assessment
bde	brigade
BLSA	basic load storage area
BSA	brigade support area

Glossary

C2	command and control
C3	command, control, and communications
CAB	combat aviation brigade
CAFAD	combined arms for air defense
CBRN	chemical, biological, radiological, nuclear
CCR	closed-circuit refueling
CH	cargo helicopter
cl	class
COA	course of action
COM	communication (see figure 1-3)
CP	command post
CTA	common table of allowances
CSS AMO	combat service support automation management office (see figure 1-3)
DA	Department of the Army
DISTRO	Distribution
DOT	Department of Transportation
DP	decision point
DSA	division support area
EA	each
ECWCS	Extended Cold Weather Clothing System
EETF	electronic equipment test facility (see figure 1-3)
ELEC	electrical (see figure 1-3)
EOD	explosive ordnance disposal
EOM	end of mission
ERFS	extended range fuel system
ESSS	External Stores Support System
FARE	forward area refueling equipment
FARP	forward arming and refueling point
FC	fire control (see figure 1-3)
FE	flight engineer
fld	field
FLD FEED	field feeding team (see figures 1-1 and 1-3)
FLIR	forward looking infrared
FLOT	forward line of own troops
FM	field manual or frequency modulation
FMCP	fuel management control panel

FOD	foreign object damage
FRAGO	fragmentary order
FSC	forward support company
FSO	fire support officer
ft	foot
G-4	Assistant Chief of Staff for Logistics
GCU	gas charging unit
GPH	gallons per hour
GPM	gallons per minute
GPS	global positioning system
GSAB	general support aviation battalion
HA	holding area
HARRP	helmet assembly, rearming refueling personnel
HE	high explosive
HF-ALE	high frequency-automated link establishment
HEMAT	heavy expanded mobility ammunition trailer
HEMTT	heavy expanded mobility tactical truck
HMMWV	high mobility multipurpose wheeled vehicle
HQ	headquarters
HSC	headquarters and support company
HTARS	HEMTT tanker aviation refueling system
HM	hazardous material
HW	hazardous waste
HYD	hydraulic (see figure 1-3)
IED	improvised explosive device
in	inch
IR	infrared
JP4	jet propulsion fuel, type 4
JP5	jet propulsion fuel, type 5
JP8	jet propulsion fuel, type 8
km	kilometer(s)
kph	kilometers per hour

Glossary

lbs	pounds
LHS	load handling system (see figure 1-3)
LMTV	light medium tactical vehicle (see figure 1-3)
LRP	logistics release point
LZ	landing zone
MED	medical (see figure 1-3)
METT-TC	mission, enemy, terrain and weather, troops available, time available, civilian considerations
MHE	materials handling equipment
mm	millimeter(s)
MOPP	Mission-oriented protective posture
MOS	military occupational specialty
MTF	maintenance test flight (see figure 1-3)
MTOE	modified table of organization and equipment
NATO	North Atlantic Treaty Organization
NAV	navigation (see figure 1-3)
NCO	noncommissioned officer
NCOIC	noncommissioned officer in charge
NEW	net explosive weight
NOE	nap-of-the-earth
NSN	national stock number
NVD	night vision device
OH	observation helicopter
OIC	officer in charge
OPSEC	operations security
OPTEMPO	operating tempo
PAM	pamphlet
PC	pilot in command
PC	production control (see figure 1-3)
PLS	palletized load system
PMCS	preventive maintenance checks and services
POL	petroleum, oils, and lubricants
ppm	parts per million
psi	pounds per square inch
PT	power train (see figure 1-3)

QC	quality control (see figure 1-3)
RASA	ready ammunition storage area
RSR	required supply rate
S-2	Intelligence Staff Officer
S-3	Operations Staff Officer)
S-4	Logistics Staff Officer
SB	supply bulletin
SEC	section (see figure 1-3)
SO	safety officer
SHORAD	short-range air defense
SOP	standing operating procedure
SPR	single point receptacle
SPO	support operations office (see figure 1-3)
SPLY	supply (see figure 1-3)
spt	support
SSA	supply support activity (see figure 1-3)
STANAG	Standardization Agreement
SVC	service (see figure 1-3)
TACT	tactical aviation control team
TBFDS	tactical bulk fuel delivery system
TM	technical manual
TNDB	tactical nondirectional radio beacon
TOC	tactical operations center
TOE	table of organization and equipment
TPU	tank pump unit
Trans	transportation (see figure 1-3)
TTCS	tactical terminal control system
TSU	telescopic sight unit
UH	utility helicopter
US	United States (of America)
UHF-AM	ultra high frequency-amplitude modulation
UMT	unit ministry team (see figure 1-3)
USAAWC	United States Army Aviation Warfighting Center

Glossary

USAF	United States Air Force
VHF-AM	very high frequency-amplitude modulation
VHF-FM	very high frequency-frequency modulation
WPN	weapon (see figure 1-3)
WTR	water (see figure 1-3)
XO	executive officer

SECTION II – TERMS

None

References

These publications are sources for additional information on the topics in this Field Manual. Most joint publications can be found at <http://www.dtic.mil/doctrine/index.html>. Most Army doctrinal publications are available online at <https://akocomm.us.army.mil/usapa/doctrine/index.html>.

SOURCES USED

These are the sources quoted or paraphrased in this publication.

ARMY PUBLICATION

- AR 95-1. *Flight Regulations*. 3 February 2006.
- AR 200-1. *Environmental Protection and Enhancement*. 21 February 1997.
- AR 200-3. *National Resources—Land, Forest, and Wildlife Management*. 28 February 1995.
- AR 200-4. *Cultural Resources Management*. 1 October 1998.
- AR 385-64. *U.S. Army Explosives Safety Program*. 1 February 2000.
- AR 385-95. *Army Aviation Accident Prevention*. 10 December 1999.
- AR 710-2. *Supply Policy Below the National Level*. 8 July 2005.

COMMON TABLE OF ALLOWANCES

- CTA 50-900, *Clothing and Individual Equipment*. 9 April 2005.
- CTA 50-909, *Field and Garrison Furnishings and Equipment*. 9 April 2005

DEPARTMENT OF THE ARMY PAMPHLET

- DA PAM 200-1. *Handbook For Environmental Impact Analysis*. 17 January 2002.
- DA PAM 385-64. *Ammunition and Explosives Safety Standards*. 15 December 1999.

FIELD MANUALS

- FM 3-04.140. *Helicopter Gunnery*. 14 July 2003.
- FM 3-19.1. *Military Police Operations*. 22 March 2001.
- FM 4-30.1. *Munitions Distribution in the Theater of Operations*. 16 December 2003.
- FM 5-0. *Army Planning and Orders Production*. 20 January 2005.
- FM 10-67-1. *Concepts and Equipment of Petroleum Operations*. 2 April 1998.
- FM 10-450-3. *Multiservice Helicopter Sling Load: Basic Operations and Equipment*. 10 April 1997.
- FM 20-3. *Camouflage, Concealment, and Decoys*. 30 August 1999.
- FM 20-32. *Mine/Countermining Operations*. 29 May 1998.
- FM 10-67-1. *Concepts and Equipment of Petroleum Operations*. 2 April 1998.
- FM 10-450-3. *Multiservice Helicopter Sling Load: Basic Operations and Equipment*. 10 April 1997.

SUPPLY BULLETIN

- SB 710-2. *Supply Control Combat Consumption Rates for Ground and Aviation-Type Petroleum Products*. 12 March 1993.

References

STANDARDIZATION AGREEMENTS

- STANAG 2999 (Edition 6). *Use of Helicopters in Land Operations*. 13 September 2004. Allied Tactical Publication-49(D), Volumes 1 (Doctrine) and II (Tactics, Techniques, and Procedures). *Use of Helicopters in Land Operations*. September 2004
- STANAG 3117 (Edition 7). *Aircraft Marshalling Signals*. 11 June 1999.

TECHNICAL MANUALS

- TM 1-1520-240-10. *Operator's Manual for Army CH-47D Helicopters*. 31 January 2003.
- TM 1-1520-248-10. *Operator's Manual for Army OH-58D Helicopters*. 15 March 2005.
- TM 1-1560-312-10. *Operator's Manual for Extended Range Fuel System II (ERFS II) Configured for the Army Ch-47 Helicopter*. 30 September 2000.
- TM 9-1340-222-20. *Unit Maintenance Manual for 2.75-Inch Low Spin, Folding Fin Aircraft Rockets: 2.75-inch Spin Stabilized Wrap Around Fin Aircraft Rockets; 66-MM Light Antitank Weapon Systems: 3.5-Inch Rockets and M3A2E1 Rocket Mortar (JATO)*. 30 September 1994.
- TM 55-1560-307-13&P. *Operator, Aviation Unit and Aviation Intermediate Maintenance Manual With Repair Parts and Special Tools List for Extended Range Fuel System Army Model CH-47 Helicopter*. 11 December 1990.
- TM 750-244-3. *Procedures for Destruction of Equipment to Prevent Enemy Use*. 23 September 1969.

DOCUMENTS NEEDED

These documents must be available to the intended users of this publication.

DEPARTMENT OF THE ARMY FORMS

- DA Form 581. *Request for Issue and Turn-in of Ammunition*.
- DA Form 2028. *Recommended Changes to publications and Blank Forms*.
- DA Form 2404. *Equipment Inspection and Maintenance Worksheet*.
- DA Form 2408-13-1. *Aircraft Maintenance and Inspection Record*.
- DA Form 2408-13-3. *Aircraft Technical Inspection Worksheet*.

READINGS RECOMMENDED

These sources contain relevant supplemental information.

- AR 700-19. *U.S. Army Munitions Reporting Systems*. 1 January 2001.
- FM 3-0. *Operations*. 14 June 2001.
- FM 44-8. *Combined Arms for the Air Defense*. 1 June 1999.
- FM 1-100. *Army Aviation Operations*. 21 February 1997.
- FM 3-04.111. *Aviation Brigades*. 21 August 2003.
- FM 21-60. *Visual Signals*. 30 September 1987.
- FM 3-34. *Engineer Operations*. 2 January 2004.
- FM 71-100. *Division Operations*. 28 August 1996.
- FM 55-30. *Army Motor Transport Units and Operations*. 27 June 1997.
- FM 8-10-6. *Medical Evacuation in a Theater of Operations, Tactics, Techniques, and Procedures*. 14 April 2000.
- FM 10-450-4. *Multiservice Helicopter Sling Load: Single-Point Rigging Procedures*. 30 May 1998.

References

FM 10-450-5. *Multiservice Helicopter Sling Load: Dual-Point Rigging Procedures*. 30 August 1999.

FM 4-25.11. *First Aid*. 23 December 2002.

FM 21-16. *Unexploded Ordnance (UXO) Procedures*. 30 August 1994.

FM 4-30.13. *Ammunition Handbook: Tactics, Techniques, and Procedures for Munitions Handlers*. 1 March 2001.

STANAG 2946 (Edition 1(4)). *Forward Area Refueling Equipment*. 19 July 1983.

TM 1-1520-237-10. *Operator's Manual for Army UH-60A Helicopters, EH-60A Helicopters, EH-60A Helicopters*. 1 May 2003.

TM 1-1520-238-10. *Helicopter, Attack, AH-64A Apache*. 22 December 2005.

This page intentionally left blank.

Index

A

Advanced aviation forward area refueling system. (AAFARS), 3-2, 3-4, 3-7, 3-9, 3-17, 3-19, 3-21, 3-22, 3-23, 3-35, 5-2, 5-3, D-5

Advance party, 3-2, 3-2, 3-19, 3-20

Additional conditions and characteristics, 5-4

Aircraft control, 2-1, 2-3, 5-4, E-2

Aircraft flow and mix, 3-36
aircraft mix, 3-37
limitations, 3-36

Air guards, 3-4
vehicle horns, 3-4

Air traffic services (ATS), 1-5, 2-1, 2-2,

Ammunition
basic load storage area (BLSA), 3-32, 3-33
handlers, 3-32
load plan, C-3, C-4
RASA, 3-32, 3-33, B-2
safety procedures, 3-32
storage, 3-33

Argon gas, 4-4 - 4-6

Armament configurations, 3-35
AH-64, F-2
OH-58D, F-2

Arming operations, 3-33
Volcano 3-17- 3-19
armament configurations, 3-35, F-2
armament pad setup, 3-33
personnel requirements, 3-35

Arming signals, 2-5

Attack reconnaissance battalion (ARB), 1-1, 1-2, 1-4, 1-5, 3-5, 3-37, 4-3, 4-4

B

Basic load storage area (BLSA), 3-32, 3-33

Battle damage assessment (BDA), 1-2, 1-4

C

Checkpoints, 2-3, 3-20

Class III, 1-1, 1-2, 1-4, 1-5, 2-4, 2-5, 3-7, 3-8, 3-19, 3-35, 4-1, 4-3, 4-4, D-1

Class V, 3-3, 3-4, 4-2 - 4-4, 4-6, 4-7, D-2

Class III requirements, 4-3

Class V requirements, 3-3, 4-4

Command and Control (C2), 1-4, 2-1

Command, control, and communications (C3), 2-1

Convoy, 3-1 - 3-3, 3-20, G-2

D

Deep attack, 1-1

Desert operations, 5-2 - 5-4
communications during, 5-3
conditions and characteristics, 5-4
forward area refueling equipment system, 5-3
flying techniques, 5-3
high-density altitude during 5-3
mobility, 5-2
terrain, 5-2, 5-3

Dust cap, 3-17, 3-18, 3-26, 3-31, E-2

E

Emplacement, 3-3, 3-4, 5-4
advantages/disadvantages, 3-18
aircraft delivery, 3-8
equipment layout, 3-16
fat cow, 3-9
ground vehicles, 3-7
grounding and other equipment, 3-17
jump FARP, 3-9
joint aircraft assets. 3-13
METT-TC, 3-4

operation, 3-17
site considerations, 3-16
volcano, 3-18

Employment, 1-1, 3-1

Engineers 3-3, 3-18, 3-27

Equipment setup, 3-24, 3-29

Extended range fuel systems (ERFS), 3-9

Extended range fuel systems II (ERFS II), 3-12

F

Forward area refueling equipment (FARE), 3-1, 3-2, 3-4, 3-7, 3-9, 3-12, 3-13, 3-18, 3-19, 3-21, 5-1

Forward arming and refueling point (FARP)
active, 3-1, D-1
aircraft control and safety in the, Figure B-1
aircraft procedures in the, Figure B-1
Aqua-Glo test preparation procedures in the, Figure B-11
camouflage, 1-4, 3-2, Figures B-1 and E-2
communications, 2-1, 2-5, 4-1, 5-3, Figures B-1 and E-2
emplacement in the , 3-4, 3-8, 5-5, 6-1, B-1, B-2
equipment setup in the, 3-24, 3-31
extraction and displacement plan, G-3
fuel sampling procedures in the, B-12
fuel test procedures in the, Figure B-12
helicopter spacing in the, 3-23, E-1
jump, 3-1, 3-3 - 3-5, 3-9, D-1

Index

- location of, 1-3, 2-4, 2-5, 3-4 - 3-6, 3-21, 3-35, 4-1, 4-2, 5-1, D-2
- movement and resupply of the, 3-4
- multiple operations, D-1
- organization, 1-1, Figure B-1
- personnel, 1-4, 3-17, 3-27, 3-32, 3-35
- purpose of a, 1-1
- rearming operations, 3-1, B-4
- refueling operations, 3-5, 3-9, 3-13, 3-26, 5-1, E-1, E-2, Figure B-1
- relocation, 3-20
- resupply, 3-13, 4-1, B-2
- safety requirement, 3-31, E-1
- security, 3-20, B-1
- setup, 3-22, 3-31, 5-3, B-5
- silent, 3-1, 3-4, 3-6, B-2, D-2
- site selection, 3-1, B-1
- site preparation, 3-38, E-1
- size of the, 3-4, 3-6, 3-15
- survivability of the, 1-4, 3-3, 3-13, 3-20
- Fat Cow, 3-9, Figure 3-4, B-7
- Fat Hawk, 3-13
- Fighter Management/Crew Endurance, 1-4
- Filter/separator, 3-7, 3-17, 3-18, 3-27
- Foreign object damage (FOD), 2-3, 3-32, B-1, E-1
- Fuel consumption rates, 4-2, 4-3, Table 4-2
- Fuel spills, 3-2, 6-2
- assessment, 6-3
- cleanup, 6-4
- definition, 6-2
- discovery, 6-3
- spill kits, 6-4
- reacting to, 6-5, 6-6
- G**
- Ground guide, 2-3, 2-4, 5-4, B-6, E-2
- H**
- Heavy expanded mobility ammunition trailer (HEMAT), 3-7, C-1
- Heavy extended mobile tactical truck (HEMTT), 3-2, 3-4, 3-7, 3-21, 4-4, C-2, E-2
- Helicopter spacing, 3-23, E-1
- Helmet assembly, rearming refueling personnel. (HARRP), 2-5, 3-28
- HEMTT tanker aviation refueling system (HTARS), 3-7, 3-15 - 3-17, 3-24 - 3-26, B-8, C-1
- High mobility multipurpose wheeled vehicle (HMMWV), 2-2, 3-7, D-2
- Hoses, 3-9, 3-14, 3-16, 3-18, 3-21, 3-22, 3-24 - 3-26, E-2
- Hoses, nozzles, grounding equipment, and valves, 3-21, 3-22
- I**
- Intelligence, 1-5
- L**
- Load plans, 3-3, 4-4, C-1
- M**
- Map reconnaissance, 3-1, 3-2, 3-4
- Marker panels, 2-3, 2-4, 5-4
- Material handling equipment. (MHE), 1-4, 3-7, 3-9, 3-19, 4-1
- mission, enemy, terrain and weather, troops available, time available, civilian considerations (METT-TC), 2-1, 2-5, 3-5, 3-6, 3-27, D-1
- Mission-oriented protective posture (MOPP), 3-37, 3-38
- Movement plan, 3-3, Figure G-2
- N**
- Night operations, 3-37
- artificial lights, 5-1
- light discipline, 2-4, 5-1
- mark obstacles for, 5-1
- Night vision devices (NVDs), 2-5, 3-23, 3-37, 5-1, 5-2, B-4
- Nozzles, 3-16 - 3-22, 3-24 - 3-31, Figures 3-20 - 3-23 and E-2
- O**
- Operations
- Linear battlefield, 3-4
- Nonlinear and noncontiguous battlefield, 3-4, 3-20, 4-1, 4-7
- P**
- Pump assembly, 3-21, 3-22, 3-29 - 3-31, E-1
- Q**
- Quick reaction force, 3-20
- R**
- Refuelers, 3-17, 3-18, 3-35, B-10
- protective clothing for, 3-27, 3-37, E-1
- Refueling operations, 3-5, 3-9, 3-13, 3-26, 3-27, 5-1, B-1, E-1, E-2
- center point, 3-22, 3-30
- closed-circuit, 3-17, 3-29, 3-31, E-1
- cold, 3-28, 5-4
- hot, 3-17, 3-24, 3-28, B-3
- open-port, 3-22, 3-26, 3-28 - 3-31, E-1
- personnel requirements for, 3-35, B-4
- Relocation, 3-1, 3-20, 3-21, 3-38
- Rolling FARP, 3-1, 3-2, 5-2
- S**
- Scatter plan, 3-20
- Security, 1-4, 3-1 - 3-5, 3-20, B-1
- Simultaneous arming and refueling, 1-1, 3-17 - 3-19
- Site preparation, 3-38, E-1, G-4

Standard hand and arm
signals, 2-4, 2-5, 5-2, 5-4,
A-1, B-3

Static electricity, 3-28, 3-29,
3-31, 5-5

Stinger assets, 3-19

Supply point distribution, 4-2

Support equipment, 3-22, 3-26,
B-8

fuel sampling kit, 3-22

fuel source, 3-22, 3-23, 3-
34, 5-3, E-2

Survey, 3-2

Sustainment, 3-3, 4-1

T

Tactical enabler, 1-1, 1-5, 3-1

air defense, 1-5

field artillery, 1-5

intelligence, 1-5

Threat, 1-5, 1-6, 6-3, B-7

Traffic layout, 2-3, 2-4

Training, 3-37, 3-38

individual and collective,
3-38

operation skills, 3-38

qualification, 3-37

realism, 3-38

Transportation, 4-6, 4-7

planning considerations,
4-6

planning options, 4-7

Troop leading procedures, G-1

U

Unit distribution, 4-2

V

Valves, 3-17, 3-18, 3-21, 3-22,
3-25, 3-26, 3-35, B-4

Vehicle horns, 3-4

Visual signals, 2-3, B-9

W

Waste fuel plan, 3-27

Wet Hawk, 1-4, 3-14, 3-13

Wind and rotor wash, 3-23

Winter operations, 5-4

This page intentionally left blank.

FM 3-04.104

3 August 2006

By Order of the Secretary of the Army:

Official:



JOYCE E. MORROW

*Administrative Assistant to the
Secretary of the Army*

0619401

PETER J. SCHOOMAKER
*General, United States Army
Chief of Staff*

DISTRIBUTION:

Active Army, Army National Guard, and U.S. Army Reserve: To be distributed in accordance with the initial distribution number (IDN) 110711, requirements for FM 3-04.104.

This page intentionally left blank.

