

MHI
Copy 3

LIBRARY

FM 24-5

WAR DEPARTMENT

BASIC FIELD MANUAL



SIGNAL COMMUNICATION

October 19, 1942

OFFICE CHIEF OF MILITARY HISTORY
Rm. 714, 49 "D" Street, N.E.,
Washington 25, D.C.

**MHRC
COPY**

NOTE.—This is not a revision. This manual contains only C 1, 31 July 1943, C 2, 30 August 1943, and C 3, 20 September 1943, to the 19 October 1942 edition placed at the back following the original text, and will not be issued to individuals possessing that edition.

FM 24-5

BASIC FIELD MANUAL



SIGNAL COMMUNICATION



NOTE.—This is not a revision. This manual contains only C 1, 31 July 1943, C 2, 30 August 1943, and C 3, 20 September 1943, to the 19 October 1942 edition placed at the back following the original text, and will not be issued to individuals possessing that edition.

**UNITED STATES
GOVERNMENT PRINTING OFFICE
WASHINGTON : 1942**

WAR DEPARTMENT,
WASHINGTON, October 19, 1942.

FM 24-5, Basic Field Manual, Signal Communication, is published for the information and guidance of all concerned.

[A. G. 062.11 (7-7-42).]

BY ORDER OF THE SECRETARY OF WAR:

G. C. MARSHALL,
Chief of Staff.

OFFICIAL:

J. A. ULIO,
Major General,
The Adjutant General.

DISTRIBUTION:

Bn and H 1-11, 17, 18, 19 (5); C 11 (10); IC 1-7, 17,
18, 19 (10); 11 (20).

(For explanation of symbols see FM 21-6.)

TABLE OF CONTENTS

	Paragraphs	Page
CHAPTER 1. General.		
SECTION I. General	1-4	1
II. Organization.....	5-9	2
III. Command and staff duties of signal and communication officers.....	10-12	5
IV. Disposition of matériel.....	13-16	8
CHAPTER 2. Message center.		
SECTION I. General	17-35	13
II. Procedure for divisions and higher units.....	36-42	31
III. Procedure in headquarters below di- vision.....	43-48	53
IV. Military cryptography.....	49-54	62
V. Cipher device M-94.....	55-61	70
VI. Converter M-209.....	62	81
CHAPTER 3. Messenger communication.		
SECTION I. General	63-65	83
II. Training of personnel.....	66-71	84
III. Employment.....	72-81	86
IV. Dropped messages.....	82-85	91
V. Pick-up of messages.....	86-90	94
CHAPTER 4. Pigeon communication	91-93	100
CHAPTER 5. Radio communication.		
SECTION I. General	94-100	109
II. Tactical radio nets.....	101-108	115
III. Operating regulations.....	109-114	119
IV. Station records.....	115-120	122
CHAPTER 6. Visual communication.		
SECTION I. General	121-122	127
II. Lamps.....	123-130	130
III. Flags.....	131-136	136
IV. Ppotechnics.....	137-142	140
V. Panels.....	143-155	144
VI. Airplane maneuvers as signals.....	156	154
CHAPTER 7. Communication by sound	157-160	156
CHAPTER 8. Wire communication.		
SECTION I. General	161-182	158
II. Field wire line construction.....	183-208	181
III. Field telephones and centrals.....	209-226	239
IV. Field telegraph sets and stations.....	227-233	253
V. Maintenance of field wire systems.....	234-243	255
CHAPTER 9. Signal supply	244-254	271
CHAPTER 10. Orders, records, and reports	255-265	278
APPENDIX I. Wire communication equipment		327
II. List of references.....		365
III. International Morse Code.....		367
INDEX		369

BASIC FIELD MANUAL

SIGNAL COMMUNICATION

(This pamphlet supersedes FM 24-5, Basic Field Manual, Signal Communication, November 1, 1939, including Training Circulars Nos. 3, 28, 53, and 56, 1941, and Training Circular No. 8, 1942.)

CHAPTER 1

GENERAL

	Paragraphs
SECTION I. General	1-4
II. Organization	5-9
III. Command and staff duties of signal and communication officers	10-12
IV. Disposition of matériel	13-16

SECTION I

GENERAL

■ 1. **FUNCTIONS.**—Signal communication enables a commander to send and receive information and orders.

■ 2. **OBJECT.**—The object of this manual is to furnish basic information governing signal communication essential to officers and enlisted men of all arms engaged in communication activities.

■ 3. **SCOPE.**—The scope of this manual includes the methods and technique relating to the installation, operation, maintenance of, and planning for signal communication with special emphasis on such systems employed within the division and smaller units.

■ 4. **REFERENCES.**—*a. Training publications.*—For a complete list of War Department training publications, see FM 21-6. See appendix II for a reference list for Signal Corps equipment and activities.

b. *Miscellaneous*.—(1) *Army Regulations*.—Instructions relating to signal communication and Signal Corps activities are found in the AR 105-series.

(2) *Tables of Organization*.—Tables of Organization prescribe the organization of signal and communication units and personnel and show the authorized items of transportation and weapons.

(3) *Tables of Basic Allowances*.—Tables of Basic Allowances list items of signal equipment authorized for signal or communication units with the basis of issue.

(4) *Signal Corps General Catalog*.—The Signal Corps General Catalog includes a descriptive section, a stock section, and several appendixes. This catalog is essential to all signal property and supply officers.

(5) Circulars issued by the Chief Signal Officer.

SECTION II

ORGANIZATION

■ 5. DEFINITIONS.—a. *Message*.—The term “message” as used herein includes all instructions, reports, orders, documents, photographs, maps, or other intelligence, in plain language or code, transmitted by a means of signal communication (see c below).

b. *Agency of signal communication*.—The term “agency of signal communication” embraces the personnel and equipment necessary to operate message centers, signal intelligence, signal supply, signal repair, and messenger, pigeon, radio, visual, sound, and wire communication.

c. *Means of signal communication*.—A “means of signal communication” is an agency of signal communication capable of transmitting messages. The following agencies are means of signal communication: messenger, pigeon, radio, visual, sound, and wire.

d. *Command post*.—The command post is the location of the forward echelon of a headquarters during combat from which tactical control is normally exercised and to which tactical information from subordinate units is sent. When the commander leaves his command post for any purpose,

he maintains constant communication with it through the speediest and most reliable means of signal communication available to him. Only by such means can his effectiveness as a tactical commander be constantly maintained.

e. Axis of signal communication.—To secure continuity of command and signal communication in combat when the movement of command posts either forward or backward is contemplated, the probable successive command posts should be selected in advance. The "axis of signal communication" is designated by naming these probable successive locations in the direction of movement. These points may not actually be occupied by the command post, but the command post will move along the route indicated by the points named.

■ 6. SIGNAL AND COMMUNICATION UNITS.—Specially trained personnel and technical equipment required for the operation of signal communication are provided by Tables of Organization and Tables of Basic Allowances for signal communication units to serve each battalion and higher headquarters. Signal Corps units are herein referred to as signal troops, and others as communication troops.

■ 7. SIGNAL SYSTEMS.—The signal system of each tactical unit is complete within itself and embraces the signal systems of subordinate units to meet the need of the unit commander. It also forms an integral part of the system of the next superior unit. All systems combine to form one coordinated system.

■ 8. SIGNAL AGENCIES AND MEANS.—*a. Agencies.*—The following agencies of signal communication may be employed in the signal systems within the division and higher units:

- (1) Message centers.
- (2) Messenger communication.
 - (a) Airplane messenger.
 - (b) Motor messenger.
 - (c) Motorcycle messenger.
 - (d) Bicycle messenger.
 - (e) Mounted (horse) messenger.
 - (f) Runner (foot messenger).
- (3) Pigeon communication.

- (4) Radio communication.
 - (a) Radiotelegraph.
 - (b) Radiotelephone.
- (5) Visual communication.
 - (a) Lamps.
 - (b) Flags.
 - (c) Panels.
 - (d) Pyrotechnics.
 - (e) Airplanes.
- (6) Sound communication.
- (7) Wire communication.
 - (a) Telephone.
 - (b) Telegraph.
 - (c) Teletypewriter.
- (8) Signal supply.
- (9) Signal repair.

b. *Means.*—The signal systems within the division generally employ the following means: radio, wire, messenger, sound, and visual. Pigeon, and certain forms of visual and sound communication, are used for special purposes. Choice of the means employed in each instance depends on the situation. Exclusive reliance upon any one means is unwise because special and unforeseen circumstances may render that means inoperative when most needed. Plans of all commanders will make advance provision for prompt employment of effective and reliable alternate means; and the simultaneous operation of several means will minimize the ill effects of complete interruption in any one. In general, the primary means actually used for tactical purposes will be that which combines the greatest facility and speed of installation and operation with the required secrecy and dependability.

■ **9. TEAMWORK.**—To insure successful signal communication, the signal and communication troops must work as a team regardless of unit, arm, or service. There must exist a spirit of mutual helpfulness and cooperation. Signal communication personnel at any headquarters should become personally acquainted with personnel at other headquarters with whom they communicate directly. This includes units in all relationships (supported, supporting, superior, subordinate, ad-

jacent, and attached) and is regardless of the point at which the responsibility for communication is fixed. Personal contact promotes a better understanding of the special problems and conditions which exist at each headquarters and permits full assistance and cooperation in the installation, operation, and maintenance of signal communication.

SECTION III

COMMAND AND STAFF DUTIES OF SIGNAL AND COMMUNICATION OFFICERS

■ 10. RESPONSIBILITY.—*a. Commander.*—Responsibility for signal communication is a function of command and is prescribed in AR 105-15. In general, the tactical commander is responsible for the installation, operation, and maintenance of all agencies of signal communication which form the signal system for his unit, and for the efficient functioning and coordination of signal communication in subordinate units. To that end he prescribes the requisite training of personnel in all echelons under his command and the application of such training in field operations in the same manner and to the same extent as for other tactical functions and means. Mobilization Training Programs for each type of unit are issued by the War Department.

b. Signal or communication officer.—In general, each tactical unit commander down to the battalion is provided with a special staff officer trained in the tactics and technique of signal communication. He is charged, under the direction of the unit commander (or his G-3 or S-3), with the exercise of tactical supervision of signal communication for the entire command, and with initiating, through proper recommendations, the necessary measures for the training of personnel or subordinate units in signal communication for combat. For ground units in the division and higher headquarters and for air units in the wing and higher headquarters, this special staff officer is known as the signal officer; in units below the division and wing he is known as the communication officer.

c. Channels of supervision.—All orders affecting the tactical employment of signal communication are issued through

the normal channels of command and are coordinated with orders issued to other tactical or technical agencies by the appropriate staff section prior to their issue. Orders pertaining to routine matters issued for the technical control of an agency of signal communication and which do not need coordination with orders issued to other elements of the command may be issued in the name of the commander by the communication or signal officer of the superior unit to the communication or signal officer of the subordinate unit.

■ 11. **STAFF AND COMMAND FUNCTIONS.**—*a.* The signal or communication officer, as a member of the special staff group, assists the tactical commander in exercising his command functions relative to signal communication and acts as an adviser to the commander and other members of the staff on all matters relating to signal communication. Under instructions received from his commander, he acts as inspector and coordinator of the training and operations of subordinate signal or communication units.

b. The signal officer commands, so far as relates to training and tactical employment, all signal troops assigned to serve his headquarters. As a commander of troops, the signal officer is responsible for the proper training and tactical employment of his own signal units.

c. These two functions of staff and command, although vested in the same individual, are separate and distinct in that each involves different responsibilities and duties and the exercise of one should not be confused or permitted to interfere with the exercise of the other. However, this dual function of the signal officer has many advantages in facilitating the proper discharge of both his command and staff duties.

■ 12. **DETAILED DUTIES.**—*a. Signal officer.*—(1) *During mobilization.*—During mobilization the signal officer—

(a) Prepares requisitions for personnel to bring his unit to authorized strength.

(b) Inventories and inspects signal equipment, and requisitions what is needed to bring the quantity on hand up to that authorized by Tables of Basic Allowances for his unit and for subordinate units.

(c) Prepares the training programs for signal communication troops of his unit under the general policy laid down by his commander and by higher authority, adapting the policy to meet local conditions and the time period allowed for mobilization.

(d) Takes steps to secure and supply authorized training equipment throughout the command.

(e) Organizes and supervises such troop schools for communication specialists as may be authorized by his commander or required by orders of higher authority.

(f) Prepares for the approval of the commander such routine orders and signal operation instructions as may be needed for the efficient training of the signal and communication personnel of the command.

(g) Personally supervises the training of the signal troops assigned to serve his headquarters, and obtains their training and organization equipment.

(h) Recommends training for the signal and communication units with the staffs and the troops throughout the command.

(2) *During actual or simulated combat.*—During actual or simulated combat the signal officer—

(a) Prepares or secures from higher authority such orders and signal operation instructions as may be needed to insure tactical and technical control of the signal systems of the command. Insures the proper distribution of such orders and signal operation instructions throughout the command.

(b) Recommends the initial location of the command post of the unit which he serves, if this location has not been prescribed by higher authority. Recommends the initial locations for the command posts of the next subordinate units when practicable. When the necessity for the displacement of command posts during the operation can be foreseen, recommends the axes of signal communication for the next subordinate units and for the unit which he serves when it has not been prescribed by higher authority. Submits these recommendations to the commander or his designated staff officer.

(c) Prepares plans for the employment of the signal agencies of the unit which he serves and for subordinate units so

as to insure the most efficient employment of these agencies within the headquarters of the unit which he serves and the necessary coordination and technical control of the agencies of subordinate units, subject to orders received from higher authority. Submits these plans to his commander or to the appropriate staff officer for approval.

(d) Prepares all signal orders based upon the approved plan of signal communication, transmits these orders to the proper issuing agency, checks on the issue of these orders, and supervises their execution.

(e) Establishes and operates the signal communication system for which his unit commander is directly responsible; makes technical inspections of the signal communication personnel and equipment throughout the command as his commander may direct, and submits recommendations to his commander concerning the action that should be taken to correct the deficiencies that may exist, or to improve the training methods or doctrine.

(f) Supervises the replacement of signal equipment and personnel of the unit which he serves and of subordinate units.

b. Communication officer.—The communication officer performs duties similar to those for a signal officer with respect to the signal communication troops of the unit which he serves and subordinate units when such duties are appropriate.

SECTION IV

DISPOSITION OF MATÉRIEL

■ 13. GENERAL.—When signal communication equipment is in imminent danger of capture by the enemy, it must be destroyed in accordance with the following:

a. Unclassified and restricted communication equipment.—This equipment will be destroyed beyond possibility of repair or reclamation of parts.

b. Secret and confidential communication equipment, codes, ciphers, cipher devices and all instruction books.—These will be destroyed beyond recognition. Only those parts of a secret or confidential device which show secret principles

or design must be destroyed beyond recognition. Other components not involving secret or confidential principles, such as power supplies, cabling, etc., need be destroyed only to an extent that would prevent future use or reclamation. Personnel who are responsible for secret or confidential equipment must be familiar with any special or detailed instructions relating to any particular device and must be prepared at all times to carry out these instructions without delay. In those cases where special instructions have been issued regarding certain devices, personnel responsible will be prepared and equipped to carry them out without delay.

■ 14. **DESTRUCTION.**—*a. Priority.*—In destroying parts of equipment which are to be destroyed only to an extent sufficient to prevent their future use or reclamation, the following priorities will be followed:

(1) Parts which are nonstandard and unusual, either from a mechanical or electrical standpoint, since the likelihood that the enemy can replace them would be small, particularly if all captured units of a particular item have the same nonstandard component destroyed.

(2) Critical units, since the likelihood that the enemy would be able to replace them would be smaller than for non-critical items.

(3) Parts interchangeable with other equipment, to prevent the enemy from using them to salvage other types of destroyed equipment.

(4) Other parts.

b. Methods.—The following general means of destruction, utilizing the usually available tools and materials, are prescribed for the principal items of signal communication equipment:

(1) *Books and papers.*—Instruction books, circuit and wiring diagrams, records of all kinds for all types of Signal Corps equipment, and code books and registered documents should be destroyed by burning. Each cryptographic security officer will secure a 5-gallon can of gasoline to be kept within easy reach and close proximity to the storage place of all registered documents. If possible, each document will be separated into individual sheets, each sheet crumpled, and all placed in a

pile. The pile may then be saturated with gasoline and ignited; for safety, a lighted match may be thrown from a distance of at least 6 feet.

(2) *Engines.*—All gasoline engines, whether a part of a truck or an engine generator, should be demolished in order of importance of the principal parts such as engine block, magneto, carburetor, radiator, cylinder heads, manifold, and fuel tanks.

(3) *Generators.*—All generators should be demolished in order of importance of the principal parts, which are casting, armature windings, commutator, brushes, and main casting.

The armature windings, and in some instances the field windings, of generators may be destroyed by short-circuiting prior to demolition of the prime mover.

(4) *Power switchboards.*—The principal power switchboard parts to be demolished in order of importance are meters, regulators or relays, switches, and wiring. These parts may be destroyed by sledges and axes.

(5) *Telephone switchboards.*—Switchboards should be destroyed with any hammer, ax, sledge, or other means of demolition available. Destruction should be accomplished in the following order: Jacks, keys, relays, battery and meter protective units, head and chest sets, and power equipment.

(6) *Radio sets.*—Destruction of equipment by explosives, when provided, is prescribed in appropriate instructions. All radio sets may be destroyed in the following manner:

(a) Shear off all panel knobs, dials, etc., with an ax head. Break open set compartment by smashing in panel face, then knock off top, bottom, and sides. The object is to destroy the panel and expose the chassis. On the top of the chassis, strike all tubes and circuit elements with the ax head. On the under side of the chassis the ax head should be used for shearing and tearing off wires and small circuit units. Socket bases should be broken and circuit units and wires cut. Tubes, coils, crystals and holders, microphones, earphones, and batteries should be smashed or cut, the treatment and tool being the same as for chassis parts. Masts and poles should be broken at the joints by bending. The variable gang tuning condenser is the most difficult part to replace and should therefore be destroyed.

(b) The following supplementary means of destruction should be employed whenever possible:

1. Pile up equipment already smashed as outlined above, and pour on gasoline or oil and set on fire. If other inflammable material such as wood, sawdust, cloth, straw, etc., is available, pile up this material and place equipment on it before pouring on gasoline or oil.
2. Smashed parts should be buried in earth or stream beds.

(7) *Radio stations.*—Destruction of radio stations may be accomplished in the same manner as described for radio sets except that additional demolition is required for all permanent fixtures such as antennae towers and power plants. Such permanent and heavy fixtures may be destroyed by explosives and in the case of engines, generators, and power switchboards by the methods covered in *b*, *c*, and *d* above.

(8) *Telegraph equipment.*—Telegraph switchboards, sets, and printers should be destroyed in the same manner as telephone equipment. It is particularly important to smash gears and frame castings of teletypewriters.

(9) *Meteorological equipment.*—All meteorological equipment such as barometers, anemometers, wind vanes, thermometers, hydrometers, wind-indicating instruments, rain gages, sunshine gages, recorders, and meteorographs may be destroyed by means of bending or crushing with heavy instruments.

(10) *Visual signaling equipment.*—All visual signal equipment may be rendered permanently inoperative by destroying all glass, particularly optical glass, metal reflectors, gears, and wiring by bending or smashing with heavy instruments.

(11) *Miscellaneous.*—Transmitters and receiver units of telephones and head and chest sets should be destroyed by hammering. Items containing rubber, such as rubber-tired reel carts, wiring of all types, and field wire should be destroyed by cutting and burning.

■ 15. CAPTURED EQUIPMENT.—In order that captured enemy signal communication equipment may be reused by friendly troops, turned in for salvage of usable parts, or studied to

gain information about the enemy, it must be handled promptly and placed in the proper channels. In order to study such equipment an identification officer is provided at infantry division and similar or higher unit headquarters in the theater of operations. All personnel should immediately report captured enemy signal communication or cryptographic equipment to the nearest signal or communication officer. Where circumstances permit, installed equipment will not be disturbed before the arrival of specially trained personnel. For further details see FM 11-35. *Caution: Such equipment may conceal "booby traps" which will cause casualties to unwary personnel.*

■ **16. RESPONSIBILITY OF SIGNAL OFFICERS.**—Signal officers will be familiar with all items of equipment for which they are responsible, in order that they may prescribe other means of destruction as necessary to meet unusual conditions in the field. Such instructions will be coordinated by the senior signal officer, and copies forwarded to the Chief Signal Officer.

CHAPTER 2

MESSAGE CENTER.

	Paragraphs
SECTION I. General	17-35
II. Procedure for divisions and higher units.....	36-42
III. Procedure in headquarters below division.....	43-48
IV. Military cryptography.....	49-54
V. Cipher device M-94.....	55-61
VI. Converter M-209	62

SECTION I

GENERAL

■ 17. DEFINITIONS.—*a. Message center.*—The message center is the agency of the commander at each headquarters or command post charged with the receipt, transmission, and delivery of all messages except those indicated in paragraphs 20*d* and 48*b*(3).

b. Addressee.—An addressee is the person or office to which a message is to be delivered. The term includes a representative authorized by an addressee to receive his messages. Addressees may be indicated as "action" or "information", depending upon the purpose for which the message is sent to them.

c. Message.—See paragraph 5*a*.

d. Writer.—The originator of a message is called the writer.

e. Cryptography.—See paragraph 50.

■ 18. PURPOSE.—*a.* The purpose of the message center is to speed the transmission of authentic messages by—

(1) Providing a designated point to which messages and messengers may be directed.

(2) Keeping informed of the current effectiveness of each available means of signal communication.

(3) Properly distributing message traffic to the available effective means of signal communication.

(4) Eliminating unnecessary delays in transmission.

(5) Operating an efficient messenger service.

b. Message centers of divisions and higher units are operated by Signal Corps units. Message centers of units below the division are operated by communication personnel of those units. Message centers are located at the command post and at the rear echelon of the headquarters. Advance message centers for the reception and relay of messages are employed as a part of the signal system to facilitate signal communication with advanced units or units operating on a flank.

c. Advance message centers are established when required to relay messages transmitted by different means of signal communication or through different channels of the same means. Information of their locations will be transmitted to interested unit signal or communication officers, who are responsible for the proper and rapid dissemination of this information. Advance message centers often are employed as a part of the signal system to facilitate the transmission of information and reports from front line reconnaissance and security units, and as collecting points for messages from several reconnaissance detachments in the reconnaissance operations of cavalry divisions. A staff officer may be assigned to the advance message center to receive, evaluate, and consolidate messages for retransmission to the rear.

d. The message center is not organized or equipped to perform stenographic or clerical work pertaining to the headquarters which it serves. It is not equipped to prepare copies of outgoing messages for multiple transmission, nor to prepare additional copies of incoming messages for multiple distribution. It will therefore not be used for these purposes. (See pars. 25 and 37h.)

■ 19. CLASSIFICATION OF MESSAGES.—Messages are classified according to—

a. *Secrecy*.—Messages are classified as secret by the writer if their content so warrants. In simulated or actual tactical operations, all messages not classified as secret will be re-

garded as confidential and need not be so marked. (See AR 380-5.)

b. *Intelligibility*.—This classification refers to whether the message is in clear or cryptographed (sec. IV).

(1) A clear message is one in which the text of the message conveys an intelligible meaning in a spoken language.

(2) A cryptographed message is one in which the text of the message conveys no intelligible meaning in any spoken language.

c. *Precedence with which handled*.—Messages may be classified as urgent, operational priority, priority, or deferred by the writer. Messages transmitted electrically may carry any of the five precedences (formerly termed classifications) given below as to priority.

(1) *Urgent (O)*.—Commanders must restrict the use of the urgent precedence to the most urgent messages; excessive use will defeat its purpose. Urgent precedence indicated by symbol O is reserved for initial enemy contact and initial amplifying reports, and for subsequent contact reports and other messages during actual or imminent combat (real or simulated), which may materially affect plans or course of action and must therefore be brought to the attention of the addressee at the earliest possible moment. A primary example of this type of message is a so-called Army flash message which is employed to report the approach of hostile aircraft. Urgent messages will be sent immediately upon receipt, except when communication involving another urgent message is being carried on.

(2) *Operational priority (OP)*.—Operational priority precedence, indicated by the symbol OP, is not ordinarily used in the Army, but is used in joint Army and Navy procedure, and is reserved for important messages pertaining directly to operations, except ordinary movement reports, which cannot be classified as urgent, but which nevertheless must be delivered to the addressee as expeditiously as possible in order to be acted upon properly. *This priority shall be given only to operational traffic.* (Messages sent by the executive (IX) method are of this precedence, but do not carry OP in the heading.)

(3) *Priority (P)*.—Priority precedence, indicated by the symbol P, is used for messages which cannot be classified under definitions of urgent and operational priority, but which, nevertheless, are pressing and require the addressee's immediate attention upon receipt, and which must therefore be delivered to the addressee as expeditiously as traffic of higher precedence will permit. This is the highest precedence that can be given to administrative traffic. Priority messages will be transmitted before such routine messages as may be waiting to be sent, but transmission of a message will usually not be interrupted to send a priority message.

(4) *Routine (no symbol)*.—Routine precedence is used for messages requiring prompt delivery to the addressee but no special precedence. It is standard for messages in normal form, and is understood to apply where no other precedence is indicated, except in the case of executive (IX) method messages mentioned in (2) above. The majority of the messages handled by the message center will be routine messages. They are transmitted in the order in which they are received.

(5) *Deferred (D)*.—The deferred precedence indicated by the symbol D is used for those messages whose delivery to the addressee may be delayed until the transmitting agency is unoccupied with other traffic, or if sent by messenger, until one is otherwise required for the trip, but in no instance will the delay exceed 24 hours.

d. Terminology employed in message center operation.—

(1) *Outgoing messages*.—Outgoing messages are those coming to the message center from local sources for transmission to offices or individuals served by another message center, and to those not served by a message center, or located beyond the normal operating distance of local messengers.

(2) *Incoming messages*.—Incoming messages are those coming to the message center for delivery within the headquarters or echelon from another message center or offices or individuals not served by a message center, or from distant members of the headquarters or echelon who are beyond the normal operating distance of local messengers.

(3) *Relay messages*.—Relay messages are those originating outside the headquarters or echelon served, and sent to the

message center for delivery to an office, individual, or message center at another headquarters or echelon.

(4) *Local messages.*—Local messages are those originating at an echelon of a headquarters for delivery to another office or individual at the same echelon. Such messages normally are not handled by the message center, but may be for records.

e. Form.—This classification refers to the form employed in transmission of the message by electrical means and not to the writing of the message by the writer.

(1) *Normal form.*—The normal form message is ordinarily used when transmitting messages electrically between divisions or higher headquarters. The abbreviated form may be used if desired. (See par. 27b.)

(2) *Abbreviated form.*—The abbreviated form message is always used when transmitting messages by radio within the division and between elements of the division and smaller units. For messages sent by means other than radio the normal form may be used if desired. (See par. 27c.)

f. Method of sending.—Methods used for transmission of messages by electrical means include—

(1) **Receipt or R method**, in which both the transmitting and receiving stations normally may use their transmitters in order to effect delivery of messages, and in which the transmitting station usually requires and obtains a receipt for each message thus transmitted. This is the normal method.

(2) **Broadcast or F (Fox) method** in which several stations are addressed, but are not permitted to receipt to the transmitting station for the messages thus received.

(3) **Intercept or I method** in which, by prearrangement, messages intended for a silent station are exchanged between two regularly operating stations.

(4) **Executive (IX) method**, which is used for messages which require the execute sign to indicate the instant of execution.

■ **20. RESPONSIBILITY.**—*a. Outgoing messages.*—The responsibility of a message center begins when a message is received and continues until the message is receipted for by the addressee, another message center, or a means of signal com-

munication at another headquarters or echelon. It is also the responsibility of the message center to assure that messages submitted for transmission are submitted by persons known to the message center personnel or able to establish their identity.

b. Incoming messages.—The responsibility of a message center begins with the receipt of the message by whatever means of signal communication employed and continues until the message is received for by the addressee.

c. Relay messages.—The responsibility of the relaying message center begins with the receipt of the message by whatever means of signal communication employed and continues until the message is received for by the addressee, another message center, or a means of signal communication at another headquarters or echelon.

d. Other messages.—The message center is not responsible for—

(1) Messages transmitted by the writer directly to the addressee by telephone, teletypewriter, or personal agency.

(2) Messages handled by the military or civil postal service.

(3) Local messages. (See par. 19d(4).)

■ 21. FLEXIBILITY OF ORGANIZATION.—*a.* Since the handling of messages is an important function of command, the commander of each unit is responsible for the adoption of methods which are satisfactory for his unit. Message centers will operate with a varied number of men depending upon the size of the unit, the magnitude of operations, the time of day, and all other factors which affect the volume of traffic to be expected during any given period. *Flexibility in procedure and organization is therefore desirable and authorized.*

b. Situations peculiar to a particular headquarters organization or tactical operation may require special methods of procedure. Commanders will be alert to recognize such situations and to adapt their methods to secure best results. *A standing operating procedure is desirable but it will not be considered binding when departures therefrom will speed operation.* However, some uniformity of procedure is necessary to prevent confusion, because each message center must

transact business with other message centers. Also, personnel allotted to the message center are sufficient to perform only the minimum functions incident to the handling of normal message traffic, and if operations in excess of these minimum functions are required, the necessary additional men must be provided by the commander.

c. The methods of handling messages as set forth in this chapter are intended only for guides. Deviations therefrom are authorized if circumstances warrant and if other message centers and communication personnel are notified and assent to a change which affects their own operation.

■ 22. TRAINING.—*a. Objective.*—The time required for all clerical operations of the message center, including time for recording and numbering the message, inclosing and preparing the envelope, if used, or preparing a delivery list, but excluding cryptographing, should not exceed 20 seconds.

b. Maximum delay time in message centers.—No message will be delayed for recording operations in the message center longer than 2 minutes, exclusive of the time required for cryptographing, decryptographing, or authentication. Commanders are responsible for having sufficient personnel available and properly trained to accomplish this objective. If the volume of business at any time exceeds the capacity of the message center personnel to perform the normal recording operations within this maximum delay time, the unit commander will be promptly informed and additional personnel provided or the normal operations abridged or eliminated.

c. Personnel.—For detailed instructions as to training of messengers, see section II, chapter 3. The training of message center and messenger personnel will emphasize—

(1) Military courtesy.

(2) Staff organization, particularly the organization and personnel at local headquarters.

(3) Organization of the unit and the numerical designation of subordinate and superior units.

(4) Training in passive air defense, such as natural and artificial concealment, use of sand bags and earthworks as

a passive defense measure, and the identification of hostile and friendly aircraft and vehicles.

(5) Use of the weapon with which armed.

d. Conference with users of the system.—It must be realized that commanders and staff officers do not always find time to keep up with regulations relating to use of the signal system. It will prove helpful to the entire unit if the signal or communication officer finds opportunity in a staff conference or otherwise to receive complaints and to explain to the principal users of the system such matters as—

(1) Handling of messages of various precedences, and how the excessive use of high precedences will defeat the purpose for which they are established.

(2) Handling secret and other messages.

(3) Value of writer's identification number and time signed if future reference to the message is anticipated between writer and addressee.

(4) Schedules of messenger service, with the suggestion that when practicable, outgoing messages be submitted to meet these schedules.

(5) Advantage of the telegraph or teletypewriter over the telephone for certain types of messages.

(6) Policy of the commander regarding the transmission of radio messages in the clear. See paragraph 49 for basic policy in this respect.

(7) Necessity for warning the message center of any unusual demand for service which will be made upon it, such as the distribution of field orders at a certain hour.

(8) Necessity for the writer to submit all messages in duplicate.

(9) Directions for submission of messages for multiple distribution.

(10) Any other matters which require coordination.

■ **23. INFORMAL CONTACT WITH NEIGHBORING MESSAGE CENTERS.**—Effective operation is facilitated by informal contact between neighboring message centers on matters of mutual interest, such as reporting the delivery of an important message, notifying the other message center of the reason for delay in securing an answer, or warning the neighboring mes-

sage center that it will shortly receive orders or other messages which will require special measures for prompt handling. Neighboring message centers should thus work together as a team; each should assist the other in meeting mutual problems and in answering inquiries, and should welcome such assistance from neighbors.

■ 24. OPERATION. — *a. Continuous service.* — During active operations, message center service is continuous and is effected as follows:

(1) *On the march.* — Message centers may function during the march to afford communication between columns, within the column, with aerial or ground reconnaissance troops, and with the rear echelon when it does not accompany the column.

(2) *At each echelon.* — A message center is established at each echelon of the headquarters. (See par. 18*b*.) When an echelon moves, the message center opens at the new location prior to or at the same time as the closing of the message center at the former location.

b. Location. — (1) Signs to mark the location of the message center and the routes thereto are used sparingly — when the danger is great, not at all; in place of signs, guides are posted to point the way and messengers are given more precise instructions.

(2) On the march, the position of the message center in column is made known to all concerned by designating its position in the march order and by the use of pennants and panels. The latter are used when necessary to mark the location from the air. Standard markings are shown in paragraph 149.

(3) The following are desirable physical features of the message center:

(*a*) Quiet.

(*b*) Protection from the weather and from the enemy.

(*c*) Capability of being made lightproof at night and gas-proof at any time.

(*d*) Accommodations for personnel and equipment.

(*e*) Convenience to staff sections and to highways.

(*f*) Location in a region of good radio reception and trans-

mission such that radio stations can be grouped around the message center in a scattered, hidden arrangement.

c. Employment of means of signal communication.—In coordinating the use of the various means of signal communication, the message center employs the most suitable and rapid means available for the transmission of any message. To this end the message center will keep itself informed as to the availability of all means. The considerations governing the means to be employed are—

(1) Messages to go only a very short distance should habitually be sent by messenger.

(2) Maps, documents, photographs, and similar messages must be sent by messenger unless equipment for facsimile transmission is available.

(3) Short messages going a comparatively long distance should be sent by some electrical means.

(4) Whenever possible, the telegraph or teletypewriter should be used in preference to the telephone in order that the latter may be kept open for direct communication by the commander and his staff. Messages transmitted by telegraph or telephone may be cryptographed as necessary to conform to paragraph 49.

(5) Pigeons should be employed as prescribed in chapter 4. The instructions in paragraph 49 as to cryptographing radio messages apply to pigeon messages also.

(6) Very long messages should usually be sent by messenger.

(7) Messages transmitted by radio are subject to interception by an alert enemy, and must be cryptographed as directed in paragraph 49.

(8) If its importance warrants, a message may be sent by two or more means subject to the restrictions imposed by cryptographic security. (See AR 380-5.)

(9) Urgent and priority messages are sent by the most rapid means available. (See par. 19c.)

(10) Routine administrative reports must be transmitted by means other than radio.

(11) Relative speeds of transmission of the various means of signal communication. The following chart assumes a normal tactical message of 10 groups or 10 clear text words:

Means	Speed
Manual telegraph (single line)	28-36
Manual telegraph (duplex)	50-70
Teletypewriter (single line)	80-100
Teletypewriter (duplex)	150-190
Radiotelegraph	15-25
Radiotelephone	10-15
Telephone	10-15
Lamp	10
Semaphore flags	15
Wigwag flags	10
Panel	30
Messenger, dismounted	3-5
Messenger, mounted	6-8
Messenger, bicycle	6-10
Messenger, motor	25-40
Messenger, airplane	80-200

Messages
per hour.

Groups per
hour.

Miles per
hour.

d. Forms and equipment.—Certain blank forms, stamps, and other equipment are normally provided for convenience and to save labor. *However, message center operation will not be made dependent upon blank forms or other equipment, nor will the absence of such material be permitted to delay messages in the message center.*

■ 25. MULTIPLE DISTRIBUTION.—When distribution of mimeographed or printed material to a number of addressees is desired, all copies required for each addressee will be delivered to the message center wrapped, packaged, or otherwise secured, and the bundle plainly marked with its destination. Each such package, envelope, or container will be handled by the message center as a single message and will be delivered by messenger. One additional copy of the message should be delivered to the message center.

■ 26. MESSENGER SYSTEM.—For the employment of messengers, see chapter 3.

a. Estimate of needs.—As all local delivery and a large portion of message traffic between message centers is handled by messenger, an effective messenger system is indispensable. It is, therefore, an important responsibility of the commander to provide for their means of transport.

b. Casualties.—War experience has shown that messengers

suffer heavy casualties and that when these casualties are not promptly replaced or when insufficient men are detailed to the messenger service, the messenger personnel is soon brought to the limit of physical endurance. The unit commander should, therefore, keep himself informed of the messenger situation and should be prepared to detail additional trained messengers whenever they are required.

c. Messenger dispatcher.—The messenger dispatcher should be selected with care. He should be a forceful non-commissioned officer and able to write rapidly; he should be mentally alert and have considerable endurance; and above all, he should know how to handle his messengers with the proper combination of understanding and firmness.

d. Organization.—It may be expected that the number of messengers detailed will be the minimum estimated even under the most favorable circumstances. It is vitally important therefore that this personnel be carefully selected and well trained and that its transport be utilized at maximum efficiency. As the requirements for messengers change from day to day and even from hour to hour, the organization must be flexible. This flexibility is enhanced if the sleeping quarters of the messengers are in the immediate vicinity of the message center. When practicable, messengers should be organized into shifts and details to provide 24-hour service for—

- (1) Local delivery.
- (2) Scheduled messenger service to other message centers.
- (3) Special messenger service to handle urgent and priority messages and other special missions.

e. Training.—To meet situations in which heavy casualties among messengers or the total failure of other means of signal communication call for sudden extensive augmentation in messenger personnel from any source available, all military personnel will, as an integral part of their routine training, receive the fullest instruction in the duties of messengers, runners, and agents, with the object in view of rendering any squad or similar grouping capable of functioning as an efficient messenger team on a moment's notice. Messengers carried as such in Tables of Organization will be given further specialized training.

■ 27. ELECTRICAL TRANSMISSION OF MESSAGES.—*a. General.*—

(1) It is important that message center personnel have sufficient knowledge of radio procedure to enable them to prepare messages properly for transmission and delivery when electrical means are used; *b* and *c* below are based upon TM 11-454.

(2) The telephone is not considered a satisfactory means for a message center to use in transmitting message traffic because it denies to more important use the circuits being so employed. If a message cannot be sent by telegraph, teletypewriter, radio, or messenger, the writer should be notified so that he personally or one of his representatives may communicate direct with the addressee by telephone. The telephone in the message center, if installed, is not intended for the transmission of message traffic, but may be found helpful in contacts with neighboring message centers, transmission agencies, and offices relative to the transmission and delivery of messages.

b. Normal form.—(1) The table below lists the data of interest to the message center, in addition to the authentication group, which should appear, in whole or in part, on messages to be transmitted by electrical means in the normal form.

(2) Messages sent from one headquarters to another are addressed to and signed by the designation of the respective

Main sections	Part	Example	When used
Heading...	Destination.....	Send to BA1, or send to I Corps.	Always.
	Operating instructions.	F, G, T, or Y.....	If required.
	Classification.....	O, P, or D.....	If required.
Text.....	Date of origin.....	Sixteenth.....	Always.
	Writer's number.....	NR26.....	If available.
	Addressee.....	TO G-3, I Corps (cryptographed if message text is cryptographed).	If essential, inserted at random at beginning of text.
	Code or cipher indicator.	DFCTO1.....	If essential.
	Message.....	IXOW VAWL COTZ.....	Always.
	Writer's identification.	FROM G-3, 1st Inf. Div. (cryptographed if message text is cryptographed).	If essential, inserted at random near end of text.
	Time signed.....	1828.....	Always.

commanders except when the message is sent by a particular staff officer and action will be expedited by using the designation of the respective staff officers. Designations of commanders, when used as addresses and signatures, are not transmitted in messages sent by radio, but are inserted in the proper places on the message form by the receiving operator when the message is transmitted in the clear, using the designations indicated by the radio call signs of the stations of origin and destination. If sent in secret text, the code clerk making the clear text copy will insert the designations thereon.

(3) When the designation of a staff officer is used in the address or signature of messages sent in the clear by radio, the designation of his unit or headquarters is not transmitted but is inserted at the headquarters of destination as explained in (2) above. In messages sent in secret text where the designations of staff officers are inserted at random in the body of the message, each will be inclosed in parentheses and preceded by an appropriate word as (For ———) or (From ———). They are not cryptographed so as to appear at the beginning or end of the message.

c. Abbreviated form.—The following table lists the data of

Main sections	Part	Example	When used
Heading	Destination	Send to FA1 or send to 1st Inf. Div. Arty.	Always.
	Operating instructions.	F, G, T, or Y	If required.
	Classification	O	Urgent message only.
Text	Addressee	TO CG DIV ARTY (cryptographed if message text is cryptographed).	If essential, inserted at random near beginning of text.
	Code or cipher indicator.	DFCTL	If essential.
	Message	IXOW VAWL COTZ UKZH.	Always.
	Writer's identification.	FROM CO 1ST INF (cryptographed if message text is cryptographed).	If essential, inserted at random near end of text.
	Time signed	1926	Always.

interest to the message center, in addition to the authentication group, in whole or in part, on messages to be transmitted by electrical means in the abbreviated form.

■ 28. ARMY AND NAVY METHODS OF SPECIFYING TIME.—*a.* The Army and the Navy use the 24-hour clock. In the 24-hour clock, time is always expressed as a group of four numerals. The first two numerals of the group denote the hour and the last two numerals the minute after the hour. Ordinary or 12-hour time may be converted to 24-hour time by adding 12 hours to all times from 1:00 PM to midnight, inclusive.

b. The date may be expressed in either of two ways:

(1) For the current month, the day may be indicated by preceding the four-digit time group with a two-figure date group, indicating the day of the month. For example, 080600 is the 8th day of the month and the time is 6:00 AM.

(2) The date and time may be stated by using the four-digit time group, followed by the month, day, and if desirable, the year.

c. The heading of all messages, dispatches, reports, and orders transmitted by radio, telegraph, or cable to the War Department will include the date and the time of origin expressed by six digits as prescribed in *b*(1) above. The date group, time group, or date-time group may be omitted from messages, dispatches, reports, and orders transmitted by radio in the abbreviated form or abbreviated normal form when necessary.

d. Greenwich Civil Time is used within the Navy and in joint operations, unless otherwise prescribed, and within the Army, in both the heading and text of all communication in the following categories:

(1) Messages and orders from the War Department.

(2) Messages and reports to the War Department.

(3) Orders, reports, and other communication between headquarters not having common local time.

(4) Communication with the armed forces of associated nations.

e. All the groups expressing Greenwich Civil Time, including those in the headings of messages, will be designated by the letter suffix Z immediately following the last digit of the group. For example, 190225Z indicates 2:25 AM on the 19th day of the current month Greenwich Civil Time.

f. Examples of time expressed in the 12-hour and 24-hour clock systems are shown below.

12-hour time	24-hour time	12-hour time	24-hour time
Midnight.....	0000	Noon.....	1200
12:01 A.M.....	2400	12:59 P.M.....	1259
1:17 A.M.....	0001	6:08 P.M.....	1808
11:35 A.M.....	0117	11:59 P.M.....	2359
	1135		

■ 29. STATION LISTS.—Operation of the message centers of divisions and higher units is facilitated when station lists are provided. The station list is prepared by the adjutant general or G-1 of the unit, and gives the location of the various headquarters and elements of the command.

■ 30. TELEPHONE DIRECTORY.—In signal operation instructions, the message center is furnished the telephone directory names of all switching centrals and the numbers of all telephones with which it may be concerned. Telephone directory names and numbers are not intended for secrecy but may be prescribed for purposes of simplicity, accuracy, and speed in handling telephone calls. (See par. 175 and example, par. 265*m*.)

■ 31. RADIO, TELEGRAPH, AND VISUAL CALL SIGNS.—Call signs are issued in blocks to the unit signal officer by the next higher echelon. In signal operation instructions, the message center is furnished a list of the call signs of stations with which it may be concerned. These call signs are used by the message center to expedite the handling of messages. All stations serving the same headquarters, whether radio, telegraph, or visual, use the same call sign. However, when there is danger that the enemy may intercept visual signals and identify the station, a separate call sign may be prescribed for visual stations. (See example, par. 265*e*.)

■ 32. AUTHENTICATION SYSTEMS.—An authentication system may be prescribed for use with messages transmitted by any

means. The purpose of an authentication system is to provide a means whereby *bona fide* messages can be made to carry a special symbol attesting to the authenticity of their origin. These systems, when issued, will be accompanied with detailed instructions for their use. These systems will vary in complexity and form depending on their specific use.

■ 33. LETTERING.—The following system of lettering is prescribed for legibility in copying cryptographed messages, and elsewhere as desired. The examples indicate how letters and numerals should be formed and the sequence to be followed in making the various strokes.



TL 4005

The straight line I is the foundation stroke. The letters E, Z, X, and K are made slightly smaller at the top. The letters H, E, and F have the center horizontal strokes slightly above the middle. The letters X, Y, and K have the junction slightly above the middle.



TL 4004

The letters O, Q, C, and G are made in circular form. The letter B is slightly smaller at the top and has the center horizontal part slightly above the middle. The letters R and S are slightly smaller at the top.

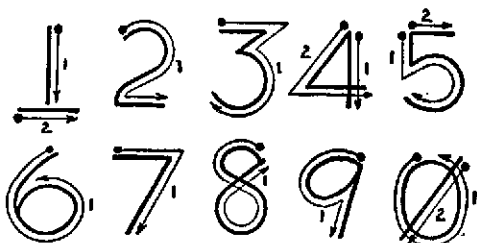

TL4006

The bar under the numeral 1, the top of the 5 and 7, and the bottom of 2, are straight lines. The numeral 1 has a bar under it, slightly below the stem, to distinguish it from the letter I and the cipher 0 has a bar diagonally through it to distinguish it from the letter O.

■ 34. CHARTS, MAPS, AND DIAGRAMS.—The items given below, particularly in divisions and higher headquarters, are helpful in conducting the operations of the message center. In order to be of value, they must be kept up to date.

a. A display map to show the locations of headquarters of the next superior and of the next subordinate units, the scheduled messenger routes, and other information which would be useful to messengers. Sufficient maps or map substitutes of the area to provide each messenger with copies should be available.

b. A corresponding diagram of the locations of the several offices at the local headquarters, possibly showing the names of the principal occupants of those offices.

c. A ready reference chart showing the various means of signal communication established to the different units prepared in substantially the following form and with pins placed in appropriate spaces to indicate the means which are established. (See par. 46a.)

Unit	Messenger	Telegraph	Telephone	Radio
16 Inf.....				
18 Inf.....				
26 Inf.....				
8 Div Arty.....				

d. A list of officers on duty with the unit.

e. A duty chart of message center and messenger personnel, which also should provide a meal schedule.

■ 35. ABBREVIATIONS.—In indicating the means by which messages may be transmitted, the following abbreviations are used:

Msg.....	Message
Msg Cen.....	Message center
Msgr.....	Dismounted messenger (runner)
Ap Msgr.....	Airplane messenger
Bcl Msgr.....	Bicycle messenger
M Msgr.....	Motor messenger
Mtcl Msgr.....	Motorcycle messenger
Mtd Msgr.....	Mounted messenger
Scd Msgr.....	Scheduled messenger
Sp Msgr.....	Special messenger
Pgn.....	Pigeon
Rad.....	Radio
Tg.....	Telegraph
Tt.....	Teletypewriter
Tp.....	Telephone
Vis.....	Visual

SECTION II

PROCEDURE FOR DIVISIONS AND HIGHER UNITS

■ 36. ORGANIZATION.—*a.* In describing the procedure for divisions and higher units, duties are outlined for message center chief, messenger dispatcher, code clerk, messengers, and operators of the several means of signal communication.

This division of duties is functional and is made for convenience in description. In small message centers during periods of inactivity, one man may perform two or more functions while in large and busy message centers, two or more men may be required for a single function.

b. The term "message center chief" is applied to the senior specialist on duty.

c. The term "operator" includes telegraph, teletypewriter, and radio operators.

■ 37. EQUIPMENT AND FORMS.—There is no guarantee that all messages arriving at a message center for transmission will be on standard forms and properly prepared. Nevertheless, the responsibility of the message center begins when the message is presented to it by the writer, regardless of the manner or form of presentation, and every effort will be made to insure its rapid and accurate transmission to the addressee. The following equipment and forms are helpful although the procedure may be used without them:

a. *Received stamp*.—The received stamp indicates in permanent type the message center designation; in movable type, the month, date, and year; it also provides for time entry by clock operated stamp.

b. *Serial number stamp*.—This is an automatic numbering stamp.

c. *Field message book*.—This book contains message blanks for all messages, special tissue blanks for pigeon messages, and several vellum sheets for making map overlays.

d. *Number sheet*.—The following is an extract from W. D., S. C. Form No. 159. The complete form provides space for 100 messages. (See par. 46a.)

SIGNAL COMMUNICATION

37

WAR DEPARTMENT							
SIGNAL CORPS, U. S. ARMY							
NUMBER SHEET							
-----				-----			
(Unit)				(Date)			
No.	Remarks	No.	Remarks	No.	Remarks	No.	Remarks
1	-----	26	-----	51	-----	76	-----
2	-----	27	-----	52	-----	77	-----

e. Delivery lists.—(1) The following is an extract from W. D., S. C. Form No. 160. The complete form provides space for seven messages.

WAR DEPARTMENT	
SIGNAL CORPS, U. S. ARMY	
LOCAL DELIVERY LIST	
Time dispatched	Time returned
MESSAGE IDENTIFICATION	SIGNATURE IN FULL
-----	-----
-----	-----

(2) The following is an extract from W. D., S. C. Form No. 158. The complete form provides spaces for 19 messages.

WAR DEPARTMENT SIGNAL CORPS, U. S. ARMY ROUTE DELIVERY LIST		
Time dispatched		Time returned
MESSAGE IDENTIFICATION	SIGNATURE IN FULL	TIME RECEIVED

(3) The above forms are used for securing receipts for messages delivered by messenger. The form in (1) is most suitable for local messengers and the form in (2) for scheduled messengers.

f. Skeleton copy stamp.—This is a rubber stamp with the word "SKELETON" in letters about 1 inch high. This stamp is used in stamping message blanks when preparing skeleton copies. (See paragraph 39g.)

g. Paper fastening machine.—This is a medium duty, spool of wire type of machine.

h. Indelible ribbon, or single- or double-faced carbon paper.—These materials may be used when preparing original copies of a message in order that duplicates may readily be prepared by the appropriate office or agency without recopying. (See par. 18d.)

i. Message carrying bags.—These are bags for the use of messengers.

■ 38. MESSAGES.—*a. Preparation by writer.*—The necessary instructions covering the preparation of messages are contained on the inside of the front cover of the field message

book. The following are the essential instructions contained in the message book:

(1) The preparation of at least two carbon copies is required, the original and one carbon to be delivered to the message center and the other carbon copy to be retained for the writer's file.

(2) Print plainly. Print proper names (except signature and grade of writer) and code and cipher groups in capital letters.

(3) Write the message in as few words as possible. If the writer desires punctuation marks transmitted, they must be spelled out, otherwise they will not be sent.

(4) Use only authorized abbreviations.

(5) If a precedence in speed of handling other than routine is desired, print in capital letters the desired precedence in the space at the upper right of the message form.

(6) The use of a serial number by the writer simplifies future reference by either the writer or the addressee. The number is inserted on the first line of the message form after the word "No."

(7) After the word "Date" insert the date in the following order: Day, month, year (example: 15 January 1941 or 15 Jan 41).

(8) After the word "To" on the message form insert the official designation of the addressee (example: CG 1st Inf Div). Add his actual location only when necessary to insure delivery. Do not use the telephone directory designations as addresses.

(9) In the blank following "Official designation of sender" insert the official capacity in which the writer is serving (examples: "CO 1st Bn 1st Inf" or "Leader Patrol No. 1").

(10) In the blank following "Time signed" enter the time at which the message is signed. This blank must always be filled.

(11) In the blank following "Signature and grade of writer" insert the personal signature of the writer of the message or of the person authorized to write the message for him.

(12) *In time of war or emergency* all messages to be transmitted by radio, or by other means when danger of hostile

interception exists, are cryptographed unless authority to send in clear is given by the commanding officer or his authorized representative. This authority must be indicated in lower left corner. A box is provided in the message form to authorize transmission in clear.

THESE SPACES FOR MESSAGE CENTER ONLY		
TIME FILED	MSG CEN NO.	HOW SENT
		URGENT
MESSAGE (SUBMIT TO MESSAGE CENTER IN DUPLICATE)		(CLASSIFICATION)
No. 3	DATE 21 JULY 1941	
To CG I CORPS		
ENEMY FORCES HAVE CHECKED OUR ADVANCE PERIOD REQUEST REINFORCEMENTS		
CG 1ST INF DIV OFFICIAL DESIGNATION OF SENDER		0905 TIME SIGNED
AUTHORIZED TO BE SENT IN CLEAR	SIGNATURE OF OFFICER	John T. Peterson, Col, GSC SIGNATURE AND GRADE OF WRITER

7L-4022A

FIGURE 1.—Example of a message properly prepared by the writer.

b. Address and signature.—When call signs are used for the transmission of a message, only the commanding officers of the units which the stations serve are indicated. However, the individual for whom the message is intended or his official title may be inserted at random within the body and near the beginning of the message preceded by the word "For", and the identity of the writer of the message near the end of the message preceded by the word "From." The position of these insertions must be varied in order to maintain cryptographic security.

c. Receipt.—The receipt of an addressee for a message consists of his signature and the time at which he receives the message.

d. Acknowledgment.—An acknowledgment of a message encompasses not only the fact that the message was received but also that the addressee understands the contents of the message. When directed by the writer of a message, the addressee may be informed that an acknowledgment of the message is requested. The receipt indicated above is adequate for the acknowledgment provided the addressee understands that his receipt encompasses this additional requirement. If, however, a study of the message is required prior to an acknowledgment, the addressee may initially receipt for the message and at a later time acknowledge it.

■ 39. HANDLING OUTGOING MESSAGES.—The procedure prescribed in this paragraph and paragraph 40 applies specifically to messages not classified as secret; these messages are treated as confidential. The procedure for handling messages marked "Secret" differs somewhat and is described in paragraph 41. An authentication system may be used at message centers to indicate or determine the authenticity of messages. Outgoing messages coming to a message center from a local source may be handled by the separate specialists listed below in the manner described:

a. Message center chief.—The message center chief—

(1) Receives the message in duplicate from the writer, his representative, or a messenger, making sure that the person submitting the message is known to him or can satisfactorily identify himself.

(2) Immediately inspects the message for legibility and proper address. He declines to accept illegible and improperly addressed messages and, if necessary, brings such messages immediately to the attention of the message center officer.

(3) Writes the time filed on both copies of the message or stamps the time of receipt on the back of both copies with his received stamp. (See fig. 2.)

(4) Writes or stamps the message center number with his serial number stamp, beginning a new series of numbers at midnight each day. (See fig. 2.)

(5) Determines the means by which the message shall be transmitted and writes the abbreviated name of the appropriate means at the top of the message. (See fig. 2.)

(6) Checks the message center number off his number sheet by drawing a diagonal line through the number corresponding to the message center number assigned to the message. (See fig. 3.)

THESE SPACES FOR MESSAGE CENTER ONLY		
TIME FILED 0907	MSG CEN NO. 6	HOW SENT RAD
MESSAGE (SUBMIT TO MESSAGE CENTER IN DUPLICATE)		URGENT (CLASSIFICATION)
No. 3	DATE 21 JULY 1941	
To CGI CORPS		
ENEMY FORCES HAVE CHECKED OUR ADVANCE PERIOD REQUEST REINFORCEMENTS		
CG 1ST INF DIV OFFICIAL DESIGNATION OF SENDER		0905 TIME SIGNED
AUTHORIZED TO BE SENT IN CLEAR	SIGNATURE OF OFFICER	SIGNATURE AND GRADE OF WRITER
	John T. Peterson, Col, GSC	

71-4023A

FIGURE 2.—Writer's original message properly filled in by the message center chief.

(7) (a) If he decides that the message should go forward by electrical means and transmission is authorized in the clear, he provides for the authentication of the message and hands or delivers the original of the message to the operator and files the duplicate copy in the live file. (See par. 46c.)

(b) If the message is to be transmitted as a cryptogram, he passes the original of the message at once to the code clerk and files the duplicate copy in the live file. (See par. 24c (7).)

SIGNAL COMMUNICATION

39

(c) If the message is to be sent in the clear by messenger, he inserts the authentication group in the heading of the message when received, passes the original of the message at once to the messenger dispatcher, and files the duplicate copy in the live file.

(8) Receives the signed delivery list from the messenger dispatcher as soon as it has been returned by the messenger.

FORM NO. 129
7. 12. 38. C.

WAR DEPARTMENT
SIGNAL CORPS, U. S. ARMY

NUMBER SHEET

1st INF DIV 21 JULY, 1941
(UNIT) (DATE)

NO.	REMARKS	NO.	REMARKS	NO.	REMARKS	NO.	REMARKS
X	CG-1AC-Rad-P	26		51		76	
X	CG-1ST INF-1g-O	27		52		77	
X	G4-1AC-T1	28		53		78	
X	CG-3D INF-Rad	29		54		79	
X	G1-G1AC-1g	30		55		80	
X	CG-1AC-Rad-O	31		56		81	
X	CG-2D INF-Tg	32		57		82	
X	G4-G4 3D INF-Rad	33		58		83	
X	CG-1ST INF-Rad-O	34		59		84	
		35		60		85	
		36				86	
		37				87	
				78		88	
				79		89	
				80		90	

TL-4024A

FIGURE 3.—Message center number sheet as prepared by message center chief.

(9) Checks the transmitted messages off his number sheet during lulls in traffic handling by drawing a second opposing diagonal line through the corresponding number. Traffic will not be delayed to perform this operation. (See fig. 3.)

(10) (a) Files the copy of messages transmitted by the operators in the dead file when these are returned by the operator. These originals are used for reference. Removes the duplicate copies from the live file and destroys them. (See par. 46d.)

(b) Removes from the live file duplicate copies of the messages sent by messenger and places them and the signed delivery lists in the dead file.

(11) Uses pigeonholes or envelopes for filing. For ready reference, these are labeled with the names of the unit whose traffic they contain; for example, "From I Corps," "To I Corps," "From 1st Infantry Division," "To First Army," etc. Files are kept for all units with which the unit transacts considerable business. A file marked "From miscellaneous" and "To miscellaneous" is kept for all other business. These files are disposed of as directed by the unit signal officer.

THESE SPACES FOR MESSAGE CENTER ONLY		
TIME FILED 0907	MSG CEN NO. 6	HOW SENT RAD
CD3 V ABL		0
MESSAGE (SUBMIT TO MESSAGE CENTER IN DUPLICATE)		(CLASSIFICATION)
No. _____	DATE 21 JULY 135	
To _____	NR3 DFCTI INJZ OJXH SUVW	
ATBK MYKD HETE ZASF VAWL		
OGLH 0905		
OFFICIAL DESIGNATION OF SENDER		TIME SIGNED
AUTHORIZED TO BE SENT IN CLEAR	SIGNATURE OF OFFICER	SIGNATURE AND GRADE OF WRITER

7L-4025A

FIGURE 4.—Cryptographed message as completed by the code clerk.

b. Code clerk.—(1) Receives the original of the message to be cryptographed from the message center chief.

(2) Cryptographs the message without making a duplicate copy of the cryptographed message. (See par. 27b.)

(3) Transfers message center data at the top of the message to the cryptographed message form. (See fig. 4.)

SIGNAL COMMUNICATION

39

(4) Indicates the pertinent data as to address, operating instructions, speed in handling, and authentication group (if predetermined) in the heading of the cryptographed message. (See fig. 4.)

(5) Passes the cryptographed message to the operator, or to the messenger dispatcher when the message is to go via messenger.

THESE SPACES FOR MESSAGE CENTER ONLY			
TIME FILED 0907	MSG CEN NO. 6	HOW SENT RAD	
CD3 V ABL	NR2	0	GR-12
MESSAGE (SUBMIT TO MESSAGE CENTER IN DUPLICATE)		(CLASSIFICATION)	
No. _____	DATE 21 JULY 135		
To _____	NR3 DFCTL INJZ OJXH SUVW		
	ATBK MYKD HETE ZASF VAWL		
	OGLH 0905		
	0912/R		
OFFICIAL DESIGNATION OF SENDER		TIME SIGNED	
AUTHORIZED TO BE SENT IN CLEAR	SIGNATURE OF OFFICER	SIGNATURE AND GRADE OF WRITER	

TL-4026A

FIGURE 5.—Message after completion of transmission by the operator.

(6) Files the original of the clear text message in his file and disposes of the file as directed by the unit signal or communication officer.

(7) Destroys all work sheets by burning.

c. Operator.—(1) Receives the cryptographed text message from the code clerk or the clear text message from the message center chief.

(2) Inserts a group count and a station-to-station serial number. (See fig. 5.)

(3) Transmits the message and receives a receipt from the distant operator. (See par. 27b.)

(4) Services the message in his possession and when he no longer needs it for verification, returns it to the message center chief for file. (See *a* (10) (*a*) above and fig. 5.)

d. Messenger dispatcher (see also *f* below).—The messenger dispatcher, who is charged with the supervision of messengers—

(1) Receives the original of a clear text message from the message center chief or the cryptographed message from the code clerk.

(2) Prepares a delivery list in duplicate for transmission by messenger. A good carbon copy is necessary; this copy is retained by the messenger dispatcher.

(3) Enters a serial number at the upper right of the delivery list form. (See fig. 6.)

(4) Enters the message center number or other means of identification in the first column of the delivery list. (See fig. 6.)

(5) Stamps or writes the time dispatched in the blank space at the upper left of the delivery list just prior to the departure of the messenger. (See fig. 6.)

(6) Hands the delivery list and the messages to the messenger and gives him any necessary special instructions.

(7) Stamps or writes the time returned in the blank space at the upper right of the signed delivery list when it is returned by the messenger. (See fig. 7.)

(8) Hands the completed delivery list to the message center chief.

(9) Disposes of duplicate delivery lists as directed by the unit signal or communication officer.

e. Messenger (see also *f* below).—The scheduled or special messenger—

(1) Receives the message(s) and delivery list from the messenger dispatcher and proceeds to the distant message center (or addressee if the addressee is not served by a message center).

(2) Delivers the message(s) and delivery list to the message center chief of the distant message center or to the addressee who signs for each message and, in the case of the route de-

livery list, enters the time of receipt in the right-hand column. (See fig. 7.)

(3) Receives the signed delivery list from the message center chief of the distant message center or from the addressee and either returns to his message center or continues to other message centers or addressees on his route if he has other deliveries to make.

(4) Enters his name, his initials, or his number as prescribed by local regulation, on the delivery list for identification. (See fig. 7.)

(5) Hands the delivery list to the messenger dispatcher of his own message center.

f. Scheduled messenger service.—(1) *Routine messages.*—For scheduled messenger service, the delivery list is handled as follows:

(a) When a scheduled messenger has just departed on a certain scheduled route and the next message for delivery on that route reaches the messenger dispatcher's desk, the latter enters the message center number or other message identification in the first column of a serially numbered delivery list. He enters succeeding messages for that route on successive lines as they arrive.

(b) When the time scheduled for the next messenger's departure arrives, the messenger dispatcher enters or stamps the time dispatched in the proper space, turns the delivery list and messages over to the messenger, and gives him such instructions as may be necessary.

(c) The messenger delivers the messages according to his standing instructions supplemented by such special directions as he may have received for the particular run. He secures a signature for each message.

(2) *Other messages.*—Delivery of urgent, operational priority, and priority messages will not be held up for a scheduled messenger.

g. Skeleton copy of message.—Some messages will be submitted to the message center without a duplicate copy. For transmission by electrical means, the single copy will suffice, but if transmission is by messenger, a skeleton copy is made for follow-up and this copy is thereafter handled as a duplicate copy. The skeleton copy is usually brief; for a 100-

word message relating to class I supplies, the skeleton copy might be simply, "QM to Army QM Class I supplies," or for a bundle of maps, "G-3 to G-3, 26 Inf Div bundle maps." A very brief description is all that is required for identification. An urgent or priority message is not delayed for the preparation of a skeleton copy. If a skeleton copy is required, it is made as accurately as possible from memory after the message has been dispatched and the notation "From memory" is added.

■ 40. HANDLING INCOMING MESSAGES.—Messages received at a message center for delivery to local addressees may be handled in the manner indicated below. Incoming messages are not assigned message center numbers.

a. Operator.—(1) Copies the message in duplicate.

(2) Services the message, entering the time he acknowledged receipt and his personal sign under the message, inclosed in a circle. (See fig. 8.)

(3) If the message is in the clear, inserts the address and signature or completes them by adding the designation of the staff officer's headquarters (see par. 27*b*), and passes or delivers—

(a) Original to the message center chief for authentication when necessary or to the messenger dispatcher for delivery.

(b) Duplicate to the message center chief when no longer needed for verification.

(4) If the message is cryptographed, passes or delivers—

(a) Original of the message to the code clerk.

(b) Duplicate to the message center chief when no longer needed for verification.

b. Message center chief.—(1) Receives the original of a clear text message from the operator (*a*(3) (*a*) above).

(2) Verifies the authenticity and marks the message "Authenticated" or "Not authenticated."

(3) Hands the original to the messenger dispatcher for delivery.

(4) Receives and files the duplicate copies of messages from the operators referred to in *a* above.

(5) Receives the message(s) from the incoming messenger; signs for each message received on the delivery list of the

SIGNAL COMMUNICATION

40

distant message center; returns the delivery list to the messenger; stamps the message or its cover with his received stamp; if the message is in the clear, verifies the authentication group, writes or stamps it "Authenticated" or "Not authenticated," and hands the message directly to the messenger dispatcher for delivery; if the message is cryptographed, hands the message to the code clerk for decryptographing and authentication.

THESE SPACES FOR MESSAGE CENTER ONLY		
TIME FILED	MSG CEN NO.	HOW SENT
CD3 VABI	NR 2	0 GR-12
MESSAGE <small>(SUBMIT TO MESSAGE CENTER IN DUPLICATES)</small>		<small>(CLASSIFICATION)</small>
NO.	DATE 21 JULY 135	
TO		
NR3 DFCTI INJZ OJXH SUVW		
ATBK MYKD HETE ZASF VAWL		
OGLH 0905		
(0912/7)		
OFFICIAL DESIGNATION OF SENDER		TIME SIGNED
AUTHORIZED TO BE SENT IN CLEAR	SIGNATURE OF OFFICER	SIGNATURE AND GRADE OF WRITER

TL-4031A

FIGURE 8.—Receiving operator's completed copy of the message after transmission of receipt.

(6) After the message has been delivered, receives the completed delivery list from the messenger dispatcher and files it in his dead file.

c. Code clerk.—(1) Receives the original of the cryptographed message from the operator, or from the message center chief if the message arrives via messenger.

(2) Verifies the authenticity of the message and writes or stamps the words "Authenticated" or "Not authenticated" on the face of the clear copy of the message.

(3) Decryptographs the message, making an original only.

(4) Enters the official designations of the addressee and the sender, as determined from the call signs or from the designations inclosed in parentheses and the call signs (see par. 27b), the date, time signed, and the operator's heading (if any) or the distant message center data (if any) in their proper places on the decryptographed copy of the message. (See fig. 9.)

(5) Passes the message to the message center chief, files the original cryptographed copy of the message in his file for reference, and disposes of this file as directed by the unit signal or communication officer.

(6) Destroys all work sheets by burning.

THESE SPACES FOR MESSAGE CENTER ONLY		
TIME FILED	MSG CEN NO.	HOW SENT
ABI NR2	Rad	URGENT
MESSAGE (SUBMIT TO MESSAGE CENTER IN DUPLICATE)		(CLASSIFICATION)
NO. 3	DATE	21 JULY
TO CG 1ST CORPS		
ENEMY FORCES HAVE CHECKED		
OUR ADVANCE STOP REQUEST		
REINFORCEMENTS		
AUTHENTICATED		
CG 1ST INF DIV OFFICIAL DESIGNATION OF SENDER		0905 TIME SIGNED
AUTHORIZED TO BE SENT IN CLEAR	SIGNATURE OF OFFICER	SIGNATURE AND GRADE OF WRITER

TL-4032A

FIGURE 9.—Code clerk's copy of the message ready for delivery to the addressee.

d. *Messenger dispatcher*.—Receives the original of a clear text message from the message center chief and—

(1) Prepares a delivery list as follows:

(a) Enters a serial number on the upper right-hand corner of the local delivery list.

(b) If the message arrived via messenger, he enters the message center number of the distant message center, headquarters of origin, and means of communication by which the message arrived in the left-hand column of the local delivery list. (See fig. 10.)

W. D., Sig. C. Form No. 160		WAR DEPARTMENT SIGNAL CORPS, U. S. ARMY	
LOCAL DELIVERY LIST			
1ST INF DIV MESSAGE CENTER		Time dispatched	Time returned
		MESSAGE IDENTIFICATION	SIGNATURE IN FULL
		<i>AB-6-(Rad)</i>	
		<i>GFS-9-(Tt)</i>	
		<i>IAC-5-(Msgr)</i>	
		<i>20 INF DIV-6-(Pgn)</i>	
		<i>1st INF-1136A-(Rad)</i>	

*** 3-10775

TL-4030A

FIGURE 10.—Examples of a local delivery list properly filled out by the messenger dispatcher.

(c) If the message arrived by a means requiring an operator, he enters the headquarters or station of origin, the station-to-station serial number (if the message is in the normal form) or the time signed (if the message is in the abbreviated form), and the means of communication by which the message arrived in the left-hand column of the local delivery list. (See fig. 10.)

(2) Designates a messenger to deliver the message.

(3) Stamps or writes the time dispatched on the delivery list when the messenger is ready to depart. (See fig. 10.)

(4) Hands the message(s) and the delivery list to the messenger and gives him the necessary additional instructions for the delivery of his message(s).

(5) Stamps or writes the time returned in the upper right-hand blank of the delivery list when the signed delivery list is returned to him by the messenger. (See fig. 11.)

(6) Hands the completed delivery list to the message center chief.

(7) In handling urgent and priority messages and in order to avoid delay in delivery, the messenger may be given a blank delivery list and be instructed to request the addressee to fill in the message identification as well as the signature, and in case of the route delivery list, the time of receipt.

e. Messenger.—(1) Receives the message and the delivery list from the messenger dispatcher.

(2) Delivers the message and the delivery list to the addressee and obtains his signature, and in the case of the route delivery list, the time received. (See fig. 11.)

(3) Returns to the message center and enters his name, initials, or his messenger number as required by local regulations, on the delivery list for identification. (See fig. 11.)

(4) Hands the delivery list to the messenger dispatcher.



SIGNAL COMMUNICATION

41

W. D., Sig. C.
Form No. 160

WAR DEPARTMENT
SIGNAL CORPS, U. S. ARMY

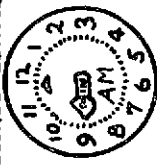
LOCAL DELIVERY LIST

1ST INF DIV MESSAGE CENTER		1ST INF DIV MESSAGE CENTER	
	Time dispatched		Time returned
MESSAGE IDENTIFICATION	SIGNATURE IN FULL		
AB1-6-(Rad)	Robert R. James G-2		
GFS-9-(T+)	Thomas N. Wilson G-1		
IAC-5-(Msgr)	John O'Brien G-3		
2D INF DIV-6-(Pgn)	George A. Smith G-4		
1st INF-1136A-(Rad)	Robert R. James G-2		

*** 3-10776

7L-4029A

FIGURE 11.—Completed local delivery list as returned to the messenger dispatcher by the messenger.

■ 41. HANDLING SECRET MESSAGES.—The handling of secret messages is prescribed in detail in AR 380-5. When time permits, secret messages will normally be carried by officer couriers operating as direct agents of the originating office. The handling of secret messages in the message center differs from the handling of nonsecret messages in the respects mentioned below. The message center must be informed of the cryptographic systems which its code clerks must have in order to handle secret messages received from or addressed to other headquarters, offices, or agencies.

a. Outgoing messages.—The writer of an outgoing message submits only the original copy of a secret message to the message center. The message center chief stamps this message with his time stamp and serial number stamp, makes the notation "Secret" in the "Remarks" column of his number sheet, and passes the message to the code clerk. The code clerk makes an original and a skeleton copy of the cryptographed message, these copies being henceforth handled in the same manner as nonsecret messages. The original of the plain text message is then marked, "Sent (date)" and is immediately returned to the originator's office for file. The original of the cryptographed message is passed to the transmitting agency, the skeleton copy is placed in the live file, and final disposition made in the same manner as for skeleton copies of nonsecret messages.

b. Incoming messages.—An incoming secret message is handled in the same manner as a nonsecret message except that the single copy of the plain text is marked by the code clerk "Secret."

■ 42. HANDLING RELAY MESSAGES.—*a.* The operator hands or sends both the original and the duplicate copy to the message center chief whether received cryptographed or in clear. If the message is received from a messenger, only the original is available.

b. The message is then handled as an outgoing message. It is not given a message number by the relaying message center.

c. A message received in secret text is not decryptographed by the relaying message center.

d. A copy of the message will be available in the message center with the operator's service for follow-up if received or transmitted by electrical means.

e. No copy of the message will be available in the message center if received and transmitted by messenger. In this case, the signed delivery list or message envelope is the only record. If considered necessary, a skeleton copy may be made for reference.

SECTION III

PROCEDURE IN HEADQUARTERS BELOW DIVISION

■ 43. GENERAL.—Simplicity and speed in handling message traffic are paramount considerations. If necessary to meet local requirements, unit commanders are authorized to make modifications in the procedure given in paragraph 47.

■ 44. ORGANIZATION.—*a.* In describing the procedure, duties are outlined for message center chief, messenger dispatcher, code clerk, messenger, and operators of the several means of signal communication. This division of duties is functional and is made for convenience in description. For definitions of the terms "message center chief" and "operator", see paragraph 36. For the classification of messages, see paragraph 19.

b. In small message centers during slack periods, one man may perform all the duties. For this reason each member of the message center team must be trained to perform all the duties incident to message center operation. The personnel should be able to operate as more than one team in order to provide for continuous operation when the command post is moved.

c. Radio operators are authorized to cryptograph and de-cryptograph messages when their radio station is separated from their message center by an appreciable distance or there is no message center. (See par. 49*b.*)

■ 45. FORMS AND EQUIPMENT.—*Message center procedure is not dependent on forms. No equipment other than pencil, paper, timepiece, and the authorized codes and cipher devices is required.* Certain forms such as delivery lists, number sheets, field message books, and message envelopes are, however, usually provided for convenience and to save labor. (See par. 37.)

■ 46. RECORDS.—The message center keeps only such temporary records as are required to insure rapid and accurate handling of message traffic. The following records are usually kept:

a. Number sheet.—Message center numbers are assigned to each outgoing message. (See par. 39*a* (4).) If desirable,

the chart referred to in paragraph 34c and the number sheet referred to in paragraph 37d may be combined into a message center log. An example of an extract of such a log is shown below. Spaces for 100 numbers and additional units may be conveniently provided on the form. If it is used, the instructions in this chapter dealing with the number sheet apply also to this form.

MESSAGE CENTER LOG										
1st FA Bn							9-6-41			
-----							-----			
(Unit)							(Date)			
Record of serviceability of means							No.	Re- marks	No.	Remarks
Units to which con- nected	RAD		TG		TP					
	In	Out	In	Out	In	Out				
6th Div Arty	645A	705A	715A	830A	705A	830A	1	Rad	51	
	830A	845A	845A	930A	845A	930A	2	Tg	52	
	930A	1000A	1000A	-----	1000A	-----	3	Msgr	53	
	-----	-----	-----	-----	-----	-----	4	Msgr	54	
	-----	-----	-----	-----	-----	-----	5	Msgr	55	
	-----	-----	-----	-----	-----	-----	6	-----	56	
	-----	-----	-----	-----	-----	-----	7	-----	57	
	-----	-----	-----	-----	-----	-----	8	-----	58	
	-----	-----	-----	-----	-----	-----	9	-----	59	
	-----	-----	-----	-----	-----	-----	10	-----	-----	

b. Receipt form.—The receipt form may be a delivery list, message envelope, message blank, or blank sheet of paper. If an acknowledgment has been requested by the writer, notation of this fact will be made on the receipt form. (See par. 38c.)

c. Live file.—The live file consists of a duplicate or skeleton copy of each outgoing message which has been sent to a signal agency for transmission but for which a receipt has not yet been obtained.

d. Dead file.—The dead file consists of the duplicate or skeleton copies of all receipted outgoing messages; completed

receipt forms; and the receipted duplicate clear text copies of all incoming messages received by means other than special messenger. The dead file is disposed of daily or oftener as directed by the unit communication officer. Unless otherwise directed by the commander, it is turned over to S-1 at frequent intervals so that messages may be included in the unit journal. (See par. 257.)

e. Code clerk's file.—This file contains the original clear copy of all outgoing messages sent as cryptograms and the original copies of all incoming cryptographed messages. *Caution: Clear and cryptographed copies of the same message must never be filed together.* The file is disposed of daily as directed by the unit communication officer. (See par. 257*d*.)

■ 47. HANDLING MESSAGES (see par. 21*c*).—The following procedure is one of several methods which may be used in handling messages at a message center. It should be remembered that the assignment of duties as tabulated below is functional and that one man may perform several or all functions in a certain message center, whereas one or more men may be necessary to perform a single function in another.

a. Message center chief.—(1) *Outgoing messages.*—(a) Receives message in duplicate from writer. (See fig. 1.)

(b) Makes skeleton copy when single copy or bundle of maps is submitted to message center.

(c) Writes or stamps on front or back of both copies—

1. Time filed.
2. Message center number.
3. How sent. (See fig. 2.)

(*d*) Checks message center number off number sheet by drawing diagonal line through corresponding number. (See fig. 3.)

(e) Notes briefly, opposite the assigned number and in remarks column of number sheet, data which he considers necessary for reference. (See fig. 3.) Examples:

1. Writer's designation.
2. Addressee.
3. Method of transmission (Rad, Tg, etc.).
4. Precedence.

(f) If the message is to go forward in the clear, he provides for its authentication group in the heading of the message and hands or delivers the original of the clear text message to the operator or messenger dispatcher and files the duplicate in the live file.

(g) If the message is to be cryptographed, he passes the original of the message to the code clerk and files the duplicate in the live file.

(h) When message has been delivered or transmitted he receives from—

1. *Messenger dispatcher*.—Signed receipt form or notification of time of release of pigeon. (A receipt form may be a delivery list, a message envelope, the duplicate copy of a message, or a blank sheet of paper.)

2. *Operator or panel station*.—Notification of time of receipt or time of airplane pick-up.

(i) Draws a crossing diagonal line through the number assigned to the message on the number sheet completing the letter X. (See fig. 3.)

(j) Removes duplicate copy of message from live file and if sent by—

1. *Messenger*.—Attaches receipt form and files both in dead file.

2. *Electrical means, pigeon, or airplane pick-up*.—Services duplicate copy by entering in blank space on face the time of receipt, or time of release, or time of pick-up, and his personal sign, and files in dead file.

(2) *Incoming messages*.—(a) *From local operators*.

1. *For local delivery*.—Receives the duplicate copy re-
ceived by addressee, if delivered by the radio operator, and files in dead file, or the original and duplicate, which are handled as in b(1) below.

2. *For relay*.—Receives original and duplicate of cryptographed or clear message. Handles same as outgoing message, except message center number is not given. Enters time filed and how sent on both copies of message.

(b) From scheduled messengers.

1. *For local delivery.*—Receives messages and signs receipt form; writes or stamps his own message center designation, date and time of receipt on the face, back, or cover; checks the authentication group of clear text messages (if not already done), marks them "Authenticated" or "Not authenticated," and hands the messages to messenger dispatcher, or passes cryptograms to code clerk; files completed receipt forms in dead file when received from messenger dispatcher.
2. *For relay.*—Proceeds as in 1 above, handing message to operator or messenger dispatcher. If necessary, makes skeleton copy and handles it like a duplicate copy of an outgoing message.

b. Code clerk.—(1) *Outgoing messages.*—(a) Receives original message from message center chief. (See fig. 2.)

(b) Cryptographs messages, making an original copy only.

(c) Enters following pertinent data on cryptographed copy:

1. Message center data.
2. If going by electrical means, inserts unit designation of addressee or call sign of unit, operating instructions if any, authentication group, and priority, if any. (See fig. 4.)
3. If going by messenger, inserts official designation of addressee and writer in clear on message or envelope.

(d) Forwards completed cryptogram to operator or messenger dispatcher when message is to go via messenger.

(e) Files original clear message.

(f) Destroys all work sheets by burning.

(2) *Incoming messages.*—(a) Receives original of message from operator or message center chief. (See fig. 8.)

(b) Marks message "Authenticated" or "Not authenticated." (See fig. 9.)

(c) Decryptographs message.

(d) Delivers original clear copy to addressee and gets receipt on duplicate which he gives to message center chief.

(e) Destroys all work sheets by burning.

c. *Operator*.—(1) *Outgoing messages*.—(a) Receives the original message from—

1. Message center chief if clear text.
2. Code clerk if cryptographed.

(b) Transmits message.

(c) Obtains receipt.

(d) Services message.

(e) Notifies message center chief of time of receipt and files message.

(2) *Incoming messages*.—(a) Copies message in duplicate.

(b) Services message.

(c) If message is in clear, passes it in duplicate to the message center chief who receipts on the duplicate. Local commander may require that he deliver the original in clear to the addressee when nearby, and obtain his receipt on the duplicate. Files receipted duplicate.

(d) If message is cryptographed, hands original to code clerk and files duplicate.

d. *Messenger dispatcher*.—(1) *Outgoing messages*.—(a) Receives original message from—

1. Message center chief if clear text.
2. Code clerk if cryptographed.

(b) Special messenger service—

1. Prepares receipt form by entering message identification and time dispatched thereon. (See fig. 12 which illustrates message envelope as receipt form.)

2. Hands message and receipt form to messenger and gives him any necessary instructions concerning the delivery.

(c) Scheduled messenger service—

1. Enters on receipt form the message identification as each message is received.
2. At time scheduled for next messenger's departure, writes or stamps the time dispatched on the receipt form and hands message and receipt form to messenger.

(d) If message is to go by pigeon, he places message in message holder, releases bird, and notifies message center chief of time of release.

SIGNAL COMMUNICATION

47

Signal Corps
Message Envelope M-40

URGENT MESSAGE
(Classification. If routine, leave blank.)

TO CO 1ST INF NO. 3
(Receipt for this message below or on the delivery list) (Or other identification)

Fill in the following and obtain receipt if delivery list is NOT used.

TIME DISPATCHED 0745 TIME RETURNED _____

RECEIVED _____ TIME _____
(Signature in full)

71-4033A

FIGURE 12.—Message envelope properly filled out by messenger dispatcher.

(e) If message is to go by airplane pick-up, he sends message to panel station, which notifies message center chief of time of pick-up.

(f) Enters time returned on signed receipt form when it is returned by special or scheduled messenger. (See fig. 13

Signal Corps
Message Envelope M-40

URGENT MESSAGE
(Classification. If routine, leave blank.)

TO CO 1ST INF NO. 3
(Receipt for this message below or on the delivery list) (Or other identification)

Fill in the following and obtain receipt if delivery list is NOT used.

TIME DISPATCHED 0745 TIME RETURNED 0803

RECEIVED James N. Moore TIME 0757
(Signature in full)

71-4034A

FIGURE 13.—Message envelope properly completed when used as a receipt form.

which illustrates completed message envelope as receipt form.)

(g) Hands receipt form to message center chief.

(2) *Incoming messages.*—(a) Receives messages from message center chief (code clerk and operator during heavy traffic).

(b) Prepares receipt form and dispatches messenger with receipt form and message.

(c) When signed receipt form is returned, writes or stamps time returned in proper place.

(d) Hands completed receipt form to message center chief.

e. *Messengers.*—(1) *Outgoing messages.*—(a) *Special messenger.*

1. Receives message and receipt form from messenger dispatcher.

2. Delivers message to addressee and obtains receipt. (Special messengers deliver all messages for division headquarters to division message center.)

3. Returns to own message center and writes his identification on face of receipt form and hands to messenger dispatcher.

(b) *Scheduled messenger.*

1. Receives messages and receipt form from messenger dispatcher.

2. Delivers messages to distant message center chief (addressee if not served by another message center) and obtains signatures and times of receipt on receipt form.

3. Returns to own message center, writes his identification on face of receipt form and hands to messenger dispatcher.

(2) *Incoming messages.*—For incoming messages a local messenger is employed during peak traffic loads who—

(a) Receives message and receipt form from messenger dispatcher for local delivery.

(b) Delivers message to local addressee and obtains receipt on receipt form.

(c) Returns to message center and enters his identification on face of receipt form.

(d) Hands receipt form to messenger dispatcher.

■ 48. MESSENGER SERVICE.—*a. Scheduled.*—(1) Scheduled messenger service is established only when the command posts and establishments are fixed for a sufficient length of time to warrant its employment. During combat, scheduled messenger service usually is not employed by units smaller than the division.

(2) Scheduled messengers always deliver their messages to the message center of the addressee. Receipt for messages is obtained on a receipt form.

(3) The signed receipt form is returned by the scheduled messenger to his own messenger dispatcher or message center chief.

b. Special.—(1) Special messengers should always be available. They are dispatched as needed.

(2) Special messengers dispatched to the headquarters of divisions or higher units deliver their messages to the message center of the unit concerned.

(3) Special messengers arriving at headquarters below the division deliver clear text messages direct to the addressee and cryptographed messages to the message center, securing receipt therefor. Information as to the location of offices is secured from the message center. Whenever practicable, an incoming messenger calls at the local message center after delivering his message in order that advantage may be taken of his return trip. However, his return will not be delayed for this purpose. Special arrangements are made to obtain receipt for messages sent by return messenger.

(4) The signed receipt form is returned by the special messenger to his own messenger dispatcher or message center chief.

c. Local.—In some situations, particularly in higher units due to dispersion of command post installations and other factors, it may not be practicable for the message center chief or the code clerk to hand messages direct to the transmitting agency or for operators or the code clerk to deliver their incoming messages direct to the addressee. Local messengers must then be available to provide for local deliveries within the command post.

SECTION IV

MILITARY CRYPTOGRAPHY

■ 49. USE OF CRYPTOGRAMS.—*a.* In time of war or national emergency, all messages to be transmitted by radio or by other means when danger of hostile or unauthorized interception exists, are cryptographed and, if necessary, authenticated, except that—

(1) When the tactical situation is such that time cannot be spared for cryptographing and when the information to be transmitted, if intercepted by the enemy, cannot be acted upon in time to influence the situation, the commanding officer or his authorized representative may order the transmission of messages in plain language. Written messages will be marked, "Send in clear," over the signature of the commander or his authorized representative. Responsibility for transmissions by radiotelephony in the clear rests with the officer in charge of the transmitting station. When written or oral messages in the clear are authorized, the maximum care must be taken to avoid disclosing the contents of future plans or locations of friendly troops and installations. The use of prearranged messages in the clear will expedite transmission.

(2) Commanders of units smaller than a division may authorize the normal transmission of messages in clear text which are to be acted upon immediately in rapidly moving situations.

(3) Transmission of artillery fire-control messages is in clear. (Fire-control code is considered clear text.)

b. All cryptographing and decryptographing of messages at a headquarters are performed in the message center, except as authorized in paragraph 44, unless the message requires a code or cipher not in the possession of the message center. The message center is provided with the authorized codes, cipher devices, and keys.

c. If it becomes necessary to modify the wording of a message to facilitate cryptographing, the modified text should be submitted to the writer before cryptographing.

■ 50. DEFINITIONS.—A knowledge of the following terms is essential for all personnel handling code and cipher messages:

a. "Plain text", "clear text", or "plain language" is the text of a message which, on its face, conveys an intelligible meaning in a spoken language.

b. "Secret text" or "secret language" is the text of a message which, on its face, conveys no intelligible meaning in any spoken language. The secret text of a message constitutes a cryptogram.

c. "Cryptography" is the science which treats of the various means, methods, and devices for converting plain-text messages into cryptograms and reconverting the so-produced cryptograms into their plain-text forms by a direct reversal of the steps or processes employed in the original conversion.

d. "Cryptograms" are of three types as follows:

(1) *Cipher*.—A cryptogram in cipher is one which has been produced by taking the individual letters of the plain text as units and applying to them either or both of two cryptographic processes known as "transposition" and "substitution" explained below. The resulting secret text is called "cipher text" and the operation of producing it is called "enciphering"; the reverse operation, that of reproducing the plain text from the cipher text by a direct reversal of the steps involved in its enciphering, is called "deciphering." The basis of every cipher system is an agreement between correspondents covering the general method and the steps to be followed in cryptographing. That part of the agreement which specifically controls the steps under the general method is termed the "key." The key is usually of a variable nature, changeable at the will of the correspondents. Normally it consists of an easily remembered word, phrase, or sentence; or of a number or series of numbers derivable from a word, phrase, or sentence. In signal communication, keys are changed in accordance with signal operation instructions.

(a) *Transposition cipher*.—The cryptographic process known as transposition consists in rearranging the letters (rarely syllables or whole words) constituting the plain text so that the resultant text becomes unintelligible. The letters undergo no change in identity; only their relative order is altered. A cryptogram which has been produced in this way is termed a "transposition cipher."

(b) *Substitution cipher*.—The cryptographic process known as substitution consists in replacing the letters constituting plain text by other letters, figures, symbols, etc. Here the letters undergo a change in identity without a change in their relative order. A cryptogram which has been produced in this way is termed a "substitution cipher."

(c) *Combined cipher*.—When both of these processes have been applied in producing a cryptogram, the latter is termed a combined "substitution-transposition cipher."

(2) *Code*.—(a) A cryptogram in code is one which has been produced by taking whole sentences, phrases, words, letters, or numbers of plain text as units and replacing them by arbitrary groups of symbols given as their equivalents in a code book. The resulting secret text is called "code text" and the operation of producing it is called "encoding"; the reverse operation, that of reproducing the plain text from the code text by reference to the code book, is called "decoding." A one-part code consists of an alphabetical list of code groups with a corresponding alphabetical list of equivalent meanings. This one section serves both for encoding and decoding messages. A two-part code consists of two sections; an encoding section and a decoding section. The encoding section comprises an alphabetical list of meanings set opposite random code groups. The decoding section comprises an alphabetical list of code groups with their equivalent meanings set opposite them. Since the one-part code lists both the code groups and the equivalent meanings alphabetically, a cryptanalyst is enabled to confine his search for the proper equivalent word to words whose initial letter occurs in a small section of the alphabet, whereas any word might be the equivalent meaning of a code group in a two-part code. As a consequence, the two-part code is much more secure than the one-part code.

(b) Code groups or code words are arbitrary groups of symbols constituting code text. They usually consist of letters or figures, rarely of both.

(3) *Enciphered code*.—A cryptogram in enciphered code is one which has been produced by first encoding the plain text and then enciphering the code text.

e. To "cryptograph" a message is to convert its plain text into secret text. This is a convenient term to use in re-

ferring to the processes involved without indicating or specifying whether they are methods of enciphering or encoding.

f. To "decryptograph" a message is to reconvert its secret text into plain text by a direct reversal of the operations involved in its cryptographing. This is a convenient term to use in referring to the processes involved without indicating whether the cryptogram is in cipher, in code, or in enciphered code. As enciphering and encoding are forms of cryptographing, so deciphering and decoding are forms of decryptographing.

g. "Cryptanalysis" is the name applied to the steps and processes involved in converting cryptograms (usually of hostile origin) into plain text by means other than those normally employed in decryptographing messages of friendly origin.

■ 51. SAFETY AFFORDED BY CRYPTOGRAPHY.—Codes and ciphers are used to condense messages or to maintain the contents secret, except from the addressee, or for both purposes. Unless secrecy is reasonably certain, all additional time, labor, and danger of error involved in cryptographic messages is wasted; moreover, the correspondents may be lulled into a false sense of security in the belief that their messages are secret, when, in fact, the enemy may have cryptanalyzed them and taken action accordingly. With the use of radio as well as other means of electrical communication, the safeguarding of codes and ciphers has assumed a paramount importance. No cryptographic system suitable for a voluminous official correspondence is absolute proof against the organized, cooperative efforts of a large and well-trained staff of cryptanalysts. Practically every cipher system that has ever been employed for military purposes has been solved and practically any code book can be reconstructed by analysis, given a sufficient number of cryptograms and the personnel and time necessary to accomplish it.

■ 52. COMPARISON OF CODES AND CIPHERS.—*a.* Both code and cipher methods are needed in the military service. The principal factors to be considered in comparing them are—

- (1) Simplicity, rapidity, practicability.
- (2) Secrecy.
- (3) Accuracy.
- (4) Economy.

b. In general, code is a more rapid and more simple method of secret communication than is cipher. The processes of enciphering and deciphering require very close mental attention to avoid errors, and are usually much slower than those of encoding and decoding, which are more nearly automatic. This is of greatest importance in the combat zone. There are some very small cipher devices which tend to reduce the mental strain to a minimum, but usually the cryptograms they yield are not as secret as those produced by a good code, especially when many messages are available for enemy interception.

c. Code systems are, on the whole, more secret than cipher systems, depending upon the type of code, the extent of its vocabulary or contents, and the extent to which it is used; that is, the number of messages transmitted. Furthermore, the solution of one message as a rule does not entail the immediate break-down of the whole system, with the consequent solution of all other messages in the same key, as it does in ciphers. However, it is necessary at all times to guard the code book so that it does not fall into the hands of the enemy. Actual possession is not always necessary, for a single opportunity to copy or memorize certain parts is sufficient to compromise the whole code.

d. Code systems, on the whole, are less accurate than cipher systems and are more subject to the necessity for repetition of messages, because a mistake in one or two code groups may obscure, alter, or render unintelligible the meaning of a whole message, whereas the meaning of a few letters which are in error in cipher may be supplied by the context.

e. Code text is usually shorter than the equivalent plain text. Codes of the two-part type must be changed rather frequently to maintain secrecy. This necessitates repeated processes of preparation, printing, and distribution, all of which take much time and labor.

■ 53. AUTHORIZED MILITARY CODES AND CIPHERS.—*a. Codes.*—The authorized codes when issued are accompanied with detailed instructions. The codes vary in type and composition

to fit the specific requirements. See AR 380-5 for the manner in which codes are authorized to be used.

b. Special codes.—Such codes as address and signature codes, map coordinate codes, geographic, meteorological, and supply catalog codes, as well as appendixes to the various codes mentioned in *a* above, may be published from time to time.

c. Prearranged message codes.—To reduce the time required for cryptographing and transmission in tactical situations, a single code group, the meaning of which will not be readily apparent to the enemy, may be used to convey a short complete tactical message. A listing of such code groups, together with their meanings, may be prepared in advance of tactical operations by unit commanders, and is called a prearranged message code. Security from enemy knowledge is based on frequent changes of the messages or in the assignment of code groups for the messages. The following is an example of the type of material suitable for a prearranged message code:

<i>Tg</i>	<i>Code group</i> <i>Tp</i>	<i>Meaning</i>
AB	AFIRE BAKER	Combat team 82 now at _____.
LO	LOVE OPTION	Division CP now at GETTYSBURG.

Employment of the 2-letter groups will give a possibility of 676 different combinations. Generally a limited number of groups will be required, and the selections of 2-letter groups having the greatest phonetic difference when transmitted in the international Morse alphabet should be used. The use of the authorized phonetic alphabet for telephone or radiotelephone transmissions insures phonetic differences. Short, distinctive words also may be used as the code groups, care being taken to avoid having two or more words of similar phonetic content. Where the signal officer feels that messages sent in the prearranged message code may be confused with messages in other codes, an indicator group may be assigned for use with the prearranged message code.

d. Ciphers.—Among others, the cipher device M-94 and converter M-209 are authorized for use in the military service (see secs. V and VI).

e. Indicators.—(1) A partial list of the various message

codes and ciphers with their indicators and the number of characters comprising each group is shown below. Indicators of codes authorized for training include the letter T before the number. For example, DFCT2 is the indicator for Training Edition No. 2 of the Division Field Code. Similarly, those authorized for use in maneuvers include the letter M. For example, AGLM1 is the indicator for a maneuver issue of the Air-Ground Liaison Code.

Name of code or cipher	Indicator	Number of characters per group
War Department Telegraph Code.....	No indicator.....	5
Division Field Code.....	DFC, followed by a number.....	4
Air-Ground Liaison Code.....	AGL, followed by a number.....	3
Meteorological Code.....	M, followed by two letters.....	4, 5, 6 or 7
Cipher Device M-94.....	CD, followed by numbers.....	5
Converter M-209.....	System indicator (see signal operation instructions). Message indicator (see TM 11-380).	5

(2) In place of the above indicators which, in effect, are clear-text abbreviations of the code or cipher system being used, secret or confidential indicators may be used, which resemble the code or cipher groups of the message and which can be interpreted only by reference to the special secret or confidential instructions which explain their meanings and use.

■ 54. RULES FOR USE OF CODES AND CIPHERS (AR 380-5).—The following general rules govern the use of codes and ciphers:

a. The instructions contained in each code book or furnished with each cipher system must be carefully studied and thoroughly understood before the code or cipher is used.

b. Care should be exercised to prevent the loss or compromise of a code book or cipher key. If a code book is lost or possibly compromised, the fact should be reported promptly to higher headquarters.

c. Except prearranged codes as indicated in paragraph 53c, no code or cipher which has not been approved by higher authority should be employed within any unit.

d. Care should be exercised that only one edition of a code of a particular class, or only one cipher key is being used within a unit at one time. When a code is replaced by a new code or a new edition, the replaced code will be destroyed by burning unless otherwise ordered.

e. Cryptographic messages should be short and concise. Long messages facilitate solution by the enemy.

f. Never repeat a message in a code or cipher other than the one in which it was originally sent. If the enemy has already solved one of the codes or cipher keys used, he will translate the message by that code or cipher key and will thus be given clues to the solution of the other code or cipher key.

g. Never cryptograph a message which has been sent previously in clear and never send a message in clear which has been sent previously as a cryptogram. If the enemy compares the cryptographic message with the clear message, he will be able to break into the code and solve other messages, or in the case of ciphers, he will have the key for the solution of all other messages.

h. Never mix secret and clear text in the same message. This applies also to abbreviations and signs of punctuation which are equivalent to clear text. If clear text of any kind whatever is left in the message, the enemy can more easily discover the meaning of the secret text. If cryptographed at all, the entire message must be cryptographed.

i. A cryptographed message never should be filed with the clear message. (See par. 46e.)

j. Capital letters should be employed throughout in writing cryptograms in order to avoid errors. The grouping of the letters of code text corresponds to the length of the code groups as given by the book; cipher text is written and transmitted in groups of five letters. (See par. 33.)

k. Do not cryptograph the address and signature. Where a particular addressee or originator must be indicated, it should be handled as described in paragraph 38b.

SECTION V

CIPHER DEVICE M-94

■ 55. PURPOSE AND DISTRIBUTION.—Cipher device M-94 is a cryptographic instrument that is an item of equipment issued by the Signal Corps to all message centers as one of the authorized means for secret communication. It is also an item of equipment possessed by all naval units and stations, including those of the Marine Corps, and can be employed in certain classes of secret intercommunication between the Army and the Navy when specific arrangements therefor have been made by the appropriate commanders. (See fig. 14.)

CAUTION: When in danger of capture, thoroughly destroy the cipher device beyond use or repair and, if possible, beyond recognition.

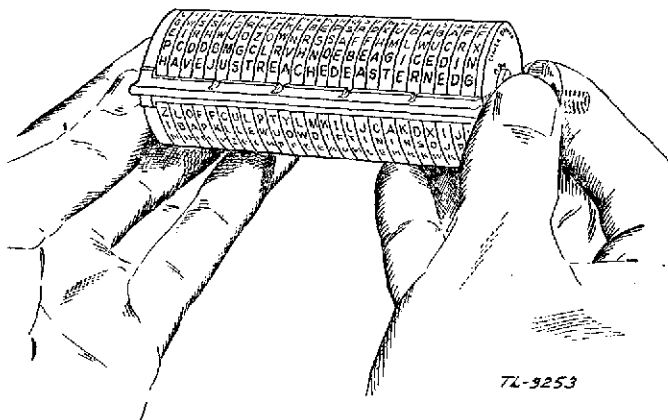

FIGURE 14.—Cipher device M-94.

■ 56. DESCRIPTION.—*a.* The device is made of aluminum alloy and consists of the following parts:

(1) A central shaft, the left end of which terminates with a projecting shoulder, the right end of which is threaded.

(2) A set of 25 alphabet disks, on the rim of each of which there is stamped a different, completely disarranged alphabet.

(3) A guide-rule disk, consisting of a blank or unlettered disk from which projects a guide rule.

(4) A retaining plate, consisting of a thin disk upon one surface of which is stamped the name and type number of the device.

(5) A knurled thumb nut.

b. Each disk has a hole at the center suitable for mounting it upon the central shaft upon which the disk can be revolved forward or backward. The left face of each alphabet disk is provided with a circle of 26 equidistant slots; the right face is cupped and carries at one point on the inside rim of this cup a small projecting lug. The guide-rule disk also carries such a lug. When the disks are assembled upon the shaft, the lug on each disk engages with one of the slots on the adjacent disk on the right and thus the disks can be held in engagement in any desired relative positions by screwing down the knurled thumb nut against the retaining plate, which is inserted between the last alphabet disk and the nut.

c. When the thumb nut and the retaining plate are removed and the alphabet disks are taken off the shaft, it will be noted that each alphabet disk is stamped on its inside or cup surface with an identifying symbol consisting of a number that is above the central hole and a letter that is below it. The numbers run from 1 to 25, inclusive, the letters from B to Z, inclusive. These symbols are employed to designate the sequence in which the alphabet disks are to be assembled upon the shaft in cryptographing or decryptographing messages as described in paragraph 58. Either symbol may be used for this purpose (as prearranged) but for the present, only the numerical identifying symbols will be so used.

■ 57. NECESSITY FOR KEY AND PROVIDING FOR CHANGES THEREIN.—a. Messages cryptographed by the same sequence of alphabet disks can remain secure against solution by a well-organized and efficient enemy cryptanalytic section for only a relatively short time. A conservative estimate would place the minimum at 6 hours, the maximum at 2 or 3 days.

For this reason it is necessary to change the sequence from time to time, and the method for determining or indicating the new sequence must be agreed upon in advance and thoroughly understood by all who are to use the instrument.

b. The sequence in which the alphabet disks are assembled upon the shaft constitutes the key in this cipher system. When a change in key is to take place, exactly what the new key will be and the exact moment it is to supersede the old key will be determined by the proper commander and will be published in signal operation instructions. (For example, see par. 265f.)

■ 58. DETAILED INSTRUCTIONS FOR SETTING DEVICE TO A PRE-DETERMINED KEY.—a. The method prescribed herein is based upon a key word or key phrase from which the sequence of numbers constituting the key for assembling the alphabet disks may be obtained by following a simple, standardized procedure. A relatively long sequence of numbers (which would be difficult to remember) may thereby be derived at will from a word or phrase (which is easy to remember) and the necessity of carrying the key in written form upon the person eliminated. The basic key word or key phrase, together with the numerical key derived as shown below, is distributed throughout the command in signal operation instructions.

b. Assume that the key phrase so distributed is **CHINESE LAUNDRY**. The detailed steps for deriving the numerical key sequence are as follows:

(1) Prepare a sheet of paper by drawing cross sections $\frac{1}{4}$ -inch square, 25 squares to the line, unless prepared sheets are available.

(2) Insert in the top row of squares the series of numbers from 1 through 25. Thus:

1	2	3	4	5	6	7	8	9	10	11	12	13	14	15	16	17	18	19	20	21	22	23	24	25	

71-5233

(3) Beginning under the number 1, insert the successive letters of the key phrase in the second line of squares under the successive numbers. Thus:

SIGNAL COMMUNICATION

58

1	2	3	4	5	6	7	8	9	10	11	12	13	14	15	16	17	18	19	20	21	22	23	24	25
C	H	I	N	E	S	E	L	A	U	N	D	R	Y											

7L-3234

(4) Extend the key phrase by repetition until there is a letter under the number 25, making a key sequence of 25 letters. (If the key phrase should contain more than 25 letters, those after 25 are merely omitted.) Thus:

1	2	3	4	5	6	7	8	9	10	11	12	13	14	15	16	17	18	19	20	21	22	23	24	25
C	H	I	N	E	S	E	L	A	U	N	D	R	Y	C	H	I	N	E	S	E	L	A	U	N

7L-3235

(5) Number the letters of the key sequence serially from left to right in accordance with their relative position in the ordinary alphabet. The letter A comes first in the ordinary alphabet, and occurs twice in the illustrative key sequence; therefore, write the number 1 under the first appearance of A in the key sequence and the number 2 under its second appearance. Thus:

1	2	3	4	5	6	7	8	9	10	11	12	13	14	15	16	17	18	19	20	21	22	23	24	25
C	H	I	N	E	S	E	L	A	U	N	D	R	Y	C	H	I	N	E	S	E	L	A	U	N
								I														2		

7L-3236

(6) The next letter in the ordinary alphabet is B. Examine the key sequence carefully to see if it contains the letter B. Since this letter does not appear in the key sequence, examine the key sequence for the letter C. This letter occurs twice in the illustrative key sequence. Write the number 3 under the first appearance of the letter C and the number 4 under the second appearance of the letter C. Thus:

1	2	3	4	5	6	7	8	9	10	11	12	13	14	15	16	17	18	19	20	21	22	23	24	25
C	H	I	N	E	S	E	L	A	U	N	D	R	Y	C	H	I	N	E	S	E	L	A	U	N
3								1						4								2		

7L-3237

(7) The next letter in the ordinary alphabet is D, which is present in the illustrative key sequence. Assign the number 5 to the only appearance of the letter D and so on through the alphabet taking each letter successively and assigning the next number in sequence to each appearance of the letter in the illustrative key. The work must be done carefully in order that no letter will be overlooked. If an error is made in the early stage of deriving the key, start anew. Be especially careful with letters which follow each other in the ordinary alphabet, but which are present in the key sequence in reversed order, such as the combinations ED, FE, ON, and so on. It is easy to make a mistake in these cases and as a consequence, the assigned numbers will appear in reverse order.

(8) When the numbering process is completed and if the work is correctly performed, there will be a number under every letter of the key sequence and the highest number will be 25. If not, an error has been made. Check the work and better still, if two clerks are available, each should derive the key independently and the final results checked by comparison.

(9) The key phrase selected for the foregoing example will yield the following key:

1	2	3	4	5	6	7	8	9	10	11	12	13	14	15	16	17	18	19	20	21	22	23	24	25
C	H	I	N	E	S	E	L	A	U	N	D	R	Y	C	H	I	N	E	S	E	L	A	U	N
3	10	12	16	6	21	7	14	1	23	17	5	20	25	4	11	13	18	8	22	9	15	2	24	19

74-3235

(10) This sequence of numbers indicates the order in which the successive alphabet disks are to be assembled on the shaft from left to right. According to the foregoing key sequence, place the alphabet disk No. 3 on the shaft immediately to the right of the guide rule disk; following disk No. 3, disk No. 10, and so on, are placed successively to the right of the guide-rule disk. Disk No. 19 is the last disk to be placed on the shaft using this particular key. When disk No. 19 is in place on the shaft, put on the retaining plate and the thumb nut. Turn the thumb nut on to the shaft sufficiently to retain the assembly and yet permit the revolving of the individual disks on the shaft. The device is now ready for enciphering and deciphering messages.

■ 59. CRYPTOGRAPHING A MESSAGE.—Suppose the following message is to be enciphered with the key used in paragraph 58:

CO 3d INF

HAVE JUST REACHED EASTERN EDGE OF WOODS
ALONG 552-592 ROAD WILL REMAIN IN OBSERVATION.

CO 2d BN

a. Omitting the address, write the message down on the work sheet underneath the key line in lines of 25 letters each. (With experienced code clerks, the work sheet may be omitted.) Allow two blank lines between each line of clear text set down on the paper for the insertion of the enciphered text. (For procedure in enciphering abbreviations and numbers appearing in the text of the message, see paragraph 60.) Thus:

1	2	3	4	5	6	7	8	9	10	11	12	13	14	15	16	17	18	19	20	21	22	23	24	25
C	H	I	N	E	S	E	L	A	U	N	D	R	Y	C	H	I	N	E	S	E	L	A	U	N
3	10	12	16	6	21	7	14	1	23	17	5	20	25	4	11	13	18	8	22	9	15	2	24	19
H	A	V	E	J	U	S	T	R	E	A	C	H	E	D	E	A	S	T	E	R	N	E	D	G
E	O	F	W	O	O	D	S	A	L	O	N	G	P	I	V	E	F	I	V	E	T	W	O	D
A	S	H	F	I	V	E	N	I	N	E	T	W	O	R	O	A	D	W	I	L	L	R	E	M
A	I	N	I	N	O	B	S	E	R	V	A	T	I	O	N									

71-3239

b. Revolve the disks on the shaft one by one, alining the first 25 letters of the message to form one continuous row of letters from left to right with the aid of the guide rule. After alining all 25 letters, lock the assembly in place so that no disk can become displaced in further manipulation of the cylinder. *The row of letters now appearing along the guide rule should be checked at this point to be sure that the text in clear appears as written on the work sheet.*

c. The circumference of the cylinder now presents 26 rows

of letters, 24 of which are visible, the remaining two being hidden or partially obscured by the guide rule. One of the 24 visible rows is the clear text row; the remaining 23 are cipher text rows, *any one of which may be used as the cipher text*. Select one of the cipher text rows at random and write the letters composing this row immediately under the clear text on the work sheet. Assume that you chose the row beginning JUKLD, the first row on the work sheet would then read as follows:

1	2	3	4	5	6	7	8	9	10	11	12	13	14	15	16	17	18	19	20	21	22	23	24	25
C	H	I	N	E	S	E	L	A	U	N	D	R	Y	C	H	I	N	E	S	E	L	A	U	N
3	10	12	16	6	21	7	14	1	23	17	5	20	25	4	11	13	18	8	22	9	15	2	24	19
H	A	V	E	J	U	S	T	R	E	A	C	H	E	D	E	A	S	T	E	R	N	E	D	G
J	U	K	L	D	Y	K	I	T	Z	I	I	V	C	Y	C	V	U	Y	V	P	Y	W	H	J

7L-3240

It is not necessary to make a record of the cipher text row (above or below the plain text row) used as the cipher text nor is it necessary to indicate anywhere in the cipher text which row was used.

d. Loosen the thumb nut but do not remove it from the shaft. Aline the next 25 letters of the plain text as in b above and tighten the thumb nut once more. Recheck your work and then select another cipher text line from the 23 lines available, except the one used in enciphering the first line of the text. Write the cipher line thus obtained under the second clear text line on the work sheet. Assume you select the line beginning YUYEZ, the work sheet will now appear as follows:

1	2	3	4	5	6	7	8	9	10	11	12	13	14	15	16	17	18	19	20	21	22	23	24	25
C	H	I	N	E	S	E	L	A	U	N	D	R	Y	C	H	I	N	E	S	E	L	A	U	N
3	10	12	16	6	21	7	14	1	23	17	5	20	25	4	11	13	18	8	22	9	15	2	24	19
H	A	V	E	J	U	S	T	R	E	A	C	H	E	D	E	A	S	T	E	R	N	E	D	G
J	U	K	L	D	Y	K	I	T	Z	I	I	V	C	Y	C	V	U	Y	V	P	Y	W	H	J
E	O	P	W	O	O	D	S	A	L	O	N	G	F	I	V	E	F	I	V	E	T	W	O	D
Y	U	Y	E	Z	D	H	V	U	Z	D	B	Q	P	O	Z	M	C	F	N	B	J	J	I	X

7L-3241

e. Continue this process in a similar manner with the third line of plain text. Do not make a practice of selecting any particular line of cipher text above or below the clear text. Avoid the selection of the line above the clear text line and the line below the guide rule. Assume that instructions have been followed up to this point and that you have selected the cipher text row beginning EAPTH to represent the third line of clear text, the work sheet now appears as follows:

1	2	3	4	5	6	7	8	9	10	11	12	13	14	15	16	17	18	19	20	21	22	23	24	25
C	H	I	N	E	S	E	L	A	U	H	D	R	Y	C	H	I	N	E	S	E	L	A	U	N
3	10	12	16	6	21	7	14	1	23	17	5	20	25	4	11	13	18	8	22	9	15	2	24	19
H	A	V	E	J	U	S	T	R	E	A	C	H	E	D	E	A	S	T	E	R	N	E	D	G
J	U	K	L	D	Y	K	I	T	Z	I	I	V	C	Y	C	V	U	Y	V	P	Y	W	H	J
E	O	F	W	O	O	D	S	A	L	O	N	G	F	I	V	E	F	I	V	E	T	W	O	D
Y	U	Y	E	Z	D	H	V	U	Z	D	B	Q	P	O	Z	N	C	F	N	B	J	J	I	X
A	S	H	F	I	V	E	N	I	N	E	T	W	O	R	O	A	D	W	I	L	L	R	E	M
E	A	P	T	H	Y	O	W	H	K	W	W	T	N	Y	G	M	P	R	Z	J	I	F	A	D

TL-3242

f. Because the signature is not enciphered, there are only 16 letters remaining to be enciphered which are not enough to complete a row of cipher text. Aline this third line of clear text consisting of 16 letters and select a row of cipher text

to represent them. Assume that you select the row beginning MEQRH, the work sheet now appears as follows:

1	2	3	4	5	6	7	8	9	10	11	12	13	14	15	16	17	18	19	20	21	22	23	24	25
C	H	I	N	E	S	E	L	A	U	N	D	R	Y	C	H	I	N	E	S	E	L	A	U	N
3	10	12	16	6	21	7	14	1	23	17	5	20	25	4	11	13	18	8	22	9	15	2	24	19
H	A	V	E	J	U	S	T	R	E	A	C	H	E	D	E	A	S	T	E	R	N	E	D	G
J	U	K	L	D	Y	K	I	T	Z	I	I	V	C	Y	C	V	U	Y	V	P	Y	W	H	J
E	O	F	W	O	O	D	S	A	L	O	N	G	F	I	V	E	F	I	V	E	T	W	O	D
Y	U	Y	E	Z	D	H	V	U	Z	D	B	Q	P	O	Z	M	C	F	N	B	J	J	I	X
A	S	H	F	I	V	E	N	I	N	E	T	W	O	R	O	A	D	W	I	L	L	R	E	M
E	A	P	T	H	Y	O	W	H	K	W	W	T	N	Y	G	M	P	R	Z	J	I	F	A	D
A	I	N	I	N	O	B	S	E	R	V	A	T	I	O	N									
M	E	Q	R	H	B	P	O	J	T	Y	U	Q	N	T	W									

7L-3243

g. Now copy the cipher text on the message form in five-letter groups. It will then appear as follows:

```

JUKLD  YKITZ  IIVCY  CVUYV  PYWHJ
YUYEZ  DHVUZ  DBQPO  ZMCFN  BJJIX
EAPTH  YOWHK  WWTNY  GMPRZ  JIFAD
MEQRH  BPOJT  YUQNT  W

```

h. The last group of the message is not a complete group of five letters; make it a complete group by adding four X's. These are not cryptographed, but are merely added to complete the cipher group. The final work sheet on this message will appear as follows:

```

JUKLD  YKITZ  IIVCY  CVUYV  PYWHJ
YUYEZ  DHVUZ  DBQPO  ZMCFN  BJJIX
EAPTH  YOWHK  WWTNY  GMPRZ  JIFAD
MEQRH  BPOJT  YUQNT  WXXXX

```

The message as it now appears is one of many forms in which the enciphered text might appear externally, depending on which of the cipher text rows were selected for each line of the encipherment.

i. All work sheets utilized in cryptographing the message will be destroyed by burning.

■ 60. CRYPTOGRAPHING ABBREVIATIONS, PUNCTUATION SIGNS, AND NUMBERS.—*a.* Authorized abbreviations appearing in the original plain-text message may be enciphered as abbreviations without periods. Examples: Am Tn=AMTN; E. V. Brown Sch=EVBROWNSCH.

b. The writer of a message must spell out the punctuation signs he wishes transmitted; for example, STOP, COMMA, COLON, etc. Otherwise punctuation signs will not be transmitted. (See par. 38a(3).)

c. Cardinal and ordinal numbers when spelled out in letters in the original plain-text message are always enciphered exactly as spelled.

d. Cardinal numbers when expressed in figures in the original plain-text message must be spelled out digit by digit in cryptographing. Examples:

4=FOUR

40=FOURZERO (*not* FORTY)

400=FOURZEROZERO (*not* FOUR HUNDRED)

455=FOURFIVEFIVE

2005=TWOZEROZEROFIVE

12.01 AM=ONETWOZEROONEAM

5.15 PM=FIVEONEFIVEPM

To save time in the encipherment of numerals, an abbreviated method of substituting one letter for each of 10 digits may be authorized in signal operation instructions. Thus "ALONG 552-592" might be enciphered as "ALONG JJP DASH JBP." The substituted letters must then be enciphered.

e. Ordinal numbers above the ordinal number 10th, when expressed in figures followed by "d", or "th", are cryptographed merely as digits spelled out without adding the "d" or "th." The omission of the "d" or the "th" will cause no confusion or ambiguity. Examples: 3d Bn=THIRDBN; 7th Pk Tn=SEVENTHPKTN; 11th Rgt=ONEONEREGT; 403d Am Tn=FOURZEROTHREEAMTN.

■ 61. DECRYPTOGRAPHING A MESSAGE.—*a.* If the key word or key phrase is known, the numerical key sequence can be de-

veloped as described in paragraph 58 and the set of alphabet disks assembled accordingly. Write the message to be decrypted in rows of 25 letters on cross section paper, if available; leave space under each line for the insertion of the plain-text letters. Using the cipher message given in paragraph 59h, it would appear under the key in the following form:

1	2	3	4	5	6	7	8	9	10	11	12	13	14	15	16	17	18	19	20	21	22	23	24	25
C	H	I	N	E	S	E	L	A	U	N	D	R	Y	C	H	I	N	E	S	E	L	A	U	N
3	10	12	16	6	21	7	14	1	23	17	5	20	25	4	11	13	18	8	22	9	15	2	24	19
J	U	K	L	D	Y	K	I	T	Z	I	I	V	C	Y	C	V	U	Y	V	P	Y	W	H	J
Y	U	Y	E	Z	D	H	V	U	Z	D	B	Q	P	O	Z	M	C	F	N	B	J	J	I	X
E	A	P	T	H	Y	O	W	H	K	W	W	T	N	Y	G	M	P	R	Z	J	I	F	A	D
M	E	Q	R	H	B	P	O	J	T	Y	U	Q	N	T	W									

7L-3244

b. Set up the first 25 letters of the cryptogram on the cipher device, alining the letters in a row from left to right. Fix the disks in place by screwing down the thumb nut and check your work. Rotate the cylinder scanning successive rows until one is found which is intelligible all the way across from left to right. One row *and only one* will be found. That row contains the first 25 letters of the plain text. Insert these letters in the proper place on the work sheet which will give the following:

1	2	3	4	5	6	7	8	9	10	11	12	13	14	15	16	17	18	19	20	21	22	23	24	25
C	H	I	N	E	S	E	L	A	U	N	D	R	Y	C	H	I	N	E	S	E	L	A	U	N
3	10	12	16	6	21	7	14	1	23	17	5	20	25	4	11	13	18	8	22	9	15	2	24	19
J	U	K	L	D	Y	K	I	T	Z	I	I	V	C	Y	C	V	U	Y	V	P	Y	W	H	J
H	A	V	E	J	U	S	T	R	E	A	C	H	E	D	E	A	S	T	E	R	N	E	D	G

7L-3245

c. Loosen the thumb nut and set up the next 25 letters of the cipher text. Lock the assembly in position and again check your work before scanning the rows for one containing plain text. Again write these 25 letters down in their proper place on the work sheet and continue the process until the whole message has been decryptographed.

d. If any difficulty is experienced in picking out a plain text row, the context of the preceding row should give a good clue as to the plain text following it. In the message illustrated above, the last four letters of the group are not to be decryptographed since they were merely added to make the last group of the cryptographed text a complete group of five letters. Omit them from the work sheet.

e. Copy the plain text message on a message form. The code clerk may, if authorized to do so by the message center chief, convert the numbers which had to be spelled out to be enciphered to their equivalent arabic numerals. Copy abbreviations and punctuation signs exactly as they stand in the decryptographed message.

SECTION VI

CONVERTER M-209

■ 62. DESCRIPTION AND USE.—a. Converter M-209 is a small, hand-operated, all-mechanical cryptographic machine that is an item of equipment issued by the Signal Corps to all message centers serving units below the division, and to certain types of armored force vehicles, and aircraft. In enciphering, it makes a printed record of the cryptogram; in deciphering, it makes a printed record of the plain text message. Its speed of operation is approximately 12 groups per minute.

b. TM 11-380 contains detailed information regarding the construction and operation of the machine, necessary adjustments, and repairs. While the manual may give illustrative examples of keying arrangements, specific cipher keys which are employed in actual field operations are issued in signal operation instructions.

CHAPTER 3

MESSENGER COMMUNICATION

	Paragraphs
SECTION I. General	63-65
II. Training of personnel.....	66-71
III. Employment.....	72-81
IV. Dropped messages.....	82-85
V. Pick-up of messages.....	86-90

SECTION I

GENERAL

■ 63. GENERAL.—Messenger communication is needed and used by all units from the smallest to the largest. Both personnel and equipment are necessary for messenger communication, but of all means of signal communication, it is most dependent upon personnel, and only to a minor degree upon equipment. All persons in the military service are directed to assist messengers carrying important orders or messages by pointing out the route, giving directions, and providing transportation if necessary.

■ 64. PERSONNEL.—*a.* The personnel needed for messenger communication consists primarily of messengers, but agents, airplane pilots, observers, and others are required in special situations. Usually messengers are a part of message center sections of units operating a message center, but if they are not, they should be attached to those sections for training and employment. These additional messengers will be provided from personnel other than communication personnel by the commanding officer of the unit which the message center serves.

(1) Messengers are persons who carry messages as defined in paragraph 5. In the field a dismounted messenger is named a runner. Other messengers are named according to the means of transport used by them; as, mounted (horse), bicycle, motorcycle, motor, and airplane.

(2) Agents are special messengers, usually noncommis-

sioned officers, employed by commanders for liaison with subordinate, adjacent, or supported units (see pars. 71 and 81).

b. The great dependence of messenger communication upon personnel necessitates that personnel should be selected with the following characteristics as a basis:

(1) Motorcycle, bicycle, mounted messengers, and runners should be young and sturdy.

(2) Messengers, especially runners and agents, are required to have courage to a marked degree. They are often sent on important missions the accomplishment of which requires extraordinary self-reliance and endurance.

(3) Messengers and agents are required to have an intelligence above the average. They must be resourceful, able to comprehend simple oral orders, to use compasses and maps, and to understand changes in tactical situations.

(4) Extreme loyalty is necessary to insure trustworthiness. In messengers, loyalty and courage will compensate to some extent for deficiencies in physique. These men must carry out their instructions and duties with care and certainty.

■ 65. EQUIPMENT.—All messengers should be provided, when necessary, with a compass and a message-carrying bag. In addition, all except runners and some agents, require a means of transportation. A motor messenger may be the driver of a vehicle or he may be an additional occupant, depending upon the circumstances. Commanders of all units may find it necessary in an emergency to utilize, for messengers, any motor vehicle assigned to their units. The motor vehicle park for messengers should be several hundred yards away from headquarters. Motor messengers should be instructed to exercise caution in the manner in which their vehicles are parked in order that they may be immediately accessible and at the same time not visible to enemy observation. Message center officers should take advantage of motor transport and trains traveling over routes used by messengers as a means of transportation for messengers. An airplane may have solely a messenger mission, it may perform such a mission in addition to its other work, or it may be used only to transport an ordinary messenger. See sections IV and V for the equipment necessary for dropping and picking up messages by airplane.

SECTION II

TRAINING OF PERSONNEL

■ 66. BASIC.—See TM 11-450 for the minimum training specifications for signal specialists, and particularly those for a basic private, a basic corporal, and a basic sergeant. The training outlined in the paragraphs below for messengers, except airplane pilots or observers, follows the completion of the training for a basic private and that for agents follows the completion of the training for a basic corporal or sergeant.

■ 67. RUNNER.—The runner will be qualified in—

a. Transmitting oral and written messages.

b. Traveling across country over various kinds of ground at the prescribed rates. (See par. 75c.)

c. Using a compass as a means of orientation and as a means of following a given azimuth.

d. Reading maps and orienting himself by stars or sun so as to locate routes, terrain features, and troop positions, and to be able to follow highways, ravines, streams, and telephone or telegraph lines.

e. Selecting routes from map or ground that will furnish the best cover and concealment consistent with time limit of delivery.

f. Observing and reporting troop movements.

g. Recognition of officers, units, ornaments, and insignia with which they are associated. (In the combat zone where use of ornaments and insignia is limited, the runner should be taught to question guides to identify officers and units.)

h. Conveying information and orders by whistle, by conventional arm and hand signals, and by prearranged flag or light signals.

i. Using a delivery list and message envelope as a receipt form.

■ 68. MOUNTED MESSENGER.—In addition to the training of a runner, a mounted messenger will be qualified in—

a. Feeding, watering, and grooming animals.

b. Saddling and bridling animals, and adjusting their equipment.

c. Care of animals in garrison and field; to include recognition of common ailments, administration of necessary first-aid treatment, and care of back and feet.

d. Equitation, including riding at all gaits over varied terrain.

e. Covering specified distances in specified times, all within the limits of endurance of the animal.

f. Concealing and protecting animals during combat.

■ **69. BICYCLE, MOTOR, AND MOTORCYCLE MESSENGERS.**—In addition to the training of a runner, bicycle, motor, and motorcycle messengers will be qualified in riding, driving, and caring for the vehicle which transports them, and in traveling in accordance with traffic regulations and rules of the road.

■ **70. AIRPLANE MESSENGER.**—If the airplane messenger is the pilot or observer, he will be qualified in radio and visual communication, and in dropping and picking up messages, all of which are covered elsewhere in this manual. (See pars. 82 and 86.)

■ **71. AGENT.**—An agent is a soldier acting as a personal representative of a commander at the headquarters of his next superior commander. The agent will be qualified in—

a. Transmitting oral and written messages.

b. Receiving and transmitting messages accurately by telephone.

c. Using the message blank.

d. Using the compass.

e. Reading maps.

f. Making a simple sketch.

g. Observing and reporting troop movements, troop positions, and terrain features.

h. An elementary understanding of the organization and tactical employment of his unit and of the unit to which he is sent.

i. Conveying messages by visual signaling with flags and lights, or by conventional or prearranged arm and hand signals.

SECTION III

EMPLOYMENT

■ 72. GENERAL.—For further details as to the employment of messengers, see chapter 2.

■ 73. SELECTION OF TYPE OF MESSENGERS USED.—The effectiveness of messenger communication is largely dependent upon the selection of the proper type of messenger. This selection is based upon the urgency, length, or bulk of the message, terrain, weather, and types of messengers and transportation available.

a. Runner.—Runners are used when other means of signal communication will not function in a dependable manner, when other means become overtaxed, when distances are short or the route is impassable for other messengers, and also in small units not provided with other means of communication. The runner is able to go where other types of messengers cannot go, and he can conceal himself more easily. He should not, however, be used for long distances, unless relays are established.

b. Mounted, bicycle, and motorcycle.—Messages are sent by mounted, bicycle, and motorcycle messengers when the enemy situation and the condition of the route permit the use of horses, bicycles, or motorcycles.

c. Motor.—Motor messengers are normally used between headquarters separated by not more than 4 hours' motor time, when the mail service will not suffice. They may be placed on a routine schedule or may be subject to call as required.

d. Airplane.—(1) The commander of a division or higher unit who has attached aviation or commanding officer of any air force unit may assign airplanes to the messenger service when other means of signal communication will not suffice. Important messages transmitted between widely separated units or between allied armies may be best delivered by airplane.

(2) Messages may be handed on the ground to the pilot, observer, or a messenger traveling in the airplane, or delivered to the airplane in flight by radio, panels, pyrotechnics, pick-up, flag or lamp signals, or other means. (See sec. V.)

(3) Messages transmitted by airplane may be delivered directly by the pilot, observer, or other messenger on the ground; or from the airplane in flight by radio, pyrotechnics, or other visual means, or by dropping. (See sec. IV below.)

■ 74. RECEIPT OF MESSAGES FOR DELIVERY.—*a.* The officer or noncommissioned officer directing the transmission of a message gives the messenger the following information:

(1) Name and location of the headquarters or person to whom the message is to be delivered.

(2) Route to be followed unless left to the messenger's discretion.

(3) Danger points to be avoided.

(4) Speed required.

(5) Whether or not an answer is expected.

(6) Where to report upon return.

(7) Where to report in case the message is not delivered.

(8) Special instructions, if any.

(9) Contents of the message if the situation warrants.

b. When one or more messages are entrusted to a messenger, a delivery list is attached, or he is directed to obtain receipts on the envelope or other receipt form.

c. The messenger is instructed to report his destination to the nearest leader when passing an outpost or other line established by a security detachment. This officer or noncommissioned officer should orient the messenger and lend aid, if required, to expedite the delivery. (See par. 63.)

■ 75. CARRYING MESSAGES.—*a.* Messages will be carried in the message-carrying bag when one is provided. If none is provided, the messages will be carried in the upper left-hand pocket of the blouse or the left-hand pocket of the shirt. Bulky packages are carried in the hand or under the arm. In inclement weather they should be protected by a raincoat or waterproof covering.

b. When the situation permits, messengers will travel by covered routes. When approaching or leaving command posts, messengers will be particularly careful to avoid disclosing the location to hostile air observation. They should use such measures as are necessary to insure prompt delivery and to prevent needless exposures. When practicable, routes over difficult terrain which may be traversed at night should be reconnoitered during the day by the messengers who will use

them at night. When necessary they will inquire their way of troops they may meet.

c. Messengers will be trained to travel, under good road conditions, at the following prescribed rates given in miles per hour:

	Runner	Mounted messenger	Bicycle messenger	Motor and motorcycle messenger	Airplane messenger
Routine.....	3	6	6	25	Limitations of the airplane.
Priority (P).....	5	8	10	40	
Urgent (O)..... and Operational priority (OP).	Highest speed consistent with certainty of arrival.				

d. Messengers may be instructed to show unsealed messages to designated commanders whom they may meet on the route. Each person reading such a message will initial it.

e. The importance of preventing messages of all kinds from falling into enemy hands will be impressed upon all messengers. When in immediate danger of capture, messages will be destroyed. Before destruction, if circumstances permit, their contents will be committed to memory.

f. Messengers found wounded or killed will be searched and any message discovered will be delivered to the nearest message center or commander.

■ 76. DELIVERY OF MESSAGES.—a. For routine delivery of messages, see chapter 2.

b. Because oral messages are subject to error in transmission, they should not be used when time permits written messages; however, oral messages may often be necessary in mobile units and fast moving situations. When used, they should be short and simple. Messengers deliver them verbatim. A messenger receiving an oral message repeats it back to the sender so there may be no misunderstanding.

The messenger repeats it to himself until he has committed it to memory.

c. Messengers may at times be required to carry back a reply or other messages destined for their own command. However, their return will not be delayed for this purpose.

d. When the headquarters, message center, or the individual addressed cannot be found without undue loss of time, messengers will report to the nearest headquarters and request instructions.

e. Messengers whose transportation has become disabled will continue to their destination in the most practicable manner. It may be advisable to report to the nearest headquarters for assistance and instructions. In event of being incapacitated by wounds, they should turn their messages and instructions over to any reliable person whom they may encounter. When such action is necessary they will keep a record of the person, time, and place and turn it in at the first opportunity to the message center or to the person from whom the message was received.

f. Messengers will travel in accordance with instructions from the messenger dispatcher. In the presence of a person not definitely recognized as a member of their own army, messengers will make no mention of the direction from which they have come or of their destination.

g. Messengers will help other means of signal communication to function when it is possible to do so without interfering with their own task. For instance, if they discover breaks in wire lines they will report the location.

■ 77. **DOUBLE MESSENGERS.**—Double messengers should be used when the mission is important or dangerous, such as movement through hostile territory, past enemy patrols, over ground swept by small-arms fire, or over heavily shelled areas. Double messengers must keep within sight of each other yet remain separated by such distance as will prevent both being exposed to hostile fire or ambushed at the same time. Each should carry a copy of the message. It is sometimes advisable to send messengers over several routes at the same time.

■ 78. **ROUTES.**—a. Routes over which messengers are to travel usually will be selected by the officer or noncommissioned

officer in charge. They must be chosen with due regard to—

- (1) Type of messenger which is to be used.
- (2) Concealment from enemy observation.
- (3) Availability under existing orders or traffic conditions.
- (4) Length and condition.

b. Messengers must be instructed very carefully as to the routes which they will follow in traveling to their destination. Ordinarily signs will not be used to point the way; in lieu of the signs, guides are posted at intervals along principal routes and at crossroads to direct traffic and messengers.

c. It may be advisable to send messengers over routes once by daylight, preferably with other messengers who have been over the route. Through difficult terrain, runners may be instructed to follow telephone wires maintaining their direction at night by letting a wire pass through the hand. Wires may be laid to guide runners at night or through dense woods. Alternate routes are selected whenever the principal route cannot be used because of congestion, enemy observation, or shelling.

■ 79. SCHEDULED MESSENGERS (par. 39).—When periodic trips are desirable, a scheduled messenger service is arranged by message centers and the necessary assignment of messengers made in accordance therewith. The messenger dispatcher will equalize the work assigned to messengers.

■ 80. RELAY POSTS.—Relay posts are established when messages must be carried frequently between the same points or units and when, by reason of distance, difficulties of terrain, or hostile activity, the physical strain and danger of casualty render the operation of through messengers too arduous and uncertain. A chain of relay posts may be organized from a squad or similar group of men trained to function as such and operating under the normal group leader who is responsible for its operation and for the replacement of casualties. Posts are preferably double or multiple to lessen the chance of interruption through casualties. Relays may also be used when a change in the method of transportation en route is necessary. Relay posts exposed to enemy raids should be of sufficient strength to provide for their own security.

■ 81. AGENTS.—*a.* Below the division all necessary information can usually be obtained or distributed through reports and field orders, though agents prove useful in special cases. During combat, agents may be exchanged by adjacent platoons or larger units.

b. A headquarters or unit sends out an agent or agents when the service of information, need of coordination, or special occasion requires his particular service. An agent may deliver instructions, transmit information, perform duties of reconnaissance, or work as guide.

c. Agents will be instructed regarding the information which they are to furnish to, and request from, the headquarters or unit to which they are sent. These instructions usually concern the disposition, location, and movements of units, command posts, and headquarters; and the intention, plan, success, and failure of operations. Agents will be given information which may be of value to their respective unit commanders and they will transmit such information as soon as practicable thereafter.

SECTION IV

DROPPED MESSAGES

■ 82. USE.—Normally messages are dropped by airplane observers only to units down to and including the battalion; but by prearrangement, messages may be dropped to any unit, detachment, or individual. During heavy shelling by friendly batteries, messages usually are not dropped to units in front of the light artillery positions.

■ 83. DROPPING GROUNDS.—Message dropping grounds or panel display grounds are located near the radio station. Panels are displayed on these grounds when there is a message for the airplane observer or when the observer calls for panels. A dropping ground should be an open space removed from high trees, bodies of water, and weeds. (See pars. 87 and 150.) By prearrangement, messages may be dropped at any predetermined point where panels may or may not be required to indicate the dropping ground.

■ 84. PROCEDURE.—When it is desired to drop a message to a particular unit, a prearranged pyrotechnic or other signal,

meaning "display identification panels," is made when the airplane is over the unit for which the message is intended. The unit's assigned identification panels are then displayed, and the message is dropped from the airplane as near as possible to the identification panel display. When the location of the unit for which the message is intended is known, or if conditions of combat require it, the message may be dropped without a request for a display of identification panels. Therefore, on the approach of a friendly airplane, all ground troops should observe the airplane for a dropped message. Whether or not prearranged signals are made from the airplane, the message will be picked up by the nearest troops and taken at once to the commanding officer or his representative. Ground troops will indicate that the message has been received by means of a prearranged panel display or other signal, such as waving the message bag or container after it has been retrieved. After the drop message has been delivered to the commanding officer or his representative, the message bag or container will be returned by mail or scheduled messenger to the nearest Army Air Forces troops.

■ 85. EQUIPMENT.—*a.* Bags, drop-message, Air Corps, type A-1, are provided as a part of the equipment of practically all combat airplanes. The quantity provided depends upon the use and the probable needs of the particular type of airplane. The message bag, made of 8-ounce duck, is 7½ inches long by 5¼ inches wide. Attached to the top of the bag, in order to mark the line of descent and its location on the ground, is a 72-inch cotton bunting chrome-yellow streamer. Sewed fast in the bottom section of the bag is a 2-ounce lead bar to keep wind drift at a minimum. The front compartment of the bag contains ¼ ounce of kapok to keep it afloat if it falls into water. A flap with snap fastener is provided to fasten the message compartment securely. Printed on the back center of the bag are the words, "MAIL OR DELIVER TO THE NEAREST U. S. AIR CORPS TROOPS," which refer to the return of the message bag and not to the delivery of the message, and in the upper right-hand corner are the words, "OFFICIAL BUSINESS ONLY. Penalty for Private Use \$300.00."

b. Certain type airplanes, for example, observation airplanes, are equipped with kit, air message, Air Corps, class O3F, which contains—

- (1) 20 each, bag, assembly drop-message, type A-1.
- (2) 1 each, holder assembly, air message, pad, type A-3.
- (3) 5 each, pad, air message.
- (4) 2 each, pick-up assembly, message, type A-1.

c. The Air Corps message container, type A-4, used to drop maps or photographs, consists of an aluminum tubular message container which is closed with a cork and streamer assembly. The tube is $9\frac{3}{4}$ inches long and $1\frac{1}{4}$ inches in outside diameter. A chrome-yellow waterproof streamer, 72 inches long by $3\frac{1}{2}$ inches wide, is attached to the rubber cork by means of a line through the center of the cork and knotted at the bottom. When not in use the streamer is tucked inside the tube so that the observer or pilot may readily pull the cork and streamer out of the tube, insert the message, turn the cork around, close the tube with the cork leaving the streamer on the outside. In event the container falls into the water it should float for a period of 2 hours or longer if it has been properly closed and dropped.

d. The Air Corps message container, illuminated, type A-6, is specially designed to drop messages at night. It consists of an aluminum alloy tube approximately $10\frac{3}{4}$ inches long and $2\frac{7}{8}$ inches in outside diameter, a flash-light assembly which fits inside the bottom of the tube, and a 2-foot square parachute which is attached to the tube by means of four shroud lines. The tube is protected with clear varnish and all metal other than aluminum or aluminum alloy is cadmium plated. Rubber bumpers are provided to absorb the shock received in striking the ground. In order to mark its descent to ground troops, two bulbs are provided, one in the bottom and another in the top of the tube, the latter to illuminate the parachute. It weighs $1\frac{1}{2}$ pounds exclusive of batteries. This message container should float for a period of 2 hours or longer if it falls into the water.

e. Modification of the above types of message bags or containers may be developed and made available for special purposes such as to drop messages at night or to drop small parcels or objects.

SECTION V

PICK-UP OF MESSAGES

■ 86. USE.—*a.* This means of message transmission may be used only when the requirements for a pick-up field (par. 87) can be met and the airplane landing speed does not greatly exceed 100 miles per hour. In addition, the ground troops must be equipped with the required panels, improvise satisfactory substitutes, or make the necessary prearrangements for the airplane pick-up service.

b. Messages normally are picked up by airplane observers from units down to and including the battalion when the requirements of *a* above are met. By prearrangement, messages may be picked up from any unit or detachment. During heavy shelling by friendly batteries, messages are usually not picked up from units in front of the light artillery positions.

c. This means is used to afford communication from a ground unit to an airplane observer. Frequently the pick-up message is a reply to a message dropped by an airplane observer. It may be combined, usually by prearrangement, with the drop method at another location to provide airplane messenger service between ground units. However, except in emergencies, drop and pick-up airplane messenger service is seldom used between ground units unless they are separated by a considerable distance. (See par. 153*b*.)

d. The method of pick-up described herein is used when it is desired to pick up messages or other light packages from localities where landing fields are not available. In that case, observation aircraft must carry a supply of message bags and the equipment required by the observer. Ground troops must assemble or improvise the equipment required.

■ 87. PICK-UP FIELD.—An open field is selected 300 yards or more in length with clear approaches up and down wind. The required length should be verified by ground troops with the particular air unit working with them. There should be no obstacle in the line of flight of the airplane which would keep it from flying close to the ground. The direction of the wind must be carefully noted as the line of flight of the air-

plane will be into (against) the wind. The degree of success obtained will depend largely upon the selection of the field and the careful lay-out of the equipment.

■ 88. EQUIPMENT.—*a. Required on the ground.*—The equipment required on the ground is—

(1) Two poles 12 to 15 feet in length such as lance pole PO-2 or trimmed saplings.

(2) Two large nails, about 10-penny.

(3) Sixty feet of cord about $\frac{1}{8}$ -inch in diameter, preferably waxed. If this is not available, any flexible material of equal strength, length, and weight will suffice. The cord is used to make the message transfer loop.

(4) Two panels AL-121, AL-122, or suitable substitutes. These are code and distinguishing panels 12 feet long and 2 feet 4 inches wide. (See par. 143.)

(5) Message bags. The Air Corps, drop-message bag, type A-1 (see par. 85a), will often be available from a previously dropped message. If not, it may be improvised in various ways. (See par. 90.)

(6) Two stakes. Bayonets or tent pegs may be used for this purpose or rocks may be substituted for chocking the poles.

b. Required in the air.—The equipment required in the air is—

(1) Fifty feet of waxed braided cotton cord $\frac{3}{16}$ -inch diameter or equivalent, to be used for the pick-up line.

(2) A leaded weight of about 2 pounds with four hooks attached to the pick-up end of the cord line. Other specially designed weights also may be used. (See par. 85a.)

c. Preparation and arrangement on the ground.—(1) The equipment is prepared as follows:

(a) A large nail is driven through each pole about 6 inches from the top so that the nail point will protrude about 2 inches and slant up at an angle of about 45°. If available, small streamers are attached at the top of the poles to aid the pilot in locating the equipment. Small streamers also help indicate wind direction and facilitate rearrangement of pick-up poles in event there is a change. Care must be exercised that the streamers and pick-up loop do not become entangled.

(b) The cord is then prepared as follows: Tie both ends to the message bag, thus making a single loop of the cord. The message bag should be weighted with some foreign substance of small volume (stones if necessary), to bring it to a weight of about 1 pound. If parcels are to be picked up, the cord should be tied in a similar manner. However, unless satisfactory prearrangements can be made, no attempt should be made to pick up parcels in excess of 3 pounds.

(2) Determine and indicate the direction of the prevailing wind. Any reliable wind test can be used such as a wind streamer or tossing dry dirt or dust into the air. Normally the wind direction will be indicated to the pilot by a wind tee placed upwind from the spot where pick-up poles are to be placed. When pick-up service is maintained over a lengthy period the wind direction should be frequently checked and the proper change in the arrangement of ground equipment made whenever necessary. Care must be exercised in determining and indicating wind direction because the pilot must rely greatly upon ground personnel for this information.

(3) Figure 15 shows the arrangement of the equipment. The poles are placed about midway of the field and should be lashed to stakes or bayonets driven into the ground about two pole lengths apart. Care should be taken to drive the support stakes so that they will cut out of the ground, or some other provision made, so that the poles will fall if they are struck. In the absence of stakes, the poles may be chocked upright with rocks. If much pick-up work is likely to be done, short metal stakes with pole sockets attached will be useful. Place the poles so that the points of the nails point into (against) the wind. Hang the cord over the nails and pull the slack out so that the message bag will lie on the ground on a line midway between the poles, down wind (toward the approaching airplane.)

(4) Marking panels are now laid out, one extending from the base of each pole in the direction toward which the wind is blowing. These panels mark the pick-up position for the pilot and should always be used or improvised. The wind tee is normally placed upwind about 100 yards from the

pick-up poles and is arranged to represent an airplane flying into (against) the wind.

(5) All ground personnel should stand outside the danger area during the pick-up.

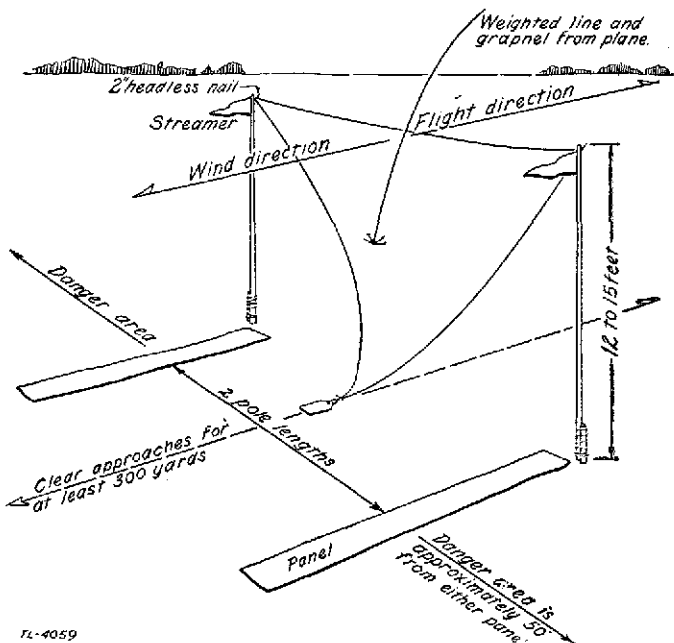

FL-4059

FIGURE 15.—Arrangement of equipment for picking up messages by airplane.

■ 89. PROCEDURE.—*a.* Upon receipt and acknowledgment of the panel or other signal meaning "Pick-up message at this point," the airplane is flown over and circles the area until the pilot observes the lay-out of the equipment. When all is ready, the observer lowers the weighted pick-up line. He grasps a bight of the line without wrapping it around his hand or otherwise securing it to his body, when all but a few feet of the line have been released. The airplane then approaches against the wind with the weight trailing on the

end of the line and will pick up the cord with the message attached by catching the cord with the weighted line. The line is then pulled into the airplane and the message is removed. The ground detail immediately takes up all panel signals. It is the duty of the observer to assist the pilot in making an accurate pick-up; he should therefore be alert, as the airplane approaches the cord, to lengthen or shorten his line so that the weight will strike below the top section of the cord. The observer will take every precaution possible to prevent the weight from striking the ground which might cause it to rebound thereby missing the pick-up loop, striking the airplane or ground personnel.

b. More than one attempt may be necessary before the message is successfully picked up. If an attempt is unsuccessful, the ground detail prepares for another trial. The panel signal meaning "Pick-up message at this point" will not be displayed until all is ready for the next attempt.

c. All members of the ground detail should watch the approaching airplane and especially the weight on the end of the line. Since it is difficult for the pilot to control the path of the line and weight exactly, all ground personnel will stand to one side at least 50 feet clear of the poles.

■ 90. TRAINING.—In preparing training programs, provision should be made where practicable for training in picking up messages with and without issue equipments.

a. In order to impress all personnel with the possibility of using this means of signal communication without standard issue equipment, ground troops should be required to improvise all equipment required. Organizational equipment, personal equipment, or articles obtained locally should be utilized for this purpose. For example, two small trees might be cut for use as poles, stubs or branches utilized in lieu of nails, undershirts might serve as panels, handkerchiefs as streamers, and unraveled shelter tent ropes for cord. An old rag, handkerchief, or sock may be use for a message bag; some sand, a few pebbles, or a small stone should be used for ballast.

b. Similarly Army Air Forces personnel should be taught to improvise the equipment used in the airplane. The fish-

SIGNAL COMMUNICATION

weight of the pick-up assembly may be made in several ways, frequently being any small heavy object to which nails or hooks can be tied or attached. Drop message bags or metal tubes may be improvised by Army Air Forces personnel to resemble closely those described in paragraph 85. The bag and streamer may be made out of heavy cloth. Two ounces of sand may be used as the weight to counteract wind drift; a small piece of light dry wood may be used in place of the kapok to make the bag float in water; and a draw string or other suitable fastener may be provided to close the message compartment. The message tube may be improvised from any light tubular material by welding or sealing one end shut and providing a plug or stopper for the other end. Streamers may be attached with the stopper.

CHAPTER 4

PIGEON COMMUNICATION

■ 91. GENERAL.—*a. Capabilities.*—A trained homing pigeon will return to its loft from a distant point, carrying any light message which has been properly attached to it, at an average speed in excess of 37 miles per hour. Fog, rain, snow, and darkness decrease the efficiency of the birds. Specially trained night-flying birds are frequently available. Percentage loss is very low. When received, pigeon messages are delivered to the nearest message center for forwarding to the addressee through other channels of signal communication. When lofts are assigned to special missions, messages may be delivered as directed by the commander of the special mission. The following are some examples of the use of pigeons in emergencies and in special situations:

(1) Forwarding important messages when other means of communication fail.

(2) Forwarding map overlay messages, which are especially valuable during combat, at regular or frequent intervals. Reports from patrols or reconnaissance units are especially advantageous, and should be made as frequently as the supply of pigeons on hand warrants.

(3) Transmitting a communication of any kind that may conserve messenger personnel when under fire.

(4) From field artillery observation posts to their headquarters when wire circuits are not available.

(5) From airplanes in flight to their headquarters or to combat commanders to which they are assigned.

(6) From air-borne infantry and parachute troops to their rear echelon.

b. Organization.—Pigeons are contained in portable, mobile, or stationary pigeon lofts, usually attached or assigned to army, corps, and division headquarters. A signal pigeon company is an organic part of a field army, and is under

control of the army signal officer who will direct the assignment of lofts to the headquarters of the army, corps, divisions, and other units. Each of the three combat platoons of the signal pigeon company is trained for independent action and may be attached to other forces as required.

c. Training.—Pigeons function by training in the terrain in which they are used, and their lofts remain fixed as long as possible. Lofts remain in the terrain occupied by the army regardless of the movements of divisions and corps in or out of the area. The pigeon loft should be directly connected by telephone or other signal communication means to the headquarters of the army, corps, division, or other unit which it is serving. Pigeons should be used regularly during periods of training, as well as in combat, to permit personnel to become accustomed to handling them, and to train the birds.

■ 92. DELIVERY, CARE, AND USE OF PIGEONS.—*a. Delivery.*—Army, corps, or division message centers usually act as an agency of supply of pigeons which they receive from the lofts. Officers in charge of message centers may use the supply of pigeons on hand if ordinary means of communication are interrupted. Birds crated in pigeon equipment PG-60 are drawn as needed by signal and communication officers, who hold the pigeons available for the use of combat unit commanders, from the pigeoneer stationed at message centers by exchanging an empty container for the loaded container. This container is tagged to indicate whether it contains day or night pigeons, and it is equipped with the following:

- (1) Water and feed container for each bird.
- (2) Feed for pigeons.
- (3) Extra message capsules.
- (4) Field message book.
- (5) Overlay paper.
- (6) Pencil.
- (7) Gas protection bags when necessary.

b. Care.—(1) Pigeons must be kept in a dry place sheltered from stormy weather.

(2) The capsule which is attached to the right leg of each bird should not be removed.

(3) The only feed given to the birds should be that included in the pigeon equipment. Care should be taken to assure that the feed remains dry. If kept more than 24 hours they should be fed once a day at the rate of a teaspoonful of mixed grain per bird per feeding, but should not be fed on the day they are to be used. If liberated hungry they will carry out their mission more rapidly.

(4) The pigeon should have water available at all times whenever practicable. If not practicable, the bird should be watered at each feeding. Water should be fresh, clean, and changed twice daily. The pigeon should be watered 15 to 20 minutes prior to release.

(5) Pigeons are very susceptible to carbon monoxide gas and should not be transported in the luggage compartment of vehicles.

c. Use.—(1) *Maximum time before release.*—Pigeons should not be kept confined away from their loft for a longer period than 2 days and 3 nights. After 3 nights they should be released provided replacement pigeons can be obtained. In emergency they can be held for longer periods. If birds are drawn from a message center at night ordinarily they should be released before darkness the following night. Commanders of combat units should use pigeons each day to develop the efficiency of their pigeon communication.

(2) *Messages.*—Messages to be sent by pigeon may be written on sheets from the field message book or may be written on any available paper. Map overlay tissue is supplied with the PG-60.

■ 93. **RELEASING PIGEONS.**—*a. Day birds.*—(1) Pigeon equipment PG-60 is provided with an individual door opening giving access to the message capsule on each bird (see fig. 16). Reach into the compartment and hold the pigeon's right leg below the capsule, remove the cover of the capsule, insert the message in the cover, and replace the cover. The message should be applied without removing the bird from the cage whenever possible.

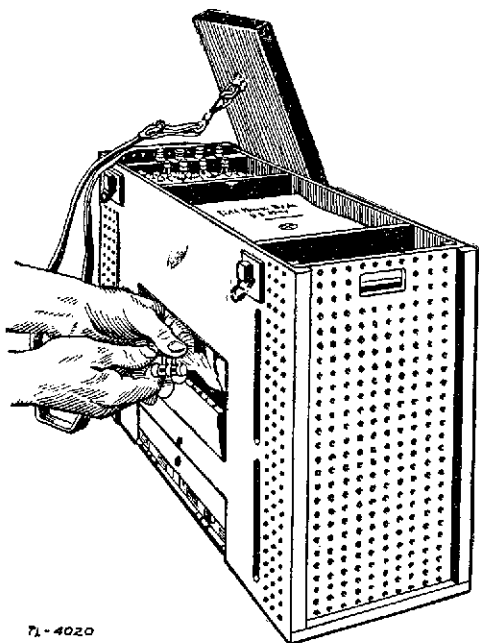

71-4020

FIGURE 16.—Pigeon equipment PG-60, showing the method of obtaining access to the message capsule.

(2) To release the bird, lift the doweled door as indicated in figure 17. Allow the bird to depart of its own volition.

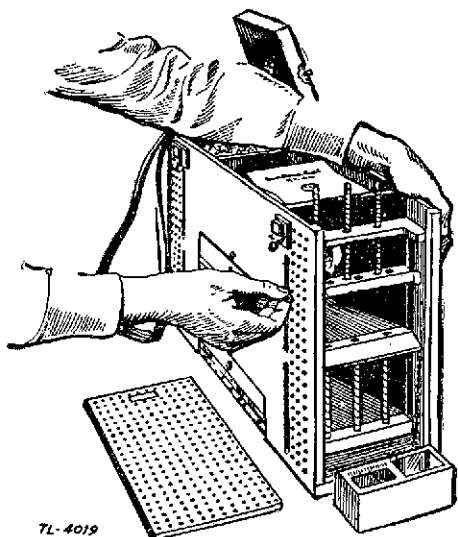
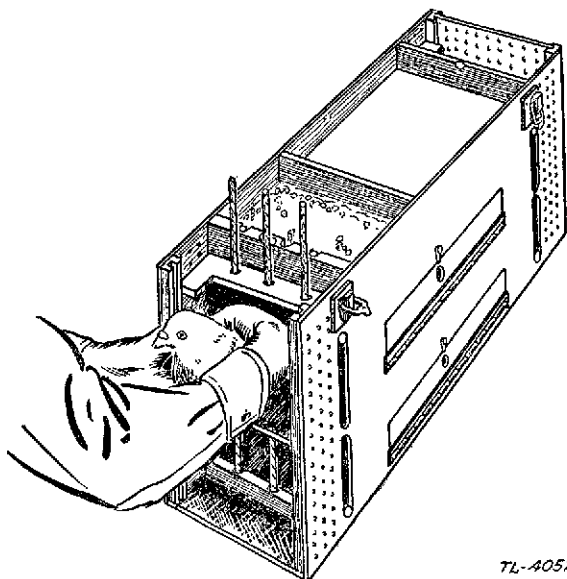

FIGURE 17.—Pigeon equipment PG-60, showing method of releasing pigeon.

b. Night birds.—(1) It is necessary to release night flying birds by hand rather than as indicated in *a* above. To do this, open the doweled door of the case and catch the pigeon gently in both hands as shown in figure 18.



TL-4052

FIGURE 18.—Method of removing bird from pigeon equipment PG-60.

(2) Shift the position of the hands on the bird to that shown in figure 19.



FIGURE 19.—Method of holding bird preparatory to release.

(3) Bend forward as shown in figure 20 with arms extended at full length.



FIGURE 20.—First position in release of a night bird.

(4) Rise rapidly, throwing the bird high in the air as shown in figure 21.



FIGURE 21.—Position of operator at moment of release of the bird.

(5) The bird must be forcibly thrown into the air as high as possible.

CHAPTER 5

RADIO COMMUNICATION

	Paragraphs
SECTION I. General.....	94-100
II. Tactical radio nets.....	101-108
III. Operating regulations.....	109-114
IV. Station records.....	115-120

SECTION I

GENERAL

■ 94. RADIO SETS.—*a.* A radio set consists usually of a transmitter for sending out radio waves and a receiver for converting radio waves from other stations to intelligible signals. Radio sets are broadly classified as amplitude-modulated (AM) or frequency-modulated (FM), and as continuous-wave (CW), or as tone- or voice-modulated.

b. Amplitude modulation and frequency modulation are explained in TM 11-455. A significant difference so far as operation in the field is concerned is that a frequency-modulated receiver responds only to the strongest signal being received on any frequency and therefore the presence of other weaker signals cannot be detected, whereas an amplitude-modulated receiver reproduces simultaneously all signals received on the same frequency with resultant interference, but all signals present may be heard in the background.

c. Continuous-wave signals require the generation within the receiver of a signal to be mixed with the incoming signal in order to produce an audible sound, but provide the sharpest tuning and the greatest range for a given radio set. In tone and voice modulation, the transmitter emits a signal which is modified by a locally generated tone, controlled by a key, or by a telephone transmitter so as to convey intelligence. Both continuous-wave and tone-modulated signals are used in radiotelegraphy.

■ 95. DEFINITIONS.—Terms as used in this chapter are defined below. For definitions of other terms, see paragraphs 5 and 17.

a. Break-in operation.—A method of operation wherein the receiving operator can interrupt the transmitting operator at any time.

b. Call sign.—A group of letters and numerals or a word, used for station identification.

c. Frequency assignment.—The frequency or frequencies, usually expressed in kilocycles (kc) or megacycles (mc), at which the station is authorized to operate. For sets which are calibrated in channels or tuner settings, this assignment is made by allotting channels or tuner settings.

d. Headings.—The heading of a message is that part which appears before the text begins. (See TM 11-454.)

e. Intercept station.—A station that copies enemy radio traffic for the purpose of obtaining information or friendly traffic for the purpose of supervision.

f. Internet traffic.—Traffic between stations which are not assigned to the same net.

g. Linking station.—A station used for the relay of messages from one net to another.

h. Mobile station.—A station that normally operates from a stationary location but which can be rapidly transported to another location. The station can be operated while in motion.

i. Number.—The numbers defined below should not be confused with the message center number referred to in chapter 2.

(1) *Station-to-station serial number.*—A number assigned by an operator to an outgoing message to facilitate handling and checking of traffic. It is never used in the abbreviated form message.

(2) *Writer's number.*—A number which may be given a message by the writer and which is a part of the text. (See par. 38a(6).)

j. Net.—A grouping of stations on one frequency for purposes of intercommunicating. Usually the net is organized to follow the chain of tactical command—a radio station at

the superior unit and radio stations at each of its immediate subordinate units. (See also sec. II.)

k. Net call sign.—A call sign used to call all stations in a net.

l. Net control station.—The station which coordinates and supervises the stations within the net to assure prompt and efficient service to the commander.

m. Operator's service.—(1) *Receiving service.*—Station from which received, station-to-station serial number, receiving operator's personal sign, and time of receipt. The time of receipt appears below the last word in the message. The balance of the service appears at the top of the message blank.

(2) *Sending service.*—Station to which sent, station-to-station serial number, personal sign of sending operator, and time sent. Example: NR5 JX 2343.

n. Personal sign.—One or two letters identifying the operator but not necessarily his initials. It is never transmitted.

o. Portable set.—A radio set which can be carried without the use of a vehicle and operated while in motion.

p. Position-finding station.—A station containing one or more radio receivers capable of indicating the direction from which incoming radio waves are arriving.

q. Radiotelegraphy.—Radio communication by means of the International Morse Code.

r. Radiotelephony.—Radio communication by means of voice.

s. Semimobile station.—A ground station which is transportable by a vehicle but normally operated only from a fixed location.

t. Signal operation instructions.—See paragraph 265.

u. Station log.—A chronological record of traffic and unusual events kept at a station.

v. Text.—That part of a message between the break sign (\overline{BT}) and the suffix. (See TM 11-454.)

w. Time of receipt.—That time the receiving station receipts for a message.

x. Traffic.—All transmitted and received messages.

y. Transmission.—Complete communication between stations.

z. Trick or watch.—A tour of duty as an operator.

aa. Vehicular station.—A station permanently installed in

a vehicle so that it is capable of operation with the vehicle in motion.

■ 96. **EMPLOYMENT.**—*a.* Radio is used as a means of signal communication for tactical control, for fire control, for administrative purposes, and for liaison between and within all units to whom the equipment is available. It is essential to highly mobile elements such as aircraft and armored units, and is especially applicable to motor movements and fast-moving situations.

b. Radiotelegraphy is the normal means of radio communication when distances involved are great and when, by reason of the subject matter and the time factor, formal messages in cipher and code are required. The International Morse Code is used for radiotelegraphy by the Army and Nav. (See appendix III and FM 24-6 and TM 11-454.) In combat and maneuver zones where radio activity is curtailed, it is desirable to establish radio nets with reduced power, dummy antennas, etc., consistent with signal security regulations for the purpose of maintaining radio operators at their highest efficiency.

c. Radiotelephony is used when person-to-person communication is required in the interests of speed and necessity and when, by reason of the nature of the communication or the time factor involved, secrecy is relatively unimportant. In general, it is especially suited to the uses of forward combat units for communication between airplanes, between airplanes and the ground, between vehicles in motion, between vehicles and ground stations, and with light portable radio sets. The use of radiotelephony in combat requires a high state of training and discipline on the part of individuals concerned to render transmission intelligible, to avoid congestion, and to provide the necessary signal security.

d. Radio communication within a tactical unit on the march may be established at prearranged times and places or between vehicular and mobile stations accompanying the units and operating while actually on the march.

■ 97. **CAPABILITIES.**—*a.* The range of radio communication is, in general, independent of conditions of roads and traffic, and is affected by the nature of the intervening terrain in

a varying degree depending upon the frequency used. Vehicular sets, however, are affected by conditions of roads and traffic. Weather conditions may have a serious effect on range. (See par. 99.)

b. Radio communication is the most effective means of signal communication between rapidly moving units when the maintenance of wire and messenger communication is impracticable.

c. Radio communication can be readily intercepted and interfered with by hostile stations. It is for this reason that emphasis is placed on encoding messages, as prescribed in paragraph 49. International code is *not* a form of cryptography. Strict discipline is necessary to make messages short, cryptic, and few in number to avoid giving information to the enemy and unnecessarily congesting radio channels. (See par. 112.)

d. The approximate number, types, and locations of our radio stations can be determined by hostile position-finding stations. From this information the enemy can estimate the disposition and approximate strength of our forces. This disadvantage of radio communication can be minimized by—

(1) Curtailing the use of radio during the times this information would be of most value to the enemy.

(2) Establishing dummy stations to cause errors in his deductions.

(3) Shifting the location of stations frequently.

(4) Training radio operators in the strict observance of radio discipline and radio security.

(5) Frequent changes and limited use of call signs.

(6) Limiting the number of stations in a net.

(7) Utilizing low power when possible.

e. Hostile radio stations can interfere deliberately with our radio communication by blocking a single frequency or band of frequencies. The enemy may also cause our stations to accept false information or messages. They may also falsely receipt for traffic to prevent reception at the proper station. The effects of deception can be minimized by the use of a frequently changed authentication system.

■ 98. TRAINING OF RADIO OPERATORS.—See TM 11-450 and TM 11-454.

■ 99. LOCATION OF STATIONS.—*a.* The following considerations are important in the location of radio stations:

(1) Stations should be in quiet localities, protected from moisture and from enemy fire. The copying of weak signals requires great concentration by the operator. Therefore, noise and confusion in the vicinity of stations should be minimized.

(2) Stations should be placed at a distance from any source of radio interference. Sources of possible interference are power lines, telegraph and telephone lines, and electrical equipment of any sort, including nearby radio stations.

(3) Radio sets which can be located by enemy position-finding units should be located at least 200 yards or more from a command post and remotely controlled where possible. Also, it is unwise to have the sets placed so they inclose the command post, thus showing the enemy the definite command-post area.

b. Radio waves, especially those of high frequencies, may be screened by intervening objects such as high hills, wooded areas, large structures of reinforced concrete and steel, and pole lines carrying conductors. To minimize the effect of such screening, the radio station should have its antenna located in a clear space and elevated when practicable. (See par. 97*a.*) However, advantage may be taken of this characteristic to screen transmissions from the enemy. In any case, the item of antiaircraft observation must not be overlooked.

■ 100. SPECIAL USES OF RADIO.—*a.* Radio is used in the military service for numerous special purposes, among which are—

(1) *Reception.*—(a) Position finding of enemy radio stations on land, ships, or aircraft.

(b) Interception of hostile radio traffic.

(c) Interception of friendly radio traffic for supervision.

(d) Collection of upper-air meteorological data from aircraft.

(2) *Transmission.*—(a) Time signals.

(b) Press reports.

(c) Counterpropaganda.

b. These special services are operated and maintained by Signal Corps personnel of the higher units, usually the army.

c. Copying of press reports is a function of the army signal service which in turn rebroadcasts to the lower units.

SECTION II

TACTICAL RADIO NETS

■ 101. GENERAL.—*a.* Tactical nets are made up of mobile or vehicular low-power radio stations of tactical units in the field. Tactical nets are given a name indicative of the superior headquarters in the net, such as the First Army net or the 4th Infantry Division Artillery net. (See par. 106.)

b. Nets operate either on schedule or continuously (continuous watch). Nets operating on schedule handle traffic only at definite, prearranged times and in accordance with a prearranged schedule of intercommunication. Nets operating continuously are prepared to handle traffic at any time; they maintain operators on duty at all stations in the net at all times. When practicable, messages relating to schedules will be transmitted by a means of signal communication other than radio.

c. All stations in a net normally operate on the same frequency or channel.

d. A separate frequency or channel for each station in a net is required when duplex operation is used, that is, when each station is transmitting and receiving simultaneously.

■ 102. CONTROL.—*a.* In every net one of the stations is designated as the net control station, abbreviated NCS. The NCS is charged with the clearing of traffic within the net, with dispatching internet traffic as quickly as possible, and with maintaining order within the net. Questions concerning traffic are referred to the NCS for decision. The authority of the NCS extends only to the operation of the net and its discipline on the air, and is in no way concerned with the interior administration of any station, nor with its tactical operation or movement. Within its scope, however, the authority of the NCS is absolute, its decisions are final,

and its orders are strictly obeyed. These orders are generally transmitted in the form of procedure signals, or messages, but may be contained in written orders, circulars, or letters of instruction. (See par. 112.)

b. Duty as NCS is generally assigned to the station of the superior headquarters in the net, but may be assigned to any station in the net which can best fulfill the duties. All other stations in the net are known as secondary stations and are under control of the NCS.

c. A secondary station is always designated by the NCS to take over the functions of the NCS if the NCS leaves the net for any reason. This station is called NC2.

■ 103. OPERATION.—a. A net may be operated as—

(1) A *free net*, in which any station can communicate with any other station in the same net without first obtaining permission to do so from the NCS.

(2) A *directed net*, in which no station, except the NCS, can communicate, except for the transmission of urgent messages with any other station, without first obtaining the permission of the NCS. Permission granted to a station to transmit one or more messages includes all transmissions necessary to complete the transmission of such messages.

b. Nets ordinarily are operated free, but the NCS may change to directed net operation at any time if it is unable otherwise to maintain proper control. In a directed net, traffic moves more slowly than in a free net. A directed net should be used only when all other means of obtaining order have failed. Free net operation is resumed as soon as the necessity for directed net operation has passed.

c. A secondary station always informs the NCS promptly when it knows it will be unable to follow out its schedules, or unable to have its station on continuous watch at any time during which a continuous watch is to be maintained. (See par. 101b.)

■ 104. TRAFFIC.—a. Nets must be prepared to assume the entire traffic load of their units at any time. For this reason close cooperation with the message center is essential. Radio stations are given a telephone connection whenever practicable and especially when they are remote from the command post.

b. A communication will not be interrupted until completed except as prescribed in paragraph 19c. When stations are using the break-in system of operation, communication may be interrupted by the receiving operators.

c. Urgent messages are transmitted to the station of destination or to a linking station as soon as possible, under the restriction imposed in b above, without obtaining permission from an NCS. (See par. 107.)

■ 105. ASSIGNMENT OF FREQUENCIES AND CALL SIGNS.—a. Radio nets must operate on assigned frequencies to prevent interference with each other and each radio station must be identified by a call sign. Assignments of call signs and frequencies are issued in the form of signal operation instructions. (See par. 2657 for examples applicable to an infantry division.) See FM 11-10 for examples of division radio net charts.

b. Changes in assignment of call signs and frequencies for signal security may be expected by radio nets in the combat zone. These changes will be made at intervals which may vary in length from several hours to several days.

c. The use of any call sign or frequency not assigned by higher headquarters is prohibited.

■ 106. ESTABLISHING A NET.—a. During the concentration period, station call signs, net call signs, duties, and frequencies are assigned to the various stations and nets. (See fig. 22.) When time permits, sets in the net should be calibrated prior to the opening of the action.

b. Radio stations conform to the movements of the organizations served. As soon as a station is set up and in operation at the desired location it endeavors to report into the net of which it is a part.

c. The first station set up acts as NCS and the second station as NC2 until the regularly appointed NCS reports into the net and takes control (par. 102). The NCS, when necessary, causes each new station reporting into the net to adjust its frequency until all stations can be heard on the same dial setting of the receiver of the NCS. The NCS may adjust its frequency in accordance with directions from one of the secondary stations until that station receives the NCS and all other stations in the net on the same dial setting. This

adjustment of net frequency is made when the third station reports into the net and each station reporting thereafter with an incorrect adjustment is caused to adjust its frequency before it transmits any traffic. The NC2 takes over the duties of the NCS in case the NCS disappears from the net or leaves the net without giving other instructions. Usually

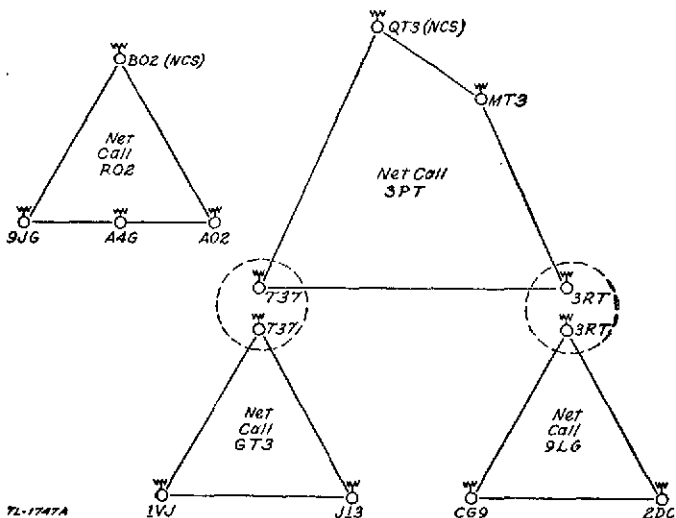

FIGURE 22.—Tactical radio nets.

the first station of a net in a numerical or alphabetical sequence of call signs, other than the NCS, is automatically NC2 unless some other prearrangement has been made.

d. Procedure signals are provided in TM 11-454 and FM 24-6.

■ 107. INTERNET TRAFFIC.—a. *Necessity.*—Figure 22 may be considered as representing a system of tactical nets. The nets 3PT and GT3 and the nets 3PT and 9LG are linked physically by having two stations at a common headquarters, while the net RO2 is physically isolated. Consequently, while

a message originating in the net 9LG with destination in the net GT3 could be handled either by relay through the net 3PT or by direct internet communication, all traffic to or from the net RO2 must be handled by internet communication.

b. *Procedure.*—Except for the transmission of urgent messages, a station obtains permission from its own NCS to leave the net, stating with what station it is going to work, and reports to the NCS of the new net before transmitting any traffic in that net. A station reports back into its own net as soon as its business is finished in the outside net. If the station does not know the call sign of the net or of the NCS, or the frequency to be used, it obtains such information by means other than radio, if practicable.

■ 108. RADIO INTELLIGENCE—INTERCEPT AND POSITION FINDING.—a. Enemy intercept and position finding services can easily locate our transmitters. This can be minimized by using the least practicable number of transmissions. Frequent changes of call signs and frequencies of operation will confuse the enemy intercept services and cause them to arrive at wrong conclusions as to strength of our forces.

b. Position finding is accomplished by means of a calibrated directional antenna which operates a receiver. By reading the scale of the antenna when the antenna is rotated to a point of minimum reception, the direction from which the signal is arriving can be determined. If two or more of these position-finding stations located at some distance apart take simultaneous bearings on the same signal, the extensions of the lines on the map, indicating the direction of reception, will intersect at the approximate map location of the transmitting station. (For a detailed discussion of the theory of position finding see FM 11-20.)

SECTION III

OPERATING REGULATIONS

■ 109. GENERAL.—a. *References.*—TM 11-454 and FM 24-6, cover operating regulations. Special procedures may be prescribed for such purposes as artillery fire control, command nets of mechanized and armored units, command nets of air-

craft in flight, and control of forward units in combat. Examples of these special procedures are not included in this manual; they are usually brief, and are included with the codes used for the special purpose. Other technical manuals or instructions cover the operation of specific items of equipment. (See par. 4a, and app. II.)

b. Handling equipment.—Precautions for the transportation of equipment given in paragraph 243 also apply to radio equipment. When danger of capture exists, radio operators should be prepared to render the equipment, authenticator charts, and other net data useless to the enemy as prescribed in paragraph 14 or other instructions.

■ 110. PROCEDURE, PROCEDURE SIGNALS, AND PROCEDURE SIGNS.—

a. Definitions.—(1) Radio procedure is a standardized routine used by radio operators in the handling of traffic.

(2) Procedure signs are nonsecret, arbitrary signals which have been adopted to assist operators in handling traffic in the shortest possible time. Hereinafter the term procedure signs will be used to include the terms "procedure signs" and "procedure signals" defined in TM 11-454.

b. Importance of procedure.—Strict compliance with operating procedures prescribed in TM 11-454 and FM 24-6 or other special procedures insures the accurate and rapid handling of traffic with minimum transmissions. Every radio operator must have a thorough knowledge of the correct procedure to use in any particular instance. Deviations from authorized procedure usually results in delaying traffic and is prohibited.

■ 111. TRANSMITTING RULES.—*a.* An operator will listen on the transmitting frequency assigned his station before making any call or other transmission. If there are other stations working on the frequency he will not interrupt communication unless such interruption is warranted by the class of his traffic. (See TM 11-454.) All stations remain silent for a period of 15 seconds at the completion of each message transmitted, in order to permit any station in the net to send traffic of high precedence.

b. All transmissions must be as short and concise as possible. No superfluous calls or signals of any kind will be sent.

An operator may test his transmitting set before the first transmission by sending a few "Vs" followed by his own station call sign.

c. Messages and transmissions must be sent at a speed which will allow the receiving stations to copy them on the first transmission. Thus, no transmissions should be faster than the slowest operator in a net can receive them.

d. Particular care is necessary that all call signs are made slowly and distinctly.

e. The procedure sign for "Wait" is used when an immediate answer cannot be given.

f. Every message will be terminated with a suitable procedure sign.

■ 112. TRANSMISSIONS.—*a.* Radio stations will transmit only those messages authorized by competent authority. All transmissions and messages handled will be considered as official. (See par. 102*a.*)

b. In general, the need for inquiries, instructions, and information in connection with the handling of traffic is adequately met by the prescribed procedure signs. When procedure signs cannot be used a service message will be employed. The exchange of transmissions in other than authorized form is prohibited.

c. The chief operator or station chief of a station has full authority to authorize the transmission of messages relating to the signal service. Such messages will be signed with the call sign of the station of origin, and will be in an approved code.

d. Every operator will read through the text of each message filed to ascertain that each word or the individual letters of each code group are clear and unmistakable. If there is any doubt about any of the words or letters, he will have them verified.

■ 113. TIME ENTRIES AND THE RADIO DAY.—Unless otherwise specified by higher authority—

a. Time entries on the station records are made in the time of the zone in which the station is located. (See par. 28.)

b. Transmissions involving the specifying of time (time broadcasts, transmissions as to the time a station will call

another station or return to a net, etc.) likewise use the time of the zone in which the station is located.

c. The "radio day" is the 24-hour period covered by a complete set of station records. It commences at midnight of the time zone in which the station is located, and ends at the following midnight of the same zone. All station records of all stations in the net will be opened and closed in accordance with the above-mentioned rule.

■ 114. COOPERATION WITH MESSAGE CENTER.—The message center is the agency charged with the receipt, transmission, and delivery of messages, and with the encoding and decoding of messages when required. It is therefore the responsibility of radio station chiefs to keep the message center informed at all times of the stations actually operating in the net and of traffic conditions with reference to any delay time that might occur to messages routed by radio.

SECTION IV

STATION RECORDS

■ 115. OPERATOR'S NUMBER SHEET.—Stations that are required to use station-to-station serial numbers (see TM 11-454) will keep a record of the numbers in the following manner:

a. On completion of a period of transmission or reception, the key operator will record on the number sheet the number or numbers of the messages sent and the number or numbers of the messages received. The record is made by drawing a line through the numerals in the appropriate column assigned to the other station and entering the time of receipt and his personal sign in the blank space to the right of the last message number used during the period of transmission and reception.

b. The following example indicates a completed extract of a satisfactory number sheet for recording station-to-station serial numbers:

c. Any messages that cannot be sent without delay should be returned to the message center for routing by other means. Failure by radio station personnel to adhere strictly to directions of the message center or other traffic routing

SIGNAL COMMUNICATION

115-117

agencies that may be prescribed will result in serious delays in the delivery of messages and in much useless code work by the message center personnel.

■ 116. RECEPTION OF MESSAGES.—*a.* All received messages are copied at the radio station in duplicate. Messages are copied on the typewriter or by hand using the system of lettering described in paragraph 33. When copied by hand, the same number of code groups should be copied on each line. In using the typewriter, 5 or 10 code groups will constitute a line.

W. D., M. C.
Form 128-119601 Use

SIGNAL CORPS, UNITED STATES ARMY
OPERATOR'S NUMBER SHEET

Check off both sent and received numbers immediately and enter time and personal sigs. Numbers must be exchanged nightly at closing hour. Receiving and sending operators will be held responsible for correct records of numbers.

STATION 91G 4TH INF CIRCUIT OR NET R022d INF DIV DATE 10 AUG 41

B02		A4G		A02	
SENT	RECEIVED	SENT	RECEIVED	SENT	RECEIVED
X 0630-Q	X 0654-Q	X 0644-Q	1	X 0637-Q	X 1110-R
X 0750-Q	X 0704-Q		2	X 0735-Q	X 1140-R
	X 0715-Q		3		
			4		
			5		
X 0823-G	X 0900-G		6		
X 0900-G	X 0915-G		7		
	X 0925-G		8		
	X 1030-G		9		
			0		
	X 1135-R		1		
	X 1157-R		2		
			3		
			4		
			5		
			6		
			7		
			8		
			9		
			0		

7-116
FL-4057A

b. See paragraphs 40*a* and 47 for the disposition of the original and the duplicate copy of incoming messages. Delay of original copies of messages for recopying or extracting data for station records is prohibited.

c. See paragraphs 42 and 47 for the disposition of the original and the duplicate copy of relay messages.

■ 117. SERVICING OF MESSAGES.—*a.* Every message is serviced by the transmitting operator and the receiving operator upon the completion of its transmission (see TM 11-454). The transmission of a message requiring a receipt or a repeat

back is not considered complete until such receipt or repeat back is received by the transmitting operator.

b. A message must show the station to which it was sent or from which it was received. In any case where this information is absent from the heading of the message the operator's service will include it.

c. The sending operator's service is written in at the bottom of the message and circled. Many operators perform this service with one hand while operating the key with the other. (See par. 95m.)

■ 118. STATION LOG.—*a. General.*—(1) A station log in conjunction with the number sheet and the file of transmitted and received messages forms a complete record of events and operating conditions which occur during a radio day at a station.

(2) The amount of detail that should appear upon the log varies according to the number of operators on duty at the station, and the state of training of the operators, but the keeping of the log should not delay traffic.

(3) Signal and communication officers are authorized to prescribe the amount of detail that they require on the logs of their stations but the following essential elements with time entry for each will be included:

(a) Operators on duty.

(b) Opening and closing of stations.

(c) Causes of delays in traffic.

(d) Frequency adjustments and changes.

(e) Unusual occurrences such as procedure violations, verifications, etc.

(4) During the initial training phases the log should include all signals heard or transmitted, thus serving as a detailed check on operating procedures. As training progresses the amount of detail required can be gradually reduced to the essential elements listed in (3) above.

b. Form and example.—(1) *Training form.*—The following is a satisfactory station log form for use during the initial training period and for stations having a senior (key) and a junior (log) operator. A form of this kind is desirable when actual transmissions are to be logged in detail.

SIGNAL COMMUNICATION

118

STATION LOG			
Date	19.....	Net	Sheet No.
Station call	Net call	Station opened	M
.....	Senior operator	Junior operator
Time	To	From	Traffic
.....
.....
.....

(2) *Example of log.*—During the later training period and in actual field operations a combination form having the operator's number sheet printed on one side and a log printed on the reverse side is more satisfactory. The operator merely turns his number sheet over and makes the log entry on the back thereof as the events requiring a log entry occur. The following is an example including entries of such a form in common use at fixed stations. This form is printed on the reverse side of the operator's number sheet shown in paragraph 115b.

SIGNAL CORPS, UNITED STATES ARMY		
LOG		
Enter opening and closing time, frequency and frequency changes, traffic delays and any incidents or conditions affecting circuit efficiency.		
Station <u>3JG, 4TH INF</u>		Date <u>10 AUG 41</u>
TIME	OPERATOR	REMARKS
0600	Q-G	OPEN AT SELMA 4120 KC
0605		REPORT IN TO B02 (NGS)
		OUR SIGS ZSB4 AT B02
0608		AAG REPORTS IN NET
0613		A02 REPORTS IN NET
0800	G-Q	G TO KEY, Q TO GENERATOR
1100	R-Q	R RELIEVES G
1105	R-T	T RELIEVES Q
		IS TO 4100 KC BY ORDER B02
	QG	CLOSE STATION FOR MOVE

U. S. GOVERNMENT PRINTING OFFICE 7-128

TL-4056A

■ 119. **DISPOSITION.**—*a.* The station log, number sheets, and any other records connected with the operation of a station for a radio day will be placed together in a packet as soon as possible after the conclusion of such period and plainly marked with the date and a description of contents. These records will be disposed of as prescribed by the unit signal or communication officer.

b. Radio station records often contain valuable information for the enemy intelligence service. If at any time there is great danger of station records being captured by the enemy, they must be destroyed.

■ 120. **IMPORTANCE.**—*a.* Station records are valuable studies for signal and communication officers to use in determining errors made by operating personnel, causes of delays in traffic, and in determining the proper actions necessary for increasing traffic efficiency. They are also useful in the recovery of lost messages and as verification records.

b. The keeping of these records is secondary to the primary mission of delivering the message to the addressee without delay and exactly as written by the writer. Operators should be constantly reminded of their primary mission.

CHAPTER 6

VISUAL COMMUNICATION

	Paragraphs
SECTION I. General.....	121-122
II. Lamps.....	123-130
III. Flags.....	131-136
IV. Pyrotechnics.....	137-142
V. Panels.....	143-155
VI. Airplane maneuvers as signals.....	156

SECTION I

GENERAL

■ 121. SCOPE.—Visual communication includes all signals received by the eye regardless of how they may have been transmitted. While arm and hand signals are properly a part of visual communication, they are not included in this manual but are prescribed in other training publications. In this manual visual communication includes only communication by lamps, flags, pyrotechnics, panels and airplanes.

■ 122. CAPABILITIES AND EMPLOYMENT.—*a. General.*—In areas served by other signal communication equipment, visual communication is an auxiliary means supplementing wire and radio, but the necessary equipment issued for its use should always be at hand and in operative condition if, due to the failure of other means, the condition necessitating and favoring its employment should arise. It may be used to supplement one-way radio communication. For example, where a forward command group is able to receive messages by radio but not to transmit, the higher commander may direct that the reply be sent by means of visual communication. For small isolated groups or those which are not organically equipped with technical means of signal communication, the situation may sometimes be such that visual signaling with any means available is the only method possible. Its use depends upon the type of warfare, proximity of the enemy,

terrain, and weather. While the relatively slow speed of transmission renders visual signal communication less suited for transmitting long messages than other means usually available, it is well adapted to transmitting prearranged messages and code groups such as those used in the Air-Ground Liaison Code or the Division Field Code, using either groups of letters or numerals in brief messages over short distances. This type of visual signaling is especially applicable for use from front to rear, from ground to air, and from ground to a vehicle in motion. The success of visual communication depends upon training, previous preparation and distribution of codes, and prearranged messages. The degree of training which personnel require depends upon the purpose for which they will be employed. For short-range communication to extend tactical control below the forward limit of the more technical means, a very modest degree of training of a sufficient proportion of individuals to insure that at least one man with each group the size of the squad is trained will produce important results. The ability to transmit and receive groups of numerals can be acquired by a soldier of average intelligence in a short time.

b. Between ground stations.—(1) *Making contact.*—When a visual signaling system has been installed, or when for any other reason visual signals may be expected, all likely points from which such signals might originate should be examined frequently to see if visual signaling is being attempted. Attempts to attract attention of personnel with whom communication is desired must be persistent. The azimuths of all prepared stations with whom visual communication is expected should be recorded and stakes properly alined and tagged with the designation of the unit with which they are concerned placed in the ground to mark the line of sight to the other visual stations. For light portable equipment carried by forward groups or detachments, the distances involved will usually facilitate attracting attention through some prearranged sound or visual means. All personnel must be trained to be on the alert for such signals and to direct the attention of the proper personnel to them.

(2) *Limitations.*—If other effective means are available, visual communication should not be used when it is likely

to disclose a position or to draw fire on other troops. Where signals being sent are likely to be seen and read by the enemy, care must be taken not to disclose information which may enable the enemy to take countermeasures in view of the time factor involved. In general, the time factor favors more extensive use of nonsecret means between the smaller forward elements. Great care must be exercised in the selection of locations for visual signaling stations, especially those transmitting from rear to front. These considerations therefore frequently preclude two-way visual communication. When not in immediate contact with the enemy, visual stations may communicate in any direction but in immediate contact with the enemy, visual communication will generally be employed only from front to rear although two-way lateral communication may be employed if both stations are defiladed from hostile view.

(3) *Advantages.*—The advantages of visual communication between ground stations are—

(a) Rapidity with which stations can be installed.

(b) Speed with which short messages and prearranged signals may be sent.

(c) The light weight, simplicity, and portability of the equipment.

(d) Absence of need for metallic circuits between stations.

(e) Independence of intervening terrain or zones under hostile fire as compared to wire or messenger service, as long as mutually visible stations exist.

(4) *Disadvantages.*—Disadvantages of visual communication between ground stations as compared with wire and radio are—

(a) Slowness, hence poor adaptability for sending long messages.

(b) Dependence on mutual visibility.

(c) Difficulty of locating companion station, attracting its attention, and insuring receipt for traffic.

(d) The vigilance necessary by operators to avoid missing signals.

(e) Limited range.

c. *Air-ground communication.*—Visual communication from the ground to airplanes in flight is possible by use of

panels, pyrotechnics, flags, and signal lamps. The airplane may reply by radio, dropped message, pyrotechnics, lamps, or limited wing signals, all of which are covered elsewhere in this manual.

(1) *Advantages.*—The advantages of visual air-ground communication are the same as those listed in *b(3) (a)*, *(b)*, and *(c)* above.

(2) *Disadvantages.*—The disadvantages of visual air-ground communication are—

(a) Impracticability of sending long messages.

(b) Dependence on visibility.

(c) Air observer's difficulty locating stations desired.

(d) Ease with which hostile aircraft can locate ground stations.

SECTION II

LAMPS

■ 123. EQUIPMENT.—*a.* Signal lamp equipments EE-6, EE-6-A, EE-10-B, and EE-84 are authorized for specified field artillery and coast artillery units. Signal lamp equipment EE-80 is a portable searchlight 12 inches in diameter mounted on a tripod. It is normally placed in airdrome control towers and used for signaling to airplanes.

b. The EE-6 and EE-6-A are essentially the same, the difference being that the EE-6-A includes a belt with an attached case and a control box for carrying the eight dry batteries, spare bulbs, and key, while in the EE-6 these items are carried in one case rested on the ground during operation. Both consist of a portable electric lamp with a metal reflector 14 centimeters (about 5½ inches) in diameter, a sighting tube on the top, a hinged lid covering the front, and a two-wire cord to connect the batteries and lamp. Lamp signaling is accomplished by operating the key to cause short or long flashes of the lamp. These flashes combined make the characters of the International Morse Code. (Other lamp signals are described in par. 136.)

c. The EE-10-B uses either a 6-volt, a-c supply from a 110-volt step-down transformer or a 6-volt battery supply. It is heavier and more rugged than the EE-6 and has a

6-inch silvered glass reflector. Power supply, key, and controls are built into the lamp's wooden carrying case. A two-wire cord connects the lamp's power supply and key. A supporting stake is supplied with the EE-10-B.

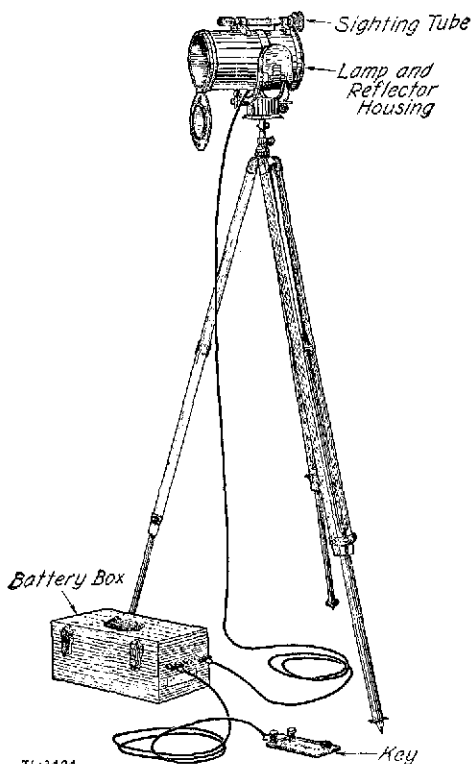

FIGURE 23.—Signal lamp EE-84.

d. The EE-84 uses a silvered glass reflector $4\frac{1}{2}$ inches in diameter and a prefocused 6-volt, automobile-type bulb (see fig. 23). On top of the lamp is a telescopic sight for directing the beam. The lamp is mounted on adjustable trunnions.

This assembly is mounted on a standard aiming circle tripod to permit laying the lamp from a map. A 5-foot, two-wire cord connects a metal box containing dry batteries and a relay to the lamp. The key is connected to this box by a longer two-wire cord and hence may be located some distance from the lamp.

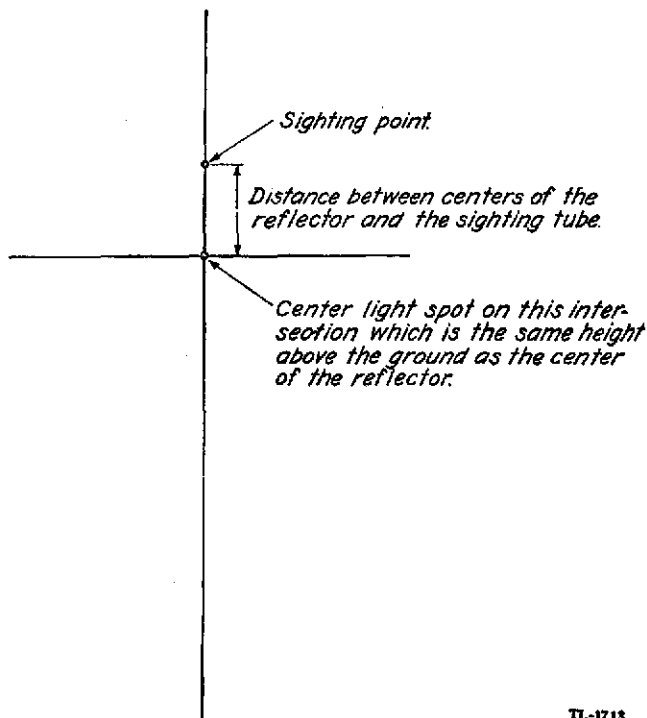

FIGURE 24.—Adjustment of signal lamp equipment EE-6.

■ 124. ADJUSTMENT.—The reflecting apparatus of all lamps should be checked for adjustment at frequent intervals and each time a bulb is replaced. To adjust the EE-6, draw horizontal and vertical lines on a flat vertical background

like a wall, intersecting at the height of the reflector above the ground (see fig. 24). Locate a sighting point on the vertical line a distance above this intersection equal to the distance between the centers of the reflector and the sighting tube. Set up the lamp a few yards away and aim the sighting tube at the sighting point. Turn the reflector screws supporting until the concentrated light spot becomes centered on the horizontal and vertical lines. A similar procedure may be followed in adjusting other lamps. When properly adjusted, the lamp projects a beam of approximately parallel light rays. Accuracy in this adjustment restricts the area in which signals may be observed and increases the range.

■ 125. CARE.—The following precautions are necessary in handling and operating lamps:

- a. The lid should be closed when the lamp is not in use.
- b. The reflector should not be touched with the fingers, and should be cleaned only with clean gauze or cotton dampened with clean water or alcohol.
- c. Cord connections should be kept clean and tight.
- d. The lamp should not be used for illumination.

■ 126. TRAINING.—Lamp operators should be qualified in the following:

- a. International Morse Code. (See app. III.)
- b. Lamp procedure, lamp sighting and adjusting.
- c. Use of field glasses, compass, and map reading.
- d. Distance limitations of the lamp.
- e. Establishment, operation, and maintenance of visual stations.
- f. Fire-control Code.

■ 127. INSTALLATION.—*a. Location.*—Under favorable conditions the EE-6 has a range of 3,300 yards in daylight or 6,000 yards at night. (See *b* below.) The ranges of other types are greater. Ordinarily the white bulb is used. The red bulb is preferable in operating through smoke or fog. Shadows, reflections, and background affect the visibility of the beam. In daylight place the lamp in a deep shadow. Sunlight falling on the face of the lamp produces a reflector glare making

signals unreadable. It is essential that the lamp be accurately sighted on the receiving station. Slight movements of the lamp divert the beam and the signal becomes faint or invisible. Therefore, some form of fixed mounting must be used.

b. Improvisations.—(1) Stability may be obtained by fixing the lamp to a tripod like that issued for use with the prismatic compass or commercial cameras. A stake driven in the ground may be used. Operation may be improved by providing a battery box for the batteries and spare lamp bulbs, and mounting a telegraph key on a removable cover. When operating many lamps at night in the same general area, it is desirable to use colored bulbs.

(2) In permanent and semipermanent stations, lamps may be oriented and fixed in position. Beam diffusion, increasing the possibility that signals may be read by the enemy, may be minimized by using a wooden tube 6 to 9 feet long, approximately the size of the lamp at the inner end and tapered slightly to a smaller size at the outer end.

■ 128. INTERNATIONAL MORSE CODE.—The alphabet, numerals, and special signs transmitted in International Morse Code are shown in appendix III.

■ 129. MESSAGE TRANSMISSION.—*a.* The speed of sending dots and dashes should be constant. Speed of transmission is increased by decreasing the intervals between successive dots and dashes, then letters, and finally, words.

(1) A dot is a short flash of about $\frac{1}{2}$ second.

(2) A dash is a long flash of about $1\frac{1}{2}$ seconds.

(3) The maximum interval between successive dots and dashes should be about $\frac{1}{2}$ second.

(4) The maximum interval between successive letters or characters should be about $1\frac{1}{2}$ seconds.

(5) The maximum interval between successive words should be about 3 seconds unless it is necessary for the receiving station to acknowledge by one or two dots after each word, in which case the transmission is resumed immediately upon receipt of such acknowledgment. (See par. 130.)

b. In order that lamp signals may be easily read it is essential that they be sent slowly. Experienced operators should

be able to transmit and receive at a rate of better than 10 words of 5 characters each per minute. Two men for each shift are required to operate a lamp station. In transmitting, one man operates the lamp and watches the receiving station while the other dictates the message to be sent letter by letter. In receiving, one man receives the message and calls it off letter by letter to the other who records it. The receiving operator also acknowledges when acknowledgment is necessary.

c. To establish communication the call sign of the called station is sent several times, and at intervals the station sends its own call sign. If two-way visual communication is authorized under the existing conditions, the called station answers immediately in a similar manner by lamp. In case two-way communication is not authorized, the called station answers by pyrotechnic signals or some means other than by flag or lamp.

d. A message consists of the following:

(1) The call, which consists of the call sign of the called station; the letter V, meaning "from"; and the call sign of the calling station, except as permitted in *c* above and paragraph 130b(3).

(2) The body of the message, without address, followed by the appropriate ending sign, \overline{AR} , \overline{K} , or \overline{VA} .

■ 130. PROCEDURE.—*a. Call signs.*—With modifications, radio procedure is used in the operation of lamps. Call signs are prescribed in signal operation instructions and will normally be the same as the radio call signs of the units. (See par. 31 and example in par. 265*l*.) For small units having no radio equipment, visual call signs are assigned by the next higher unit commander. These will be used only when required to establish communication or to attract the attention of the called station.

b. Special signs.—The following special signals and meanings are used in lamp operation:

(1) One dot—Last word received.

(2) Two dots—Repeat last word.

(3) A series of about eight dots—From transmitting station: Error. From receiving station: I must interrupt. The

series of dots may also be used by the calling station in place of a call to attract the attention of the called station after communication has been established.

(4) RL—Resight your lamp, signals are dim.

(5) A series of dashes of increasing length—Your adjustment is improving.

(6) A very long dash or steady light—Your adjustment is satisfactory.

(7) A series of dashes of decreasing length—Your adjustment is becoming worse.

(8) R—Entire message received.

(9) MU—Move up.

(10) MD—Move down.

(11) MR—Move right.

(12) ML—Move left.

c. Acknowledgment.—Every message which has been received will be acknowledged by some means even though difficult. In general, lamps will be used only from front to rear, and the acknowledgment in such cases will be made from the rear station by pyrotechnics or some means other than lamp or flag, if such use would divulge the location of the rear station to the enemy. This is important since rear stations are normally located at or near command or observation posts, and this intelligence may draw artillery fire. Situations will occur, particularly within the infantry and field artillery battalion during open warfare, when two-way lamp signaling is feasible without enemy observation. Then acknowledgment may be made by lamp. If the letter F precedes the transmission, the receiving station acknowledges the receipt of the message by some means other than flag or lamp. Otherwise the receiving station may acknowledge each word with either one dot or two dots, depending upon whether the word was understood or not.

SECTION III

FLAGS

■ 131. GENERAL.—Suitable flag equipment is issued for signaling by semaphore and wigwag, and for special purposes.

If no standard equipment is available, strips of cloth tied toward the outer end of sticks of wood or bayonets will serve for flags. For short ranges, when the use of flags would be unduly conspicuous, the hands or arms, or the headdress or handkerchiefs held in the hand may be used.

■ 132. CARE.—Signal flags should be kept in a clean, serviceable condition. A clean flag can be more easily read.

■ 133. TRAINING.—The steps to be followed in training of flagmen are in general identical to those given in paragraph 126 for the training of lamp operators. The semaphore flagmen use the semaphore code. (See fig. 25.) A proficient semaphore flagman should be able to transmit and receive at the rate of 125 characters per minute at medium ranges. Flagmen are trained to transmit in the kneeling, sitting, or prone position. Wigwag signalers, which include those equipped with sets consisting of a single flag and staff, use the International Morse Code (see app. III).

■ 134. Use.—*a.* Flag signal ranges vary with the location of the stations, visibility, and the proficiency of the flagmen. Under favorable conditions and with the aid of field glasses, semaphore flags can be read up to 2,500 yards.

b. The background should be the same for all positions of the flags during the transmission of a message. The flag color should contrast with the color of the background.

c. When a station is moved to get a better background, the flagman at each station holds his flag vertically above his head. The station requesting the move lowers its flag immediately when the flagman of the moving station arrives at a position having a suitable background.

d. When signal flags are used under hostile small arms fire, distances will be short and effective ranges will depend on cover for the flagmen. The rear station will permit the forward station to select the most advantageous position and the rear station conforms.

■ 135. SEMAPHORE FLAG PROCEDURE AND TRANSMISSION.—*a.* The semaphore code is given in figure 25. The "end of message" signal (chop-chop) is executed by waving both flags in short vertical opposite directional arcs on the left side of the body.

b. The semaphore flag signaling call to one station consists of the signal "attention." Otherwise, the call is that given for lamps in paragraph 129. The special signals and meanings used in semaphore flag signaling are shown in figure 25.

■ 136. WIGWAG PROCEDURE AND TRANSMISSION.—a. For general use in lower units wigwag signaling is more applicable than semaphore as transmission is possible with improvised equipment and does not require an operator to expose himself by standing. Since wigwag flags, radios, telegraphs, and signal lamps employ the International Morse Code (app. III), training is facilitated. It is especially suited to transmission of code groups consisting of numerals, which are provided in certain codes. In the absence of suitable codes, prearranged numerals may be substituted. Training must include the transmission and reception of wigwag signals in the kneeling and prone positions as well as standing.

b. A dot is made by a motion from overhead downward to the sender's right, through an arc of 90° in the plane perpendicular to the line of transmission, and returning immediately to the starting point overhead. A dash is made by a similar motion to the sender's left. A short pause in the vertical position indicates spacing between the individual characters. The end of a word or group is indicated by dipping the flag to the operator's front; the end of a message is indicated by two such motions.

c. A hand lamp may be substituted for the flag. When using a hand lamp, the swing may be upward from a starting point with the arm hanging down naturally, instead of downward from a starting point overhead.

d. The procedure prescribed in paragraph 130 shall be followed except that the ATTENTION sign, made by waving the flag through 180° overhead several times, or by waving the lantern through 180° across the knees, may be used in calling; and that the ANSWERING sign may be used in answering a call as well as in "receiving" an item transmitted. If an answering signal is not received, and if the message is urgent, the operator transmits the message several times until he is reasonably sure that the message has been received.

e. For communication with aircraft, the wigwag operator faces the airplane continuously while transmitting, turning

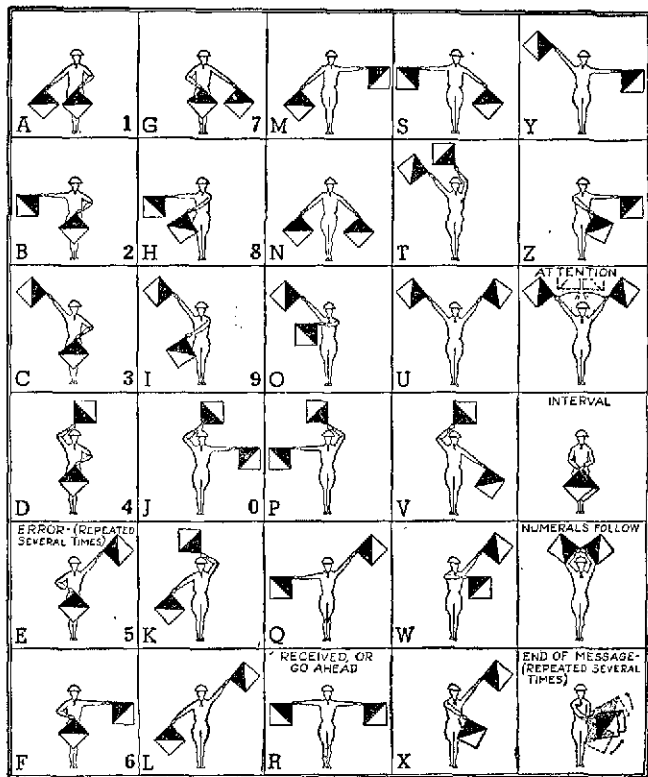

FIGURE 25.—Semaphore code.

his body for such purposes. Such messages may be transmitted in the clear under proper conditions, or groups of letters or numerals prescribed in the air-ground liaison code may be used. For low-flying aircraft this means is sometimes faster and more practical than a series of signals by panels. Under exceptional conditions the wigwag method of transmission may be employed by persons in a slow-flying aircraft or in a moving vehicle.

SECTION IV

PYROTECHNICS

■ **137 EQUIPMENT.**—Pyrotechnic devices used for signal communication are the ground signal projector, the pyrotechnic pistol, aircraft, and the Very pistol.

a. Ground signal projectors.—There are three types of ground signal projectors. In all types the barrel is about 12 inches long and has a 42-mm bore.

(1) In projector M1 a firing pin is centered in the bottom or breech end of the tube and is actuated by a simple, springless hammer and lanyard. For firing, this projector is mounted on the muzzle of the service rifle or on a steel supporting tube, about 4 feet long, with a flange and sharp pin at one end to be pushed into the ground. (See fig. 26②.) The signal cartridge resembles a large shotgun shell without the flanged base. It is dropped into the muzzle, base first, and then fired by a quick jerk on the lanyard. After each discharge, the projector must be inverted to dislodge the cartridge base. The cartridge contains varying types of signals, which are projected about 300 feet upon being fired. (See fig. 26⑦.)

(2) The projector M3 (fig. 26③) has a fixed firing pin in the bottom or breech of the bore. This type fires the same ammunition as the first type projector. The signal cartridge is dropped into the muzzle, base first, and allowed to slide down the tube until it is stopped just above the firing pin by a spring arrester. To fire the cartridge the operator assumes the prone position, the tube being held muzzle up at arm's length a few inches from the ground; then the breech end is struck smartly against the ground. The inertia of the cartridge causes it to pass the arrester and strike against the firing pin, thus igniting the propelling charge. After discharge, the projector must be inverted to dislodge the cartridge base. (See fig. 26⑦.)

(3) The projector M4 is a modification of the M3 and differs very slightly in mechanical construction or physical appearance. (See fig. 26④.) It is fired in the same manner as the M3 and uses the same ammunition.

b. Pyrotechnic pistol.—The pyrotechnic pistol, aircraft type, is for use in airplanes. It consists of a heavy frame

or receiver only, the cartridge serving as the barrel through which the signal is fired. The cartridge is about $1\frac{1}{2}$ inches in diameter and contains either a star cluster or a star blinker signal of various colors. (See par. 141a.) The cartridge is inserted into the receiver of the pistol and the pistol held

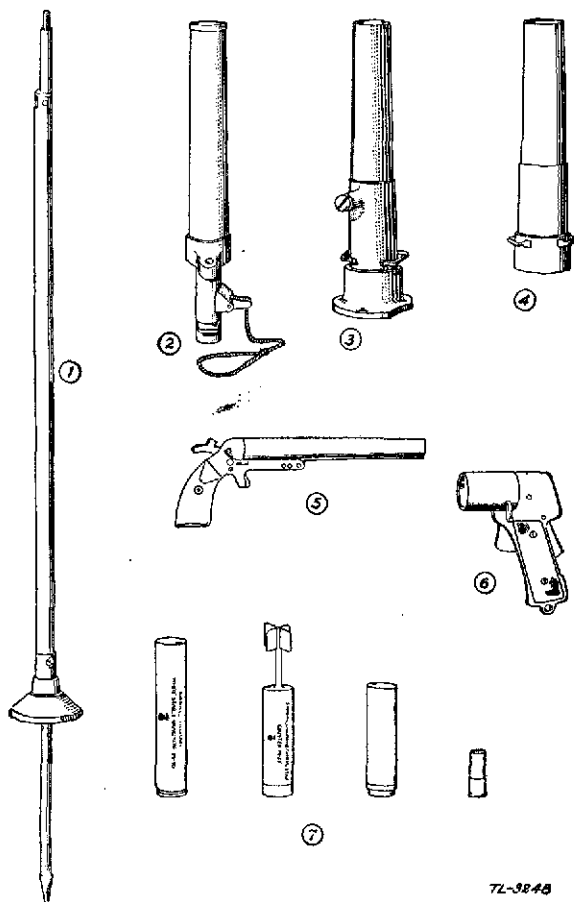

FIGURE 28.—Pyrotechnic projectors.

7L-3848

outside of the airplane and fired. After firing, or in case of a misfire, the cartridge is ejected from the pistol. The pistol may be held in one hand and fired, but due to the severe recoil, both hands should be used. (See fig. 26⑥.)

c. Very pistol.—The Very pistol is a single-shot 10-gage pistol with a 9-inch steel barrel and a bronze frame. The barrel is hinged to the frame by a pin, and breaks open for loading and extracting the cartridge. The Very pistol cartridge is similar in appearance to a 10-gage shotgun shell and contains either a red, white, or green single star signal without a parachute. Upon being fired the signal is projected about 200 feet and burns from 6 to 8 seconds. (See fig. 26⑥.)

■ 138. CARE.—*a.* Pyrotechnics must not be mixed with ammunition or other fireworks. Those giving red or green light are loaded with compositions which may explode under certain conditions and hence should be stored separately if feasible. The storage of small quantities of pyrotechnics in the same building with small arms ammunition is authorized.

b. All cartridges for the above devices are discharged by percussion; hence boxes of these cartridges should be placed flat with top side up and protected from moisture. Pyrotechnics in storage should be placed by lots of approximately the same date of manufacture and the oldest lots issued first. Those whose serviceability is uncertain will be tested.

■ 139. USE.—*a.* Pyrotechnic devices are used for sending pre-arranged messages requiring immediate action or when other means of signal communication are uncertain or too slow.

b. In order to insure transmission through fog, dust, and smoke, it may be necessary to establish a chain of stations to relay pyrotechnic signals.

c. Some of the principal uses of pyrotechnic signals are—

(1) To cause artillery fire to commence, cease, or lift.

(2) To indicate the arrival of certain front-line units on certain points on the terrain.

(3) To acknowledge receipt of lamp or flag transmissions by a visual station which is not permitted to use lamps or flags.

(4) To call for a display of markings or identification panels.

- (5) Identification of friendly aircraft.
- (6) Identification of friendly armored vehicles and units.
- (7) Intercommunication of armored vehicles and units.

■ 140. TRAINING.—The steps to be followed in the training of pyrotechnic signalmen are—

- a. Care and handling of pyrotechnics.
- b. Firing and reading of pyrotechnic signals.
- c. Employment and tactical use of pyrotechnic signals.
- d. Instruction in map reading and use of the compass.
- e. Establishment, operation, and maintenance of pyrotechnic signaling stations under assumed tactical situations.

■ 141. SIGNALS.—The standard pyrotechnic signals are as follows:

a. *For use from aircraft:*

- (1) Signal, aircraft, red star parachute, M11.
- (2) Signal, aircraft, red star parachute, cluster, M14.
- (3) Signal, aircraft, white star blinker, M15.
- (4) Signal, aircraft, green star blinker, M16.
- (5) Signal, aircraft, white star parachute, M10.

b. *For use from ground:*

- (1) Signal, ground, white star parachute, M17.
- (2) Signal, ground, white star cluster, M18.
- (3) Signal, ground, green star parachute, M19.
- (4) Signal, ground, green star cluster, M20.
- (5) Signal, ground, amber star parachute, M21.
- (6) Signal, ground, amber star cluster, M22.
- (7) Signal, ground, white star parachute, M5.
- (8) Signal, light, Mk. 2, Very, white.
- (9) Signal, light, Mk. 2, Very, red.
- (10) Signal, light, Mk. 2, Very, green.

■ 142. MESSAGE TRANSMISSION.—a. Meanings are assigned pyrotechnic signals in signal operation instructions and should be changed frequently for secrecy. The names given in paragraph 141 are catalog listings and will be used in the signal operation instructions prescribing their meanings. (See example, par. 265k.) Since the number of distinct signals is extremely limited and the use of pyrotechnic signals is largely confined to the front lines, the meanings assigned should invariably be those most important to front-line units at the

time. Pyrotechnic signals, particularly Very signals, are extremely difficult to see in bright sunlight. They should not be used to control important operations unless no other means is available.

b. Observing the following precautions will avoid misuse of pyrotechnics:

- (1) Signals should be distinct from one another.
- (2) The most readily discernible signal should be assigned the most important meaning.
- (3) Promulgation and distribution of signal operation instructions pertaining to pyrotechnics must be timely.
- (4) Each unit commander should designate an officer to be responsible for the use of pyrotechnics by that unit.
- (5) Lookouts, and when necessary, relay stations for the repetitions of signals should be provided.

SECTION V

PANELS

■ 143. EQUIPMENT.—Several types of panels and panel sets are issued to ground troops. Panels AL-119 and AL-120 issued to the Infantry are 1½-foot squares, the former in white and the latter in black, furnished with grommets and 4 metal pins for staking down the corners. The following arms are issued panel sets AP-30-C and AP-30-D: Infantry, Field Artillery, Coast Artillery Corps, Armored Force, and Signal Corps. The Cavalry is issued the AP-30-D only. The panel set AP-30-C consists of a case CS-18 of canvas for carrying panels and 13 panels AL-122 of black cotton fabric, measuring 12 feet in length and 2 feet 4 inches in width, each panel being provided with grommets and 14 metal pins for staking it to the ground. The panel set AP-30-D is similar except the 13 panels AL-121 taking the place of the panels AL-122 are white. Specified coast artillery units are issued panel sets AP-33-A and AP-34-A. Panel set AP-33-A consists of 13 panels AL-124 of tangerine colored cotton fabric, measuring 30 feet in length and 6 feet in width, with a wooden roller on one end. Panel set AP-34-A is similar except the 13 panels AL-125 taking the place of the panels AL-124 are white.

■ 144. CARE.—Panels should be examined each time they are used and any rents or loose grommets promptly repaired. Soiled panels should be washed clean and thoroughly dried. Wet or damp panels should be dried at the first opportunity, to prevent mildew. Panels should be kept in their carrying case when not in use.

■ 145. PURPOSE.—*a.* The AL-119 and AL-120 are marking panels and are displayed by troops in combat on signal from the infantry liaison airplane in order that an airplane may report their progress and location to higher headquarters. The panels AL-120 (black) are used when snow covers the ground, but the panels AL-119 (white) are normally used. These panels are issued to a rifle squad and should be used for no other purpose than that for which issued.

b. The AP-30-C, AP-30-D, AP-33-A, and AP-34-A are issued for communication with aircraft and for the location and identification of unit command posts on request by aircraft. The AP-33-A and AP-34-A are especially designed for communication with high-flying aircraft.

■ 146. DISPLAY GROUNDS.—Panel display grounds are located near the radio station since the radio operators are normally also the panel operators. The panel display ground should be a fairly level open space free from rocks, high weeds, and brush, removed from high trees and bodies of water. It should be defiladed from hostile ground observation but so located that the panels can be seen by airplanes at wide angles from the vertical. The panels should be displayed in the best light available and so placed that shadows will not fall across them blurring their outlines to the air observer. Care must be exercised to see that panels are displayed only to friendly aircraft who have identified themselves as such by use of a prearranged signal. Upon the approach of hostile aircraft, the panels should be taken up or concealed.

■ 147. NUMERALS.—*a.* The three-numeral code groups in the Air-Ground Liaison Code are intended for use with panels. To indicate these numerals the panels are laid out as shown in figure 27.

b. An index group composed of two panels laid out about 12 feet apart in line is always placed at the top to indicate

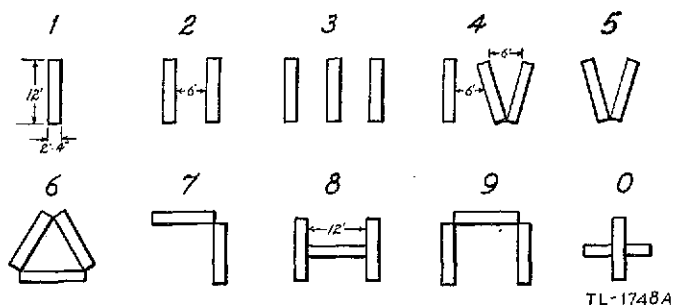

FIGURE 27.—Panel numerals.

to the observer the sequence in which the panel numerals are to be read. Except as indicated in figures 30, 31, and 32, the index group remains in place throughout communication. The three-numeral code group is placed below the index group as shown in figure 28.

■ 148. IDENTIFICATION GROUP.—Each military unit equipped with panels may identify itself to a friendly questioning airplane or to the airplane assigned to work with it by laying

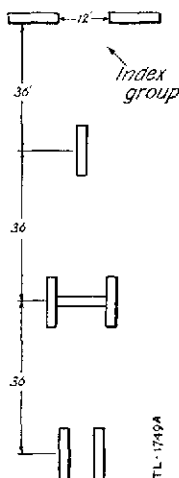

FIGURE 28.—Example of a code group, 182.

out panel numerals forming a number called an identification group, arbitrarily assigned the unit in signal operation instructions. The identification group may consist of one, two, or three numerals. These identification groups have no relation in any way to the actual numerical designation of the unit. For an example, see paragraph 265*h*.

■ 149. DISPLAYING THE IDENTIFICATION GROUP.—*a*. The identification group is displayed when the airplane gives a pre-arranged signal meaning "display identification group." In order to indicate that an identification group is being displayed and not a code group, a special signal or indicator for an identification group is laid out simultaneously with the numerals. This consists of a single panel placed about 12 feet above the index group and at right angles to it.

b. If the 4th Field Artillery Battalion were assigned 102 as its identification group, this unit would identify itself by displaying panels as shown in figure 29.

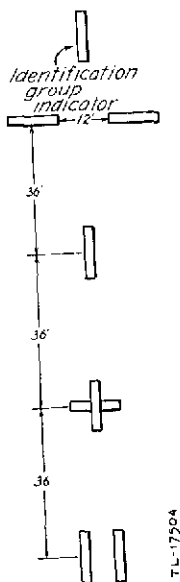

FIGURE 29.—Example of an identification group, 102.

c. When the identification group consists of less than three numerals, it is preceded by one or two zeros, as may be necessary, in order to make a three-numeral group. For example, the identification group 8 would be displayed as the number 008.

■ 150. TECHNIQUE OF PANEL DISPLAY.—*a. General.*—No hard and fast rules governing the space that must be left between the panels composing any signal can be laid down. The distance between all panels should be dictated by local conditions as to visibility, space available, height of the airplane, and the terrain. Under average conditions, the display of the numeral panels and the special signals should conform to the form and relative distances indicated in the examples shown in this manual and in the Air-Ground Liaison Code.

b. Preparation.—When two or more operators are available for laying out the panels, the work should be divided up by specific assignment of duties. Special circumstances and good judgment will dictate the best possible division of labor. Constant practice will result in developing a highly efficient panel detail capable of operating with maximum speed and minimum interference or confusion. Panel operators when preparing to display panels will, according to the number of operators available, post themselves in such positions as will facilitate laying out, changing, and taking up panels with the greatest possible speed and precision. When the display of any signal has been completed, operators move away from the panels rapidly and take up such positions that they will not obscure the signal from observation or cast shadows upon any part of it. The signal remains displayed until the airplane's acknowledgment has been received, whereupon all panels not in the initial display will always be removed before a new display is made.

c. Beginning.—In order to commence working with the airplane, an initial display consisting of the unit's identification group is displayed. This means "I am ready to work." (See par. 149.) In the event that the identification group is not displayed, the initial display will be the number "000" under the index group. This also means "I am ready to work."

d. Continuation.—In order to avoid misunderstandings, ambiguities, and delays, the noncommissioned officer or the senior operator in charge of the panel detailed calls out loudly, in separate numerals, the signal to be displayed, for example, "ZERO ZERO THREE" or "THREE FOUR FIVE." Much time will be saved if the next signal is announced while the preceding signal is being displayed and the airplane's acknowledgment is being awaited. By so doing, such operator can fix in mind beforehand his exact movements in the next display. When this procedure is followed, the announcement regarding the signal to be displayed is preceded by the phrase, "The next signal will be—." The operators then await the command GO before proceeding to execute the order.

■ 151. REPORTING.—*a.* An airplane requests the ground station to identify itself by radio, pyrotechnics, or lamp signals and other ways all indicated in current signal operation instructions.

b. The ground station answers by displaying its identification group. If not previously arranged for, the ground station will also indicate by panels the joint communication method desired. The communication method may be changed during a mission by displaying the proper panels or by sending the necessary signals. Some of these methods are described in paragraphs below.

c. The airplane acknowledges by signals which have been prearranged or ordered.

■ 152. BETWEEN AIRPLANE RADIO AND GROUND STATION HAVING RADIO RECEIVER ONLY.—*a.* The airplane acknowledges receipt of each panel display by sending R, if telegraph, or ROGER or WILCO, if voice.

b. If the airplane sends the first message, the ground station acknowledges by displaying the signal 009 meaning "Received", followed immediately by the next panel signal.

c. When the last panel signal of a message has been displayed and its receipt has been acknowledged by the airplane, the ground station displays the panels meaning "More to follow" or those meaning "Finish." The latter panels are displayed only when the ground station desires the airplane to proceed on the mission.

d. If the ground station displays the panels meaning "More to follow" only, the airplane acknowledges by sending R, but if it displays the panels meaning "Finish", the airplane acknowledges by sending R \overline{VA} and proceeds on the mission.

e. The airplane reports back from the mission by dropped message or by other previously arranged means.

f. The ground station acknowledges as in *b* above, followed by the panels meaning "More to follow" if it is desired that the airplane remain in the vicinity, or by the panels meaning "Finish" if it is desired that the airplane carry on with its reconnaissance, etc.

g. The airplane acknowledges as in *d* above.

■ 153. LAMPS, DROPPED MESSAGES, AND PANELS.—*a.* When radio communication is impossible, suspended, or undesirable, the normal method of intercommunication between airplane and ground station is by panels and dropped messages (see ch. 3, sec. IV). If previously arranged for, the airplane may use the lamp and the ground station may use panels, in which case the procedure used is the same as that indicated in paragraph 130.

b. The normal communication method between airplanes and outlying detachments is by dropped messages and panels and, if possible, picked-up messages. (See ch. 3.)

■ 154. INDICATING COMPLETION OF WORK.—*a.* Except for urgent reasons, observers will not leave a mission before the signal meaning "Go home" is received, and then only after sending the signal meaning "Request relief" three times, the last of which will ordinarily be by means of a dropped message. If, after sending "Request relief" three times, the operator receives no signal meaning "Go home", the observer will go home.

b. Only the highest headquarters of the force to which the airplane is assigned will authorize the signal meaning "Go home." All subordinate units will habitually send the signal meaning "No further need of you" when they are through with the airplane, upon receipt of which the airplane will report back to the highest headquarters of the force to which it is assigned. Only when specifically directed or authorized to do

so by the highest headquarters concerned may a subordinate unit send the signal meaning "Go home."

■ 155. SPECIAL PANEL SIGNALS. *a.*—Figures 30, 31, and 32 show several special signals. The display in figure 31① means "487" and *not* the equivalent of code group 487. If in the display of figure 31② panels for 000 were shown instead of those for 895, the meaning would be "Verify and repeat coordinates." The display in figure 32③ is followed immediately by the display of figure 30③.

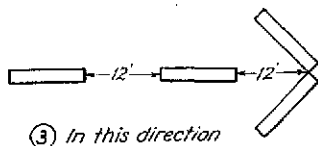
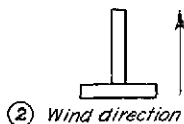
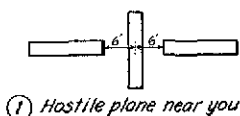

TL-1751A

Figure 30.—Special panel signals.

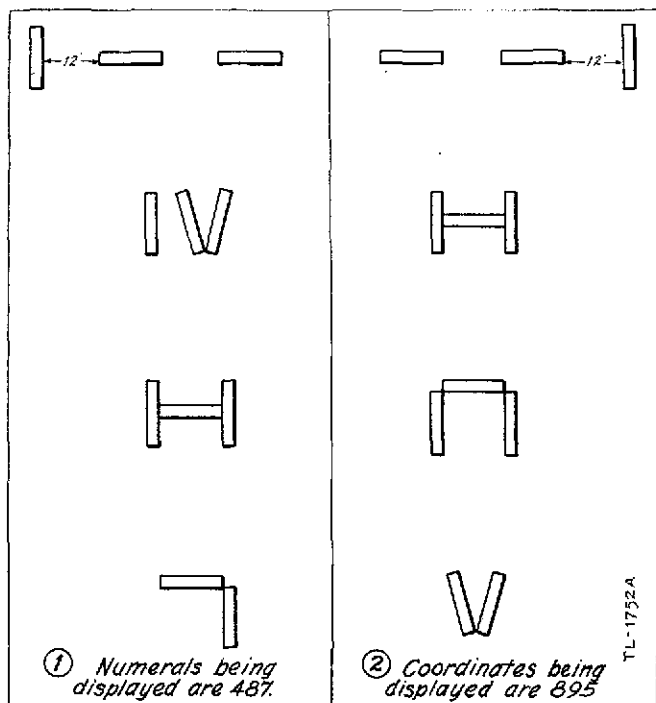

Figure 31.—Special panel signals.

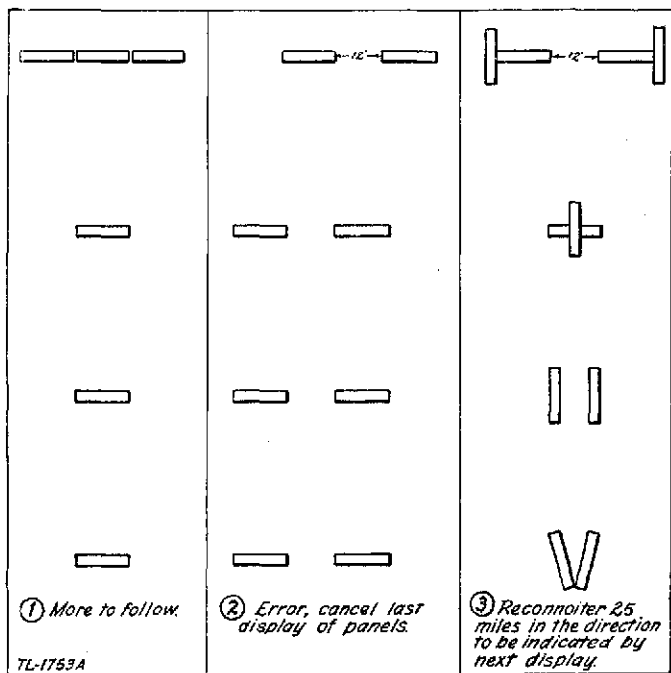

Figure 32.—Special panel signals.

155-156

BASIC FIELD MANUAL

b. Improvised panels, constructed for quick attachment and removal, may be used to identify vehicles in a column. If so, standard signals for this purpose are:

March message center-----



Message for airplane pick-up-----

(When this signal is displayed, observer will drop a message giving location of landing field he will use for pick-up.)



Leading vehicle of column...



Last vehicle of column-----

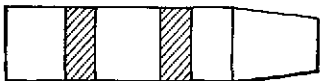

TL-3155

SECTION VI

AIRPLANE MANEUVERS AS SIGNALS

■ 156. PURPOSE AND GENERAL USE.—In an emergency, when a ground station is not equipped for radio reception or when the radio transmitter of an airplane is silenced or out of com-

mission, an airplane may communicate to a limited degree with a ground panel station by means of various maneuvers of the airplane while in flight. Such signals are limited to a very small number. No standard code has been developed for this means of communication but any code used should be practical of performance by the airplane used and preferably be prescribed in signal operation instructions. Individual units have devised such codes by prearrangement with observation aviation units designated to operate with them. Adjustment of the fire of field artillery batteries using only panel signals and airplane wing signals is both rapid and often practicable.

CHAPTER 7

COMMUNICATION BY SOUND

■ 157. DEFINITION.—The transmission of messages by audible sounds produced by mechanical or acoustical devices, excluding speech, and their direct reception by ear is defined as sound communication.

■ 158. SOUND PRODUCING DEVICES.—Such common sound-producing devices as whistles, bugles, horns, sirens, and rattles, and the sounds produced by small arms, artillery, and motors of airplanes in flight are frequently used for signaling. The bugle is often used to transmit prearranged messages, and the other devices mentioned have also been used in many operations. Except as indicated in paragraph 159, the use of any sound producing device for this purpose may be prescribed by a commander.

■ 159. PREARRANGED MESSAGES REPRESENTED BY SOUNDS.—*a.* Orders, information, and other prearranged messages represented by bugle sounds are prescribed in TM 20-250.

b. Prearranged messages represented by whistle sounds are prescribed in other training publications.

c. The signals from sound-producing devices issued for use as gas or air attack alarms are prescribed in War Department Training Circulars, and the devices will not be used for any other purpose.

d. The following meanings are understood:

<i>Signal</i>	<i>Meaning</i>
3 long blasts of a whistle, motor horn, siren or klaxon repeated several times; or three equally spaced shots with rifles or pistol; or three short bursts of fire from machine gun or submachine gun.*	Air or mechanized attack.
Percussion sounds, such as those produced by bells, triangles, iron ralls, and empty cartridge cases, struck rapidly and continuously.	Gas alarm.

* In daylight, the individual giving the signal points in the direction of the impending danger; at night the alarm signal will be supplemented by voice warning to indicate the direction of danger.

e. If messages have not been prescribed by higher echelons for the sound produced by any sound-producing device, commanders authorizing the use of the device will also prescribe the prearranged messages pertaining thereto in signal operation instructions. They may also repeat therein the signals from sound-producing devices prescribed by higher authority, and the prearranged messages corresponding thereto.

■ 160. EMPLOYMENT.—The chief value of communication by sound is the resulting economy of time, personnel, and equipment when utilized for alarms, for attracting attention, and for the transmission of short prearranged messages. As a measure of signal security, particularly when enemy forces are present, the employment of sound communication should be strictly regulated by commanders.

CHAPTER 8

WIRE COMMUNICATION

	Paragraphs
SECTION I. General.....	161-182
II. Field wire line construction.....	183-208
III. Field telephones and centrals.....	209-226
IV. Field telegraph sets and stations.....	227-233
V. Maintenance of field wire systems.....	234-243

SECTION I

GENERAL

■ 161. **PURPOSE AND SCOPE.**—The purpose of this chapter is to establish standard practice in the installation, maintenance, and operation of the field wire systems of tactical units. This standardization is necessary to insure efficient wire communication. The individual duties assigned to the wire personnel of units are specifically explained in the training publications pertaining to the different arms. Complete technical information pertaining to particular items of wire communication equipment may be found in references listed in appropriate paragraphs.

■ 162. **DEFINITIONS.**—The following terms used in this chapter are peculiar to wire communication. These terms are defined in the sense in which they are used herein. For definitions of general terms see paragraph 5, and for definitions of those pertaining to other means of signal communication, see pertinent chapters.

a. Common battery.—A term used to describe a telephone system which has current supplied to it from a central source.

b. Construction center.—A central point other than a switchboard from which wire crews may be controlled.

c. Field telephone.—A portable telephone designed for field use.

d. Field telephone switchboard.—A portable telephone switchboard designed for field use.

e. Gaff.—A spur on the inside of pole climbers which engages in the pole.

f. Local battery.—A term used to describe a telephone system in which current is supplied for talking at each telephone, usually from a dry battery contained in the telephone.

g. Magneto.—A hand-operated generator of alternating current utilized to operate telephone ringers and switchboard line indicators. Local battery telephones use a magneto for signaling, hence are sometimes referred to as magneto telephones.

h. Marline.—A small, loosely twisted twine of two strands used for tying field wire to a support.

i. Monocord switchboard.—A field telephone switchboard in which each line terminates in a single jack and plug.

j. Repeating coil.—A transformer of approximately unity ratio used to superimpose additional circuits on field wire lines. (See par. 215.)

k. Seizing wire.—Soft-drawn copper wire, used to improve field wire splices mechanically and electrically.

l. Sidetone.—The audible sound produced in a telephone receiver when the transmitter of the same telephone set is actuated by sound waves produced by speaking or blowing into the mouthpiece.

m. Skinning.—The process of removing insulation from wire.

n. Staggering.—The offsetting of splices in the two conductors of twisted pair wire so as to prevent bulkiness and short circuits.

o. Switching central.—The facility employing a telephone switchboard to interconnect telephones served and to connect telephones to trunk lines which terminate at another switching central.

p. Terminals.—Contacts or binding posts conveniently arranged for connecting equipment or circuits.

q. Test station.—An installation of one or more terminal strips cut in on a long trunk or local circuit for test purposes. (See pars. 174 and 239.)

r. Wire boom.—A device sometimes used in laying field wire from a truck.

s. *Wire circuit*.—An electrical circuit composed of one or more wire conductors. (See par. 164b.)

t. *Wirehead*.—A forward test point to which all trunk and long local circuits for a switching central are brought prior to connection to the switchboard.

u. *Wire line*.—One or more wire circuits.

v. *Wire pike*.—A small pole about 9 feet long used to place field wire lines off or on a road or over limbs of trees, etc.

■ 163. **COMPOSITION OF WIRE SYSTEMS**.—A wire system includes all means of signal communication utilizing wire lines. It consists of wire circuits and the connecting, operating, and testing equipment for use therewith. The wire system of a tactical unit consists of the telephone, telegraph, and teletypewriter facilities installed by the personnel assigned to the headquarters of that unit. For example, the division wire system includes only the wire communication facilities installed and operated by the signal troops assigned to serve the division headquarters.

■ 164. **CLASSIFICATION OF WIRE CIRCUITS**.—*a. According to their use*.—Wire circuits are classified according to their use as follows:

(1) *Trunk* circuits or trunks, which connect switching centrals.

(2) *Local* circuits or locals, which connect telephones to centrals or to other telephones.

b. According to electrical path.—Wire circuits are also classified according to the path provided for the electric current as follows:

(1) *Ground return* circuits, in which the metallic conductor furnishes only a part of the path for the electric current, the return path being through the ground.

(2) *Metallic* circuits, in which the path for the electric current is completed through the metallic conductors. The metallic circuit has proved to be the more satisfactory for telephone communication. It is less susceptible to interference from other circuits and earth currents, or to interception by hostile listening stations.

c. When superimposed on others.—Additional circuits may be superimposed upon metallic circuits by the use of repeat-

ing coils, and when this is done, the circuits are classified as follows:

(1) A single metallic telephone circuit may provide an additional telegraph or telephone circuit without mutual interference. This additional circuit ordinarily uses a ground return and is known as a simplex circuit (par. 216), and the metallic circuit is said to be "simplex." "

(2) Two metallic telephone circuits may provide an additional telephone or telegraph circuit without mutual interference. This third circuit is called a "phantom circuit." (See par. 217.) The two metallic circuits are called "side circuits" or "physical circuits" to distinguish them from the phantom circuit, and the three together are known as a "phantom group." Such a connection, when good ground connections are difficult to obtain, will provide greater signal security than a simplex telegraph circuit. If the phantom circuit of a phantom group is used to provide a telephone channel, this phantom may also be simplex for a telegraph set (fig. 95).

■ 165. MOVEMENT OF COMMAND POSTS.—The maintenance of wire communication is usually more difficult during the movements of command posts than at any other time. The initial installation of each wire system is planned with the object of maintaining continuous wire communication with subordinate units during and after the movement of command posts. No fixed rules can be given, and ingenuity must be exercised. The methods given below show solutions for certain situations, and should be used only as general guides for more specific problems. For explanation of symbols used, see paragraph 170.

a. Single-axis method.—In figure 33, assume that the command post of a unit is located at 3 and that the command posts of its subordinate units are at 1 and 6, respectively. The axes of signal communication of these units are 3-5, 1-2, and 6-7, respectively. The superior unit runs one circuit from 3 to 1 via 4 and another circuit from 3 to 6 via 4. Prior to the movement of the command posts of the subordinate units to 2 and 7, respectively, two circuits are run by the superior unit from 4 to 5, one circuit is continued from 5 to 2, and the other circuit from 5 to 7. When the command post of the subordi-

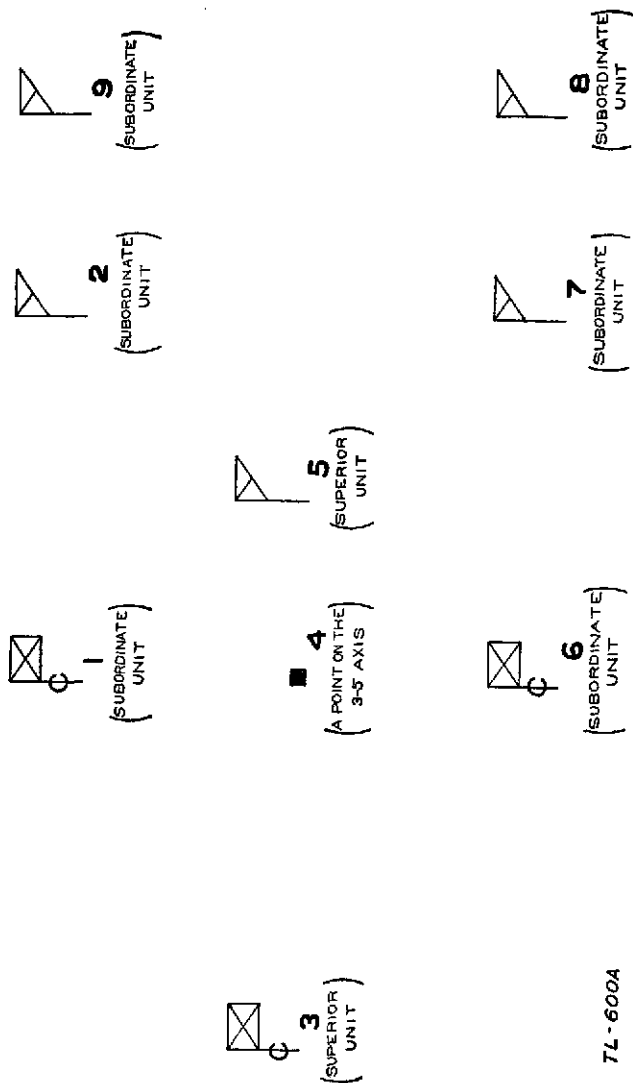

FIGURE 33.—Schematic location of command posts for selection of wire axis.

7L-600A

nate unit at 6 moves to 7, the 3-4-6 circuit is used until the moment the command post closes at 6 and opens at 7. At this instant the 3-4-6 circuit is disconnected at 4, and the 3-4 section of this circuit is connected to the 4-5-7 circuit. The 4-6 circuit may then be recovered or assigned to some other unit. The procedure during the movement of the other command post from 1 to 2 is similar.

b. Multiple-axis method.—(1) In figure 33, assume the same initial locations of command posts and axes of signal communication as before. The superior unit runs two circuits, one from 3 to 1 and the other from 3 to 6. It then lays one circuit along the axis of signal communication of each subordinate unit, passing through 2 and 7, respectively. When the command post of the unit at 6 moves to 7, the 6-7 circuit is connected to the 3-6 circuit. The superior unit maintains the 3-6-7 circuit. The procedure during the move of the command post of the other subordinate unit from 1 to 2 is similar.

(2) To expedite installation, the superior unit may attach wire construction teams to subordinate units with instructions to lay wire toward the superior unit command post as soon as the subordinate unit establishes a command post.

c. Joint-axis method.—In figure 33, assume that the initial command post of the unit is located at 3, and that the initial command posts of its subordinate units are 1 and 6, respectively. The axes of signal communication of these units are 3-1-2-9, 1-2-9, and 6-7-8, respectively, the axis of the superior unit coinciding with the axis of its left subordinate. The superior unit makes the initial trunk installation by laying circuits 3-1 and 3-6. Should all three units move to position from a common assembly area or from the same column in march, these circuits may, by agreement, be laid by the subordinate units en route to position. Should the left subordinate unit desire at any time to advance to another command post, as 2, it lays circuit 1-2, and having decided to open at 2, circuit 1-2 is connected to 3-1 at 1, and signal communication is maintained over circuit 3-1-2. The movement from point 1, and the connecting of circuits at that point, are accomplished without interruption of wire traffic. Assume that the subordinate units have advanced, by the foregoing method, to points 9 and 8, respectively. At this time the

superior unit decides to advance to 2, located on the axis shared jointly with its left subordinate unit. The superior unit first lays a circuit 2-8 and so installs a switchboard at 2 that traffic may be handled over circuits 3-1-2, 2-8, and 2-9. At a suitable time, the switchboard at 3 is removed and the switchboard at 2 begins to serve the new command post. Should a circuit from 3 to the rear exist, this circuit is connected at 3 to the circuit 3-1, no traffic being interrupted.

d. Teamwork method.—(1) In the methods described above, if the command post of either subordinate unit moves to the new location prior to the extension of the circuit by the personnel of the superior unit, wire communication will be interrupted. In rapidly moving situations, continuous wire communication between any unit and its subordinate units can be insured only by coordination between those units. The method in (2) below is based upon this coordination.

(2) In figure 33, assume the same initial locations of command posts. Assume also that each unit installs its wire system by the single-axis method, but that the 4-5-2 and 4-5-7 circuits are not completed by the superior unit until after the movement of the command posts of the subordinate units to 2 and 7. Each subordinate unit has laid at least one circuit along its axis, passing through 2 and 7, respectively. When the command post at 6 moves to 7, the 6-7 circuit laid by that unit is connected to the 3-4-6 circuit laid by the superior unit. When the 4-5-7 circuit laid by the superior unit reaches 7, the 3-4-6-7 circuit is disconnected at 4, and the 3-4 section of the circuit is connected to the 4-5-7 circuit. Communication is then maintained by the superior unit over the 3-4-5-7 circuit. The 4-6-7 circuit may be recovered or assigned to another unit. The procedure during the movement of the command post of the other subordinate unit from 1 to 2 is similar. This method makes use of circuits previously laid but no longer required by a subordinate unit. It conserves personnel, simplifies construction and maintenance, makes the maximum use of the initial system, and facilitates the continuity of wire communication during the movement of command posts.

e. Alternate installation.—All of the methods prescribed

above are suited to obtaining the initial installation. As soon as this installation has been completed an alternate installation along different routes should be initiated.

■ 166. **ORDERS AND INSTRUCTIONS.**—In divisions and higher units, instructions concerning the wire system for a particular operation are usually included in a signal annex. In units below the division, the corresponding instructions are usually issued orally. However, the plan of installation can best be shown by a circuit diagram and a line route map. See instructions, forms, and examples in chapter 10.

■ 167. **CIRCUIT DIAGRAM.**—*a.* A circuit diagram gives schematically the technical arrangement and connections of the circuits and terminal installations of the wire system. (See example, par. 262.)

b. The circuit diagram indicates—

(1) Switching centrals at command posts and establishments served by the wire system, commercial switching centrals, test stations, and long local telephone circuits, that is, circuits to local telephones not in the immediate vicinity of a switching central. These are shown by their special symbols (par. 170) and by their telephone directory names, or telephone directory numbers, if these are used. Their locations are indicated by names of map or terrain features and by coordinates. (The commander of the theater of operations may prohibit such use of map locations and coordinates.)

(2) Number of circuits, including trunks and long locals, between each of the command posts or establishments shown.

(3) Number assigned to each circuit (see par. 168).

(4) Manner of connecting each circuit into or through switching centrals and test stations. This includes the connections for simplex and phantom circuits.

(5) Type of line construction used for each line, such as field wire, open wire, cable, commercial circuits, etc.

■ 168. **DESIGNATING LINES AND CIRCUITS.**—*a.* Wire lines and circuits are given individual designations as published in orders from higher authority.

b. In large wire systems, the designation of wire circuits is the number of the circuit followed by the name or number

of the line; for example, circuit No. 50, cable No. 6, or circuit No. 561, New York-Washington line.

c. In division wire systems, a circuit is not normally designated by name but by its individual number.

d. In assigning numbers to wire circuits the following general rules are observed:

(1) No two circuits in a named or numbered wire line are given the same number.

(2) No two circuits constructed by the same organization during a single operation are given the same number.

(3) All wire lines are divided into sections. A section begins and terminates at successive switching centrals, test stations, or (in the case of a long local) at a telephone. A circuit passing from one section to another is given a different designation on entering the new section.

e. In the wire systems of divisions and lower units, construction and maintenance are facilitated by a numbering system which identifies the general position of each circuit with respect to other circuits in the same system. The example in paragraph 262 illustrates one system of numbering which is given only as a guide. This system provides for the allotment of a block of numbers to each section of the line along the axis and to each section of the line laterally from the axis both to the right and left. Beginning at the rear echelon of the division, each section of the line along the axis is allotted a block of 10 numbers of three digits each—hundreds, tens, and units. The hundreds begin at 1 and increase in arithmetical progression for each section of the line. The last two digits are from 01 to 10 in each section of the line. Laterally to the left each section of the line is allotted a block of nine numbers, the hundreds' number being the same as the section of the axial line, terminating at this point of divergence. The last two digits are from 11 to 19. The next section to the left maintains the same hundreds' number and takes the next block of nine numbers beginning with an odd number, that is, 31 to 39, etc. The same method is applied to the allotment of numbers to the sections to the right of the axis, using, however, for the last two digits, blocks of nine beginning with even numbers; that is, from 21 to 29, 41 to 49, etc.

■ 169. **LINE ROUTE MAP.**—A line route map is a map, map substitute, or overlay suitably titled on which are shown the actual or projected routes of wire circuits, but not the actual connections at centrals or test stations. (See example, par. 263.) Its principal use is in reporting the physical location of wire circuits as actually laid for the information of wire personnel. If an overlay, at least two orientation points taken from the map must be shown in addition, and a reference must be made on the overlay to the map used unless otherwise directed by the commander of the theater of operation. The line route map contains as few lines, symbols, and notations as is consistent with its purpose, but shows the location of each headquarters or establishment served by the wire system, and locations of switching centrals, test stations, and long locals, the type of line construction, and the number of physical circuits in each section of the line.

■ 170. **SPECIAL SYMBOLS.**—The following special symbols are authorized for use as indicated in or in addition to those authorized in FM 21-30.

a. Symbols for circuit diagrams, with corresponding wiring diagrams of connections.

Field wire circuit, twisted pair-----

Commercial circuit, two conductors-----

Several circuit pairs of the same general type-----

Field cable-----

Circuit designation (No. 101)-----

Circuit designation when not constructed by unit issuing the
diagram (101, 2d Inf Div)-----

Interrupted circuits-----

Circuits dead-ended at terminal frame-----

Circuit passing through test station (see par. 174)-----

Circuit terminating in a telephone-----

Circuit terminating in a switchboard-----

Circuit terminating in a telephone or switchboard, simplex
for telegraph (see par. 216)-----

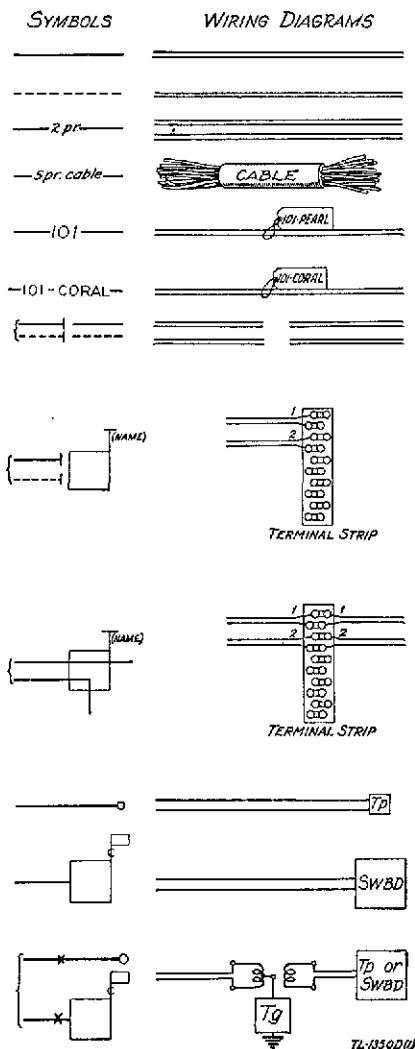

TL-1350D(2)

If required for clarity, show simplexed telegraph set or tele-
typewriter connection (see par. 216) _____

Simplexed circuit bridged around a switchboard; telephone
circuits terminating in the switchboard (see par. 229) _____

Telegraph way station on simplexed circuit, telephone cir-
cuits terminating on the switchboard (see par. 230) _____

Telegraph way station on simplexed circuit, telephone circuit
bridged around the switchboard (see par. 230) _____

Phantom group terminating in a switchboard (see par. 217) __



Side circuits of two phantom groups terminating in a switch-
board, the phantom circuit bridged around the switchboard.

Phantom group terminating in a switchboard, phantom cir-
cuit simplexed for telegraph (see par. 217b) _____

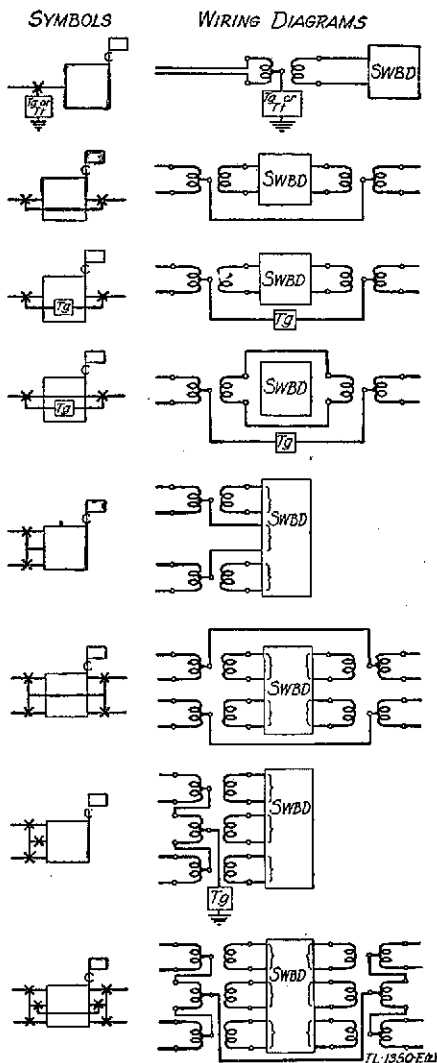





Two phantom groups terminating in a switchboard, the phan-
tom circuit simplexed and bridged around the switchboard.





b. Symbols for line route maps, indicating wire lines.

Field wire line.....	
Number of circuits in a field wire line.....	<u>4</u>
Field cable.....	<u>Spr</u>
Standard pole line.....	

c. Basic symbols for circuit diagrams, line route maps, traffic diagrams, and signal operation maps.

Switching central located at an echelon of a headquarters.....	
Switching central.....	
Commercial switching central (add commercial designation of the central on top of symbol).....	
Test station or terminal frame.....	
Probable future location of a cavalry command post, indicating a point on the axis of signal communication.....	
Probable future location of an infantry command post, indicating a point on the axis of signal communication.....	
Probable future location of a field artillery command post, indicating a point on the axis of signal communication.....	

d. Symbols for traffic diagrams.

Communication channel.....	
Number of communication channels.....	<u>3</u>
Switching central.....	
Telephone.....	

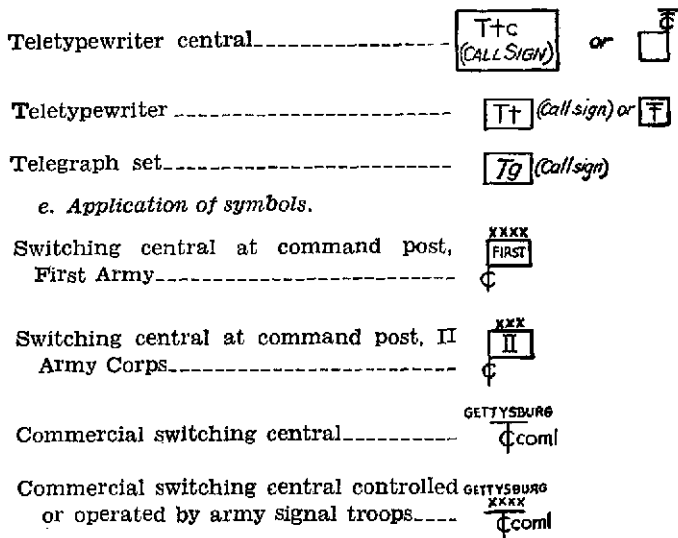

TL-1351C

■ 171. TELEPHONE CAPABILITIES.—*a.* The greatest advantage of the telephone is that it affords immediate personal contact between individuals. Disadvantages of the telephone are lack of record of the conversation and the tendency to talk too long.

b. The efficiency of the telephone system depends upon a number of factors, the most important of which are—

- (1) Type of wire line construction.
- (2) Type of equipment used.
- (3) Weather.
- (4) Training of the personnel operating and using the system.

c. The distance over which satisfactory telephone communication is possible is determined by the electrical characteristics of the telephone circuit. A given type of wire circuit under normal conditions has a definite talking range.

d. The following conditions tend to decrease the efficiency

of telephone circuits and the range of telephone communication:

- (1) Snow, ice, rain, heavy dew, or fog.
- (2) Poor electrical insulation between wires and ground.
- (3) Moisture in the telephone instrument, especially in the transmitter.
- (4) Weak dry batteries in local battery (magneto) telephones.
- (5) Additional telephones bridged across a circuit.
- (6) Additional switchboards involved in a connection.

■ 172. SWITCHING CENTRALS AT COMMAND POSTS.—A switching central is established at each echelon of a headquarters where two or more local telephones are installed to provide flexible intercommunication between local telephones, connections to trunk circuits to other units, and a place at which all circuits are available for test and from which maintenance may be directed.

■ 173. SWITCHING CENTRALS OTHER THAN AT COMMAND POSTS.—A switching central is installed at a point other than an echelon of a headquarters for the principal purpose of trunk switching. Their judicious use enables better telephone service to be furnished with the same number of trunks, but they require additional personnel and equipment, necessitate an additional switching operation with increased possibility of interruptions to service, and introduce additional transmission losses.

■ 174. TEST STATIONS (pars. 200 and 239).—Test stations may be installed on a wire line to facilitate the testing and rearranging of circuits. They may be located at points where circuits diverge at the end of a wire line which does not terminate in a switchboard, near points where circuits are most exposed to damage, at probable future locations of command posts, or at other convenient points on the line. If a command post is established where a test station has been previously installed, the test station can easily be converted into a switching central. Test stations are usually given a geographic designation, for example, Jones Farm Test. In the situations given in paragraph 165*a* and *d*, the location of test stations at points 4 and 5 would facilitate the rearrange-

ment of circuits after the movement of the command posts of the subordinate units. (See par. 239 for operation of test station.) A special type of test station known as a construction center may be established to provide a point on the edge of the command post area where the construction chief may test long local and trunk circuits, to eliminate unnecessary traffic of wire construction vehicles in the command post area, and to make possible the use of a single cable through the area from the construction center to the switching central.

■ 175. TELEPHONE DIRECTORY.—*a.* To simplify and expedite the operation of field telephone systems, particularly within divisions, a telephone directory may be used when prescribed by the commander. This directory consists of two parts which are issued together as one item of signal operation instructions. (See example, par. 265*m.*) When a telephone directory is used, names are assigned to switching centrals. Within a division, all names begin with the same initial letter and when once assigned remain fixed and are not changed except when necessary to avoid conflict with directory names of other units.

b. Each organization, office, and installation reached by telephone but not served by its own switching central, is given a fixed number. To prevent confusion, the superior tactical commander should prescribe the same fixed number for use throughout his command. Directory numbers, when assigned, remain fixed. Within the limitations of equipment, it is desirable that the switchboard jack number correspond to the directory number assigned to the organization, office, or installation.

c. Directory names and numbers are not intended for secrecy, but may be prescribed for purposes of simplicity, accuracy, and speed in the handling of telephone calls. To fulfill its purpose, the telephone directory must be habitually used by all telephone switchboard operators and telephone users. However, operators should be instructed to put through calls regardless of how they may be placed. A copy of the telephone directory should be attached to each field switchboard and telephone in use.

d. In larger units, such as corps and field armies, the use of the telephone directory often becomes impracticable because of the increased difficulty for all concerned, particularly the switchboard operators, in memorizing the directory names of the many switching centrals in the larger system. In such systems, the briefest generally understandable spoken abbreviation of the designation of the organization whose headquarters is served by a switching central may serve as the telephone directory designation of the switching central; for example, "First Army", "Ninth Corps" or "First Battalion, Seventh" for "First Battalion, Seventh Infantry" when no other organization designated by seven is served by the same system.

■ 176. TELEPHONE CONVERSATIONS.—*a.* In placing a telephone call the complete designation of the party desired is given to the switchboard operator, including the directory name of the unit and the directory number of the party. However, when placing a call to a party at the same headquarters or echelon served by the same switchboard, it is not necessary to give the directory name of the unit.

b. In answering a telephone call, the expression "Hello" should not be used. The individual answering the call states the directory name and number of that telephone and identifies himself, as "Magic three, S-3 (or Captain Jones) speaking."

c. Telephone conversations should be made brief by mentally preparing the subject matter beforehand so as not to deprive others of the use of the circuits. The telephone should not be used for long reports, orders, or messages when messenger or telegraph communication would serve as well or better. Conversations must be discrete because secrecy is never assured; they may be intercepted by direct tapping of the line, by induction from the lines, and by leaks to the ground and thence to enemy listening sets.

d. No unnecessary conversations should be held with the switchboard operator, and he should be spoken to in a civil manner. In case it is desired to make a complaint regarding the service, it should be made to the chief operator or to the signal or communication officer. The operator should not be directed how to route a call, nor should the calling party

attempt to route his own call by merely asking for connection to a certain central. The operator is best prepared to put through a call with minimum delay when he is given the complete designation of the party to be called.

■ 177. CONFERENCE CALLS.—*a.* At certain times it is desirable for a commander or one of his staff officers to obtain telephone connection with two or more other individuals at the same time in order to transmit instructions or information to all parties simultaneously. For this purpose the conference call is used.

b. A conference call is obtained by the calling party stating to the operator "Conference call," giving the telephone directory designations of the parties desired, such as "Dragoon six, Domino six, Diamond six," and giving his own directory designation if necessary. The calling party may instruct the operator that in the absence of the particular party called certain other staff officers or their assistants will be satisfactory. After placing a conference call, the calling party may hang up to wait recall by the operator. The connection is established by the operator as described in paragraph 3, appendix I.

■ 178. PHONETIC ALPHABET.—*a.* Certain letters of the alphabet have similar sounds and are often confused in telephone conversations. To avoid this difficulty, the following pronunciation of letters is prescribed for all voice communication, including telephone and radio:

Letter	Spoken as—
A	Afirm
B	Baker
C	Cast
D	Dog
E	Easy
F	Fox
G	George
H	Hypo
I	Inter ¹

Letter	Spoken as—
J	Jig
K	King
L	Love
M	Mike
N	Negat
O	Option
P	Prep
Q	Queen
R	Roger

Letter	Spoken as—
S	Sail
T	Tare
U	Unit
V	Victor
W	William
X	X-ray
Y	Yoke
Z	Zed

¹ *Interrogatory* is used in place of *Inter* in joint Army-Navy operations.

b. The words of the phonetic alphabet are used in place of the letters they represent just as in spelling a word. Expressions such as "A as in Afirm" or "A for Afirm" are not used. For example, in transmitting the words "Barts church" the word Barts is likely to be misunderstood. The transmission is as follows: "Barts, spelled Baker-Afirm-Roger-Tare-Sail, church."

c. The phonetic alphabet is also used in the transmission by telephone of coded messages. For example, the code group XISV is transmitted as "X-ray-Inter-Sail-Victor."

■ 179. PRONUNCIATION OF NUMERALS.—a. The following pronunciation of numerals is prescribed in telephone transmission:

Numeral	Spoken as—
0	Ze-ro
1	Wun
2	Too
3	Thuh-ree
4	Fo-wer

Numeral	Spoken as—
5	Fi-yiv
6	Siks
7	Sev-ven
8	Ate
9	Ni-yen

b. Numbers are transmitted as numerals or digits except in the case of an even hundred or thousand, when the word hundred or thousand is used. Examples:

Number	Spoken as—
44	Fo-wer fo-wer,
80	Ate ze-ro,
136	Wun thuh-ree siks.
500	Fi-yiv hun-dred.
1478	Wun fo-wer sev-ven ate.
7000	Sev-ven thow-zand.
16000	Wun siks thow-zand.

c. When giving a telephone number to a switchboard operator, speak the directory name deliberately and distinctly, pausing between the name and first numeral. Speak each

numeral separately, pausing slightly between numerals. Examples:

Directory name and number	Spoken as--
Table 44.	Ta-ble, fo-wer fo-wer.
Turkey 80.	Tur-key, ate, ze-ro.
Track 6100.	Track, siks, wun, hun-dred.

■ 180. TELEGRAPH AND TELETYPEWRITER CAPABILITIES.—*a.* The telegraph is one of the most rapid and accurate electrical means of transmitting messages and its value in a field wire system must never be overlooked. A failure to utilize telegraph channels will seriously overburden any field telephone system that may be installed during the normal time allowable and will defeat the principal purpose of the telephone. In suitable installations, telegraph messages and telephone conversations may be transmitted simultaneously over the same circuit without mutual interference (par. 164c(1)) by means of the simplex circuit which will be installed on every wire line provided the units being served by the wire have the equipment necessary. Although the ranges of telephone and telegraph instruments are in general limited by the same factors, most telegraph instruments have a much greater range than do telephones over a given circuit.

b. The teletypewriter is an instrument designed for interchanging printed messages between two or more stations. It is employed between higher headquarters in the same manner as the telegraph is employed between headquarters of units within a division. A military teletypewriter is illustrated in figure 34; for data on its employment, see FM 11-5, and for information regarding the installation and maintenance of such equipment, see TM 11-353.

■ 181. TELETYPEWRITER CENTRAL (TTC).—*a.* The usefulness of the teletypewriter as a signal communication agency is tremendously increased by the teletypewriter central. In the military service, this is abbreviated as Ttc. The abbreviation for a commercial teletypewriter exchange, to which military operated teletypewriters may be connected in certain situ-

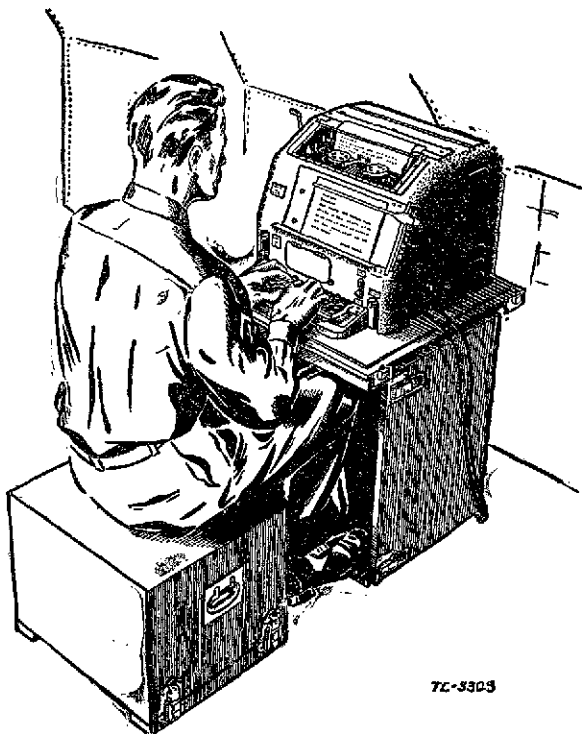

FIGURE 34.—Military teletypewriter.

ations, is TWX. The switchboard for a small teletypewriter central is quite similar to a telephone switchboard, except that the operator communicates by means of a teletypewriter. A reperforator often may be used in place of a switchboard at a teletypewriter central, or the relay may be manual by re-typing. The teletypewriter central provides great flexibility in switching between teletypewriter stations, and such connections as two-way station-to-station, conference, and broadcast can be quickly set up. In addition to the provisions for stand-by and automatic starting and stopping of distant teletypewriters for receiving messages while unat-

tended, the advantages of the system include instantaneous transmission, typed immediate acknowledgment of receipt typed on the message itself.

b. Teletypewriter central personnel can expedite communication by the preparation and use of traffic diagrams, prepared in a manner similar to telephone traffic diagrams (see par 223).

■ 182. **REPORTS AND RECORDS.**—*a.* In order to make the most efficient use of the wire system, the signal or communication officer keeps himself informed of the condition of the systems of his own and subordinate units. Subordinate units report to next superior units when the wire system is first installed and thereafter whenever important changes are made. These reports are usually made by telephone or telegraph, supplemented by line route maps and circuit diagrams.

b. The signal or communication officer requires the signal or communication troops under his immediate supervision to keep such records relating to the wire system as are essential to its efficiency. These records cover installation, maintenance, and operation. They are seldom kept in small units where few circuits are maintained. Reports are made by the chief of construction on the installation or recovery of wire lines. When necessary, the operating personnel keep station logs, and installation, test, and trouble reports. (See secs. III and V.)

SECTION II

FIELD WIRE LINE CONSTRUCTION

■ 183. **GENERAL.**—Field wire is a flexible conductor of high tensile strength and good conductivity, usually composed of a combination of steel and copper strands covered by insulation. Field wire lines are used within the zone subject to hostile shell fire, and in rear areas when time does not permit the installation of other more permanent types of construction.

■ 184. **TYPES OF FIELD WIRE.**—The characteristics and approximate transmission distances of four types of field wire are shown in the table below. Each conductor of types W-110, W-110-B, and W-150 is insulated with rubber compound and weatherproof braid. The braid is omitted on the type W-130.

Characteristics	Wire W-110	Wire W-110-B	Wire W-130	Wire W-150
Number of conductors	2 twisted	2 twisted	2 twisted	2 twisted
Tensile strength	340 pounds	246 pounds	110 pounds	110 pounds
Satisfactory transmission distance:				
Unloaded	10-15 miles	11-17 miles	6-10 miles	6-10 miles
Loaded	14-22 miles	16-24 miles		
Issued:				
In coils	1,000 feet	1,000 feet	2,640 feet (on spools)	2,640 feet (on spools)
On reel DR-4	2,400 feet	2,400 feet		
On reel DR-5	1 mile	1 mile		
On reel DR-8			1,320 feet	600 feet
Weight:				
Wire along	132 pounds per mile	132 pounds per mile	32 pounds per mile	49 pounds per mile
Reel DR-4 filled	82 pounds	82 pounds		
Reel DR-5 filled	166 pounds	166 pounds	10 pounds	8 pounds
Reel DR-8 filled				
Per conductor:				
Composition	5 steel and 2 copper strands	4 steel and 3 copper strands	6 steel and 1 copper strands	6 steel and 1 copper strands
Tensile strength	200 pounds	145 pounds	55 pounds	55 pounds
Resistance	130 ohms per mile	95 ohms per mile	317 ohms per mile	317 ohms per mile

■ 185. **FIELD WIRE SPLICES.**—*a. General.*—Splices in a field wire line are present of necessity and are vulnerable points in the circuit; as such they merit sufficient time, effort, and matériel to be made properly. Every soldier engaged in communication work should be able to make a proper wire splice. The ideal splice would be indistinguishable electrically or mechanically from the unspliced wire. In practice, this cannot be attained, and consideration must therefore be given to the following characteristics of splices:

- Tensile strength
- Electrical conductivity
- Insulation resistance
- Protection against weathering and abrasion
- Flexibility and bulkiness

These factors must be balanced against the time required to make the splice. The standard field wire splice which best meets those requirements comprises a wire knot tie, seizing wire to bind the tie, and tape for insulation.

(1) *Square knot.*—A properly made square knot between the two ends of a conductor produces a tie which will not pull out.

(2) *Seizing wire.*—(a) A flexible field wire of high tensile strength will necessarily have a number of steel strands which are difficult to manage due to their temper. The natural tendency of the strands to spring up prevents the splice from staying tightly wrapped and the ends of the steel strands tend to puncture through the insulation and render the splice unserviceable. In making the standard splice, seizing wire is wrapped around the conductors after the square knot is tied. This keeps the strands in place and the binding effect of the seizing wire on both ends of a spliced conductor, together with the large contact area, produces a splice of high and constant electrical conductivity. Under conditions of low and variable conductivity such as may exist in a splice made by a knot alone, a circuit becomes noisy and interferes with telephonic communication.

(b) If a wire conductor is sufficiently flexible, it can be wrapped on a small radius without spreading and seizing wire can be dispensed with in a properly made splice (such as described for wire W-130).

(3) *Insulation.*—The primary reason for insulating a splice is to render the resulting circuit as satisfactory electrically in wet weather as in dry weather. Electrical insulation adequate to meet this requirement can be obtained only with a minimum of two layers of rubber tape and two layers of friction tape. (See par. 187.)

(4) *Bulk.*—The physical size of an insulated splice is no criteria of its ability to withstand service conditions satisfactorily. If properly made, a field wire splice is adequately flexible for service use, and its bulk is such that it will not seriously affect the wire capacity of a reel, since this is determined primarily by the ability of personnel to wind wire smoothly and uniformly. Extremely bulky splices are usually indicative of the need for further training of the individual making the splice.

b. Standard field wire splice.—This splice, utilizing copper seizing wire W-71, is used on all heavier types of stranded conductor field wire.

(1) *Teamwork in splicing.*—If two men are available, the over-all time for the splice can be greatly reduced if they have a standard cooperative method and function as a team. Only the teamwork splice is described; obvious modifications of the procedure can be made if one man is working alone.

(2) *Staggering splice* (fig. 35).—Each man prepares one of the two wires which are to be spliced together. To obtain a uniform stagger which will insure equal tension on both conductors when the splice is completed, each man measures back one pliers' length (about 6 inches) from the end of one

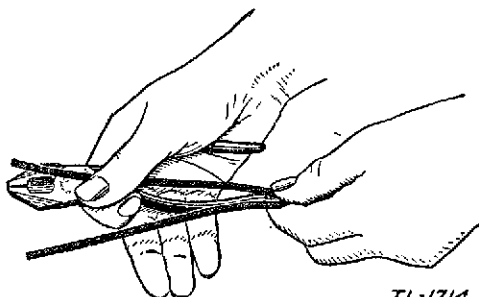

TL-1714

FIGURE 35.—Staggering splice.

conductor of the wire pair he is preparing, and cuts off the conductor thus measured. Each man now has two conductors, with one cut so as to be one pliers' length shorter than the other.

(3) *Crushing insulation.*—Each man now begins crushing the insulation on his long conductor at the point where the short one ends, that is, one pliers' length from the end of the long conductor. (See fig. 36.) Using the heel of his pliers,

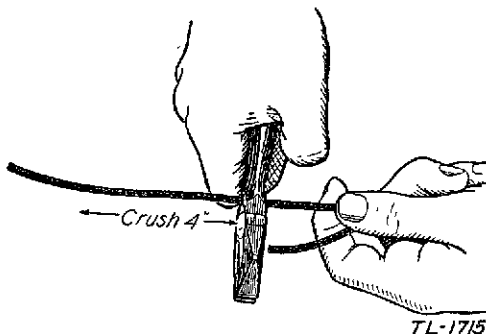
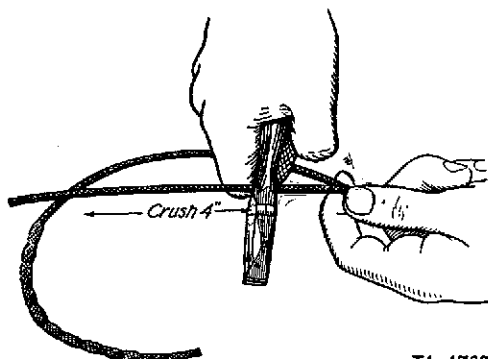

FIGURE 36.—Crushing insulation on long conductors.

he crushes the insulation toward the end for a distance of about 4 inches, leaving about 2 inches of the insulation uncrushed on the end of the conductor. He next measures back one pliers' length along the short conductor, and in a similar manner crushes about 4 inches of its insulation. (See fig. 37.) The uncrushed insulation remaining on the ends of the conductors holds the strands of the conductors together, prevents possible injury by the steel strands to the splicer, and greatly reduces the over-all splicing time. (With some types of pliers, it may be necessary to improvise shims from sheet metal in order to crush the insulation.)

(4) *Skinning conductor.*—Each man scores or rings the crushed insulation of both conductors with the cutting edges of his pliers at a point on the crushed section about $\frac{1}{2}$ inch from the point at which the crushing began. He then bares about $3\frac{1}{2}$ inches of the conductor by changing the hand grip on his pliers (fig. 38) and drawing the cutting edges of his pliers straight along the conductor so as to push the crushed

insulation ahead of the pliers. In this operation, care is taken to draw the pliers perpendicularly along the conductor, as drawing the pliers at any appreciably different angle to



TL-1737

FIGURE 37.—Crushing insulation on short conductor.

the conductor will nick or break the strands thereof. Although slower, this skinning may be done satisfactorily with less danger to the strands by using the gripping jaws or the heel of the pliers instead of the cutting edges. If these

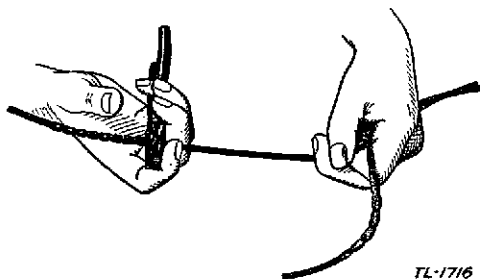

TL-1716

FIGURE 38.—Skinning conductor.

strands appear dirty, he carefully scrapes them with the back of the screw driver blade of his electrician's knife. The entire procedure of staggering the splice, crushing the insulation, and skinning the wire should not take over 1 minute.

(5) *Tying square knot.*—The ends of the two wire pairs are now brought together and the long conductor of one pair and the short conductor of the other are tied in a square knot by each man (fig. 39), taking care to restore the original twist of the two conductors. The square knot is so placed as to leave a distance of about $\frac{1}{4}$ inch between the knot and the rubber insulation. The weatherproof braid of the conductor is then peeled back from the $\frac{1}{2}$ inch of wire that was crushed but not skinned. This leaves $\frac{1}{2}$ inch of exposed rubber insulation to permit close adhesion of the rubber tape when it is applied. (See figs. 40 and 41.)

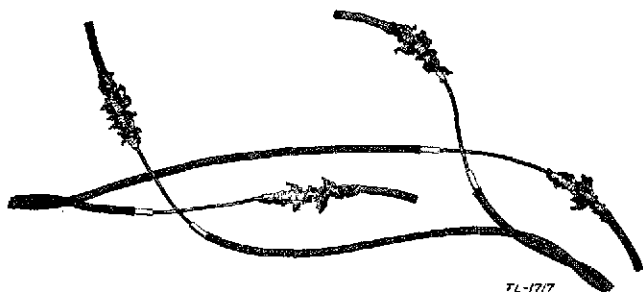

FIGURE 39.—Wires skinned and ready for square knots.



FIGURE 40.—Tying square knot.

(6) *Applying seizing wire.*—A 6- to 8-inch piece of seizing wire W-71 is inserted up through the square knot and then the knot is pulled tight (fig. 41). Seizing wire can always

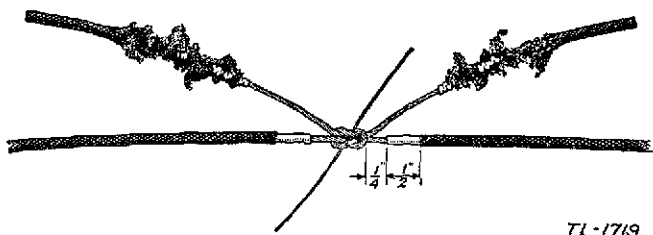

FIGURE 41.—Seizing wire inserted through knot.

TL-1719

be improvised by using a copper strand from the piece of wire cut off when staggering the splice. The seizing wire is bent so as to have half for wrapping to the left and half for wrapping to the right. Two or three close turns are taken with the seizing wire, both to the left and to the right of the square knot (fig. 42), to bind the ends of the knot before

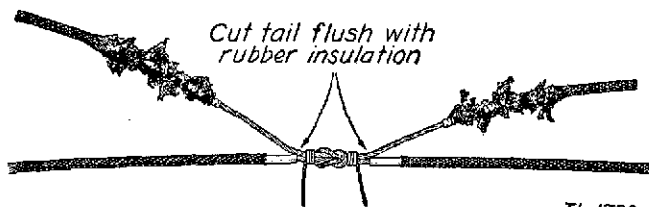

FIGURE 42.—Wrapping seizing wire.

TL-1720

cutting off the excess ends of the conductors flush with the rubber insulation. The seizing wire wrap is then continued both left and right of the square knot until two turns are taken on the rubber insulation (fig. 43). The ends of the

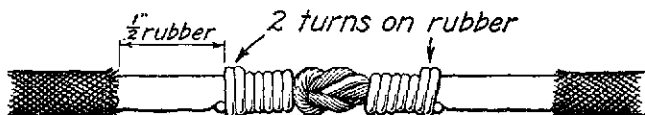

FIGURE 43.—Splice on one conductor after seizing is completed.

TL-1725

seizing wire are now cut off flush and pressed down into the rubber. With both men tying the square knots and applying the seizing wire at the same time, the over-all time for these operations should be about 1 minute (fig. 44). Tape the splice as described in paragraph 187b.

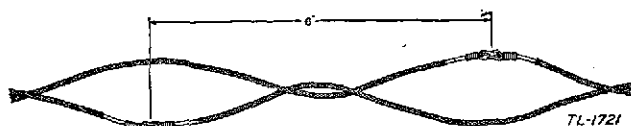

FIGURE 44.—Splice ready for taping.

c. Splicing wire W-130 and other field wire without seizing wire.—To splice wire W-130 and other field wire without seizing wire, cut off one conductor of each pair a pliers' length (about 6 inches) from the end. Slip back about 3 inches of the rubber insulation from each conductor by holding the pliers as shown in figure 38, clamping the jaws lightly and drawing the pliers toward the end of the wire. The remaining 3 inches of insulation on the end of the conductor keeps the strands from fraying. Tie a square knot in one wire; then cross the left-hand short end over the crest of the knot, wrapping several turns closely over the bared part of the right-hand conductor and two or three turns over the rubber insulation. Cut off the excess flush with the wire (fig. 45). Repeat with the right-hand short end, again crossing the crest of the knot and wrapping the left-hand conductor. The other wire of the pair is tied in the same manner. Tape the splice as described in paragraph 187b(1). This splice will not loosen when tension on the wire is relieved and has adequate electrical conductivity.

■ 186. SPECIAL WIRE SPLICES.—*a. Western Union splice* (fig. 46).—The Western Union splice is used in splicing two solid conductor insulated wires. To make the splice, strip the insulation from the end of each wire for a distance of about 8 inches and clean the wires so that they are bright and free from corrosion. Twist the bare ends together in the center for about $2\frac{1}{2}$ inches. Then bend the ends at right angles to the axis of the wire and wrap each end around the wire with at least five close turns. The twisted part of the splice

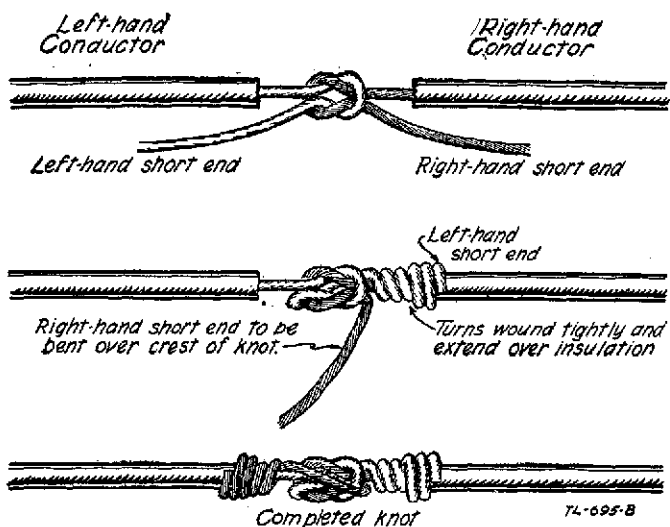

FIGURE 45.—Splicing field wire W-180.

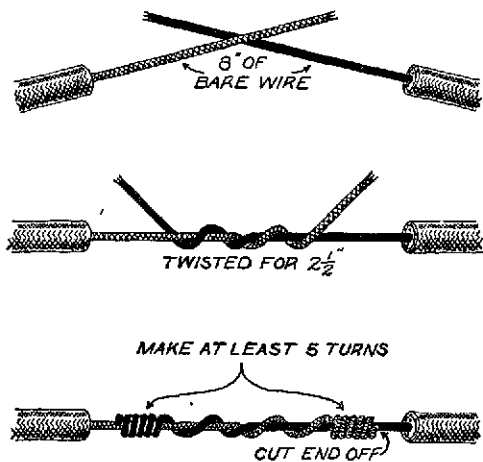

FIGURE 46.—Western Union splice for solid conductors.

is called the "neck", and the five turns at each end are called the "buttons." Cut off the ends as close as possible, being careful not to leave a sharp point that will puncture the tape wrapping. (See par. 187b(2) for taping this splice.)

b. *Combination splice* (fig. 47).—The combination splice is used to splice a stranded conductor insulated wire to a solid conductor insulated wire. To make the splice, strip the insulation from the end of each wire for a distance of about 6 inches and clean the wires so that they are bright and free from corrosion. Tie an overhand knot in the stranded wire close to the insulation and slip it over the solid wire to within $\frac{1}{2}$ inch of the insulation. Pull the knot tight and wrap the end of the stranded wire around the solid wire from the knot to the insulation. Cut off the surplus stranded wire. Bend the end of the solid wire back at the knot and with it seize the stranded wire, wrapping it up as far as the insulation. Wrap the solid wire in the direction opposite to the wrappings of the stranded wire, otherwise the solid wire will fail to

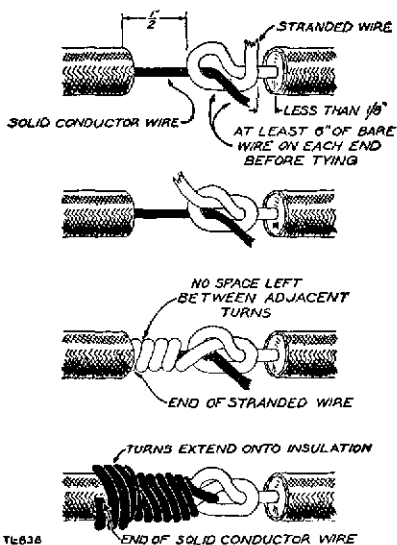

FIGURE 47.—Combination splice, solid to stranded conductor.

hold the strands in place. Continue the wrapping of the solid wire until two turns are taken over the insulation. Cut off the surplus solid wire and press the end down into the insulation. See paragraph 187b(2) for taping this splice.

c. *Combination seizing wire splice* (fig. 48).—This splice is used to connect an insulated stranded conductor to a bare solid conductor such as is used on an open wire pole line, in the manner shown in figure 57. To make the splice, strip about 1 inch of insulation from the end of the stranded wire and clean both wires so that they are bright and free from corrosion. Lay this end of the stranded wire along the solid wire. Begin the seizing by taking four turns with the seizing wire around only the solid wire back of the stranded wire. Continue the wrapping, including several turns over the insulation of the stranded wire, then over the bare end of the stranded wire, and finish with four turns over the solid wire only. Wrap the seizing wire tightly and draw the turns close against each other. (See fig. 57 for tying in the splice.) Tape splice as described in paragraph 187b(3).

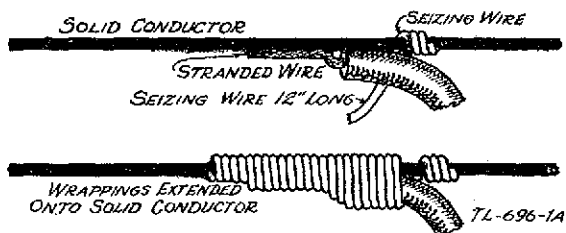

FIGURE 48.—Combination seizing wire splice, stranded to solid conductor.

d. *Commercial splice* (fig. 49).—The commercial splice is used to connect an insulated solid conductor and a bare solid conductor as used on an open wire pole line. To make the splice, remove the insulation from the insulated wire for a distance of about 6 inches and clean both wires so that they are bright and free from corrosion. Lay this bare end of the insulated wire along the bare wire. Bend this end at right angles to the bare wire and wrap it around the bare wire for at least eight turns, drawing the turns tight and close

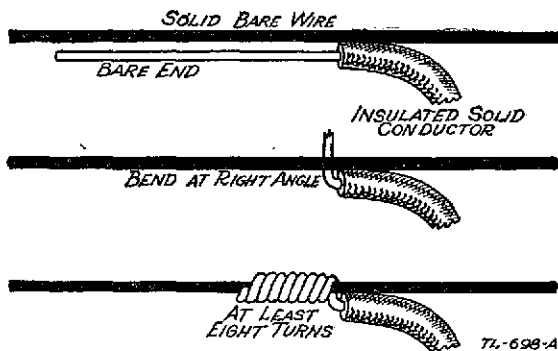

FIGURE 49.—Commercial splice, solid to solid conductor.

together. Cut off the surplus end of the insulated wire. See paragraph 187b(3) for taping splice.

e. *T-splice*.—The T-splice is used to splice a wire to another without interrupting the circuit of which the latter is a part. In figure 50, X is the wire in the circuit and Y is the wire to be connected. In this illustration it is assumed that after the splice is completed the portion of X to the left of the splice will be discarded and that the strain will be toward the right. To make the splice—

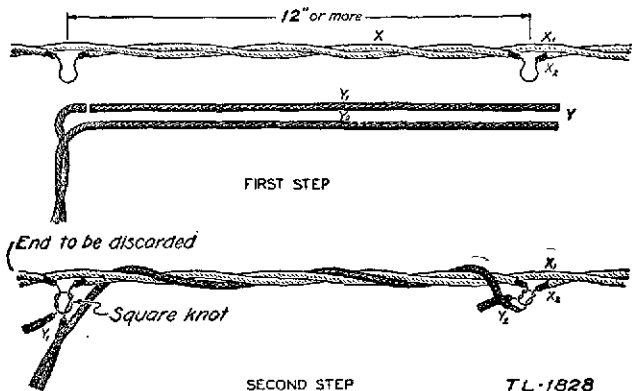

FIGURE 50.—T-splice.

(1) Remove about $1\frac{1}{2}$ inches of insulation from each of the conductors of X, 12 or more inches apart.

(2) Place Y beside X with the two ends at one of the bared places.

(3) Cut Y off at the other bared place, and prepare the ends of Y₁ and Y₂ for splicing as in paragraph 185b(3) and (4).

(4) Tie Y₁ to X₁ with a square knot. To tie this knot, make a loop with the left hand in the bared part of X₁; with the right hand, pass the end of Y₁ up through the loop, over the right side of the loop, under the neck of the loop over the left side of the loop, and down through the loop; draw the knot tight. To avoid making a "thief" knot, be sure that the two conductors on which the strain is to be placed are on the same side of the loop, otherwise the knot will not hold.

(5) Twist Y₂ around X₁ and X₂, and tie Y₂ to X₂ in a similar manner.

(6) Cut off the portion of X to be discarded and complete the splice as indicated in paragraph 185b.

■ 187. TAPING SPLICES.—*a. Insulation resistance.*—Splices are insulated to provide circuits with transmission characteristics substantially independent of weather conditions. This requires first that the insulation resistance of the splice be maintained at the same level as that of the rest of the line, and second that the splice be protected from corrosion and resulting poor conductivity due to weathering. Under service conditions, in which time is an important factor, tapes provide the most convenient materials for covering splices. Figure 51 shows the relative effectiveness of rubber and friction tape for insulating field wire splices. In this graph, the insulation resistance of new wire is taken as the standard of reference, and evaluated at 100 percent. The ordinate represents the ratio in percent of the actual insulation resistance of the given splice covering to the standard insulation resistance of the uninjured new wire. The abscissa represents the time of continuous immersion of the splices in water. As is evident from figure 51, the insulation resistance of all splice coverings is lowered with increase in time of immersion of the samples. However, the rate at which the resistance decreases varies between wide limits for the various

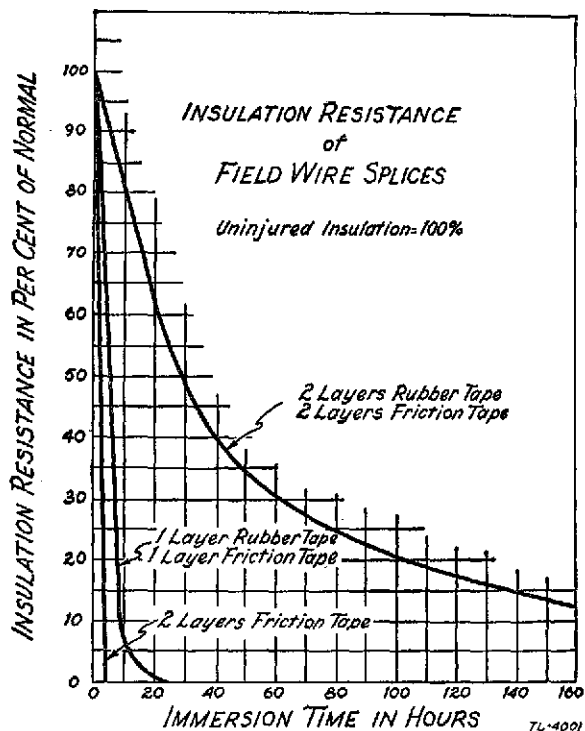
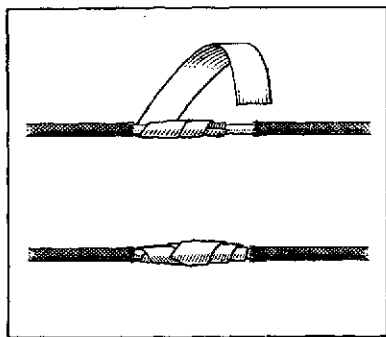

FIGURE 51.—Insulation resistance of field wire splices.

combinations of insulation. The standard field wire splice insulation consisting of two layers of rubber tape and two layers of friction tape, decreases 50 percent in insulation resistance in 29 hours. After 160 hours immersion (approximately 1 week), the resistance is of the order of 12 percent of standard. In contrast, the same splice insulated with only two layers of friction tape drops to 50 percent of its original insulation in 2 hours, and becomes practically useless as an electrical insulating medium in a matter of 5 hours. A splice covered with one layer of rubber and one layer of friction tape is but little better than one insulated with friction tape alone.

Wire such as type W-130 insulated with but a single layer of rubber also requires both rubber and friction tapes to produce a splice of good wearability. Although the smooth exterior of this wire does not catch readily and can be dragged without appreciable wear, this is not true for a surface wound with rubber tape. Friction tape wound over the rubber tape presents a much smoother and more durable exterior and is a buffer against abrasion when the wire is dragged along the ground or wound around an object, as well as affording protection to the rubber tape against deterioration by sunlight and weathering in general.

b. *Procedure.*—(1) In taping the field wire splice by the teamwork method (par. 185b), one man holds the wire taut and the other applies two layers of rubber tape to the splice. The taping is started at the center of the splice and is worked to the left and right of the knot for a distance of $\frac{1}{2}$ inch on the rubber insulation of the conductor, and then back again ending at the center of the splice. (See fig. 52.) The rubber



TL-1722

FIGURE 52.—Applying rubber tape.

tape is stretched considerably during winding so as to give close adhesion, and is pressed into intimate contact with the rubber insulation on both ends of the splice to make it waterproof. Two layers of friction tape are then wrapped in the same manner over the rubber tape. The friction tape is extended about 1 inch beyond the rubber tape (see fig. 53)

and then rolled several times in the hands to seal the edges of the tape. This gives an over-all taped splice of about 4 inches on each wire of the pair.

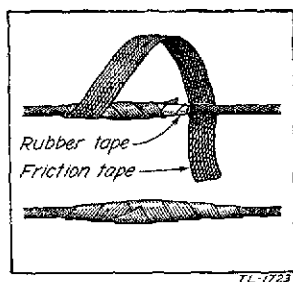

FIGURE 53.—Applying friction tape.

(2) Splices in insulated wire (par. 186a and b) are taped in the same manner as described for the standard field wire splice above.

(3) Insulated wire spliced to bare wire (par. 186c and d) is also wrapped with two layers of rubber tape and two layers of friction tape, to assist in holding the wire firmly in place and to reduce corrosion due to weathering. Figure 54 illustrates the completed and insulated splice, and the method of extending the wrappings of the tapes on the solid conductor well beyond the region of actual contact of the two conductors.



TL-696-2

FIGURE 54.—Taping an insulated conductor spliced to bare wire.

■ 188. WIRE TIES.—Field wire lines usually terminate at the binding posts of a terminal strip or an instrument. Obviously any strain placed on the wire tends to pull it away from the binding posts. To avoid this, the wire is securely fastened to

a convenient tree, pole, or other support before connecting it to the binding posts. Wire lines are also tied in at various points along the route where it is necessary to hold the wire in place. Several kinds of ties which should meet all conditions in field wire line construction are described below. Where the wire is tied above equipment to which it is to be connected, such as a telephone or terminal strip, a drip loop is made in the wire. (See figs. 55 and 56.)

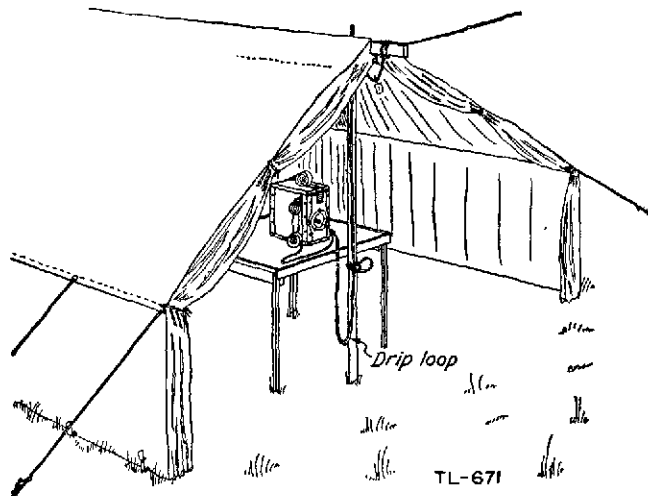

FIGURE 55.—Field telephone installed in a tent.

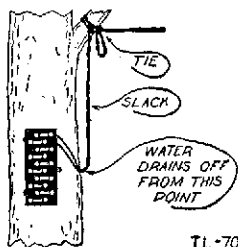

FIGURE 56.—Drip loop in wire leading to a terminal strip. Water running down the wire will drip off from the bottom of the loop and will not be led to the terminal strip or instrument where it might cause a short circuit or damage the equipment.

a. Tying in field wire to open wire (fig. 57).—Stranded wire is normally spliced to solid conductor wire only where it is necessary to connect a field wire to an open wire pole line. The stranded wire is tied in to the cross arm or pole, but never to the metal brace, near the point where the splice is to be made, and a little slack is left between the tie and the splice. The tie should take the strain, since the splice is not strong enough to withstand a heavy pull.

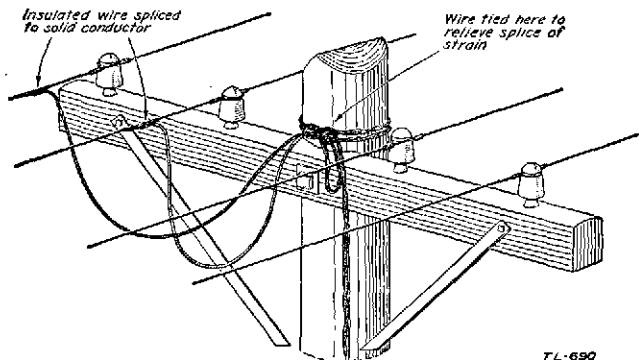

FIGURE 57.—Tying in field wire to open wire.

b. Clove hitch tie.—When the end of the object to which the wire is to be tied is exposed so that the wire may be placed over it, the clove hitch tie is used. To make up the tie, make two loops in the wire as shown in figure 58①. Place the right-hand loop on top of the left-hand loop without turning either loop as shown in figure 58②. Place both loops over the object to which the tie is to be made and pull them tight as shown in figure 58③.

c. Other knot ties.—When the end of the object to which the wire is to be tied is not exposed, one of the three ties described below is used. All three permit tying the wire without cutting it. For simplicity, figures 59 and 60 show only one of the two conductors of the field wire. In each of those figures the standing part is the part of the line which has already been laid, and the running end is the part leading to the wire-laying equipment. This may be reversed if the

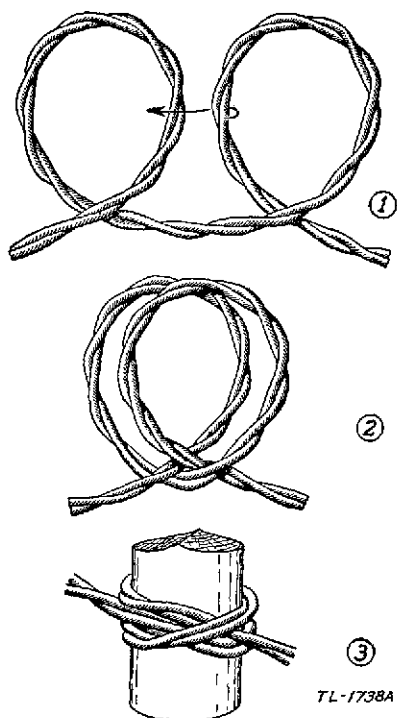

FIGURE 58.—Clove hitch tie around a stake.

strain is in the other direction. A bight is a loop formed on the wire so that the two parts of the loop lie alongside of one another.

(1) *Loop knot tie.*—This is made more easily and quickly than are those described in (2) and (3) below but it is not so secure. Consequently, it is not used in very long spans, at overhead crossings where increasing sag resulting from slipping of the tie might endanger traffic, or where it might be untied accidentally by passing personnel, vehicles, or animals.

(a) 1. To make the tie, stand facing the object on the side on which the wire is being laid. Pull in enough

slack to make a bight to go around the object with about 2 feet of bight left over. If, during tying, the greater strain is on the standing part, place the bight around the object from the front, going around the side toward which the wire is being laid, and returning to the front on the side from which the wire has been laid (fig. 59①). (If the greater strain is on the running end, place the bight around the object from the front in the opposite direction.) Bring the bight under and then over both the standing part and the running end, forming the front V-opening shown in figure 59①. Reach through this opening and pull through it about 6 inches of the doubled bight as shown in figure 59②. Tighten the tie, being sure that it rests against the object.

2. An alternate satisfactory loop knot tie may also be made as follows: After placing the bight around the object (fig. 59③), hold the bight in the left hand, passing the right hand under the standing part and running end, and grasping the bight with the right hand palm up (fig. 59④), turn the hand in a counterclockwise direction, pulling the loop under the standing part and running end (fig. 59⑤); double the bight and pass it over the line and into the loop, pulling the bight until the knot is tight and against the object (fig. 59⑥).

(b) To untie the tie, pull the free end of the bight through the opening. The wire will fall away from the object.

(2) *Square knot and loop tie.*—This tie is used in long spans, at overhead crossings, and when a tie is desired which will remain secure for a longer time than the one described in (1) above.

(a) To make the tie, begin as in (1) (a) 1 above, but bring the bight over both the standing part and the running end, and then between the object and the turn around it, as shown in figure 60①. Draw this knot tightly against the object. Bring the bight over the running end, forming the opening

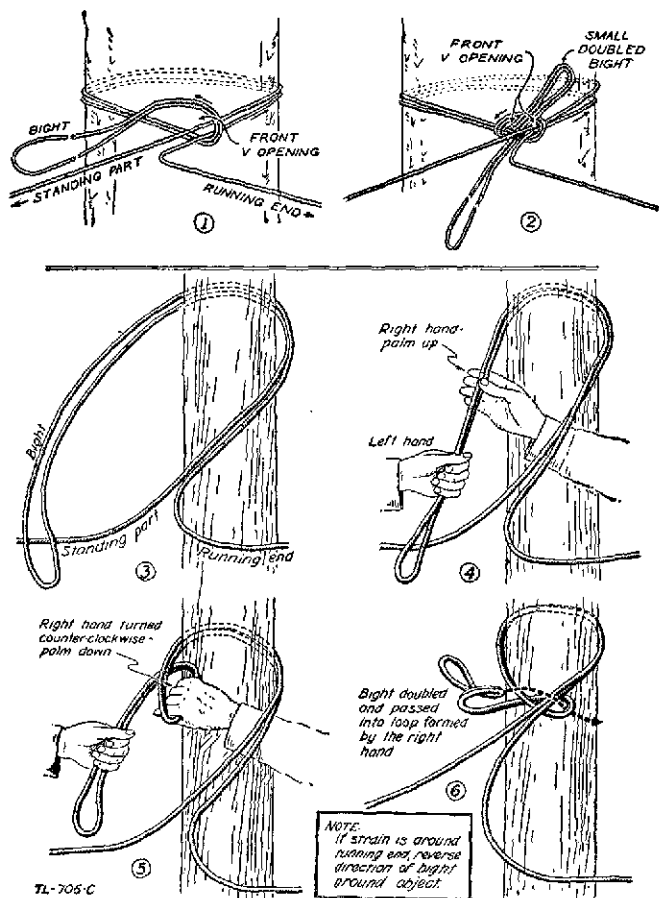

FIGURE 59.—Loop knot ties showing only one of the two conductors.

shown in figure 60②. Reach through this opening and pull through it about 6 inches of the doubled bight as shown in figure 60③. Tighten the tie by holding the doubled bight in one hand and pulling the running end with the other.

(b) To untie the tie, pull the free end of the bight through

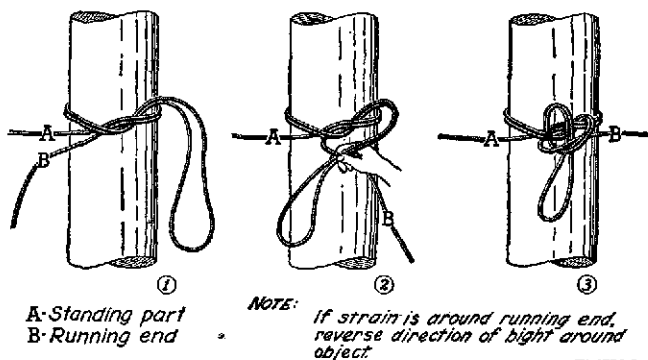

FIGURE 60.—Square knot and loop tie, showing only one of the two conductors.

the opening and then untie the bight from the object. The wire will fall away from the object.

(3) *Square knot tie*.—This tie is used when a tie is desired which will remain secure for a longer time than those described in (1) and (2) above.

(a) To make the tie, proceed as in (2) (a) above but pull the end of the bight through the opening and tighten it by holding the end of the bight in one hand and pulling the running end with the other. It is shown in figure 78.

(b) To untie the tie, reverse the procedure in (a) above. After it has remained in place for some time under a strain, it is more difficult to untie than are the ties described in (1) and (2) above.

d. *Knob tie* (fig. 61).—The knob tie is used in tying field wire to a knob or insulator. It is not suited to tie over larger objects. To make the tie, form a loop in the wire. Separate the two conductors in the loop and bend each back around its side of the length of wire so that they again touch each other 180° opposite the original position of the loop. Place the loop over the knob and draw it tight.

e. *Marline tie*.—The marline tie may be used to support a field wire line on a knob, cross arm, or other support when there is a possibility that the object to which the wire is to be tied might damage the insulation. To make the tie, take a

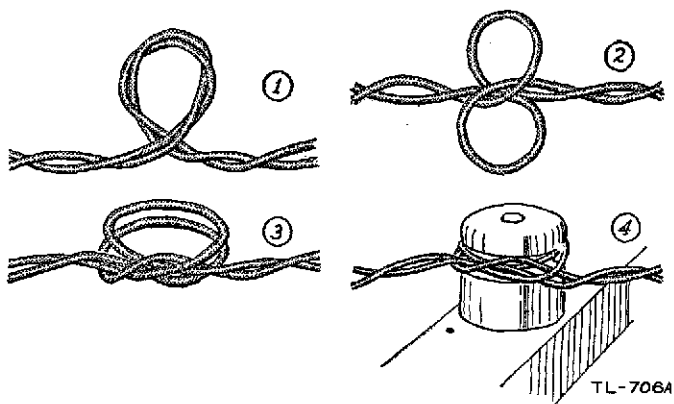

FIGURE 61.—Knob tie.

piece of marline which, when doubled, will reach from the wire in its suspended position twice around the support and down to the wire again, with about 4 inches left over for tying. Insert the ends through the loop formed in the middle of the marline and draw the marline tight around the wire as shown in figure 62①. Pass the doubled marline twice around the support and back to the wire as shown in figure 62②. Tie it securely to the wire with a double overhand knot. To tie this knot, place the marline around the wire and pass the running ends over the standing part to form a loop. Then pass the running ends down through this loop as shown in figure 62③. Draw the knot tight.

■ 189. CIRCUIT MARKING TAGS.—*a*. A field wire circuit is identified by means of the designation (par. 168) appearing on the tags tied to the wire. The tags (fig. 63) should be of rope stock or other fairly waterproof substance which will show the marks made by a soft pencil or crayon. Short lengths of soft iron wire passed through the eyelets of the tags are provided for attaching them firmly to wire lines, but in such a manner that they can easily be removed when the line is taken up. Tags are required where the wire line connects to an instrument or terminal strip, and are attached about 1 foot from these devices. They are also placed at frequent

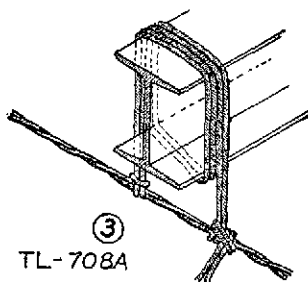
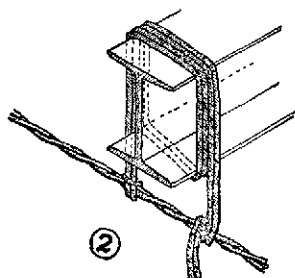
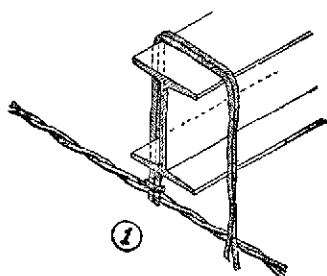

FIGURE 62.—Marline tie to a metal support.

intervals along the wire, particularly where circuits parallel each other for a long distance; at points where some circuits leave the main route; and at points where the type of construction changes, as from surface to overhead.

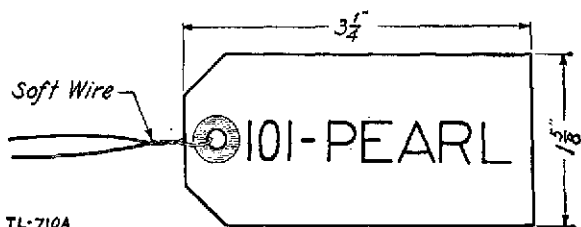

FIGURE 63.—Circuit marking tags.

b. Trunk circuits in units larger than the division are tagged with the complete designation of the circuit. In smaller wire systems, the circuit number is followed by the title of the organization constructing the circuit. Local telephone circuits are tagged with the local telephone number. Telegraph legs are tagged with their local number and the unit to which they lead, as TG-1 to 1st CT, TG-2 to 2d CT, etc.

c. Commanders will prohibit any tagging of circuits that clearly indicates to anyone unacquainted with the confidential system employed, the specific units which the circuits serve and some means of identification such as colored or partially colored tags, tags having distinctive shapes, or a code name prescribed by higher authority will be substituted. If colors are used, care must be taken that they will be identifiable at night with available light sources. An example of a wire tagging code is given in paragraph 265n.

■ 190. TERMINAL STRIPS.—*a. Description.*—A terminal strip is a block of insulating material to which are fastened several binding posts. The binding posts are connected in pairs by metal strips, so that a wire connected to a binding post on one side will be joined electrically to another wire connected to the corresponding binding post on the opposite side. The type commonly used for field wire systems is the terminal strip TM-84-A which will hold five pairs of wires (see fig. 64).

b. Connecting a wire to a terminal strip (fig. 65).—To make the connection, skin off about $\frac{1}{2}$ inch of insulation from the end of the wire to be connected. Open the slot in the binding post to its fullest extent by unscrewing the knob with the

fingers. Insert the end of the wire into the slot so that it projects through the binding post. As an alternative satisfactory method, skin off about 1 inch of insulation from the wire, leaving about 1 inch of insulation on the end, double

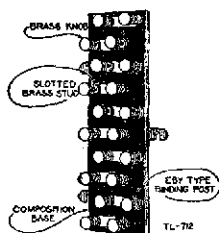

FIGURE 64.—Terminal strip TM-84-A.

the bared portion, and insert it into the slot. Tighten the knob firmly with the fingers, clamping the wires securely in the slot so that a good electrical contact is secured. Do not use pliers to tighten the knob as the threads on the binding post may strip.

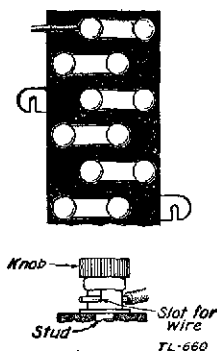

FIGURE 65.—Wire connected to terminal strip TM-84-A.

■ 191. POLE CLIMBING EQUIPMENT.—*a. Description.*—In making overhead installations the ability to climb poles and trees is necessary. The lineman's equipment TE-21 for pole climbing includes a lineman's body belt with safety strap, a pair

of climbers, pliers, ax, screw driver, splicing clamp, and a lag wrench. In addition, gloves and insulating tape may be needed.

b. Inspection.—Since the safety of a lineman when on a pole depends in part upon the condition of his equipment, all such equipment must be carefully inspected for defects prior to its use, and replaced if unsatisfactory.

(1) *Climbers.*—Climbers are examined for broken or loose gaffs, and defective straps and pads. The gaffs should be sharp and have the proper dimensions. The gaff gage TL-144 (fig. 66) is used to determine the five important gaff dimensions, which are the length along the inside surface; the

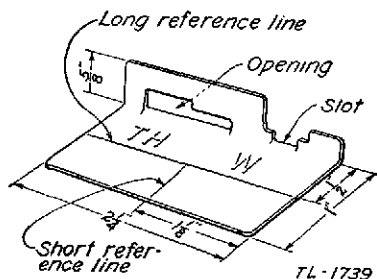

FIGURE 66.—Gaff gage TL-144.

width at distances of $\frac{1}{2}$ inch and 1 inch from the point; and the thickness at distances of $\frac{1}{2}$ inch and 1 inch from the point. These measurements are made as follows:

(a) *Length.*—Place the gage on the flat surface of the gaff with a short edge tight against the crotch. To be satisfactory, the point of the gaff must extend to or beyond the $1\frac{1}{8}$ inch short reference line at the middle of the gage.

(b) *Width.*—Place the gaff (with flat surface next to gage) first in the smaller and then in the larger of the slots marked "W", sliding the gage toward the crotch as far as it will go. To be satisfactory, the point of the gaff must not extend beyond the long reference line when in the small slot, and must not extend beyond the far edge of the gage when in the large slot.

(c) *Thickness.*—The thickness of the gaff is checked in the

same manner as the width, using the openings marked "TH."

(2) *Lineman's belt*.—The lineman's body belt and safety strap are examined before use for cracks, cuts, tears, broken stitching, worn places, loose rivets, or other defects that would be likely to affect the strength of the leather. Buckles, snaps, keepers, and D-rings should likewise be inspected for defects and wear.

c. *Care of equipment*.—(1) *Climbers*.—The gaffs of climbers are kept clean, free from rust, and sharp at all times. Sharpening is preferably done by clamping the climber in a vise and filing flat on the *inside* surface of the gaff, thereby keeping the shape of the gaff unchanged. After sharpening, the gaff dimensions are checked as described in b(1) above. Climbers when not in use are given a light coating of oil to prevent rust, and must not be stored in the same container with body belts and safety straps to avoid any possibility of cutting or puncturing the leather equipment.

(2) *Leather belts*.—The body belt, safety belt, and climber straps are kept clean, soft, and pliable by the use of saddle soap or by washing thoroughly with the lather from a neutral soap (such as castile), removing embedded dirt and perspiration, wiping dry, and finally sparingly oiling with neat's-foot oil. Mineral oil or grease should not be used for this purpose. Particular care must be taken not to subject the leather to excessive heat by standing near an open fire, hanging the belt on or near hot steam pipes, or contacting hot objects. Further instructions on the care of leather may be found in AR 30-3040.

d. *Size and adjustment*.—(1) The size of climbers is determined by the measured length in inches from the instep to the end of the leg iron. The correct size of climber to use is one measuring $\frac{1}{2}$ inch less in length than the distance from the projecting bone on the inside of the knee to the arch of the shoe of the wearer. Climbers are bent to conform to the wearer's leg so that they are comfortable, with straps fastened snugly around the calf and ankle.

(2) The D-rings of the lineman's body belt of proper size will be just behind the prominent portions of the hip bones. Wear the body belt over the hips and tightly enough not to

slip down. If right-handed, snap both ends of the safety strap to the left-hand D-ring, and if left-handed, snap the ends to the right-hand ring. The double side of the strap is snapped nearest the body and remains hooked at all times, with the keeper toward the rear. The fixed side of the strap is snapped on the outer side with the keeper toward the front. The safety strap should be adjusted to the proper length prior to climbing a pole, and this may be done as follows: Stand at the base of the pole upon which the work is to be done, and engage the gaffs of the climbers. Pass the safety strap around the pole in the manner described in paragraph 193*d* and engage the safety belt. Lean back, keeping the torso about parallel to the pole until the weight is carried by the safety strap. When the safety belt is properly adjusted, the palms of the hands will rest on the far side of the pole without overlapping.



FIGURE 67.—Lineman with equipment, front.

■ 192. POLE CLIMBING SAFEGUARDS.—*a. On the ground.*—Men wearing climbers must exercise caution at all times since gaffs will easily penetrate shoes, muscles, and bone, and are capable of making very serious wounds. Every precaution must therefore be taken to avoid stepping on the feet of personnel. *Climbers should be worn only while climbing and working on poles.* Habitually wearing climbers while working on the ground will inevitably result in serious injury to personnel. While standing on the ground, a lineman stands in the position shown in figures 67 and 68, with feet well separated and hands on hips.

b. Aloft.—While aloft, linemen always use their safety belts, not only to prevent falls but also to facilitate working with minimum fatigue. Linemen must be careful not to drop tools or other equipment while on a pole, as these objects may strike personnel working below.



FIGURE 68.—Lineman with equipment, rear.

c. *Testing poles.*—Poles which have been in service for long periods of time may be defective and are likely to break under the unbalanced loads due to climbing or working. If such a pole breaks, communication may be disrupted, matériel destroyed, and personnel injured. These poles should therefore be tested prior to climbing and temporarily supported if found to be defective. It is unnecessary to test a pole attached to a secured suspension strand, to five power wires, to a full cross arm of heavy telegraph wires, or to four-way storm guys. A suitable test for soundness is the pike pole test, which is made by applying a 16-foot pike pole at an angle of about 45° to the pole, and rocking the pole back and forth at right angles to the line. If the pole cracks or breaks, it is unsafe for climbing without temporary bracing. This can be obtained with four pike poles; by guying to trees or other sound poles; or by support from a derrick truck. The bottom of the pole is likewise secured by driving bars into the ground around the pole if the butt is broken. The pike pole test must not be applied if the pole will crush matériel in falling, and the pole should not be rocked so vigorously that the wires swing together and cause trouble to develop in the circuits on the pole. Poles which break under test are marked conspicuously as unsafe for climbing.

■ 193. CLIMBING POLES.—In the following descriptions, a right-handed lineman is assumed. A left-handed lineman performs the operations with the opposite hands and legs.

a. *General.*—In climbing a pole, keep the arms slightly bent with the hips the farthest portion of the body from the pole. To engage the gaffs, whether ascending or descending, thrust the legs inward and downward so as to obtain good penetration of the gaffs into the pole. To disengage the gaffs, the legs are moved sharply upward and outward. Place the hands on the far side of the pole. If the hands overlap, the body necessarily is too close to the pole, with danger of cutting out the gaffs and loss of footing; if the hands are on the sides of the pole, the palms have no bearing and the arms are under great strain. The weight of the body is normally carried and lifted entirely on the gaffs, the arms merely balancing the climber. If the hips are too close to the pole, the legs will be parallel to the pole and the gaffs

will cut out removing support for the climber; likewise if the hips are too far out the arms are placed under strain since they will be supporting a large portion of the climber's weight.

b. Ascending.—(1) Before climbing, circle the pole and inspect it for soundness, dangerously wide weather cracks, soft or other spots in the wood, and location of knots. Notice any cables, cross arms, or other obstructions that may interfere with climbing the pole, etc. If the pole leans, select the high side for climbing.

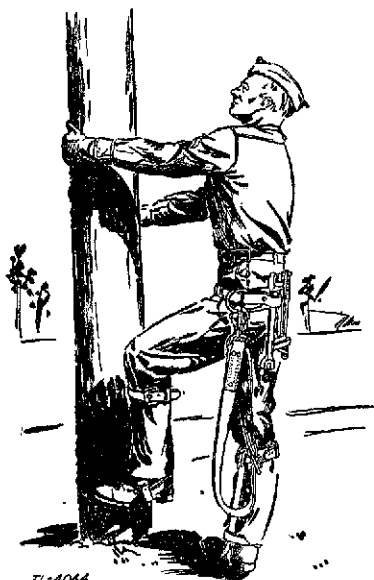

FIGURE 69.—Beginning the climb.

(2) Hold onto the pole and raise the left foot about 10 inches from the ground, keeping it about 1 inch from the pole, and with a downward thrust, engage the gaff of the climber in the face of the pole about 8 inches from the ground.

(3) Lift the weight of the body on the gaff, keeping the knees straight and raising the other leg and corresponding

arm, drive the climber downward and inward to seat the gaff firmly (fig. 70).

(4) The climber is disengaged by a sharp upward and outward motion of the leg, and in taking the next step the diagonal arm and leg are raised together.

(5) Reengage the free gaff firmly, and so on to the desired height, always looking upward.

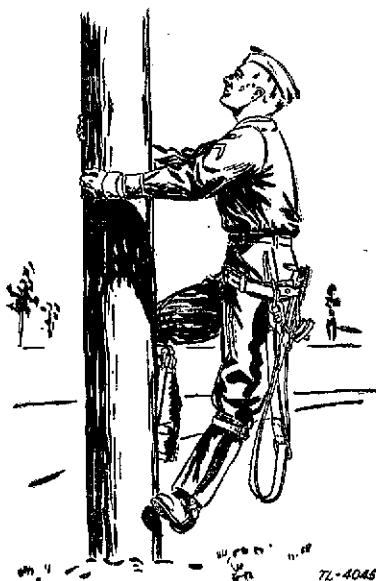

FIGURE 70.—Climbing.

c. Descending.—The motions in descending are the reverse of those used in ascending. Look down to see that the way is clear below.

d. Working on pole.—To fasten the safety belt when at the desired height on the pole—

(1) Shift the weight partially to the left foot and engage the right gaff at a slightly higher level than the left gaff.

(2) Place the right hand around the pole for secure balance

(fig. 71), and with the thumb of the left hand, open the keeper and shift the fixed end of the safety strap around the pole to the right hand.

(3) Transfer the snaphook and strap to the right hand, and balance the body with the left hand (fig. 72).

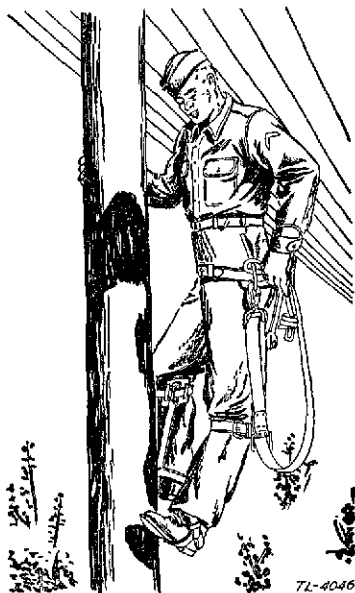

FIGURE 71.—Unhooking safety belt.

(4) Hold the strap up loosely on the pole at about the proper height while the right hand pulls the belt to the right-hand D-ring.

(5) Snap the hook to the right-hand D-ring, using the heel of the right hand to back up the ring. *It is essential to SEE that the ring is properly engaged, and not merely to assume from the snap of the keeper that the D-ring has been engaged by the hook.* (See fig. 73.)

(6) Reengage the right gaff at the same level as the left gaff, lean back and carefully put the full weight on the safety

belt, keeping the hands firmly gripped about the safety belt until it has been tested (fig. 74). To unfasten the belt, the reverse motions are carried out:

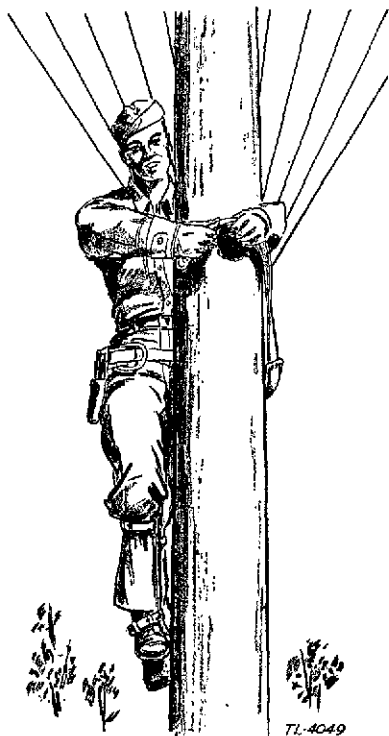

FIGURE 72.—Transferring belt to right hand.

(a) Move the right gaff up and reengage it at a slightly higher level than the left gaff.

(b) With the right elbow up, hand twisted, thumb downward, depress the latch and disengage the snaphook from the right-hand D-ring.

(c) Pass the belt around the pole to the left hand, balancing the body with the right hand.

(d) Snap the hook to the left-hand D-ring with a single move downward.

(7) Beginners should perform these operations near the ground until sufficient practice has been attained to pass the belt around the pole with speed and precision, before performing the same operation aloft. While working at the

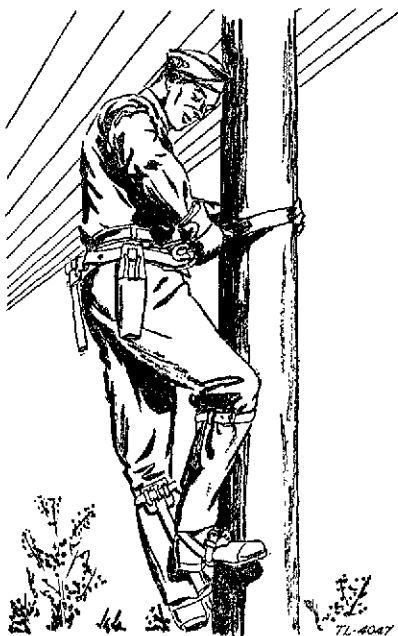

FIGURE 73.—Snapping hook on D-ring.

top of a pole, the safety belt is never placed above the cross arm nor within less than 6 inches of the top. If the outer wires of a cross arm are to be reached, hook the safety belt just below the cross arm. Thrust the body through the conductors so that the head and shoulders are above the level of the arm (fig. 75). To shift one's position around a pole and yet remain at a constant height with the safety belt

fastened, take 2- or 3-inch steps sideward in the desired direction, twisting the hips slightly in the belt each time so as to obtain the necessary slack.

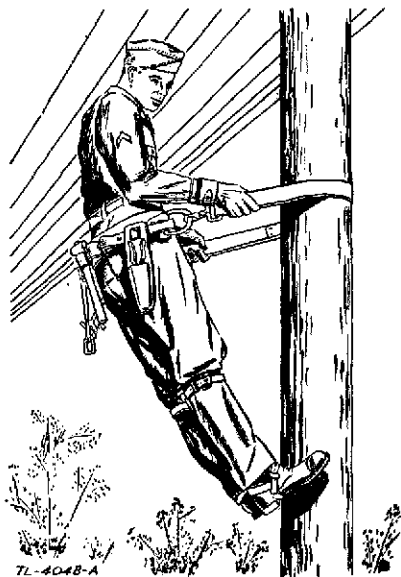

FIGURE 74.—Testing the safety belt.

■ 194. WIRE-LAYING EQUIPMENT.—Field wire is carried forward and laid by motor trucks or other vehicles, or animals, carrying reel units; by hand-drawn or towed reel carts; by reels on axles carried by hand; and from bundles or coils carried by hand. The actual method employed depends upon the equipment available, the condition of the roads and terrain, the amount of traffic, and the tactical situation. For descriptions of specific apparatus employed, see appendix I.

■ 195. PROTECTION OF WIRE.—Immediately after wire has been laid, it should be removed from the path of vehicles or traffic in order to protect it and insure its continued use. If the wire-laying device does not otherwise lay the wire in a

safe place, it must be followed by personnel who place the wire in the desired position by hand, by the use of wire pikes, or other expedients.



FIGURE 75.—Working on outer wire of cross arm.

■ 196. RECOVERY OF WIRE.—In the recovery of wire, the recovering equipment should be preceded by linemen, who remove all tags, and with a wire pike or by hand place the wire back in the path of the recovering equipment. Leather gloves or pads should ordinarily be used for protection while handling field wire. The normal way to recover wire is to proceed along the line and wind up the wire en route. Under some conditions it may be necessary to leave the recovering equipment stationary and drag in the wire by turning the

reel. This causes more wear on the insulation and may cause the wire to break.

■ 197. **ROUTING OF WIRE LINES.**—*a.* The signal or communication officer prescribes the general route to be followed. The chief of construction should be allowed considerable latitude in the selection of the actual route to provide for unforeseen terrain conditions. Routes must be reconnoitered before wire lines are laid. Cross-country routes are desirable to minimize interruptions resulting from bombs, shell fire, and traffic.

b. Maintenance is facilitated by using the minimum number of routes. However, vulnerability of the lines is likely to be increased, and complete interruption of wire communication may result unless the route is particularly well chosen. In general, where more than one circuit is to be laid to a unit, vulnerability may be decreased and circuit continuity better insured if an alternate route is used for the additional circuit. The route or routes selected are determined largely by the time element and the wire-laying equipment available, but should afford cover from hostile observation and fire. Main traffic routes, shelled areas, and areas over which tanks or tractors are likely to pass should be avoided wherever practicable. It is also desirable that lines should be routed to permit use by the same or another friendly unit after the movement of command posts.

■ 198. **CONSTRUCTION ORDERS.**—*a.* The chief of construction is given orders prescribing the number of circuits to be installed, the priority of installation, the time at which each of the various circuits must be completed, and the action to be taken upon the completion of the installation. He should receive or obtain the following descriptive information relative to each circuit to be laid:

- (1) Circuit number.
- (2) Route.
- (3) Whether a trunk or a local circuit.
- (4) Whether a metallic or a ground return circuit.
- (5) Type of wire.
- (6) The centrals which it will connect and test stations it

will pass through, including the telephone directory names of the organizations served.

(7) Approximate length.

(8) Type of construction.

(9) Nature of roads and terrain.

(10) Precautions to avoid damage by friendly troops and transportation.

(11) Tests and reports required.

b. This information is best imparted by use of a line route map and circuit diagram supplemented by oral or written instructions from the signal or communication officer. These instructions always include orders as to the disposition of the construction detail after the construction specified has been completed.

■ 199. PROCEDURE IN LAYING FIELD WIRE.—*a.* The construction chief makes a personal reconnaissance of available routes before starting the construction. During this reconnaissance the following features of the routes are noted:

(1) Number of overhead crossings.

(2) Number of underground crossings.

(3) Number of railroad crossings.

(4) Number of stream crossings.

(5) Types of roads found and the wire-laying equipment and type of construction best adapted to each.

(6) Distances in miles.

(7) Concealment for wire parties during construction and subsequent maintenance.

(8) Any obstacles to maintenance.

(9) Alternate routes to avoid gassed or shelled areas or other unfavorable road conditions.

b. The exact route along which the wire is to be laid which offers the least difficulty of construction and maintenance are then selected.

c. The wire for the circuits is tested before starting to insure the continuity of each reel. Reels of wire which do not show a continuous circuit when tested are not used until the wire has been serviced (par. 242).

d. At the starting point, the free end of the wire is tagged with the circuit designation (par. 189). This tag is placed a foot from the end of the wire.

e. Sufficient wire is left at the free end to reach the switchboard terminal strip or other installation, and the wire is tied in to some fixed object.

f. The free end of the wire is connected to the switchboard terminal strip if installed. If a switchboard is to be installed later, the wire is connected to a telephone or other instrument which may be used in making tests on the circuit until the switchboard has been installed.

g. The chief of construction then directs the laying of wire over the detailed route, determined as in *b* above, following the general route prescribed by the signal or communication officer (par. 197). He causes a test to be made back to the starting point from the far side of each splice after it is made in order to insure continuity of the circuit. When connections are made at terminal strips he causes a test to be made from the far side of the connection back to the starting point.

h. When the wire has been laid to the designated point, it is tied in and tagged, leaving a free end with sufficient slack to run to the switchboard terminal strip. The circuit is then tested and turned over to the operating detail who connect it to the switchboard terminal strip or to an instrument. The chief of construction calls back over the completed circuit to report the installation. This call is placed through the switchboard or other instrument if installed, so that any fault in the terminal connections may be discovered and corrected before the circuit is reported.

i. Should the wire be laid to any location where a switching central is to be installed, but where the operating detail or the equipment for the installation has not yet arrived, the chief of construction calls back over the circuit in order to verify his proper location and to ask for instructions. In the absence of other instructions, the construction chief leaves a member of the construction detail at the wire terminal with a telephone connected to one circuit. This member informs the arriving personnel of the location of the circuits and assists in making the terminal connections. After the terminal apparatus has been connected, he makes a test back and reports over each circuit. Sufficient slack is left at these terminals to permit extending the circuits to the probable

location of the central to be selected by the operating detail upon arrival.

■ 200. CONSTRUCTION AND REMOVAL OF TEST STATIONS (pars. 174 and 239).—*a. Construction.*—The site selected should afford cover from hostile observation and fire and protection from friendly troop movements, and should be accessible for testing. A station consists of one or more terminal strips fastened to a support such as a tree or fence post. The wire circuits are tagged and tied in before being connected to the binding posts. Each of any two circuits connected together at a test station is attached to opposite pairs of binding posts as shown in figure 76. Paired circuits are connected beginning at the top. A telephone or other suitable instrument

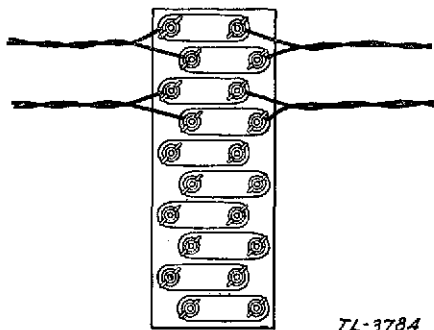

FIGURE 76.—Test station constructed during initial installation of wire lines.

may be connected to the designated test circuit as prescribed in paragraph 239. A test station may be installed after initial installation of wire lines without interrupting any possible conversation on the circuit by pulling in the desired slack and tying in near the terminal strip, stripping the insulation from each wire to permit connecting it to binding posts on opposite sides of the terminal strip, and removing the loop in the wire between binding posts by cutting close to the binding posts. (See fig. 77.) Cut in other circuits to the test station terminal strip in a like manner. Beginning at the top with the lowest numbered circuit, cut in circuits in numerical order.

b. Removal.—When a test station is to be abandoned, it is the usual practice to leave the terminal strip connected, although it may be removed and the circuits spliced through. Before removing any circuit from the strip, the lineman first listens on it and satisfies himself that it is not in use. He then calls on the circuit and notifies the switchboard operator that the test station is to be removed and the circuits cut through. Then, taking two wires that are connected together by the terminal strip, he removes them from the binding posts and splices them together. The other wires of the pair are then spliced, and other circuits are removed from the strip and spliced in a like manner.

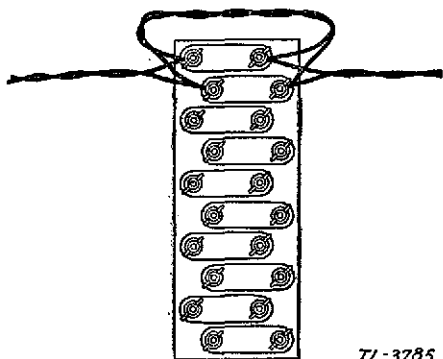
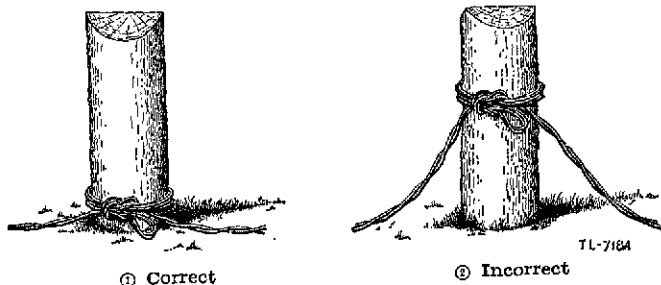

FIGURE 77.—Test station constructed after initial installation of wire lines.

■ 201. SURFACE LINE CONSTRUCTION.—During movement of units in combat, field wire lines are laid hastily on the ground. This type of wire line is termed a surface line. Surface lines must be protected from traffic at command posts, road and railroad crossings, or other places where the lines cross traffic lanes (par. 209*d*). Surface lines are laid very loosely by leaving abundant distributed slack in order that the wire may be flat on the ground and sufficient slack provided as incidental protection from shell fire, for repairing breaks and facilitating subsequent changes in the type of construction. At suitable intervals, surface lines are tied in to ob-

jects such as trees or posts in order to leave sufficient slack and to prevent passing troops and vehicles from pulling the wire into traffic lanes. The wire is tied to the tree or post at ground level (see fig. 78). When surface lines are routed along a road, the wires *must* be kept off the traffic lane. If the road curves in one general direction, the line should, if practicable, be routed along the inside edge of the road. Otherwise, many ties on the outside edge become necessary. Advantage should be taken of objects such as trees or posts along a curve in the road to prevent the wires from being pulled into the traffic lane.



① Correct
② Incorrect
FIGURE 78.—Method of tying wire at ground level.

Connections between surface lines and pole lines are preferably made at existing terminals of the pole line. If such terminals are not conveniently located, a test station may be established. When surface lines connect with overhead construction, the surface line must be securely tied and tagged at the base of the pole at which the connection is made, and tied again just above the cross arm or terminal where the connection is to be made. Connections to aerial or buried cables are made only at standard cable terminals.

a. *Advantages.*—(1) Surface lines require minimum time for installation.

(2) When loosely laid, they are less vulnerable to artillery fire than are other types of construction.

b. *Disadvantages.*—(1) Surface lines may become unserviceable in wet weather due to leakage to ground.

(2) They are often broken by passing troops and transport.

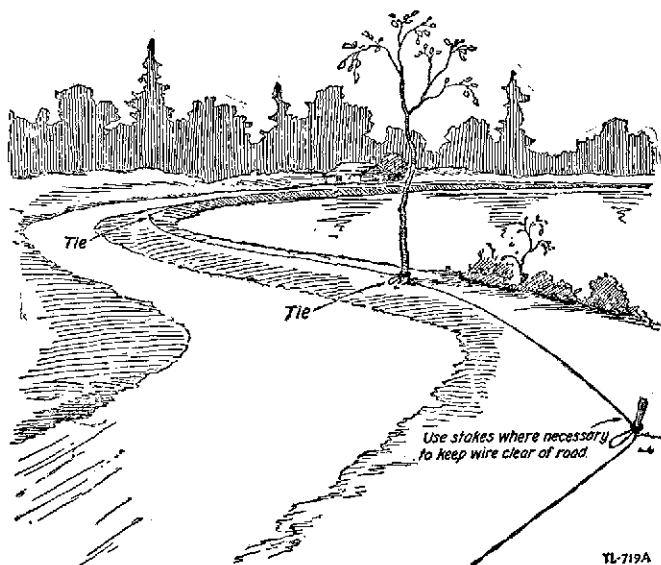

FIGURE 79.—Method of tying wire along curve in road.

■ 202. OVERHEAD CONSTRUCTION.—*a.* Field wire lines should be placed overhead near command posts, test stations, and along roadways at points where traffic is likely to be diverted from the roads by tying the wire to trees or existing poles 14 feet above the ground using standard field wire ties. At junctions between overhead and surface line construction, the wires are tied securely to the bottom of the support and tagged there (see fig. 80). Test stations should be installed generally at the junctions of long overhead lines with other types of construction.

b. Lance poles are convenient means for supporting field wires in overhead construction, particularly where trees, poles, and other like supports are not available. When a field wire line crosses a secondary road, a guyed lance pole on each side of the road usually provides adequate clearance (par. 203*b*). The required 18-foot road clearance on main roads may be obtained by lashing two lance poles together.

When necessary, lance poles may be supported by lashing them to fence posts and tree stumps, and in rocky terrain by piling heavy rocks around the bases of the poles. Field lines of themselves often provide sufficient guying for the lance pole. An H-frame composed of two lance poles set parallel to one another 3 feet apart, with a horizontal arm of 1- by 2-inch lumber fastened at the upper end of the poles, provides an excellent overhead support for a large number of field wires. Guying of the frame in both directions perpendicularly to the line is usually required.

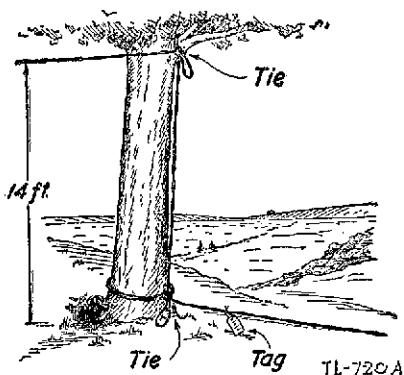

FIGURE 80.—Method of tying wire at junction of surface line with overhead construction.

■ 203. ROAD CROSSINGS.—*a.* Where a road crossing is necessary, field wire lines should cross through a culvert if possible. The wires are passed through the culvert, tagged, and tied at the entrance and exit to prevent contact with water. (See fig. 81.)

b. Wires which must cross roads overhead must clear the crown of main traffic arteries and paved roads by at least 18 feet, and of other roads by at least 14 feet. When a surface line crosses a road on poles or other objects, the wire is tied at the base and at the top of the object on each side of the road and tagged at the base. The strain which occurs along the line is met by the tie at the base. (See fig. 82.)

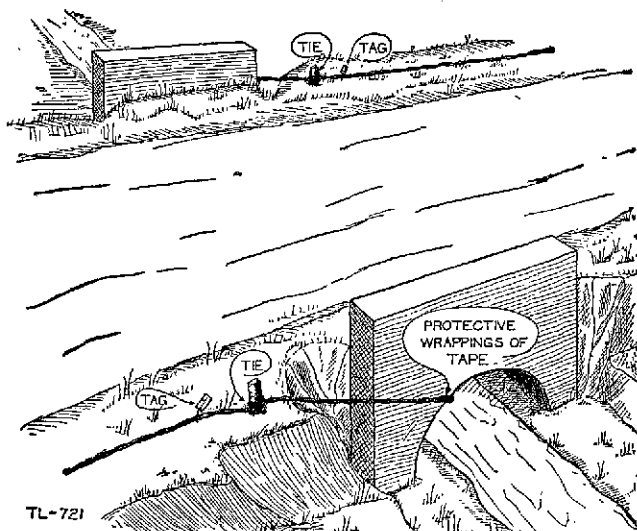

FIGURE 81.—Wire crossing road through culvert.

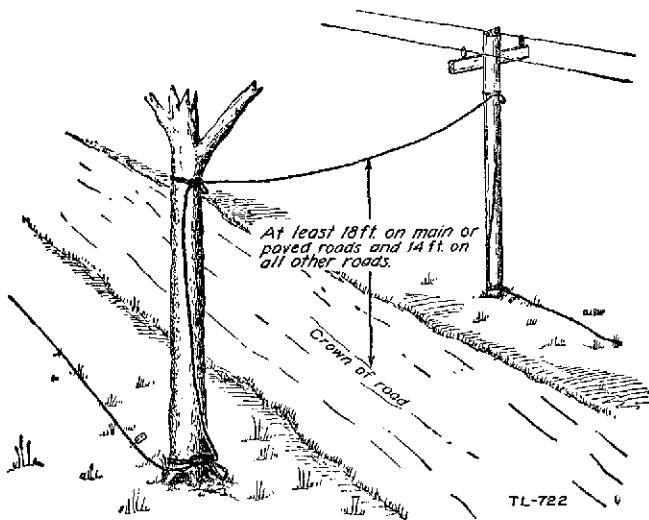

FIGURE 82.—Wire crossing road overhead.

c. If neither of the above methods can be used, the wires are buried in a trench crossing the road at right angles. The wires are laid snug, tagged, and tied to a stake at each end of the trench to prevent their being pulled out. A sufficient amount of slack wire is left at one side of the road to permit replacement of the section under the road, should it become worn or water-soaked. (See fig. 83.)

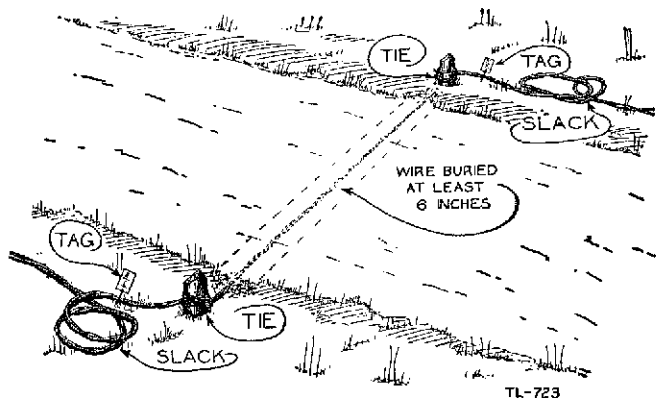

FIGURE 83.—Wire crossing under road in trench.

d. Where a hard surfaced road *must* be crossed and none of the above methods is applicable, then as a *last resort*, the wire obviously must be laid on the road. Protection of the wire in this emergency method is primarily one of reducing the risks involved.

(1) The smoothest section of road available should be selected.

(2) Substitute a length of twisted wire for *each* side of the circuit crossing the road.

(3) The wire should be laid without slack, tied and tagged on each side of the road surface.

(4) These parallel crossings should be separated by more than the length of the longest vehicle which will cross.

(5) Keep an exact record of such cases and inspect frequently.

■ 204. RAILROAD CROSSINGS.—Railroad yards should be avoided. If a bridge or culvert is available, it should be used

in making the crossing even if this requires paralleling the tracks with the wire for some distance in order to reach it. If a bridge or culvert is not available, field wire lines should cross railroad tracks *under* the rails. (See fig. 84.) In making the crossing, the wires are pulled tight and buried outside the rails to a point beyond the shoulders or improved strip along the tracks, and secured on both sides to prevent them from being pulled out and becoming a hazard to trainmen walking along the tracks. Field wire lines should *never cross overhead*, as to do so endangers trainmen on top of railroad cars.

■ 205. RIVER CROSSINGS.—*a. Overhead.*—Small stream crossings are made in the same manner as overhead road crossings, except that the wires need be only high enough to clear the water-borne traffic. A span of more than 150 feet should not contain a splice. Long spans up to 250 feet can be made with field wire, but special construction is necessary for resisting the strain.

b. Submerged.—When field wire lines must cross bodies of water such as rivers where it is impracticable to make overhead crossings, the wire should be submerged. The wire is tied in securely on the near bank, laid by paying out from a reel or coil, and tied in securely on the far bank. The ties are made above the highest level reached by the water. The insulation on the wire should be sound. Splices should be made only if absolutely necessary and should be made as waterproof as possible. If the current in the stream is strong, or if the stream is navigable, the wire is weighted at suitable intervals to keep it submerged to the full depth and to retard its movement by the current. The amount of wire necessary for the crossing is carefully computed and the wire prepared in advance so as to avoid splicing the wire in midstream.

■ 206. TRENCH LINE CONSTRUCTION.—In position defense, field wire lines are often installed in trenches, two kinds being generally used—wire trenches constructed specifically for that purpose, and trenches primarily intended for other purposes, such as fire or communication. Trench wire lines are tagged at intervals of not more than 150 feet and at junctions with other lines.

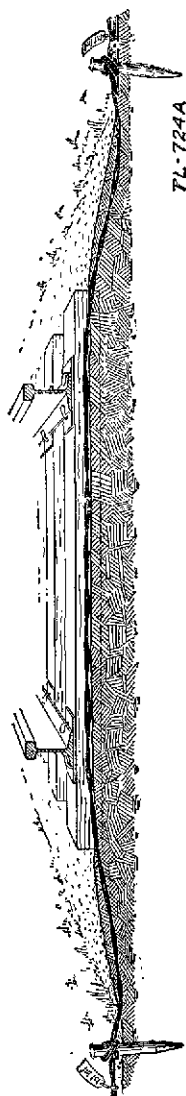

FIGURE 84.—Wire crossing under railroad track.

a. Wire trenches (fig. 85).—(1) Wire trenches vary in size from 10 inches wide by 10 inches deep to 36 inches wide by 30 inches deep. They afford considerable protection from shell fire but offer an obstacle to friendly traffic. The wire may be fastened to cross arms which are attached horizontally to short poles or rest against or project into the sides of the trench. Instead of using cross arms the wire may be fastened to the sides of vertical poles. Field wire may be tied directly to these supports with wire or marline, but it is preferable to tie the wire to wooden or porcelain knobs or insulators.

(2) The wire trench route should be chosen with a view to concealment, cover, and ease of construction. The number of trenches is kept to a minimum, and the wire is kept in the main trunk-line trenches as much as practicable. Switching centrals may be installed at important trench junctions.

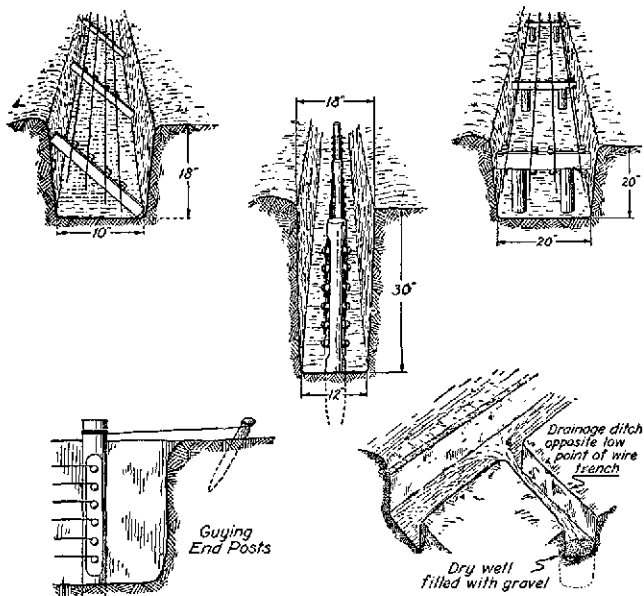

FIGURE 85.—Wire trench construction.

TL-592A

(3) In digging the trench, the workers are divided into groups of two men, each group equipped with a pick and shovel. Two men can dig from 15 to 35 lineal yards of trench per day in good ground, depending on the type of trench.

(4) Trench posts are set in the ground at intervals of from 15 to 25 feet. They are guyed at turns and at the ends of the line. When fastening wire to vertical poles, insulators may be nailed on opposite side of each pole. As many as 14 twisted pairs can be carried on a single pole line of this type in a trench about 30 inches deep. A liberal allowance of wire should be made for sag.

(5) Trench lines may be terminated by running directly into a switching central or test station or connecting to some other type of construction.

(6) When necessary to cross a road with a wire trench, the line should preferably be placed in a buried conduit of wood, clay, or iron, or passed through a culvert if available. If this is impracticable, the wires should be carried overhead on poles.

b. Fire or communication trenches (fig. 86).—(1) When it is impracticable to construct wire trenches, field wire may be installed temporarily in fire or communication trenches. Due to the great use made of these trenches by combat troops, they are not satisfactory for permanent wire installations.

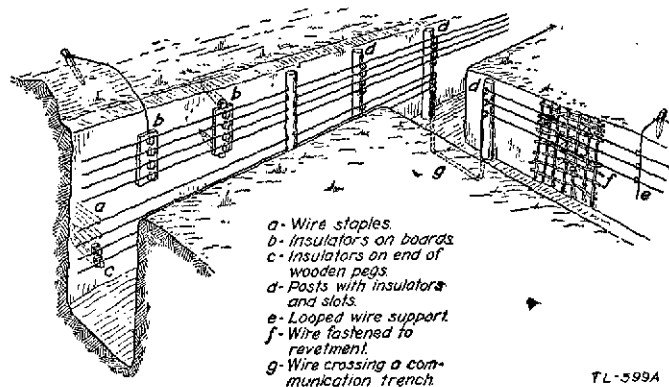

TL-599A

FIGURE 86.—Wire line construction in communication trenches.

(2) Except in narrow fire trenches, wire lines should be kept ordinarily on the side of the trench nearest the enemy. Wire placed at heights between 10 and 30 inches from the duck boards or bottom of the trench is least subject to damage from cave-ins, water, and traffic.

(3) Field wire may be fastened to the side of a trench, as shown in the composite figure 86, by—

(a) Staples made of stiff wire and about 12 inches long. The staples are driven into the ground as far as possible, thus holding the wire closely against the side of the trench.

(b) Attaching the wire to insulators mounted on boards fastened to the sides of the trench by wire, stakes, rods, or staples.

(c) Attaching the wire to insulators nailed to the ends of wooden stakes or pegs which are driven into the trench wall.

(d) Attaching the wire to insulators nailed to posts driven into the bottom of the trench close to the side.

(e) Passing the wire through supports made of No. 9 or heavier galvanized iron wire. One end of the support wire is attached to a stake driven into the ground just outside the edge of the trench.

(f) Attaching the wire to revetment posts, either directly or on insulators.

■ 207. LOADING OF FIELD WIRE LINES.—*a. Purpose.*—Telephone transmission over long field wire circuits may be improved by the use of loading coils which add inductance to the line neutralizing the effect of the capacitance of the wire. An increase of about 30 percent in the maximum length of line for satisfactory transmission may be obtained. Lines less than 10 miles in length are usually satisfactory without the use of the coils.

b. Description of coil C-114 (loading).—The coil C-114 is contained in a watertight aluminum alloy case and weighs about 2 pounds. The cover is hinged along one side and is held closed by a latch, a rubber gasket making a watertight seal. The line wires are connected by opening the cover and inserting the wires in the slots of the four binding posts. The head of each binding post contains a steel pin, so that when it is screwed down the pin is driven through the insulation and makes contact with the conductor. When the cover

is closed, the line wires come out through grooves in the rubber gasket opposite the binding posts. (See fig. 87.)

c. *Spacing.*—The loading coils are designed to be installed at intervals of 1 mile in wire W-110 and W-110-B. The distance between one terminal of a circuit and the first coil, or the distance between the other terminal and the last coil, is known as an end section. The length of this section must be at least 0.2 mile but not over 1 mile. The spacing of the coils between the end sections should not deviate more than plus or minus 5 percent from 1 mile.

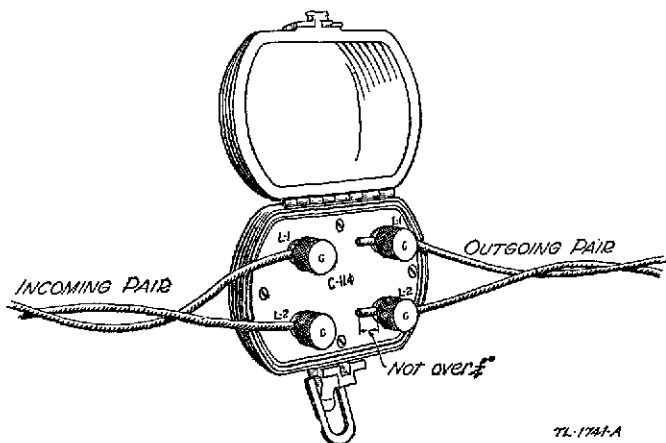

FIGURE 87.—Method of connecting loading coil C-114 in field wire line.

d. *Installation.*—The coil is installed in a circuit by connecting the field wire from one direction to the two adjacent binding posts marked L_1 and L_2 at one end of the coil, and the field wire from the other direction to the two remaining binding posts marked in a similar manner. The wires should be cut but not skinned when making connections to the terminals, nor should the inside ends of the wires extend more than $\frac{1}{4}$ inch from the terminals after connections are completed. All four wires must fit snugly into the grooves in the rubber gasket. All strain should be taken off the coil

connections in order to avoid damage to the coil and reduction in the tensile strength of the line.

■ 208. EXPEDIENTS.—*a.* Many units have found that at higher headquarters some central point, other than the switchboard, is an advantageous one from which to control wire crews in action and make tests on trunks or long locals. Such an installation removes these duties from switchboard personnel, thus increasing their efficiency. It could be located at the edge of the command post where all the long lines from the front are arranged to come together upon entering the command post area. It is called a "construction center." The size and amount of equipment thereat may vary widely from a terminal strip and telephone with test leads to the inclusion of a test switchboard and test set. However, if such a center is established, only available standard equipment should be used and so installed as to be readily removed or disassembled. Figure 88 shows one such construction center temporarily installed in a trailer. Figure 89 is a suggested circuit diagram for such an installation which might be found at a division headquarters. The equipment is, by improvisation, installed on one side of the trailer and is operated by an enlisted construction chief. The diagram shows all incoming trunks and long locals terminating at a terminal strip. From this strip the circuits when completed and serviceable are taken directly through another terminal strip to the switchboard. By the use of test clips, jumper wires, or improvised switches the circuit may, instead of going direct to the switchboard, be switched to a test telephone switchboard affording a lineman or construction crew working on the line an opportunity to call the construction chief for a test, additional instructions, or to report his progress. The switchboard gives the construction chief, by the use of his operator's phone or set, access to any of his long lines. If desired, the test set leads may be equipped with a spare switchboard plug. Thus he may quickly connect his test set to any line by the insertion of the test set plug into the switchboard jack to which such line is connected. The trailer shown in figure 88 may normally be used to transport communication equipment.

b. It has been found that laying field wire from a truck can be accelerated by the use of an improvised, laterally and

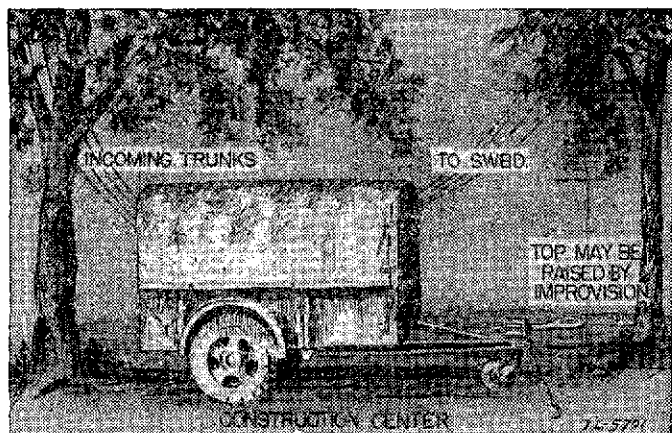

FIGURE 88.—External view of the suggested construction center for larger units.

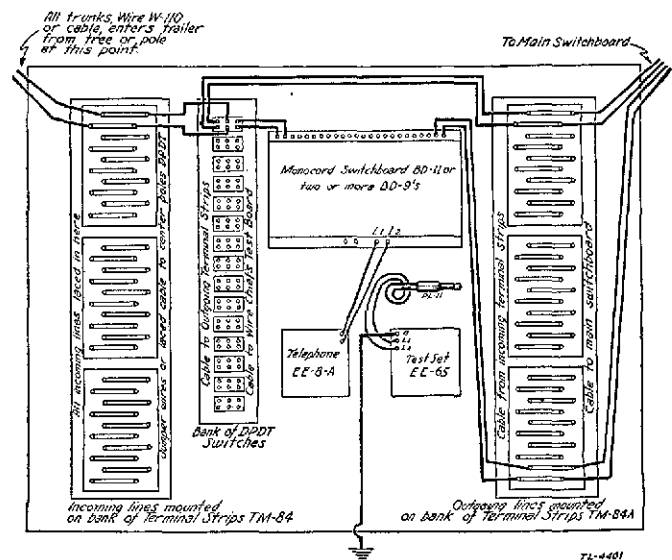

FIGURE 89.—Wiring diagram for the suggested construction center.

vertically adjustable, wire boom. Its efficiency is greatly dependent upon a trained crew as, at first, the speed and distribution of slack attained is likely to be discouraging. This boom, attached to a truck in which a reel unit RL-26 or RL-31 has been mounted, is so equipped as to lay two circuits simultaneously and at such a horizontal angle that the wire falls well off the road. This initially affords protection of the wire from traffic but does not eliminate the necessity for subsequently inspecting and servicing the completed line for slack, ties, tags, and additional circuit protection. Overhead crossings, tying, underground crossings, and occasional accumulations of slack may be secured by leaving behind one or more linemen and sufficient slack wire to perform the mission. As circuit establishment speed is paramount, this causes the wire layer minimum delay. A tender vehicle, such as $\frac{1}{4}$ -ton truck, following the wire layer would pick up the lineman left behind and quickly shuttle him forward to rejoin the wire layer. The lateral position of the wire boom is adjusted by one guy line and the vertical by another. Two men on the alert in the wire layer operate the guy lines to prevent the boom from striking obstacles passed such as trees, posts, and heavy brush. When not so engaged they assist the reelman. One suggested plan of boom construction is illustrated in figure 90. Other types or improvements may be suggested by use and experience. In operation, the wires from the reel drums are threaded through the sheaves shown and after the reel wire drums and truck attain momentum the wire feeds out. Additional slack is attained by momentarily decreasing the truck speed but permitting the reel drums to run freely. When the truck stops, the reel drum brake must be applied by the reelman. It is suggested the truck speed be controlled by telephone or by the reelman blowing whistle blasts such as—

One blast—stop

Two blasts—go or faster if underway

Three blasts—slower speed

Wire has been satisfactorily laid with this boom at an all inclusive rate of from 8 to 14 miles per hour.

c. The use of such expedients to increase efficiency by

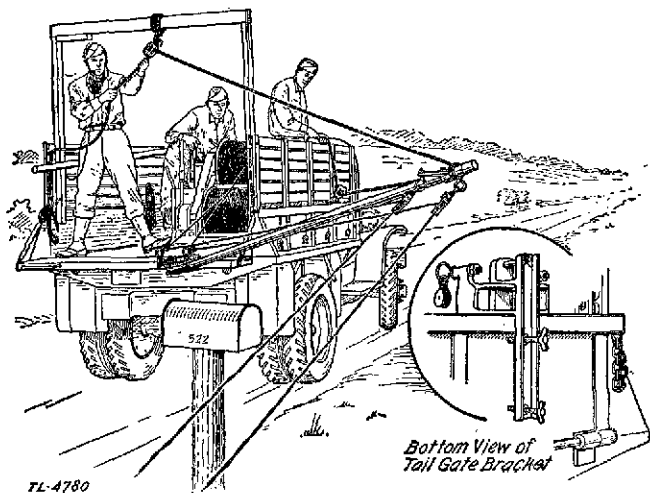

FIGURE 90.—One suggested form of wire boom.

permitting earlier establishment of communication is encouraged but is not directed and should not be taken as a basis of converting transportation solely to this use.

SECTION III

FIELD TELEPHONES AND CENTRALS

■ 209. INSTALLATION OF SWITCHING CENTRALS.—*a.* Installation of a field switching central includes installing the switchboard and its auxiliary equipment, terminal strips if required, and testing equipment if available. It also includes the installation of local circuits and telephones (except long locals), and making the proper connections at the switchboard terminal strip between these circuits and the trunk circuits turned over by construction details.

b. Each circuit is tested as soon as it is connected, and when it is in satisfactory operative condition the time is recorded and the message center is informed of the available service. A traffic diagram (see par. 223) is prepared

and posted at the switchboard together with a copy of the telephone directory for the use of the operator.

c. Trunk circuits available before they can be connected to the switchboard, are connected directly to telephones to give temporary service until the switchboard is installed.

d. After the switching central is installed and operating, circuits should be rearranged for their better protection and to facilitate maintenance. Care is taken that circuits radiating from a switching central are not subject to interference from troops and traffic in the vicinity of the command post. They are placed overhead or underground.

e. Priority in which local telephones are installed at a command post varies with the situation and the orders of the commander. They are normally installed in the following order:

- (1) Message center.
- (2) Commander (or chief of staff or executive).
- (3) Operations section (G-3 or S-3).
- (4) Intelligence section (G-2 or S-2).
- (5) Supply section (G-4 or S-4).
- (6) Signal section (signal officer).
- (7) Personnel section (G-1 or S-1).
- (8) Public telephone for personnel not furnished individual telephones. (Installed convenient to staff personnel and well marked as the public telephone.)
- (9) Other staff officers and activities as required.

f. At command posts of small units, as in battalions or regiments, one telephone ordinarily serves two or more staff officers. At larger headquarters, more than one telephone may be required in each staff section. At all echelons, telephones are reduced to minimum requirements.

■ 210. INSTALLATION OF TELEPHONE SWITCHBOARDS.—A field switching central may include one or more switchboards, depending on the number of trunk and local circuits to be installed. With certain types of switchboards it is necessary to install terminal strips; with others, the terminal strips and repeating coils are self-contained in the switchboard itself. The switchboard and its associated equipment are installed in a centrally located place affording as much shelter

and freedom from noise or interference as possible, and concealed from observation.

■ 211. CARE AND PROTECTION OF FIELD TELEPHONE EQUIPMENT.—*a. Care.*—After use, no equipment containing batteries will be temporarily stored until all batteries therein have been removed. If batteries are not removed, corrosion will take place and the equipment eventually will be damaged. Do not allow dirt to accumulate on any part of the equipment. Keep terminals and contacts particularly clean. Keep all mounting screws and wire connections tight. Protect the equipment from the elements as far as practicable when installed, and place it in a cool, dry place when stored. Do not attempt field repairs beyond the replacement of batteries, the replacement of broken or defective elements or parts which can be properly replaced with tools issued, and the checking and repair of loose or broken connections.

b. Protecting equipment against enemy capture.—(1) In general, smaller items of equipment can be carried off by personnel. Each soldier should be trained to carry off smaller items of equipment when danger of enemy capture exists.

(2) If the equipment is too heavy to be carried off, it should be destroyed as thoroughly as time permits. (See par. 14.)

■ 212. INSTALLATION OF TELEPHONES.—Both common battery and local battery telephones are used in field wire systems, often in the same installation; within divisions, however, the instruments are usually local battery (magneto). Telephones should be installed in a position convenient to the user, with the field wire connection tied in near the instrument, leaving sufficient slack between the tie and the instrument to permit some movement of the telephone. If the circuit enters the place of installation from overhead, a drip loop is inserted to drain water away from the instrument (see fig. 56). If the telephone is strapped to a tree trunk or tent pole, tie down the instrument firmly with a short length of field wire in a manner providing easy access to the handset and generator crank. Attach to each telephone the telephone directory referred to in paragraph 175 and a tag bearing the directory name and number of that telephone.

When an installation has been tested and is completed, the user is immediately informed of that fact.

■ **213. TYPES OF FIELD TELEPHONES.**—The field type telephones in common use are the EE-8-A, EE-8, EE-5, and EE-3B. These instruments have common operating characteristics but vary in details of construction. (See par. 2, app. I, for descriptions.)

■ **214. TESTING FIELD TELEPHONES.**—A field telephone must perform two distinct functions: Signaling of the distant and local party, and transmission and reception of speech. Separate apparatus and circuits are provided for both functions, properly interconnected to the single pair of field wires. The simplest and most comprehensive field test of a telephone is to connect an instrument known to be satisfactory to the telephone under test by means of a short line. If both telephones can be signaled satisfactorily, and if speech can be transmitted intelligibly without effort, the telephone under test is in an operative condition. If the telephone is not serviceable, or if more specific tests as described below fail, the telephone should be turned in for repair.

a. Test of signaling circuits.—The magneto or hand-operated generator furnishes signaling currents for the telephone. It should turn freely when not connected to a line. Short-circuiting the line binding posts should produce a definite drag on the crank. The internal ringer or buzzer is tested by connecting the telephone to another serviceable telephone and cranking the generator of the latter. The ringer or buzzer of the field telephone under test should respond energetically.

b. Test of speech circuits.—Field-type telephones require a suitable battery for speech transmission when used on local or common battery systems (sound-powered telephones are exceptions). Brighten the spring or clip terminals in the battery compartment if inspection discloses they are corroded. Place a new dry-cell battery of proper type in the compartment. Blowing into the transmitter of telephones EE-8-A and EE-8 should produce an audible sound (side-tone) in the receiver when the handset button or switch is operated. In the telephones EE-5 and EE-3B, short-circuit

the line terminals to complete the voice circuits, and depress the handset button of the EE-5 during the test. Presence of sidetone indicates that the voice circuits are functioning properly and that the battery is serviceable. Blowing into the transmitter of handset TS-10 should produce an audible sound (sidetone) in the receiver, indicating that the handset is in operative condition.

■ 215. REPEATING COILS.—*a. Types.*—Repeating coils are used in field wire systems for the construction of simplex and phantom circuits for additional telegraph, teletypewriter, or telephone channels. They consist of two windings on a magnetic core, carefully balanced to prevent crosstalk. The ends of one winding are brought out to two terminals marked LINE which are connected to the incoming wire line. The ends of the other winding are brought out to two terminals marked SWITCHBOARD which are connected to the switchboard line terminals. The midpoint of the line side of the coil is brought out to a fifth terminal marked TELEG, which can be connected to provide a simplex or a phantom circuit as explained in paragraphs 216 and 217.

(1) *Military.*—The coils commonly issued for use in the field are the coil C-75 and the coil C-161 (fig. 91). These are similar in electrical characteristics, but the coil C-161 is more efficient, smaller and lighter, and is also used in switchboards BD-72 and BD-71.

(2) *Commercial.*—Commercial repeating coils of the type illustrated in figure 92 may be issued. These have windings brought out to soldering terminals numbered 1 to 8. Prior to being taken into the field, these coils should be mounted on a wood base and wired to five binding posts lettered as shown in figure 92. The connections are made with insulated wire soldered to the coil terminals. These coils are designed to withstand moisture and a certain amount of rough handling, but are subject to failure due to broken connections and corroded or dirty terminals. The coils should be inspected before installation for broken or loose connections outside of the metal cover; these are resoldered if necessary and corroded or dirty terminals are thoroughly cleaned and brightened with sandpaper or emery cloth.

b. Test.—To test repeating coils, connect the coil under test with a coil known to be satisfactory by a short length of wire in the manner shown in figure 93, for simplexing a line. The ground should be an actual wire connection for the test. Then connect four serviceable telephones to the two coils, one pair of telephones to the metallic circuit, and one pair of telephones to the simplex circuit which is completed through the wire replacing the ground return circuit. The test consists in ringing and talking over each circuit. If

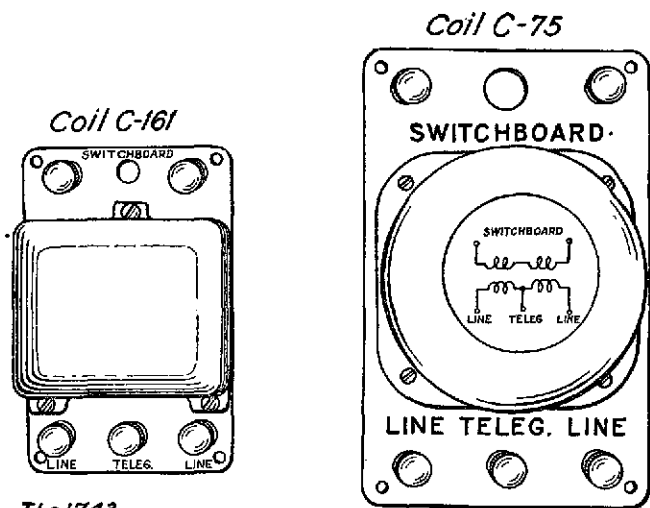

FIGURE 91.—Coils C-161 and C-75 (repeating).

unable to ring or talk over either circuit, test each of the short wire connectors both for continuity and for cross connection with all other wires. If they are clear of trouble, the coil windings which are inside the iron case are probably defective. If the first test shows that both circuits are clear, ring and talk over each circuit while listening over the other circuit. If the ringing or talking over one circuit can be heard loudly over the other circuit, the coil is defective and should be turned in for repair.

■ 216. SIMPLEX CIRCUIT (fig. 93).—*a.* The simplex circuit (par. 164*c*) is obtained by placing a repeating coil at each end of a metallic circuit (par. 215). The coil at each end is

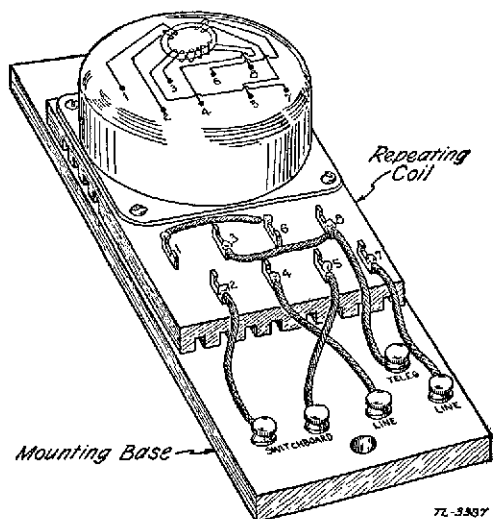

FIGURE 92.—Commercial repeating coil mounted and wired to binding posts.

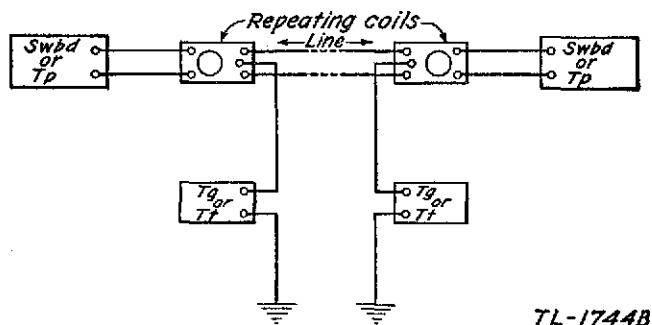

FIGURE 93.—Simplex circuit constructed with repeating coils.

usually located in the line as close to the switchboard terminal strip as practicable. The binding posts marked **LINE** are connected directly to the line, and those marked **SWITCHBOARD** are connected to the desired line terminals on the switchboard. The telephone circuit is completed inductively through the coil. The binding post marked **TELEG** is connected to one line terminal of the telegraph set, the other line terminal of which is ordinarily grounded near the instrument. This line to the telegraph set is usually referred to as the telegraph leg.

b. When a telephone is installed without a switchboard, the repeating coil terminals marked **SWITCHBOARD** are connected directly to the telephone.

c. Switchboards integrally equipped with repeating coils and terminal strips have the repeating coils permanently connected between the switchboard terminal strips and certain line units. The simplex circuit is then obtained by connecting the desired line to the proper line terminals on the switchboard and running the telegraph leg from the corresponding telegraph binding post to the telegraph set.

■ 217. **PHANTOM CIRCUIT.**—*a.* A phantom circuit may be constructed from two metallic circuits and four repeating coils, two at each end of the lines. The coils are usually located near the switchboard terminal strips unless they are integral parts of the switchboards. The end of each line is connected to the **LINE** binding posts of a repeating coil, and the corresponding **SWITCHBOARD** binding posts are connected to the line terminals of the appropriate switchboard. The two binding posts marked **TELEG** at each end of the lines form the phantom circuit, and are connected to the desired line terminals of the switchboards. (See fig. 94.)

b. If desired, the phantom circuit thus formed may itself be simplexed to obtain a telegraph circuit in the same manner as described in paragraph 216 for a single metallic circuit. This requires the use of an additional repeating coil at each end. (See fig. 95.)

c. In a switchboard integrally equipped with repeating coils and terminal strip, a phantom circuit may be obtained by connecting the two physical circuits to simplexed line

terminals of the switchboard, and connecting the two corresponding telegraph binding posts to another line terminal on the same switchboard, thus forming the phantom circuit. The corresponding phantom connections must be made at both ends of the two physical line circuits.

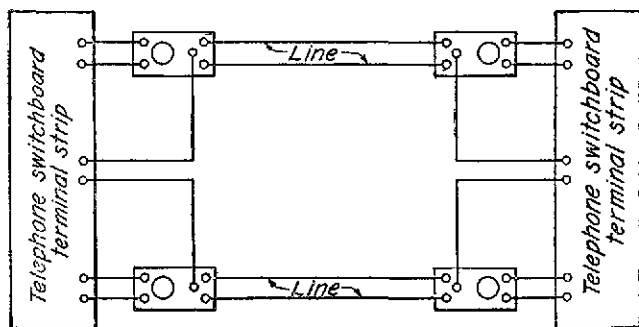

TL-1745

FIGURE 94.—Phantom circuit constructed with repeating coils.

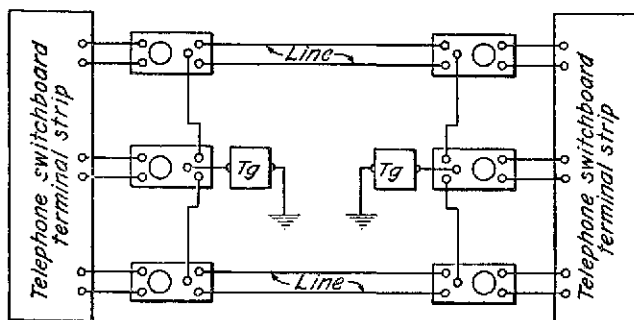

TL-1746

FIGURE 95.—Simplex phantom circuit.

■ 218. MUTUAL INTERFERENCE IN SIMPLEX AND PHANTOM GROUPS.—*a.* In these types of connections, mutual interference between simultaneous signals in different channels will result when all wires in the simplex or phantom group do

not have exactly the same impedance. The circuits are then said to be unbalanced and the amount of the interference will depend upon the degree of unbalance between the two physical, or metallic, circuits. The primary causes are poor splices which introduce a high resistance into either side of the circuit and improperly taped splices or damaged insulation which, particularly when wet, result in excessive leakage from one side of the circuit to ground. Although it is impossible to obtain a perfect impedance balance in field wire circuits, mutual interference may be reduced to a negligible value by making sure that each wire of a group is of approximately the same length and that all splices are well made, and by employing overhead construction at low, wet places and during rainy weather. Resistance unbalance may be corrected and mutual interference reduced to a minimum by inserting and adjusting a variable resistance in the low resistance side of an unbalanced circuit. The low resistance side is determined by trial.

b. The interference resulting from any unbalance is usually more pronounced in a phantom group than in a simplex circuit as there are more circuits involved in the former. Furthermore, due to their similarity of sound, interference between telephone channels is much more serious than the interference from telegraph key clicks. Ordinarily, a phantom circuit should be used in field wire systems only when the phantom circuit can be immediately removed, in case of undesirable crosstalk, without eliminating an essential talking channel. The use of simplex circuits usually is confined to the superposition of telegraph facilities on the wire systems.

■ 219. TYPES OF FIELD SWITCHBOARDS.—The switchboards in common use on field wire systems are the BD-72, BD-71, BD-11, BD-9, and telephone central office sets TC-4 and TC-12. Except for the TC-4, these are all monocord switchboards, and are described in paragraph 3, appendix I.

■ 220. SWITCHBOARD OPERATOR.—The ideal switchboard operator is courteous, intelligent, efficient, and capable of working for prolonged periods under stress. He should be familiar with Army organization, should be able to speak distinctly,

and should be able to understand speech over the telephone readily.

■ 221. OPERATING PHRASES.—The following phrases are prescribed for use by switchboard operators in all cases where they apply, to the exclusion of other phrases of similar meaning:

a. "Magic operator." Used by the operator in answering a call at the switchboard of the unit whose directory name is Magic.

b. "Magic ——" (Blank is appropriate directory number.) Used by an operator to indicate that he has correctly understood a number given to him by either a local party or by an operator of another central, and that he is proceeding to complete the call.

c. "What number please?" Used by an operator to request repetition of a number which he has not understood.

d. "The line is busy." Used by an operator to report that a local telephone for which he has received a call is already in use.

e. "Maytime is busy." Used by an operator who has received a call to be completed to a certain central (Maytime) to report that all trunks to that central are in use.

f. "Magic three-three does not answer." Used by an operator in reporting that a called party (Magic three-three) does not answer.

g. "Maytime does not answer." Used by an operator in reporting that a certain called central (Maytime) does not answer.

h. "Here's your party." Used by an operator whenever it is necessary for him to start the conversation over a connection.

i. "Are you through?" Used by an operator in supervising a connection, when no conversation is heard. Repeat the challenge at least once if no reply is heard.

j. "I will ring again." Used by an operator when, in supervising a connection, he is informed that the called party did not answer.

k. "What number is calling, please?" Used by an operator if, after supervising a connection, he is given a new number

to call by one of the parties and he is otherwise unable to identify that party.

l. "Magic three-zero has no telephone but I can give you Magic one-one." Used by an operator when there is no telephone at the number called, but another telephone is available to which the calling party might desire to be connected.

m. "What number were you calling, please?" Used by an operator to determine the number desired by a party who reports he has been given a wrong number or has been cut off.

n. "One moment please" or "I have a call for you." Used by an operator if necessary, to hold either party on the line while a connection is being completed.

o. "Calling Magic," or "Calling Magic one-one." Used by an operator when there is confusion or interruption in getting an operator or called party on the line.

p. "I must interrupt—urgent call from Magic six—please hang up." Used by an operator to inform the parties using a circuit that it is required for an urgent call by a certain calling party.

■ 222. SUPERVISION.—*a.* A switchboard operator supervises each connection to insure that conversation is established between the calling party and the called party, and to remove the connection as soon as possible after the conversation is completed. The operator listens in after he has made a connection and rung the called party, waiting to hear the called party answer and conversation begin. He remains in on the connection of a trunk call to another central until the other central has answered and he has passed the call to the other central. If it be necessary to answer another call before he has supervised a connection, he does so at the first opportunity. A shutter is never restored on a connection until it has been supervised.

b. In supervising a connection which has already been established, no conversation is heard, he challenges by asking "Are you through?" Great care is taken not to interrupt a conversation in progress. If after a second challenge, he receives no response, he takes down the connection. If he is notified that the called party has not answered, he answers, "I will ring again," and does so. If he is informed that the

connection is still in use, he removes his operator's plug. Connections are supervised frequently in the above manner in case both parties may have failed to ring off when the conversation was completed.

c. Normally, when a conversation is completed, the shutter on the connection will fall due to one of the parties ringing off. This is the signal for the operator to supervise the connection in the same manner as in *b* above. If a new number is given him by either party he asks, "What number is calling?" and proceeds to complete the call in the usual manner.

■ 223. TELEPHONE TRAFFIC DIAGRAM.—*a*. A traffic diagram is a chart showing the number of telephone channels actually existing between the switching centrals of a telephone system. Circuits connecting distant locals are also shown. A single line indicates direct telephone communication; a numeral placed on the line indicates the number of channels available including phantom circuits. The units to which each switching central or distant local pertains are indicated by the telephone directory name or otherwise.

b. The telephone traffic diagram is prepared at each switchboard by the wire chief or chief operator, assisted by the operator on duty, from information received over the wire system and shows such circuits only as are available for traffic. Its purpose is to indicate to the operator the most direct routing for a call to any other central in the system and to show alternate routings in case the direct routing is busy or out of order. For this purpose it often includes connecting telephone systems of other higher, lower, and adjacent units. It must be corrected continuously as changes occur and expanded as information is obtained. An example of a telephone traffic diagram is shown in figure 105.

■ 224. RECORDS.—At each switching central such records covering its operation are kept as required by the signal or communication officer. These records may include a station log and a test and trouble record (pars. 225 and 235).

■ 225. STATION LOG.—The station log is kept by the switchboard operator on duty under the supervision of the chief

STATION LOG

DIRECTORY NAME _____

LOCATION		OPENED		CLOSED		SCHEDULE OF OPERATORS										
DROP NO	CIRCUIT NO	TIME SERVICE OPENED	TIME SERVICE CLOSED	SERVICE INTERRUPTIONS OUT-TIME>IN	REMARKS NATURE OF TROUBLE ETC.	DROP NO	CIRCUIT NO	TIME SERVICE OPENED	TIME SERVICE CLOSED	SERVICE INTERRUPTIONS OUT-TIME>IN	REMARKS NATURE OF TROUBLE ETC.	TIME TIME	NAME	TIME TIME	NAME	
												ON	OFF	ON	OFF	
1																
2																
3																
4																
5																
6																
7																
8																
9																
10																
11																
12																
13																
14																
15																
16																
17																
18																
19																
20																
21																
22																
23																
24																
25																
26																
27																
28																
29																
30																

TL 673-A

CHIEF OPERATOR

Figure 96.—Example of station log for telephone central.

operator. A simple form for a station log, illustrated in figure 96, contains the following information:

- Directory name of station to which it applies.
- Location, date, and hour station opened and closed.
- Schedule of operators.
- Drop and circuit number.
- Time service opened and closed on each circuit.
- Time of interruptions to service.
- Remarks (nature of trouble, etc.).

In small switching centrals this form is not required.

■ 226. REPORTS TO MESSAGE CENTER.—The operating personnel keeps the message center continuously informed of telephone communication available to other centrals in the system. Interruptions and changes are likewise reported promptly to the message center.

SECTION IV

FIELD TELEGRAPH SETS AND STATIONS

■ 227. CIRCUITS.—Telegraph circuits used in field wire systems are usually obtained by simplexing existing telephone circuits (par. 216). Where the tactical situation is such that hostile interception is unlikely and proper operating precautions are taken, the earth may be used as a return circuit. The telegraph terminal on the repeating coil or switchboard at each end of the circuit is connected to one line binding post of the telegraph instrument. This is the telegraph leg and may be either a single conductor or a twisted pair field wire with both conductors in parallel. The other line binding post of the telegraph set at a terminal station is grounded. Where a good ground connection cannot be obtained (par. 228), and a second telephone circuit can be simplexed, a phantom circuit may be used (par. 217).

■ 228. GROUND CONNECTION.—A good low-resistance ground connection usually is necessary for each terminal station not only to insure sufficient operating current, but also to prevent interference with neighboring telegraph circuits. It is almost always possible to obtain a good ground by proceeding as follows:

- a. Drive a metal ground rod about 2 feet in length well

into the ground where it is moist. Use a longer rod if one is necessary and available. Usually the ground near the roots of a shrub, cactus, or other vegetation is moist. The ground rod, or a long spike, may be driven into the roots proper. If only dry ground is available, wet it thoroughly and pack it down around the rod.

b. Use a separate ground for each telegraph set or other equipment and keep separate grounds at least 15 feet apart.

c. Use two or more ground rods at least 15 feet apart connected together for a single set if one ground rod will not suffice.

d. Keep the wire leading from the ground rod to the set reasonably short, but do not hesitate to use a wire several hundred yards long if necessary to reach moist ground, such as a stream bed.

■ 229. BRIDGING SIMPLEXED CIRCUITS AROUND A SWITCHBOARD.—When a telephone circuit which is to be simplexed for telegraph passes through an intermediate telephone central at which no telegraph set is to be located it is necessary to make the simplex circuit continuous by bridging it around the telephone switchboard by means of repeating coils (par. 170a).

■ 230. TELEGRAPH WAY STATIONS.—Intermediate stations located between the terminal stations on a telegraph circuit are called the telegraph way stations. The connections which may be made at the way station are shown in paragraph 170a.

■ 231. TYPES OF FIELD TELEGRAPH SETS.—The telegraphs in common use on field wire systems are the telegraph sets TG-5-A and TG-5, the older buzzerphone EE-1-A, and teletypewriters. The sets differ from commercial Morse telegraph equipment, in that no sounders are used. Instead, the telegraph operators wear headphones and hear a sharp tone whenever local or distant keys of telegraph sets on a circuit are depressed. Operation and procedure are therefore similar to a break-in radiotelegraph circuit. For descriptions of the TG-5-A, see paragraph 4 of appendix I, which also includes appropriate references for the other telegraph sets. (See paragraphs 180b and 181 for references to teletypewriters.)

■ 232. ESTABLISHING TELEGRAPH COMMUNICATION.—*a.* On long telegraph circuits where good ground connections cannot be obtained, some difficulty may be experienced in establishing communication because the operator at one station may not know when the distant operator is on the line and attempting to transmit or receive signals, and therefore a definite procedure should be prescribed by the unit signal or communication officer. If telephone communication with the distant operator is possible, one operator should call the other by telephone and indicate that he is ready to operate and that he will attempt to establish communication by telegraph.

b. When no other means of communication is available, it will be necessary for each operator to adjust his instrument for most sensitive operation, connect it to the line, and alternately listen and transmit until he succeeds in communicating with the distant operator. A definite time should be prescribed the unit signal or communication officer for beginning telegraphic communication to facilitate establishing the net.

■ 233. TELEGRAPH OPERATING PROCEDURE AND RECORDS.—Station records and operating procedure for military manual field telegraph sets generally are the same as for radio, including the use of the International Morse Code. (See ch. 5 and TM 11-454.)

SECTION V

MAINTENANCE OF FIELD WIRE SYSTEMS

■ 234. GENERAL.—*a.* Maintenance of a field wire system includes the prevention, detection, localization, and correction of trouble in the system. Trouble may be prevented to a large extent by the following actions:

(1) Routing of wire lines and locating of centrals and stations so as to avoid hostile artillery fire and aerial bombing as far as practicable, and to protect the lines and equipment from injury by friendly troops and traffic.

(2) Careful handling of wire equipment and its protection from moisture while in storage, in transit, and after it is installed.

(3) Training of all operating and using personnel in the proper use and care of wire equipment.

(4) Conference between signal and communication officers with reference to the location of wire lines.

b. Trouble that occurs on field wire systems is of two classes: that which causes an interruption to service, and that which is located and cleared before an interruption to service occurs. Most trouble may be kept in the latter class by an alert maintenance crew making proper routine tests. When trouble occurs it is located and cleared as soon as possible by methodical locating procedure and proper repair or replacement of equipment. All trouble, whether detected by operating and maintenance personnel or reported by users, is recorded and followed up until cleared. Clearing of trouble on wire lines is facilitated by the establishment of test stations at important junctions and at points near which trouble is anticipated.

■ 235. ROUTINE TESTS.—a. The frequency with which routine tests of circuits and equipment should be made varies and is determined by the nature and importance of the circuits, type of equipment and its manner of installation, amount of traffic being handled, and amount of trouble being experienced. The frequency of these tests is prescribed by the signal or communication officer. All local and trunk circuits and the operating equipment connected to them or used in their operation are included in these tests. In general, circuits that are kept busy do not require as frequent routine tests as those that are seldom used. Communication is never interrupted to make a routine test, as a busy circuit obviously indicates that it is not in trouble. Circuits that have been busy and suddenly become idle are always tested at the first opportunity by the switchboard operator.

b. The routine tests of trunk circuits ordinarily are made by the wire chief, although they may be made by the switchboard operator if it does not interfere with the prompt handling of traffic. The test includes a check to see that each switchboard can be signaled from the other over all circuits between them, and that the voice transmission in each direction over the circuits is clear and satisfactory.

c. The routine tests of local circuits are ordinarily made by sending to the local telephone a maintenance man who

tests back to the wire chief or switchboard operator. The test includes a check that the switchboard can be signaled from the telephone and vice versa, and that the voice transmission in both directions over the circuit is satisfactory. In cases where it is impracticable to send a man to the local telephone, as might happen in the case of a long circuit, the user is called and requested to make the test. Ordinarily, however, users are not disturbed in making routine tests of local circuits.

d. A record of installation time, tests made, and troubles found or reported on trunk circuits, is kept by the wire chief at each switching central on a form such as illustrated in figure 97. Information included comprises—

- Directory name of station to which it applies.
- Location, date, and hour station opened and closed.
- Schedule of assistant wire chiefs.
- Notation of time interval between routine tests.
- Drop and circuit numbers.
- Time lines connected to switchboard.
- Time service was opened on particular line.
- Time of interruptions to service, with notation of personnel clearing trouble.
- Time service terminated on particular line.
- Remarks (nature of trouble, etc.).

■ 236. **CIRCUIT TROUBLES.**—*a. Character.*—Trouble on a field wire circuit is indicated when it is impossible to signal or be signaled, when it is impossible to hear or be heard, or when the transmission is weak or is interfered with by noise on the circuit or crosstalk from other circuits. A knowledge of the various troubles and the manner in which they affect transmission will materially aid in localizing the troubles when they occur.

b. Cause.—The trouble may occur either in the line wire itself or in the operating equipment attached to it, and will usually be found to be the result of an open circuit, a short circuit, a grounded circuit, or a crossed circuit at one or more points in the circuit.

(1) The open circuit or "open" is a break or cut in the conductor, either on one or both sides of the circuit.

(2) The short circuit or "short" is caused by electrical contact between the two conductors of a circuit. It may be the result of bruised or stripped insulation which either permits the bare wires to touch each other or permits them to conduct electricity from one to the other when wet.

(3) The grounded circuit or "ground" occurs when there is an electrical path to earth from one or both conductors of the circuit. It also may be the result of bruised or stripped insulation or a poorly taped splice where the wire is lying on the ground. The effects of grounds will be most pronounced in wet or damp weather.

(4) The crossed circuit or "cross" is caused by electrical contact between conductors of two adjacent circuits, and is in reality a short circuit between a conductor of one circuit and a conductor of another.

c. Effects on telephone transmission.—(1) An open will interrupt telephone communication completely. However, a partial open, such as results from a poorly made splice or a loose contact which introduces a high resistance in the circuit, may not destroy communication completely, but the transmission will be weak and probably noisy.

(2) A heavy or low resistance short will interrupt telephone communication completely. A partial or high resistance short will result in weakened transmission.

(3) A ground on both sides of a circuit will produce an effect similar to that of a short described in (2) above. A ground on only one side of a circuit will not usually interrupt telephone communication, but may produce hum or noise in the circuit.

(4) A cross is likely to result in crosstalk or interference between the two circuits involved which may or may not be sufficient to render the separate conversations unintelligible.

d. Effects on simplex telegraph operation.—It will be observed that a simplex telegraph channel may continue operative under certain trouble conditions which render the physical circuit on which it is superimposed inoperative for telephone communication, thus emphasizing again the value of the simplex telegraph channel. For example, the simplex telegraph circuit will work, or may be made to work, by the addition of battery in the case of the telegraph set

TG-5 or TG-5-A even though one side of the physical circuit is open; a short on the physical circuit will not affect the telegraph channel adversely; an accidental ground on one or both sides of the physical circuit will not render the telegraph channel inoperative generally unless the ground is of unusually low resistance; a cross is not likely to interfere with the telegraph channel unless both of the circuits involved in the cross are simplexed, and even then does not necessarily render the telegraph channels inoperative.

■ 237. EQUIPMENT USED FOR TESTING.—The nature of the trouble on a field wire circuit or in operating equipment can be determined with any of the following equipment in the manner described for each:

a. Field telephones.—Any field telephone may be used for testing line or equipment circuits. For convenience in making tests the telephone is equipped with a pair of test leads made of lamp cord, field wire, or other flexible twisted pair wire about 3 feet in length. A test clip is soldered to one end of each conductor, and if stranded wire is used the other end which is to be connected to the line terminal of the telephone is soldered lightly to hold the strands together and prevent accidental short circuits at the telephone terminals. The following tests may be made:

(1) *Test for an open.*—Connect the ends of the circuit to the line terminals of the test telephone and turn the generator crank rapidly. If the generator crank turns quite freely without any drag on it the circuit is probably open.

(2) *Test for a short.*—With the telephone connected as above, if the generator turns quite hard, as if a drag had been placed on it, the circuit is probably short-circuited or grounded on both sides.

(3) *Test for a ground.*—Connect one side of the circuit to one line terminal of the telephone, and connect the other line terminal of the telephone to ground. If there is a ground on that side of the circuit, the generator will turn hard as in the case of a short. Test the other side of the circuit in a similar manner.

(4) *Test for a cross.*—Connect one side of the circuit to one line terminal of the telephone and the other line terminal of the telephone to the conductor with which the circuit may

be crossed. If there is a cross the generator will turn hard as in the case of a short circuit. Test each side of the circuit in a similar manner with any conductor with which it might be crossed.

b. *Test sets EE-65-A and EE-65.*—The test sets **EE-65-A** and **EE-65** are compact wire chief's testing equipment for

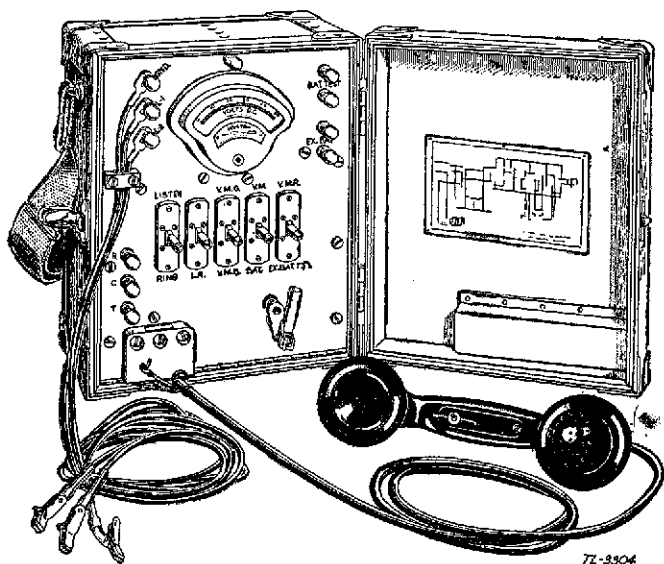

FIGURE 98.—Test set EE-65-A.

use in the field or in central office installations. The test set **EE-65-A** is illustrated in figure 98. In addition to means for ringing and talking on field wire systems, both test sets have provisions for the usual measurements required for analysis of faulty line operation. These include tests for continuity, opens, shorts, grounds, and other more specialized applications such as determinations of line capacitance and leakage. The principal differences between the two test sets are that the **EE-65-A** has the more sensitive voltmeter and has no telephone handset included with the instrument. For

a complete description and circuit diagrams of the test sets EE-65-A and EE-65, see TM 11-361.

c. *Voltmeter and battery* (fig. 99).—A simple arrangement for testing equipment circuits consists of a voltmeter and battery connected in series and equipped with wire leads. The terminals of the wire leads may be fitted either with test clips or short lengths of stiff copper wire for convenience in making contacts with the equipment circuits. This apparatus is suitable for making the following tests:

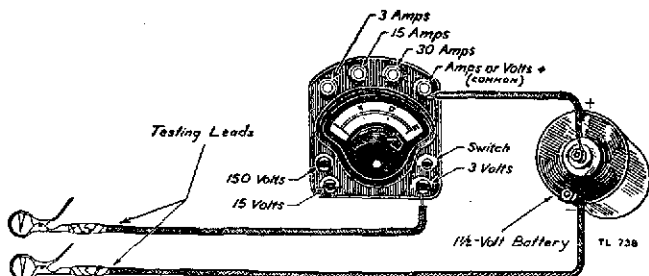

FIGURE 99.—Voltmeter and battery for use in testing circuits.

(1) *Test for a complete circuit.*—Connect the test leads to the ends of the circuit to be tested. If the circuit is complete the voltmeter needle will indicate a reading.

(2) *Test for an open.*—Connect the test leads to the ends of the circuit to be tested. If the circuit is open, the voltmeter needle will *not* indicate a reading.

(3) *Test for a short.*—Connect the test leads to the ends of the circuit to be tested. Open the other end of the circuit. If a short circuit exists, the results noted will be the same as for a complete circuit ((1) above).

(4) *Test for a ground.*—Connect one test lead to the circuit to be tested. Connect the other test lead to ground. If the circuit is grounded, the results noted will be the same as for a complete circuit ((1) above).

(5) *Test for a cross.*—Connect one test lead to the circuit to be tested. Connect the other test lead to the circuit with which the circuit to be tested is believed to be crossed. If one is crossed with the other, the results noted will be the same as for a complete circuit ((1) above).

d. *Receiver and battery* (fig. 100).—A telephone switchboard receiver connected in series with a battery and fitted with leads may also be used for testing. The terminals of the test leads may be either test clips or short lengths of stiff copper wire. The apparatus is suitable for making the tests

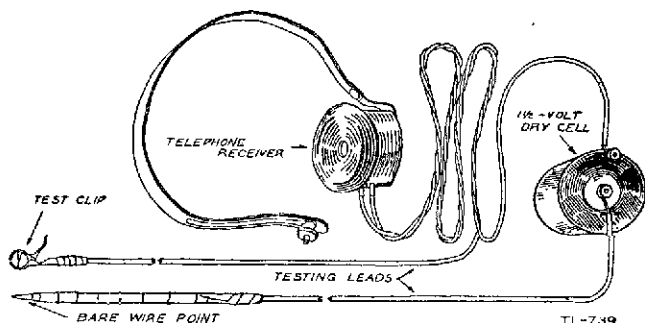

FIGURE 100.—Receiver and battery connected for use in testing circuits.

outlined for the voltmeter and battery in c above. However, a click in the receiver instead of a reading indicates a complete circuit. A failure to obtain a distinct click on completing the circuit indicates an open circuit.

■ 238. **LOCATING AND CLEARING TROUBLE.**—*a. General localizing of trouble.*—When trouble is detected or reported on a circuit, the first step is to determine whether it is in the line wire itself or in the operating equipment. If the line wire is cleared from the terminal equipment at the terminal strip, tests made from that point toward the switchboard show no trouble in the operating equipment, the trouble may be assumed to be either in the line wire itself or in the operating equipment at the distant end. This is verified by connecting the test equipment to the line and testing toward the distant end of the circuit. Trouble on a trunk circuit may be still further localized, providing an additional good circuit is available, by requesting the wire chief at the distant end to clear the faulty circuit from the operating equipment at that end. The circuit is then tested again for an open with the distant ends of the circuit open, and for a complete circuit

with the distant ends of the circuit connected together. If the trouble is in the line wire itself it will appear upon making these tests, and it is located and cleared as described in *d* below. If these tests show the line wires to be good, the trouble is in the operating equipment at the distant end and the wire chief there is so notified and requested to clear the trouble and reconnect the circuit.

b. Short local circuit in trouble.—If, upon making the first test described in *a* above at the terminal strips, the trouble is found to be toward the user's telephone, the circuit is reconnected and a trouble man dispatched with a serviceable telephone to the user's instrument. On his way he inspects the circuit for visible sources of trouble and repairs any that he finds. He then makes a ringing and talking test with the user's telephone. If he cannot signal the operator with it, he replaces the local instrument with his own instrument and repeats the test. If he can now signal and converse with the operator, the trouble was in the local telephone which is either repaired or replaced by him. If he cannot signal the operator, the trouble is probably in the local line circuit, and he first tests for a short and an open circuit, then tests for a grounded circuit, and, if applicable, tests for a cross with another circuit. If trouble is located in the line wire, he works back toward the switching central, making a careful inspection of the line wire, paying especial attention to splices and other doubtful points over its entire length. If the fault is located, he repairs it and notifies the user that the service is again available. If careful inspection does not readily disclose the fault, time may be saved by running a new circuit. This circuit is then connected into the switchboard, the local telephone connected at the end of the circuit, and the new installation tested.

c. Trunk circuit or long local circuit in trouble.—(1) If the tests described in *a* above determine that the trouble is in the line wire of a trunk circuit or in a long local circuit, the wire chief determines as accurately as his instruments permit the nature and approximate location of the trouble. This will facilitate the testing and materially shorten the time required to locate and clear the trouble.

(2) The circuit is then connected to a test telephone at the

switchboard terminal strip or left connected into the switchboard if there is not sufficient maintenance personnel available to man the test telephone. A lineman is then sent out on the line with a test telephone to test methodically from various points back to the man at the switchboard terminal strip or to the switchboard operator. Starting from the switchboard terminal strip, he carefully examines the circuit as he proceeds, particularly scrutinizing the insulation, splices, underground and overhead road crossings, and places where the wire has been passed over or pulled out of place by traffic. Fouled insulation, poor splices, and other evidences of possible trouble are repaired and the circuit tested in order to determine if the trouble has been cleared. If no such points of obvious trouble are found, the lineman bridges his telephone across the circuit at intervals and tests.

(3) If testing the defective circuit for an open, he connects the test telephone across the circuit without opening it. If testing for a ground or a short, he opens the circuit and then tests in both directions. Before opening the circuit however, he connects his telephone to it with the test clips and attempts to communicate in either direction as there is a possibility that the trouble has been cleared in the meantime by other personnel. In case it is necessary to open the circuit, it is opened at a splice or at a test station if practicable. After making each test the circuit is reconditioned by taping wherever a test clip has been connected to it, or by splicing and taping wherever the wire was cut.

(4) Upon making each test the lineman himself can determine whether the circuit is good between his location and the central by his ability to ring and talk to the man at the switchboard terminal strip or the operator. If any test toward his own central is successful, the fault still lies beyond in the direction of the distant central and the lineman continues to work in that direction. If he is unsuccessful in reaching his own central during any test, he has passed the fault and therefore works back over the circuit, reducing the distance between successive tests to about one half. By following this procedure the fault is located between two points a short distance apart. This section of the line is then carefully inspected until the actual fault is located. It is then

repaired by splicing, by cutting out and replacing the faulty section, or by simply taping as required.

(5) A defective circuit may have more than one fault. These may be of the same nature or different. It is essential that the lineman, after clearing each case of trouble, test the circuit in both directions to insure that it is in order. If trouble still exists he continues his inspection until all trouble has been located and cleared.

(6) The time consumed in splicing a circuit after each test for a short or ground is considerable, and will seriously delay the ultimate locating of a fault if such tests are made at too frequent intervals along the circuit when first starting out. Furthermore, a visual inspection of the circuit by the lineman as he progresses along its route will frequently disclose the fault. A knowledge of the geographic location of a circuit will aid the wire chief in predicting the probable location of a fault, having determined its nature. He may direct the lineman to make tests from the vicinity of such points or may specify the approximate interval for making tests. A good rule is to test each time a portion of the circuit has been passed which could not be visually inspected.

d. Removing trouble.—In repairing a circuit in the field, speed in restoring service comes first and proper technique in splicing next. When repairing a break in a line, communication is first restored by completing the square knot in each wire. Then while the bare wires are kept separated to prevent a short circuit, the splice is completed and taped. A valuable addition to the equipment of a lineman consists of two short pieces of wire about 3 feet in length with test clips on each end. These jumper wires are used to bridge a break during the construction of a splice, thus keeping the circuit in operation. In using jumper wires, care is taken that a short circuit is not caused while splicing. In locating trouble, linemen, preferably from the unit originally constructing the line, are sent out from each end of the circuit and work toward each other. The wire chiefs at both ends are responsible that it is cleared, regardless of where the trouble was first discovered. In addition to pliers, tape, and test telephone, each lineman carries a 50-foot coil of field wire with which to repair defective sections.

e. Trouble in local operating equipment.—If the trouble was originally determined to be toward the operating equipment at the central, it may be localized by opening the circuit at various places such as the line terminals, fuses, protectors, etc., and the tests repeated. Terminal strips and connections are inspected carefully for "shorts," "opens," and "crosses." If the trouble is in the equipment itself it can be located by a rigid system of testing such as prescribed for that specific piece of equipment elsewhere in this manual or in the Technical Manuals relating thereto. In the case of a faulty unit in a switchboard, its use should be discontinued and the circuit transferred to a spare unit until repair or replacement can be made.

■ 239. OPERATION OF TEST STATIONS (pars. 174 and 200).—*a.* The personnel at a test station may consist of one or more linemen as the situation requires. When the talking range will not be affected adversely, a test telephone may be kept bridged across a circuit, usually the lowest numbered telephone circuit passing through the test station, or a special circuit ending at the test station may be temporarily reserved for test purposes. The personnel on duty at the test station is instructed to answer prearranged signals only, usually three short rings. When answering this prearranged signal, the test station personnel states the name of the test station. The test station personnel is then instructed as to patching, testing, or repairing circuits, as the situation requires.

b. Test station personnel keeps informed constantly as to the serviceability of the circuit across which the test telephone is bridged by listening for the normal signaling and conversation that is passed over the circuit. If the circuit becomes idle it is tested promptly, and frequently thereafter. If these tests show the test circuit to be in trouble, the test telephone is bridged across another circuit and a report made to the switchboard operator or the wire chief.

c. Locating and clearing trouble on defective circuits which pass through test stations manned by linemen is facilitated by the fact that the wire chief can call each successive test station and quickly determine the faulty section. The nearest test station can then be directed to dispatch a lineman to

locate and clear the trouble. In the meantime serviceable sections may be patched as described in paragraph 240. A copy of the circuit diagram and line route map indicating all circuits passing through or terminating is kept posted at each test station.

■ 240. PATCHING CIRCUITS AT TEST STATIONS.—*a.* The patching of circuits at test stations frequently results in maintaining communication between centrals over these patched circuits during the locating and clearing of trouble on the defective sections of the original circuits. If this patching were not

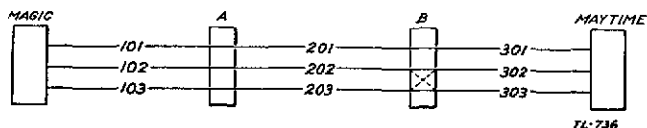

FIGURE 101.—Circuits patched at a test station.

TL-736

done, communication would be interrupted until the trouble had been cleared. The example in *b* below illustrates how patching may be used advantageously.

b. Assume that two switching centrals are connected by three circuits, all of which pass through two test stations as shown in figure 101. The telephone switchboard operator at **MAGIC** reports to the **MAGIC** wire chief that circuits 102 and 103 to **MAYTIME** are out of order. The wire chief at **MAGIC** tests these two circuits. With the aid of a serviceable circuit to his test stations, he finds that the trouble on the 102 circuit lies in section 202, between test station A and test station B, and that the trouble on the 103 circuit lies in section 303 between test station B and **MAYTIME**. He then instructs the lineman at B to connect circuit 203 to circuit 302, and circuit 202 to circuit 303. This gives immediately one serviceable built-up circuit from **MAGIC** to **MAYTIME** in addition to the 101-201-301 circuit. The **MAGIC** wire chief informs the lineman at A and the **MAYTIME** wire chief of the changes made at B so that all circuit diagrams can be temporarily changed accordingly. When the interrupted circuits have been repaired the wire chief is notified. Upon instructions from him the original connections are restored during an interval between busy periods, and all concerned are notified to this effect.

■ 241. PATROLLING WIRE LINES.—In shelled areas or where wire lines are subject to frequent damage from other causes, periodic testing from designated points is supplemented by patrolling the sections most subject to damage. Whenever possible, the personnel that have constructed a given section are also assigned the mission of patrolling that section. Wire patrols to be effective must carefully inspect every foot of the wire in the sections they cover, using a wire pike or an improvised wire guide made by fastening a bridle ring to a hand grip. Wire patrols repair trouble whenever found. They replace doubtful splices or sections of the line, tape abrasions in insulation, and improve the construction.

■ 242. TESTING FIELD WIRE ON REELS.—All insulated wire is carefully reconditioned after use, as follows:

a. Mount an empty reel and the reel containing the wire to be tested, so that the wire may be wound from the full reel on to the empty reel.

b. Pass the end of the wire through the hole provided near the drum of the empty reel and secure it so that the end will protrude from the side of the reel. This end must be free for use in future testing.

c. Station an experienced man between the reels to examine the wire carefully as it is slowly wound on to the empty reel. Cover with tape each abrasion or break in the insulation. If only the braid is broken, apply two layers of friction tape. If the bare wire is exposed, remove the ragged portions of insulation and cover the wire with two layers of rubber tape and two layers of friction tape as described in paragraph 187b. Carefully splice breaks in the conductor. Untape and examine each old splice; if the splice is poorly made, cut it out and splice the wire properly. If the insulation has been damaged over a long section of the wire, or if there are several splices very close together, cut out the faulty section.

d. After each splice, and also when all the wire of a reel is completely repaired, test the wire on the reel being filled for an open circuit or a short circuit between the two wires. These tests may be made by any of the equipment described in paragraph 236.

■ 243. TRANSPORTATION OF WIRE EQUIPMENT IN FIELD.—*a. Operating equipment.*—Operating equipment is comparatively delicate and its serviceability is governed to a great extent by care in methods of packing it for transportation. Operating equipment is packed and loaded in such manner as to protect it from—

- (1) Dust and dirt.
- (2) Weather.
- (3) Shocks of the road.
- (4) Injury from other articles loaded in the same vehicle.

b. Telephones.—Field telephones are carried in pack chests when these are provided. Handsets and cords are always placed neatly in their proper compartments, hook switches and removable generator cranks placed inside the cases, and carrying cases closed and locked or strapped. Special care must be taken to keep push buttons or butterfly switches on telephone handsets in the "off" or undeflected position to prevent useless drain on batteries.

c. Switchboards.—Monocord switchboards with cable and switchboard terminal strip attached are packed in a pack chest separate from telephones. Before placing in the pack chest the switchboards are placed in their carrying cases with shutters locked and cable neatly coiled.

d. Repeating coils, loading coils, terminal strips, spare batteries, and spare parts.—These are carried in the pack chests provided, packed in such manner as to prevent injury to themselves or other equipment in the same chest.

e. Telegraph and buzzerphone sets.—When pack chests are available it is desirable to use them for packing this equipment as loads that are more compact and easily handled result from their use. The cases of buzzerphones are of more sturdy construction and they may be packed outside of special pack chests without danger of injury.

f. Wire.—The principal precaution necessary in transporting wire is that the metal drums or commercial spools should not be dropped from vehicles or handled in such a manner as to injure or bend them and thereby make difficult their refilling and use. The wire should be protected from crushing or abrasion from other objects transported with the reels.

CHAPTER 9

SIGNAL SUPPLY

■ 244. **GENERAL.**—For general information regarding supply, see FM 100-10.

a. Signal supply is conveniently discussed in terms of the division and the supply duties of the division signal officer. Signal supply of corps troops is effected by the same methods as are employed in the division, the duties of the corps signal officer in this respect being analogous to those of the division signal officer. Signal supply for army troops and GHQ troops is accomplished in a similar manner. See paragraph 254 for signal supply of air force troops.

b. Responsibilities of commanders for signal supply of their troops are the same as for other supply. The principal supply duties of a division signal officer are given in paragraph 12 and the most important publications relating to signal supply are included in appendix II.

■ 245. **CLASSIFICATION.**—All items of signal communication equipment, except pyrotechnics and pyrotechnic projectors, are classed as signal supplies. These excepted items are ordnance property and are handled through ordnance channels. All signal supplies issued to division units are normally class II and the methods of procurement described below are based on this premise. Some signal supplies properly fall into class IV. Special materials for cable, pole, and trench line construction, and for radio and other installations not usual within the division fall into this latter classification. Such materials are commonly used by Signal Corps troops or corps and higher echelons, and occasionally by troops of other arms.

■ 246. **DIVISION PERSONNEL.**—The supply officer of the division signal company or troop is the principal supply assistant of the division signal officer. The supply and transportation personnel and facilities of the company or troop are utilized for division as well as for company or troop supply purposes. Supply officers of all division units may deal directly with the division signal officer on signal supply matters within the limits of policies prescribed by the commanders concerned.

■ 247. **METHOD.**—The impulse for signal, like other supplies, is from *rear* to *front*. Any expediency which can be adopted to expedite supply, particularly in the theater of operations, should be vigorously enforced. To reduce formal paper work, full advantage should be taken of provisions of AR 35-6540, which authorize the exchange of serviceable for unserviceable articles. In the theater of operations, radio and telegraphic messages, or, in an emergency, even oral or telephonic messages, may suffice for requisitions. In such case, an explanation of the need for such articles may be required by the approving authority, especially when the articles requested are in excess of T/BA allowances. The supply approval decision should be based upon a careful consideration of the expressed need for supplies in contradiction to any special formal allowance. Stocks available and priority of need are the main controlling features.

a. Normal requisitions are reduced to a single request by the consolidation of needs within any unit. Emergency requisitions may be submitted at any time. A requisition or request for supplies which has been accepted by a higher office must be followed up vigorously to see that every effort is made to secure them, and that any action taken or results obtained is transmitted to the requesting authority. Hence, no unit should duplicate on later requisition items previously requested unless they have been informed that such items have been stricken from the original requisition.

b. Requisitions or requests are submitted to the division signal officer by the unit supply officer. Each requisition includes the consolidated needs of the unit. A signal company or troop submits requisitions or requests the same as any other unit.

c. Requisitions or requests should be for supplies within

established T/BA unless justification for the additional needs is included. It is understood no requisition is submitted by any unit when its supply officer could furnish the material from some excess source available to him.

d. Using standard nomenclature as listed in T/BA or the Signal Corps General Catalog expedites supply.

e. When an article has been lost, destroyed, or damaged other than by fair wear and tear, a request for replacement, accompanied by the responsible officer's certificate that the article is in the process of survey, will suffice for a replacement requisition.

f. The division signal officer—

(1) Edits all requisitions for quantity, authenticity, and nomenclature, and takes action relative to the supply thereof.

(2) If any needs can be met by using supplies on hand in the division signal company or troop or in other units in excess of their reasonable requirements, authorizes issues of such supplies.

(3) Prepares one consolidated requisition for the unfilled signal supply needs of the entire division. No requisition should include articles of different classes.

(4) When necessary, obtains the approval of the division commander and forwards the requisition in accordance with instructions of higher authority, usually through the corps signal officer to the army signal officer.

(5) Informs unit commanders of the action taken on requisitions submitted by their units.

■ 248. RECEIPT.—Signal supplies are received by the division at army supply points either in response to requisitions of the division signal officer or in the form of credits allocated to the division by the army signal officer. In the case of credits, the division signal officer may reallocate these to units of the division. This procedure, when it can be followed, expedites supply and reduces the necessity for requisitions being submitted through higher channels. The division signal officer takes control of supplies when they are issued at the army supply point.

■ 249. TRANSPORTATION.—The division signal officer notifies unit supply officers when and where to send transportation

for signal supplies. Usually units send their transportation to the signal supply dump. When drawing against credits, an informal request for the items desired, signed by the unit supply officer, should accompany the transportation. In the combat zone where accountability is suspended, the supply officer includes on his receipt for the property a notation of the organization and purpose, or work, for which the supplies or materials are to be used. When unit transportation is not available, cargo vehicles available to the division commander are used to deliver supplies to the subordinate units. In an emergency, the division commander may direct the use of transportation of the signal company or troop for this purpose. When possible, supplies are delivered to unit distributing points where supply officers make any additional distribution which may be desired.

■ 250. SIGNAL UNIT SUPPLIES.—The quantities of signal supplies authorized for the division signal company and troop are the minimum necessary for their proper functions, and the use of those supplies to meet the needs of other units is not normal. However, in unusual situations, emergency needs of lower units are balanced by the signal officer against those of the signal company or troop, and if necessary, are met to some extent from those supplies. In such cases immediate action is initiated to replenish the supplies so issued. To release the train of the division signal company or troop for its combat mission, it is necessary to dump some or all of the unit supplies at a point convenient to the unit. This point is located near the division command post.

■ 251. STORAGE BATTERIES.—*a.* In units not equipped with charging sets, the storage batteries authorized solely for use with communication equipment are serviced by the division signal company or troop.

b. The division signal officer provides for the collection, charging, and distribution of these batteries. Batteries should always be fully charged before the beginning of a tactical operation.

c. The charging and maintenance of storage batteries installed in a vehicle and used jointly in the operation of the vehicle and of signal equipment installed therein is the re-

sponsibility of the arm or service charged by AR 850-15 with the maintenance of the vehicle.

d. For further details, see TM 11-430.

■ 252. PIGEONS.—Pigeons are distributed as prescribed in paragraph 92*a*.

■ 253. REPAIR OF EQUIPMENT.—While much of the signal equipment issued is simple and usually needs only minor mechanical or electrical repair, other items are inherently as delicate as precision instruments and require the attention of expert repairmen. The attempted repair of the latter equipment by an incapable repairman often results in greater damage to the equipment. The Signal Corps General Catalog and Technical Manuals provide guides to the repairs which should be attempted in the field. Repairs are accomplished as follows:

a. The extent to which repairs are permitted in any unit is determined by the commander of the unit after the receipt of advice from the division signal officer. This determination is made only after a consideration of the tools and testing equipment available in the unit and of the capabilities of available personnel.

b. Using units habitually replace unserviceable batteries, cords, tubes, easily accessible assemblies, nuts, bolts, screws, straps, and other simple mechanical parts.

c. Equipment which is not repaired in lower units is turned in for repair or replacement to the division signal company or troop which has limited but usually better repair personnel and facilities. If needed repairs are beyond the immediate capabilities of those units, the signal officer takes immediate steps to secure replacement and forward the unserviceable item to the army signal depot or to a mobile repair shop of the army signal repair company when the division is part of an army, or disposes of it in accordance with instructions of higher authority when it is not.

■ 254. SIGNAL SUPPLY FOR ARMY AIR FORCES.—*a. Organization for supply.*—Supply for air force units is described in FM 100-10. The organization for supply of air force units, which is shown graphically in figure 102, follows the chain of ground installations rather than the chain of command. The air

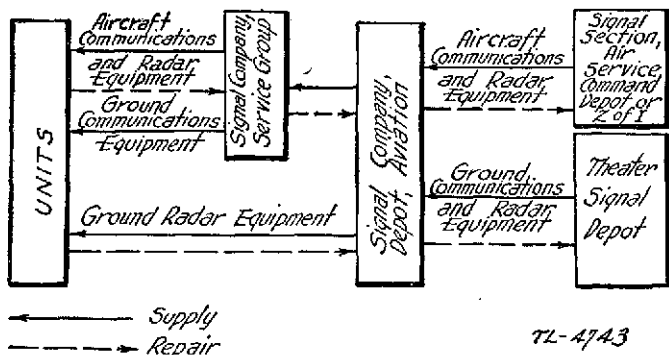

FIGURE 102.—Flow of supplies in an air force.

force signal officer is responsible for proper operation of signal supply in the air force and the signal officer of each command echelon is responsible for assuring himself that signal supply requirements of all units of his echelon are being met and for making reports and recommendations for improving this service.

b. Signal supply officers.—Signal Corps officers are provided for signal supply down to include the subair base. Down to this point, accountability and the process of requisitions and shipments of property are maintained. Below the subair base, requisitions are informal and property is held on memorandum receipt. Full advantage is taken of the exchange of property provisions of AR 35-6540. Every authorized procedure which will facilitate supply is followed.

c. Method.—If, in the air force squadron, authorized non-expendable property becomes unserviceable through fair wear and tear, the squadron supply officer executes an informal certificate of fair wear and tear and with an informal requisition for replacement of the equipment submits it to the air force distributing point officer. The distributing point officer exchanges the unserviceable item for a like serviceable item in his stock whenever possible. If he does not have the item in stock, he informally requisitions the item from his subair base signal supply officer accompanying the requisition with the squadron supply officer's informal certificate of fair wear and tear and also the item when practicable.

d. Source.—The appropriate section of an air force base command serving an air support command is the agency charged with maintaining appropriate reserve stocks of signal supplies and issuing them to the signal communication units to the extent of allotments provided in the Tables of Basic Allowances, in the first instance, and thereafter as replacements are required.

e. Expendable and nonexpendable items.—Expendable items of signal supplies and equipment will be replaced by the supply agency upon presentation to it by the signal or communication unit concerned a duly executed certificate of expenditure, listing thereon the expendable items to be replaced. Unserviceable expendable and nonexpendable items will be turned in to the signal supply agency accompanied by a duly executed certificate of fair wear and tear, and the items will be replaced. The certificate in each instance will serve as a requisition.

f. Repair of equipment.—Minor repairs only of signal equipment, and only within the facilities and means available, will be undertaken by signal and communication units. Equipment in need of repair will be turned in to the signal supply agency accompanied by a certificate of fair wear and tear and replacement will be furnished.

CHAPTER 10

ORDERS, RECORDS, AND REPORTS

■ 255. REFERENCES.—For further information on this subject, see FM 101-5 and FM 11-5.

■ 256. ORDERS.—Signal communication personnel are required to interpret and execute the instructions contained in routine and combat orders. (See FM 101-5 for classification of orders and forms.)

■ 257. RECORDS AND REPORTS.—*a. Unit journal.*—Signal units of division and higher headquarters keep a journal during operations in the field. The journal is a daybook containing briefs of important written and oral messages received and sent and notations of periodic reports, orders, and similar matters that pertain directly to the signal unit. Copies of messages and other data pertaining to the signal unit and furnished by it for purposes of information to sections of the unit are not entered in the journal. Communication units may keep a similar journal but rarely find it necessary to do so. (See form for a signal unit journal in par. 261.)

b. Circuit diagram.—A consolidated circuit diagram is kept by signal communication troops of the unit headquarters to show the wire system of the unit and those of its subordinate units. A circuit diagram also serves as a convenient method of reporting to the next superior headquarters the circuit connections installed by the subordinate unit. (See pars. 167 and 262.)

c. Line route map.—A consolidated line route map is kept by signal communication troops of the unit headquarters to show the routes of the wire lines of the unit and those of its subordinate units. A line route map also serves as a practical and convenient method of reporting to the next superior headquarters the routes of the wire lines installed by the subordinate unit. (See pars. 169 and 263.)

d. Disposition.—The signal or communication officer arranges for the collection of message center records, switching central records, and records of radio and telegraph stations, and other operating agencies from each operating agency at frequent or at least daily intervals. (See par. 46*d*.) Such records are useful for the correction of errors, checking on operation, or for information for special reports. When of no use, they are destroyed.

■ 258. STEPS INVOLVED IN EACH TACTICAL OPERATION.—The solution of any situation demanding action requires that certain definite steps be taken in a logical sequence.

a. Mission.—The signal mission is the particular duty required of signal communication troops. The commander may give his signal or communication officer definite instructions as to what signal communication he desires or he may restrict the mission of the signal or communication officer by directing that only certain agencies be employed. In most cases, however, this mission is seldom stated by the commander. It is more or less routine and is usually deduced from the commander's directive to his staff.

b. Estimate of the signal situation.—The signal or communication officer makes an estimate of the signal communication situation in order to arrive at his recommendations concerning the signal activities of the command. He first considers his mission; he next considers so much of the enemy situation as may affect his commander's signal communication; then the tactical decision and so much of the friendly situation, including the signal situation, as has a bearing on the furnishing of the signal communication desired for the operation; and last, the several plans open to the commander for providing adequate signal communication for the contemplated tactical operation. From as complete an analysis of these considerations as time permits, the signal or communication officer makes his decision as to the recommendations he will make to his commander for providing signal communication for the tactical operation planned.

c. Plan.—When time permits, the recommendations are submitted to the commander in the form of a plan for signal communication. Whether or not the time necessary to

evolve and obtain approval for a communication plan will be available will depend on the tactical situation. In any event the steps in evolving the plan are followed whether they are transcribed as a formal written order or are issued as an oral or dictated order, fragmentary or complete. Whether or not the plan is submitted to the commander or to his G-3 (S-3) depends upon the operating methods of the particular staff. Since G-3 (S-3) is charged with supervision of signal communication, it is considered better practice to first submit the plan to him. The plan presented will comprise the following:

- (1) Paragraph 5 of the field order. (See par. 259a.)
- (2) Time the signal system will be ready for operation.
- (3) Essential service to be provided.
- (4) Signal supply details affecting the plan.

d. Signal orders.—After the commander approves the plan for signal communication, the signal or communication officer works out the details necessary to put the plan in order form. The instructions to be included in paragraph 5 of the field order are submitted to the operations and training section of the staff; this section is charged with the preparation of the field order. The plan, supplemented by other necessary information and instructions, is issued as signal orders. The purpose of these orders is to coordinate the establishment of the signal system throughout the command and, therefore, contain only essential information and necessary instructions to accomplish this purpose. By the employment of standing operating procedure signal orders may be very brief, indicating only the deviations or additions to standing operating procedure. (See appendix I, FM 11-10.) Signal orders may be issued as an annex to formal written field orders, and if so issued, that annex is ordinarily called the signal annex. (See par. 259b.) When it is impracticable to prepare the signal orders in written form, they may be issued either as a dictated or an oral order, complete or fragmentary. If the order is issued orally the ultimate information imparted is identical with that contained in the formal written order. An operation map indicating points of special interest to signal and communication units may be issued as an annex to the signal order. This operation map will materially re-

duce the size of the written field order and will supplant much of the oral signal order. A circuit diagram of the wire system may be issued as an annex to the signal order. (See example, par. 262.) However, when time does not permit the issue of a circuit diagram, fragmentary orders or standing operating procedure will indicate the circuit connections to be made and the circuit diagram will be made up after the wire system is installed. A line route map may also be issued as an annex to the signal order when sufficient time is available to permit thorough reconnaissance, or when it is desired to indicate general routes of wire lines. (See example, par. 263.) However, when time does not permit, fragmentary orders may indicate the wire routings or construction personnel may select the routing between given points, making up the line route map as a record of the route followed. In units smaller than a division, the signal orders are normally oral or fragmentary, supplemented by such sketches as may be necessary.

e. Supervision.—The responsibility of the commander does not end with the issue of orders. Therefore, to secure proper compliance by subordinates and to assure himself that plans of subordinates are in furtherance of his own orders, the commander may direct his signal or communication officer to supervise the execution of the signal orders which have been issued. Supervision is exercised by means of conferences and visits. Such conferences have as their object the promotion of mutual understanding, the correct interpretation of doubtful or obscure points, and the development of teamwork.

■ 259. **FIELD ORDERS.**—Field orders are issued by the commanders of all tactical organizations for each distinct operation. They contain instructions governing all tactical activities of the command during the combat operation for which the order is issued, including as paragraph 5 the establishment of signal communication.

a. Paragraph 5 of the field order.—This paragraph contains instructions arranged in lettered subparagraphs and in sequence as follows:

(1) Subparagraph *a* refers to the signal annex if issued. If signal orders are not issued as an annex, this subparagraph

refers to the index to signal operation instructions in effect for the operation. If reference is made to the annex, further reference to signal operation instructions is unnecessary since the annex contains a statement indicating what index to signal operation instructions is in effect. Examples:

a. See Annex No. 3, Signal Orders.

a. See Index No. 7 to Signal Operation Instructions.

In addition, important instructions in the annex or in signal operations instructions may be repeated in this subparagraph to emphasize them. Examples:

All radio communication is restricted until the hour of attack, 0448 14 November.

Pyrotechnic signal to fire barrage: Signal, ground green star cluster, M20.

(2) Subparagraph **b** announces the initial locations of the command posts of the unit and each of its principal subordinate combat units, and the axes of signal communication for all tactical operations in which a displacement of command posts is contemplated. A command post location may be expressed in several ways, depending upon the situation. It may be expressed by stating a definite location or a definite position in a column. It may be indicated as being at a certain place after a certain hour. It may be shown as closing at one location and opening at a new location at the same hour. A subordinate combat unit may be directed to report the location of its command post when the location cannot be predicted. Axes of signal communication are prescribed by the higher unit for its principal next subordinate combat units, and for itself if not already prescribed by a higher unit. Example of subparagraph **b** for a division field order:

b. Command posts and axes of signal communication.—

(1) Command posts.

1st Inf Division: Closes at TWO TAVERNS at 1900 and opens at BONNEAUVILLE at the same hour

1st Infantry: RJ 575-D (358.2-750.7) after 1800

2d Infantry: RJ 598-H (359.6-748.7) after 1900

3d Infantry: To be reported by 2100

(2) *Axes of signal communication:*

1st Inf Division: RJ 568-A (360.3-750.1)—CEDAR RIDGE (361.3-751.5)—NEW OXFORD (366.2-753.8)

1st Infantry: RJ 572-B (359.6-752.7)—RJ 524-D (361.2-753.7)—SWIFT RUN SCHOOL (363.1-754.5)—RJ 461-D (365.0-756.0)

2d Infantry: RJ 586-J (360.5-750.1)—RJ 534-D (361.9-752.1)—RJ 569-C (363.4-753.3)—RJ 536-K (365.5-753.5)

3d Infantry: RJ 549-E (363.8-751.4)—RJ 544-A (365.4-751.6)—RJ 604-F (367.7-752.1)

(3) Subparagraph *c* announces instructions governing advance message center and march control points. Examples:

c. An Advance Message Center, 1st Inf Division, will be established at CR 581-A (368.9-754.7) by 1400.

c. 1st Inf Division will establish the following march control points for the movement of the main attack force:

CR 581-P (370.2-747.0) opens 1730, closes 2200.

CR 601-A (363.6-746.5) opens 1900, closes 2330.

CR 530-D (356-748.2) opens 2030, closes 0100 night 14/15 November.

(4) If no instructions are published pertaining to an indicated subparagraph, its letter designation is applied to the succeeding subparagraph.

b. Signal annex (par. 258d).—The signal annex contains the signal situation confronting the command as a whole, the mission to be accomplished by the signal agencies of the command as a whole, any missions other than those covered by standing operating procedure assigned to the commanders of the next subordinate units, and any additional instructions for signal communication troops of the command necessary to coordinate the establishment of signal systems and agencies throughout the command.

(1) Signal annexes are prepared by signal officers of divisions and higher units when formal written field orders are issued by the headquarters. In units below the division and in the division and higher units when field orders are

oral and fragmentary, signal orders are normally issued as dictated or oral orders, complete or fragmentary.

(2) The general form of signal annexes to formal written field orders follows that prescribed for field orders.

(3) A signal annex to a formal written field order may be subdivided into annexes which comprise an operations map, a circuit diagram, a line route map, etc. When the signal order is issued orally it probably will be supplemented with an operations map, circuit diagram, and line route map.

(4) A signal annex is given the same distribution as the field order. Extra copies may be distributed to signal communication troops as required.

c. Orders of signal communication units.—The commander of a signal communication unit follows certain steps in each tactical operation. His mission is defined in the orders of the commander whose headquarters he serves, and he makes an estimate of the situation and reaches a decision in order to adopt a plan of action. In making this estimate he considers the allotment of tasks to the components of his organization and the methods available to install, operate, and maintain the signal agencies for the headquarters his unit is serving. The plan of action adopted is then put into order form, either written or oral, for issue to his unit.

(1) In signal units of divisions and in communication units, field orders are usually issued as oral orders and often in fragmentary form.

(2) A circuit diagram of the wire system to be installed, operated, and maintained; and, whenever practicable, a signal operation map indicating certain of the proposed signal installations and as much of the tactical plan as is required by signal troops, are issued as annexes to the field orders of signal units. When oral orders are issued they are normally supplemented by a circuit diagram even though roughly drawn, and whenever practicable, are issued from a signal operation map.

■ 260. SIGNAL OPERATION INSTRUCTIONS.—*a.* Signal operation instructions are a type of combat orders which primarily affect the employment of signal communication troops and agencies. They are issued for the technical control and

coordination of signal agencies throughout the command, generally in advance of a contemplated operation, and may remain in force throughout the entire operation or cycle of operations, or be changed whenever required. They are prepared by signal officers of divisions and higher headquarters and are issued to subordinate units in the name of the respective commander. Units smaller than the division have little occasion to prepare signal operation instructions. However, an independent force smaller than a division may find it advantageous to prepare certain items of signal operation instructions if it is to be engaged on a separate mission for any appreciable length of time.

b. The instructions may be prepared as separate items so that only those items which apply to their particular duties may be issued to interested personnel. Each issuing headquarters issues both an index and a distribution list.

(1) The index states the title of each item of signal operation instructions, the serial number of each item, the issuing headquarters when other than the headquarters issuing the index, the date and hour each item becomes effective or supersedes a previous item, and such other pertinent remarks as are essential. A new index with a new serial number is prepared and issued whenever a new item or change is issued.

(2) Each item of signal operation instructions has a distribution including only units or individuals concerned. This distribution, referred to as "Distribution S", is published and distributed as signal operation instruction. It lists the number of copies of each item to be distributed to each unit needing a copy.

c. Each item covers a distinct phase of activity concerned and is designated by a title descriptive of its contents and by a number which is changed serially for successive issues. At the top of each item appears the heading SIGNAL OPERATION INSTRUCTIONS. When applicable, the classification SECRET, CONFIDENTIAL, or RESTRICTED is noted as prescribed by AR 380-5. In certain organizations the complete signal operation instructions are published bound as a unit. When bound the document as a whole bears the highest classification contained within it.

d. Examples of items of signal operation instructions are given in paragraph 265. Those examples are suggested as a

guide only and departures therefrom are authorized. Except for the items of index and Distribution S, appropriate titles for required items will be determined by the headquarters of issue.

■ 261. FORM FOR SIGNAL UNIT JOURNAL.

----- Journal ¹

Time ¹		Serial No.	Time dated ²	Incidents, messages, orders, etc.	Disposition ⁴
In	Out				
				(Day and date)	

¹ The journal is the day book of the signal unit. It is usually not kept by signal units of organizations smaller than a division. It contains briefs of important written and oral messages received and sent and notations of periodic reports, orders, and similar matters that pertain directly to the unit. Copies of messages and other data pertaining to the unit and furnished by it for purposes of information of other sections or units are not entered in the journal. If any item is received or issued in oral form, the entry herein is detailed; if in document form, the entry may be a notation referring to a file or a brief synopsis of contents.

² Refers to time of receipt or sending in this office.

³ Refers to time information originated thus calling attention to age of the information.

⁴ The following symbols may be used: M=noted on situation map; S=standard distribution at CP; T=information furnished troops.

■ 262. EXAMPLE OF CIRCUIT DIAGRAM.—This example was prepared for issue as an annex to a signal order to a division field order (fig. 103).

■ 263. EXAMPLE OF LINE ROUTE MAP.—This example prepared as a record for the signal section, headquarters, 1st Infantry Division (fig. 104).

■ 264. EXAMPLE OF TELEPHONE TRAFFIC DIAGRAM.—This example was prepared for use at a switching central and retained as a record for the signal officer, headquarters, 1st Infantry Division (fig. 105).

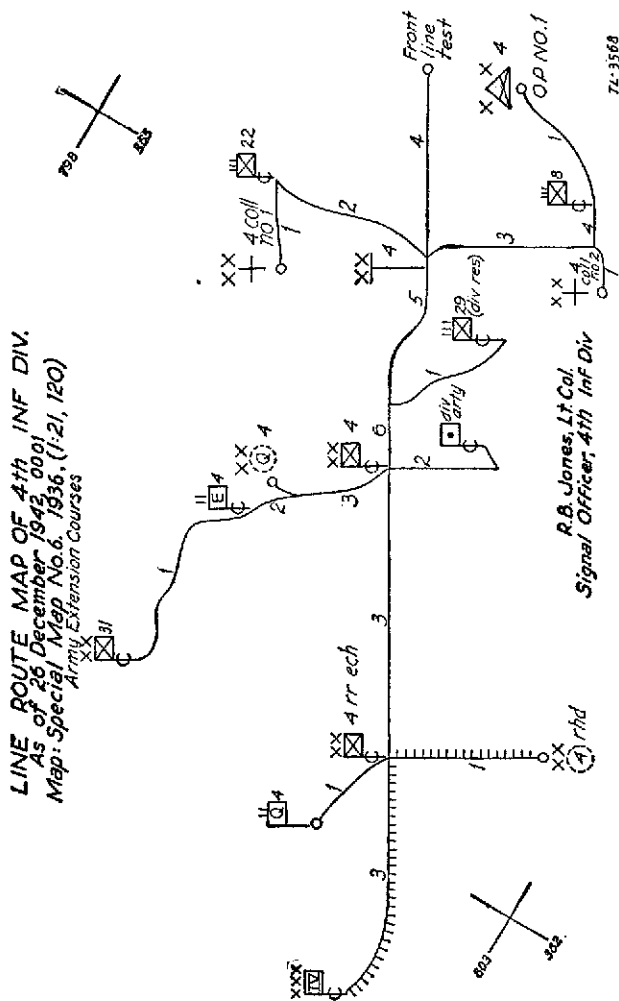

FIGURE 104.—Example of line route map.

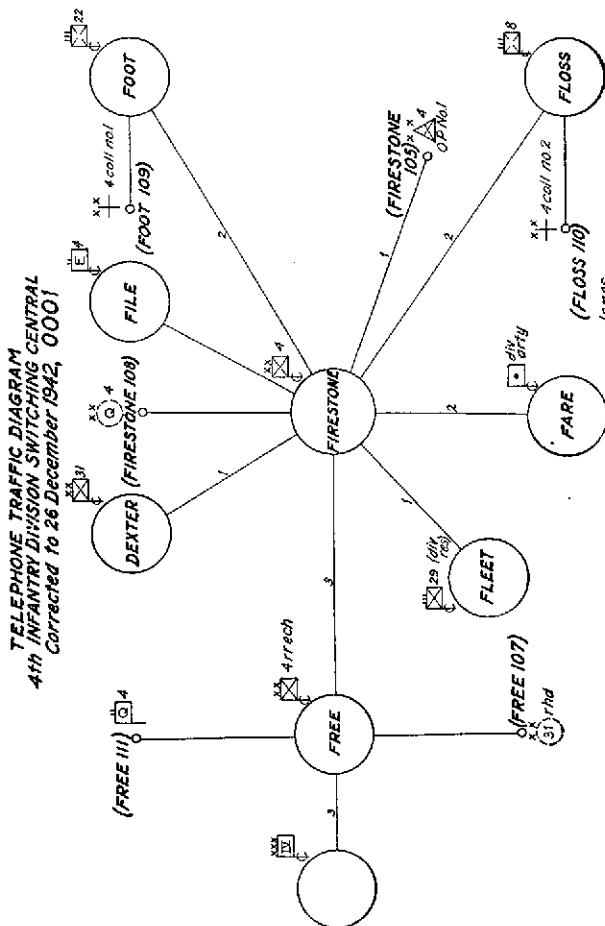

Figure 105.—Example of telephone traffic diagram.

71-3567

■ 265. EXAMPLES OF SIGNAL OPERATION INSTRUCTIONS FOR AN INFANTRY DIVISION.—These examples are intended for use as guides only.

a. Instruction page prescribing the use of signal operation instructions.

RESTRICTED*

SIGNAL OPERATION INSTRUCTIONS

4th Infantry Division

NEW CUMBERLAND, PA.

24 April 1942, 0900

1. The signal operation instructions prescribed in Index No. 1-2 are issued for use in the 4th Infantry Division effective 0001, 25 April 1942. Additional items of signal operation instructions, items to be issued at a later date, and items listed in Index No. 1-2 which are to be changed will be issued to units as prescribed in distribution S No. 2-1 and will be accompanied by a new index to signal operation instructions. Each new issue of an item of signal operation instructions will bear an authentication.

2. Except for such extracts as may be required, items of this signal operation instructions will not be taken forward of the command posts of front line battalions.

3. Loss or information of compromise of any item of this signal operation instructions will be immediately reported to the division signal officer.

BY COMMAND OF MAJOR GENERAL WHITE:

ERNEST R. BLUE,
Colonel, General Staff Corps,
Chief of Staff.

OFFICIAL:

/s/ MARVIN O. ELM
Marvin O. Elm,
Lieutenant Colonel, General Staff Corps,
Assistant Chief of Staff, G-3.

DISTRIBUTION:

All units receiving items of signal operation instructions.

RESTRICTED

*Classifications used in this and other examples of signal operation instructions which follow are examples only and do not necessarily mean that those instructions should be so classified.

SIGNAL COMMUNICATION

265

b. Example of index to signal operation instructions.

RESTRICTED

SIGNAL OPERATION INSTRUCTIONS

INDEX TO SIGNAL OPERATION INSTRUCTIONS

NO. 1-2

4th Infantry Division
NEW CUMBERLAND, PA.
24 April 1942, 0900

Effective 25 April 1942, 0001

Item	Serial No. ¹	Remarks
GENERAL:		
Index to signal operation instructions.....	1-2	Supersedes No. 1-1.
Distribution S.....	2-1	
Index to regulations and orders on signal communication.	3-1	To be issued.
CODES AND CIPHER KEYS:		
Supplement to AGE T-1.....	4-2	Supersedes No. 4-1.
Supplement to DFC T-1.....	5-2	Supersedes No. 5-1.
Authenticator code.....	6-1	
Supplement to FCC.....	7-1	
Cipher keys.....	8-1	For Cipher Device M-94 and Converter M-209.
Panel identification code.....	9-1	
Map identification code.....	10-1	
Number and map coordinate code.....	11-1	Issued by Corps.
Pyrotechnic code.....	12-1	Issued by Corps.
RADIO COMMUNICATION:		
Radio frequencies.....	13-1	
Radio call signs.....	14-1	
WIRE COMMUNICATION:		
Telephone directory.....	15-1	
Wire tagging code.....	16-1	
MISCELLANEOUS:		
Daylight chart and moon phase.....	17-1	Issued by Corps.
Prearranged message code.....	18-1	Issued by Corps.

¹ First number is associated with the designation of the item; second is the serial issue of that item.

RESTRICTED

RESTRICTED

BY COMMAND OF MAJOR GENERAL WHITE:

ERNEST R. BLUE,
*Colonel, General Staff Corps,
 Chief of Staff.*

OFFICIAL:

/s/ MARVIN O. ELM
 Marvin O. Elm,
*Lieutenant Colonel, General Staff Corps,
 Assistant Chief of Staff, G-3.*

DISTRIBUTION: S.

RESTRICTEDc. *Example of signal operation instructions.***RESTRICTED****SIGNAL OPERATION INSTRUCTIONS****DISTRIBUTION S**

No. 2-1

4th Infantry Division
 NEW CUMBERLAND, PA.
 24 April 1942, 0900

Effective 25 April 1942, 0001

Key to serial numbers

1. Index to signal operation instructions
2. Distribution S
3. Index to regulations and orders on signal communication
4. Supplement to AGL T-1
5. Supplement to DFC T-1
6. Authentication code
7. Supplement to FCC
8. Cipher keys for cipher device M-94
9. Panel identification
10. Map identification code
11. Number and map coordinate code
12. Pyrotechnic code
13. Radio frequencies
14. Radio call signs
15. Telephone directory
16. Daylight chart
17. Precarranged message code

RESTRICTED

SIGNAL COMMUNICATION

265

RESTRICTED

Organizations	1	2	3	4	5	6	7	8	9	10	11	12	13	14	15	16	17
Staff Officers Div Hq.....	2	2	2							2	2				2	2	2
Division Signal Officer.....	10	10	10	10	10	10	10	10	10	10	10	10	10	10	10	10	10
4th Signal Company.....	5	5	5	5	5	5	5	5	5	5	5	5	5	5	20	10	20
8th Inf Hq & Hq Co.....	4	4															4
Ea Inf Bn—Total.....	4	4															4
22d Inf Hq & Hq Co.....	4	4															4
Ea Inf Bn—Total.....	4	4															4
29th Inf Hq & Hq Co.....	4	4															4
Ea Inf Bn—Total.....	4	4															4
Hq Division Artillery.....	5	5															5
29th FA Bn, 105-mm.....	4	4															4
42d FA Bn, 105-mm.....	4	4															4
44th FA Bn, 105-mm.....	4	4															4
20th FA Bn, 155-mm.....	4	4															4
4th Engr Bn.....	4	4															4
4th Med Bn.....	1	1															1
4th QM Bn.....	1	1															1
4th Ren Troop.....	4	4															4
IV Corps.....	4	4															4
31st Infantry Division.....	4	4	4	4	4	4	4	4	4	4	4	4	4	4	4	4	4
43d Infantry Division.....	4	4	4	4	4	4	4	4	4	4	4	4	4	4	4	4	4
Diary.....	1	1	1	1	1	1	1	1	1	1	1	1	1	1	1	1	1
Total.....	85	85	83	76	37	60	48	64	81	83	83	81	44	44	104	90	112

Numbers represent such quantities as are necessary for distribution. (It is intended to show that numbers throughout the table will be inserted in the quantities necessary; those shown are not fixed).

BY COMMAND OF MAJOR GENERAL WHITE:

ERNEST R. BLUE,
Colonel, General Staff Corps,
Chief of Staff.

OFFICIAL:

/s/ MARVIN O. ELM
Marvin O. Elm,
Lieutenant Colonel, General Staff Corps,
Assistant Chief of Staff, G-3.

DISTRIBUTION: S.

RESTRICTED

d. Example of signal operation instructions supplement to AGL T-1.

RESTRICTED

SIGNAL OPERATION INSTRUCTIONS

SUPPLEMENT TO AGL T-1

NO. D-2

4th Infantry Division

NEW CUMBERLAND, PA.

24 April 1942, 0900

Effective 25 April 1942, 0001

1. *Special meanings for supplement groups.*—The following special meanings are assigned to supplement groups of the Air-Ground Liaison Code, Training Edition No. 1 (AGL T-1). They should be pasted in the spaces reserved for same in both the encoding and decoding sections of the code. No other meanings will be assigned to the supplement groups listed below. The coordinates shown under the columns headed "Coordinates" refer to the General Map of Gettysburg (1925), 1/312,500.

ENCODING

<i>Meaning</i>	<i>Code group</i>			<i>Panel</i>
BEECHER HILL.....	Hypo	Tare	Unit	256
BLACK ROCK.....	Dog	Queen	Unit	184
CODORUS CREEK.....	Mike	Fox	Xray	359
EBBVALE.....	Cast	Yoke	Prep	168
HOFFACKER VALLEY.....	Fox	Baker	Prep	217
WENTZ.....	Baker	King	Tare	133
WESTERN MARYLAND RR.....	Love	Mike	Inter	342

DECODING

<i>Meaning</i>	<i>Code group</i>
WENTZ.....	Baker
EBBVALE.....	Cast
BLACK ROCK.....	Dog
HOFFACKER VALLEY.....	Fox
BEECHER HILL.....	Hypo
WESTERN MARYLAND RR.....	Love
CODORUS CREEK.....	Mike

RESTRICTED

RESTRICTED

2. Map coordinates appearing in messages encoding in the Air-Ground Liaison Code will be encoded in the map coordinate code listed in the current Index to Signal Operation Instructions of this division.

BY COMMAND OF MAJOR GENERAL WHITE:

ERNEST R. BLUE,
Colonel, General Staff Corps,
Chief of Staff.

OFFICIAL:

/s/ MARVIN O. ELM
Marvin O. Elm,
Lieutenant Colonel, General Staff Corps,
Assistant Chief of Staff, G-3.

DISTRIBUTION: S.

RESTRICTED

e. Example of signal operation instructions supplement to DFC T-1.

RESTRICTED

SIGNAL OPERATION INSTRUCTIONS

SUPPLEMENT TO DFC T-1

NO. 5-2

4th Infantry Division
NEW CUMBERLAND, PA.
24 April 1942, 0900

Effective 25 April 1942, 0001

ENCODING

Meaning	Code group	Meaning	Code group
ABBOTTSTOWN ---	EKZC 1224	BLACK ROCK-----	EWEA 1429
BACHMAN MILLS--	ETSZ 1392	BOILING SPRINGS.	EWIE 1433
BAIR-----	EVGO 1406	BOWMANSVILLE --	EWWS 1446
BALTIMORE -----	EVNW 1413	BRICKLYN-----	EXIS 1458
B A L T I M O R E		CARLISLE JUNC-	
& HANOVER RD--	WIIO 5083	TION-----	EXJT 1459
BECKLEYSVILLE--	EVRZ 1416	CRANBERRY-----	EXWF 1471
BIXILER-----	EWEX 1426	DALLASTOWN-----	EXYH 1473

RESTRICTED

RESTRICTED

<i>Meaning</i>	<i>Code group</i>	<i>Meaning</i>	<i>Code group</i>
DILLSBURG	FALW 1511	HAMPSTEAD	ARGO 0356
DUG HILL RIDGE	WUGF 5131	HOFFMANVILLE	ARPY 0365
EBBVALE	FAMX 1512	KEENER	ARYG 0373
EKLO	FEUG 1544	KINGSDALE	ASDZ 0378
FISCAL	FIXL 1572	LINEBORO	ASGC 0381
FREELAND	FIYM 1573	LOGANVILLE	ASVR 0395
GLADFELTERS	FOOG 1589	MANCHESTER	ATPZ 0415
GLEN ROCK	FORI 1591	MAPLE GROVE	WUML 5137
GULDENS	FOTK 1593	MECHANICSBURG	ATRA 0416
GUNPOWDER FALLS CREEK	APWR 0346		

DECODING

<i>Code group</i>	<i>Meaning</i>	<i>Code group</i>	<i>Meaning</i>
APWR 0346	GUNPOWDER FALLS CREEK	EWWS 1446	BOWMANSVILLE
AGRO 0356	HAMPSTEAD	EXIS 1458	BRICKLYN
ARPY 0365	HOFFMANVILLE	EXJT 1459	CARLISLE JUNC- TION
ARYG 0373	KEENER	EXWF 1471	CRANBERRY
ASOZ 0378	KINGSDALE	EXYH 1473	DALLASTOWN
ASGC 0381	LINEBORO	FALW 1511	DILLSBURG
ASVR 0395	LOGANVILLE	FAMX 1512	EBBVALE
ATPZ 0415	MANCHESTER	FEUG 1544	EKLO
ATRA 0416	MECHANICSBURG	FIXL 1572	FISCAL
EKZC 1224	ABBOTTSTOWN	FIYM 1573	FREELAND
ETSZ 1392	BACHMAN MILLS	FOOG 1589	GLADFELTERS
EVGO 1406	BAIR	FORI 1591	GLEN ROCK
EVNW 1413	BALTIMORE	FOTK 1593	GULDENS
EVRZ 1416	BECKLEYSVILLE	WIIO 5083	BALTIMORE & HANOVER RD.
EWBX 1426	BIXLER		
EWEA 1429	BLACK ROCK	WUGF	
EWIE 1433	BOILING SPRINGS	WUML	

BY COMMAND OF MAJOR GENERAL WHITE:

ERNEST R. BLUE,
Colonel, General Staff Corps,
Chief of Staff.

RESTRICTED

RESTRICTED

OFFICIAL:

/s/ MARVIN O. ELM
 Marvin O. Elm,
Lieutenant Colonel, General Staff Corps,
Assistant Chief of Staff, G-3.

DISTRIBUTION: S.

(This takes the same classification as the code to which it pertains.)

RESTRICTED

f. Example of signal operation instructions supplement to FCC.

RESTRICTED

SIGNAL OPERATION INSTRUCTIONS

SUPPLEMENT TO FCC

NO. 7-1

4th Infantry Division
 NEW CUMBERLAND, PA.
 24 April 1942, 0900

Effective 25 April 1942, 0001

Special meanings for supplement groups.—The following special meanings are assigned to supplement groups of fire-control code (FCC). They should be entered on the page containing the supplemental code groups in TM 6-230, in pencil. No other meanings will be assigned to the supplement code groups listed below.

<i>Code group</i>	<i>Panel</i>	<i>Meaning</i>
ZA	ø87	Adjust (will adjust) on head of column.
ZB	ø88	Adjust (will adjust) on leading assault wave.
ZC	ø89	Adjust (will adjust) on rear target.
ZE	ø91	Check target position.
ZG	ø93	Describe target.
ZH	ø94	Fly (will fly) gun target line.

RESTRICTED

RESTRICTED

BY COMMAND OF MAJOR GENERAL WHITE:

ERNEST R. BLUE,
Colonel, General Staff Corps,
Chief of Staff.

OFFICIAL:

/s/ MARVIN O. ELM
Marvin O. Elm,
Lieutenant Colonel, General Staff Corps,
Assistant Chief of Staff, G-3.

DISTRIBUTION: S.

RESTRICTED

*g. Example of signal operation instructions cipher keys for
cipher device M-94 and converter M-209.*

CONFIDENTIAL

SIGNAL OPERATION INSTRUCTIONS

CIPHER KEYS FOR CIPHER DEVICE M-94 AND CONVERTER M-209

NO. 8-1

IV Corps
MECHANICSBURG, PA.
23 April 1942, 0900

Effective 25 April 1942, 0001

Cipher device M-94

1 2 3 4 5 6 7 8 9 10 11 12 13 14 15 16 17 18 19 20 21 22 23 24 26

Effective Midnight 24-25 April to Midnight 28-29 April

G O N E W I T H T H E W I N D G O N E W I T H T H
5 17 14 2 23 11 19 7 20 8 3 24 12 15 1 6 18 16 4 25 13 21 9 22 10

(Proceed in a similar manner for successive periods of time.)

CONFIDENTIAL

SIGNAL COMMUNICATION

265

CONFIDENTIAL

*Converter M-209**Position of Key Wheel Pins*

Period of Midnight 24-25 April to Midnight 28-29 April

No. 1 (26)	No. 2 (25)	No. 3 (23)	No. 4 (21)	No. 5 (19)	No. 6 (17)
A-	-A	A-	-A	-A	A-
B-	-B	B-	-B	B-	B-
-C	-C	-C	C-	-C	-C
D-	D-	-D	-D	D-	D-
-E	E-	-E	E-	E-	-E
-F	-F	-F	F-	F-	-F
-G	G-	G-	-G	-G	-G
H-	-H	H-	H-	H-	H-
I-	-I	-I	I-	I-	-I
J-	J-	J-	-J	-J	-J
K-	K-	-K	-K	-K	K-
-L	L-	L-	-L	-L	-L
M-	-M	M-	M-	M-	-M
N-	-N	N-	N-	N-	N-
-O	O-	-O	-O	-O	O-
-P	-P	-P	P-	P-	-P
-Q	-Q	-Q	-Q	-Q	Q-
-R	R-	R-	-R	-R	
S-	S-	S-	S-	S-	
T-	-T	T-	T-		
-U	U-	U-	U-		
V-	-V	V-			
W-	X-	X-			
-X	-Y				
-Y	-Z				
-Z					

(Proceed in a similar manner for successive periods of time.)

Position of Drum Bar Lugs

Period of Midnight 24-25 April to Midnight April 30-May 1

CONFIDENTIAL

BASIC FIELD MANUAL

CONFIDENTIAL.

	1	2	3	4	5	6
1	X					
2		X				
3		X				
4			X			
5			X			
6			X			
7				X		
8				X		
9				X		
10				X	X	
11			•		X	
12					X	
13					X	
14					X	
15					X	
16					X	
17					X	X
18						X
19						X
20						X
21						X
22						X
23						X
24						X
25						X
26						X
27						X

(Proceed in a similar manner for successive periods of time.)

CONFIDENTIAL

CONFIDENTIAL

26- letter check

T K H R X C U Y T K N O I K R J N T A D T A I V P M
 BY COMMAND OF LIEUTENANT GENERAL SMITH:

L. M. JONES,
*Brigadier General, General Staff Corps,
 Chief of Staff.*

OFFICIAL:

/s/ R. L. BROWN
 R. L. Brown,
*Lieutenant Colonel, General Staff Corps,
 Assistant Chief of Staff, G-3.*

DISTRIBUTION: S.

CONFIDENTIAL

h. Example of signal operation instructions panel identification code.

CONFIDENTIAL

SIGNAL OPERATION INSTRUCTIONS

PANEL IDENTIFICATION CODE

NO. 9-1

4th Infantry Division

NEW CUMBERLAND, PA.

24 April 1942, 0900

Effective 25 April 1942, 0001

<i>Headquarters</i>	<i>Panel</i>
4th Infantry Division.....	018
8th Infantry.....	450
1st Battalion 8th Infantry.....	519
2d Battalion 8th Infantry.....	527
3d Battalion 8th Infantry.....	490
Antitank Company 8th Infantry.....	489
22d Infantry.....	455
1st Battalion 22d Infantry.....	532
2d Battalion 22d Infantry.....	459
3d Battalion 22d Infantry.....	544
Antitank Company 22d Infantry.....	523
29th Infantry.....	470
1st Battalion 29th Infantry.....	480
2d Battalion 29th Infantry.....	529
3d Battalion 29th Infantry.....	533
Antitank Company 29th Infantry.....	497
4th Infantry Division Artillery.....	545
29th Field Artillery Battalion.....	520
42d Field Artillery Battalion.....	465
44th Field Artillery Battalion.....	482
20th Field Artillery Battalion.....	451
4th Reconnaissance Troop.....	550

CONFIDENTIAL

CONFIDENTIAL

BY COMMAND OF MAJOR GENERAL WHITE:

ERNEST R. BLUE,
Colonel, General Staff Corps,
Chief of Staff.

OFFICIAL:

/s/ MARVIN O. ELM
Marvin O. Elm,
Lieutenant Colonel, General Staff Corps,
Assistant Chief of Staff, G-3.

DISTRIBUTION: S.

CONFIDENTIAL

i. Example of signal operation instructions map identification code.

CONFIDENTIAL

SIGNAL OPERATION INSTRUCTIONS

MAP IDENTIFICATION CODE

NO. 10-1

4th Infantry Division
NEW CUMBERLAND, PA.
24 April 1942, 0900

Effective 25 April 1942, 0001

Map name	Identification April 25-30	Code groups May 1-6
Abbotstown sheet, 1/21, 120.....	TQ	LV
Antietam quadrangle, 1/62, 500.....	PZ	EP
Arendtsville sheet, 1/21, 120.....	YN	OL
Baltimore quadrangle, 1/62, 500.....	QX	MK
Belair quadrangle, 1/62, 500.....	AI	EW
Bonneauville sheet, 1/21, 120.....	TM	CA
Carlisle quadrangle, 1/62, 500.....	PM	CU

CONFIDENTIAL

CONFIDENTIAL

Map name	Identification April 25-30	Code groups May 1-6
Chambersburg quadrangle, 1/62, 500.....	ZS	QB
Ellicott quadrangle, 1/62, 500.....	YB	CP
Emmitsburg quadrangle, 1/62, 500.....	VN	IH
Emmitsburg sheet, 1/21, 120.....	CH	ZL
Fairfield quadrangle, 1/62, 500.....	UA	OV
Fairfield sheet, 1/21, 120.....	LR	HO
General map, Gettysburg (1925) 1/312, 500.....	WE	AY
Gettysburg quadrangle, 1/62, 500.....	ZB	YK
Gettysburg sheet, 1/21, 120.....	WO	UK
Hagerstown quadrangle, 1/62, 500.....	YA	YG
Hanover quadrangle, 1/62, 500.....	PR	GT
Hanover sheet, 1/21, 120.....	TX	LA
Harrisburg quadrangle, 1/62, 500.....	US	ZT
Hunterstown sheet, 1/21, 120.....	AO	YZ
Jamsville quadrangle, 1/62, 500.....	ZN	OQ
Kingsdale sheet, 1/21, 120.....	LU	HD
Knowlyn sheet, 1/21, 120.....	KY	GR
Mercersburg quadrangle, 1/62, 500.....	BI	WJ
Middletown quadrangle, 1/62, 500.....	WV	ZL
Mount Airy quadrangle, 1/62, 500.....	NM	GD
New Cumberland quadrangle, 1/62, 500.....	BG	AZ
Newman sheet, 1/21, 120.....	XT	YT

CONFIDENTIAL

CONFIDENTIAL

BY COMMAND OF MAJOR GENERAL WHITE:

ERNEST R. BLUE,
Colonel, General Staff Corps,
Chief of Staff.

OFFICIAL:

/s/ MARVIN O. ELM
Marvin O. Elm,
Lieutenant Colonel, General Staff Corps,
Assistant Chief of Staff, G-3.

CONFIDENTIAL

f. Example of signal operation instructions number and map coordinate code.—This system can be used to indicate grid, polar, or thrust line coordinates.

CONFIDENTIAL

SIGNAL OPERATION INSTRUCTIONS

NUMBER AND MAP COORDINATE CODE

NO. 11-1

IV Corps
MECHANICSBURG, PA.
23 April 1942, 0900

Effective 24 April 1942, 0001

1. *Purpose and construction of the chart.*—*a.* This number chart can be used for indicating numbers of any type, including map coordinates expressed in any of the three generally accepted systems, namely, gridded quadrangles of the U. S. Geological Survey, polar coordinates, or point of origin-extension point coordinates.

b. The chart has been constructed in four sections numbered I, II, III, and IV so that by combining properly the groups from the various sections any desired number can be expressed. Sections I and II are intended to be used together to express any number under 100 to the nearest tenth by means of a single three-letter group. Sections III and IV are intended to be used together to express round numbers above 100. In line A the numbers from 100 to 995 can be

CONFIDENTIAL

CONFIDENTIAL

expressed by intervals of 5, in line E the numbers from 1,000 to 99,500 can be expressed by intervals of 50, and in line I the numbers from 10,000 to 99,500 can be expressed by intervals of 500, all by means of single three-letter groups. The letter B in section IV is used as a null to produce a three-letter group in cases where a number is completely expressed by two letters. Example: EPB=2,000.

2. *Indicating numbers.*—*a.* Numbers less than 100, including decimals in tenths, can be expressed by the use of sections I and II of the chart. For example, to indicate the number 64.5, locate 64 in section I and write down the letters at the left of the row and at the top of the column in which 64 appears, in that order; follow these letters by the letter heading the column in which 5 appears in section II on the same row as 64 in section I. This gives the three-letter group JSC.

b. For numbers greater than 100 use is made of sections III and IV in addition to sections I and II. For example, to indicate the number 114,000, find 100 in section III and write down the letters at the left of the row and at the top of the column in which 100 appears; follow these letters by the null letter B. This gives the three-letter group ANB. Now find 14 in section I and write down its equivalents by proceeding as in 2*a* above. For the third letter of the group write down the letter heading the column in which \emptyset appears in section II on the same row as 14 in section I. This gives the three-letter group CSC. Thus the two groups ANB CSC will represent 114. The group for $\emptyset\emptyset\emptyset$ is now derived as in the case of 100. This gives the three-letter group AYB. Thus the complete expression of 114,000 will be ANB CSC AYB.

c. Using any authorized code or cipher system, substitute the appropriate code or cipher equivalents for the groups obtained by the above procedure.

d. It will usually be found that a large number can be made up in several different ways, but in general that method should be employed which makes use of the least possible number of groups. For example, 1,500,000 can be represented by BPB ASB AYB, but more simply by ENN AYB.

CONFIDENTIAL

CONFIDENTIAL

3. *Indicating grid coordinates.*—*a.* The method of using the number chart to indicate grid coordinates applicable to a gridded map can best be explained by means of an example. Assume the coordinates to be 332.8-749.5. Locate the number 300 in section III and write down the letters at the left of the row and at the head of the column in which 300 appears, in that order, plus the null letter B, as: AQB. Then find 32 in section I and write down the letters at the left of the row and at the top of the column in which 32 appears, in that order; follow these letters by the letter heading the column in which 8 appears in section II on the same row as 32 in section I. This gives the three-letter group FQC. Thus 332.8 is expressed by the two groups AQB FQC.

b. For 749.5, proceeding as in 3*a* above, write AVB GYM.

c. Using any authorized code or cipher system, substitute for AQB FQC AVB GYM the code or cipher equivalents of those twelve letters.

4. *Indicating polar coordinates.*—*a.* Polar coordinates are commonly given in this order: (1) magnetic azimuth in degrees, (2) reference point, (3) distance in miles, or yards. To indicate the polar coordinates 105° C 12, locate the number 100 in section III and write down the letters at the left of the row and at the top of the column in which 100 appears; follow these letters by the letter heading the column in which 05 appears in section IV. This gives the three-letter group ANC.

b. Write down the reference point letter C.

c. Find 12 in section I and write down the letters at the left of the row and at the top of the column in which 12 appears; follow these letters by the letter heading the column in which 0 appears in section II on the same line as 12 in section I. This gives the three-letter group CQC.

d. Using any authorized code or cipher system, substitute for ANC C CQC the code or cipher equivalents of those seven letters.

5. *Indicating point of origin-extension point coordinates.*—*a.* Coordinates in this system are commonly given in this order: (1) distance in miles (or yards) from point of origin, (2) left or right, (3) distance to left or right in miles (or

CONFIDENTIAL

CONFIDENTIAL

yards). To indicate 21.5 L 6.7, proceeding as in 3a above, write down DPK for 21.5.

b. Write down the letter L.

c. For 6.7, proceeding as in 3a above, write down BVK.

d. Using any authorized code or cipher system, substitute for DPK L BVK the code or cipher equivalents of those seven letters.

e. While it is permissible to mix miles and yards in this system (indicating one direction in miles, the other in yards), this is not advisable.

6. *Reversing the operations.*—*a. For numbers.*—Having decoded or deciphered a message and obtained INK HNH as numbers, to convert these groups back into numbers, find in section III the number in row I under N; it is 10,000. Since the number under K in section IV on row A is 3,500, then INK=13,500. For the second group, HNH, find the number under N in row H of section I; it is 50. Since the third letter in the group is H, and this represents Ø on the H row of section II, then HNH=50. Thus the total value of INK HNH is 13,550.

b. For grid coordinates.—Having decoded or deciphered a message and obtained AQB HXC AVB KVB as grid coordinates, to convert these groups back into numbers, find in section III the number in row A under Q; it is 300. Since the 3d letter in the group is B, and this represents a null, then AQB=300. The 2d group is HXC; find the number under X in row H of section I, and annex the number under C in row H of section II as the decimal. This gives 58.6. The number 58.6 added to 300 gives 358.6, which is the X coordinate. For the Y coordinate (AVB KVB) proceed as for the X coordinate, obtaining 776.3. The complete coordinates are therefore 358.6-776.3.

c. For polar coordinates.—Having decoded or deciphered a message and obtained GTD B EWB as polar coordinates, to convert back into numbers, find in section I the number in row G under T and annex as the decimal the number under D in row G of section II. This gives 45.8, which is the magnetic azimuth in degrees. The reference point is B. The distance is obtained by proceeding as in paragraph 6a with the

CONFIDENTIAL

CONFIDENTIAL

group EWB, obtaining 8,000, which is the distance in yards. The complete polar coordinates are therefore 45.8° —reference point B—8,000 yards.

d. *For point of origin—extension point coordinates.*—Having decoded or deciphered a message and obtained GYJ R CQJ as point of origin—extension point coordinates, to convert back into numbers, find in section I the number in row G under Y and annex the number under J on row G of section II as the decimal. This gives 49.2, which is the distance in miles away from the point of origin toward the extension point. The direction is to the right as indicated by the letter R. For the distance to the right, proceeding as in paragraph 6a with the group CQJ, the number 12.5 is obtained. The complete coordinates are therefore 49.2 miles from point of origin—right 12.5 miles.

SECTION I

	N	P	Q	R	S	T	V	W	X	Y
B	00	01	02	03	04	05	06	07	08	09
C	10	11	12	13	14	15	16	17	18	19
D	20	21	22	23	24	25	26	27	28	29
F	30	31	32	33	34	35	36	37	38	39
G	40	41	42	43	44	45	46	47	48	49
H	50	51	52	53	54	55	56	57	58	59
J	60	61	62	63	64	65	66	67	68	69
K	70	71	72	73	74	75	76	77	78	79
L	80	81	82	83	84	85	86	87	88	89
M	90	91	92	93	94	95	96	97	98	99

SECTION II

B	C	D	F	G	H	J	K	L	M
.0	.1	.2	.3	.4	.5	.6	.7	.8	.9
.9	.0	.1	.2	.3	.4	.5	.6	.7	.8
.8	.9	.0	.1	.2	.3	.4	.5	.6	.7
.7	.8	.9	.0	.1	.2	.3	.4	.5	.6
.6	.7	.8	.9	.0	.1	.2	.3	.4	.5
.5	.6	.7	.8	.9	.0	.1	.2	.3	.4
.4	.5	.6	.7	.8	.9	.0	.1	.2	.3
.3	.4	.5	.6	.7	.8	.9	.0	.1	.2
.2	.3	.4	.5	.6	.7	.8	.9	.0	.1
.1	.2	.3	.4	.5	.6	.7	.8	.9	.0

CONFIDENTIAL

SIGNAL COMMUNICATION

265

CONFIDENTIAL

SECTION III

	N	P	Q	R	S	T	V	W	X	Y
A	100	200	300	400	500	600	700	800	900	000
E	1,000	2,000	3,000	4,000	5,000	6,000	7,000	8,000	9,000	0,000
I	10,000	20,000	30,000	40,000	50,000	60,000	70,000	80,000	90,000	00,000

SECTION IV

	B	O	D	F	G	H	J	K	L	M
NULL	05	10	15	20	25	30	35	40	45	
NULL	50	100	150	200	250	300	350	400	450	
NULL	500	1,000	1,500	2,000	2,500	3,000	3,500	4,000	4,500	

	N	P	Q	R	S	T	V	W	X	Y
	50	55	60	65	70	75	80	85	90	95
	500	550	600	650	700	750	800	850	900	950
	5,000	5,500	6,000	6,500	7,000	7,500	8,000	8,500	9,000	9,500

NUMBER CHART

BY COMMAND OF LIEUTENANT GENERAL SMITH:

L. M. JONES,

*Brigadier General, General Staff Corps,
Chief of Staff.*

OFFICIAL:

/s/ R. L. BROWN

R. L. Brown,

*Lieutenant Colonel, General Staff Corps,
Assistant Chief of Staff, G-3.*

DISTRIBUTION: S.

CONFIDENTIAL

*k. Example of signal operation instructions pyrotechnic
code.*

CONFIDENTIAL

SIGNAL OPERATION INSTRUCTIONS

PYROTECHNIC CODE

NO. 12-1

IV Corps

MECHANICSBURG, PA.

23 April 1942, 0900

CONFIDENTIAL

CONFIDENTIAL

Effective 25 April 1942, 0001

<i>Signal</i>	<i>Meaning</i>
Signal, ground, white star parachute, M17.	Artillery is firing short.
Signal, ground, white star cluster, M18.	Lift barrage.
Signal, ground, green star parachute, M19.	Fire barrage.
Signal, ground, green star cluster, M20.	Objective taken.
Signal, ground, amber star cluster, M22	Understood.
Signal, aircraft, white star blinker, M15	Display panels, (identification or marking).
Signal, aircraft, green star blinker, M16.	Friendly pursuit aircraft.
Signal, aircraft, red star parachute, M11.	Understood.

BY COMMAND OF LIEUTENANT GENERAL SMITH:

L. M. JONES,
Brigadier General, General Staff Corps,
Chief of Staff.

OFFICIAL:

/s/ R. L. BROWN
 R. L. Brown,
Lieutenant Colonel, General Staff Corps,
Assistant Chief of Staff, G-3.

DISTRIBUTION: S.

CONFIDENTIAL

1. *Examples of signal operation instructions, radio frequencies, and call signs.*—For a type radio net organization for the infantry division, see figure 106. These examples are intended to illustrate only the forms in which information may be presented, and not to prescribe or limit the organization of radio nets.

(1) Example of assignment of radio frequencies:

RESTRICTED

SIGNAL OPERATION INSTRUCTIONS

RADIO FREQUENCIES

NO. 13-1

4th Infantry Division
 NEW CUMBERLAND, PA.
 24 April 1942, 0900

RESTRICTED

SIGNAL COMMUNICATION

265

RESTRICTED

Effective 25 April 1942, 0001

Designation of net	Period effective	Corps com-mand net	Div. command net	Div. command net (alternate)	Inf. rgt. com-mand net	Inf. rgt. com-mand net	Inf. rgt. com-mand net	Div. arty. com-mand net	Div. arty. AG net	Reconnal-sance net	Warning net
Net frequency	A-	2980	3860	3880	3960	4120	4340	4820	W-2520 X-2620 Y-2720 Z-2820 W-2540 X-2640 Y-2740 Z-2840	1620	3060
	B-	2950	3840	3890	3920	4330	4100	4860			
UNIT											
IV Corps.....		X									
4th Inf Div.....		X	X	X				X		X	X
31st Inf Div.....		X									
43d Inf Div.....		X									
8th Inf.....			X	X	X						X
1st Bn.....					X						
2d Bn.....					X						
3d Bn.....					X						
Vehicle Set No. 1					X						
22d Inf.....			X	X		X					X
1st Bn.....						X					
2d Bn.....						X					
3d Bn.....						X					
Vehicle Set No. 1						X					
29th Inf.....			X	X			X				X
1st Bn.....							X				
2d Bn.....							X				
3d Bn.....							X				
Vehicle Set No. 1							X				
4th Recn Troop.....										X	
Div Arty.....			X	X				X	X		
29th FA Bn.....								X	X		
Plane.....									X		
42d FA Bn.....								X	X		
Plane.....									X		
44th FA Bn.....								X	X		
Plane.....									X		
20th FA Bn.....								X	X		
Plane.....									X		

A—Frequencies in kilocycles for use April 25-27.

B—Frequencies in kilocycles for use April 28-30.

RESTRICTED

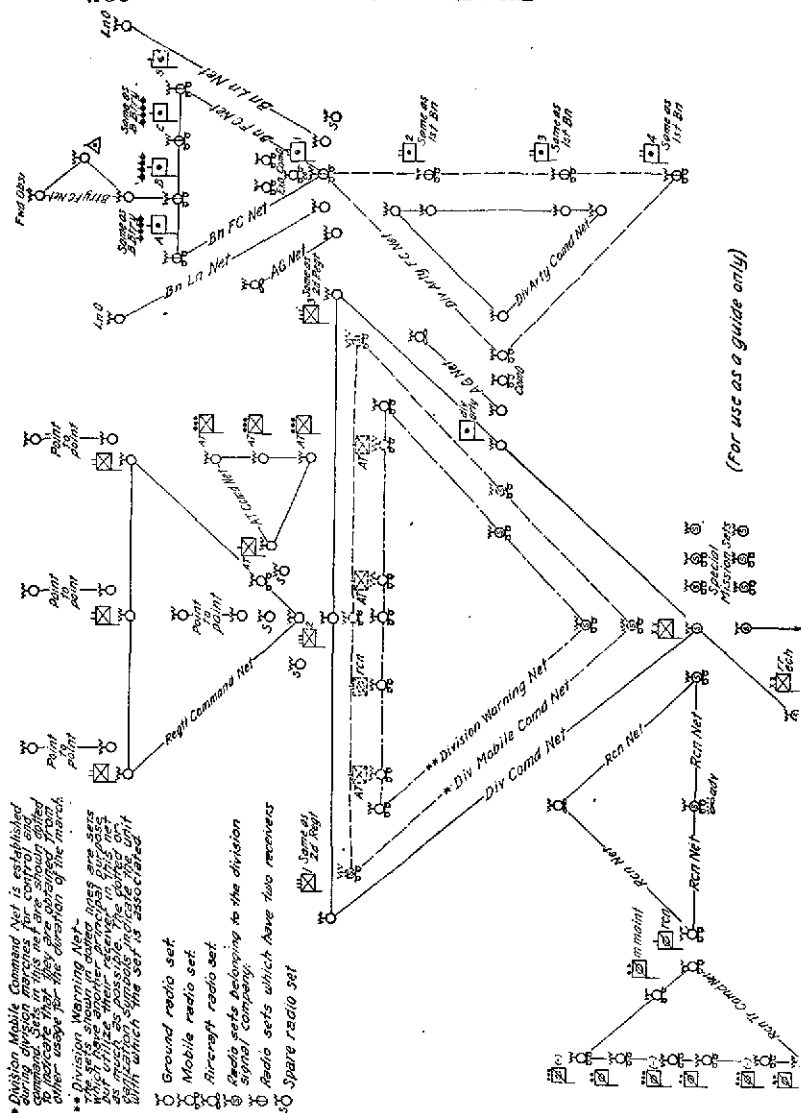

(312) FIGURE 106.—Type radio net organization for the infantry division.

RESTRICTED

Infantry regiment point to point nets.—The following frequencies are assigned to the infantry regiments as indicated. The assignment of frequencies within the regiments will be made by the regiment communication officers.

Organization	Radio set	Frequencies	Channel Nos.
8th Infantry.....	SCR-195	52.90	1
Do.....	do	54.10	4
Do.....	do	55.30	7
Do.....	do	56.50	10
Do.....	do	57.70	13
Do.....	do	58.90	16
Do.....	do	60.10	19
Do.....	do	61.30	22
Do.....	do	62.50	25
Do.....	do	63.70	28
Do.....	do	64.90	31
22d Infantry.....	do	53.30	2
Do.....	do	54.50	5
Do.....	do	55.70	8
Do.....	do	56.90	11
Do.....	do	58.10	14
Do.....	do	59.30	17
Do.....	do	60.50	20
Do.....	do	61.70	23
Do.....	do	62.90	26
Do.....	do	64.10	29
Do.....	do	65.30	32
20th Infantry.....	do	53.70	3
Do.....	do	54.90	6
Do.....	do	56.10	9
Do.....	do	57.30	12
Do.....	do	58.50	15
Do.....	do	59.70	18
Do.....	do	60.90	21
Do.....	do	62.10	24
Do.....	do	63.30	27
Do.....	do	64.50	30
Do.....	do	65.70	33

4th Infantry Division Field Artillery point to point nets.—The following frequencies are assigned to the field artillery battalions as indicated. The assignment of frequencies to units within the battalions will be made by the battalion communication officers.

RESTRICTED

RESTRICTED

Organization	Radio set	Frequencies	Channel Nos.
29th FA Battalion.....	SCR-194..	27.70 mc	1
Do.....	do.....	28.50	3
Do.....	do.....	29.30	5
Do.....	do.....	30.10	7
Do.....	do.....	30.90	9
Do.....	do.....	31.70	11
Do.....	do.....	32.50	13
Do.....	do.....	33.30	15
42d FA Battalion.....	do.....	28.10	2
Do.....	do.....	28.90	4
Do.....	do.....	29.70	6
Do.....	do.....	30.50	8
Do.....	do.....	31.30	10
Do.....	do.....	32.10	12
Do.....	do.....	32.90	14
Do.....	do.....	33.70	16
44th FA Battalion.....	do.....	34.10	17
Do.....	do.....	34.90	19
Do.....	do.....	35.70	21
Do.....	do.....	36.50	23
Do.....	do.....	37.30	25
Do.....	do.....	38.10	27
Do.....	do.....	38.90	29
Do.....	do.....	39.70	31
20th FA Battalion.....	do.....	47.30	50
Do.....	do.....	48.10	52
Do.....	do.....	48.90	54
Do.....	do.....	49.70	56
Do.....	do.....	50.50	58
Do.....	do.....	51.30	60

BY COMMAND OF MAJOR GENERAL WHITE:

ERNEST R. BLUE,
Colonel, General Staff Corps,
Chief of Staff.

OFFICIAL:

/s/ MARVIN O. ELM
Marvin O. Elm,
Lieutenant Colonel, General Staff Corps,
Assistant Chief of Staff, G-3.

DISTRIBUTION: S.

RESTRICTED

RESTRICTED

(2) Example of assignment of radio call signs:

SIGNAL OPERATION INSTRUCTIONS

RADIO CALL SIGNS

NO. 14-1

4th Infantry Division

NEW CUMBERLAND, PA.

24 April 1942, 0900

Unit	Effective 250001-251030	251631-261500	261501-280100
CORPS COMMAND NET.....	UKS		
IV Corps.....	DS4		
4th Inf Div.....	4MW		
31st Inf Div.....	XW3		
43d Inf Div.....	3GC		
DIVISION COMMAND NET.....	4GW	(Similar columns providing for changes of call signs are prepared for such other periods of time as may be desired.)	
4th Inf Div.....	4MW		
4th Rec Troop.....	5MJ		
4th Inf Div Arty.....	HR5		
8th Inf.....	H76		
22d Inf.....	EW4		
29th Inf.....	LV7		
DIVISION RECONNAISSANCE NET.....	DH7		
4th Inf Div.....	4MW		
4th Rec Troop.....	BJ5		
DIVISION ARTILLERY COM- MAND NET.....	51J		
Div Arty.....	HR5		
29th FA Bn.....	UV7		
42d FA Bn.....	H7R		
44th FA Bn.....	CW4		
20th FA Bn.....	RH5		
ARTILLERY AIR - GROUND NET.....	5EJ		
Div Arty.....	HR5		
29th FA Bn.....	UV7		
42d FA Bn.....	H7R		
44th FA Bn.....	CW4		
20th FA Bn.....	RH5		
Plane.....	2WB		
29th FA Bn.....	UV7		
Plane.....	2OR		
42d FA Bn.....	H7R		
Plane.....	2KB		
44th FA Bn.....	CW4		
Plane.....	2LR		
20th FA Bn.....	RH5		
Plane.....	2UR		

RESTRICTED

RESTRICTED

(2) Example of assignment of radio call signs—Continued.

Unit	Effective 250001-251630	251631-261500	261501-280100
INFANTRY REGIMENT COM- MAND NETS			
8th INF REGT NET.....	5QH		
8th Inf Regt Hq.....	H76		
1st Bn.....	7DV		
2d Bn.....	V7K		
3d Bn.....	RV7		
Vehicle Set No. 1.....	V7B		
22d INFANTRY REGIMENT NET.....	5XH		
22d Inf Regt Hq.....	EW4		
1st Bn.....	4CW		
2d Bn.....	W4V		
3d Bn.....	4NW		
Vehicle Set No. 1.....	EW4		
29th INFANTRY REGI- MENT NET.....	5PH		
29th Inf Regt Hq.....	LV7		
1st Bn.....	SH7		
2d Bn.....	YH7		
3d Bn.....	7BH		
Vehicle Set No. 1.....	H7K		

Code names for radio sets SCR-194, and SCR-195

	Channel	Code name	Channel	Code name
8th Inf, SCR-195.....	1	Magie.....	19	Mercy.
	4	Marvel.....	22	Mervin.
	7	Maytime.....	25	Moontide.
	10	Modest.....	28	Moonray.
	13	Morbid.....	31	M o o n - shine.
	16	Mortal.....		
22d Inf, SCR-195.....	2	Daring.....	20	Dexter.
	5	Dashing.....	23	Devil.
	8	Darling.....	26	Duty.
	11	Dory.....	29	Dungeon.
	14	Docile.....	32	Duffie.
	17	Dotage.....		

RESTRICTED

RESTRICTED

Code names for radio sets SCR-194, and SCR-195—Continued

	Channel	Code name	Channel	Code name
29th Inf, SCR-195.....	3	Fairy.....	21	Fiction.
	6	Fable.....	24	Filly.
	9	Fagin.....	27	Forage.
	12	Fertile.....	30	Forest.
	15	Fervent.....	33	Fortuna.
	18	Fervor.....		
29th FA Bn, SCR-194.....	1	Angle.....	9	Aper.
	3	Anzac.....	11	Apron.
	5	Alto.....	13	Acid.
	7	Album.....	15	Acme.
42d FA Bn, SCR-194.....	2	Bargain.....	10	Boston.
	4	Barkeep.....	12	Borrow.
	6	Bedside.....	14	Bundle.
	8	Bedtime.....	16	Britain.
44th FA Bn, SCR-194.....	17	Casket.....	25	Copper.
	19	Candy.....	27	Coddle.
	21	Carton.....	29	Custer.
	23	Castle.....	31	Cushion.
20th FA Bn, SCR-194.....	50	Gable.....	56	Guernsey.
	52	Gascon.....	58	Guilty.
	54	Gallop.....	60	Gunner.

BY COMMAND OF MAJOR GENERAL WHITE:

ERNEST R. BLUE,
Colonel, General Staff Corps,
Chief of Staff.

OFFICIAL:

/s/ MARVIN O. ELM
Marvin O. Elm,
Lieutenant Colonel, General Staff Corps,
Assistant Chief of Staff, G-3.

DISTRIBUTION: S.

RESTRICTED

(3) *Example of assignment of radio frequencies and call signs.*—In this example, the first figure given is the frequency in kilocycles, followed by the net call and call sign of the station, respectively. The final letter indicates the type of net as explained in the example.

RESTRICTED

SIGNAL OPERATION INSTRUCTIONS
RADIO FREQUENCIES AND CALL SIGNS

NO. 14-1

4th Infantry Division

NEW CUMBERLAND, PA.

24 April 1942, 0900

Unit	Effective 250001-251835	251836-271930	271931-021030
IV Corps.....	2980/UK8-DS4/A		
31st Inf Div.....	2980/UK8-XW3/A		
43d Inf Div.....	2980/UK8-3GC/A		
4th Inf Div.....	2980/UK8-4MW/A		
	3880/4GW-4MW/A		
	3880/4GW-4MW/B		
	1620/DH7-4MW/E		
	3060/4GW-4MW/F		
8th Inf.....	3060/4GW-II76/F		
	3960/5QH-H76/A		
1st Bn.....	3960/5QH-7DV/A		
2d Bn.....	3960/5QH-V7K/A		
3d Bn.....	3960/5QH-RV7/A		
Vehicle Set No. 1..	3960/5QH-V7B/A		
22d Inf.....	3060/4GW-EW4/F		
	4120/5XH-EW4/A		
1st Bn.....	4120/5XH-4CW/A		
2d Bn.....	4120/5XH-W4V/A		
3d Bn.....	4120/5XH-4NW/A		
Vehicle Set No. 1..	4120/5XH-EW4/A		
29th Inf.....	3060/4GW-LV7/F		
	4340/5PH-LV7/A		
1st Bn.....	4340/5PH-SH7/A		
2d Bn.....	4340/5PH-YH7/A		
3d Bn.....	4340/5PH-7BII/A		
Vehicle Set No. 1..	4340/5PH-H7K/A		
Div Arty.....	3880/4GW-HR5/A		
	4820/5IJ-HR5/C		
	W-2520, X-2620, /5EJ-HR5/D		
	Y-2720, Z-2820, /		
29th FA Bn.....	4820/5IJ-UV7/C		
	W-2520, X-2620, /5EJ-UV7/D		
Plane.....	Y-2720, Z-2820, /5EJ-20R/D		
42d FA Bn.....	4820/5IJ-H7R/C		
	W-2520, X-2620, /5EJ-H7R/D		
Plane.....	Y-2720, Z-2820, /5EJ-2KB/D		
44th FA Bn.....	4820/5IJ-CW4/C		
	W-2520, X-2620, /5EJ-CW4/D		
Plane.....	Y-2720, Z-2820, /5EJ-2LR/D		
20th FA Bn.....	4820/5IJ-RH5/C		
	W-2520, X-2620, /5EJ-RH5/D		
Plane.....	Y-2720, Z-2820, /5EJ-2WR/D		
	/5EJ-2UR/D		

(Similar columns providing for changes of call signs and frequencies are prepared for such other periods of time as may be desired.)

A—Command net.
B—Alternate command net.
C—Artillery command net.D—Artillery air-ground net.
E—Reconnaissance net.
F—Warning net.

RESTRICTED

SIGNAL COMMUNICATION

265

RESTRICTED

BY COMMAND OF MAJOR GENERAL WHITE:

ERNEST R. BLUE,
Colonel, General Staff Corps,
Chief of Staff.

OFFICIAL:

/s/ MARVIN O. ELM,
Marvin O. Elm,
Lieutenant Colonel, General Staff Corps,
Assistant Chief of Staff, G-3.

DISTRIBUTION: S.

RESTRICTED

m. Example of signal operation instructions telephone directory.—This is an example of an instance in which the division commander has prescribed the use of a telephone directory (see par. 175).

RESTRICTED

SIGNAL OPERATION INSTRUCTIONS

TELEPHONE DIRECTORY

NO. 15-1

4th Infantry Division
NEW CUMBERLAND, PA.
24 April 1942, 0900

Effective 25 April 1942, 0001

1. Telephone directory—names of switching centrals:

<i>Switching central</i>	<i>Name</i>
4th Infantry Division.....	FIRESTONE
4th Infantry Division, rear echelon.....	FREE
8th Infantry Regiment.....	FLOSS
22d Infantry Regiment.....	FOOT
29th Infantry Regiment.....	FLEET
4th Infantry Division Artillery.....	FARE
4th Engineer Battalion.....	FILE
31st Infantry Division.....	DEXTER
IV Corps.....	FOURTH CORPS

RESTRICTED

RESTRICTED

RED, WHITE, BLUE, OR GREEN added to the telephone directory name of the regiment switching central indicates the switching central of the 1st, 2d, 3d, or 4th Battalion respectively. Example: FLEET BLUE is the directory name of the switching central of the 3d Battalion of the 29th Infantry Regiment.

2. Telephone directory numbers—officers, and offices:

<i>Number</i>	<i>Title</i>
1-----	G-1 or S-1
2-----	G-2 or S-2
3-----	G-3 or S-3
4-----	G-4 or S-4
5-----	Chief of staff or executive officer
6-----	Commanding officer
7-----	Adjutant (division and higher units)
8-----	Ordnance officer
9-----	Inspector
10-----	Signal or communication officer
11-----	Message center (incoming)
12-----	Message center (outgoing)
13-----	Aide-de-camp
14-----	Air officer
15-----	Engineer officer
16-----	Surgeon or medical officer
17-----	Judge advocate
18-----	Finance officer
19-----	Chaplain
20-----	Postal officer
21-----	Quartermaster (not supply officer)
22-----	Chief of artillery or artillery officer
23-----	Chemical or gas officer
24-----	Liaison officer
25-----	Munitions officer
26-----	Pigeon loft
27-----	Provost marshal
28-----	Radio station
29-----	Reconnaissance officer
30-----	Telegraph office
31-----	Telephone wire chief or trouble chief

RESTRICTED

RESTRICTED

2. Telephone directory numbers—officers, and offices—Con.

<i>Number</i>	<i>Title</i>
32-----	Veterinarian
33-----	Public telephone
34-----	Headquarters commandant
35-----	Motor officer
36-----	Antitank officer
37-----	Special services officer

3. Telephone directory number—units:

<i>Number</i>	<i>Unit</i>
101-----	4th Signal Company
102-----	4th Medical Battalion
103-----	Division advance landing field
104-----	Headquarters and Military Police Company
105-----	4th Division observation post No. 1
106-----	4th Division observation post No. 2
107-----	4th Infantry Division railhead
108-----	4th Infantry Division quartermaster park
109-----	4th Infantry Division collecting station No. 1
110-----	4th Infantry Division collecting station No. 2
111-----	4th Quartermaster Battalion

4. Telephone directories will be attached to each telephone and switchboard. Tags showing the telephone directory name and number of that particular telephone will be securely attached to the telephone.

BY COMMAND OF MAJOR GENERAL WHITE:

ERNEST R. BLUE,
Colonel, General Staff Corps,
Chief of Staff.

OFFICIAL:

/s/ MARVIN O. ELM
Marvin O. Elm,
Lieutenant Colonel, General Staff Corps,
Assistant Chief of Staff, G-3

DISTRIBUTION: S.

RESTRICTED

n. Example of signal operation instructions wire tagging code.

RESTRICTED

SIGNAL OPERATION INSTRUCTIONS

WIRE TAGGING CODE

NO. 16-1

4th Infantry Division

NEW CUMBERLAND, PA.

24 April 1942, 0900

Effective 25 April 1942, 0001

1. The code names listed herein are for use in designating units on wire circuit tags.

2. The code names will be used as prescribed in paragraph 189 of FM 24-5.

3. Code names in the first column will remain in force until canceled by division order, at which time the second column will be used.

4. Lines will be tagged in accordance with FM 24-5.

	First period	Second period
Unit	Code name	Code name
4th Division.....	Asp	Owl
4th Division Artillery.....	Cat	Egg
8th Infantry.....	Dog	Perch
1st Battalion.....	Dough	Peach
2d Battalion.....	Doubt	Pet
3d Battalion.....	Dock	Pearl
12th Infantry.....	Frog	Sail
1st Battalion.....	Fret	Salt
2d Battalion.....	Frail	Sand
3d Battalion.....	Fruit	Sap
22d Infantry.....	Rat	Cow
1st Battalion.....	Ramp	Coot
2d Battalion.....	Race	Corn
3d Battalion.....	Rail	Cock
4th Signal Company.....	Mud	Dirt
34th Quartermaster Battalion.....	Duck	Hen

RESTRICTED

SIGNAL COMMUNICATION

265

RESTRICTED

	First period	Second period
Unit	Code name	Code name
4th Medical Battalion.....	Wren	Crow
604 Military Police Company.....	Cop	Crook
54th Engineer Battalion.....	Dig	Bridge
84th Reconnaissance Battalion.....	Hunt	Eye
37th Ordnance Control Point.....	Shell	Cap
4th Antitank Battalion.....	Can	Keg
104th Coast Artillery (AA) Battalion.....	Sky	Fly
194th Tank Battalion.....	Beo	Rose
37th Ordnance Company.....	Shock	Soup

BY COMMAND OF MAJOR GENERAL WHITE:

ERNEST R. BLUE,
Colonel, General Staff Corps,
Chief of Staff.

OFFICIAL:

/s/ MARVIN O. ELM
 Marvin O. Elm,
Lieutenant Colonel, General Staff Corps,
Assistant Chief of Staff, G-3.

DISTRIBUTION: S.

RESTRICTED

o. Example of signal operation instructions—daylight and moon phase chart.

RESTRICTED
SIGNAL OPERATION INSTRUCTIONS
DAYLIGHT AND MOON
PHASE CHART
NO. 17-1

IV Corps
 MECHANICSBURG, PA.
 24 April 1942, 0900

Effective 25 April 1942, 0001

1. The following table will be used to determine the approximate time of sunrise and sunset for the dates and areas shown. This table was calculated using FM 101-10 for latitudes and longitudes shown. Note that all tables are in 24-hour clock, War Time.

2. Daylight begins 1 hour before sunrise and dark begins 1 hour after sunset.

Date	Latitude 30 N Longitude 82 W South Atlantic Seaboard (Eastern War Time)		Latitude 30 N Longitude 90 W Mississippi Valley (Central War Time)		Latitude 30 N Longitude 98 W Texas Area (Central War Time)		Latitude 35 N Longitude 120 W South Pacific Seaboard (Pacific War Time)	
	Sunrise	Sunset	Sunrise	Sunset	Sunrise	Sunset	Sunrise	Sunset
April 21.....	0656	1958	0628	1930	0700	2002	0621	1937
May 1.....	0646	2005	0618	1937	0650	2009	0610	1945
May 11.....	0630	2011	0610	1943	0642	2015	0600	1953
May 21.....	0632	2018	0604	1950	0636	2022	0553	2001
May 31.....	0628	2024	0600	1956	0632	2028	0548	2008
June 10.....	0626	2028	0548	2000	0630	2032	0545	2013
June 20.....	0627	2032	0559	2004	0631	2036	0546	2017
June 30.....	0630	2033	0602	2005	0634	2037	0549	2018
July 10.....	0634	2032	0606	2004	0638	2036	0554	2016
July 20.....	0639	2029	0611	2001	0643	2033	0600	2012
July 30.....	0645	2023	0617	1955	0649	2027	0607	2005
Aug 9.....	0651	2015	0623	1947	0655	2019	0615	1956
Aug 19.....	0657	2006	0629	1938	0701	2010	0622	1944
Aug 29.....	0703	1955	0635	1927	0707	1959	0630	1932
Sept 8.....	0708	1943	0640	1915	0712	1947	0637	1918
Sept 18.....	0714	1930	0646	1902	0718	1934	0644	1904

RESTRICTED

SIGNAL COMMUNICATION

265

RESTRICTED

	New Moon	First Quarter	Full Moon	Last Quarter	New Moon	First Quarter	Full Moon	Last Quarter
January.....	16	24	2	10	6	13	21	29
February.....	15	22	1	8	4	11	20	27
March.....	16	24	2	9	6	13	21	28
April.....	15	23	land 30	7	4	12	20	27
May.....	15	23	30	7	4	12	19	26
June.....	13	21	28	5	2	10	18	24
July.....	13	21	27	5	2and 31	10	17	23
August.....	11	19	25	3	30	8	15	22
September.....	10	17	24	2	29	7	13	21
October.....	9	16	23	2	28	6	13	20
November.....	8	15	22	land 30	27	4	11	19
December.....	7	14	22	30	26	4	11	19

BY COMMAND OF LIEUTENANT GENERAL SMITH:

L. M. JONES,

*Brigadier General, General Staff Corps,
Chief of Staff.*

OFFICIAL:

/s/ R. L. BROWN

R. L. Brown,

*Lieutenant Colonel, General Staff Corps,
Assistant Chief of Staff, G-3.*

DISTRIBUTION: S.

RESTRICTED

p. Example of signal operation instructions prearranged message code.

CONFIDENTIAL

SIGNAL OPERATION INSTRUCTIONS

PREARRANGED MESSAGE CODE

NO. 18-1

4th Infantry Division

NEW CUMBERLAND, PA.

24 April 1942, 0900

Effective 25 April 1942, 0001

1. This code is to be used when operating with division headquarters signal communication units. It is intended primarily for the rapid transmission of certain messages when danger of hostile interception exists and transmissions in the clear are not authorized. Other cryptograph methods should be used for meanings not listed herein, when secrecy is required.

2. Regiment and separate units of this division may prepare prearranged messages appropriate for their use. Such prearranged message codes will be changed frequently. (See par. 48*d*, FM 24-5.)

<i>Code group</i>		<i>Meaning</i>
<i>Telegraphic</i>	<i>Telephonic</i>	
AB	AFIRM BAKER	Combat team 8 now at.....
CF	CAST FOX	Combat team 22 now at.....
RY	ROGER YOKE	Combat team 29 now at.....
GJ	GEORGE JIG	No change in enemy situation.
KN	KING NEGAT	Enemy contacted.
LO	LOVE OPTION	Corps command post now at.....
TY	TARE YOKE	Attack launched.

BY COMMAND OF MAJOR GENERAL WHITE:

ERNEST R. BLUE,

*Colonel, General Staff Corps,
Chief of Staff.*

OFFICIAL:

/s/ **MARVIN O. ELM**

Marvin O. Elm,

*Lieutenant Colonel, General Staff Corps,
Assistant Chief of Staff, G-3.*

DISTRIBUTION: S.

CONFIDENTIAL

APPENDIX I

WIRE COMMUNICATION EQUIPMENT

■ 1. WIRE-LAYING EQUIPMENT.—*a. Reel unit RL-31* (fig. 107).—(1) The reel unit RL-31 is a lightweight portable frame and mounting designed to facilitate the reeling and unreeling of field wire by hand. The unit uses either one reel DR-5 or two reels DR-4.

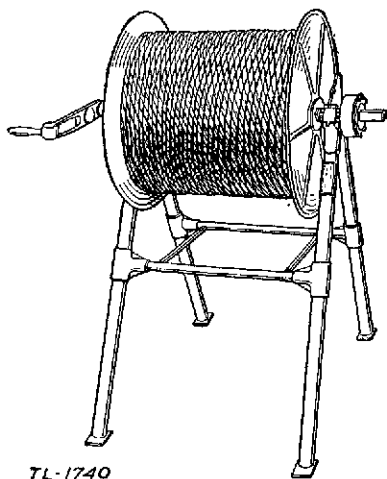

FIGURE 107.—Reel unit RL-31 with reel DR-5.

(2) The reel unit may be set up on the ground, mounted in a vehicle, or secured to the tailboard thereof. It may also be used as a carrying frame, similar to a litter, for use by two men using carrying straps to help support the weight of the frame and reel. One man may use it as a rolling frame in wheelbarrow fashion.

BASIC FIELD MANUAL

(3) The reel unit consists of a folding tubular aluminum alloy frame with bearings for a steel axle equipped with a removable hand crank. A brake is provided to prevent the reels from overspinning while unreeling. Two tailboard hangers with bolts are provided to facilitate mounting the reel unit on the tailboard of a truck or wagon. Four toe



FIGURE 108.—Axle RL-27 showing removable handle.

plates are provided to hold the reel unit securely in place when it is mounted on the floor of the vehicle. (See TM 11-362.)

b. Axles RL-27 and RL-27-A (figs. 108 and 109).—The axle RL-27 is a simple form of wire-laying device for laying short

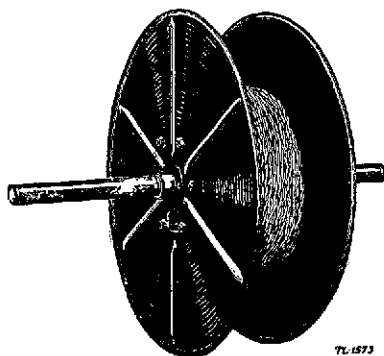
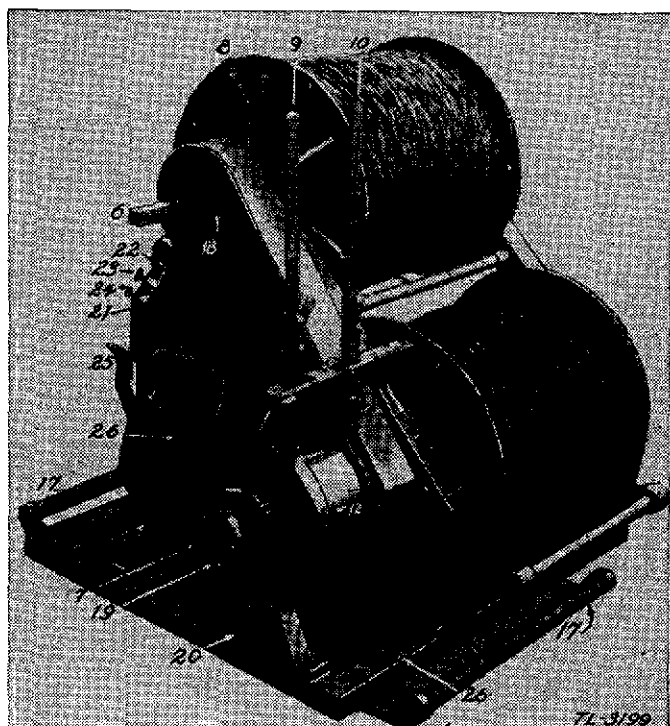

FIGURE 109.—Axle RL-27 with reel DR-4.

local circuits by hand. It can be used to lay lines where conditions do not permit the use of other wire-laying equipment. The axle RL-27 is a machined steel bar, about 2 feet long, with two knurled aluminum handles, one of which is permanently fixed to the bar. The other can be removed to

SIGNAL COMMUNICATION



- | | |
|---|----------------------|
| 6 and 7. Axles for reels. | 20. Axle tool. |
| 8. Secondary clutch lever for upper axle. | 21. Control panel. |
| 9. Main clutch lever for lower axle. | 22. Ignition switch. |
| 10. Main clutch lever for upper axle. | 23. Throttle. |
| 12. Clutch drum. | 24. Choke. |
| 17. Skid frame. | 25. Pedal starter. |
| 18 and 19. Axle latches. | 26. Exhaust pipe. |

FIGURE 110.—Reel unit RL-26 with two reels DR-5 in position.

BASIC FIELD MANUAL

permit placing a reel DR-4 on the axle. The reel DR-5 will not fit on the axle RL-27. The axle RL-27-A is a modification of the axle RL-27 with an improved type of roller bearings.

c. Reel unit RL-26-A.—Reel unit RL-26-A is a transportable wire-laying and wire-recovering machine intended primarily for temporary or permanent installation in motor-trucks. It may be operated while the vehicles are stationary or in motion. Dismounted, the unit may also be operated in temporary fixed positions on the ground. All component parts are assembled on a skid frame which can be quickly installed in the back of a vehicle. The capacity of the unit is two reels DR-5; mounted in position for paying out or reeling in the wire. The individual reels are readily replaceable. The wire can be payed out from either reel singly or from both simultaneously, and means are provided for braking the reels to prevent overspinning. By means of a small gasoline engine, the wire can be reeled in on either reel separately or on both at the same time (fig. 110). It can also be reeled in by hand cranking when the engine is inoperative. The weight of the RL-26-A, without reels, is about 346 pounds. The unit fully loaded with 2 miles of wire weighs approximately 690 pounds.

The method of laying wire from a reel unit RL-26-A mounted in a truck is shown in figure 111. More complete descriptions of the operation and maintenance of these reel units may be found in TM 11-360.

d. Reel cart RL-16 (fig. 112).—This is a cart which may be pulled by hand or towed behind a communication cart. It should not be towed behind a fast-moving vehicle. Each reel cart carries two reels DR-4 which are removable, and the axle is equipped with a detachable hand crank for recovering wire on the reels. A single reel DR-5 can be placed on the cart by removing the spacer bar on the axle. The reel cart may be taken apart for packing.

e. Reel equipment CE-11.—This is a breast reel and telephone handset carried by the individual soldier as illustrated in figure 113. It consists of reel unit RL-39 and handset TS-10. The reel unit RL-39 comprises a reel DR-8, carrying handles for the reel which incorporate the supported bearings, a square-shaft axle with crank for rewinding, and

SIGNAL COMMUNICATION

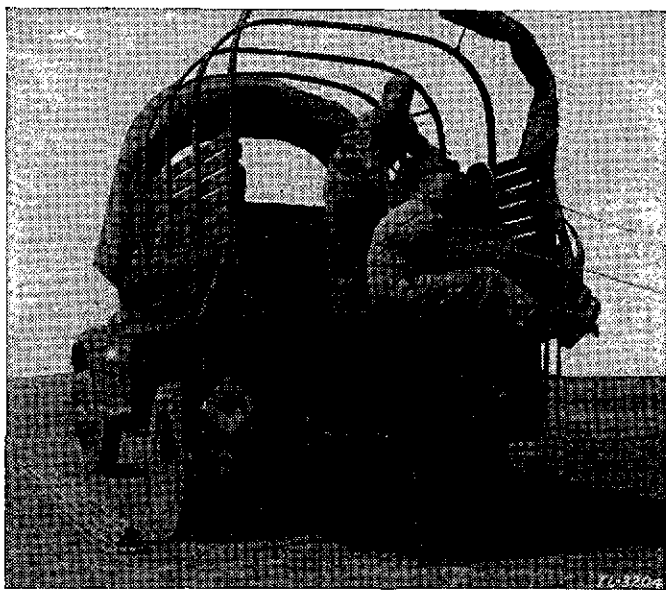

FIGURE 111.—Laying field wire from truck-mounted reel unit RL-26-A.

BASIC FIELD MANUAL

carrying straps. The method of carrying the handset shown in figure 111 permits the operator to hear a prearranged signal for attracting his attention without the necessity of continuously holding the handset to his ear. To lay wire with this equipment, the handles are unsnapped from the carrying straps and the reel is then carried by the handles at the side of the soldier permitting the reel to rotate freely. To recover wire, the carrying handles are snapped to the carrying straps and the reel rotated by means of the axle and crank as the operator walks toward the opposite end of the line.

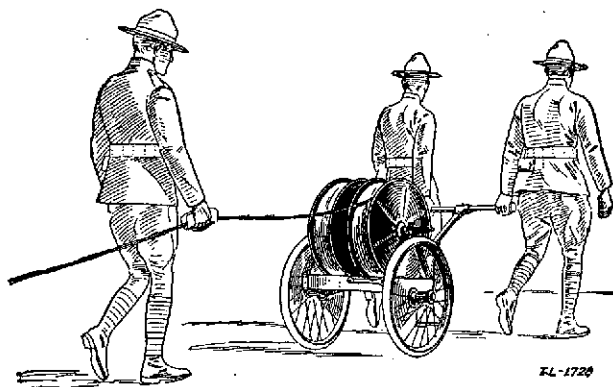

FIGURE 112.—Reel cart RL-16.

f. Commercial spools.—If wire is issued on commercial spools, it may be laid by inserting an iron bar through the axial opening in the spool and paying out the wire from a truck or wagon; or two men may carry the spool on the bar and pay out the wire while walking along the route.

g. Pack carriers.—Pack-saddle carriers are available for transporting several reels DR-4 on the back of a pack animal. Field wire may be payed out or reeled in directly from the mounted reels.

SIGNAL COMMUNICATION



FIGURE 113.—Reel equipment CE-11.

■ 2. TYPES OF FIELD TELEPHONES.—a. Telephone EE-8-A.—

The field telephone EE-8-A can be used on either local battery or common battery systems and has other applications described in TM 11-333. Two batteries BA-30 are required with the instrument; these are not supplied as part of the telephone and must be requisitioned separately. An external 3-volt battery may be used instead of the two batteries BA-30 provided it is connected to the external battery binding posts and the internal batteries are removed. A view of the telephone EE-8-A with the case opened is shown in figure 114. The handset and cord fit into the compartment shown when the instrument is not in service.

BASIC FIELD MANUAL

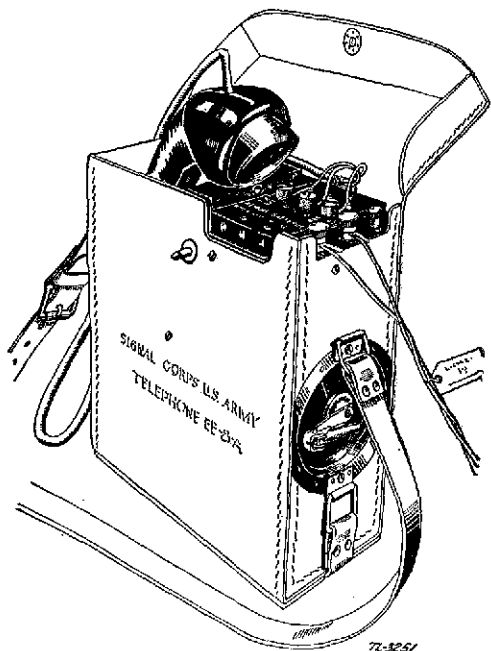

FIGURE 114.—Telephone EE-8-A, case opened.

(1) *Installation.*—Place two batteries BA-30 in the compartment under the lever switch, accessible when the hand-set is removed from the case. Make certain that the bottoms of the batteries rest on the springs and that the brass caps rest securely on the contacts at the top of the battery compartment. Connect the field wire conductors to the binding posts L_1 and L_2 .

(2) *Operation.*—(a) *Local battery.*—For use on local battery systems, turn the screw switch near the lever switch (fig. 115) with a screw driver counterclockwise toward LB until it comes to a stop.

SIGNAL COMMUNICATION

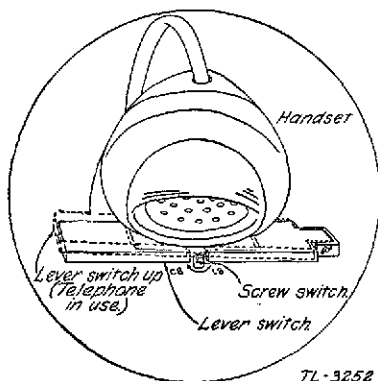

FIGURE 115.—Position of handset on lever switch in common battery operation.

1. *To signal.*—Turn the generator rapidly for several turns. The position of the handset or lever switch is immaterial.
2. *To talk and listen.*—Hold the handset with the receiver to the ear. While talking, operate the handset switch with the thumb and talk directly into the transmitter. When listening only, release the switch to conserve the battery strength; this does not reduce the receiver sensitivity, but does cut out any extraneous noises originating near the telephone.
3. *To ring off.*—If the circuit is established through a switchboard, ring off by two or three sharp turns of the generator when the conversation is completed. This indicates to the switchboard operator that the conversation is ended or that a new connection is desired. After ringing off, if a new connection is not desired, replace the handset in the case, leaving the cord hanging out.

(b) *Common battery.*—Turn the screw switch near the lever switch clockwise toward CB with a screw driver until it comes

BASIC FIELD MANUAL

to a stop. The lever switch (fig. 115) is an essential part of the telephone in common battery operation, corresponding to the hook or plunger switch on commercial telephones. The handset when not in use is placed with the transmitter up, resting upon and depressing the lever switch. This is the position of the handset on the lever switch shown in figure 115.

1. *To call.*—Remove the handset from its position on the lever switch. (The lever switch is then released, as shown by the dotted lines in figure 114.) If the switchboard operator does not answer, depress and release the lever switch *slowly* several times, which flashes the line lamp at the switchboard, giving notice to the operator.
2. *To talk and listen.*—Proceed as in (a) 2 above. The BA-30 batteries furnish talking current for common battery as well as local battery operation.
3. *To recall operator.*—Push the lever switch down and release *slowly* several times.
4. *To indicate completion of call.*—Place the handset as shown in figure 115, depressing the lever switch.

(3) *To close station.*—Before disconnecting the telephone from a wire circuit, the person removing the telephone should call the switching central or other party on the line informing him that the telephone is being removed from the circuit. Remove the connections to L_1 and L_2 . Remove the batteries BA-30, unless the telephone is to be installed on another circuit immediately, as highly corrosive chemicals injurious to the telephone leak out of run-down batteries. Fold the rubber-covered cord loosely into folds about as long as the handset, place the folds alongside the handset, and insert the handset (receiver end first) into the case as shown in figure 113. The cord may also be conveniently handled by holding the handset in the left hand, placing the thumb against the receiver case, and wrapping the cord in long folds completely around the handset. In either case, *do not wrap the cord around the handle of the handset* as that is injurious to the cord and may operate the handset switch. The switch must be left in the neutral position (wings parallel to the

SIGNAL COMMUNICATION

handset body) to prevent rapid running down of the batteries if still in the instrument.

b. *Telephone EE-8.*—The field telephone EE-8 operates on local or common battery circuits and is described in TM 11-333. It is similar to the telephone EE-8-A.

c. *Telephone EE-5.*—(1) *Description and installation.*—The telephone EE-5, shown in figure 116, can be used only on local battery circuits. One battery BA-9 (4½ volts) is required, and it is inserted in a spring clip just below the top

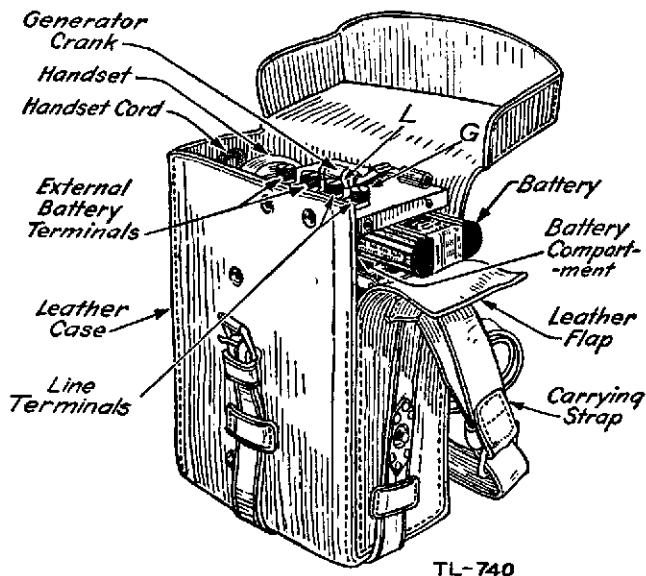

FIGURE 116.—Telephone EE-5.

of the frame. The battery is covered by the leather flap formed by one side of the case. Two screws which hold this flap to the frame must be removed to insert the battery, after which the screws should be replaced. The top of the frame is a hardwood panel on which are two knurled screw driver binding posts marked L and G to which the line wires are connected. Two similar binding posts are provided for ex-

BASIC FIELD MANUAL

ternal battery (if an external battery is used, it should not exceed $4\frac{1}{2}$ volts and the internal battery BA-9 must be removed). A clip on the panel holds the generator crank when the telephone is packed for transportation. To use the generator, remove the crank from the clip and screw it on to the generator shaft at the side of the case. Misplaced or lost generator cranks render the instrument useless for calling purposes, and particular care should be taken that this does not occur. The handset is provided with a push button switch which must be depressed in order to talk, but the receiving circuit is always in operation, regardless of the position of the push button.

(2) *Operation.*—(a) *To signal.*—Turn the generator crank rapidly for several turns.

(b) *To talk and listen.*—Hold the handset with the receiver to the ear, depress the push button on the handset with the thumb, and talk directly into the transmitter. When listening only, release the push button to conserve battery, as its depression is then not necessary.

(c) *To ring off.*—When the conversation is completed, ring off by two or three sharp turns on the generator crank. This signals the operator that the conversation is ended or that another connection is desired. Ringing off is required only when the telephone is connected to a switchboard.

■ 3. FIELD TELEPHONE SWITCHBOARDS.—a. *Switchboards BD-72 and BD-71.*—Switchboards BD-72 and BD-71 are portable, monocord, telephone switchboards for use primarily on field wire systems. See TM 11-330 for complete descriptions. The switchboard BD-72 (fig. 117) accommodates 12 telephone lines and includes four permanently connected repeating coils; the switchboard BD-71 accommodates six telephone lines and includes two permanently connected repeating coils. The height of the writing shelf (front cover of the carrying case) of either switchboard is 24 inches when the mounting legs are fully extended. Both types require a total of 12 batteries BA-30. Six batteries are necessary for operation; the remainder are spares.

(1) *Installation.*—If the switchboard is placed on a table, leave the legs folded and locked in place. Otherwise, turn

SIGNAL COMMUNICATION

the case on its side, unlock and unfold the legs, extending them to full length by pressing the spring release button on each leg. Lift the switchboard up and place all four legs firmly on the ground. Open the front compartment; the lower panel serves as a desk and the upper panel can be pushed back into the recess beneath the top of the case, or



FIGURE 117.—Switchboard BD-72 set up for operation.

it may be adjusted as a rain or sun shield. Pull out the cords from under the switchboard line units, allowing them to hang down freely in front of the shelf. The plugs should clear the ground so as not to collect dirt which may later foul the line jacks. Lower the spring locking bars on the signal drops of the line units to the horizontal position. The drops should fall freely of their own weight when energized by an

BASIC FIELD MANUAL

incoming signal; this may require a slight forward tilt of the switchboard front. Open the battery case inside the rear compartment (fig. 118). Place two batteries BA-30 in series

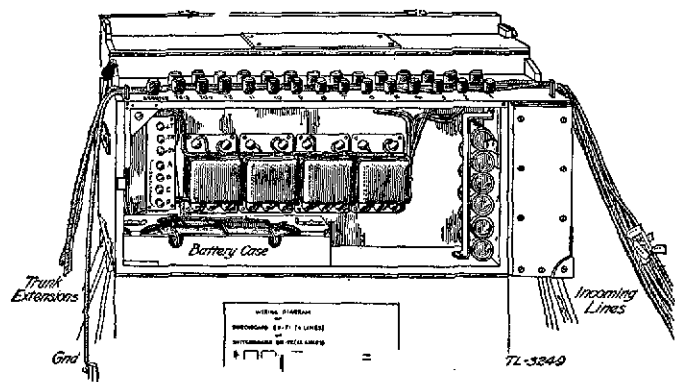

FIGURE 118.—Rear view of switchboard BD-72, with compartments opened.

in the right-hand division of the case; these furnish talking current for the operator's set. Place two pairs of batteries in series in the left-hand division; these operate the night alarm and panel lights. The bottoms of the batteries must make good contact to the coiled springs. The brass caps of the other batteries of any pair should seat firmly on the contact plate in the middle of the compartment. The contact between the batteries of a pair should likewise be clean and firm. Tighten all connections and in general care for the switchboard as outlined in paragraph 212. The operator's head and chest set is plugged into the panel on the left of the switchboard units. The three binding posts marked T, C, and R immediately above the plug receptacle are paralleled with the plug contacts; this makes possible the use of a field telephone handset or other suitable telephone transmitter and receiver in an emergency. Terminal T connects to the telephone transmitter, R to the receiver and C to the common connection between them.

(2) *Preliminary tests.*—Select any line unit and see that the corresponding line binding post in the terminal com-

SIGNAL COMMUNICATION

partment is clear. Raise the key of the line unit to the "ring" position (up) and crank the ringing generator. It should turn freely. Short-circuiting the two line terminals should produce a definite drag on the generator when the key is in the "ring" position. Remove the short circuit. Blow lightly into the transmitter (chest toggle switch in locked position) and throw the key of any line unit to the "talk" position (down). Sidetone should be clearly audible with the switch down, but not present when in the neutral position. Connect a serviceable field telephone to the line binding posts of the first line unit. Crank the generator of the field telephone. The line drop of the first unit should fall. Test the night-alarm circuits by throwing the NT AL toggle switch to the right. The alarm bell should start ringing and stop when the line drop is reset. Ring the field telephone by cranking the generator and throwing the key to "ring" (up). The bell or buzzer of the field telephone should operate energetically. Depress the key to the "talk" position (down). Conversation should be possible without sensible effort. Test each line successively in the same manner.

(3) *Line connections.*—Connect field wire lines, properly tagged, to the binding posts (numbered in pairs from 1 to 6 in the BD-71 and 1 to 12 in the BD-72) in the top rear compartment of the switchboard (fig. 113). The binding posts on the line terminal strip are of the type not requiring skinning of insulation unless the contact is found to be unsatisfactory, in which case a small amount of insulation is stripped and the bared wire secured in the binding post slot by tightening the knurled head of the post by hand. Each pair of posts is connected internally to a correspondingly marked line unit, comprising a line drop, plug and cord, jack, and key switch. The field wires may enter the line compartment from either the left or right but should place no mechanical strain on the switchboard. (See figure 117.) This arrangement also prevents water from running down the field wires into the switchboard. Trunk lines should be connected to the lower-numbered line circuits on the board since these are connected to the repeating coils for simplex use. (Line circuits 1 and 2 on the 6-line BD-71 and 1, 2,

BASIC FIELD MANUAL

3, and 4 on the 12-line BD-72 switchboards.) Local circuits should be connected to the higher-numbered line circuits. This is a convenient manner of distinguishing between trunk and local circuits and facilitates switchboard operation. Since trunk circuits are likely to be extended along the axis of signal communication, such trunks should enter the switchboard from one end and be carried completely through the switchboard, with about 3 feet being allowed to hang freely from the opposite end (fig. 118). (The free ends of these wires should be taped.) When the extended circuits are ready to be cut in, the trunks are connected to the 3-foot extensions without disconnecting the circuits from the switchboard. When the splices are completed, the new switchboard at the extended position takes over. The trunk lines are then removed from the binding posts and the wires taped. Continuity of communication is thereby maintained. The telegraphed legs of the simplex line circuits are marked TG-1, TG-2, in the BD-71; TG-1, TG-2, TG-3, and TG-4 in the BD-72 (fig. 118). The GROUND binding post should be connected to a metal ground rod or stake driven in the earth near the switchboard. This provides lightning protection to the system by means of small spark-gaps between each line terminal and ground. Grounds for simplex circuits must be independent of the switchboard ground connection.

(4) *Operation.*—(a) *Operator's equipment.*—The operator should be seated so that he may observe all drops and conveniently operate the switchboard. The head and chest set should be adjusted for comfort, with the mouthpiece about $\frac{1}{2}$ inch from the operator's lips, and the toggle switch on the chest unit set to the lock position to close the transmitter circuit. The switch is left in that position since the circuit is not complete (and the talking batteries thereby conserved) unless a key of a line unit is in the "talk" position. The night alarm is turned on by the NT AL toggle switch and the panel lights, used only for answering calls at night by the LT toggle switch.

(b) *Incoming call.*—An incoming call is indicated by the falling of the line drop of the calling line. (This will operate the night alarm if the night alarm switch is on the NT

SIGNAL COMMUNICATION

AL position.) Depress the key of the calling line unit to the "talk" position (down) and answer the party (or central) calling, at the same time picking up the calling party's plug. After determining the party (or central) to be called, restore the calling party's key to the neutral (mid) position. Ring the called party by raising the key of that line unit to the "ring" position (up) and turning the generator crank rapidly several times. **Caution:** Ringing back into the ear of the calling party is very objectionable, and will result if the calling party's key switch is not restored to neutral (midposition) before ringing the called party. Immediately after ringing, depress the called party's key to "talk" and, if it is a local call, insert the calling party's plug into the called party's jack. If it is a trunk call, pass the call to the distant operator before making the connection. After the connection has been made, the operator's telephone is bridged across the connection enabling him to supervise the call. The called party's key may be left down until conversation has actually begun, or in the case of a trunk call, until the call has been passed to the distant operator. When the call has been supervised the called party's key and the calling party's drop should be restored. In case it is necessary for the operator to answer another call before he has properly supervised the first connection, he restores the key but leaves the drop down and proceeds to handle the other call. He then goes back at the first opportunity and supervises the first connection, restoring the drop after he has done so. A drop is not restored on a connection until it has been supervised, and when left in the "down" position indicates a connection that still requires supervision. A connection that has been established and which is in use can be supervised by depressing the key of the called party's line unit, listening, and challenging if necessary. The operator should not throw two keys in the "talk" position at the same time, since the two circuits would thereby be coupled through the operator's set, resulting in crosstalk on both circuits. After talking to either party, the operator always restores his key to midposition before beginning any other operation.

(c) *Completed call.*—When a conversation is completed and either of two connected parties rings off, that is, turns the

BASIC FIELD MANUAL

generator of his telephone, the drop of the calling party's line unit will fall. The operator should then depress the key and answer the signal to see if either party desires another connection. If no reply is received, he takes down the connection by removing the plug from the called party's jack and restores the drop and key. *Caution:* Never pull on cord to remove plug from jack. The line drop of the other unit will not fall, since it was automatically removed from the circuit when the plug of the calling party was inserted in the jack of the unit. In case another call is desired by either party, the operator must ascertain which party desires another connection by asking which party is calling.

(5) *Conference call.*—Inform the calling party desiring the conference connection that he may hold the line or not, as he desires. Restore the calling party's key. Ring the first of the called parties, depress this party's key, and when he answers advise him to hold the line for a conference call. Restore his key and insert the calling party's plug in his jack. Pick up the first called party's plug and ring the second called party. Depress this party's key and when he answers advise him also to hold the line for a conference call. Restore his key and then insert the first called party's plug into the second called party's jack. Extend the connection in a similar manner to each of the called parties in turn. When the last of the called parties has been connected, restore his key, depress the key of the calling party, and if he is not already on the line, ring him. When the calling party answers, inform him that all parties are now on the line. When the conversation has begun, restore the calling party's key and drop. All parties are bridged together (at the switchboard) so that each can talk or listen to any of the others. The drop of the calling party remains bridged across the connection for a supervisory signal as in an ordinary call. The connection may be supervised by depressing the key of any one of the connected line units.

(6) *Removal from service.*—Before removing any connections, notify all parties connected that the switchboard is being removed from service. When the switchboard is to be removed from service, disconnect all lines from the terminal

SIGNAL COMMUNICATION

strip. Remove the batteries from the case if the switchboard is not to be again placed in service within 24 hours. Put the operator's chest and headset in the left front compartment. Lock all line drops. Clean out any dust or dirt accumulations. Place the line cords under the line units. Carefully close all the covers and retract and lock the legs of the switchboard.

b. *Switchboard BD-14.*—For the installation, operation, and maintenance of switchboard BD-14, see TM 11-331.

c. *Switchboards BD-11 and BD-9.*—(1) *Description.*—(a) Switchboards BD-11 and BD-9 are identical in design except for line capacity; the BD-11 accommodates 12 lines, and the BD-9 accommodates four lines. A fiber carrying case with carrying strap is provided for protection of switchboards in transportation. No terminal strips, repeating coils, or operator's telephone set are included in the switchboard. Any field telephone may be used as the operator's telephone. Repeating coils, if required, are installed as described in paragraph 215. When found desirable to do so, each switchboard may be equipped with a switchboard cable and terminal strip as explained in (b) below. This should be done prior to taking it into the field. These then remain integral parts of the switchboard and should not be disconnected except for replacement.

(b) To prepare cable for these switchboards cut wire W-110-B (or similar twisted pair field wire) into 11-foot lengths, cutting one more length than there are units on the switchboard. Connect one pair of wires to the line terminals of the left-hand switchboard line unit, and temporarily attach the other end of the pair to the upper left-hand pair of binding posts on a terminal strip placed about 10 feet from the switchboard. Connect the remaining lengths of wire similarly in order from left to right on the switchboard and from top to bottom on the terminal strip. Leave the extra pair sufficiently long so that each free end will reach any pair of binding posts; this is a spare pair for use in case one of the others becomes unserviceable. Lace the wires together neatly and securely with a piece of lacing twine or other stout cord. Begin at the switchboard and use a lock-stitch. Work toward the terminal strip in lacing, spacing the

BASIC FIELD MANUAL

stitches about $1\frac{1}{2}$ inches apart, pushing the slack in the wires ahead of the lacing so as to make a neat and compact cable. Figure 119 ① shows the method of starting the lacing; ② the serving completed and the beginning of the lacing cord snubbed; ③ the lockstitch and the method of securing the end of the cord by a double stitch (two half hitches); finally, ④ shows the completely laced cable.

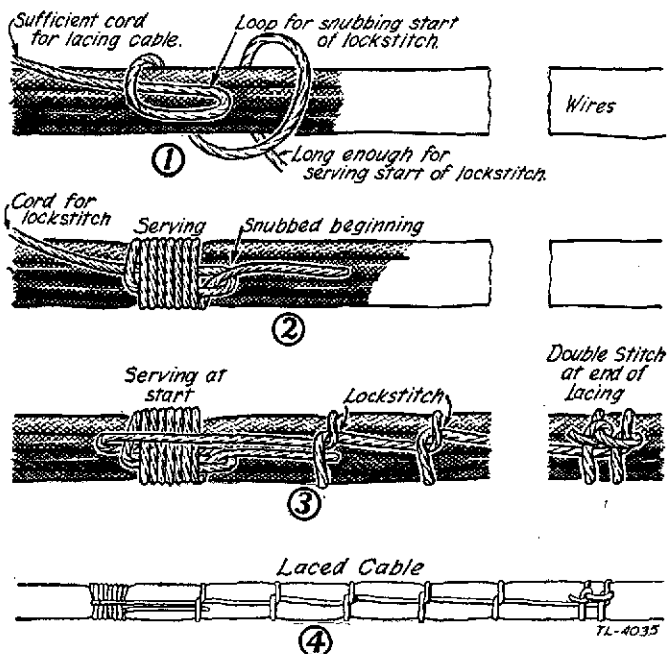

FIGURE 119.—Method of lacing cable using lockstitch.

At the terminal strip, the wires of each pair should come out as a pair opposite the proper left-hand binding posts on the terminal strip. Form the wires along the side of the terminal strip and cut them so that each will be of the proper length for attaching to its proper binding post, and then attach them in the same order as before. Leave the ends of the spare pair free until the cable is completed, then

SIGNAL COMMUNICATION

lace them down with a separate piece of twine. In order to relieve the terminal connections of all strain, secure the completed cable to the wooden part of the switchboard by clamping it with strips of leather held down with screws

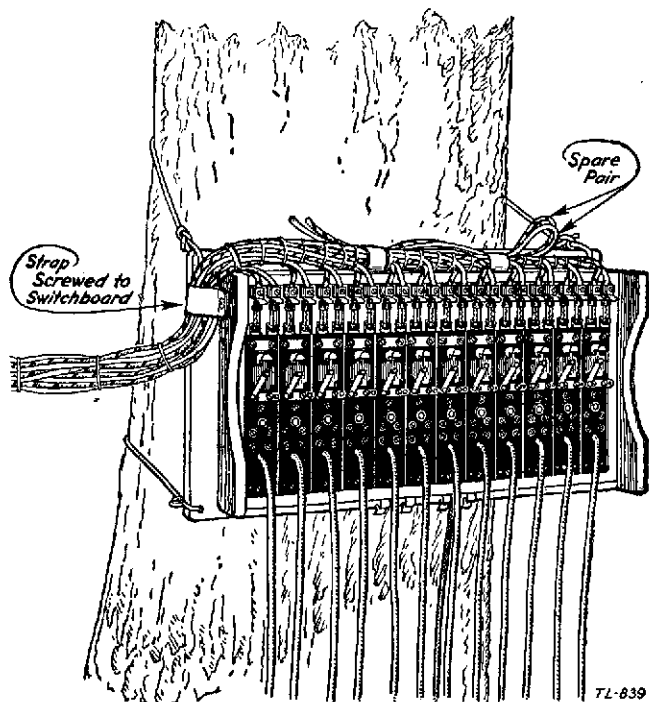

FIGURE 120.—Cable secured to monocord switchboard.

(fig. 120). Mount the terminal strips on a wood strip and secure the cable to the wood to relieve the terminal strip binding post connections of strain. Coil the cable during transportation for protection.

(2) *Installation.*—The switchboard with cable and switchboard terminal strip attached may be installed in the following manner:

(a) Secure the switchboard to a support with wire or stout

BASIC FIELD MANUAL

cord. Do not drive nails through any part of the frame. The switchboard should tilt slightly forward to permit the shutters to fall when released, and the plugs must not touch the ground (fig. 121).

(b) Install the switchboard terminal strip out of the way

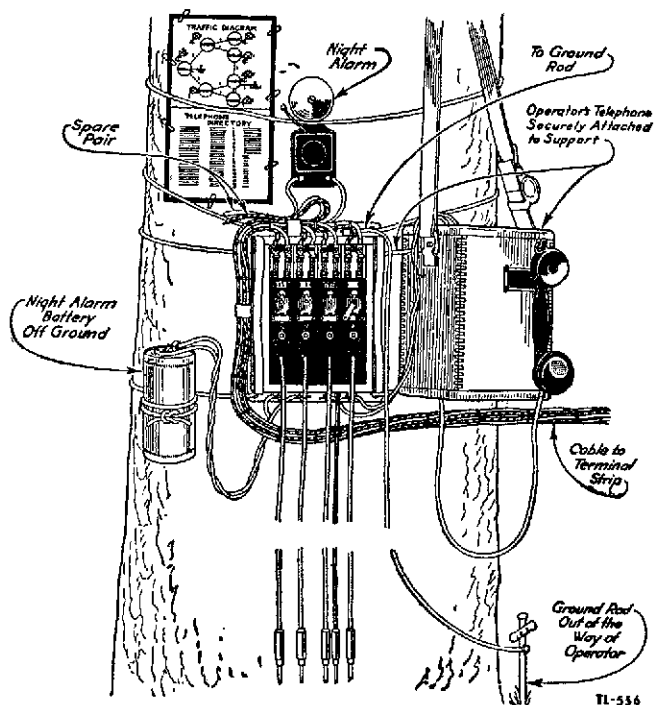

FIGURE 121.—Installation of monocord switchboard.

of the operator, but conveniently placed for maintenance personnel to work thereat. Route the cable from the switchboard to the terminal strip so as to afford protection to the wires (fig. 122).

(c) Connect the operator's telephone to the spring clip terminals on the switchboard marked L_1 and L_2 . Connect a low resistance buzzer or bell as a night alarm across the

SIGNAL COMMUNICATION

terminals marked A and A₁ and a dry battery for operating the night alarm across terminals marked B and B₁. Connect a wire from the terminal marked G to a suitable metal ground rod or stake driven in the ground near the switchboard (par.

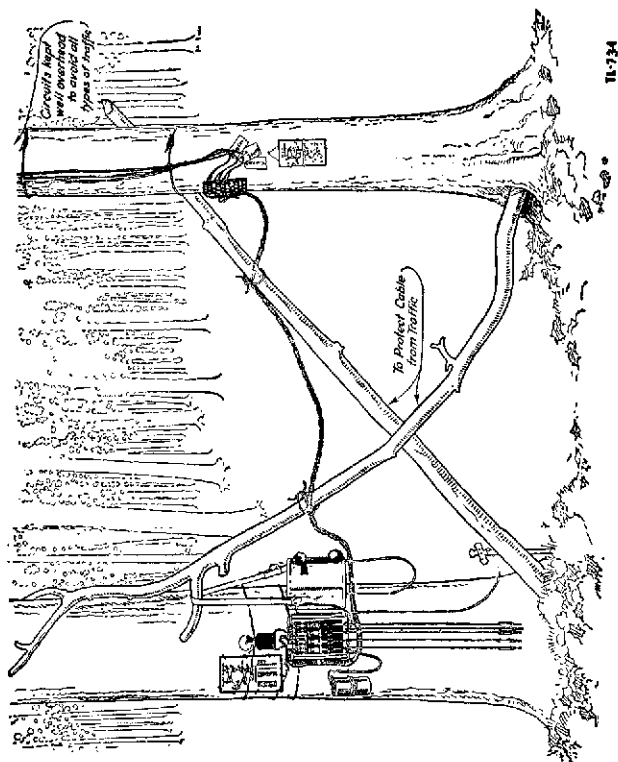

FIGURE 122.—Switching central using monocoord switchboard.

228). Release the shutters of the units which are to be used by lowering the spring locking bars to the horizontal position. Write with a lead pencil the designation of the directory names and numbers on the small celluloid strips on each switchboard line unit.

(3) *Preliminary tests.*—(a) Turn the generator crank of

BASIC FIELD MANUAL

the operator's telephone rapidly for several turns. It should turn easily.

(b) Short-circuit the tip and sleeve of the operator's plug and again turn the generator crank. It should turn hard.

(c) See that two serviceable fuses are installed in the spring clips at the top of each switchboard unit. Hold the operator's plug between the line terminal binding posts of the first unit so that the tip makes contact with one binding post and the sleeve with the other. Turn the generator crank of the telephone. The shutter of the unit should fall and the night alarm bell or buzzer should operate. Restoring the shutter should stop the alarm.

(d) Insert the operator's plug in the jack of the first unit and turn the generator crank. It should turn easily. Short-circuit the line terminals of the unit and again turn the generator crank. It should turn hard, but the shutter should not fall in either case.

(e) Remove the short circuit from the line terminals of the unit. Short-circuit the tip and sleeve of the plug of the unit and turn the generator crank. It should turn hard and the drop should not fall.

(f) Test each unit in the same manner as above. If any one of the above tests fails, replace the faulty unit or turn the switchboard in for repair.

(4) *Installation in parallel.*—Two monocard switchboards may be connected in parallel if one is insufficient for the number of circuits. The installation is made as follows:

(a) Install the first switchboard as prescribed in (2) above, leaving sufficient space between the switchboard and operator's telephone to mount the added switchboard to the right-hand side of the first. Installation is the same, except that only certain terminals are connected and these are connected in parallel to the corresponding terminals on the first switchboard as shown in figure 123; connect terminals A_1 to A_1 and B_1 to B_1 ; and if the operator's cord on the first switchboard is not sufficiently long to reach all units on the additional switchboard connect terminals L_1 to L_1 and L_2 to L_2 . To ground the switchboards, connect G to G and ground one of the terminals.

(b) When the switchboards connected in parallel are in-

SIGNAL COMMUNICATION

stalled in a manner which prohibits the plugging in of any line unit cord in all of the other line jacks, full use may be made of the switchboards by trunking the switchboards together. This is accomplished by reserving for trunking one or more line units on the right-hand side of the left-hand switchboard and a like number of line units on the left-hand side of the right-hand switchboard. Plug the cord of the line unit of the left-hand switchboard into the jack of the line unit of the right-hand switchboard and leave this con-

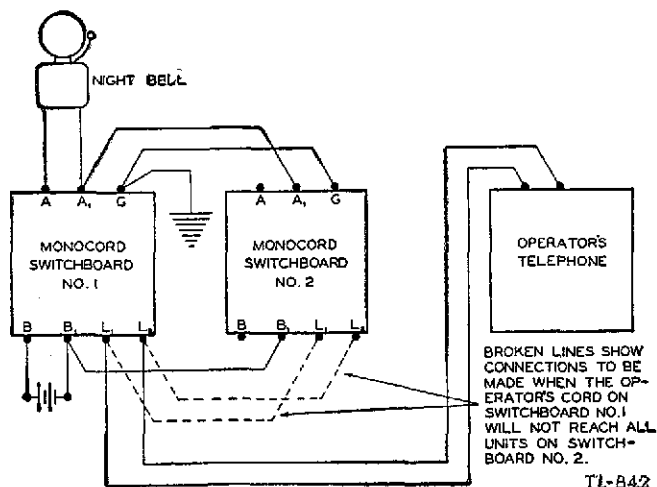

FIGURE 123.—Parallel connection of monocord switchboards.

nection up throughout the operation of the switchboards in parallel. Any connection to be made between the switchboards where the line unit cords will not reach may be made through these two line units which are trunked together.

(5) *Operation.*—(a) An incoming call is indicated by the falling of the shutter of the calling line. Insert the operator's plug into the calling party's jack. After determining the party (or central) to be called, remove the operator's plug and insert it in the called party's jack. Ring the called party by turning the generator crank of the operator's telephone

BASIC FIELD MANUAL

and then insert the called party's plug into the calling party's jack. In the case of a trunk call, do not insert the called party's plug in the calling party's jack until after the number has been passed to the distant operator. The operator's plug may be left in the called party's jack until the conversation has actually begun, or until it is necessary to answer another call. When the conversation has actually begun, remove the operator's plug and restore the shutter. In case it is necessary to answer another call before the first connection has been properly supervised, do not restore the shutter until the first connection has been supervised.

(b) When the conversation is completed and either party rings off, the called party's shutter will fall. Insert the operator's plug into the called party's jack and answer the signal to see if either party desires another connection. If no reply is received, take the connection down and restore the shutter.

(c) The operation of two switchboards in parallel is the same as the operation of a single switchboard, one operator's set being used for both switchboards.

(d) When two parties desire a straight-through connection so that either party can ring the other without operating the shutters or requiring the services of the operator, the units may be cross-patched, that is, the plug of one unit inserted in the jack of the other and vice versa. Such connections are not established except as directed by the signal or communication officer. This action disconnects both drops from the circuit and provides a direct connection between the two lines. Since neither party is then able to signal the operator, the latter should be informed as to how long the through connection is desired.

(6) *Conference call.*—(a) Inform the calling party that he will be called when all parties are on the line.

(b) Ring the first of the called parties and when he answers request him to hold the line for a conference call, telling him what party is calling.

(c) Ring the second called party and when he answers request him also to hold the line for a conference call. Then plug the first called party's plug into the second called party's jack. Extend the connection in a similar manner to each of the called parties in turn.

SIGNAL COMMUNICATION

(d) When the last of the called parties has been connected, ring the calling party if he is not already on the line. Inform the calling party that all parties are now on the line, then plug the calling party's plug into the first called party's jack and tell the calling party to go ahead.

(e) When the conversation has begun, remove the operator's plug from the calling party's jack and restore his shutter. All parties are now connected and each can talk or listen to any of the others. The calling party's drop remains bridged across the connection for a supervisory signal. The connection may be supervised by plugging into the calling party's jack.

d. Telephone central office set TC-4.—The telephone central office set TC-4 is used at division and other headquarters requiring a switching central of the capacity of this equipment. The principal equipment comprises a switchboard BD-96 and a panel BD-97. (For a complete description see TM 11-332.)

(1) *Switchboard BD-96.*—The switchboard is a complete transportable single position, manually operated telephone switchboard for serving magneto-line traffic as well as originating and terminating trunk-line and tie-line traffic. The switchboard comprises 40 line circuits, magneto; 12 cord circuits; 4 common battery trunk circuits, manual and automatic; 1 first operator's telephone circuit with grouping key; 1 ringing circuit; 1 conference circuit; 1 dial cord circuit; 1 second operator's circuit; and 1 night alarm circuit. In operating position the approximate size of the switchboard is 15 inches deep by 22 inches wide by 47 inches high. (See fig. 124.) The switchboard is arranged to be packed within the angle iron base; therefore, no additional packing case is necessary for transportation.

(2) *Panel BD-97.*—The panel is arranged as shown in figure 125. It comprises eight repeating coils C-161 mounted four on each side of the cabinet; two terminal strips of 44 binding posts each mounted on each side of the cabinet; two vertical rows of 22 pairs of 1-ampere fuses and unit dischargers mounted in the center of the cabinet; and three rubber covered cables of 15 pairs each 21 feet long for interconnecting the panel BD-97 with the switchboard BD-96. In operating

BASIC FIELD MANUAL

position the size of the panel is approximately 11 inches deep by 24½ inches wide by 55 inches high. (See fig. 125.) A separate packing case is not necessary for transportation of the panel.

(3) *Installation.*—Turn the switchboard and base upside



FIGURE 124.—Switchboard BD-96 set up for operation.

down, remove the seat top, and extend the extension legs of the base. Ease the equipment to an upright position and lift the base off the switchboard, setting it in the desired position for the switchboard. Set the switchboard on the base making sure that the dowels in the base of the switchboard engage the holes in the top of the base. Unfasten the

SIGNAL COMMUNICATION

cord compartment allowing the cords and weights to drop into position. Clamp the switchboard to the base by means of the two wing-nut bolts provided. Remove the front cover of the

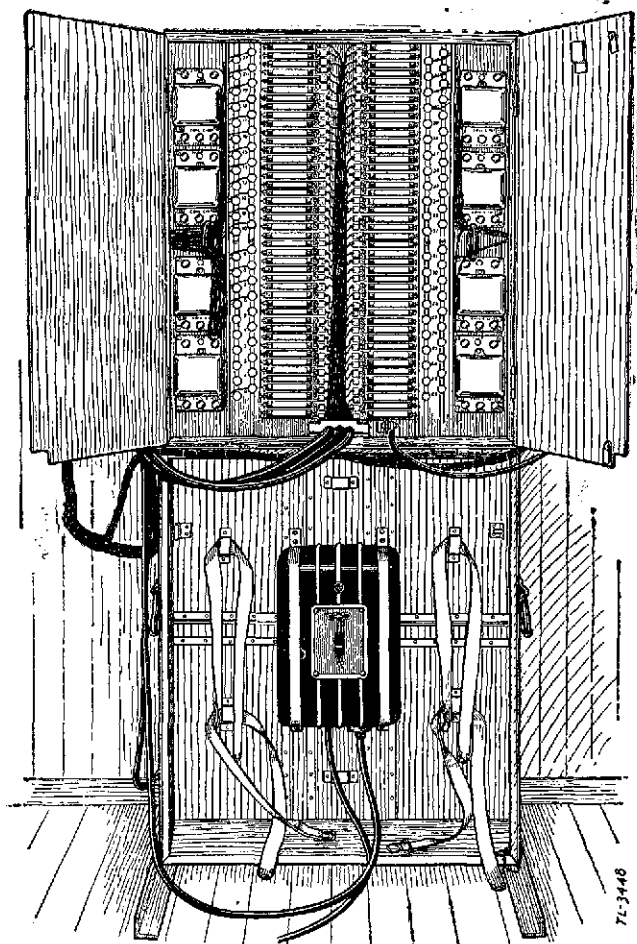

FIGURE 125.—Panel BD-97 ready for operation.

BASIC FIELD MANUAL

switchboard and raise the designation strips permitting the drops to fall. Fasten the seat top to the switchboard cover for an operator's chair. Install six batteries BA-30 in the compartment in the lower rear of the switchboard. (When more than one switchboard is in use, set up the additional units successively adjacent to the first unit in a similar manner to that just described.) Set the panel BD-97 in a suitable location within cabling distance of the switchboard. Loosen the bars on the outside of the case and raise the upper half of the panel (the half without the handles) until it is vertical. Fasten the two lower bars of the upper cabinet to the top bolts of the lower cabinet as a brace. Unstrap the cables and remove the two angle irons chained to the panel; fasten these angle irons to the bottom of the lower cabinet to form extension legs. Slots are provided in the angle irons to provide for mounting the panel BD-97 either at the center or at the end of the angle irons permitting installation against a wall. The upper cabinet may be removed and suspended on a wall by means of hangers at each corner. The ringing machine may also be removed. Connect the three cables to the three rows of binding posts in the top of the switchboard as designated. (Local battery trunk circuits should be terminated in line jacks.) Install the ground rod and connect it to the ground terminal of the BD-97. Connect the incoming lines to the binding posts in the upper cabinet, wiring through the repeating coils when desired. When a 110-volt, 60-cycle power source is available, plug in the power cord of the ringing source into a convenient outlet and extend ringing current to the switchboard by means of cord CD-451. The switchboard termination for ringing power is located on the panel in the top of the switchboard.

(4) *Operation.*—Operation of this switchboard is characteristic of comparable commercial switchboard practice. The drop signals indicate a call on a line or trunk. When a call is received as indicated by the drop, the answering plug (back plug) is inserted in the jack associated with the signal (the drop is mechanically restored to normal position by the insertion of the plug) and the operator's circuit is connected by operating the key immediately in front of the cord circuit used to the locking position (away from the operator). To

SIGNAL COMMUNICATION

call a number, insert the calling plug (front plug) in the desired party's line jack and operate the key immediately in front of the cord circuit used to the nonlocking ringing position (toward the operator). Supervision of a call is provided by a row of drops located immediately above and directly associated with each cord circuit. Ring off or recall is indicated by these drops falling. An audible night-alarm circuit is associated with all drops at the option of the operator by a night-alarm key located at the upper left of the face panel. A grouping key is provided so that an operator may use the cord circuits of an adjacent switchboard where two or more boards are set up together. To connect a telephone to a dial exchange, use any cord circuit to connect the telephone line jack to the trunk-line jack (engraved L) of the trunk desired. When the operator hears dial tone, he plugs the dial cord into the adjacent dial jack (engraved D) and proceeds to dial the desired number. When ringing is heard, the operator removes the dial plug from the dial jack. To connect a telephone to a common battery manual exchange, use any cord circuit to connect the telephone-line jack to the trunk-line jack desired. Plugging in signals the distant operator. An incoming call on a trunk line is answered the same as any other call. To connect a number of lines together for conference, the answering cord plug is inserted in the line jack of the party originating the conference call. The associated calling plug is then inserted in one of the six conference call jacks. The other connections to the conference are made by inserting the answering cord plugs in one of the conference circuit jacks and the associated calling plug in the line jack of the desired party to be called. The operator must call each member of the conference in the usual manner. During peak traffic loads, provision is made for the use of an additional operator by operating the key at the lower left-hand corner of the switchboard panel face. This places cord circuits 9 through 12 on external terminals with provision for connecting any local battery telephone to the switchboard for use of the second operator.

■ 4. FIELD TELEGRAPH SETS.—*a. Telegraph set TG-5-A.*—The telegraph set TG-5-A is shown in figure 126 and is described

BASIC FIELD MANUAL

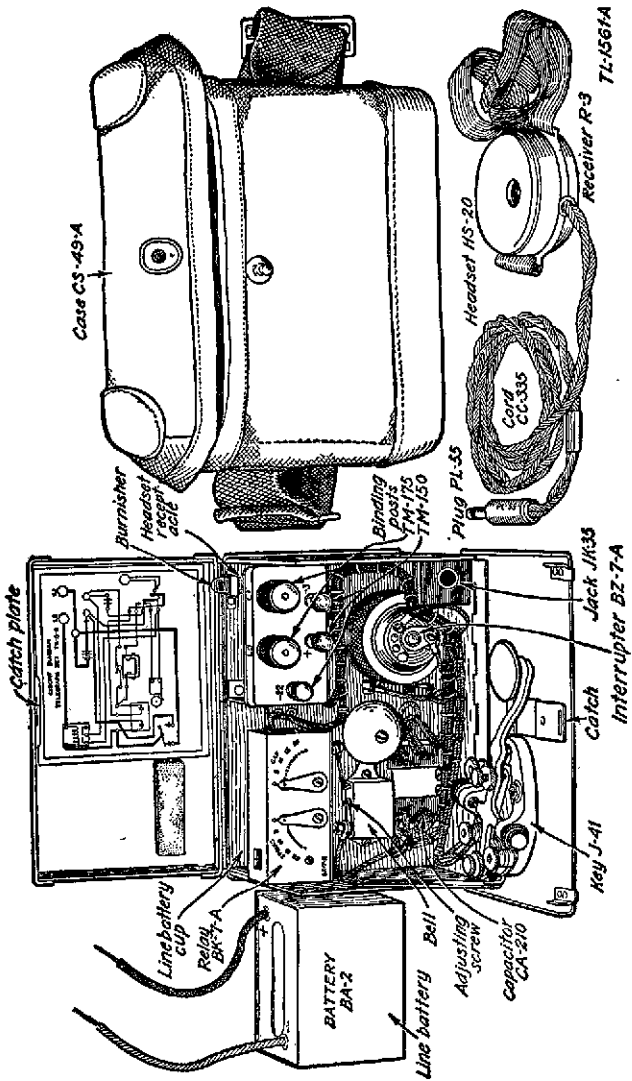

FIGURE 126.—Telegraph set TG-5-A.

SIGNAL COMMUNICATION

completely in TM 11-351. Two batteries BA-30 and one battery BA-2 are required for operation. The line battery BA-2 is carried in the line battery cup and the batteries BA-30 are contained inside the local battery compartment in the rear of the set. (See figure 127.) The large binding posts L_1 and L_2 are the line connections, whether for simplex to ground, or for full metallic circuit. Basically the circuits of the telegraph set TG-5-A can be divided into the line circuit and the local circuit. The line circuit comprises the 22.5-volt line battery, the telegraph key and the line relay, all in series; it is connected by the field wire line to the identical equipment in the distant stations comprising the net. The telegraph keys have three terminals, and the circuits are such that when the key is up, the circuit is completed through the back contact. Depressing any key in the telegraph net places a 22.5-volt battery in series with the line, causing all the line relays to operate. The local circuit has two functions; it can operate as an alarm, in which case ringing of the bell in the telegraph set indicates that a station in the net is beginning operation; or it can key a tone from a hummer (telephone receiver direct-coupled to a carbon-button microphone) for Morse code communication.

(1) *Installation.*—Remove the telegraph set from its carrying case, and open the front compartment, removing the headset and cord. Open the local battery compartment by turning the slot on the catch to a vertical position by means of a screw driver. Place two fresh batteries BA-30 in the local battery compartment, making certain that the case of one battery makes contact to the coiled spring and that the cap of the other battery makes firm contact to the metal spring plate which should be clean and bright. The contact between the batteries should likewise be clean. Close and lock the door of the local battery compartment. Should the alarm bell ring, set the SPRING and the GAP pointers on the relay at zero, then increase the SPRING pointer setting one notch at a time until the ringing ceases. Adjust the key until its "feel" is suitable to the touch. Be certain that the front contacts are open when the key is released, otherwise the line battery will be short-circuited and the key contacts may also be ruined. Connect the red lead of the

BASIC FIELD MANUAL

22.5-volt battery BA-2 to the small plus (+) binding post and the black lead to the 22-volt negative (-22) binding post. Connect the telegraph lines (or telegraph leg of repeating coil and ground of simplex circuit) to L₁ and L₂.

(2) *Adjustment and test.*—(a) *Alarm circuit.*—Short-circuit the binding posts L₁ and L₂. Depressing the telegraph key should start the alarm bell ringing. If the alarm

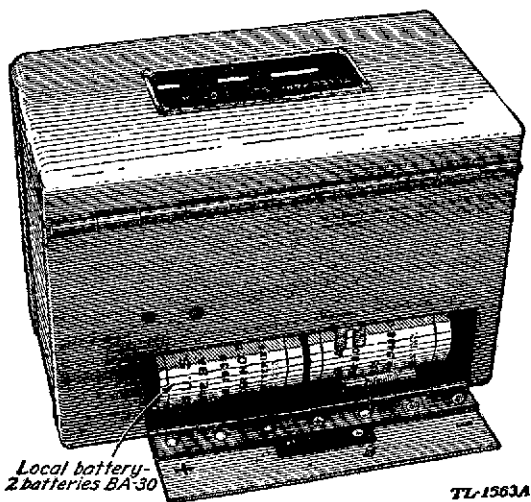

FIGURE 127.—Telegraph set TG-5-A, showing the local battery compartment and batteries BA-30.

fails to ring, and the battery BA-2 is known to be serviceable and properly connected, move the GAP pointer setting one notch at a time beginning with zero until the bell rings when the key is depressed. If the bell continues to ring upon releasing the key, increase the SPRING pointer setting one notch at a time until the alarm stops ringing.

(b) *Local tone circuit.*—Insert the plug in the jack at the lower right-hand corner of the set. This closes the local battery circuit to the hummer, and a faint hum may be heard continuously, indicating the hummer is working. De-

SIGNAL COMMUNICATION

press the telegraph key (with the line binding posts still short-circuited). A 1,000-cycle-per-second tone should be heard clearly. The set box must be in an upright position as this is necessary for the best operation of the hummer. The short circuit should now be removed and the relay may now be adjusted for operation in the telegraph circuit.

(c) *Line relay adjustment.*—Considerable care is required to adjust the line relay for satisfactory functioning on circuits of varying line length and ground connection resistance. When the **SPRING** and **GAP** pointers are at zero, the armature air-gap is smallest and the spring tension least. Under these conditions, the relay will operate with small currents. Due to the characteristics of the relay, this adjustment will not be satisfactory for relatively larger currents, as the spring adjustment will be too weak to pull the armature sufficiently quick after the larger currents cease to flow. The adjustment consists in properly balancing the spring tension against the magnetic pull when current flows in the relay winding. Best adjustments are obtained with the lowest setting of the **GAP** pointer which will permit the relay to operate with the current from the most distant set, and the lowest setting of the **SPRING** pointer which will open the relay contacts sharply. Proper adjustment of the relay is obtained when the tone in the telephone headset clearly and accurately follows the telegraph keying, and shows no tendency to lag or stick on dashes or to chirp on dots.

(3) *Operating the set.*—(a) *Transmitting.*—Use the key as in any other telegraphic circuit; continuous monitoring of the transmission is always present. The line battery **BA-2** furnishes current only when the telegraph key is depressed.

(b) *Receiving.*—With the relay properly adjusted, the transmissions from the distant station are as loud as the local signals, since the hummer circuit furnishes the tone for both.

(c) *Break-in.*—If it is desired to break in on the transmission of the distant operator, operate the telegraph key of the local set, making long dashes. The distant operator will immediately be aware of the break-in signals and stand by for the local operator's transmission.

(d) *Continuous operation.*—If the set is to be operated con-

BASIC FIELD MANUAL

tinuously, keep the plug in the jack. Signals are then received only in the headset which must be worn in order not to miss a call. Such operation causes a continuous drain on the local batteries.

(e) *Stand-by operation.*—With the plug withdrawn from the jack, the hummer is inoperative, and incoming signals operate the alarm bell. No battery drain exists in such case except when the alarm is ringing. This is desirable for stand-by operation.

(4) *Care of telegraph set TG-5-A.*—Keep the telegraph set TG-5-A clean and dry, blowing out all dust or dirt picked up in the field. Keep all connections tight, and inspect the wiring for broken leads. The local battery coiled-spring and plate contacts should be clean and bright. The telegraph key contacts and the relay contacts should be kept clean. This is done by placing a small piece of glazed paper which has been dipped in carbon tetrachloride between the contacts and withdrawing the paper with slight pressure on the contacts. Repeat with a piece of dry paper, always taking pains to prevent lint from accumulating on the contacts. Should the contacts be pitted, it may be necessary to use the burnisher furnished with each set. This is done by placing the thin blade between the contacts and withdrawing it with a slight pressure on the contacts. Especial care must be taken in burnishing the relay contacts *not to spread or bend the springs apart*, as this will cause faulty operation. As with all other apparatus, remove all the batteries from the telegraph set if it is not to be kept in continuous service.

b. *Telegraph set TG-5.*—The telegraph set TG-5 is described in TM 11-351.

■ 5. DRY BATTERIES.—a. *General.*—Dry batteries are the principal source of power for field wire equipment. Since weak or run-down batteries render such equipment inoperative, they are always suspected as the cause of trouble when equipment in which batteries are installed begins to decrease in efficiency. Dry batteries deteriorate rapidly when in use, and slowly when in storage. The date of manufacture is ordinarily stamped on dry batteries and aids in estimating the probable capabilities of dry batteries either in stock for issue or in use.

SIGNAL COMMUNICATION

b. Characteristics.—Some characteristics of dry batteries commonly used in field equipment are given in the following table.

Battery	Principal use	Identification of terminal polarity		Open-circuit voltage	Dimensions in inches	Weight in pounds
		Positive	Negative			
BA-1	Tp	Top, center	Zinc case	3	1 $\frac{3}{8}$ dia. x 6 $\frac{1}{16}$	1
BA-2	Rad	Red wire	Black wire	2 $\frac{1}{2}$	2 $\frac{3}{32}$ x 2 $\frac{1}{32}$ x 3 $\frac{3}{16}$	1 $\frac{1}{4}$
BA-8	Rad	Red wire	Black wire	2 $\frac{1}{2}$	3 $\frac{1}{8}$ x 6 $\frac{5}{8}$ x 4 $\frac{1}{16}$	5 $\frac{1}{2}$
BA-9	Tp	Short strip	Long strip	4 $\frac{1}{2}$	2 $\frac{5}{8}$ x 2 $\frac{3}{8}$ x 1 $\frac{3}{16}$	$\frac{1}{4}$
BA-23	Tp and Rad	Top, center	Zinc case	1 $\frac{1}{2}$	2 $\frac{1}{2}$ dia. x 6 $\frac{1}{2}$	2
BA-30	Tp	Top, center	Zinc case	1 $\frac{1}{2}$	1 $\frac{1}{4}$ dia. x 2 $\frac{1}{4}$	$\frac{1}{4}$
BA-32	Rad	Marked on 5 pin socket on top of battery		Marked on battery	5 x 7 x 8	12

c. Storage.—(1) The number of dry batteries in storage is kept as low as possible by anticipating requirements and requesting small periodic shipments to meet the requirements.

(2) Deterioration is minimized by storing dry batteries in a cool, dry place, and by keeping them clean.

(3) The oldest batteries in storage are issued first, and stocks are arranged to assure such issue.

(4) Since deterioration of a dry battery is sure to damage equipment in which it is installed, the battery is always removed from equipment not in use and is stored separately.

d. Test.—(1) *Under load.*—The best obtainable indication of the condition of a dry battery is its voltage while supplying normal load current. If in good condition, its voltage should be only slightly less than the open circuit voltage given in *b* above.

(2) *Open circuit.*—Since the open circuit (no load) voltage of a run-down dry battery may be equal to that given in *b*

BASIC FIELD MANUAL

above, measuring the voltage of a battery when it is not supplying load current may in some cases give little indication of its condition. Nevertheless, this voltage may be measured as a matter of routine before a battery is installed, because if the open circuit voltage is less than 90 per cent of that given in b above, the battery is practically useless, as will be otherwise evident from the fact that the apparatus will not function properly. The "tongue-test" method which is frequently used for estimating the condition of a low-voltage battery, performed by placing the battery terminals on the tongue, is worthless as a measure of a battery's condition.

APPENDIX II

LIST OF REFERENCES

■ 1. FIELD MANUALS.

Mission, Functions and Signal Communication in General.....	FM 11-5
Organization and Operations in Infantry Divi- sions.....	FM 11-10
Organizations and Operations in the Cavalry Division and Cavalry Corps.....	FM 11-15
Signal Organizations and Operations in the Armored Division and the Armored Corps....	FM 11-17
Organizations and Operations in the Corps, Army, Theater of Operations, and GHQ.....	FM 11-20
Signal Corps Intelligence.....	FM 11-35
List of Publications for Training.....	FM 21-6
Conventional Signs, Military Symbols, and Ab- breviations	FM 21-30
Radio Procedure.....	FM 24-6
Joint Army and Navy Radio Procedure.....	FM 24-10
Operations	FM 100-5
Administration	FM 100-10
The Staff and Combat Orders.....	FM 101-5
Organization, Technical and Logistical Data....	FM 101-10

■ 2. TECHNICAL MANUALS AND TECHNICAL REGULATIONS.

Electrical Fundamentals.....	TM 1-455
Radio Sets SCR-178 and SCR-179.....	TM 11-231
Radio Set SCR-177-B.....	TM 11-232
Radio Sets SCR-131 and SCR-161.....	TM 11-237
Radio Sets SCR-194 and SCR-195.....	TM 11-238
Radio Set SCR-203.....	TM 11-239
Radio Sets SCR-210-A, -B, -C, -D, -E, -F, -G, -H and -J and Radio Sets SCR-245-A, -B, -C, -D, -E, -F, -G, -H, -J, -K, -L, -M, -N, and -P..	TM 11-272

BASIC FIELD MANUAL

Radio Sets SCR-193-A, SCR-193-B, SCR-193-C, SCR-193-D, and SCR-193-E.....	TM 11-273
Frequency Meter Sets SCR-211-A, SCR-211-B, and SCR-211-C.....	TM 11-300
Charging Set SCR-169.....	TM 11-302
Switchboards BD-71 and BD-72.....	TM 11-330
Switchboard BD-14.....	TM 11-331
Signal Corps Telephones EE-8-A.....	TM 11-333
Telegraph Set TG-5 and TG-5-A.....	TM 11-351
Installation and Maintenance of Telegraph Printer Equipment.....	TM 11-353
Reel Unit RL-26 and RL-26-A.....	TM 11-360
Signal Corps Test Set EE-65 and EE-65-A.....	TM 11-361
Reel Unit RL-31.....	TM 11-362
Converter M-209.....	TM 11-380
The Homing Pigeon.....	TM 11-410
Tables of Vertical and Horizontal Components of Distances of Pilot Balloons.....	TM 11-420
Storage Batteries for Signal Communication Ex- cept Those Pertaining to Aircraft.....	TM 11-430
Target Range Communication Systems.....	TM 11-431
Code Practice Equipment.....	TM 11-432
Training of Signal Communication Personnel.....	TM 11-450
The Radio Operator.....	TM 11-454
Radio Fundamentals.....	TM 11-455
Division Field Code, Training Edition No. 2.....	TM 11-460
Air-Ground Liaison Code, Training Edition No. 2.....	TM 11-461
Buzzerphone, Type EE-1-A.....	TR 1230-5
■ 3. ARMY REGULATIONS.	
Leather and Leather Equipment.....	AR 30-3040
Requisitioning Property.....	AR 35-6540
Safeguarding Military Information.....	AR 380-5
Military Motor Vehicles.....	AR 850-15

APPENDIX III

INTERNATIONAL MORSE CODE

■ 1. INTERNATIONAL MORSE CODE.—The dot and dash equivalents for the International Morse Code are as follows:

a. Alphabet.

A	..-	J	.----	S
B	---..	K	-.--	T	-
C	---..	L	.----	U	..-.
D	---.	M	--	V	...-
E	.	N	-. .	W	.---
F	...-	O	----	X	---.
G	--.	P	.----	Y	---.-
H	Q	---.-	Z	---..
I	..	R	.-..		

b. Numerals.

1	.----	6	---..
2	..---	7	---..
3	...--	8	---..
4-	9	---..
5	0	-----

c. Special signs.—These are not used in service communications.

ä (German)	..-.	ñ (Spanish)	---.-
á (Spanish, Scandinavian) or å.	---..	ö (German)	---.
ch (German, Spanish)	----	ü (German)	...-

BASIC FIELD MANUAL

d. Special characters.

Period (.)	Underline (—)
Comma (,)	—	Double dash	
Colon (:)	— — — —	(=)	—
Interrogation (?)		Understood
or request to		Error
repeat	Cross or end (+)
Apostrophe (')	Invitation to	
Hyphen or dash		transmit	—
(—)	—	End of work —
Wait	Separation be-	
Fraction bar (/)	—	tween whole	
Brackets or pa-		number and	
rentheses ()	—	fraction
Starting signal	—	Is it correct

e. Distress, urgent, and safety signals.—See the General Radio Regulations annexed to the International Telecommunications Convention.

Distress call <u>SOS</u>
Urgent signal <u>XXX</u>	—
Safety signal <u>TTT</u>	— — —

INDEX

	Paragraph	Page
Abbreviations, message center.....	35	31
Agents.....	71, 81	85, 91
Authenticators.....	32	28
Batteries:		
Dry.....	App. I	827
Storage.....	251	274
Calls:		
Conference.....	177, App. I	177, 327
Call signs, radio, telegraph and visual.....	31, 265	28, 290
Cipher device M-94:		
Cryptographing, abbreviations, punctuation		
Cryptographing message.....	59	79
signs, and numbers.....	60	75
Decryptographing message.....	61	79
Description.....	56	70
Necessity for key.....	57	71
Purpose and distribution.....	55	70
Setting the device.....	58	72
Ciphers, authorized military.....	53	66
Circuit diagram.....	167, 262	165, 286
Circuits:		
Bridging simplex around a switchboard....	229	254
Mutual interference in simplex and phantom		
groups.....	218	247
Phantom.....	217	246
Simplex.....	216	245
Code, International Morse.....	App. III	367
Codes and ciphers:		
Authorized for military use.....	53	66
Comparison.....	52	65
Rules for use.....	54	68
Colls:		
Loading.....	207	234
Repeating.....	215, 216, 217, 243, 245, 246	
Communication officer:		
Duties.....	12	6
Staff and command functions.....	11	6
Conference calls.....	177	177
Construction center.....	208	236
Converter M-209.....	62	81
Cryptograms, use.....	49	62
Cryptography:		
Definitions.....	50	62
Safety afforded by.....	51	65
Definitions:		
Cryptography.....	50	62
Message center.....	17	13
Radio communication.....	95	110
Signal communication.....	5	2
Sound communication.....	157	156
Wire communication.....	162	158

INDEX

	Paragraph	Page
Disposition of matériel:		
Captured equipment.....	15	11
Destruction of matériel.....	14	9
General principles.....	13	8
Responsibility of signal officers.....	16	12
Field wire:		
Testing on reels.....	242	269
Types.....	184	181
Field wire lines:		
Circuit troubles.....	236	257
Construction and removal of test stations.....	200	223
Equipment used for testing.....	237	260
Loading of.....	207	234
Locating and clearing trouble.....	238	263
Maintenance.....	234	255
Operation of test stations.....	239	267
Overhead construction.....	202	226
Patching circuits at test stations.....	240	268
Patrolling.....	241	269
Procedure in laying.....	199	206
Railroad crossings.....	204	229
River crossings.....	205	230
Road crossings.....	203	227
Routine tests.....	235	256
Routing.....	197	220
Surface construction.....	201	224
Trench line construction.....	206	230
Flags:		
Care.....	132	137
Equipment.....	131	136
Semaphore procedure.....	135	137
Training.....	133	137
Use.....	134	137
Wigwag.....	136	138
Functions of signal communication.....	1	1
Ground connection.....	228	253
International Morse Code.....	App. III	367
Instructions, signal operation.....	260, 265	284, 290
Lamps:		
Adjustment.....	124	132
Care.....	125	133
Equipment.....	123	130
Installation.....	127	133
Message transmission.....	129	134
Procedure.....	130	135
Training.....	126	133
Lettering.....	33	29
Line route map.....	169, 263	167, 286

INDEX

	Paragraph	Page
Message center:		
Abbreviations	35	31
Charts, maps and diagrams	34	30
Definitions	17	13
Equipment and forms:		
Below divisions	45	53
Divisions and higher units	37	32
Flexibility of organization	21	18
Informal contact with neighboring	23	20
Organization, divisions and higher units	36	31
Principles of operation	24	21
Procedure, headquarters below the division:		
Forms and equipment	45	53
General	43	53
Handling messages	47	55
Organization	44	53
Records	46	53
Purpose	18	13
Records, headquarters below the division	46	53
Related procedures for the electrical transmis- sion of messages	27	25
Responsibility	20	17
Training	22	19
Messages:		
Classification	19	14
Dropped messages:		
Dropping grounds	83	91
Equipment for dropping	85	92
Procedure	84	91
Use	82	91
Handling of secret messages	41	51
Multiple distribution	25	23
Pick-up:		
Equipment	88	95
Field	87	94
Procedure	89	97
Training	90	98
Use	86	94
Preparation	38	34
Procedure:		
Handling in lower units	47	55
Handling incoming, divisions and higher units	40	46
Handling outgoing, divisions and higher units	39	37
Handling relay, divisions and higher units	42	52
Skeleton copy	39	37
Messenger:		
Airplane	70	85
Basic training	66	84
Bicycle	69	85
Carrying messages	75	87
Delivery of messages	76	88
Double	77	89
Motor	69	85

INDEX

Messenger—Continued.	Paragraph	Page
Motorcycle	69	85
Mounted	68	84
Personnel	64	82
Receipt of messages for delivery	74	87
Relay posts	80	90
Routes	78	89
Runner	67	84
Scheduled	79	90
Scheduled service	39	37
Selection of type used	73	86
Service	48	61
System	26	23
Messenger communication:		
Equipment for	65	83
Necessity for	63	82
Object of text	2	1
Orders, records, and reports	255, 256, 257	278
Examples:		
Circuit diagram	262	286
Line route map	263	286
Signal operation instructions for triangular division	265	290
Cipher keys for cipher device M-94 and converter M-209	265 <i>g</i>	298
Daylight chart	265 <i>o</i>	324
Distribution S	265 <i>c</i>	292
Geographical supplement to DFC T-1	265 <i>e</i>	295
Identification panel code	265 <i>h</i>	301
Index	265 <i>b</i>	291
Map coordinate code	265 <i>f</i>	304
Prearranged message code	265 <i>p</i>	326
Pyrotechnic code	265 <i>k</i>	309
Radio call signs and frequencies	265 <i>l</i>	310
Supplement to AGL T-1	265 <i>d</i>	294
Supplement to FCC	265 <i>f</i>	297
Telephone directory	265 <i>m</i>	319
Wire tagging code	265 <i>n</i>	322
Traffic diagrams	264	286
Field orders	259	281
Signal operation instructions	260	284
Signal unit journal form	261	286
Steps involved in each tactical operation	258	279
Panels:		
Between airplane radio and ground station with radio receiver only	152	149
Care	144	145
Display grounds	146	145
Displaying the identification group	149	147
Equipment	143	144
Identification group	148	146
Indicating completion of work	154	150
Lamps, dropped messages and panels	153	150
Numerals	147	145
Purpose	145	145

INDEX

	Paragraph	Page
Panels—Continued.		
Reporting.....	151	149
Special signals.....	155	151
Technique of display.....	150	148
Phonetic alphabet.....	178	177
Pigeon communication, employment.....	91	100
Pigeons:		
Delivery, care, and use.....	92, 252	101, 275
Releasing.....	93	102
Transporting.....	92	101
Pole climbing.....	193	212
Equipment.....	191	207
Safeguards.....	192	211
Pronunciation of numerals.....	179	178
Publications relating to signal communication.....	4	1
Pyrotechnics:		
Care.....	138	142
Equipment.....	137	140
Signals.....	141	143
Training.....	140	143
Transmission, message.....	142	143
Use.....	139	142
Radio call signs.....	81	28
Radio communication:		
Assignment of frequencies and call signs.....	105	117
Capabilities.....	97	112
Codes and ciphers.....	53	66
Cooperation with the message center.....	110	120
Definitions.....	95	110
Employment.....	96	112
Equipment.....	App. I	827
Procedure, procedure signals and procedure signs.....	110	120
Radio nets and net control stations:		
Assignment of frequencies and call signs.....	105	117
Control.....	102	115
Establishment.....	106	117
General.....	101	115
Operation.....	103	116
Regulations, general operating.....	109	119
Special uses.....	100	114
Station location.....	99	114
Station records:		
Disposition of records.....	119	126
Importance.....	120	126
Operator's number sheet.....	115	122
Operator's personal sign.....	95	110
Reception of messages.....	116	123
Servicing of messages.....	117	123
Station log.....	118	124
Time entries and the radio day.....	113	121
Traffic.....	104	116
Internet.....	107	118
Training of radio operators.....	98	113
Transmissions.....	112	121
Transmitting rules.....	111	120

INDEX

	Paragraph	Page
Radio intelligence, intercept and position finding	108	119
References	4, App. II	1, 365
Repair of equipment	253	275
Scope of text	3	1
Signal communication:		
Agencies and means	8	3
Definitions	5	2
Function of signal communication	1	1
Responsibility	10	5
Teamwork	9	4
Signal officer:		
Duties	12	6
Staff and command functions	11	6
Signal supply:		
Air Corps	254	275
Classification	245	271
Division personnel	246	272
General	244	271
Method of signal supply	247	272
Receipt	248	273
Signal unit supplies	250	274
Storage batteries	251	274
Transportation	249	273
Signal systems	7	3
Sound communication:		
Definition	157	156
Employment	160	157
Prearranged messages represented by sounds	159	156
Sound producing devices	158	156
Station lists	29	28
Storage batteries	251	274
Switchboards:		
Conference calls	177	177
Installation	210	240
Operating phrases	221	249
Operator	220	248
Supervision	222	250
Types of field	219, App. I	248, 327
Switching centrals:		
Installation	209	239
Records	224, 225	251
Reports to message center	226	253
Terminal strips	190	206
Test stations	174, 200, 239, 240	174, 223, 267, 268
Where established	172, 173	174
Symbols, special	170	167
Systems, signal	7	3
Telegraph:		
Call signs	31	28
Capabilities	180	179
Circuits	227	253
Establishing communication	232	255
Operating procedure and records	233	255

INDEX

	Paragraph	Page
Telegraph—Continued.		
Reports and records	182	181
Teletypewriters:		
Capabilities	180	179
Central	181	179
Types of field	231, App. I	254, 327
Way stations	230	254
Telephone:		
Capabilities	171	173
Care of equipment	211	241
Conversations	176	176
Directory	30, 175, 265 <i>m</i>	28, 175, 319
Installation of	212	241
Testing field telephones	214	242
Traffic diagram	223, 264	251, 286
Types	213, App. I	242, 327
Text:		
Object	2	1
Scope	3	1
Time, Army and Navy methods of specifying	28	27
Units, signal and communication	6	3
Visual call signs	31	28
Visual communication:		
Airplanes	156	154
Possibilities and employment	122	127
Scope	121	127
Wire:		
Protection	195	218
Recovery	196	219
Splices:		
Field wire	185	183
Special	186	189
Taping	187	194
Tags, circuit-marking	189	204
Ties	188	197
Wire circuits:		
Classification	164	160
Designating	168	165
Routing of wire lines	197	220
Wire communication:		
Construction center	208	236
Construction orders	198	220
Definitions	162	158
Movement of command posts	165	161
Orders and instructions	166	165
Purpose and scope	161	158
Transportation of equipment	243	270
Wire-laying equipment	194, 208, App. I	218, 236, 327
Wire system:		
Composition	163	160
Reports and records	182	181

BASIC FIELD MANUAL

SIGNAL COMMUNICATION

CHANGES }
 No. 1 }

WAR DEPARTMENT,
 WASHINGTON 25, D. C., 31 July 1943.

FM 24-5, 19 October 1942, is changed as follows:

■ 24. OPERATION.

* * * * *

b. *Location*.—(1) Signs to mark * * * more precise instructions. Message center marking signs shall not show the designation or size of the unit, but may have a tactical marking as authorized in paragraph 11, AR 850-5.

* * * * *

[A. G. 300.7 (22 May 43).] (C 1, 31 Jul 43.)

■ 221. OPERATING PHRASES.

* * * * *

i. "Have you finished?" Used by an * * * reply is heard.

* * * * *

[A. G. 300.7 (22 May 43).] (C 1, 31 Jul 43.)

BY ORDER OF THE SECRETARY OF WAR:

G. C. MARSHALL,
Chief of Staff.

OFFICIAL:

J. A. ULIO,
*Major General,
 The Adjutant General.*

BASIC FIELD MANUAL

SIGNAL COMMUNICATION

CHANGES }
No. 2 }WAR DEPARTMENT,
WASHINGTON 25, D. C., 30 August 1943.

FM 24-5, 19 October 1942, is changed as follows :

This change rescinds section IV, Training Circular No. 100,
War Department, 1942.

■ 5. DEFINITIONS.

* * * * *

d. (Added.) *Signal center.*—(1) A signal center is a unified collection of several agencies of signal communication equipped to transmit and receive messages by electrical means and by other means if required. The term "signal center" includes a message center section, a cryptographic section if required, and one or more operating sections, each one operating a means of signal communication.

(2) A signal center may be established to serve a designated headquarters; an echelon of a headquarters; a post, camp, or station; one or more service installations or troop units located in an area; or a combination thereof. A signal center may be established at a point, fixed or mobile, and will be charged with the receipt, transmission, and delivery of official messages.

e. *Command post.*—The command post * * * be constantly maintained.

f. *Axis of signal communication.*—To secure continuity * * * the points named.

[A. G. 300.7 (22 Jul 43).] (C 2, 30 Aug 43.)

■ 17. DEFINITIONS.—*a.* *Message center.*—The message center at a headquarters or at an echelon thereof is that signal communication agency of the commander charged with receipt, routing and delivery of all messages except—

(1) Messages transmitted to the addressee by the writer direct, using a personal agency or a telephone or teletypewriter provided for his private use.

BASIC FIELD MANUAL

(2) Messages handled by the military or civil postal service.

(3) Local messages. (See par. 19d(4).)

(4) The receipt of clear text messages delivered by special messenger to an addressee at a headquarters below the division. (See par. 48b(3).)

b. (Added.) Distribution center.—In headquarters requiring agencies for the routing of correspondence and other papers in the different offices, departments, branches, or sections of the staff, such agency will be designated as the “distribution center” of the office, department, branch, or section of the staff served.

c. Addressee.—An addressee is * * * sent to them.

d. Message.—See paragraph 5a.

e. Writer.—The originator of * * * called the writer.

f. Cryptography.—See paragraph 50.

* * * * *

[A. G. 300.7 (22 Jul 43).] (C 2, 30 Aug 43.)

■ 19. CLASSIFICATION OF MESSAGES.

* * * * *

d. Terminology employed in message center operation.

* * * * *

(4) *Local messages.*—Local messages (often referred to as interoffice messages) are those originating at an echelon of a headquarters for delivery to another office or individual at the same echelon.

* * * * *

[A. G. 300.7 (22 Jul 43).] (C 2, 30 Aug 43.)

BY ORDER OF THE SECRETARY OF WAR:

G. C. MARSHALL,
Chief of Staff.

OFFICIAL:

J. A. ULIO,
Major General,
The Adjutant General.

**BASIC FIELD MANUAL
SIGNAL COMMUNICATION**

CHANGES

No. 3

WAR DEPARTMENT,

WASHINGTON 25, D. C., 20 September 1943.

FM 24-5, 19 October 1942, is changed as follows:

■ 188. WIRE TIES.

* * * * *

f. (Added.) *Basket hitch method of tying field wire.*—(1) *Use.*—The most suitable aerial tie for Wire-110-B under conditions of extreme heat, long spans, heavy wind, or sleet loading is the basket hitch tie. It is also the best method of tying larger field wire (such as Wire W-143) and field cable to aerial fixtures, and to ground supports.

(2) *Procedure.*—To make the tie, use a single conductor of scrap field wire (W-110-B), about 6 feet long, to make a clove hitch around the field wire or cable to be supported, at such a point that the several hitches of the completed tie get a secure grip on the supported conductors (fig. 61.1(1)). Lace the ends of the tie wire around the field wire or cable in opposite directions until enough "baskets" have been formed to provide a firm grip on the supported conductors. Usually three complete "baskets" will provide adequate support. (See fig. 61.1(2).) Take two turns around the supporting structure with the ends of the tie wire (fig. 61.1(3) and (4)), and terminate the tie with a square knot. Cut off the loose ends, leaving the ends about 2 inches long.

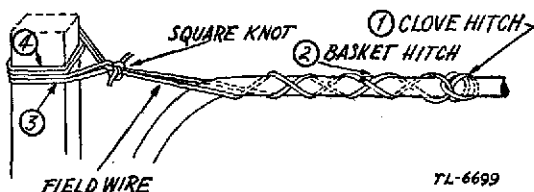

FIGURE 61.1.—Basket hitch tie.

[A. G. 300.7 (10 Jul 43).] (C 3, 20 Sep 43.)

(3) *Tie to intermediate support.*—Wherever field wire or cable is tied to intermediate supports in a section of overhead construction, the line should loop at the pole or tree in such a way that it will not rub tightly against the supporting structure. Two

FM 24-5

C 3

BASIC FIELD MANUAL

basket hitch ties are used at such intermediate supports, one to take the strain in each direction (fig. 61.2). Proper spacing between the two clove hitches depends on the size of the support and will be determined by practice.

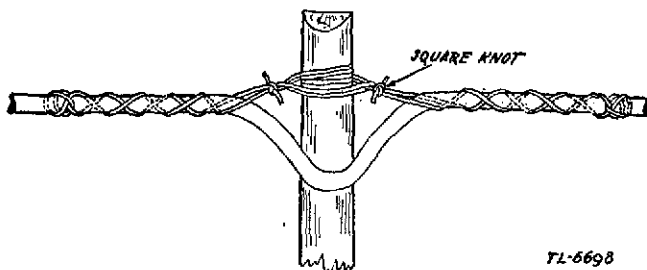

FIGURE 61.2.—Basket hitch ties to intermediate support.

[A. G. 300.7 (10 Jul 43).] (C 3, 20 Sep 43.)

(4) *Tie to pole.*—When wire lines are to be tied to poles, the basket hitch should be made on the ground before climbing the pole. Stand at the bottom of the pole and face the standing end of the line. Pull the conductor wires hand-tight to the center of the base of the pole. The basket weaves of each tie should be anchored by the clove hitch at points 2 feet from the center of the base of the pole. This will provide ample sag in the line and allow the conductor wires to loop at the pole.

(5) *Sag in long spans.*—Sag is essential in long line spans and when the line is attached to a tree or other nonrigid support. In order to gain sufficient clearance and to preserve the sag necessary to allow the tree to sway without causing damage to the line, it may be necessary to attach the hitch as far up on the tree as it is safe to climb. A long span with proper sag is much better than a short, tight span between two trees. The sway of a tree will soon cause trouble in a tight line.

[A. G. 300.7 (10 Jul 43).] (C 3, 20 Sep 43.)

BY ORDER OF THE SECRETARY OF WAR:

OFFICIAL:

J. A. ULIO,

Major General,

The Adjutant General.

G. C. MARSHALL,

Chief of Staff.