

FM 23-5

WAR DEPARTMENT

BASIC FIELD MANUAL

U. S. RIFLE, CALIBER

.30, M1

20 July 1940

**U.S. ARMY MILITARY HISTORY INSTITUTE
CARLISLE BARRACKS, PA 17013-5008**

FM 23-5

*C 1

BASIC FIELD MANUAL

U. S. RIFLE, CALIBER .30, M1

CHANGES }
No. 1 }WAR DEPARTMENT,
WASHINGTON, November 15, 1941.

FM 23-5, July 20, 1940, is changed as follows:

■ 34. IMMEDIATE ACTION.

* * * * *

b. Procedure.—(1) *Rifle fails to fire.*—With the palm up and using the little finger, pull operating rod to the rear. Release operating rod, and if operating handle goes fully home, aim and fire. To avoid injury in case of a hangfire, the hand is so held that no portion of the palm or wrist can be struck by the operating rod in its rapid rearward movement.

(2) *Bolt cannot be locked.*—If after following the procedure prescribed in (1) above, the bolt cannot go completely forward and lock, again pull operating handle to the rear. Check for a battered round, dirt, or obstruction on the face of the bolt, in the chamber, or in the locking lug recess. Discard the battered round; remove the obstruction. Reload, aim, and fire.

(3) *Bolt locks but rifle again fails to fire.*—If after procedure prescribed in (1) above the rifle continues to fail to fire, again pull operating handle to the rear. If no cartridge is ejected, reduce obstruction in clip by pressing and rotating the upper cartridges. Reload, aim, and fire.

(4) *Rifle fails to feed.*—Keep rifle in action by manually working operating handle. A detailed examination for the malfunction may be made later when time permits.

c. The above procedure of immediate action will almost invariably keep the rifle in action. In case this immediate action is not successful, a more detailed examination for the possible malfunctions listed in paragraph 35*e* may be made as circumstances permit.

[A. G. 062.11 (10-10-40).] (C 1, Nov. 15, 1941.)

*These changes supersede section II, Training Circular No. 5, section I, paragraph 1, and so much of paragraph 2 as pertains to FM 23-5, section II, Training Circular No. 8, War Department, 1940; and paragraph 1, section II, Training Circular No. 60, War Department, 1941.

BASIC FIELD MANUAL

■ 64. COURSE A.—*a. Instruction practice.*—Tables I and II are rescinded and table IV and parts of table VII will be fired twice.

* * * * *

b. Record practice.

* * * * *

TABLE IX.—*Rapid fire*

Range (yards)	Time (seconds)	Shots	Target	Position	Sling
200	60.....	16	D.....	Sitting from standing.....	Loop or hasty.

* * * * *

[A. G. 062.11 (9-28-40) (8-13-41).] (C 1, Nov. 15, 1941.)

■ 65. COURSE B.—*a. Instruction practice.*—Tables I and II are rescinded and table IV and parts of table V will be fired twice.

* * * * *

b. Record practice.

* * * * *

TABLE VIII.—*Rapid fire*

Range (yards)	Time (seconds)	Shots	Target	Position	Sling
200	60.....	16	D.....	Sitting from standing.....	Loop or hasty. Do.
200	60.....	16	D.....	Kneeling from standing.....	

* * * * *

[A. G. 062.11 (9-28-40) (8-13-41).] (C 1, Nov. 15, 1941.)

■ 66. COURSE C.—*a. Instruction practice.*—Tables I and II are rescinded and table III and parts of table IV will be fired twice.

* * * * *

[A. G. 062.11 (8-13-41).] (C 1, Nov. 15, 1941.)

■ 141. ASSAULT FIRE.—Assault fire is that fire delivered by a unit during its assault on a hostile position. Riflemen with bayonets fixed and taking full advantage of existing cover, such as tanks, boulders, trees, walls, and mounds, advance

U. S. RIFLE, CALIBER .30, M1

rapidly toward the enemy and fire as they advance at areas known or believed to be occupied by hostile personnel. Such fire is usually delivered from the standing position and is executed at a rapid rate.

[A. G. 062.11 (10-18-41).] (C 1, Nov. 15, 1941.)

BY ORDER OF THE SECRETARY OF WAR:

G. C. MARSHALL,
Chief of Staff.

OFFICIAL:

E. S. ADAMS,
Major General.
The Adjutant General.

FM 23-5

C 2

BASIC FIELD MANUAL

U. S. RIFLE, CALIBER .30, M1

CHANGES { WAR DEPARTMENT,
 No. 2 { WASHINGTON, January 30, 1942.
 FM 23-5, July 20, 1940, is changed as follows:

■ 10. IN GARRISON AND CAMP.

* * * * *

b. The bore of the rifle will always be cleaned by inserting a cleaning rod into the muzzle end. The cleaning rod specified in SNL B-21 is of sufficient length to permit cleaning of the bore without damage to the follower or face of bolt. *If a longer rod is used, the follower and face of bolt must be protected.* Numerous methods have been devised and found satisfactory. The simplest method is to block the follower and cover face of bolt with a piece of cloth stuffed into the receiver. To clean the bore, assemble a cloth patch to the cleaning rod, and insert the rod into the bore at the muzzle end. Move it forward and backward several times and replace with a new patch. Repeat until a patch comes out clean. When issue patches are not available, patches should be cut to approximately 2½ inches square to permit their being forced through the bore without bending the cleaning rod. Then saturate a patch with the oil currently issued for lubrication and preservation of small arms and push it through the bore. If the above cleaner is not available, water may be used. The bore must be thoroughly dried with dry patches before it is oiled.

Caution: In cleaning the bore, care must be taken not to foul the cleaning patch in the gas port.

c. To clean the screw heads and crevices, use a small cleaning brush or small stick. To clean the metal surfaces, wipe with a dry cloth to remove moisture, perspiration, and dirt, then wipe with a cloth containing a small quantity of the oil provided with the gun. This protective film will be maintained *at all times*. To clean the outer surfaces of the rifle, wipe off the dirt with a slightly oiled cloth and clean with a soft dry one.

* * * * *

[A. G. 062.11 (10-22-41).] (C 2, Jan. 30, 1942.)

BASIC FIELD MANUAL

11. PREPARATORY TO FIRING.—Before firing, take the following steps to insure efficient functioning of the rifle:

a. Dismount main groups.

b. Clean the bore. *Do not oil the chamber.*

c. Remove any carbon on the gas cylinder screw and piston head.

d. Thoroughly clean and lightly oil all metal parts with the oil provided with the gun. *Do not use grease.* Be sure to apply a thin coating of oil to the following working parts:

(1) Bolt lugs (locking and operating).

(2) Bolt guides.

(3) Cocking cam on bolt.

(4) Compensating spring.

(5) Contact surfaces of barrel and operating rod.

(6) Operating rod cam.

(7) Operating rod guide groove in receiver.

(8) Operating rod spring.

e. Assemble rifle and rub all outer surfaces with a lightly oiled rag to remove dust.

[A. G. 062.11 (10-22-41).] (C 2, Jan. 30, 1942.)

12. AFTER FIRING.—

* * * * *

a. *Immediate cleaning after firing, or as soon as possible.*—Hold the rifle, bottom side up, so that no cleaner or cleaning solution will enter the gas port. Run several patches saturated with cleaner, rifle bore, through the bore. If cleaner, rifle bore, is not available, water may be used; warm water is good, but warm, soapy water is better. Remove the patch section from the M3 cleaning rod and substitute the cleaning brush; run the cleaning rod with cleaning brush assembled back and forth through the bore several times. Care should be used to insure that the brush goes all the way through the bore before the direction is reversed. Remove the brush and run several patches saturated with cleaner or with water through the bore, removing them from the breech end. Follow this by dry patches until the patches come out clean and dry. Then examine the bore carefully for cleanliness. If it is not free of all residue, repeat the cleaning process; if no residue is present saturate

BASIC FIELD MANUAL

a patch in oil and push it through the bore, holding the rifle top side up, so that some of the oil will flow into the gas port.

Caution: In cleaning the bore, care must be taken not to foul the cleaning patch in the gas port.

b. *Complete cleaning.*—Complete cleaning should be accomplished as soon as possible after the cleaning described in a above. If the rifle is to be fired the next day proceed as in paragraph 11. If the rifle is not to be fired in the next few days, repeat the procedure outlined in a above for 3 days. In addition, the following instructions will be observed:

(1) *Chamber.*—Saturate a cleaning patch with cleaner, rifle bore, or with water, in order to dissolve any primer fouling in the chamber. Insert the cleaning patch deep into the slot of the chamber cleaning tool. Lay the tool * * * to permit neat entry into the chamber. This insures cleaning the full length of the chamber, prevents the patch from being crushed down to the lower end of the tool, and eliminates the danger of causing rings in the chamber by exposed portions of the cleaning tool. Clean by twisting the patch-covered tool in the chamber. Dry the chamber with dry patches on the cleaning tool. Inspect the chamber visually and by inserting the little finger into the chamber and twisting it. If no discoloration shows on the finger, oil the chamber lightly. This oil should be removed before firing.

(2) *Gas cylinder and gas cylinder plug or gas cylinder lock screw.*—Carbon will accumulate due to firing. The frequency of carbon removal is a factor peculiar to individual rifles. Excess deposits of carbon in the rifle manifest themselves by sluggishness in action and failure to feed.

(a) *Spline type.*—To remove accumulated deposits of carbon from the gas cylinder, remove the lock screw and scrape out the carbon, using the screw driver blade of the combination tool. The gas cylinder lock may be removed and the lock screw reinserted in the gas cylinder and threaded in enough to break loose the carbon. The inside of the gas cylinder should be thoroughly wiped clean and oiled at the conclusion of firing.

(b) *Screw-on type.*—Scrape the carbon from the exposed surface of the front of the gas cylinder and gas cylinder plug and piston head after extensive firing. Clean the gas cylinder plug

BASIC FIELD MANUAL

and the grooves in the gas cylinder to insure correct seating of the plug. A sharp blade instrument, similar to a mess kit knife, should be used to remove the carbon from the gas cylinder plug and piston head.

(c) *Both types.*—If firing is contemplated the next day, tip the muzzle down, place a few drops of oil into the gas cylinder between the piston and the walls of the cylinder, and operate the rod by hand a few times. Wipe clean the exterior of the gas cylinder, the operating rod, and the front sight, and oil lightly. If no firing is contemplated in the next week or two remove the operating rod and the gas cylinder lock screw (or gas cylinder plug) leaving the cylinder open at both ends. Clean the cylinder with a rod and patches in exactly the same manner as the bore is cleaned. Hold the rifle so that no water will get into the gas port. **Do not remove the gas cylinder for cleaning.** Clean the piston head and rod with cleaner or with water and dry thoroughly. Oil the rod and the cylinder before reassembling. Carbon may be removed at this time. If abrasive cloth is used, care should be taken that the corners of the plug (or lock screw) or piston head are not rounded.

(3) *Exterior surfaces.*—Wipe off the exterior of the rifle with a dry cloth to remove dampness, dirt, and perspiration. Wipe all metal surfaces with the lubricating oil provided with the gun. Oil the stock and hand guards with raw linseed oil, and oil the sling with neat's-foot oil.

(4) The face of the bolt should be cleaned with a wet patch, dried, and lightly oiled.

[A. G. 062.11 (10-22-41).] (C 2, Jan. 30, 1942.)

■ 13. ON THE RANGE OR IN THE FIELD.—The rifle must be kept clean, free from dirt, and properly lubricated. To obtain its maximum efficiency the following points must be observed:

* * * * *

d. If the rifle gives indications of lack of lubrication and excessive friction, apply additional oil to the parts listed in paragraph 11d. Excessive friction exists if the empty cases are being ejected to the right rear, and oil should be applied at the first opportunity, as failures to feed and eject will occur if the condition is not corrected.

BASIC FIELD MANUAL

e. Keep a light coating of oil on all metal parts.

* * * * *

g. In general, it should not be necessary to remove any of the parts of the rifle in the field for cleaning except the trigger housing group and the gas cylinder plug. However, if the mechanism becomes very dirty the rifle may be disassembled into its three main groups for the necessary cleaning and lubricating.

* * * * *

[A. G. 062.11 (10-22-41).] (C 2, Jan. 30, 1942.)

■ 14. PREPARATION FOR STORAGE.—a. Oil provided with the gun will protect polished surfaces, the bore, and the chamber for a period of 1 to 2 weeks, dependent on the climate and storage conditions. During such periods, however, they should be inspected daily and cleaned and reoiled as often as necessary to keep them properly protected against corrosion. For longer periods of time, rifles will be protected with compound, rust-preventive, light.

b. Compound, rust-preventive, light, is a semisolid material. It is efficient for preserving the polished surfaces, the bore, and the chamber for a period of approximately 1 year, dependent on climatic and storage conditions.

c. The rifles should be cleaned and prepared with particular care. The bore, all parts of the mechanism, and the exterior of the rifles should be thoroughly cleaned and then dried completely with rags. In damp climates, particular care must be taken to see that the rags are dry. After drying a metal part, the bare hands should not touch that part. All metal parts should then be coated with rust-preventive compound. Application of the rust-preventive compound to the bore of the rifle is best done by dipping the cleaning brush in the compound and running it through the bore two or three times. Before placing the rifle * * * which causes the weapon to rust.

[A. G. 062.11 (10-22-41).] (C 2, Jan. 30, 1942.)

■ 15. CLEANING OF RIFLES AS RECEIVED FROM STORAGE.—a. Rifles which have been stored in accordance with paragraph 14 will be coated with light rust-preventive compound. Rifles received from ordnance storage will, in general, be coated with heavy

BASIC FIELD MANUAL

rust-preventive compound. Use a light oil * * * instructions contained in paragraph 11.

* * * * *

b. Dry-cleaning solvent is a noncorrosive petroleum distillate used for removing grease, oil, and wax. It is generally applied with rag swabs to large parts and as a bath for small parts. The surfaces * * * and discolor rubber.

[A. G. 062.11 (10-22-41).] (C 2, Jan. 30, 1942.)

BY ORDER OF THE SECRETARY OF WAR:

G. C. MARSHALL,
Chief of Staff.

OFFICIAL:

E. S. ADAMS,
Major General,
The Adjutant General.

FM 23-5

BASIC FIELD MANUAL



**U. S. RIFLE, CALIBER
.30, M1**

**Prepared under direction of the
Chief of Infantry**



**UNITED STATES
GOVERNMENT PRINTING OFFICE
WASHINGTON : 1940**

WAR DEPARTMENT,
WASHINGTON, *July 20, 1940.*

FM 23-5, Basic Field Manual, U. S. Rifle, Caliber .30, M1,
is published for the information and guidance of all con-
cerned.

[A. G. 062.11 (4-5-40).]

BY ORDER OF THE SECRETARY OF WAR:

G. C. MARSHALL,
Chief of Staff.

OFFICIAL:

E. S. ADAMS,
Major General,
The Adjutant General.

TABLE OF CONTENTS

	Paragraphs	Page
CHAPTER 1. MECHANICAL TRAINING.		
Section I. General	1-3	1
II. Disassembly and assembly	4-9	1
III. Care and cleaning	10-15	19
IV. Functioning	16-19	25
V. Operation	20-31	31
VI. Immediate action and stoppages	32-35	35
VII. Spare parts and accessories	36-38	39
VIII. Instruments	39	41
IX. Ammunition	40-46	45
CHAPTER 2. MARKSMANSHIP; KNOWN-DISTANCE TARGETS.		
Section I. General	47-54	49
II. Preparatory marksmanship training	55-62	52
III. Qualification courses	63-67	93
IV. Range practice	68-72	101
V. Equipment; known-distance targets and ranges, and range precautions	73-76	121
VI. Small-bore practice	77-80	131
CHAPTER 3. MARKSMANSHIP; MOVING GROUND TARGETS.		
Section I. General	81-82	136
II. Moving vehicles	83-85	137
III. Moving personnel	86-87	138
IV. Moving targets and ranges, and range precautions	88-89	139
CHAPTER 4. MARKSMANSHIP; AIR TARGETS.		
Section I. Nature of air targets for rifle	90-91	142
II. Technique of fire	92-96	142
III. Marksmanship training	97-101	146
IV. Miniature range practice	102-105	156
V. Towed-target firing	106-110	159
VI. Ranges, targets, and equipment	111-116	163
CHAPTER 5. TECHNIQUE OF RIFLE FIRE.		
Section I. General	117-119	174
II. Range estimation	120-124	175
III. Target designation	125-131	179
IV. Rifle fire and its effect	132-138	186
V. Application of fire	139-146	189
VI. Landscape-target firing	147-154	195
VII. Field-target firing	155-157	202
VIII. Fire exercises	158-160	205
CHAPTER 6. ADVICE TO INSTRUCTORS.*		
Section I. General	161	209
II. Mechanical training	162	209
III. Marksmanship; known - distance targets	163-178	210
IV. Marksmanship; air targets	179-183	227
V. Technique of fire	184-190	232
INDEX		237

FM 23-5

BASIC FIELD MANUAL**U. S. RIFLE, CALIBER .30, M1**

(The matter contained herein supersedes chapter 1A, part one, Basic Field Manual, volume III, January 3, 1938.)

CHAPTER 1**MECHANICAL TRAINING**

	Paragraphs
Section I. General.....	1-3
II. Disassembly and assembly.....	4-9
III. Care and cleaning.....	10-15
IV. Functioning.....	16-19
V. Operation.....	20-31
VI. Immediate action and stoppages.....	32-35
VII. Spare parts and accessories.....	36-38
VIII. Instruments.....	39
IX. Ammunition.....	40-46

SECTION I**GENERAL**

■ 1. **OBJECT.**—This chapter is designed to give the soldier training that will insure his ability to maintain the rifle and keep it in operation.

■ 2. **DESCRIPTION OF RIFLE.**—The U. S. rifle, caliber .30, M1, is a self-loading shoulder weapon. (See fig. 1.) It is gas operated, clip fed, and air cooled. It weighs approximately 9 pounds and the bayonet an additional pound. The ammunition is loaded in clips of eight rounds. Bandoleers of ammunition for this rifle have six pockets with a total of 40 rounds and weigh $3\frac{1}{4}$ pounds each.

■ 3. **FIREPOWER.**—The principal characteristic of the weapon is its mechanical operation which enables the individual rifleman or group of riflemen to deliver a large volume of accurate fire upon any designated point or area within range.

SECTION II**DISASSEMBLY AND ASSEMBLY**

■ 4. **WHEN TAKEN UP.**—This training will be taken up as soon as practicable after the soldier receives his rifle. In any case it will be completed before any firing is done with the rifle by the individual. Instruction in the care and cleaning of the rifle will also be covered.

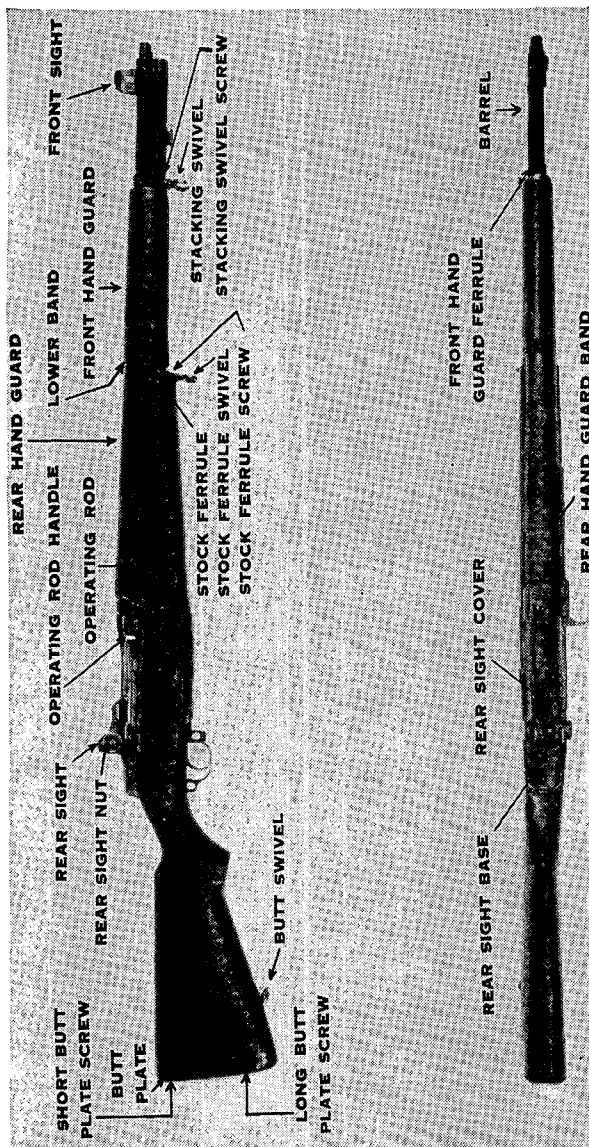

FIGURE 1.—U. S. rifle, caliber .30, M1.

■ 5. ORGANIZATION.—In the company* or platoon, all enlisted men are combined in one or more groups under their officers or selected noncommissioned officers as instructors. Other noncommissioned officers supervise the work as directed. Corporals supervise the work of their squads.

■ 6. CARE TO BE EXERCISED.—*a.* The rifle can be readily disassembled and assembled without applying force. Such practice is prohibited.

b. The piece will not be disassembled or assembled against time as this serves no useful purpose and results in burring and damaging the parts. Instruction, blindfolded, may be given to men who have passed their tests in mechanical training. In all work in disassembling the rifle the men will be taught to lay the parts out on a smooth, clean surface in the proper sequence for assembling.

■ 7. NOMENCLATURE.—The names of the parts to which reference is made in mechanical training are readily learned as this training progresses. Instructors will therefore take care to name the parts clearly and correctly in their work. A sufficient knowledge of the nomenclature of the rifle is gained by the soldier during the instruction in mechanical training.

■ 8. DISASSEMBLING.—*a. General.*—(1) Authorized disassembly by the soldier is limited to that required for proper care and maintenance of the rifle. Further disassembly will generally be done under the supervision of an officer or ordnance personnel. The individual soldier usually will be prohibited from—

- (a) Disassembling the stock group.
- (b) Disassembling the follower assembly.
- (c) Disassembling the rear sight.
- (d) Removing the clip latch.
- (e) Disassembling the trigger housing group.
- (f) Removing the gas cylinder lock.

(2) The front sight will not be dismounted at other than properly equipped Ordnance establishments.

*The term "company" as used in this manual includes troop, battery, or similar organization.

(3) The gas cylinder will not be disassembled from the rifle except by Ordnance personnel.

b. Sequence.—(1) The disassembly of the rifle authorized to be performed by the soldier without supervision is performed in the following sequence:

(a) *Dismounting three main groups.*

1. Remove trigger housing group.
2. Separate stock group from barrel and receiver group.

(b) *Disassembling barrel and receiver group.*

1. Remove follower rod with compensating spring attached.
2. Remove compensating spring from follower rod.
3. Remove operating rod spring.
4. Remove follower arm pin.
5. Remove bullet guide, follower arm, and operating rod catch assembly.
6. Remove follower with slide attached.
7. Remove operating rod.
8. Remove bolt assembly.

(c) *Disassembling bolt assembly.*

1. Remove extractor.
2. Remove extractor spring and plunger.
3. Remove ejector with ejector spring attached.
4. Remove firing pin.

(2) Disassembly of the following parts, generally prohibited for the individual soldier, is performed in the following sequence:

(a) *Removing clip latch.*

1. Remove clip latch pin.
2. Remove clip latch with clip latch spring attached.

(b) *Disassembling trigger housing group.*

1. Close and latch trigger guard.
2. Pull trigger.
3. Remove trigger pin.
4. Remove trigger assembly.
5. Remove hammer spring housing, hammer spring, and hammer spring plunger.
6. Remove hammer pin.
7. Remove hammer.

8. Remove safety.
 9. Remove trigger guard.
 10. Remove clip ejector.
- (c) *Removing gas cylinder lock.*
1. Remove gas cylinder lock screw.
 2. Remove gas cylinder lock.

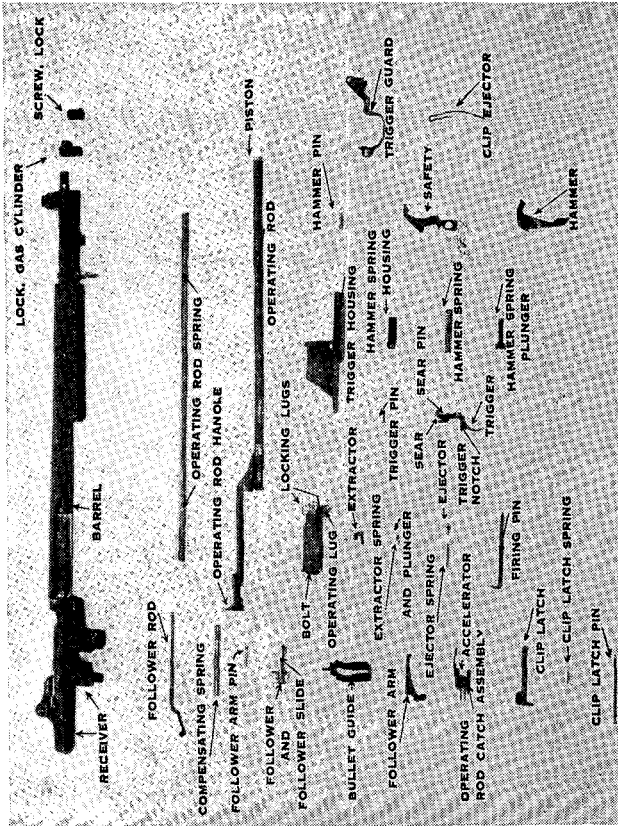

FIGURE 2.—Parts of U. S. rifle, caliber .30, M1.

c. Method.—The following detailed explanation of the method of disassembling the rifle is furnished as an aid to instructors:

(1) *Three main groups.*—Grasp rifle with left hand so that base of trigger housing is included in grip of fingers. (See fig. 3.) Place butt of rifle against left thigh. Grasp rear portion of trigger guard with thumb and forefinger of right hand and exert sufficient downward pressure to unlatch trigger guard from trigger housing. Then swing

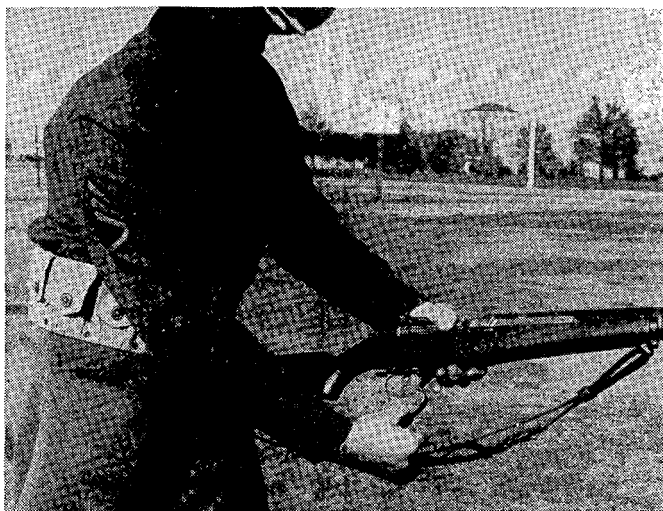

FIGURE 3.

trigger guard away from trigger housing to extreme opened position as shown in figure 3. Pull out trigger housing group. Place this group on a smooth, clean surface. Grasp rifle over rear sight with left hand, muzzle down and barrel to left. (See fig. 4.) Strike and grasp small of stock with right hand so as to separate stock group from barrel and receiver group as shown in figure 4.

(2) *Barrel and receiver group.*—(a) Place group on a smooth surface, barrel down and muzzle to the left. Grasp

follower rod with left thumb and forefinger at knurled portion and disengage it from follower arm by pressure toward muzzle. Withdraw follower rod (with compensating spring attached) to the right. (See fig. 6.) If necessary, remove compensating spring from follower rod by grasping compensating spring with left hand and twisting follower rod toward body with right hand, exerting a slight pull to the right. Withdraw operating rod spring.



FIGURE 4.

(b) Drift follower arm pin from its seat by starting it with the point of a bullet (or with drift of combination tool) held in right hand and applied on side of receiver farthest from body. Pull out pin from near side with left hand. Grasp bullet guide, follower arm, and operating rod catch assembly and pull to the left until these parts are disengaged. Lift out and separate these three parts. Do not remove accelerator from operating rod catch assembly as accelerator pin is riveted in its seat. Lift out follower with

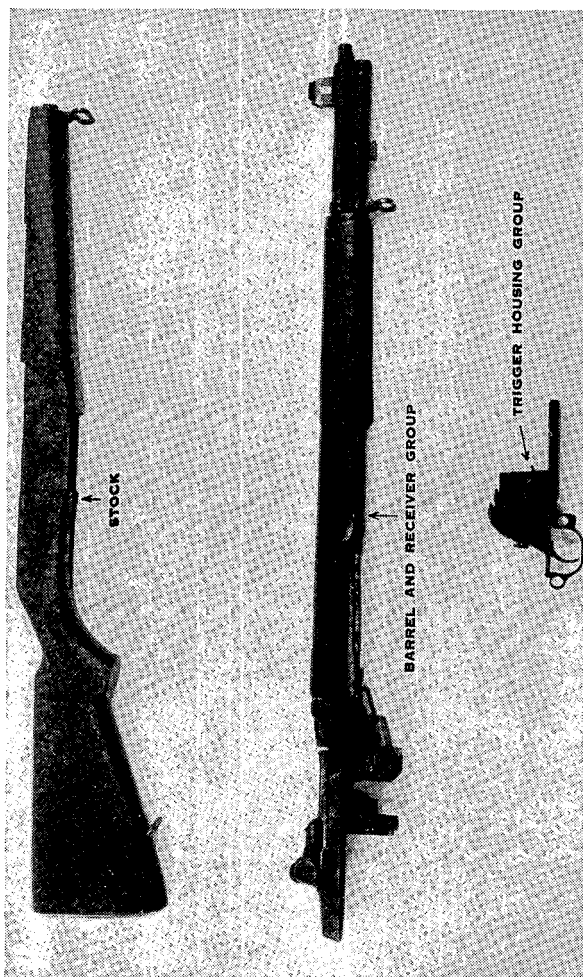

FIGURE 5.—Three main groups, U. S. rifle, caliber .30, M1.

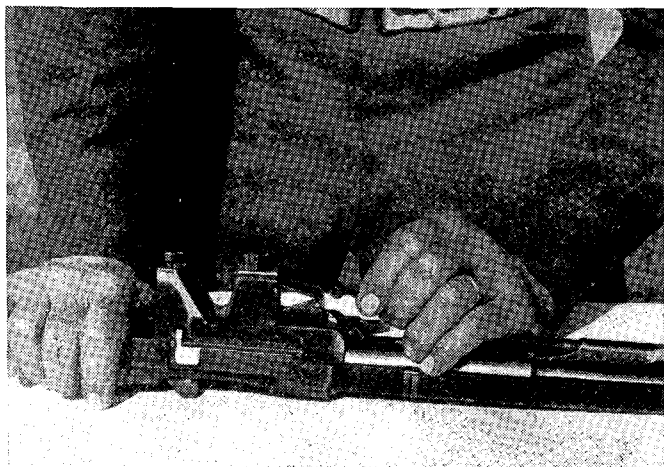

FIGURE 6.

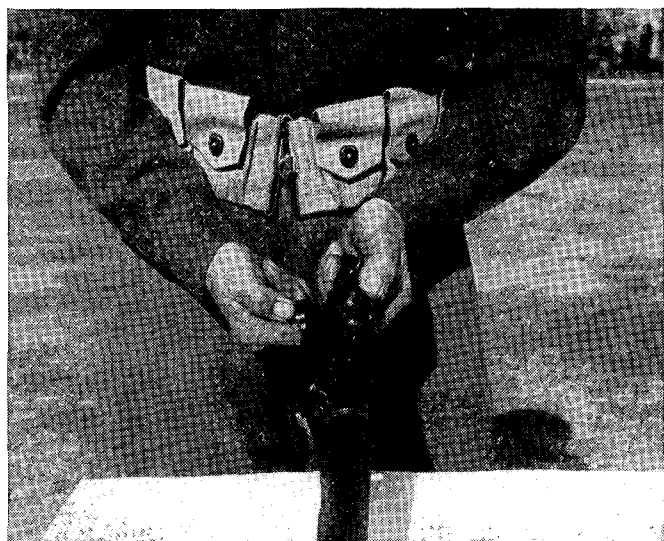

FIGURE 7.

follower slide attached. Do not separate follower from follower slide.

(c) Grasp barrel and receiver assembly with left hand and operating rod handle with right hand as shown in figure 7. Move operating rod slowly to the rear, pulling operating rod handle upward and away from receiver. This will disengage operating rod from bolt when lug on operating rod slides up into dismount notch of operating rod guide groove in



FIGURE 8.

receiver. When operating rod is thus disengaged remove it with a downward and rearward movement.

NOTE.—The operating rod has been intentionally bent. Do not attempt to straighten it.

(d) Grasp bolt by operating lug, slide it from rear to front, and lift it up and out to the right front with a slight rotary motion. (See fig. 8.)

(3) *Bolt assembly.*—Grasp bolt in left hand, holding firing pin in place with little finger, extractor to right, front end up,

thumb on front end of bolt to prevent ejector from flying out. (See fig. 9.) Insert point of a bullet or screwdriver blade of combination tool between lower edge of extractor and cartridge seat flange on bolt and pry extractor out until ejector snaps out against thumb. Extreme care must be exercised that ejector is held by thumb during this operation as ejector spring is compressed sufficiently to inflict injury if released. Remove extractor. Remove extractor spring and plunger. (Separate only when necessary.) Remove ejector with



FIGURE 9.

ejector spring attached. (Separate only when necessary.) Remove firing pin from rear of bolt.

(4) *Rear sight.*—(a) Turn barrel and receiver up. Lower aperture as far as it will go, noting reading on elevating knob and record it for use in assembling. (This reading should be approximately 100 yards.)

(b) Using combination tool, unscrew rear sight nut from right side of rear sight. Unscrew windage knob, taking care that rear sight nut lock assembly which is inside windage knob does not become lost. Remove nut lock and nut lock spring from windage knob.

(c) With a screwdriver remove rear sight elevating knob screw from left side of rear sight. Remove rear sight elevating knob. Pull out rear sight elevating pinion from left side of receiver. Grasp aperture and pull upward about $\frac{1}{2}$ inch, place thumb under top of aperture and push forward to remove rear sight cover, rear sight base, and aperture. Separate.

(5) *Clip latch.*—Place receiver on its right side with barrel to the left. Press clip latch with left thumb to relieve tension of clip latch spring, then drift out and remove clip latch pin, starting it toward muzzle with point of a bullet or drift of combination tool. Lift out clip latch with clip latch spring attached.

(6) *Trigger housing group.*—(a) The trigger housing group being removed, close and latch trigger guard. Release hammer to the fired position. Hold group in right hand, with right thumb on sear, forefinger pulling back on trigger, base of trigger housing braced against a firm support, and press on sear with right thumb to relieve tension on trigger pin. Start trigger pin from its seat with a drift held in left hand, then remove it. Release pressure of right thumb and forefinger gradually, permitting hammer spring to extend to its full length, at the same time steadying hammer spring housing with fingers of left hand. (See fig. 10.) Remove trigger assembly (do not remove sear pin or sear). Remove hammer spring housing, hammer spring, and hammer spring plunger, and separate these parts. Push out hammer pin from left side and remove hammer. Remove safety by pressing its top away from left side of trigger housing until stud snaps out of its seat, and lift it from its slot in trigger housing.

(b) Hold trigger housing in left hand, base of trigger housing down and away from body. Swing trigger guard to open position with right hand. Slide trigger guard toward body until hammer stop is opposite center of safety slot. Rotate trigger guard to right and upward with right hand until hammer stop clears edge of trigger housing. Remove trigger guard.

(c) Hold trigger housing in left hand, right side down, rear end resting on a solid surface. Insert point of a bullet

or combination tool in the dismounting hole in left side of housing and push out clip ejector.

(7) *Gas cylinder.*—(a) There are now in existence two types of gas cylinder and front sight assemblies for the M1 rifle. In the newer or spline type the barrel protrudes beyond the gas cylinder, and the front sight screw enters from the front and is sealed to prevent tampering. In the older or screw-on type the barrel does not protrude and the front sight screw enters from the side.



FIGURE 10.

(b) In order to prevent undue wear, insure proper maintenance of gas port adjustment, and avoid improper assembly, the gas cylinder assembly should not be removed except when necessary to replace the front hand guard assembly. Before such removal be sure the operating rod has been removed. To remove the gas cylinder, proceed as follows:

1. *Spline type.*—Unscrew gas cylinder lock screw using combination tool. Unscrew gas cylinder lock. Tap gas cylinder lightly toward muzzle to remove

it from barrel. The front sight will not be dismounted from the gas cylinder assembly. Do not attempt to adjust the front sight.

2. *Screw-on type.*—Remove front sight screw and lift out front sight. Unscrew gas cylinder assembly from barrel.

d. Disassembly of certain parts prohibited.—The repair or replacement of the following parts pertains to the Ordnance Department and their disassembly will not be effected within Infantry organizations: the trigger and sear assembly; the operating rod catch and accelerator assembly; the front sight; the gas cylinder.

■ 9. ASSEMBLING.—*a.* The rifle and its component groups are assembled in the reverse order of their disassembly as given in paragraph 8 *b.* The following detailed explanation of the method of assembling the rifle is furnished as an aid to instructors:

(1) *Gas cylinder lock.*—Replace gas cylinder lock and gas cylinder lock screw.

(2) *Trigger housing group.*—(*a*) Place clip ejector in position in trigger housing with short arm up, tip of long arm in its slot in vertical front face of housing, and loop against its stud on left side of trigger housing. Hold trigger housing with its left side down, rear end to the right. With right thumb hold loop of clip ejector against its stud; with forefinger of left hand hold long arm of clip ejector up in its slot in front face of trigger housing. With left thumb pry toward body on center of long arm of clip ejector, thereby seating it.

(*b*) Hold trigger housing in left hand, top up, forward end to front. Hold trigger guard in right hand, winged section pointing to the left. Place winged sections astride bottom of trigger housing, hammer stop over safety slot. Rotate trigger guard downward, then slide it forward into position.

(*c*) Replace safety so that its thumb piece passes through slot in both trigger guard and bottom of housing and its stud is snapped into its seat in side plate of trigger housing. Push thumb piece forward to ready position. Insert hammer loosely in cocked position. Aline pin hole in hammer with pin holes in trigger housing and trigger guard. Insert ham-

mer pin from the right. Swing hammer to the fired position. Place trigger housing on a smooth surface, base of trigger housing down and to the left. Assemble hammer spring housing, hammer spring, and hammer spring plunger into one unit. Place plunger in its seat against hammer, *making sure that open side of hammer spring housing is toward safety*, and hold assembled parts in a raised position with left thumb and forefinger. With right hand insert trigger into trigger slot so that notch at curved rear surface of finger piece bears against rear of slot in trigger housing. Arrange parts together so that bottom shoulder of hammer



FIGURE 11.

spring housing rests in notch just below and forward of trigger pin hole and the two wings of hammer spring housing straddle sear pin. (See fig. 11.) Push down with left thumb on top of rear end of hammer spring housing. (See fig. 12.) At the same time pull trigger rearward with right forefinger and push forward on sear with right thumb, thus compressing hammer spring and bringing trigger pin hole into alinement with holes in trigger housing. Hold this alinement with right hand bracing base of trigger housing against a firm surface. With left hand insert trigger pin

up to its head. Seat head of trigger pin fully while oscillating trigger assembly with right hand.

(3) *Clip latch.*—Place clip latch with clip latch spring attached in position on left side of receiver and start clip latch pin in from the front. Press rear end of clip latch to relieve tension of clip latch spring and push clip latch pin fully home. (Protrusion of pin head will result in a damaged stock.)

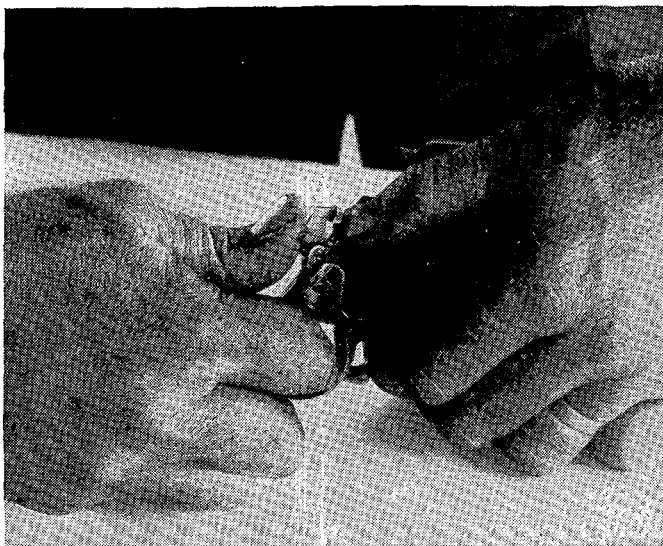

FIGURE 12.

(4) *Rear sight.*—Insert front lip of rear sight cover in slot at forward end of recess in receiver. Spring rear lip into its slot by pressing forward on rear surface. Insert forward end of rear sight base in opening in rear sight cover. Press it forward into position and slide rear sight base to the rear. Insert aperture in slot opening in rear sight base. Slide aperture to its extreme forward position. Holding rear sight base forward against rear sight cover, insert elevating pinion through left side of receiver, taking care that it meshes with

segment on aperture. Insert windage knob through right side of receiver and screw into rear sight base until zero mark on rear sight base registers with center line of windage scale on receiver. Assemble rear sight nut lock spring and nut lock and place them in position in windage knob around threaded end of elevating pinion, flange of nut lock outside, *taking care that flat cut on elevating pinion is alined with flat on nut lock.* Using combination tool, screw rear sight nut onto elevating pinion until tension desired on both elevating knob and windage knob is obtained. (If nut is screwed too tight, knobs become locked and cannot be turned.) Lower aperture as far as it will go by turning elevating pinion. Replace elevating knob and rotate it to position noted before disassembling (approximately 100 yards). Holding it in this position replace elevating knob screws and tighten.

(5) *Bolt assembly.*—Insert firing pin into bolt, making sure that tang enters slot in rear of bolt. Grasp bolt in left hand, top up, extractor recess to right, holding firing pin in place with little finger. Insert ejector with ejector spring attached. Insert extractor spring and plunger. Set stud of extractor into its hole in the bolt without forcing it against ejector spring. Place drift of combination tool in left groove of bolt with ejector in cut on face of tool. Press down on combination tool so as to compress ejector spring and aline ejector, then with thumb of left hand push extractor in until extractor plunger is seated. This operation should be performed only with the combination tool.

(6) *Barrel and receiver group.*—(a) Incline barrel and receiver assembly at an angle of approximately 45°, sights up and muzzle up and to the front. Hold bolt by right locking lug so that front end of bolt is slightly above and to the right of its extreme forward position in receiver. Insert rear end in its bearing on bridge of receiver rotating it in a counterclockwise direction sufficiently to permit tang of firing pin to clear top of bridge. Then guide left locking lug of bolt into its groove at a point just to rear of lug on left side of receiver, and right locking lug onto its bearing in receiver, and slide bolt back to its extreme rear position.

(b) Turn barrel and receiver assembly in left hand until barrel is down. With right hand grasp operating rod at

handle. Hold handle up and insert piston head into gas cylinder about $\frac{3}{8}$ of an inch, making sure that operating rod handle is to the left of receiver. Hold barrel and receiver assembly in left hand and rotate it to the right until barrel is uppermost. With right hand, adjust operating rod so that camming recess on its rear end fits over operating lug of bolt. Press operator rod forward and downward until the bolt is seated in its forward position.

(c) Place barrel and receiver assembly on a smooth surface, barrel down and muzzle to the left. Replace follower (with follower slide attached) so that its guide ribs fit into their grooves in receiver, square hole in follower to the right. Follower slide will rest on bottom surface of bolt when follower is in position correctly.

(d) With left hand replace bullet guide so that shoulders of bullet guide fit in their slots in receiver and hole in projecting lug is in line with holes in receiver.

(e) With left hand replace follower arm by passing its studded end through slot in bullet guide and inserting studs in their grooves in front end of follower. Place forked end of follower arm in position astride projecting lug on bullet guide with the pin holes in alinement. Insert rear arm of operating rod catch through clearance cut in bullet guide, making sure that its rear end is underneath forward stud on clip latch which projects into receiver opening. Aline holes in operating rod catch, follower arm, and bullet guide with those in receiver. Insert follower arm pin in side of receiver which is toward body and press pin home.

(f) If separated, insert operating rod spring into operating rod. Assemble follower rod and compensating spring by grasping spring in left hand and inserting follower rod with right hand, twisting two together so that compensating spring is fully seated on follower rod. Grasp knurled portion of the follower rod with thumb and forefinger of left hand, forked end to right, hump down. Insert left end of follower rod into operating rod spring, push to left and seat forked end against studs on follower arm. Hump on follower rod must be in slot in operating rod catch.

(7) *Three main groups.*—Insert U-shaped flange of stock ferrule in its seat in lower band. Pivoting about this point,

guide and press barrel and receiver group into position in stock. Insert trigger housing group, with trigger guard in its open position, into opening in stock. Press it into position and close and latch trigger guard.

b. Test the assembly as follows: Pull back and hold operating handle to its rearmost position; press down on follower and allow bolt to go fully home; set safety in its rearmost position; pull trigger; hammer should *not* fall; set safety in its foremost position; pull trigger; hammer *should* fall.

SECTION III

CARE AND CLEANING

■ 10. IN GARRISON AND CAMP.—*a.* Care and cleaning in garrison and camp include the care of the rifle necessary to preserve its condition and appearance during the periods when no firing is being done. Rifles in the hands of troops should be inspected daily to insure proper condition and cleanliness. Training schedules should allow proper time for cleaning rifles on each day when rifles are used in training.

b. The bore of the rifle will always be cleaned with a cleaning rod from the muzzle. The cleaning rod specified in SNL B-21 is of sufficient length to permit cleaning of the bore without damage to the follower or face of bolt. *If a longer rod is used the follower and face of bolt must be protected.* Numerous methods have been devised and found satisfactory. The simplest method is to block the follower and cover face of bolt with a piece of cloth stuffed into the receiver. To clean the bore, assemble a cloth patch to the cleaning rod. Insert the rod into the bore at the muzzle and move it forward and back several times, and remove the patch. **CAUTION:** In cleaning the bore, care must be taken not to foul the cleaning patch in the gas port. Repeat until several successive patches come out absolutely clean. Saturate a patch in sperm oil and push it through the bore, holding the rifle, top up, so that some sperm oil will flow into the gas port.

NOTE.—Sperm oil should be used when available. When not available, motor oil, weight 20, or any light grade machine oil may be used in an emergency. Aircraft lubrication oil is not a good preservative.

c. To clean the screw heads and crevices, use a small cleaning brush or small stick. To clean the metal surfaces, wipe with a dry cloth to remove moisture, perspiration, and dirt, then wipe with a cloth containing a small quantity of sperm oil. This protective film will be maintained *at all times*. To clean the outer surfaces of the rifle, wipe off the dirt with a lightly oiled cloth and clean with a soft dry one.

d. After cleaning and protecting the rifle as described above, place it in the gun rack without covering and without a plug in the muzzle or bore. Muzzle covers, gun covers, rack covers, and plugs must not be used because they cause sweating and promote rust. However, when squad rooms are being swept, the gun racks may be covered to protect the rifles from dust. Covers must be removed after the rooms have been swept.

■ 11. PREPARATORY TO FIRING.—a. The care and cleaning of the rifle preparatory to firing differs from the procedure prescribed in paragraph 10 in that lubricating grease (U. S. A. Spec. SXS77) is substituted for oil on many of the moving parts of the weapon. The grease is now issued in a collapsible tube. To apply the grease, rub a small quantity on a corner of a cleaning patch and apply it to the parts. Avoid excess quantities.

b. The following procedure will be observed to assure efficient functioning of the rifle:

- (1) Dismount main groups.
- (2) Clean and oil the bore very lightly. *Do not oil the chamber.*
- (3) Remove any carbon on the gas cylinder plug and piston head.
- (4) Thoroughly clean and lightly oil all metal parts. In cold weather use aircraft lubrication oil. In hot weather use sperm oil.
- (5) Apply a thin, uniform coating of lubricating grease to the parts listed below:
 - (a) Bolt lugs (locking and operating).
 - (b) Bolt guides.
 - (c) Cocking cam on bolt.
 - (d) Compensating spring.

- (e) Contact surfaces of barrel and operating rod.
- (f) Operating rod cam.
- (g) Operating rod guide groove in receiver.
- (h) Operating rod spring.

CAUTION: Do not apply lubricating grease to the follower slide or the under surface of the bolt, as the introduction of grease into the chamber may lead to the generation of excessive pressure.

(6) Assemble rifle and rub all outer surfaces with a lightly oiled rag to remove dust.

■ 12. **AFTER FIRING.**—The bores of all rifles must be thoroughly cleaned by the evening of the day on which they are fired. They should be cleaned in the same manner for the next 3 days. **CAUTION:** Under no circumstances will metal fouling solution be used in this rifle.

a. Immediate cleaning after firing, or as soon as possible.—Hold the rifle, bottom side up, so that no water will enter the gas port. Run several wet patches through bore. For this purpose water must be used; warm water is good, but warm, soapy water is better. Remove the patch section from the M3 cleaning rod and substitute the cleaning brush therefor; run the cleaning rod with brush assembled back and forth through the bore several times. Care should be used to insure that the brush goes all the way through the bore before the direction is reversed. Remove the brush and run several wet patches through the bore, removing them from the breech end. Follow this by dry patches until the patches come out clean and dry. Saturate a patch in sperm oil and push it through the bore, holding the rifle, top side up, so that some of the oil will flow into the gas port. **Caution:** In cleaning the bore, care must be taken not to foul the cleaning patch in the gas port.

b. Complete cleaning.—This cleaning should be done as soon as possible after that described in *a* above. If the rifle is to be fired the next day proceed as in paragraph 11. If the rifle is not to be fired in the next few days repeat procedure in *a* above for 3 days. In addition, the following instructions will be observed:

(1) **Chamber.**—Insert the cleaning patch deep into the slot of the chamber cleaning tool. Lay the tool with patch into

the palm of the left hand, close the left hand over the tool, and give the tool about three turns to the right. This will cause the patch to be neatly wrapped around the tool and will cover all its metal surfaces. A slight pressure with the forefinger of the left hand, while turning the tool, will twist the end of the patch much like the finished end of a hand-rolled cigarette, causing the patch to be sufficiently secured to the tool to permit neat entry into the chamber. This insures cleaning the full length of the chamber, prevents the patch from being crushed down to the lower end of the tool, and eliminates the danger of causing rings in the chamber by exposed portions of the cleaning tool. Clean by twisting the tool with patch in the chamber.

(2) *Gas cylinder and gas cylinder plug.*—Carbon will accumulate due to firing. The frequency of carbon removal is a factor peculiar to individual rifles. Excess deposits of carbon in the rifle manifest themselves by sluggishness in action and failure to feed.

(a) *Spline type.*—To remove accumulated deposits of carbon from the gas cylinder, remove the lock screw and remove carbon, using the screwdriver blade of the combination tool. The gas cylinder lock may be removed and the lock screw reinserted in the gas cylinder and threaded in enough to break loose the carbon. The inside of the gas cylinder should be thoroughly wiped clean and oiled at the conclusion of firing. (A few drops of oil placed between the rear gas cylinder lug and the operating rod, with the muzzle tipped down, will be sufficient if firing is contemplated on the next day. Hand operate the rod through a few cycles to distribute the oil properly.) The exterior finish should be cleaned and lightly oiled. The sight should be kept free of dust and dirt.

(b) *Screw-on type.*—Scrape the carbon from the exposed surface of the front of the gas cylinder and gas cylinder plug and piston head after extensive firing. Clean the gas cylinder plug and the grooves in the gas cylinder to insure correct seating of the plug. The frequency of this cleaning depends on the amount of firing. A sharp blade instrument, similar to a mess kit knife, should be used to remove the carbon from the gas cylinder plug and piston head. If an abrasive cloth is used care should be taken that the corners of the plug or

piston head are not rounded. *Do not remove the gas cylinder for cleaning.* The gas cylinder is cleaned by using the cleaning rod and a patch in the same manner that the bore is cleaned.

(3) *Exterior surfaces.*—Wipe off the exterior of the rifle with a dry cloth to remove dampness, dirt, and perspiration. Wipe all metal surfaces with sperm oil, the stock and hand-guards with raw linseed oil, and the sling with neat's-foot oil.

■ 13. ON THE RANGE OR IN THE FIELD.—The rifle must be kept clean and free from dirt and properly lubricated with lubricating grease. To obtain its maximum efficiency the following points must be observed:

a. Never fire a rifle with any dust, dirt, mud, or snow in the bore.

b. Keep the chamber clean and free from oil and dirt.

c. Never leave a patch, plug, or other obstruction in the chamber or bore. Neglect of this precaution may result in serious injury.

d. If the rifle gives indications of lack of lubrication and excessive friction, apply additional lubricating grease to the parts listed in paragraph 11 a (5). Excessive friction exists if the empty cases are being ejected to the right rear, and grease should be applied at the first opportunity as failures to feed and eject will occur if the condition is not corrected.

e. Keep a light coating of oil on all other metal parts.

f. Remove the carbon from the gas cylinder plug and the piston head when necessary.

g. In general it should not be necessary to remove any of the parts of the rifle in the field for cleaning except the trigger housing group and the gas cylinder plug. However, if the mechanism becomes very dirty the rifle may be disassembled into its three main groups and the necessary cleaning and lubricating accomplished.

h. During range firing, a selected and qualified man should be placed in charge of the cleaning of rifles at the cleaning racks or tables.

■ 14. PREPARATION FOR STORAGE.—a. Sperm oil is the most suitable oil for preserving the mechanism of rifles. This oil

is efficient for preserving the polished surfaces, the bore, and the chamber for a period of from 2 to 6 weeks, dependent on the climatic and storage conditions.

b. Rust preventive compound, medium, is a semisolid material. This compound is efficient for preserving the polished surfaces, the bore, and the chamber for a period of 1 year or less, dependent on the climatic and storage condition.

c. The rifles should be cleaned and prepared with particular care. The bore, all parts of the mechanism, and the exterior of the rifles should be thoroughly cleaned and then dried completely with rags. In damp climates, particular care must be taken to see that the rags are dry. After drying a metal part, the bare hands should not touch that part. All metal parts should then be coated either with sperm oil or rust-preventive compound, depending on the length of storage. (See *a* and *b* above). Application of the rust-preventive compound to the bore of the rifle is best done by dipping the cleaning brush in rust-preventive compound and running it through the bore two or three times. Before placing the rifle in the packing chest see that the bolt is in its forward position and that the firing pin is released. Then, handling the rifle by the stock and hand guard only, it should be placed in the packing chest, the wooden supports at the butt and muzzle having previously been painted with rust-preventive compound. Under no circumstances should a rifle be placed in storage contained in a cloth or other cover or with a plug in the bore. Such articles collect moisture which causes the weapon to rust.

■ 15. CLEANING OF RIFLES AS RECEIVED FROM STORAGE.—*a*. Rifles which have been stored in accordance with paragraph 14 will be coated with either sperm oil or medium rust preventive compound. Rifles received from ordnance storage will, in general, be coated with heavy rust preventive compound. Use a light oil or dry cleaning solvent to remove all traces of the compound or oil, particular care being taken that all recesses in which springs or plungers operate are cleaned thoroughly. After using the dry cleaning solvent make sure it is completely removed from all parts. Then follow instructions contained in paragraph 10. If the rifle

is to be fired immediately, follow instructions contained in paragraph 11.

NOTE.—Failure to clean the firing pin and the recess in the bolt in which it operates may result in gun failure at normal temperatures, and will most certainly result in serious malfunctions if the rifles are operated in low temperature areas, as rust preventive compound and other foreign matter will cause the lubricating oil to congeal or frost on the mechanism.

b. Dry cleaning solvent is a petroleum distillate, of low inflammability and noncorrosive, used for removing grease. It is generally applied with rag swabs to large parts and as a bath for small parts. The surfaces must be thoroughly dried immediately after removal of the solvent. To avoid leaving finger marks, which are ordinarily acid and induce corrosion, gloves should be worn by persons handling parts after such cleaning. Dry cleaning solvent will attack and discolor rubber.

SECTION IV

FUNCTIONING

■ 16. OBJECT.—This section is designed to provide a non-technical description of the functioning of the rifle. The object of instruction in this subject should be to lead the soldier to an understanding of the simple functioning of his weapon without emphasis on memorizing the matter of the text.

■ 17. WHEN TAKEN UP.—Instruction in functioning will be taken up after instruction in the disassembly, assembly, care and cleaning of the rifle.

■ 18. USE OF DUMMY CARTRIDGES.—The corrugated type of dummy cartridge (cal. .30, M1906) may be used for instruction in functioning. The use of the slotted type of dummy cartridge (range, cal. .30, M1) is prohibited. Special care must be exercised in the use of dummy cartridges that they do not introduce dirt or grit into the chamber of the rifle.

■ 19. DESCRIPTION OF CYCLE.—*a. Rearward movement.*—(1) When the rifle is loaded and the bolt closed, the hammer spring is compressed and the trigger lugs are engaged in the hammer hooks, holding the hammer in the cocked position. If pressure is then applied to the trigger, the trigger lugs are

disengaged from the hammer hooks, and the released hammer, actuated by the hammer spring, rotates about the hammer pin and strikes the firing pin which transmits the blow to the primer of the cartridge. (See fig. 13.) The bolt, however,

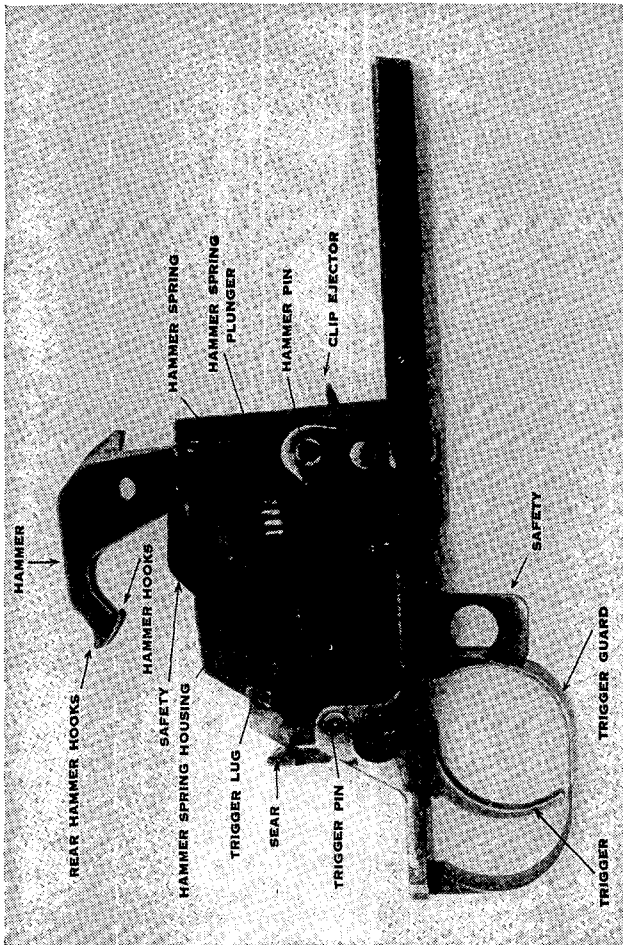

FIGURE 13.—Trigger housing group assembly with hammer in fired position.

must be fully rotated to its locked position before this action can take place as the tang of the firing pin is blocked by the bridge of the receiver except when this tang is alined with the slot in the bridge. Moreover, until the bolt is rotated to its locked position, the hammer is prevented from striking the firing pin by the bolt camming lug striking the cam surface cut into the rear face of the bolt. (The bolt camming lug projects from the face of the hammer.) The shape of this cam surface is such that the bolt will be fully closed by a positive cam action when the hammer is released. In addition the safety must be in its foremost position so that it does not block the hammer and trigger.

(2) When the bullet passes the gas port some of the gas passes through it into the cylinder, where it strikes the piston end of the operating rod with sufficient force to drive the operating rod to the rear and compress the operating rod and compensating springs.

(3) The initial movement of the operating rod to the rear for about $\frac{5}{16}$ inch, is independent of the bolt mechanism, the operating lug merely sliding in the straight section of the recess in the operating rod. The cam surface of this recess then comes in contact with the operating lug and cams it up, rotating the bolt counterclockwise and disengaging the locking lugs on the bolt from the corresponding recesses in the receiver. This delay between the initial movement of the operating rod and the unlocking of the bolt permits the bullet to leave the muzzle, thus relieving the pressure in the barrel before the bolt is opened. The rotation of the bolt also cams the hammer back from the firing pin and withdraws the firing pin point into the bolt.

(4) As the operating rod continues its movement to the rear it carries the bolt which slides along the receiver. The empty cartridge case is withdrawn from the chamber by the extractor. (See fig. 14.) When the mouth of the empty cartridge case clears the breech, the ejector, which is continually pressing on the base of the cartridge, ejects the empty case to the right front through the action of the compressed ejector spring. The rear end of the bolt forces the hammer back and rides over it, thus compressing the hammer spring, and finally comes to rest near the rear end of the receiver.

With the bolt at its extreme rearward position the magazine is uncovered. The follower, actuated by the follower arm and the follower rod which transmit pressure from the operating rod spring and the compensating spring, then forces the cartridges upward in the clip so that the top cartridge

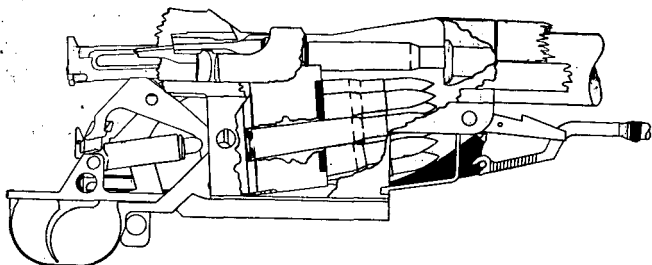

**BOLT MOVING TO REAR —
PIECE HAS BEEN FIRED.**

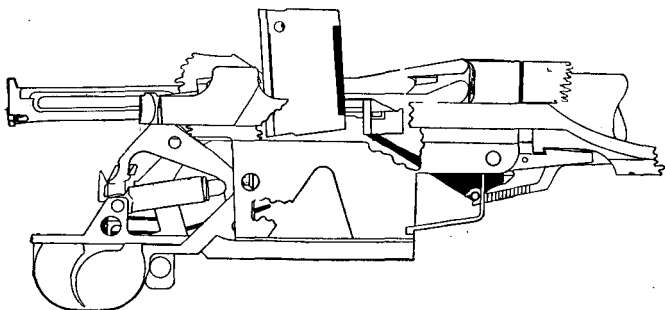

**BOLT IS IN REARMOSt POSITION —
LAST ROUND IN CLIP WAS FIRED
AND EJECTED, CLIP IS BEING EJECTED.**

FIGURE 14.—Rearward movement.

lies in the path of the bolt. The rearward movement of the operating rod terminates when the rear end of its broad curved section contacts the front face of the receiver.

b. Forward movement.—(1) As the bolt moves forward, actuated by the compressed operating rod and compensating springs, the lower front face of the bolt comes in contact

with the base of the top cartridge and slides it forward into the chamber. The hammer, under pressure from the hammer spring, rides on the bottom of the bolt and tends to follow it, but is caught and held by the trigger lugs which engage the hammer hooks, if the pressure on the trigger has been released. (See fig. 15.) If, however, the pressure on the trigger has *not* been released, that is, if the trigger is held back after firing, the sear will engage the *rear* hammer hooks. (See fig. 16.) Subsequent release of the trigger disengages the sear from the hammer which then slides into engagement with the trigger lugs.

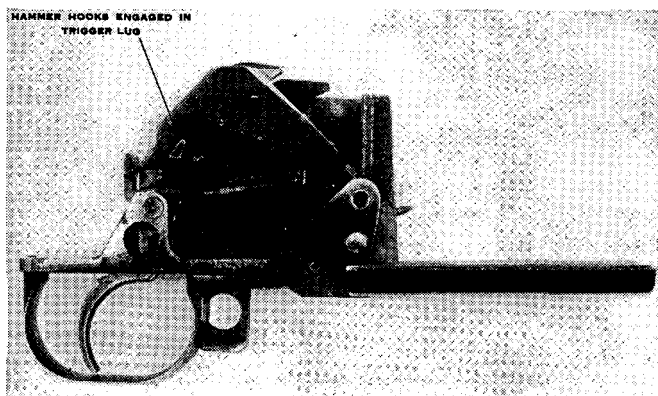

FIGURE 15.—Trigger housing group assembly with hammer in cocked position.

(2) When the bolt approaches its forward position, the rim of the cartridge is engaged by the extractor and the base of the cartridge forces the ejector into the bolt thus compressing the ejector spring. The operating lug is cammed downward by the rear surface of the cam recess in the operating rod, and in this manner the operating rod rotates the bolt clockwise to engage the locking lugs in the receiver. This section locks the bolt. The operating rod then continues to move forward for about $\frac{5}{16}$ inch until the rear end of the straight section of the recess in the operating rod contacts the operating lug on the bolt. The com-

compensating spring prevents the hooks on the follower rod from being disengaged from the follower arm during the forward movement. The rifle is then ready to be fired again. The cycle described above is repeated each time the trigger is squeezed except for the last round in the clip.

c. *Automatic ejection of empty cartridge clip.*—When the last round of a clip is fired, the operations of unlocking and opening the bolt and extracting and ejecting the empty case are accomplished as already described. The bolt clears the top of the receiver in its movement to the rear, and since

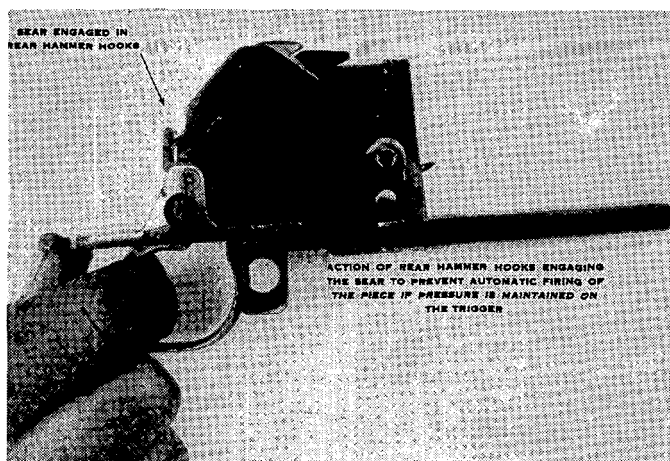

FIGURE 16.—Trigger housing group assembly with hammer hooks engaging the sear to prevent automatic firing.

the clip is empty the follower is pushed up to its extreme top position by the action of the follower arm, follower rod, compensating spring, and operating rod spring. The position of the follower rod under these conditions is such that it cams the forward end of the operating rod catch upward to engage the notch in the operating rod. At the same time the rear arm of the operating rod catch pivots about the follower arm pin and forces down the stud on the front end of the clip latch, thus rotating the clip latch and disen-

gaging it from the clip. Thereupon the empty clip is ejected by the clip ejector. (See fig. 14.) With the operating rod held to the rear by the operating rod catch, and the receiver empty, a loaded clip may be inserted without delay and firing resumed.

d. Automatic release of operating rod catch.—The automatic release of the operating rod catch, which allows the bolt to close when a loaded clip is inserted in the receiver, is accomplished in the following manner: When the loaded clip is forced down in the receiver it depresses the follower. As the follower nears the bottom of the receiver, the front end of the follower arm contacts and rotates the accelerator. The accelerator, in rotating about its pin in the operating rod catch, bears on a lug on the bullet guide and forces down the front end of the operating rod catch, thus releasing the operating rod. The operating rod is then moved forward by the pressure of the operating rod and compensating springs. At the same time the rear arm of the operating rod catch swings upward and releases the stud on the front end of the clip latch. The clip latch then rotates under the pressure of its spring, the rear lug of the clip latch moving inward to engage the notch in the clip and retain the clip in the magazine.

SECTION V

OPERATION

- 20. OBJECT.—This section is designed to give the soldier that instruction necessary for the operation of the rifle.
- 21. WHEN TAKEN UP.—The operation of the rifle will be taken up at any convenient time after instruction in care and cleaning has been completed.
- 22. USE OF DUMMY CARTRIDGES.—As prescribed in paragraph 18.
- 23. TO LOAD CARTRIDGE CLIP.—Insert eight rounds in the cartridge clip so that the base of each cartridge is close to the rear wall of the clip and the inner rib of the clip engages the extractor groove in the cartridge. It is immaterial whether the uppermost cartridge of the loaded clip is on the

left or right side as the follower slide adjusts itself for either loading. Experience shows, however, that for ease in inserting the clip the soldier prefers to have the uppermost cartridge on the right side of the clip.

■ 24. TO LOAD RIFLE.—*a.* The operation of loading is performed with the piece locked, i. e., with the safety of the piece in its rearmost position except in sustained firing. Hold the rifle at the balance in the left hand. With the forefinger of the right hand, pull the operating rod handle smartly to the rear until the operating rod is caught by the operating rod catch. With the right hand take a fully loaded clip and place it on top of the follower. Place the right side of the right hand against the operating rod handle and with the thumb of the right hand press the clip down into the receiver until it engages the clip latch. Swing the thumb to the right so as to clear the bolt in its forward movement and release the operating rod handle. The closing of the bolt may be assisted by a push forward on the operating rod handle with the heel of the right hand. The technique of loading the rifle properly is readily acquired after performing the operation a few times with dummy cartridges in accordance with these instructions.

b. The loading and reloading of the rifle without hurried movements and consequent fumbling will be demonstrated and taught to all men under instruction.

■ 25. TO UNLOAD RIFLE.—*a.* To unload a cartridge from the chamber, hook the right thumb over the operating rod handle, pull and hold the operating rod in the extreme rear position, thus extracting and ejecting the round.

b. To remove the loaded clip from the receiver, hold the rifle with the right hand, thumb on operating rod handle, fingers around the trigger guard. Place the fingers of the left hand over the receiver and press in on the clip latch with the left thumb. The clip will then be ejected upward from the receiver and into the left hand. (See fig. 17.) **CAUTION:** Do not allow the bolt to move forward during the operation as it will push the top cartridge forward and prevent normal ejection of the clip.

c. To close the bolt on an empty chamber and retain the loaded clip in the receiver, press down on the top cartridge

in the clip and allow the bolt to slide forward, making sure that it is fully closed.

■ 26. TO OPERATE RIFLE AS SINGLE LOADER.—The receiver being empty, pull the operating rod to the rear until it is caught by the operating rod catch. With the right hand, place one round in the chamber, seating it in place with the thumb. With the right side of the right hand against the operating rod handle and the fingers extended and joined,



FIGURE 17.—To unload.

force the operating rod handle slightly to the rear, depress the follower with the right thumb, and permit the bolt to ride forward about 1 inch over the follower. Then remove the thumb from the follower, release the operating rod handle and push forward on the operating rod handle with the heel of the hand to be certain that the bolt is completely closed. No type of ammunition will be loaded *into the receiver* except in full clips.

■ 27. **TO FIRE RIFLE.**—Squeeze the trigger for each shot. When the eighth shot has been fired, the empty clip is automatically ejected and the bolt remains open.

■ 28. **TO SET RIFLE AT SAFE.**—The loaded rifle will be kept locked until the moment for firing. To make this adjustment set the safety in its rearmost position inside the trigger guard. In this position the trigger cannot be pulled as the upper end of the trigger is blocked from disengaging from the hammer hooks, and the hammer is held in the cocked position by the hook on the safety being engaged with the lug on the left side of the hammer. The rifle may be loaded and operated by hand when *locked* but cannot be fired. To *unlock* the rifle set the safety in its foremost position.

■ 29. **TO ADJUST REAR SIGHT.**—The rear sight is adjusted for range by turning the elevating knob on the left side. This knob has numbered graduations for 200, 400, 600, 800, 1,000, and 1,200 yards of range and index lines between these graduations for 100, 300, 500, 700, 900, and 1,100 yards. Adjustment for windage is made by turning the windage knob on the right. Each windage graduation represents an angular adjustment of 4 minutes. Both elevating and windage knobs are provided with “clicks” which represent approximately 1 minute of angle or 1 inch on the target for each 100 yards of range. Arrows on the knobs indicate the direction in which to turn them to secure corresponding changes in the point of impact of the bullet. Rotation of the elevating knob may be eased by forcing the knob outward (away from receiver) while turning.

■ 30. **SAFETY PRECAUTIONS.**—The soldier must be impressed with the fact that while any cartridges remain in the receiver, after a round has been fired, the rifle is ready to fire. The gun is safe only when it is “cleared”; in other words, the gun is never *known* to be *safe* when the bolt is closed.

■ 31. **TO CLEAR RIFLE.**—*a.* To clear rifle, pull the operating rod fully to the rear, extracting and ejecting the cartridge from the chamber. Remove the clip from the magazine as described in paragraph 25 and *leave the bolt open.*

b. *In range firing, whenever firing ceases, execute clear rifle as prescribed above.*

SECTION VI

IMMEDIATE ACTION AND STOPPAGES

■ 32. OBJECT.—This section is designed to provide necessary instruction in the related subjects of immediate action and stoppages.

■ 33. WHEN TAKEN UP.—Instruction in immediate action and stoppages will be completed before any firing is done by the individual.

■ 34. IMMEDIATE ACTION.—*a. General.*—Immediate action is the unhesitating application of a probable remedy for a stoppage. Immediate action deals with the method of reducing stoppages and not the cause. It is taught as an unhesitating manual operation to be applied to reduce stoppages without detailed consideration of their causes.

b. Procedure.—(1) If the loaded rifle fails to fire when the trigger is pulled, count to "20" to allow for a hang fire, and then pull the operating handle to its rearmost position ejecting the round. Release the operating handle and if the bolt goes fully home aim and fire.

(2) If the bolt cannot be fully locked in *a* above, pull the operating rod handle to the rear. Check for a battered round, dirt, or obstruction on the face of the bolt, in the chamber, or in the locking lug recess. Discard the battered round; remove the obstruction. Reload, aim, and fire.

(3) The rifle fires but fails to feed. Keep the rifle in action by working the operating rod handle as it is still an effective combat weapon. A detailed examination for the malfunction may be made later when time permits.

(4) The above procedure of immediate action will almost invariably keep the rifle in action. In case this immediate action is not successful, a more detailed examination for the possible malfunctions listed in paragraph 35*e* may be made as circumstances permit.

■ 35. STOPPAGES.—*a. General.*—While immediate action and stoppages are closely related as to subject matter, the former is treated separately to emphasize its importance as an automatic and definite procedure to be applied to overcome stoppages. Proper care of the rifle before, during, and after firing will usually eliminate stoppages. Stoppages which

cannot be remedied by the application of immediate action can best be eliminated if the soldier has an understanding of the functioning of the weapon and the causes of stoppages.

b. Failure to fire.—(1) *Causes.*—Failures to fire are generally caused by—

(a) Defective ammunition.

(b) Defective firing pin.

(c) Bolt not fully closed when hammer strikes firing pin.

(2) *Action.*—(a) If the primer of a round is deeply indented, the round is defective. Discard the round. If the primer is not indented or but very lightly indented, the firing pin may be short or broken or the bolt may not have been fully closed. Check for dirt or some obstruction which does not permit the bolt to lock fully. Remove the obstruction. If the rifle is clean and lubricated, check the firing pin. Replace it if defective.

(b) *Removal of a broken firing pin.*—If the piece fails to fire and the operating handle cannot be moved to the rear by a sharp blow with the heel of the hand, the firing pin may be broken, and having come out of its seat in the bolt it may have become wedged between the rear of the bolt and the top of the receiver. Remove the trigger housing. Generally the firing pin will fall out. If it does not fall out, separate the barrel and receiver group from the stock group and remove the firing pin. If the trigger housing cannot be removed easily, *do not force it out of its recess.* The firing pin is caught under the lug on the left of the hammer. Open the trigger guard as far as it will open without force. Turn the rifle, barrel down, and shake it, at the same time oscillating the trigger guard until the trigger housing can be removed. Remove the firing pin as indicated above.

c. Failure to feed.—(1) *Types.*—Failures to feed are caused by failure of the bolt to go far enough to the rear to pick up a new round. A failure to feed may have any one of a number of causes. It will generally result in one of the following types of stoppages:

(a) Those in which the bolt fails to go fully home.

(b) Those in which the bolt does go fully home.

(2) *Action to reduce stoppage of the first type.*—Stoppages of the first type may be caused by a battered round, dirt in the

locking recesses, an obstruction on the face of the bolt, a dirty chamber, or a ruptured cartridge case part of which remains in the chamber. Remove the battered round, dirt, or other obstruction; clean the chamber; or remove the ruptured cartridge case as the case may be. Occasionally this stoppage may be caused by a clip which has lost its spring tension and does not hold the cartridge firmly in line. When this occurs, the cartridge will be found "cocked" in the gun with the nose of the bullet one side or the other of the entrance to the chamber. Remove the round; remove the clip and discard it.

(3) *Action to reduce stoppage of the second type.*—Occasionally, when a stoppage of the second type occurs, the spent case is not ejected but is re-fed back into the chamber. This condition is caused by lack of lubrication, excessive friction of the moving parts, or lack of sufficient gas pressure due to the formation of carbon in the gas port. In any case the bolt has not moved far enough to the rear to permit proper functioning. The conditions are remedied by removing all carbon and thoroughly lubricating all parts as prescribed in paragraphs 10 to 15, inclusive.

d. Failure to extract.—(1) *Causes.*—Failures to extract are generally caused by—

- (a) Extremely dirty chamber.
- (b) Extremely dirty ammunition.
- (c) Improper assembly of the rifle, i. e., failure to replace the extractor plunger and spring.
- (d) Cartridge case chambered in a hot barrel.
- (e) Broken extractor.

(2) *Action.*—(a) When a failure to extract occurs, the bolt may be found fully locked with a spent case in the chamber. Generally, most failures to extract can be remedied by pushing the operating rod fully forward and then pulling it smartly to the rear. If this does not remove the case, use the combination tool or cleaning rod.

(b) Sometimes the empty case will be left in the chamber, the extractor ripping through the base of the cartridge. When this occurs the bolt generally will attempt to feed a fresh cartridge into the chamber. It will then be necessary to remove this round before the spent case can be removed.

(c) Where a dirty chamber or dirty ammunition is indicated, clean the chamber and discard or clean very dirty

ammunition. Faulty assembly or a broken extractor will cause recurring failures to extract. Replace missing or broken parts.

e. Table of stoppages.—The following table may be found of value. It includes the stoppages outlined above and others that have not been covered but which may occur infrequently.

TABLE OF STOPPAGES

Malfunction	Cause	Correction by the soldier
Clip jumps out on seventh round.	Bent follower rod.....	Replace.
Failure to extract.....	(1) Dirty or rough chamber. (2) Restricted gas port....	(1) Clean chamber. (2) Clean gas port.
Failure to feed.....	(1) Dirty or rough chamber. (2) Restricted gas port.... (3) Dirty rifle or improperly lubricated. (4) Bent clip..... (5) Ruptured cartridge case in chamber.	(1) Clean chamber. (2) Clean gas port. (3) Clean rifle and lubricate. (4) Replace clip. (5) Remove ruptured cartridge case.
Fires automatically.....	Sear broken or remains in open position.	Replace trigger assembly or hammer spring housing.
Safety releases when pressure is applied on trigger.	Round heel on safety, or broken safety.	Replace safety.
Pull on trigger does not release hammer.	(1) Deformed hammer or trigger or worn trigger pin. (2) Trigger strikes trigger housing.	(1) Replace defective part. (2) Turn in to ordnance.
Hammer releases but gun does not fire.	(1) Bolt not all way seated. (2) Defective ammunition. (3) Broken firing pin.....	(1) Clean and lubricate. (2) Discard round. (3) Replace.
Rear sight elevation jumps.	Loose rear sight nut.....	Tighten.
Creep in trigger.....	Burs on trigger or hammer lugs.	Turn in to ordnance.

f. Other stoppages.—In the event of stoppages that are not mentioned above and that cannot be reduced, the rifle should be turned in for examination and repair.

SECTION VII

SPARE PARTS AND ACCESSORIES

■ 36. SPARE PARTS.—*a.* The parts of any rifle will in time become unserviceable through breakage or wear resulting from continuous usage, and for this reason spare parts are supplied. These are extra parts provided with the rifle for replacement of the parts most likely to fail; for use in making minor repairs; and in general care of the rifle. They should be kept clean and lightly oiled to prevent rust. Sets of spare parts should be kept complete at all times. Whenever a spare part is taken to replace a defective part in the rifle, the defective part should be repaired or a new one substituted in the spare part set as soon as possible. Parts that are carried complete should at all times be correctly assembled and ready for immediate insertion in the rifle. The allowance of spare parts is prescribed for the rifle in SNL B-21.

b. With the exception of replacements with the spare parts mentioned in *a* above, repairs or alterations to the rifle by using organizations are prohibited.

■ 37. APPENDAGES.—Appendages are items not required for use in the operation of the major equipment but are used attached to or in connection with such equipment. For the rifle they consist of the bayonet, M1905, and bayonet scabbard, M1910.

a. Bayonet.—The bayonet is a blade sharpened along the entire lower edge and partly along the top edge. The bayonet guard is constructed so as to fasten the bayonet securely to the rifle or its scabbard. Wooden assemblies on both sides of the tang provide a grip for use as a hand weapon.

b. Bayonet scabbard.—The scabbard, shaped to receive the bayonet, consists of a fabric-covered body with a leather reinforce at its tip which contains a drain hole. The scabbard is held to the belt of the soldier by two hooks.

■ 38. ACCESSORIES. — *a. General.* — Accessories include the tools required for assembling and disassembling and for the cleaning of the rifle; also the gun sling, spare parts containers, covers, arm locker, etc. Accessories should not be used for purposes other than those for which they are intended, and when not in use they should be stored in the places or receptacles provided for them. There are a number of accessories, the names or general characteristics of which indicate their uses or application. Therefore, detailed descriptions or methods of the uses of such items are not outlined herein. However, accessories of a special nature or those which have special uses are described in *b* to *h* below.

b. Arm locker and rack.—The arm locker and the arm rack are used to store or stack rifles and pistols to prevent mishandling or pilfering.

c. Barrel reflector.—This is a small, box-shaped device having a short tube which slips into the chamber of the rifle barrel. It also has a mirror and an opening through which the reflection of the bore is obtained. The condition of the rifle bore may thereby be readily determined.

d. Brush and thong.—The brush and thong are used for cleaning the bore of the rifle. The case is partitioned so that one end contains the oil and oil dropper and the other holds the tip, weight, thong, and brush.

e. Cleaning rod, M3, and cleaning brush, M2.—The cleaning rod, M3, has a handle at one end and is threaded at the other end to receive the patch section or the brush. This rod is of the correct length to prevent damaging the follower or the face of the bolt. The cleaning brush, M2, is used to clean the bore of the rifle.

f. Combination tool.—This tool consists of three parts—the chamber-cleaning tool, the handle, and the screw-driver blade. The slot in the chamber-cleaning tool is for attachment of a cleaning patch. The movable screw-driver blade is used for the gas cylinder plug screw and various other screws, while the notched blade of the handle is used on the rear sight nut. The small cylindrical projection is used to drift out pins. It is also used in conjunction with the V-shaped groove cut into the face of the handle to assemble the extractor and ejector. The curved undercut lug or

hook, commonly called the hand extractor, is used to extract a cartridge case after firing if the extractor should fail to extract the case.

g. Gun sling.—The gun sling, fastened to the loops of the rifle, is adjusted to suit the particular soldier using it. The sling consists of a long and short strap, either of which may be lengthened or shortened as desired.

h. Ruptured cartridge extractor.—The ruptured cartridge extractor has the general form of a caliber .30 cartridge. It consists of three parts—the spindle, the head, and the sleeve. To use the ruptured cartridge extractor, the cartridge clip and live cartridges must be removed from the rifle. The ruptured cartridge extractor is then inserted through the ruptured opening of the case and pushed forward into the chamber. The bolt is let forward without excessive shock so that the extractor of the rifle engages the head of the ruptured cartridge extractor. As the operating rod is drawn back, the ruptured cartridge extractor holding the cartridge on its sleeve is extracted.

SECTION VIII

INSTRUMENTS

■ 39. FIELD GLASS, TYPE EE.—The field glass, type EE (fig. 18), complete, consists of the field glass with its carrying case.

a. Description.—(1) The field glass consists of two compact prismatic telescopes (5) pivoted about a common hinge (4) which permits adjustment for interpupillary distances. A scale (3), graduated every 2 millimeters from 56 to 74, permits the observer rapidly to set the telescope to suit his eye distance when the spacing of his eyes is known. The eyepiece (1) can be focused independently for each eye by screwing in or out. Each is provided with a diopter scale (2) for rapid setting when the observer knows the correction for his eye. The zero graduations indicate the settings for normal eyes.

(2) The left telescope is fitted with a glass reticle (fig. 19 ① and ②) upon which are etched a vertical mil scale, a horizontal mil scale, and on field glasses of older manufacture

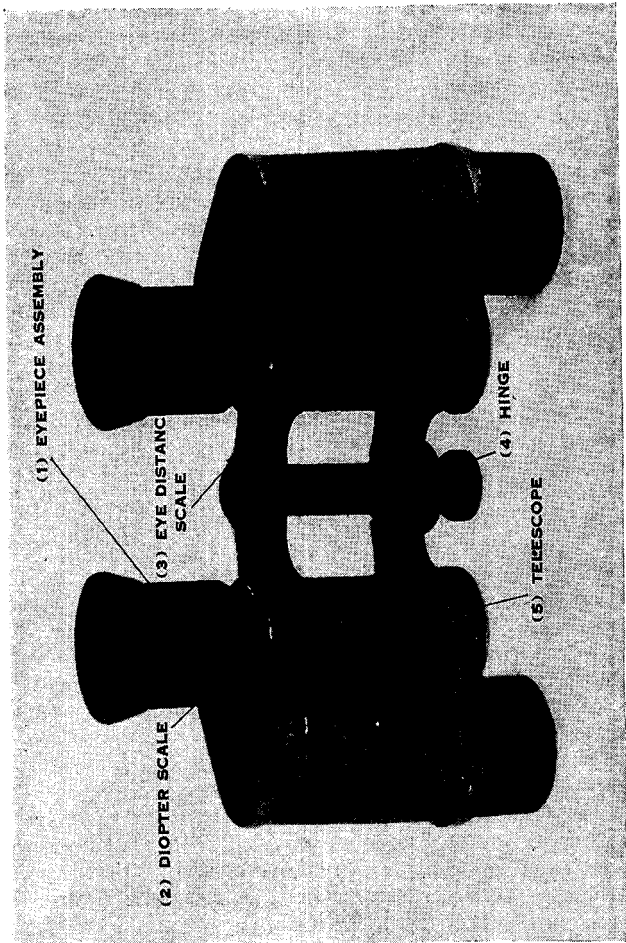

FIGURE 18.—Field glass, type EE.

a stadia graduated similarly to the sight leaf graduation on the service rifle, but inverted.

b. Use.—The field glass is used for observations and the measurement of small horizontal and vertical angles in mils. The vertical stadia scale (inverted sight leaf) is used to pick up auxiliary aiming marks in direct laying and to determine troop safety for overhead fire.

c. Preliminary adjustments; interpupillary distances.—To adjust the glass so that the eyepieces are the same distance apart as the pupils of the observer's eyes, point the glass at the sky and open or close the hinged joint until the field of view ceases to be two overlapping circles and appears to be one sharply defined circle. Note the reading on the scale (3), which indicates the spacing of the observer's eyes. The similar setting of any other field glass will then accommodate his eyes.

d. Focus of the eyepiece.—Look through the glasses, both eyes open, at an object several hundred yards away. Place the hand over the front of one telescope and screw the eyepiece of the other in or out until the object is sharply defined. Repeat this operation for the other eye and note the reading on the diopter scale. The similar setting of any other field glass will accommodate the eyes.

e. Operation.—(1) In using the glass it should be held in both hands and pressed lightly to the eyes so as to keep the relation with the eyes constant without transmitting tremors from the body. The bent thumbs should fit into the outer edges of the eye sockets in such a manner as to prevent light from entering in rear of the eyepieces. When possible it is best to use a rest for the glass or elbows.

(2) The mil scales are seen when looking through the glass, and by superimposing them upon the required objects the horizontal and vertical angles may be read between these objects.

f. Care.—The field glass is a rugged, serviceable instrument but should not be abused or roughly handled.

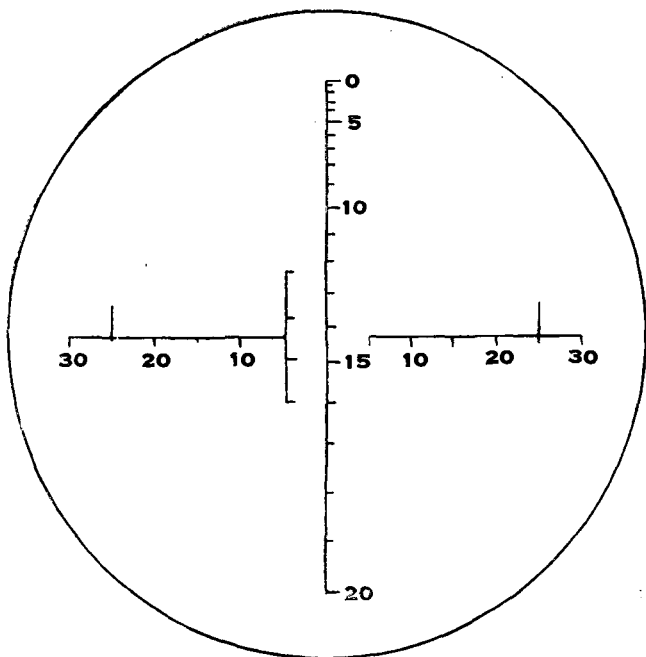

① Older manufacture.

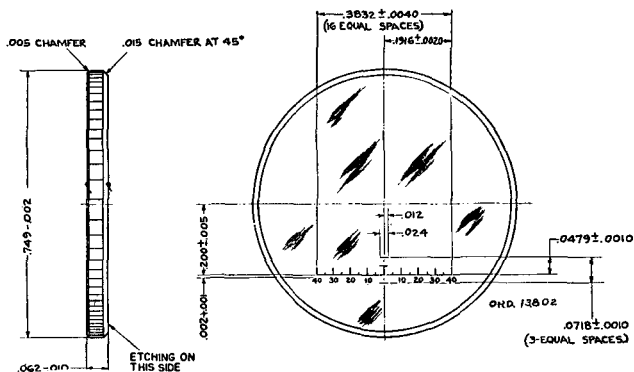

② Recent manufacture.

FIGURE 19.—Reticles on field glasses.

SECTION IX
AMMUNITION

■ 40. GENERAL.—The information in this section pertaining to the several types of cartridges authorized for use in the U. S. rifle, caliber .30, M1, includes description, means of identification, care, use, and ballistic data.

■ 41. CLASSIFICATION.—*a.* (1) Based upon use, the principal classifications of ammunition for this rifle are—

(a) *Ball*—for use against personnel and light matériel targets.

(b) *Tracer*—for observation of fire and incendiary purposes.

(c) *Armor-piercing*—for use against armored vehicles, concrete shelters, and similar bullet-resisting targets.

(2) The following types are similar to ball, except for the following:

(a) Armor-piercing is painted black for $\frac{1}{4}$ inch from the point.

(b) Tracer is painted red for $\frac{1}{4}$ inch from point.

b. (1) Other types provided for special purposes are—

(a) *Guard*—for guard purposes (gallery practice cartridges also used for this purpose).

(b) *Blank*—for simulated fire, signaling, and salute.

(c) *Dummy*—for training.

(2) For guard and blank ammunition the chamber pressure is insufficient to operate self-loading mechanism. Single shots may be fired by pulling back the operating rod handle to extract the fired cartridge case.

■ 42. LOT NUMBER.—When ammunition is manufactured, an ammunition lot number is assigned which becomes an essential part of the marking in accordance with specifications. This lot number is marked on all packing containers and the identification card inclosed in each packing box. It is required for all purposes of record, including grading and use, reports on condition, functioning, and accidents, in which the ammunition might be involved. Those lots only of grades appropriate for the weapon will be fired. Since it is impracticable to mark the ammunition lot number on each individual cartridge, every effort should be made to

maintain the ammunition lot number with the cartridges once the cartridges are removed from their original packing. Cartridges which have been removed from the original packing and for which the ammunition lot number has been lost are placed in grade 3. It is therefore obvious that when cartridges are removed from their original packings they should be so marked that the ammunition lot number is preserved.

■ 43. GRADE.—Current grades of all existing lots of small arms ammunition are established by the Chief of Ordnance and are published in Ordnance Field Service Bulletin No. 3-5. No lot other than that appropriate to the weapon will be fired. Color bands painted on the sides and ends of the packing boxes further identify the various types of ammunition. The following color bands are used to identify cartridges:

Armor-piercing.....	Blue on yellow.
Ball.....	Red.
Blank.....	Blue.
Dummy.....	Green.
Gallery practice.....	Brown.
Guard.....	Orange.
Tracer.....	Green on yellow.

■ 44. CARE, HANDLING, AND PRESERVATION.—*a.* Small arms ammunition is not dangerous to handle. Care, however, must be observed to keep the boxes from becoming broken or damaged. All broken boxes must be immediately repaired, and careful attention should be given that all markings are transferred to the new parts of the box. The metal liner should be air tested and sealed if equipment for this work is available.

b. Ammunition boxes should not be opened until the ammunition is required for use. Ammunition removed from the airtight container, particularly in damp climates, is apt to corrode, thereby causing the ammunition to become un-serviceable.

c. The ammunition should be protected from mud, sand, dirt, and water. If it gets wet or dirty, wipe it off at once. Light corrosion, if it forms on cartridges, should be wiped

off. However, cartridges should not be polished to make them look better or brighter.

d. No caliber .30 ammunition, other than blanks, will be fired until it has been positively identified by ammunition lot number and grade.

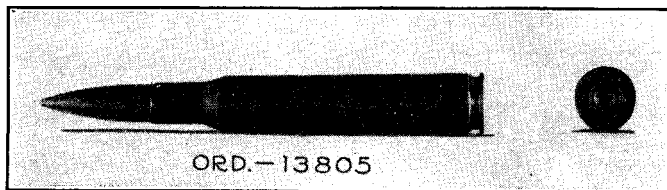

① Ball, M2.

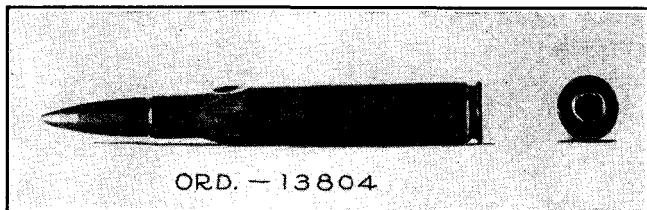

② Guard, M1906.

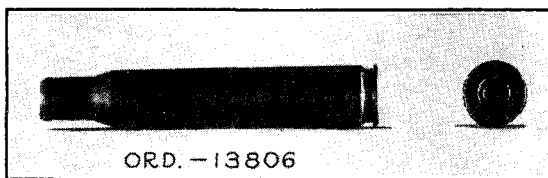

③ Blank, M1909.

FIGURE 20.—Cartridges, caliber .30.

■ 45. CARTRIDGE, BALL, CALIBER .30, M2 AND M1.—The approximate maximum range for the M2 cartridge is 3,450 yards, while for the M1 it is 5,500 yards. The M2 type is standard.

■ 46. PRECAUTIONS IN FIRING BLANK AMMUNITION.—*a.* It is dangerous to fire rifles loaded with blank cartridges at per-

sonnel representing an enemy at distances of less than 20 yards as the wad or paper cup may fail to break up.

b. Misfires in which the primer explodes but fails to ignite the powder charge may prove dangerous when blank ammunition is being fired. In this type of misfire, some of the powder may be blown into the bore of the weapon. A series of such rounds in which the powder fails to ignite due to moisture or other causes will result in an accumulation of powder sufficient to cause serious damage when ignited by a normal cartridge. When misfires are encountered in blank ammunition in excess of 5 percent, the firing of the lot will be suspended and reported to the Chief of Ordnance.

CHAPTER 2

MARKSMANSHIP; KNOWN-DISTANCE TARGETS

	Paragraphs
SECTION I. General	47-54
II. Preparatory marksmanship training.....	55-62
III. Qualification courses.....	63-67
IV. Range practice	68-72
V. Equipment; known-distance targets and ranges, and range precautions.....	73-76
VI. Small-bore practice.....	77-80

SECTION I

GENERAL

■ 47. PURPOSE.—The purpose of this chapter is to provide a thorough and uniform method of training individuals to be good rifle shots and of testing their proficiency in firing at known-distance targets.

■ 48. NECESSITY FOR TRAINING.—*a.* Without proper training a man instinctively does the wrong thing in firing the rifle. He gives the trigger a sudden pressure which causes flinching. However, if he is thoroughly instructed and drilled in the mechanism of correct shooting, and is then carefully and properly coached when he begins firing, he rapidly acquires correct shooting habits. It is much easier to develop into an excellent shot a man who has never fired a rifle than it is to correct the errors of a man who has done a good deal of shooting under improper supervision.

b. Rifle firing is a mechanical operation which anyone who is physically and mentally fit to be a soldier can learn to do well if properly instructed. The methods of instruction are the same as those used in teaching any mechanical operation. The training is divided into steps which must be taught in proper sequence. The soldier is carefully coached and is corrected whenever he starts to make a mistake.

■ 49. **FUNDAMENTALS.**—To become a good rifle shot the soldier must be thoroughly trained in the following essentials of good shooting:

- a. Correct sighting and aiming.
- b. Correct positions.
- c. Correct trigger squeeze.
- d. Correct application of rapid-fire principles.
- e. Knowledge of proper sight adjustments.

■ 50. **PHASES OF TRAINING.**—*a.* Marksmanship training is divided into the following phases:

- (1) Preparatory marksmanship training.
- (2) Range practice.

b. No individual should be given range practice until he has had a thorough course in preparatory training.

c. The soldier should be proficient in mechanical training and related subjects before he receives instruction in marksmanship training.

d. Every man who is to fire on the range will be put through the entire preparatory course. No distinction will be made between recruits and men who have had range practice, regardless of their previous qualification. Some part of the preparatory instruction may have escaped them in previous years; it is certain that some of it has been forgotten, and in any case it will be helpful to go over it again and refresh the mind on the subject.

e. When necessary and when time permits, all of the non-commissioned officers of the unit should be put through a course of instruction and required to pass a rigid test before the period of preparatory training for the unit begins.

■ 51. **PRACTICE SEASONS.**—*a. Regular.*—(1) Under ordinary conditions the regular practice season for the Regular Army will cover a period of about 3 weeks for each organization. A period of not more than 1 week is devoted to preparatory exercises and 2 weeks to range practice. When unforeseen circumstances are such as to cause a delay during the period of instruction, the time may be extended by the post commander.

(2) The regular practice season for units of the National Guard and the Organized Reserves will be of such duration

and ordered at such times as may be best suited for effective training.

(3) Under no conditions will any man be given range practice until he has had a thorough course in the preparatory exercises.

b. Supplementary.—Supplementary practice is not necessary when the regular practice season has been efficiently conducted, except in cases where a large number of unqualified men join the organization after the regular practice season. The supplementary practice season is usually placed as late in the fall as is consistent with efficient instruction. However, this practice may be held at any time when circumstances make it advisable.

■ 52. CONTINUOUS PRACTICE.—Rifle practice is not limited to a particular season. Subject to ammunition allowances, commanding officers will adopt such measures as may be necessary to maintain a high state of excellence in rifle firing throughout the year. The particular measures adopted will depend upon the facilities near the post or station. The measures taken may provide for competitions between individuals or organizations or the encouragement of small-bore rifle teams.

■ 53. RECRUIT INSTRUCTION.—As part of their recruit training, all recruits armed with the rifle will be thoroughly instructed in mechanical training and the fundamental elements of rifle marksmanship—sighting and aiming, positions, trigger squeeze, and rapid fire. They will be given a final examination and should fire one of the small-bore qualification courses outlined in paragraph 80. Instruction in rifle marksmanship will commence with the initial instruction of the recruit and will continue throughout the period of recruit training.

■ 54. LEADERS AND COMMANDERS; DUTIES AND EQUIPMENT.—*a. Duties.*—(1) *Squad leader.*—(a) Organizes the work in his squad so that each man is occupied during the preparatory period in the prescribed form of training for target practice.

(b) Examines each man in his squad at the end of the training on each preparatory step and assigns him a mark in the proper place on the blank form showing state of training.

(c) Sees that each man takes proper care of his rifle and that he cleans it at the end of each day's firing.

(d) Enforces correct aiming, position, and trigger squeeze when fire is simulated in drills and maneuvers.

(2) *Platoon leader*.—Supervises and directs the squad leader in training his squad; personally checks each man in his platoon on the points enumerated in the blank form; and examines each man along the lines outlined in paragraph 62.

(3) *Company commander*.—Requires the prescribed methods of instruction and coaching to be carried out carefully and in detail; supervises and directs the squad and platoon leader; in companies of less than 60 men, performs the duties prescribed in (2) above for platoon leaders.

(4) *Battalion commander*.—Requires the officers and non-commissioned officers to be familiar with and understand the prescribed methods of instruction and coaching; supervises the instruction within his battalion and requires the companies to follow out the preparatory exercises and methods of coaching carefully and in detail.

b. Equipment.—All equipment used in the preparatory exercises must be accurately and carefully made. One of the objects of these exercises is to cultivate a sense of exactness and carefulness in the minds of the men undergoing instruction. They cannot be exact with inexact instruments, and they will not be careful when working with equipment that looks carelessly made (pars. 73 and 166).

SECTION II

PREPARATORY MARKSMANSHIP TRAINING

■ 55. *GENERAL*.—*a.* The purpose of preparatory marksmanship training is to teach the soldier the essentials of good shooting, and to develop fixed and correct shooting habits before he undertakes range practice.

b. Preparatory marksmanship training is divided into six steps, as follows, and should be concentrated in the period of time allotted:

- (1) Sighting and aiming exercises.
- (2) Position exercises.
- (3) Trigger-squeeze exercises.
- (4) Rapid-fire exercises.

(5) Instruction in the effect of wind, sight changes, and use of the score book.

(6) Examination of men before starting range practice.

c. The first four steps listed above are given in the sequence listed; each succeeding step involves the use of technique learned in preceding steps. Instruction in the effect of wind, sight changes, and the use of the score book is not a training step that need be given in any particular sequence, but will be given before the examination which is the final step prior to range practice; these subjects can be taught indoors during inclement weather.

d. Each of the first four steps starts with a lecture by the instructor to the assembled group. This talk includes a demonstration by a squad which the instructor puts through the exercises that are to constitute the day's work. He shows exactly how to do the exercises that are to be taken up and explains why they are done and their application to rifle shooting. He shows how the squad leader organizes the work so that no men are idle, and how they coach each other when they are not under instruction by an officer or noncommissioned officer. These talks and demonstrations are an essential part of the training. If properly given they awaken the interest and enthusiasm of the whole command for the work and give an exact knowledge of how each step is to be carried on—something that men cannot get from reading a description no matter how accurate and detailed that description may be. The instructor who gives these talks and demonstrations may be the platoon leader of his platoon, the commanding officer of his unit, or he may be a specially qualified officer who has been detailed as officer in charge of rifle instruction. The instructors who apply the demonstrated exercises to the men of the command are the officers and non-commissioned officers of the units undergoing instruction.

e. The instruction must be thorough and it must be individual. Each man must understand every point and be able to explain each one in his own words. Each man must be brought to as high a state of proficiency on all of the enumerated points as the time allotted for preparatory work will permit. The company commander will carefully supervise the work. He should pick out men at random through the

different platoons from time to time and put them through a test to see if the instruction is thorough and is progressing satisfactorily.

f. The following blank form should be kept by each squad leader and by each platoon leader independently of the squad leader. This blank form shows at a glance how much each man knows about each point.

Name	Care and cleaning of the rifle	Sighting bar	Sighting and aiming with rifle	Shot group exercises	Blackening sights	Use of gun sling	Taking up the slack	Holding the breath	Positions	Assuming positions rapidly	Trigger squeeze	Calling the shot	Rapid fire	Sight changes	Effect of light and wind	Use of score book	Ability to coach	Final examination	Gallery practice	Pads

METHOD OF MARKING

Fair:	×	Good:	×	Excellent:	×
			×		×
					×

g. Interest and enthusiasm must be sustained and everything possible should be done to stimulate them. As soon as these exercises deteriorate into a perfunctory performance of physical exercise they do more harm than good.

h. Careful attention will be paid to the essential points as shown in the form of questions and answers in paragraph 62. This will be consulted by the instructor during each step of the preparatory work. Each man should be tested thoroughly before he is allowed to fire.

i. During the preparatory exercises, whenever a man is in a firing position, the coach and pupil system is used. The men are grouped in pairs and take turns in coaching each other. The man undergoing instruction is called the pupil.

The man giving instruction is called the coach. When the men of a pair change places the pupil becomes the coach and the coach becomes the pupil.

j. Correct shooting habits should be acquired during the preparatory training period. All errors must be noted, brought to the attention of the pupil, and corrective action taken. Each individual must be impressed with the importance of exactness in every detail. For example, there is no such thing as an aim that is *about right*; it is either perfect or it is incorrect.

k. Equipment used in the preparatory training is listed in paragraph 73.

l. Practice dummy ammunition only will be used during the preparatory training. The corrugated type of dummy cartridges only will be used on the firing line.

■ 56. **BLACKENING THE SIGHTS.**—In all preparatory exercises involving aiming and in all range firing, both sights of the rifle should be blackened. Before blackening, the sights should be cleaned and all traces of oil removed. The blackening is done by holding each sight for a few seconds in the point of a small flame which is of such a nature that a uniform coating of lampblack will be deposited on the metal. Materials commonly used for this purpose are carbide lamp, cylinder or carbide gas, kerosene lamp, candles, small pine sticks, and shoe paste. Carbide gas from a cylinder or a lamp is the most satisfactory of the materials named.

■ 57. **FIRST STEP: SIGHTING AND AIMING** (fig. 21).—*a. First exercise.*—The instructor shows a sighting bar to his group and explains its use as follows:

(1) The front and rear sights on the sighting bar represent enlarged rifle sights.

(2) The sighting bar is used in the first sighting and aiming exercise because with it small errors can be seen easily and explained to the pupil.

(3) The eyepiece requires the pupil to place his eye in such position that he sees the sights in exactly the same alinement as seen by the coach.

(4) There is no eyepiece on the rifle, but the pupil learns by use of the sighting bar how to aline the sights properly when using the rifle.

(5) The removable target attached to the end of the sighting bar is a simple method of readily alining the sights on a bull's-eye.

(6) The instructor explains the peep sight to the assembled group, showing each man the illustrations of a correct sight alinement (fig. 22).

(7) The instructor adjusts the sights of the sighting bar with the target removed to illustrate a correct alinement of the sights. Each man of the assembled group looks through the eyepiece at the sight adjustment.

(8) He adjusts the sights of the sighting bar with various small errors in sight alinement and has each man of the assembled group endeavor to detect the error.

(9) The instructor describes a correct aim, showing the illustration to each man. He explains that the top of

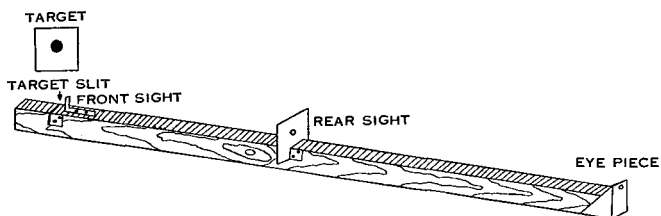

FIGURE 21.—Sighting bar.

the front sight is seen through the middle of the circle and just touches the bottom of the bull's-eye, so that all the bull's-eye can be clearly seen (fig. 22).

(10) The eye should be focused on the bull's-eye in aiming, and the instructor assures himself, by questioning the men, that each understands what is meant by focusing the eye on the bull's-eye.

(11) The instructor adjusts the sights of the sighting bar and the removable target so as to illustrate a correct aim and requires each man of the group to look through the eyepiece to observe the correct aim.

(12) He adjusts the sights and the removable target of the sighting bar so as to illustrate various small errors and requires each man in the group to attempt to detect the error.

FRONT SIGHT

PEEP SIGHT

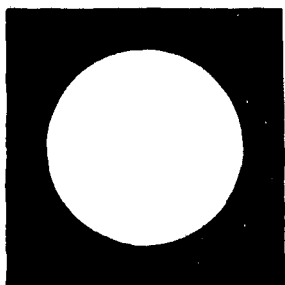

①

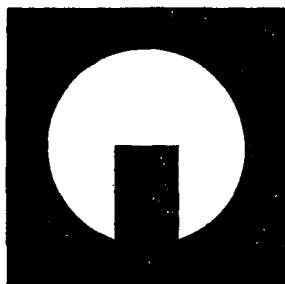

②

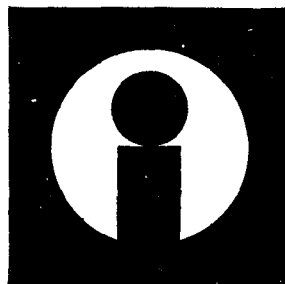

③

FIGURE 22.—Sight alinement.

(13) The exercise described above having been completed by the squad leader or other instructor, the men are placed in pairs and repeat the exercise by the coach-and-pupil method.

(14) As soon as the pupil is considered proficient in the first sighting and aiming exercise, he is put through the second and third sighting and aiming exercises by the instructor. Such pupils are then placed in pairs to instruct each other in these two exercises by the coach-and-pupil method.

b. Second exercise.—(1) A rifle with sights blackened is placed in a rifle rest and pointed at a blank sheet of paper mounted on a box (fig. 23). Without touching rifle or rifle rest, the coach takes the position illustrated and looks through the sights. The coach directs the marker by command or improvised signal to move the small disk until the bottom of the bull's-eye is in correct alinement with the sights (fig. 22) and then commands: **HOLD**, to the marker. The coach moves away from the rifle and directs the pupil to look through the sights in order to observe the correct aim.

(2) The marker moves the disk out of alinement. The pupil takes position and directs the marker to move the disk until the bottom of the bull's-eye is in correct alinement with the sights. The coach then looks through the sights to see if the alinement is correct.

(3) The coach alines the sights on the bull's-eye with various slight errors to determine whether or not the pupil can detect them.

c. Third exercise.—(1) The object of this exercise is to show the importance of uniform and correct aiming and to instill into the mind a sense of exactness. At 50 feet and with a small bull's-eye a good group of three marks can be covered by the unsharpened end of a lead pencil. (Fig. 24.)

(2) This exercise is conducted as follows: The rifle with the sights blackened is placed in a rifle rest and pointed at a blank sheet of paper mounted on a box. The pupil takes the position illustrated and looks through the sights without touching the rifle or rifle rest. The pupil directs the

marker, by command or improvised signal, to move the disk until the bottom of the bull's-eye is in correct alinement with the sights, and then commands: **HOLD**, to the marker. The coach then looks through the sights to see if the alinement is correct. Then without saying anything to the pupil, he commands: **MARK**, to the marker. The marker



FIGURE 23.—Position for second sighting and aiming exercise.

without moving the disk makes a dot on the paper with a sharp-pointed pencil inserted through the hole in the center of the bull's-eye. The marker then moves the disk to change the alinement. The pupil and coach, without touching the rifle or rifle rest, repeat this operation until three dots, numbered 1, 2, 3, respectively, have been made. These dots then outline the shot group and the pupil's name is

written under it. The size and shape of the shot group will be discussed and the errors pointed out. This exercise will be repeated until proficiency is attained.

(3) This exercise should also be held during the period of the preparatory training at 200 yards on a 10-inch movable bull's-eye (fig. 24), and if time permits at 500 yards on a 20-inch movable bull's-eye. These exercises teach the men to aim accurately at a bull's-eye the outlines of which are indistinct. If the exercise is properly handled it helps greatly to sustain interest in the work. At 200 yards a man should be able to make a shot group that can be covered with a silver



FIGURE 24.—Position for third sighting and aiming exercise at long ranges.

dollar, and at 500 yards with the small (3-inch) sighting disk.

(4) Tissue paper may be used to copy off each pupil's shot group at long range. The name of the pupil is written on the tissue paper under the shot group he made. These tracings are sent back to the firing line so that the pupil can see what he has done.

(5) The third sighting and aiming exercise, especially the long range shot group work, may be carried on during the

time devoted to the second and third preparatory steps. The purpose of continuing these exercises is to bring backward men up to the proper state of proficiency and to assist in keeping the men interested.

(6) Competition between the individuals of a squad to see which can make the smallest shot group is of value in creating interest in this exercise.

■ 58. SECOND STEP: POSITIONS.—*a. General.*—Instruction in positions includes the use of the gun sling, taking up the slack in the trigger, holding the breath while aiming, aiming, and the use of the aiming device.

b. Gun sling.—(1) The gun sling properly adjusted is of great assistance in shooting in that it helps to steady the rifle. Each man will be assisted by the instructor in securing the correct adjustment for his sling. In a firing position the sling should be adjusted to give firm support without discomfort to the soldier. The gun sling is readjusted for drill purposes by means of the lower loop without changing the adjustment of the upper loop.

(2) There are two authorized adjustments, the *loop* sling and the *hasty* sling. The *hasty* sling is more rapidly adjusted than the *loop* sling, but it gives less support in positions other than the standing position.

(*a*) *Loop adjustment* (fig. 25).

1. Loosen the lower loop.
2. Insert the left arm through upper loop from right to left, so that the upper loop is near the shoulder and well above the biceps muscle.
3. Pull the keepers and hook close against the arm to keep the upper loop in place.
4. Move the left hand over the top of the sling and grasp the rifle near the stock ferrule swivel so as to cause the sling to lie smoothly along the hand and wrist. The lower loop, not used in this adjustment, should be so loose as to prevent any pull upon it. Neither end will be removed from either swivel.

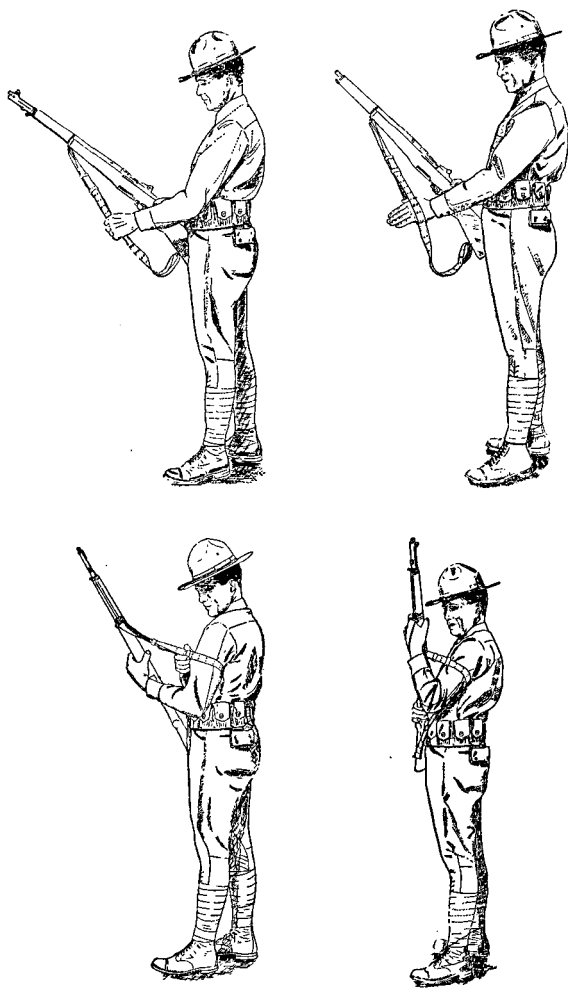

FIGURE 25.—Loop adjustment.

(b) Hasty sling adjustment.

1. Loosen the lower loop.
2. Grasp the rifle just in rear of the stock ferrule swivel with the left hand and grasp the small of the stock with the right hand.
3. Throw the sling to the left and catch it above the elbow and high on the arm.
4. Remove the left hand from the rifle, pass the left hand under the sling, then over the sling and re-grasp the rifle with the left hand so as to cause the sling to lie along the hand and wrist. The sling may be given one-half turn to the left and then adjusted. This twisting causes the sling to lie smoothly along the hand and wrist.

c. Taking up slack.—The first movement of the trigger which takes place when light pressure is applied is called "taking up the slack." It is part of the position exercise because this play must be taken up by the finger as soon as the correct position is assumed and before careful aiming is begun. The entire amount of slack in the trigger is taken up by one positive movement of the finger.

d. Holding breath.—(1) Holding the breath in the proper manner while aiming is very important. It will be found that a large proportion of men in any group undergoing instruction in rifle practice do not know how to hold the breath in the proper manner. Each man must be carefully instructed and tested on this point. The correct manner of holding the breath must be practiced at all times during position and trigger-squeeze exercises and whenever firing or simulating fire.

(2) To hold the breath properly draw into the lungs a little more air than is used in an ordinary breath. Let out a little of this air and stop the remainder by closing the throat so that the air remaining in the lungs will press against the closed throat. Do not hold the breath with the throat open or by the muscular action of the diaphragm as if attempting to draw in more air. The important point is to be comfortable and steady while aiming and squeezing the trigger.

e. Aiming.—The rifle is carefully aimed at a target each time a firing position is assumed. The aiming device may be used by the coach to check the aim.

f. General rules for positions.—The general rules which follow are common to the prone, sitting, kneeling, and standing positions. The exact details of a position for any particular individual will depend on the conformation of the man.

(1) To assume any position, except the prone position, half face to the right and then assume the position.

(2) Upon assuming any position there is some point to which the rifle points naturally and without effort. If this point is not the center of the target, the whole body must be shifted so as to bring the rifle into proper alinement. Otherwise the firer will be firing under a strain because he will be pulling the rifle toward the target by muscular effort for each shot.

(3) The right hand grasps the small of the stock. The right thumb may be either over the small of the stock or on top of the stock; it should not be placed alongside the stock.

(4) The left hand is against or near the stock ferrule swivel, wrist straight, rifle placed in the crotch formed by the thumb and index finger and resting on the heel of the hand.

(5) The left elbow will be as nearly under the rifle as it can be placed without appreciable effort.

(6) Ordinarily the second joint of the index finger contacts the trigger. The first joint may be used by men the length of whose arm or the size of whose hand is such as to make it difficult to reach the trigger with the second joint, or to whom the first joint of the finger seems more natural and comfortable.

(7) The cheek is pressed firmly against the stock and placed as far forward as possible without strain to bring the eye near the rear sight.

(8) The butt of the rifle is held firmly against the shoulder.

(9) The rifle should not be canted.

(10) Left-handed men who have difficulty with the right-hand position will be allowed to use the left-hand position.

g. Prone position (fig. 26).—(1) In assuming the prone position the body should lie at an angle of about 45 degrees to the line of aim with the spine straight. The exact angle of the body to the line of aim will depend upon the conformation of the firer. The legs should be well apart, the inside of the feet flat on the ground, or as nearly so as can be attained without strain. Elbows should be well under the body so as to raise the chest off the ground. The right hand grasps the small of the stock. The left hand should be near the stock ferrule swivel, as far forward as is comfortable and convenient for the individual firer, wrist straight, rifle placed in the crotch formed by the thumb and index finger and resting on the heel of the hand. The cheek should be firmly pressed against the stock with the eye as close to rear sight as is possible, without straining the neck muscles. The sling should be just sufficiently tight to offer support, but not so tight as to have a tendency to pull the left elbow to the left. The right thumb may be over the small of the stock or on top of the stock; it should not be placed alongside the stock.

(2) The exact details of the position will vary, depending upon the conformation of the individual firer. However, the firer must secure a position that will not be changed by the recoil of the weapon. When the correct position has been attained it will be found that upon discharge the muzzle will move slightly up and very slightly to the right, and that it will then settle back close to the original aiming point.

h. Sandbag rest position.—(1) The sandbag rest position conforms in every detail to the normal prone position described above, with the addition of a sandbag which supports the left forearm, wrist, and hand.

(2) The bag is a little more than half full and tied near the top so as to leave considerable free space above the sand.

(3) It is important that the sandbag be high enough to permit the taking of the normal prone position. The natural tendency is to have a low rest and to be very flat on the ground with the elbows spread apart. This is a faulty position which causes lower scores than if no rest at all were used. The sandbag when properly adjusted is a great help. When it is not properly adjusted it is a handicap.

(4) The sandbag rest position is used in the first stages of a pupil's training, not to teach steadiness of holding but to teach the correct trigger squeeze. By using the sandbag the slight unsteadiness of the hold is avoided, and the temptation to try to snap in the shot at the instant the sights touch the

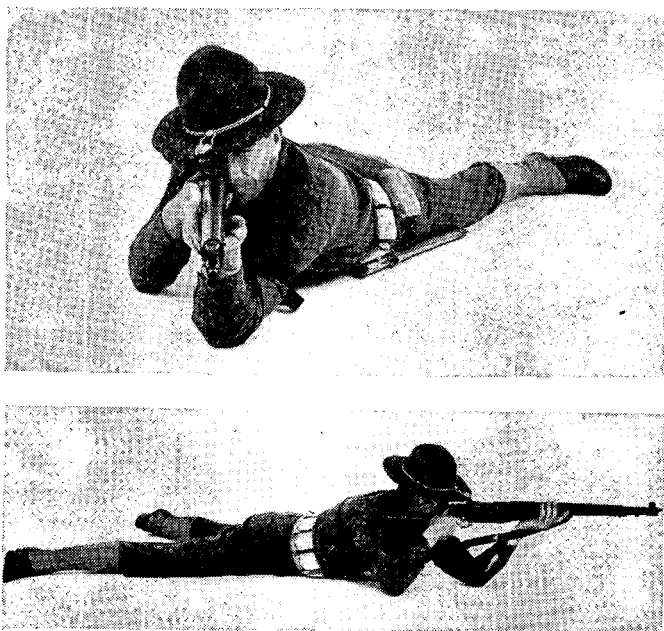

FIGURE 26.—Prone position.

bull's-eye, an action which causes all poor shooting, is eliminated.

(5) The coach will adjust the sandbag as follows:

(a) Have the pupil assume the prone position and aim at the target.

(b) Set the sandbag on its bottom and arrange the sandbag so that it is slightly higher than the back of the pupil's left hand.

(c) Facing the pupil, straddle the rifle barrel, and slide the sandbag against the pupil's left forearm, so that the narrow side of the bag supports his forearm and wrists and the back of his hand rests on top.

(d) Lower the sandbag to the proper height by pounding it with the hand.

i. Sitting position (fig. 27).—(1) The firer sits half-faced to the right; feet well apart and well braced on the heels which are dug slightly into the ground; body leaning well forward from the hips with back straight; both arms resting inside

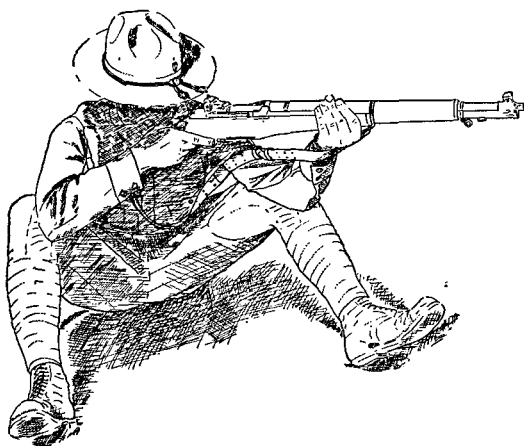

FIGURE 27.—Sitting position.

the legs and well supported; cheek pressed firmly against the stock and placed as far forward as possible without straining; left hand near the stock ferrule swivel, wrist straight, rifle placed in the crotch formed by the thumb and index finger and resting on the heel of the hand.

(2) The sitting position is used in the field when firing from ground that slopes downward to the front. In practicing this position the feet may be slightly lower than the ground upon which the pupil sits. Sitting on a low sandbag is authorized.

(3) In the event the conformation of a man is such that he cannot assume the prescribed normal position, such changes as may be necessary to secure a steady, comfortable position are authorized.

j. Kneeling position (fig. 28).—The firer kneels half-faced to the right on the right knee, sitting on the right heel; the left knee bent so that the left lower leg is vertical (as seen from the front); left arm well under the rifle and resting on the left knee with the point of the elbow beyond the kneecap; right elbow above or at the height of the

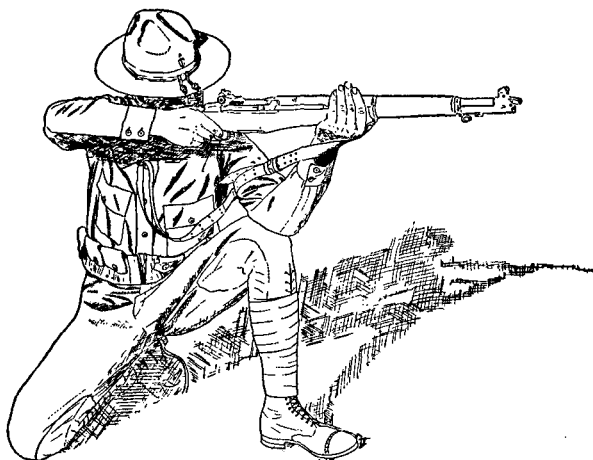

FIGURE 28.—Kneeling position.

shoulder; cheek rests firmly against the stock and is placed as far forward as possible without strain. Sitting on the side of the foot instead of the heel is authorized.

k. Standing position (fig. 29).—The firer stands half-faced to the right; feet from 1 foot to 2 feet apart; body erect and well-balanced; left elbow well under the rifle; left hand in front of the balance, wrist straight, rifle placed in the crotch formed by the thumb and index finger and resting on the heel of the hand; butt of the piece high up on the

shoulder and firmly held; right elbow approximately at the height of the shoulder; cheek pressed against the stock and placed as far forward as possible without strain. A position with the left hand against or under the trigger guard and with the left upper arm supported against the body is not a practical field position and is prohibited.

1. Procedure in conducting position exercises.—(1) Small bull's-eyes are used as aiming points. These bull's-eyes



FIGURE 29.—Standing position.

should be placed at a range of 1,000 inches and at different heights so that in aiming from various positions the rifle will be nearly horizontal, or standard known-distance targets may be installed at distances used on the known-distance range.

(2) Before taking up each phase of the position exercise the instructor assembles his squad or group and—

(a) Shows them the proper method of blackening the front and rear sights of the rifle and has each pupil blacken his sights.

(b) Explains and demonstrates the hasty sling adjustment and assists each pupil to adjust his sling. He explains the loop sling adjustment and assists each pupil to adjust his sling.

(c) Explains and demonstrates the proper manner of taking up the slack and has each pupil practice it.

(d) Explains and demonstrates the proper manner of holding the breath and has each pupil practice it.

(e) Explains and demonstrates the use of the aiming device.

(f) Explains the general rules which apply to all positions.

(g) Explains and demonstrates the different positions.

(3) Following explanations and demonstrations the instruction becomes individual by the coach-and-pupil method. Each pupil, after seeing that his sights are blackened, adjusts his sling, takes position, takes up the slack, aims carefully, and holds his breath while aiming. As soon as his aim becomes unsteady the exercise ceases. After a short rest the pupil repeats the exercise without further command. The trigger is not squeezed in the position exercises. Exercises are conducted in all positions.

m. Duties of the coach.—In the position exercises the coach sees that—

(1) The sights are blackened.

(2) The gun sling is properly adjusted, is tight enough to give support, and is high up on the arm.

(3) The proper position is taken.

(4) The slack is taken up promptly.

(5) The pupil aims.

(6) The breath is held while aiming.

The coach checks the pupil's manner of holding his breath by watching his back. The pupil's arm may be checked occasionally by means of the aiming device.

■ 59. **THIRD STEP: TRIGGER SQUEEZE.**—*a. Importance of trigger squeeze.*—(1) The most important item in rifle shooting is to squeeze the trigger in such a way as to fire the rifle without

affecting the aim. Misses and poor shots are due to spoiling the aim just before the discharge takes place. This is done by jerking the trigger and flinching. The trigger must be squeezed so steadily that the firer cannot know the instant the piece will be fired. If a man squeezes the trigger so steadily that he cannot know when the discharge will take place, he does not spoil his aim and he will not flinch, because he does not know when to flinch.

(2) No good shot attempts to discharge the piece instantly upon alining his sights on the mark. He holds his aim as accurately alined on the mark as possible and maintains a steadily increasing pressure upon the trigger until the shot is fired. This method of squeezing the trigger must be carried out in all simulated firing or the value of the practice is lost.

(3) There is only one correct method of squeezing the trigger—a steady increase of pressure so that the firer does not know when the explosion will take place.

(4) Expert shots are men who through training have learned to increase the pressure only when the sights are in correct alinement with the bull's-eye. When the sights become slightly out of alinement, they hold what they have with the finger and only continue the increase of pressure when the sights again become properly alined.

(5) The difference between poor shots and good shots is measured in their ability to squeeze the trigger properly. Any man with fair eyesight and strength can aline the sights on the target and hold them there for an appreciable length of time. When he has acquired sufficient will power and self-control to forget that there is to be an explosion and a shock, and squeezes the trigger with a steady increase of pressure until the rifle is fired, he has become a good shot, and not until then. This squeeze of the trigger applies to rapid fire as well as slow fire. The increase of pressure is faster in rapid fire, but the process is the same.

b. Calling the shot.—The pupils must always notice where the sights are pointed at the instant the rifle is fired, and call out at once where he thinks the bullet will hit. Shots are called even when simulating fire at a mark, so as to acquire the habit and to develop a closer hold. No man can

become a good shot until he is able to call his shot before it is marked. Inability to call a shot indicates the firer did not know where the sights were pointing at the time the rifle was fired; in other words, he shut his eyes first and fired afterward.

c. Procedure in conducting trigger-squeeze exercises.—(1)

(a) The instructor explains to the assembled squad or group the importance of correct trigger squeeze. He assures himself by questions that each pupil understands what is meant by a *steady increase of pressure*; that is, that the increase is only applied when the aim is correct and then by a steady increase and not by a sudden pressure. The instructor explains the necessity for calling the shot. The above points having been explained the instruction becomes individual by the coach-and-pupil method supervised by the instructor.

(b) The pupil is first taught the trigger squeeze in the prone position with the sandbag rest. In this position he can hold steadily and has not the temptation to *snap* the shot the instant the front sight touches the bull's-eye, as he has in a less steady position. After he has learned the principles of correct trigger squeeze with the sandbag rest, he is instructed in the other positions, but during the first half of this period he is not allowed to squeeze the trigger except in the prone position, first with, and then without, the sandbag rest.

(c) A great deal of trigger-squeeze exercise is necessary, but it must be carefully watched and coached. Trigger-squeeze exercise that is not along the right lines is worse than none.

(d) Soldiers should not be allowed to simulate fire until they have been thoroughly instructed in trigger squeeze, and then in all drills and field exercises where fire is simulated they should be cautioned to aim at definite objects and to carry out the correct principles of aiming, squeezing the trigger, and calling the shot.

(2) The instruction is individual by the coach-and-pupil method. Aiming targets similar to those mentioned for the position exercises are used. The exercise is conducted at will in a manner as outlined for the position exercise.

d. Duties of the coach.—In the trigger-squeeze exercises the coach insures that—

- (1) The sights are blackened.
- (2) The gun sling is properly adjusted, is tight enough to give support, and is high up on the arm.
- (3) The proper position is taken.
- (4) The slack is taken up promptly.
- (5) The pupil aims, checking occasionally by means of the aiming device.
- (6) The breath is held while aiming. He checks the breathing by watching the back of the pupil.
- (7) The trigger is squeezed properly.
- (8) The pupil calls the shot.

■ 60. **FOURTH STEP: RAPID FIRE.**—*a. General.*—All the points learned in slow fire are carried out in rapid fire. Careful coaching is essential to insure that the eye is kept on the target during the firing of each clip of cartridges, that the aim is correct, and that the trigger is squeezed correctly for each shot.

b. Timing.—A most important element in rapid fire is the development of correct timing in firing. Correct timing in firing will vary from about 5 seconds per shot for the beginner to about 2 seconds per shot for the experienced man. The development of proper timing in firing rests mainly on the correct position of the firer. The firer's position is not correct unless the sights return automatically to the aiming point after each shot is fired. As soon as the sights come back on the aiming point the firer concentrates on the sight picture and squeezes the trigger quickly. This is repeated for each shot.

Through training, accurate fire becomes more and more rapid until the ability to fire 25 or more accurate shots per minute is acquired.

(1) In timing exercises the instructor first assembles his group and explains and demonstrates—

- (a) The importance of correct position.
- (b) The importance of correct aiming and keeping the eye on the target while firing.
- (c) How the coach promptly presses back the operating handle with a sharp motion to cock the piece and then

releases the pressure to permit the operating handle to go forward. (See fig. 30.)

(d) Correct trigger squeeze.

(e) What is meant by correct timing.

(f) How speed in timing is gradually increased as skill is acquired, until an approximate rate of 2 seconds per shot is attained.

(2) Following the above explanation and demonstration by the instructor, timing exercises using the coach-and-pupil method will be given in all positions except standing.

c. *Taking positions rapidly.*—(1) *Prone position.*—(a) *First method.*—The movement is described by the numbers



FIGURE 30.—Position of coach in rapid fire exercise.

for the purpose of instruction in the sequence of the movement. After this sequence is learned the position will be taken as one motion.

1. Being at the **READY**, sling adjusted, points selected at which right and left elbows are to rest when in the prone position, and the point on the ground just below the butt of the rifle when in the firing position marked, the rifle grasped with the left hand just below the lower band and the right hand at the heel of the stock, bend both knees to the ground.
2. Place the butt of the rifle on the ground at the point marked.

3. Place the left elbow on the ground.
4. Place the butt of the rifle against the right shoulder with the right hand, at the same time spreading the feet apart.
5. Grasp the small of the stock with the right hand and place the right elbow on the ground.

(b) *Skirmisher's method*.—The movement is described by the numbers for the purpose of instruction in the sequence of movement. After this sequence is learned the position will be taken as one motion. These movements will bring the firer into his normal position with the rifle pointing at the target. Care should be taken to place the butt of the rifle on the ground without jar and to place the elbows on the ground in the same manner. With practice this position can be assumed very rapidly and without shock. When properly done the feet will still be sliding into position when the rifle is being placed on the shoulder, and the left elbow will come to the ground at almost the same time that the backward movement of the body is completed.

1. Being at the READY, sling adjusted, points selected at which right and left elbows are to rest when in the prone position, throw the right foot well back and bend the left knee as low as possible, placing the butt of the rifle on the ground 4 or 5 inches to the left and slightly in front of the spot where the right elbow is to rest. The grip of the rifle is retained with both hands.
2. Place the right elbow on the ground.
3. Place the left leg back near the right one, feet apart, and slide well back while lying on the belly.
4. Take the butt of the rifle off the ground and place it against the right shoulder.
5. Lower the left elbow to the ground.

(c) *Other methods authorized*.—Other methods of assuming the prone position may be used.

(2) *Rushing*.—(a) Rushes are not used in the rifle marksmanship course, but may be practiced in preparation for field firing. Being in the prone position with the rifle locked and unloaded, loop sling adjusted on the left arm, the command is: 1. PREPARE TO RUSH, 2. UP. At the com-

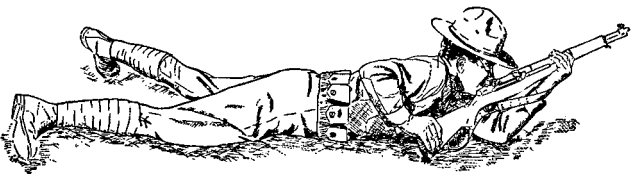
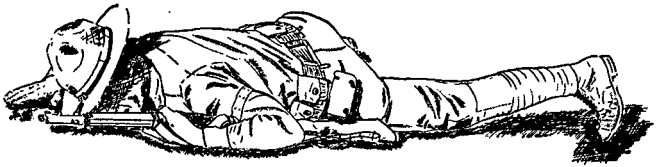

FIGURE 31.—Rushing forward.

mand **PREPARE TO RUSH** draw the arms in until the hands are opposite the chin, elbows down and away from the body. At the command **UP**—

1. Raise the body by straightening the arms.
2. Shift the weight of the body to the right leg and arm and bring the left leg forward with the knee fully bent.
3. Spring up and run forward. Grasp the rifle with both hands, left hand just below the lower band and the right hand at the small of the stock.

(b) Upon arrival at a firing point—

1. Advance the left foot, turning it across the front of the body.
2. Drop forward on the outside of the left knee and at the same time extend the rifle, grasped in both hands and held vertically, so that the butt strikes the ground at full arm's length directly in front of the left knee.
3. Pivoting on the left knee and the butt of the rifle, roll forward onto the left elbow and left side.
4. Simulate loading and with the right hand place the butt of the rifle on the right shoulder, and set the safety in its forward position.
5. Grasp the small of the stock with the right hand and place the right elbow on the ground.

(c) If the hasty sling is used it will be necessary to modify the steps in taking the prone position described in (b) 3 and 4 above, respectively, as follows:

1. Pivoting on the left knee and the butt of the rifle, roll forward on the right elbow and right side.
2. Throw the sling to the left and catch it above the elbow and high on the arm. Remove the left hand from the rifle, pass the left hand under the sling and then over the sling, and regrasp the rifle just below the lower band with the left hand. Place the left elbow on ground.

(3) *Sitting position.*—(a) To assume the sitting position rapidly, break the fall by placing the right hand on the ground slightly to the right rear of the spot on which to sit.

(b) In practicing for range firing, first sit down and aim at the target in the normal sitting position. Then mark the position of the heels and the spot on which to sit. Then at the command **READY ON THE FIRING LINE**, stand with the heels in the places made for them. As the target appears, sit down on the spot marked, breaking the fall with the right hand, grasp the small of the stock with the right hand, and assume the aiming position.

(4) *Kneeling position.*

(a) 1. *From standing.*—First kneel and aim at the target in the normal kneeling position. Then mark the position of the feet and the right knee. At the command **READY ON THE FIRING LINE**, stand with the feet in the places marked for them. As the target appears, kneel with the right knee on the spot marked, place the butt of the rifle on the shoulder with the right hand, grasp the small of the stock with the right hand and assume the aiming position.

2. *After a rush.*—Upon arrival at the firing point, kneel on the right knee; with the right hand place the butt of the rifle against the right shoulder and set the safety in its forward position. Grasp the small of the stock with the right hand and assume the aiming position.

(b) *Other methods authorized.*—Other methods of assuming the kneeling position may be used.

(c) *Practice required.*—Taking positions rapidly from the standing position and after a run should be practiced at will using the coach-and-pupil system.

d. *Reloading rifle.*—(1) During the reloading, the rifle is held firmly with the left hand, with the butt of the rifle down, to facilitate the insertion of the clip. Reloading should be accomplished with a confident movement of the right hand in taking the clip from the belt and placing it on top of the follower. With the tip of the forefinger of the right hand on the floor plate, and with the thumb of the right hand on top of the clip near the rear, the clip is pressed down into the receiver until it engages the clip latch. The thumb is swung to the right so as to clear the bolt in its forward

movement and the operating rod handle is released. The closing of the bolt may be assisted by a push forward on the operating rod handle with the heel of the right hand.

(2) Reloading the rifle without hurried movements and consequent fumbling should be practiced at will in the prone, sitting, and kneeling positions, using practice dummy cartridges, until the desired skill is acquired.

e. Procedure in conducting rapid-fire exercises.—After the pupil has become properly trained in timing, taking positions rapidly, and reloading, he is given additional practice in all of these points by rapid-fire exercises. The group under instruction is paired off, coach and pupil, and placed on line. Full-sized targets are placed at 200 and 300 yards from the men under instruction, with some simple arrangement permitting the target to be exposed to view for the prescribed period of time. Rapid-fire exercises may be conducted at shorter ranges using targets proportionately reduced in size. Sights are set to correspond to the range being used. The commands and procedure are exactly the same as rapid fire on the rifle range except that practice dummy cartridges are used. For example, the pupil stands with sights properly set and blackened, sling adjusted on his arm, and with two clips of practice dummy cartridges in his belt. The instructor, after announcing the range and the position to be used, commands: 1. WITH DUMMY CARTRIDGES, LOCK AND LOAD; 2. READY ON THE RIGHT; 3. READY ON THE LEFT; 4. READY ON THE FIRING LINE; 5. CEASE FIRING; 6. UNLOAD. At the first command the rifles are locked and loaded. At the fourth command the safety on all rifles is set in the forward position. When the target is exposed, pupils take position rapidly and simulate firing 16 rounds, reloading from the belt. Accuracy must not be sacrificed for rapidity. Upon completion of the exercise any cartridges remaining in the rifle are removed and the bolts left open. During simulated firing the soldier should never take his eye from the target except to reload. He should count his shots as he fires in order to know when the receiver is empty and thus avoid the loss of time incident to the effort of pulling the operating rod handle to the rear until the operating rod is caught by the operating

rod catch. The exercise is conducted from the standing position to the prone, sitting, and kneeling positions.

f. Duties of the coach.—In a rapid-fire exercise the coach insures that—

(1) The sights are set for the ranges designated and are blackened.

(2) The gun sling is properly adjusted.

(3) The correct position is taken.

(4) The slack is taken up promptly.

(5) The breath is held while aiming.

(6) The trigger is squeezed properly.

(7) Each time the pupil squeezes the trigger he promptly presses back the operating rod handle with a sharp motion ejecting the dummy cartridge and then releases the pressure to permit the operating rod handle to go forward.

(8) The eye is kept on the target, the elbows kept in place, and the butt of the rifle kept to the shoulder.

(9) The rifle is reloaded quickly and without fumbling.

■ 61. FIFTH STEP: EFFECT OF WIND; SIGHT CHANGES; USE OF SCORE BOOK.—*a. Wind.*—(1) In firing at 600 yards or under, the effect of the weather conditions (except that of the wind) on the bullet can be disregarded. The influence of wind must be carefully studied.

(2) The horizontal clock system is used in describing the direction of the wind. The firing point is considered the center of the clock and the target is at 12 o'clock. A 3 o'clock wind comes directly from the right. A 6 o'clock wind comes straight from the rear. A 9 o'clock wind comes directly from the left. A wind that is constantly changing its direction back and forth is called a "fishtail wind."

(3) The force of the wind is described in miles per hour. The force of the wind is estimated by throwing up light, dry grass, dust, or light paper and watching how fast it travels, by observing the danger flags, and by the mirage. In general a light breeze is a 5 to 8 mile wind; a fairly strong breeze is a 10 to 12 mile wind. Wind blowing 20 miles an hour is very strong.

(4) Wind from either side blows the bullet out of its path. This must be allowed for by moving the rear sight toward the wind by means of the wind gage. The worst kind of a

wind in which to shoot is a fishtail wind at 12 or 6 o'clock. The amount the bullet will be blown from its path depends on the force and direction of the wind and on the distance to the target.

(5) The amount of windage to allow for the first shot is shown in the wind-gage diagram in the score book. One "click" of the windage knob is taken for each quarter point of windage shown in the diagram. It can be found approximately by applying the wind rule.

(6) After the first shot is marked, the correction necessary in windage is found by referring to the ruled targets in the score book showing the windage correction for each range. Windage corrections can also be estimated by applying the wind-gage rule given in *c* below.

b. Wind rule.—(1) The range (expressed in hundreds of yards) multiplied by the velocity of the wind and divided by 10 equals the number of quarter points or clicks to allow for a 3 o'clock or 9 o'clock wind.

Example: At 500 yards the wind is blowing 8 miles per hour at 3 o'clock; $\frac{5 \times 8}{10}$ equals 4 clicks or 1 point of windage. The sight should have 4 clicks or 1 point of right windage for the first shot.

(2) As the direction of the wind gets nearer and nearer to 12 or 6 o'clock the amount of windage necessary becomes less and less. Winds 1 hour away from 3 and 9 o'clock require only slightly less windage. Winds 1 hour away from 12 and 6 o'clock require almost half as much windage as 3 or 9 o'clock winds.

(3) Winds that are at 12 o'clock require no windage, but it is a very rare thing to have a steady wind from either 12 or 6 o'clock. Strong winds from 12 o'clock tend to retard the bullet a little and from 6 o'clock to accelerate it, but the amount is so slight that a correction in elevation is very seldom necessary. At the most this allowance is very small.

c. Wind-gage rule.—One click of the windage knob moves the strike of the bullet 1 inch on the target for each 100 yards of range. Right windage moves the strike of the bullet to the right and left windage moves it to the left as shown by the arrow and letters on the windage knob.

d. Mirage.—(1) Heat waves that can be seen near the ground are called “mirage.” The direction in which these waves are blowing and their speed are watched by good riflemen in judging the direction and velocity of the wind. The mirage is of assistance in judging the wind principally on bright days when there is a light, variable breeze.

(2) In a moderate wind the waves seem to race across the range and to lie close to the ground. In a light wind the waves do not lie so close to the ground and appear to move more slowly. In strong winds the mirage cannot be seen.

(3) When there is no wind or when the wind is at 12 or 6 o'clock the mirage seems to boil. The *boiling* of the mirage signifies that the wind is changing direction. The firer should wait until the mirage begins a steady flow from one side or the other before firing.

(4) Mirage can be seen much better with a field glass or telescope than with the eye alone.

e. Elevation rule.—One click of the elevating knob moves the strike of the bullet 1 inch on the target for each 100 yards of range. The strike of the bullet is moved up or down as shown by the arrow and words on the knob.

f. Light.—(1) Light has no effect on the bullet but does affect the aim. The effect of changes of light is very slight with most riflemen. The correction for variations in light does not exceed one click in elevation at any range. The effect of changes of light is not uniform in its effect upon the aim of all riflemen.

(2) As a general rule men unconsciously aim a little lower in a poor light than in good light and consequently need more elevation when the light is poor. This lowering of the aim is due to the fact that the outline of the bull's-eye is not distinct in a poor light; therefore men cannot hold as close to the bull's-eye and still be sure of their aim. As a rule poor lights exist on dark days when there is a haze in the air; on very bright, warm days when there is a decided mirage; and when the sun is back of the target. The best light for shooting is when the sky is uniformly overcast and there is sufficient light to see the target clearly.

(3) Sunlight from one side has the same effect with most men as wind from that side. This is because the side of the

front sight toward the sun is more clearly defined and unconsciously held under the center of the bull's-eye. Such holding places the bullet on the opposite side of the bull's-eye from the sun. The allowance of windage for sunlight varies from zero to almost two clicks or one-half a point. In making this allowance the sight is moved toward the sun.

g. Zero of a rifle.—(1) The zero of a rifle for each range is the point at which the rear sight must be placed for both elevation and windage in order to hit the center of the bull's-eye on a normal day when there is no wind. This zero may not conform to the marks on the elevating knob and the wind gage. The zero of any one rifle may differ with different men, owing to the difference in their way of holding the rifle or of aiming.

(2) Each man must determine the zero of his own rifle for each range. He does this by studying the data which he has written in his score book concerning sight settings, sight changes, light, and the direction and velocity of the wind. The zero of a rifle is best ascertained on a day with an overcast sky when there is no wind. Having learned the zero of his rifle, the rifleman computes all his windage and elevation allowances for the first shot from this zero and not from the zero marked on the rifle sight unless the two correspond.

h. Shooting up or down hill.—In shooting either up or down hill, less elevation is needed than when shooting on the level. The steeper the hill the less elevation is needed, so that when firing vertically up or down no elevation at all is needed, no matter how distant the target. Slight slopes that may be found on target ranges have no appreciable effect upon the elevation used and require no correction.

i. Sight-setting and sight-changing exercises.—In these exercises the instructor uses the full-sized A, B, and D targets, with spotters to indicate the position of the hits.

(1) *Procedure.*—The instructor assembles his squad or group, each pupil having his rifle, score book, and pencil, and conducts the exercise as follows:

(a) Points out the windage knob and the wind gage and explains that each line or division on the wind gage represents one point of windage or four clicks on the windage knob.

(b) Points out the graduations on the elevating knob and explains that the numbered line represents that range in 100 yards and the unnumbered line between the even-numbered lines represents the odd-numbered range in 100 yards, i. e., the line between 2 and 4 represents the 300-yard range.

(c) Explains the effect of wind and cautions the class to disregard all atmospheric influences except wind.

(d) Explains the wind-gage diagram in the score book.

(e) Reads over and explains the wind rule, wind-gage rule, and the elevation rule. By asking questions he assures himself that these rules are understood.

(f) Explains the vertical lines on the model targets in the score book and assures himself that each man understands the use of this diagram.

(g) Shows the pupils how to draw the windage lines for each range on the blank targets of the score book upon which they are to plot their shots during range firing.

(h) The above points having been explained to the assembled group, the pupils are placed in pairs. The instructor tests the ability of the members of the class to set the sights for the first shot by use of the wind rule or the wind-gage diagram. Every time the sights are set each pupil examines the sight of the pupil paired with him and tells the instructor, when called upon, the sight setting used.

(i) Instructor tests ability to change sights intelligently after first shot by referring to the model target.

(2) *Examples of sight-setting exercises.*

(a) "You are at 500 yards and estimate the wind to be 10 miles at 3 o'clock; set your sights for the first shot. Jones, what does Smith's sight read? Robinson, what should the sight read? Each man whose teammate did not set his sight at $1\frac{1}{4}$ points or 5 clicks right windage hold up his hand." The instructor, by questions and explanations, assists the men who have made mistakes.

(b) "You are at 600 yards and estimate the wind to be 10 miles at 9 o'clock; set your sights for the first shot. Suppose you fired and the spotter marked the hit here (placing a spotter in the 4 space near the bull's-eye, at 3 o'clock), and you were sure your hold and trigger squeeze were good; change your sights to bring the next shot into the center of

the bull's-eye. Johnson, what does William's sight read? Snider, what should the sight read? Each man whose teammate did not have his sight set at 2 points or 8 clicks left windage hold up his hand." The instructor assists those men who have made decided errors. Differences of less than $\frac{1}{4}$ point or 1 click are matters of opinion in applying the rules and are unimportant.

(3) *Windage and elevation.*—(a) The instructor gives a number of examples with the wind at different angles and velocities and at the various ranges until the class thoroughly understands the use of the wind gage.

(b) Following the instruction in the use of the wind gage, the instructor puts the class through similar exercises which require changes in elevation.

(c) The instructor gives a number of examples which require changes in both windage and elevation until the principles of sight changing are well understood by the class.

(d) Assume the zero of the rifles to be away from the normal both as to windage and elevation and repeat the exercises.

(4) *Examples of other sight-setting exercises.*

(a) "Set your sight at 600 yards plus 1 click with $1\frac{1}{2}$ points, or 6 clicks, of left windage. Suppose you fire four shots hitting here (place four spotters in the bull's-eye), and your fifth shot goes here (place spotter on 3 space at 11 o'clock). Jones, what are you going to do now? Jenkins, what are you going to do? You should not do anything to the sight. It is practically certain that you squeezed the trigger improperly and flinched. Not even a very sudden and violent change in the weather or light could cause nearly that much of a difference. Don't try to correct your own faults by changing the sights around.

(b) "For your first score in rapid fire at 200 yards you have set your sight at the same elevation and windage that you used in slow fire. Suppose this to be 200 yards in elevation and zero windage and your group goes here (putting 8 spotters low and to the left). Set your sight to bring the next score into the figure. Miller, what does Wright's sight read?"

(5) *Variations in sight settings.*—A group in rapid fire should strike the same place as in slow fire. Rapid-fire

groups that vary in position from slow-fire groups are due to imperfect trigger squeeze in rapid fire, and consequently these groups are more scattered. Men should endeavor to squeeze the trigger so that the rapid-fire sight settings will be the same. But if there is a constant variation in the two sight settings, each man should note it in his score book and set his sight in rapid fire so as to make the groups count as much as possible. Groups that are scattered all over the target cannot be corrected by changing the sight.

j. Use of score book.—(1) Each man must keep a score book in which he records not only the value of the hits but the location of each hit, the sight setting and sight changes, the force and direction of wind, the kind of light, the hour, the date, and such other data as may be of use in the future. Spaces for these notes are provided on the score sheets of the score book.

(2) The use of the score book on the range is important for the following reasons:

(a) The plotting of the shots shows the firer the location of his group.

(b) The wind-gage diagram indicates the windage to take for the first shot. The model target shows by means of vertical lines the change in windage necessary to place the group in the center of the target. By reference to model "dimensions to scale of A, B, and D targets" on page 16, W. D., A. G. O. Form No. 82 (Individual Score Book), and applying the elevation rule, the change in elevation necessary to place the group in the center of the target may be computed.

(c) Plotting the shots and recording the data as to light and wind help the soldier to learn the zero of his rifle.

(d) The data written down as to sight settings and weather conditions while firing at any range are of great assistance in setting the sight correctly when again firing at that range. Where a number of scores have been fired and recorded, the firer should get his sight settings from previous scores fired on days that were similar as to light and wind.

(3) The score book will be kept personally by the man firing. The coach assists him when necessary to decide what to write down, but the coach will neither plot the shots nor enter any data.

k. Score-book exercises.—The squad or larger group is assembled in front of a full-sized B target, each man with score book, pencil, and rifle. The class is divided into pairs. Each man acts as coach for the other man of his pair.

(1) The instructor states the light and weather conditions and the range. He then indicates 8 successive shots on the target by means of a spotter and requires each man to plot each shot as it is indicated, write down the data given from time to time, and make the actual sight settings and corrections on his rifle. Weather and light conditions assumed by the instructor and changes announced during the exercise should be such as are likely to occur on the rifle range.

(2) The pupils are told by the instructor to open their score books at the first blank page and plot the shots and write in the data as given to them. They are further instructed to write lightly so that erasures may be made, allowing the same page to be reused. The example as given will be substantially as follows:

(a) "You are at 600 yards on the rifle range. You are getting ready to fire a slow-fire score. There is bright sunlight. The wind varies from 8 to 12 miles an hour in velocity and from 1 to 3 o'clock in direction. When you are in position ready to fire the first shot, the wind seems steady at 3 o'clock and blowing about 8 miles an hour. Write in your data and set your sights. Jones, where has Robinson set his sight? Williams, where has Smith set his sight? You should have $1\frac{1}{4}$ points, or 5 clicks, of right windage.

(b) "You fire your first shot and the spotter marks it here (put spotter a close 4 at 7 o'clock). Decide what you are going to do and set your sights. Dodd, what does McLean's sight read? You should have moved your sight about $\frac{1}{4}$ point, or one click, to the right and increased your elevation one click.

(c) "Your second shot goes here (spotter near center of bull's-eye); your third shot goes here (spotter in bull's-eye near the top); your fourth shot goes here (spotter in bull's-eye near the bottom); your fifth shot goes here (close 4 at 9 o'clock). The wind seems to be a little stronger, but you are not sure. Your hold was all right. Johnson, what are you going to do? I would take half the correction called for

by the model target. Set your sight accordingly. You should have about $1\frac{3}{4}$ points, or 7 clicks, of right windage now. Your sixth shot goes here (a bull's-eye near the edge at 3 o'clock). Malone, what are you going to do? The four on the fifth shot must have been due to an error in aim or trigger squeeze, so put your sight back to where it was before ($1\frac{1}{2}$ points or 6 clicks).

(d) "Before you fire your seventh shot you notice that the wind has shifted to about 1 o'clock but still blowing the same rate. Wilson, where has Simpson set his sight now? Billings, what does the book say about a 1 o'clock wind? You need almost half as much windage as for a 3 o'clock wind. You should now have $\frac{3}{4}$ point or 3 clicks of right windage. Set your sight there.

(e) "Your next shot goes here (a wide 4 at 6 o'clock). Collins, what correction has Brown made for his eighth shot? You should have made no change in your sight. Your windage is apparently correct and there has been no change in the conditions. Your low shot was due to a poor aim or a poor trigger squeeze. Do not try to correct your personal errors by moving your sight around. Your eighth and last shot goes here (bull's-eye). Write in your notes and exchange books with your teammate. Smith, has Williams plotted all the shots correctly? Read the notes he has written in his book."

(3) The instructor corrects errors and mistaken ideas and makes a note of the pupils needing additional instruction.

■ 62. SIXTH STEP: EXAMINATION OF MEN BEFORE STARTING RANGE PRACTICE.—(The answers given herein are merely examples. Men should be required to explain them in their own words.)

Q. What is this (drawing a circle on the ground or on paper)?—A. A circle.

Q. Where is the center of it?—A. Here (pointing to the center).

Q. Suppose that circle represents a peep sight through which you are looking and that you are told to bring the top of the front sight to the center of it; where would the top of the front sight be?—A. Here (pointing to the center of the circle).

Q. Make a mark in the circle to represent the front sight. Make a small circle to represent the bull's-eye. Is the bull's-eye in the center of the peep sight?—A. No; the bottom edge of it is in the center.

Q. Why?—A. Because the top of the front sight is in the center and just touches the bottom edge of the bull's-eye.

Q. Should the front sight be held up into the bottom of the bull's-eye?—A. No; it just touches the bottom edge of the bull's-eye, so that all of the bull's-eye can still be clearly seen.

Q. What is this (indicating sighting bar)?—A. Sighting bar.

Q. What is it for?—A. To teach me how to aim.

Q. Why is it better than a rifle for this purpose?—A. Because the sights on it are much larger, and slight errors can be more easily seen and pointed out.

Q. What does this represent?—A. The front sight.

Q. And this?—A. The rear sight.

Q. What is this?—A. The eyepiece.

Q. What is the eyepiece for?—A. To cause me to place my eye in such a position as to see the sights in the same alignment as that set by the coach.

Q. Is there any eyepiece on the rifle?—A. No; I learn by the sighting bar how the sights look when properly aligned, and I must hold my head so as to see the sights the same way when aiming a rifle.

Q. How do you hold your head steadily in this position when aiming a rifle?—A. By resting my cheek firmly against the side of the stock.

Q. Where do you focus your eye when aiming a rifle?—A. On the bull's-eye.

Q. Tell me what is wrong with these sights. (The instructor now adjusts the sights of the bar, making various slight errors—first, to show the correct and incorrect adjustments of the sights; and then with the sights properly adjusted he sights on the small bull's-eye to demonstrate correct and incorrect adjustments, requiring the men to point out any errors.)

Q. Now take this sighting bar and adjust the sights properly. (Verified by the instructor.)

Q. Now that the sights are properly adjusted, have the small bull's-eye moved until the sights are properly aimed at it.

Q. How do you breathe while aiming?—A. After I get my sights lined up on the bull's-eye, I draw in a little more than an ordinary breath and let out a little, and hold the remainder while aiming and squeezing the trigger.

Q. Take the prone position, aim and simulate firing a shot at that mark. (The instructor must assure himself that the man knows how to hold his breath properly while aiming. Many men have great difficulty in learning to do this correctly.)

Q. What is this?—A. An aiming device.

Q. What is it used for?—A. To show the instructor how a man is aiming.

Q. Now I will take this rifle, and with the aid of the sandbag rest to hold the rifle steady I will aim at the bull's-eye, and you will watch the sights through the aiming device and tell me when my aim is right and when it is wrong, and what the error is when wrong. (The instructor now aims so as to illustrate the common faults, and the man must observe and call attention to them.)

Q. I will now simulate firing at a bull's-eye a few times and you will watch through the aiming device and call where the shots would have hit.

Q. Now take this rifle and using the sandbag rest aim at the bull's-eye, and I will watch you through the aiming device. (The instructor satisfies himself that the man understands sighting and aiming, and requires him to simulate firing a few times and to call his shots.)

Q. I will take the rifle and assume the kneeling, sitting, and prone positions, and position with sandbag rest, and you will tell me whether the position is correct or incorrect in each case. (The gun sling is adjusted in all these tests.)

Q. Take this rifle and show me your kneeling, sitting, and prone positions, and prone position with sandbag rest.

Q. Now show me how you take the sitting and prone positions rapidly from standing position.

Q. How do you squeeze the trigger?—A. I squeeze the trigger with such a steady increase of pressure that I do not know just when the rifle will go off.

Q. What do you know while you are squeezing the trigger?—A. I know that the sights are lined upon the bull's-eye.

Q. If the sights are slightly out of alinement, what do you do?—A. I hold the pressure I have on the trigger and only resume the increase of pressure when the sights become lined upon the bull's-eye again.

Q. If you do this, can your shot be a bad one?—A. No.

Q. Why?—A. Because I cannot flinch, for I do not know when to flinch, and the sights will always be lined up with the bull's-eye, when the rifle goes off, because I never increase the pressure on the trigger, except when they are properly lined up.

Q. Is it necessary to take a long time to press the trigger in this way?—A. No. The method of squeezing the trigger is slow at first but rapidity is developed by practice.

Q. How do you squeeze the trigger in rapid fire?—A. I squeeze it the same way as in slow fire, with such a steady increase of pressure as not to know when the rifle will fire.

Q. In rapid fire how do you gain time so as not to be compelled to hurry in aiming and squeezing the trigger?—A. I gain time by taking the position rapidly and by keeping my eye on the target.

Q. How does keeping your eye on the target help you to gain time?—A. A man who looks away from his target loses time in finding his own target again.

Q. Now, show me how you load a clip of service ammunition into the receiver.

Q. Is it important to get into the correct position before beginning to shoot in rapid fire?—A. Yes; even though it takes more time, I should always get into the correct position before beginning to shoot.

Q. What is meant by *calling the shot*?—A. To say where you think the bullet hit as soon as you shoot and before the shot is marked.

Q. How can you do this?—A. By noticing exactly where the sights point when the rifle goes off.

Q. If a man cannot call his shot properly, what does it usually indicate?—A. That he did not squeeze the trigger properly and did not know where the sights pointed at the time the rifle went off.

Q. What is this?—A. A score book.

Q. What are these lines for (indicating the vertical lines on the model target)?—A. To show the amount of change in windage necessary to bring the shot to the middle line.

Q. If a shot hits here (indicating), what change in your sight would you make to bring the next shot to the center of the bull's-eye?

Q. What effect does moving your rear sight have on the shot?—A. It moves it in the same direction as the rear sight moves.

Q. If you want to make a shot hit higher, what do you do?—A. I increase my elevation.

Q. If you want to make your shots hit more to the right, what do you do?—A. I move my rear sight to the right.

Q. If you move your rear sight 1 point or 4 clicks, of windage, how much will it move the point struck by the bullet?—A. Four inches for each 100 yards of range.

Q. Explain what you mean by that.

Q. I will place this spotter on this target (full size 500-yard target) to represent a shot properly fired by you at 500 yards with zero windage and sight set at 500 yards. Take your rifle and move your sight to bring the next shot to the center of the bull's-eye. (Instructor now tests in various ways the man's ability to make proper sight corrections.)

Q. What are the three principal uses of the score book?—A. To show me where my shot group is located, to indicate how much change in the sight is necessary to move a shot or group of shots to the center of the target, and to make a record of the sight settings of my rifle for the different ranges under various weather conditions so that I will know where to set my sight when starting to shoot at each range under different weather conditions.

Q. Tell me what effect different light and weather conditions have on a man's shooting.

Q. In firing at ranges up to and including 600 yards, what is the only weather condition for which you make sight corrections?—A. Wind.

Q. What three things do you do in cleaning the bore of a rifle after it has been fired?—A. I first remove the powder fouling from the bore. I then dry the bore thoroughly of the liquid used in removing the fouling. After this is done I oil the bore to protect it from rust.

Q. How do you remove the powder fouling from the bore?—A. By swabbing it thoroughly with cleaning patches saturated with water.

Q. How do you dry the bore?—A. By running clean patches through the bore until it is thoroughly dry.

Q. How do you protect the bore from rust?—A. By swabbing it thoroughly with a cleaning patch saturated with oil.

SECTION III

QUALIFICATION COURSES

■ 63. GENERAL.—*a.* See AR 775-10 for information as to who will fire the several courses, individual classification, qualification, ammunition allowances, etc.

b. The amount of instruction practice is not limited to that prescribed in the following tables. Such additional practice as time and ammunition allowance permit may be given.

■ 64. COURSE A.—*a.* *Instruction practice.*

TABLE I.—*Slow fire*

Range (inches)	Time	Shots	Target	Position	Sling
1,000	No limit...	4	A 1,000-inch....	Prone. Sandbag optional.	Loop.
1,000	...do.....	4	...do.....	Prone.....	Do.
1,000	...do.....	4	...do.....	Sitting.....	Loop or hasty.
1,000	...do.....	4	...do.....	Kneeling.....	Do.
1,000	...do.....	4	...do.....	Standing.....	Hasty.

TABLE II.—*Rapid fire*

Range (inches)	Time (seconds)	Shots	Target	Position	Sling
1,000	30-----	8	D 1,000-inch-----	Prone from standing-----	Loop.
1,000	30-----	8	do-----	Sitting or kneeling from standing.	Loop or hasty.

TABLE III.—*Slow fire*

Range (yards)	Time	Shots	Target	Position	Sling
200	No limit..	4	A-----	Prone. Sandbag optional.	Loop.
300	do-----	4	A-----	do-----	Do.
500	do-----	4	B-----	do-----	Do.

TABLE IV.—*Slow fire*

Range (yards)	Time	Shots	Target	Position	Sling
200	No limit..	4	A-----	Prone-----	Loop.
300	do-----	4	A-----	do-----	Do.
500	do-----	8	B-----	do-----	Do.

TABLE V.—*Slow fire*

Range (yards)	Time	Shots	Target	Position	Sling
200	No limit..	4	A-----	Sitting-----	Loop or hasty.
200	do-----	4	-----	Kneeling-----	Do.
200	do-----	4	-----	Standing-----	Hasty.

TABLE VI.—*Rapid fire*

Range (yards)	Time (seconds)	Shots	Target	Position	Sling
200	60.....	16	D.....	Kneeling from standing....	Loop or hasty.
300	65.....	16	D.....	Prone from standing.....	Loop.

TABLE VII.—*Rapid fire*

Range (yards)	Time (seconds)	Shots	Target	Position	Sling
200	60.....	16	D.....	Sitting from standing....	Loop or hasty.
300	65.....	16	D.....	Prone from standing.....	Loop.

*b. Record practice.*TABLE VIII.—*Slow fire*

Range (yards)	Time	Shots	Target	Position	Sling
200	No limit..	4	A.....	Standing.....	Hasty.
200	..do.....	4	A.....	Sitting.....	Loop or hasty.
200	..do.....	4	Kneeling.....	Do.
500	..do.....	8	B.....	Prone.....	Loop.

TABLE IX.—*Rapid fire*

Range (yards)	Time (seconds)	Shots	Target	Position	Sling
300	60.....	16	D.....	Sitting from standing....	Loop or hasty.

64-65

U. S. RIFLE, CALIBER .30, M1

TABLE X.—*Rapid fire*

Range (yards)	Time (seconds)	Shots	Target	Position	Sling
200	60.....	16	D.....	Kneeling from standing.....	Loop or hasty.
300	65.....	16	D.....	Prone from standing.....	Loop.

■ 65. COURSE B.—*a. Instruction practice.*TABLE I.—*Slow fire*

Range (inches)	Time	Shots	Target	Position	Sling
1,000	No limit..	4	A, 1,000-inch....	Prone. Sandbag optional.	Loop.
1,000	do.....	4	do.....	Prone.....	Do.
1,000	do.....	4	do.....	Sitting.....	Loop or hasty.
1,000	do.....	4	do.....	Kneeling.....	Do.
1,000	do.....	4	do.....	Standing.....	Hasty.

TABLE II.—*Rapid fire*

Range (inches)	Time (seconds)	Shots	Target	Position	Sling
1,000	30.....	8	D, 1,000-inch....	Prone from standing.....	Loop.
1,000	30.....	8	do.....	Sitting from standing.....	Loop or hasty.

TABLE III.—*Slow fire*

Range (yards)	Time	Shots	Target	Position	Sling
200	No limit..	4	A.....	Prone. Sandbag optional.	Loop.
300	do.....	4	A.....	do.....	Do.

TABLE IV.—*Slow fire*

Range (yards)	Time	Shots	Target	Position	Sling
300	No limit	4	A.....	Sitting.....	Loop or hasty.
300	do.....	4	A.....	Kneeling.....	Do.
200	do.....	4	A.....	Standing.....	Hasty.

TABLE V.—*Rapid fire*

Range (yards)	Time (seconds)	Shots	Target	Position	Sling
200	60.....	16	D.....	Kneeling from standing..	Loop or hasty.
300	65.....	16	D.....	Prone from standing.....	Loop.

TABLE VI.—*Rapid fire*

Range (yards)	Time (seconds)	Shots	Target	Position	Sling
200	60.....	16	D.....	Sitting from standing....	Loop or hasty.
300	65.....	16	D.....	Prone from standing.....	Loop.

*b. Record practice.*TABLE VII.—*Slow fire*

Range (yards)	Time (seconds)	Shots	Target	Position	Sling
200	No limit	4	A.....	Standing.....	Hasty.
200	do.....	4	A.....	Sitting.....	Loop or hasty.
200	do.....	4	A.....	Kneeling.....	Do.

65-66

U. S. RIFLE, CALIBER .30, M1

TABLE VIII.—*Rapid fire*

Range (yards)	Time (seconds)	Shots	Target	Position	Sling
200	60-----	16	D-----	Sitting from standing---	Loop or hasty.
300	60-----	16	D-----	Kneeling from standing.	Do.

TABLE IX.—*Rapid fire*

Range (yards)	Time (seconds)	Shots	Target	Position	Sling
300	65-----	16	D-----	Prone from standing-----	Loop.

■ 66. COURSE C.—*a. Instruction practice.*

TABLE I.—*Slow fire*

Range (inches)	Time	Shots	Target	Position	Sling
1,000---	No limit--	4	A 1,000-inch-----	Prone, sandbag optional--	Loop.
1,000---	do-----	4	do-----	Prone-----	Do.
1,000---	do-----	4	do-----	Sitting-----	Loop or hasty.
1,000---	do-----	4	do-----	Kneeling-----	Do.
1,000---	do-----	4	do-----	Standing-----	Hasty.

TABLE II.—*Rapid fire*

Range (inches)	Time (seconds)	Shots	Target	Position	Sling
1,000---	30-----	8	D 1,000-inch---	Prone from standing-----	Loop.
1,000---	30-----	8	do-----	Sitting or kneeling from standing.	Loop or hasty.

U. S. RIFLE, CALIBER .30, M1

66

TABLE III.—*Slow fire*

Range (yards)	Time	Shots	Target	Position	Sling
200	No limit	4	A	Prone. Sandbag optional	Loop.
200	do	4	A	Prone	Do.
200	do	4	A	Sitting	Loop or hasty.
200	do	4	A	Kneeling	Do.
200	do	4	A	Standing	Hasty.

TABLE IV.—*Rapid fire*

Range (yards)	Time (seconds)	Shots	Target	Position	Sling
200	60	16	D	Kneeling from standing	Loop or hasty.
200	55	16	D	Prone from standing	Loop.

*b. Record practice.*TABLE V.—*Slow fire*

Range (yards)	Time	Shots	Target	Position	Sling
200	No limit	4	A	Sitting	Loop or hasty.
200	do	4	A	Kneeling	Do.
200	do	4	A	Standing	Hasty.

TABLE VI.—*Rapid fire*

Range (yards)	Time (seconds)	Shots	Target	Position	Sling
200	60	16	D	Kneeling from standing	Loop or hasty.
200	55	16	D	Prone from standing	Loop.

■ 67. COURSE D.—*a. Instruction practice.*TABLE I.—*Slow fire*

Range (inches)	Time	Shots	Target	Position	Sling
1,000	No limit	8	A 1,000-inch	Prone. Sandbag optional.	Loop.
1,000	do	8	do	Prone	Do.
1,000	do	8	do	Sitting	Loop or hasty.
1,000	do	8	do	Kneeling	Do.
1,000	do	8	do	Standing	Hasty.

TABLE II.—*Rapid fire*

Range (inches)	Time (seconds)	Shots	Target	Position	Sling
1,000	30	8	D 1,000-inch	Prone from standing	Loop.
1,000	30	8	do	Sitting from standing	Loop or hasty.
1,000	30	8	do	Kneeling from standing	Loop.

*b. Record practice.*TABLE III.—*Slow fire*

Range (inches)	Time	Shots	Target	Position	Sling
1,000	No limit	4	A 1,000-inch	Kneeling	Loop or hasty.
1,000	do	4	do	Standing	Hasty.
1,000	do	4	do	Sitting	Loop or hasty.

TABLE IV.—*Rapid fire*

Range (inches)	Time (seconds)	Shots	Target	Position	Sling
1,000	30	8	D 1,000-inch	Sitting from standing	Loop or hasty.
1,000	30	8	do	Prone from standing	Loop.

SECTION IV

RANGE PRACTICE

■ 68. GENERAL.—*a. Phases.*—Range practice is initiated immediately after completion of the preparatory training. Range practice is divided into two parts, instruction practice and record practice.

b. Sequence of practice.—The practice season opens with instruction practice. Each person will complete instruction practice before he proceeds with record practice. When record practice is once begun by an individual it is completed before any other practice is permitted by him. As a rule, record practice will not be fired by any rifleman on the same day that he fires any part of instruction practice. However, when the time allotted to range practice is very limited, the officer in charge of firing may authorize record firing on the same day. Instruction practice and record practice will not be conducted simultaneously except on ranges where the firing points are in echelon or where the two types of practice are conducted on different parts of the same range.

c. Range personnel.—(1) *Officer in charge of firing.*—An officer in charge of firing will be designated by the responsible commander. It is desirable that he be the senior officer of the largest organization occupying the range. The officer in charge of firing or his deputy will be present during all firing and will be in charge of the practice and safety precautions on the range.

(2) *Range officer.*—The range officer is appointed by the post commander and is responsible to the latter for maintaining and assigning ranges, designating danger zones, and closing roads leading into danger zones. The range officer

makes timely arrangements for material and labor to place the ranges in proper condition for range practice. He directs and supervises all necessary repairs to shelters, butts, targets, firing points, and telephone lines. He provides for the safety of the markers, and when necessary he provides range guards and instructs them in the methods to be used for the protection of life and property within the danger area. He assists the officer in charge of firing by using the means necessary to provide efficient service from the maintenance personnel of the ranges.

(3) *Range noncommissioned officer.*—A noncommissioned officer and such assistants as the post commander may deem necessary will be detailed permanently during the range practice season as assistant to the range officer. He is responsible to the range officer that the target-pit equipment is kept in a serviceable condition; that the desired targets are ready for use at the appointed time; and that all target and pit details are provided with the proper flags, marking disks, pasters, and spotters.

(4) *Pit details.*—Commanders of organizations firing will provide such detail of officers, noncommissioned officers, and privates as may be necessary to supervise, operate, mark, and score the targets used by their respective organizations.

d. Uniform.—The uniform to be worn during instruction practice and record practice will be prescribed by the commanding officer.

e. Pads.—Men should be required to wear pads on the shoulder and, if the ground is hard, on the elbows for the first 3 or 4 days at least. A pad can easily be improvised by putting a pair of woolen socks under the shirt so as to protect the shoulder and the upper muscles of the arm. After a few days of firing, the muscles become hardened so that the pads are not essential. (See par. 72 a(10).)

f. Cartridge belt.—The cartridge belt will be worn during instruction practice and record firing.

■ 69. *SAFETY PRECAUTIONS.*—*a.* Safety precautions for observance by troops are self-contained and complete in this manual. Reference to AR 750-10 is necessary for range officers, the officer in charge of firing, and the commander responsible for the location of ranges and the conduct of

firing thereon. All officers and men who are to fire or who are concerned with range practice will be familiarized with the safety precautions in *b* below before firing is commenced.

b. (1) Danger flags will be displayed at prominent positions on the range during firing. Do not fire unless such flags are displayed.

(2) Upon arrival at the range the rifles of an organization will be inspected by the officers to see that chambers and barrels are free from obstruction and that all bolts are opened.

(3) Consider every rifle to be loaded until it is examined and found to be unloaded. Never trust your memory as to its condition in this respect.

(4) When the bolt is closed, never point the rifle in any direction where an accidental discharge may cause harm.

(5) Firing will not begin on any range until the officer in charge of firing has ascertained that the range is clear and has given the commands LOAD and COMMENCE FIRING.

(6) At least one officer will be present at all firing.

(7) All rifles on the range except those in use on the firing line will be *clear* with bolts *open* at all times. (See par. 31.)

(8) No rifle will be removed from the firing line until an officer or specially selected noncommissioned officer has inspected it to see that it is clear and the bolt open.

(9) No person will be allowed in front of the firing line for any purpose until directed by an officer who has ordered all rifles to be cleared and ascertained that the order has been carried out.

(10) All firing will immediately cease and the safety of each rifle set in its rear position (or the rifles cleared if ordered) at the command CEASE FIRING.

(11) Cartridges will not be left chambered in hot barrels.

(12) All loading and unloading will be executed on the firing line with the muzzles directed toward the targets. Rifles will never be loaded in rear of the firing line.

(13) Care should be taken to avoid undue exposure of ammunition to the direct rays of the sun. This creates hazardous chamber pressures.

(14) Never grease or oil the ammunition or the walls of the rifle chamber.

(15) See that the ammunition is clean and dry. Examine all live *and all dummy cartridges*. Turn in all live or dummy cartridges with loose bullets or which appear to be otherwise defective.

(16) Never fire a rifle with any rust preventive compound, cleaning patch, dust, dirt, mud, snow, or other obstruction in the bore. To do so may burst the barrel.

(17) Before leaving the range, all rifles and belts will be inspected by an officer to see that they do not contain ammunition; and men in ranks will be questioned as to whether they have any ammunition in their possession.

(18) See AR 45-30 for regulations covering report of accident involving ordnance matériel.

■ 70. INSTRUCTION PRACTICE.—Instruction practice represents the application with service ammunition of the principles taught in the preparatory training. The instruction practice outlined for each course described in paragraphs 64 to 67, inclusive, is designed to serve as a guide only. Within authorized ammunition allowances the number of shots to be fired at each range is discretionary with the organization commander.

a. Zeroing the rifle.—Each rifle will be “zeroed” for the 1,000-inch range. Each rifle will also be “zeroed” for 200, 300, and 500 yards during the instruction practice provided for these ranges. Each man will keep a record of these zeroes in his score book.

(1) *For 1,000-inch range.*—(a) The target for the 1,000-inch range is so devised that when aim is accurately taken at 6 o'clock on a black bull's-eye, the center of a shot group should be in the center of the same bull's-eye.

(b) To zero the rifle for this target take a steady aim in the prone position at 6 o'clock on the black bull's-eye. The first shot is fired with a sight setting of 200 yards' elevation and zero windage. Corrections in elevation and windage to bring subsequent shots into the center of the black bull's-eye are set in clicks by the elevating and windage knobs. Such corrections are applied after every two or more shots under the direction of an instructor. If the visibility of the shot groups is limited, the instructor, after taking necessary safety precautions, may move along the line of targets and

announce the corrections to the coaches in terms of clicks. One click equals approximately $\frac{1}{4}$ inch on the target on the 1,000-inch range.

(2) *For known-distance ranges.*—The position of the spotters on the target will permit the necessary corrections in elevation and windage to be computed by the elevating and windage rules. They are then applied as clicks to the sight. These sight settings should be made under the supervision of an instructor or experienced coach after groups of two or more shots are fired.

(a) *At 200 yards.*

1. Set the elevation at 15 clicks up from the lowest elevation to which the elevating knob can be turned; set the windage at 0 in the normal manner. Fire a group of two or more shots and apply corrections in elevation and windage to bring the center of the next shot group or groups into the center of the black bull's-eye 5 inches above its bottom. Do not change the sight setting which obtains this result.
2. Being careful not to disturb the above sight setting, loosen the screw in the elevating knob with the screw-driver blade of the combination tool. Pull the elevating knob away from the receiver until its teeth are completely disengaged and then set the 200-yard mark on the drum exactly opposite the index line on the sight base.
3. Tighten the screw. The rifle now has its sight set exactly at 200 yards' elevation and is also correctly zeroed for 200 yards in elevation. Record the windage correction in the scorebook. Unless the rifle is subjected to especially hard usage, the sight setting of exactly 200 will in future be the zero elevation for that range. Minor adjustments in elevation to compensate for light on different days may be applied as clicks. These should be recorded in the scorebook.

(b) *At other ranges.*—Once the rifle has been zeroed for 200 yards as described in (a) above, it is easily zeroed for the other ranges as follows: Set the elevation at the desired range in the manner prescribed in paragraph 29. Set the windage

at 0. Fire a group of two or more shots. Then apply correction in clicks of elevation and windage to bring the center of the shot group into the center of the target. Record these corrections in the scorebook as the zero for that range.

b. Use of dummy cartridges.—The corrugated type of dummy cartridges (M1906) *only* may be used in range practice. When ammunition must be conserved, a proportion of the corrugated type dummies may be included in clips with live ammunition.

c. Slow fire.—The first few shots fired on the range by beginners should be slow fire from the prone position, following this, slow fire from other positions is conducted. The sandbag rest is used at the beginning of the course, not to teach steadiness of hold but to facilitate instruction in the proper method of squeezing the trigger. The sandbag assures such a steady hold that the temptation of the beginner to snap in his shot at the instant the sight touches or drifts past the bull's-eye, which is the cause of nearly all poor shooting, is eliminated. With the sandbag rest, the sights can be held fixed at the bottom of the bull's-eye while the firer squeezes the trigger with such a steady pressure as not to know exactly when the rifle will fire, which is the basis of all good shooting. The habit of the correct trigger squeeze having been acquired by firing with a sandbag rest will in all probability be retained while firing prone and in the more unsteady positions—sitting, kneeling, and standing.

d. Coaching.—(1) *General.*—During instruction practice the soldier works under the supervision of a coach. This does not mean that each man must have an experienced shot beside him. Any man of intelligence who has been properly instructed in the preparatory work and who has been given instruction in coaching methods can be used with good results and should be used when more experienced shots are not available. It is good practice to have expert coaches in charge of one or more targets, usually on a flank, to which particularly difficult pupils are sent for special coaching. Great patience should be exercised by the coach so as not to excite or confuse the firer.

(2) *Position of coach.*—On the firing line the coach should take a position similar to that of the man who is firing—prone,

sitting, kneeling, or standing—so as to be able to watch his trigger finger and his eye.

(3) *Watching the eye.*—Errors in trigger squeeze, which are the most serious and the hardest to correct, can be detected by watching the pupil's eye. If his eye can be seen to close as the rifle goes off, it is because he knew when it was going off and consequently was not squeezing the trigger properly. The explosion and the shock will cause a man to wink, but this wink cannot be seen, due to the sudden movement of the head that takes place at the same time. If the firer can be seen to wink it is because he winked first and jerked the trigger afterward.

(4) *Use of dummy cartridges in slow fire.*—If the pupil is seen to be flinching, or if he is doing poor or mediocre shoot-



FIGURE 32.—Position of the coach.

ing, the coach first checks his aim by the aiming device. Having assured himself that the pupil is aiming correctly, the coach has him turn his head aside while he, the coach, puts in a cartridge and shoves the bolt home. Occasionally the coach loads in a dummy cartridge instead of a live one without letting the pupil know what he has done. Then the flinch, indicated by the shoulder being shoved forward at the same time that the trigger is pressed, will be evident even to the firer himself. The coach then proves to him by squeezing the trigger a few times, as explained in (5) below, that his poor shooting is due to faulty trigger squeeze.

(5) *Coach squeezing the trigger.*—(a) To squeeze the trigger for the firer, the coach lies with his right elbow on the ground to steady his hand, places his thumb against the trigger and his first finger against the back of the trigger guard. In

this way he can apply pressure to the trigger by a pinching action of his thumb and first finger.

(b) The coach then watches the firer's back, and between 5 and 10 seconds after the firer begins to hold his breath he applies enough pressure to discharge the piece. Shots fired in this way are almost always accurately placed. After discharging the piece a few times, the coach lets the firer try a few shots alone to see if he can press the trigger the same way the coach pressed it so as not to know just when the rifle will go off. Sometimes it is necessary to repeat this exercise, but the majority of beginners can be permanently cured of the tendency to flinch by a few minutes of this kind of coaching. Old shots who are flinchers require more time and patience.

(6) *Duties of coach in slow fire.*—(a) The coach observes the pupil carefully and corrects all errors. He pays particular attention to see—

1. That the sights are blackened and that they are set at the correct range.
2. That the ammunition is free from dirt.
3. That the pupil has the correct position, gun sling properly adjusted, body at the proper angle, elbows correctly placed, and cheek resting firmly against the stock.
4. That the receiver is loaded with a clip in the correct manner.
5. That the slack is taken up promptly.
6. Whether or not the pupil flinches (by watching his eye).
7. That the pupil calls his shot each time he fires.
8. That the pupil keeps his score book correctly.
9. That the pupil is holding his breath properly (by watching his back occasionally).
10. That the aiming is correct (by watching through the aiming device occasionally).

(b) When necessary, the coach applies the coaching methods described in (4) and (5) above.

e. Rapid fire.—(1) During rapid fire the tendency to jerk the trigger is increased. This tendency must be corrected before it becomes a fixed habit. Before firing ball ammu-

dition it is advisable to have each order simulate a score of rapid fire using dummy cartridges.

(2) *The duties of the coach in rapid fire* are to observe the pupil carefully and correct all errors. He pays particular attention to see—

(a) That the sights are blackened and that they are set at the proper range.

(b) That the gun sling is properly adjusted.

(c) That the pupil assumes the correct position.

(d) That he takes up the slack promptly.

(e) Whether or not the pupil flinches (by watching his eye).

(f) That he reloads the receiver with a clip properly and quickly.

(3) These operations follow each other, and the coach can watch each in turn. The coach will also at times watch the pupil's back to see if he holds his breath while firing each shot.

(4) Any lack of smooth and proper timing in firing indicates that the preparatory training has not been sufficient, and additional preparatory rapid-fire practice will be given.

f. Exceptions to record practice procedure.—Procedure prescribed in paragraph 71 for record practice is applicable to instruction practice with the following exceptions:

(1) Scores are not required to be kept in the pits.

(2) Only such officers and noncommissioned officers are on duty in the pit as are necessary to preserve order and insure efficient pit service.

(3) The manner in which the scores are kept on the firing line is discretionary with the organization commander.

■ 71. RECORD PRACTICE.—*a. General.*—(1) The purpose of record practice is to test the soldier's skill as a rifleman and to determine his qualification. The qualification courses are prescribed in paragraphs 64 to 67, inclusive.

(2) The sequence in which the scores are fired in record practice is discretionary with the officer in charge of firing.

(3) Whenever practicable during record practice such officers as may be required for duty in the pit will be detailed from troops not firing.

b. Organization of firing line.—(1) The firing line will be organized so as to insure the safe and orderly conduct of the firing and to facilitate supervision by the officer in charge and his assistants. The distances specified in (2) below will be used as a guide for firing not involving skirmish runs, and may be modified at the discretion of the officer in charge of firing to meet local conditions and to provide for skirmish runs.

(2) (a) Scorers stationed in rear of the firing line and close to the soldier being scored.

(b) Telephone operators 5 yards in rear of the firing line.

(c) Ready line, i. e., next order on each target awaiting turn to fire, 10 yards in rear of the line of telephone operators.

(d) Rifle rests and cleaning rack 10 yards in rear of the starting line.

(3) Individuals who are to fire will be assigned targets and the order in which they will take turn in firing the several scores, i. e., 1st order, 2d order, etc.

c. Pit details.—The details for the supervision, operation, marking, and scoring of targets during record practice consist of officers, noncommissioned officers, and privates, as follows:

(1) One commissioned officer assigned to each two targets. When it is impracticable to detail one officer to each two targets in the pit, an officer will be assigned to supervise the marking and scoring of not to exceed four targets. In this case the pit scores will be kept by the noncommissioned officer in charge of each target who will sign the score card. The officer will take up and sign each score card as soon as a complete score is recorded.

(2) One noncommissioned officer assigned to each target to direct and supervise the markers. This noncommissioned officer will be selected from an organization other than the one firing on the target which he supervises. If this is not possible the officer assigned to the target will exercise special care to insure correct scoring.

(3) One or two privates assigned to operate and mark each target. These privates may be selected from the organization firing on the target to which they are assigned.

d. Score cards and scoring.—(1) Duplicate score cards will be kept, one at the firing point and one in the pit. These cards will be of different colors. The cards at the firing point will bear the date, the firer's name, the number of the target, and the order of firing. The pit card will not show the firer's name but will bear the date, the number of the target, and the order of firing.

(2) Entries on all score cards will be made in ink or with indelible pencil. No alteration or correction will be made on the card except by the organization commander, who will initial each alteration or correction made.

(3) The scores at each firing point will be kept by a non-commissioned officer of some organization other than that firing on the target to which he is assigned. If this is not possible company officers will exercise special care to insure correct scoring. As soon as a score is completed, the score card will be signed by the scorer, taken up and signed by the officer supervising the scoring, and turned over to the organization commander. Except when required for entering new scores on the range, score cards will be retained in the personal possession of the organization commander.

(4) In the pit the officer keeps the scores for the targets to which he is assigned. As soon as a score is completed he signs the score card. He turns these cards over to the organization commander at the end of the day's firing. The organization commander will check the pit records against the firing line records; in case of discrepancy between the two the pit record governs.

(5) Upon completion of record firing and after the qualification order is issued, the pit score cards of each man will be attached to his official score card kept at the firing point. These cards will be kept available for inspection among the company records for 1 year and then destroyed.

e. Marking.—(1) *Slow fire.*—(a) The value of the shot is indicated as follows:

1. A bull's-eye, with a white disk.
2. A four, with a red disk.
3. A three, with a black and white disk.
4. A two, with a black disk.

5. A miss, or a ricochet hit, by waving a red flag across the front of the target.

(b) The exact location of the hit is indicated by placing in the shot hole a spotter of size appropriate to the distance from the firing point. The center of the marking disk is placed over the spotter in signaling hits. No spotters are required on 1,000-inch ranges.

(2) *Rapid fire on target D.*—(a) The same disks are used to indicate the value of hits as in slow fire.

(b) Spotters are placed in the shot holes before the target is run up for marking.

(c) The marking begins with the hits of highest value, the center of the disk being placed over the spotter, then swung off the target and back again to the next spotter, care being taken each time to show only the face of the disk indicating the value of the shot being marked. The marking will be slow enough to avoid confusing the scorer at the firing point. When one spotter covers more than one shot hole, the disk is placed over it the required number of times. Misses and ricochet hits are indicated by slowly waving the red flag across the face of the target one time for each miss or ricochet hit.

f. Procedure.—(1) *Slow fire.*—(a) *On the firing line.*

1. One person only will be assigned to a target in each order.
2. The scorer, as the value of each shot is signaled, announces in a tone sufficiently loud to be heard by the firer the name of the firer, the number of the shot, and the value of the hit, and records the value of the hit on the score card of the individual who is firing.
3. Whenever a target is marked without the individual assigned to that target having fired, as will occur when someone fires on the wrong target, the scorer will notify the officer in charge, who will notify the officer assigned to that target in the pit to disregard the shot. This precaution is necessary to prevent errors in the pit record.
4. When an individual fires on the wrong target, he will not be scored a miss until the target to which

he is assigned has been pulled down and the miss signaled from the pit.

5. If the target is not half masked at the completion of a score on that target, or if it is half masked at the wrong time, the officer in charge of that firing point will adjust the matter at once over the telephone. This precaution is necessary to prevent the error from being carried on through the scores that follow.

(b) *In the pit.*

1. The target is withdrawn and marked after each shot, except that on 1,000-inch ranges the targets are marked and removed after each 4 or 8 shots and replaced with new targets.
2. When a shot is fired at a target it is pulled down. The noncommissioned officer makes a pencil mark across the shot hole and indicates the location of the hit to the officer. The officer announces its value and records it on the score card. A spotter is then placed in the shot hole. The previous shot hole, if any, is pasted, and the target is run up and marked. The noncommissioned officer supervises the marking of each shot. The officer also exercises general supervision over the marking.
3. When the pit score card indicates that a score has been completed, the target is half masked for about 30 seconds as a signal for such completion to the firing line. At the end of the 30 seconds the target is pulled fully down, the spotter removed, the shot hole pasted, and the target run up for the beginning of a new score.
4. When a target frame is used as a counterweight for a double sliding target, the blank side of such frame will be toward the firing line.

(2) *Rapid fire on target D.—(a) On the firing line.*

1. One person only will be assigned to a target in each order. The loop or hasty sling as required may be adjusted on the arm prior to the start of the exercise.

2. When all is ready in the pit, a red flag is displayed at the center target. At that signal the officer in charge of the firing line commands: **LOAD**. The rifles are locked and loaded.
3. The officer in charge of the firing line then calls so that all may hear, "Ready on the right? Ready on the left?" Anyone who is not ready calls out, "Not ready on No. —."
4. All being ready on the firing line, the officer in charge commands: **READY ON THE FIRING LINE**. Rifles are unlocked and the position of **READY** assumed. The telephone orderly notifies the pit, "Ready on the firing line."
5. The flag at the center target is waved and then withdrawn. Five seconds after the flag is withdrawn the targets appear, remain fully exposed for the prescribed period of time, and are then withdrawn. The firer takes the prescribed position as soon as the targets appear, and fires or attempts to fire 16 shots, reloading with a full clip taken from the belt. If any individual fails to fire at all, he will be given another opportunity to fire, but if he fires any shots the score must stand as his record. He will not be permitted to repeat his score on the claim that he was not ready. (See also par. 72a (21) and (23).)
6. As soon as the targets are withdrawn the officer in charge commands: **UNLOAD**. All unfired cartridges are removed from the rifle and the bolts are left open. The men remain in position on the firing line until they are ordered off by the officer in charge.
7. As each shot is signaled from the pits it is announced by the scorer at the firing line. A score of 16 shots is announced as follows as each shot is marked: "Target 22; 1 five, 2 fives, 3 fives, 4 fives, 5 fives, 6 fives, 7 fives; 1 four, 2 fours, 3 fours, 4 fours, 5 fours, 6 fours; 1 two, 2 twos; 1 miss." The scorer notes these values on a pad and watches the target as he calls the shot. After marking is finished he

counts the number of shots marked, and if it is more or less than 16 calls "Re-mark No. —." If 16 shots have been marked, he then enters the value of each hit and their total value on the soldier's score card.

(b) *In the pit.*

1. The time is regulated in the pit by the officer in charge.
2. When all is ready in the pit the targets are fully withdrawn and a red flag is displayed at the center target.
3. When the message is received that the firing line is ready, the red flag at the center target is waved and withdrawn and the command READY is given to the pit details.
4. Five seconds after the red flag is withdrawn, the targets are run up by command or signal, left fully exposed for the prescribed period of time, and then withdrawn.
5. The officers in the pit examine each of their targets in turn, announce the score, and record it on the pit score card. Spotters are then placed in the shot holes and the targets run up and marked. The noncommissioned officer supervises the marking of each shot. The officer exercises general supervision over the marking.
6. The targets are left up for about 1 minute after being marked and are then withdrawn, pasted, and made ready for another score. They may be left up until ordered pasted by the officer in charge of the firing line.
7. If more than 16 hits are found on any target it will not be marked unless all of the hits have the same value. The officer in charge of the firing line will be notified of the fact by telephone.

(3) *Rapid fire on target D (rifle) 1,000-inch range.—(a)*

When the 1,000-inch range has a target pit, proceed as follows: Rapid fire from standing position to prone, sitting, and kneeling will be conducted in the same manner as prescribed

for target **D**, except that the miniature targets will be removed and replaced with new targets after marking.

(b) When the 1,000-inch range has no target pit, the following will govern:

1. If the targets are covered by a curtain which can be opened to expose the face of the target and closed again to conceal it, or if the targets operate on a pivot, the rapid fire will be conducted as closely as practicable in conformity with the method in (a) above.
2. If the targets are exposed all the time, rapid fire from standing to prone, kneeling, and sitting will be conducted by the officer in charge, who commands: 1. **LIE DOWN (KNEEL OR SIT DOWN)**, 2. **COMMENCE FIRING**, 3. **CEASE FIRING**. Time is taken from the first command.
3. After the command **UNLOAD**, and when all unfired cartridges are removed from the rifle and the bolts are open, the officer in charge will direct the target detail to mark, remove, and replace the targets.

g. Use of telephones.—(1) Telephones will be used for official communications only.

(2) No one will ask over the telephone for information as to the name or organization of any person firing on any particular target, and no information of this nature will be transmitted.

(3) The following expressions will be used over the telephone in the cases enumerated:

(a) When a shot has been fired and the target has not been withdrawn from the firing position, "Mark No. —."

(b) When a shot has been fired and the target withdrawn from the firing position but not marked, "Disk No. —."

(c) When the target has been withdrawn from the firing position and marked, but the value of the shot has not been understood, "Redisk No. —."

(d) When the firing line is ready for rapid fire, "Ready on the firing line."

(e) When a shot is marked on a target and the person assigned thereto has not fired, "Disregard the last shot on No. —."

■ 72. RULES GOVERNING RECORD PRACTICE.—*a. Miscellaneous.*—(1) *Identity of firer to be unknown to personnel in pit.*—Officers and men in the pit should not know who is firing on any particular target, and will not attempt to obtain this information; likewise, other officers and men will not transmit such information to personnel in the pit.

(2) *Coaching prohibited.*—Coaching of any nature, after the firer takes his place on the firing point, is prohibited. No person will render or attempt to render the firer any assistance whatever while he is taking his position or after he has taken his position at the firing point. Each firer must observe the location of his own hits as indicated by the marking disk or spotters.

(3) *Use of instruments.*—(a) The use of field glasses, telescopes, and sight-setting instruments is authorized and encouraged.

(b) The use of instruments or devices for determining the force and direction of the wind is prohibited during record practice.

(4) *Shelter for firer.*—Sheds or shelter for the firer will not be permitted on any range.

(5) *Restrictions as to rifle.*—Troops will use the rifle with which they are armed. The rifle will be used as issued by the Ordnance Department. The use of additional appliances such as temporary shades for the sights, spirit levels, and orthoptic eyepieces is prohibited. The sights may be blackened. Small arms and appliances issued by the Ordnance Department for test and report will not be used for determining classification.

(6) *Trigger pull.*—The trigger pull will be at least 3 pounds and before record firing will be tested (with the barrel vertical) by an officer.

(7) *Ammunition.*—The ammunition used will be the service cartridge as issued by the Ordnance Department unless the use of other ammunition is authorized.

(8) *Cleaning.*—Cleaning will be permitted only between scores.

(9) *Use of gun sling.*—The gun sling will be used in connection with one arm only. For the purpose of adjustment for shooting, neither end will be removed from either sling swivel. No knot will be tied in the sling and the sling itself will neither be added to nor modified in any manner. The sling may be adjusted (secured) to the arm prior to the start of the exercise.

(10) *Pads and gloves.*—(a) Pads of moderate size and thickness may be worn on either shoulder, on both elbows, and on either upper arm. Pads of such size, thickness, or construction as to form artificial support for the rifle are prohibited. Shoulder pads so designed by means of excessive size or thickness, quilting, rolls, ridges, or other devices as to aid materially in retaining the rifle butt in the firing position against the shoulder are prohibited. The use of a hook, small roll, or ridge on the sleeve of the shooting coat or shirt to keep the sling in place on the arm is prohibited.

(b) A glove may be worn on either hand provided it is not used to form an artificial support for the rifle.

(11) *Loading pieces.*—Pieces will not be loaded except by command or until position for firing has been taken.

(12) *Warming or fouling shots.*—No warming or fouling shots will be allowed.

(13) *Action in case of disabled rifle.*—Should a breakage occur, the rifle will be repaired or a different rifle substituted. If a different rifle is substituted the firer will be allowed to zero the substituted rifle and then refire the exercise.

(14) *Shots cutting the edge of bull's-eye or line.*—Any shot cutting the edge of the figure or bull's-eye will be signaled and recorded as a hit in the figure or the bull's-eye. Because the limiting line of such division of the target is the outer edge of the line separating it from the exterior division, a shot touching this line will be signaled and recorded as a hit in the higher division.

(15) *Slow-fire score interrupted.*—If a slow-fire score is interrupted through no fault of the person firing, the unfired shots necessary to complete the score will be fired at the first opportunity thereafter. (See also (13) above.)

(16) *Misses.*—In all firing, before any miss is signaled, the target will be withdrawn from the firing position and care-

fully examined by an officer, if an officer is on duty in the pit. Whenever the target is run up and a miss is signaled, it will be presumed that this examination has been thoroughly made. No challenge of the value signaled will be entertained or resignaling of the shot allowed.

(17) *Accidental discharge.*—All shots fired by the soldier after he has taken his place at the firing point (and it is his turn to fire, the target being ready) will be considered in his score even if his piece was not directed toward the target or is accidentally discharged.

(18) *Firing on wrong targets.*—Shots fired upon the wrong target will be entered as a miss upon the score of the man firing, no matter what the value of the hit upon the wrong target may be. In rapid fire the soldier at fault is credited with only such hits as he may have made on his own target.

(19) *Two shots on same target.*—In slow fire, if two shots strike a target at the same time or nearly the same time both will be signaled; if one of these shots was fired from the firing point assigned to that target, the hit having the highest of the two values signaled will be entered on the soldier's score and no record made of the other hit.

(20) *Withdrawing target prematurely.*—In slow fire, if the target is withdrawn from the firing position just as the shot is fired, the scorer at that firing point will at once report the fact to the officer in charge of the scoring on that target. That officer will investigate to see if the case is as represented. Being satisfied that such is the case, he will direct that the shot be not considered and that the man fire another shot.

(21) *Stoppages in rapid fire.*—(a) In the event of a stoppage during rapid fire, the officer in charge of firing or one of his assistants will investigate the cause and will render all decisions on stoppages.

(b) If the stoppage is manifestly due to failure on the part of the firer, he will not be allowed to complete the exercise. In such case only that part of the exercise which was fired will be scored.

(c) When a stoppage occurs which was not the fault of the firer, time and ammunition permitting, the complete score will be refired. If sufficient time and ammunition are not available, the incompleting record target may be reex-

posed on a time basis of 3 seconds for each shot remaining to be fired. Five seconds for reloading a clip will be given. In no case will the soldier be given any information with reference to the location of his previous hits on the incompleting target until the score is completed.

(d) If during the firing of a rapid-fire score the rifle becomes disabled from causes other than a stoppage through no fault of the firer, the target will not be marked and the score refired.

(22) *Unfired cartridges in rapid fire.*—Each unfired cartridge will be recorded as a miss. In case the number of hits marked exceeds the number of rounds fired, the soldier firing on that target will be credited with the hits of highest value corresponding to the number of rounds fired.

(23) *More than 16 hits in rapid fire.*—When a target has more than 16 hits in rapid fire, the target will not be marked, and the soldier firing on that target will repeat his score; except when all the hits on target D or on target D (rifle) 1,000-inch range have the same value, the target will be marked and he will be given that value for each shot fired by him.

b. *For course D 1,000-inch range.*—The following special provisions apply only to record practice for course D which is fired on the 1,000-inch range:

(1) So much of the foregoing regulations for record practice (a above and par. 71) as can be applied will be followed. Procedure of firing on the type of 1,000-inch range which is equipped with pits and movable targets, as well as for firing on the type of 1,000-inch range which is not so equipped, will be found in paragraph 71f (4).

(2) When the record practice is fired on 1,000-inch ranges not equipped with pits and movable targets the following rules will apply:

(a) Sufficient assistants will be detailed from companies other than the ones firing to assist the officer in charge. From the assistants, officers will be detailed as scorers at the rate of one for every four targets.

(b) The officers detailed as assistants will aid the officer in charge in every way possible. They will—

1. Note deductions for penalties and report same to the scorer.

2. Note the time out for stoppages and inspect to determine whether the stoppage was due to any fault of the soldier.
 3. Superintend the firing of rounds remaining from stoppages not the fault of the firer.
- (c) *Assistants detailed as scorers will—*
1. Count the bullet holes in each target and report any that have more than the prescribed number.
 2. Score the targets in accordance with the provisions of (4) below.

(3) (a) When a stoppage occurs that cannot be cleared by pulling back the operating handle and releasing it, the firer will call, "Time." The officer in charge of firing or an assistant will note the time left to complete the exercise. The stoppage will be reduced. The firer will load and complete the firing on command from the officer in charge who will allow the remaining time. In cases where the exact time remaining was not determined by the officer in charge, the firer will be allowed 3 seconds per round for the remaining rounds.

(b) If the stoppage is manifestly the fault of the firer, no time will be allowed to complete the exercise and only that part of the exercise which was fired will be scored.

(c) Should a breakage occur, the gun will be repaired or a different rifle substituted. If a different rifle is substituted, the firer will be allowed to determine the zero of the substituted rifle. He will then complete the exercise.

(4) Target A (rifle) 1,000-inch range and target D (rifle) 1,000-inch range are scored in accordance with the requirements for record firing for targets A and D.

SECTION V

EQUIPMENT; KNOWN-DISTANCE TARGETS, RANGES, AND RANGE PRECAUTIONS

■ 73. EQUIPMENT.—*a. Preparatory marksmanship training.—*

(1) *General.*—The use during preparatory marksmanship training of complicated apparatus which cannot be readily improvised from materials at hand is prohibited. The simple apparatus described below is ample for all purposes.

(2) *For each four men.*

- 1 Sighting bar, complete.
- 1 rifle rest.
- 1 small sighting disk.
- 2 small aiming targets (targets A and D (rifle), 1,000-inch range, are suitable).
- 1 10-inch sighting disk.
- 1 small box, approximately the size of an ammunition box.
- 1 frame covered with blank paper for long-range shot groups.
- 2 sandbags.
- 1 pencil.
- 32 rounds corrugated type practice dummy cartridges.
- 4 score books (one per man).
- 1 form showing state of training (par. 55f).
- Material for blackening sights.

(3) *For general use.*

- 1 rapid-fire target with curtain for each three squads.
- 1 each A, B, and D targets on frames for scorebook exercises.

Cleaning and preserving materials.

(4) *Preparation.—(a) Sighting bar.*

1. Provide a bar of wood about 1 by 2 inches and 4½ feet long. Cut two thin slots 1 inch deep across the edge. Place one slot 5½ inches from the end and the other 26 inches from the same end of the bar (fig. 33 ②).
2. Make a front sight of thin metal ½ by 3 inches bent in the shape of an L and tack it to the edge of the bar between the two slots and ½ inch from the slot nearest the end (fig. 33 ④ (d) and (g)). Have the leg of the L project above the bar ½ to ¾ of an inch (fig. 33 ③).
3. Make an eyepiece from a piece of tin or zinc 3 by 7 inches (fig. 33 ④ (c), (f), and (h)). Cut along the dotted lines to form a shape shown in figure. Tack this eyepiece to the end of the bar farthest

from the slots so that the top of the eyepiece extends 1 inch above the top of the bar (fig. 33 ③). Make a round hole 0.03 inch in diameter in the middle of the eyepiece $\frac{1}{2}$ inch above the bar.

4. Make a peep rear sight of thin metal or cardboard 3 by 3 inches and cut a round hole $\frac{3}{4}$ inch in diameter in its center (fig. 33 ④ (b)).
5. Cut a piece of thin metal or cardboard 3 by 3 inches, painted white, and have a black bull's-eye $\frac{1}{2}$ inch in diameter painted or pasted on the center (fig. 33 ④ (a)).
6. Place two pieces of tin 1 inch wide and 3 inches long in each slot. Fold the loose ends away from each other and tack them to the sides of the bar (fig. 33 ③).
7. Blacken the eyepiece, the front sight, the rear sight, and the top of the bar.

(b) *Rifle rest.*—An empty ammunition box or any other well-made box of suitable size, with notches cut in the ends to fit the rifle closely, makes a good rifle rest. The rifle is placed in these notches with the trigger guard close to and outside of one end. The sling is loosened and pulled to one side. The box is half filled with earth or sand to make it more stationary.

(c) *Sighting disks.*—Sighting disks are of three sizes. The disk to be used at a distance of 50 feet is about 3 inches in diameter. The disk is made of tin or cardboard and mounted on a handle as shown in figure 34. The bull's-eye will be mounted on a background of clean white paper. The disks to be used at 200 and 500 yards are, respectively, 10 and 20 inches in diameter. These disks are painted black and mounted on white handles which are 4 or 5 feet long. All bull's-eyes will be black and circular and will have a hole in the center large enough to admit the point of a pencil.

b. *Range equipment.*—(1) *At firing point.*

Cleaning racks.

Scorers' tables.

Field glasses (one per target).

Score cards.

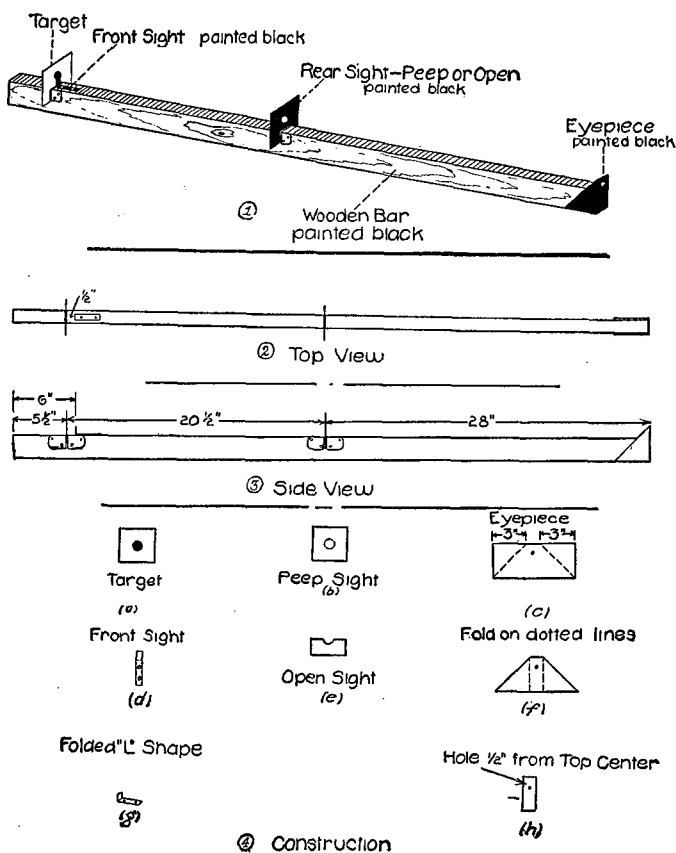

FIGURE 33.—Construction of sighting bar.

Wooden bar—1 by 2 inches by 4 feet 6 inches (approximate).

Eyepiece—Thin metal, 3 by 7 inches; hole, 0.03-inch diameter.

Rear sight—Thin metal or cardboard, 3 by 3 inches; hole in center, $\frac{3}{4}$ -inch diameter.

Front sight—Thin metal, $\frac{1}{2}$ by 3 inches, bent L shape.

Target—Thin metal or cardboard, 3 by 3 inches, painted white—Black bull's-eye, $\frac{3}{4}$ -inch diameter in center.

Slits—1 inch deep, may be lined with thin metal strips.

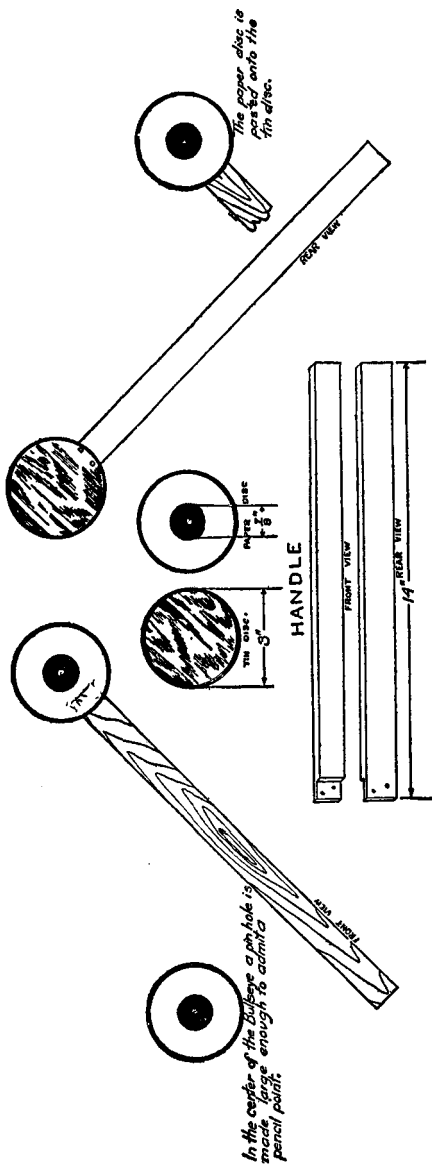

FIGURE 34.—Sighting disk.

Score board.

Cleaning and preserving materials.

Material for blackening sights.

Score books.

Indelible pencils.

Containers for empty cartridge cases.

Telephones.

(2) *In pit.*

Pit record cards.

Indelible pencils.

Telephones.

Ten 3-inch spotters per target.

One 6-inch spotter per target.

One red flag per target.

Marking disks.

Pasters.

Paste.

■ 74. TARGETS.—The specifications for marksmanship targets, together with the value of hits in their divisions, are as follows:

a. Target A, the short-range target, used for 200 and 300 yards, is a rectangle 6 feet high, 4 feet wide, black circular bull's-eye, 10 inches in diameter, value of hit, 5; center ring, 26 inches in diameter, value of hit, 4; inner ring, 46 inches in diameter, value of hit, 3; outer, remainder of target, value of hit, 2.

b. Target B, the midrange target, used for 500 yards, is a square 6 feet on a side, black circular bull's-eye, 20 inches in diameter; center ring, 37 inches in diameter; inner ring, 53 inches in diameter; outer, remainder of target. Value of hits, same as on target A.

c. Target D, the rapid-fire target, is a square 6 feet on a side and has in its middle a black silhouette representing a soldier in the prone position. Value of hits in the figure, 5; in the space immediately outside the figure, 4; in the space immediately outside the 4 space, 3; remainder of target, 2.

d. Target A (rifle) 1,000-inch range and target D (rifle) 1,000-inch range are a reduction of targets A and D, respectively, from 200 yards to 1,000 inches. Values of the

hits on the reduced targets are the same as for targets A and D.

■ 75. KNOWN-DISTANCE TARGET RANGES.—*a. General.*—There are two classes of ranges: class A ranges, which are more or less limited in extent and are equipped for known-distance practice; and class B ranges, which are of extended area and diversified terrain and are used for field targets. The following subparagraphs refer to class A ranges only.

b. Rules for selection.—As the nature and extent of the ground available for target practice and also the general climatic conditions are often widely dissimilar for different military posts, it is not possible to prescribe any particular rules governing the selection of ranges, but only to express certain general conditions to which ranges should be made to conform. In view of the range and penetration of the bullet of the United States rifle, caliber .30, it will be found necessary in the case of many posts to have target practice conducted at a distance of several miles from the post, a condition which necessitates the establishment of a camp on or near the range. The target practice can then be conducted without the interference of post duties.

c. Security necessary.—For posts situated in the thickly settled localities where the extent of the military reservation is limited, the first condition to be fulfilled is that of security for those living or laboring near or passing by the range. This requirement can be secured for class A ranges by selecting ground where a natural butt is available, or by making an artificial butt sufficiently extensive to stop wild shots. See paragraph 7*d*, AR 750-10, for information concerning danger areas.

d. Direction.—If possible, a range should be so located that the firing is toward or slightly to the east of north. Such location gives a good light on the face of the targets during the greater part of the day. However, security and suitable ground are more important than direction.

e. Ground.—Smooth, level ground or ground with only a very moderate slope is best adapted for a range. The targets should be on the same level with the firer or only slightly above him. Firing downhill should be avoided.

f. Size.—The size of the range is determined by its plan and by the number of troops that will fire over it at a time. There are two general plans used in range construction: one with a single target pit and firing points for each range; the other with firing points on one continuous line, the target pits for the various ranges being in echelon. The latter type requires more ground and is less suitable for training troops.

g. 1,000-inch range.—There are two classes of 1,000-inch ranges, those requiring a danger area behind the backstop and those which do not. Where possible, open 1,000-inch ranges requiring no danger area behind backstop for use in cities should be so sited that sparsely settled territory is behind the backstop and so located that the range will not be a noise nuisance; 1,000-inch ranges requiring a danger area behind backstop must meet the same security requirements as class A ranges.

h. Principles governing construction.—(1) *Intervals between targets.*—To reduce to a minimum the amount of labor required in preparing the range, the targets should be no farther apart than is necessary to obviate the probability of a shot being fired on the wrong target. As a general rule, the intervals between targets are equal to the width of the targets themselves; that is, at short and midrange, 6 feet; at long range, 12 feet. Where the necessity exists for as many targets as possible in a limited space, this interval may be reduced one-half without materially affecting the value of the instruction.

(2) *Protection for markers.*—(a) On all ranges, protection must be provided for the pit details. This is done by excavating a pit for the targets or by constructing a parapet in front of them, or by a combination of these methods.

(b) Where there are several targets in a row, the shelter should be continuous. It must be high enough to protect the markers. The parapet may be of earth, with a timber or concrete revetment, of sufficient thickness to stop bullets, and from 7½ to 8 feet high above the ground or platform on which the markers stand.

(3) *Artificial butts.*—If an artificial butt is constructed as a bullet stop, it should be of earth not less than 30 feet

high and with a slope of not less than 45°. It should be extended about 5 yards beyond the outside targets and should be placed as close behind the targets as possible. The slopes should be sodded.

(4) *Hills as butts.*—A natural hill to form an effective butt should have a slope of not less than 45°; if originally more gradual, it should be cut into steps, the face of each step having that slope. As a temporary expedient, the face of the hill may be plowed perpendicularly to the range, but as the bullets soon cut down the furrows this measure must be frequently repeated to prevent the danger of ricochet.

(5) *Numbering of targets.*—Each target should be designated by a number. The numbers for ranges up to 600 yards should be at least 6 feet in height and should be painted black on a white background. Arabic numerals of the size suggested will always be quickly recognized. They should be placed on the butt behind each target or on the parapet in front, and not so far above or below as to prevent the firer seeing the number when aiming at the target.

(6) *Measuring the range.*—The range should be carefully measured and marked with stakes at the firing points in front of each target. These stakes should be about 12 inches above the ground and painted white. They should have in black figures the number of the corresponding target and its distance. Particular care should be taken that each stake thus placed is parallel to the face of its own target.

(7) *Ranges parallel.*—The different ranges for the same distance should all be parallel so that similar conditions with respect to wind and light may exist. It is not essential, however, that the ranges employed for long-distance shooting should be parallel to those used for the ordinary company practice.

(8) *Firing mounds.*—If it becomes necessary to raise a firing point on account of low ground, a low mound of earth no higher than absolutely required should be made. The mound should be level, sodded, and not less than 12 feet square. If the entire firing line is raised, the firing mound should be level, sodded, and not less than 12 feet wide on top.

(9) *Pit shed.*—A small house or shed should be built in or near the target pit, in which the marking disks, signal flags,

and spare parts of the target frames for making immediate repairs should be stored. It should be sufficiently large to afford a shelter for the markers in case of a sudden storm.

(10) *Danger signals*.—A socket for the staff of the danger signals should be placed on the markers' shelter in front of each target, so inclined that the flag will always fall clear of the staff and be readily seen. This flag will always be displayed when the target is in place and not in use. In addition to the danger signals at the targets, a scarlet streamer will be displayed from a prominent point on all ranges and at all times during firing, to warn passers-by when firing is in progress. These signals will not be placed in such a position as to serve as streamers for judging wind on the range. They should be placed on the roads or on the crest of the hill where they can plainly be seen by those passing.

(11) *Range house*.—On large ranges where competitive firing is held, a house containing a storeroom and several office rooms should be erected in some central place off the range but in its immediate vicinity. Such facilities as will enable visitors to witness the firing satisfactorily should also be provided.

(12) *Telephone service*.—Ranges should be equipped with a telephone system connecting the target pit with each firing point, the range house, and the post. The number of telephones should not be less than one to each ten targets.

(13) *Electric bells*.—On large ranges the installation for each five targets of an electric bell that can be controlled from a central point in the pit adds materially to the celerity and uniformity of target manipulation for rapid fire.

(14) *Covered ways between pits*.—Where the pits are in echelon, covered ways or tunnels should be provided between the various pits. This construction will allow the pit details to be shifted with safety without interrupting the firing.

(15) *1,000-inch range*.—An open 1,000-inch range requiring no danger area behind backstop must meet the following minimum requirements:

(a) Vertical bulletproof backstop and wing walls (natural or artificial) not less than 30 feet high. Wing walls must cover at least 15° on each flank. In case of artificial wing

walls, they should be set at an angle of 15° with the backstop toward the firing points.

(b) Ricochet pit in front of firing points providing at least a 4° slope downward from the normal line of fire from a prone position and extending to within 30 feet of the backstop and wing walls. If a vertical cliff or wall over 40 feet high is available, no ricochet pit need be provided.

■ 76. RANGE PRECAUTIONS.—See AR 750-10.

SECTION VI

SMALL-BORE PRACTICE

■ 77. OBJECT.—The object of small-bore practice is to provide a form of marksmanship training with the caliber .22 rifle and ammunition which represents the application of the principles taught in the preparatory exercises. Small-bore practice provides an excellent means of improving the shooting of organizations and sustaining interest in marksmanship throughout the year. The firing of this course enables the company commander to visualize the state of training of his command and to concentrate his efforts on the training of those who are most deficient.

■ 78. VALUE.—The chief value of small-bore practice lies in the fact that it is convenient, interest sustaining, and economical. It does not have the full value of caliber .30 practice because of the absence of recoil, but on account of its convenience and saving in the cost of ammunition organization commanders will find that small-bore practice is a valuable step in marksmanship training.

■ 79. CONTINUOUS SMALL-BORE PRACTICE.—Small-bore practice may be carried on throughout the year, subject to such limitations as may be imposed by the allowance of ammunition. All persons who have never been properly instructed in shooting methods prescribed herein will be given a thorough course of preparatory instruction before being permitted to fire on the small-bore range. All small-bore practice will be properly organized and supervised in accordance with the methods of instruction as prescribed in this manual.

■ 80. COURSES.—*a.* When ammunition allowances, time, and available facilities permit, organizations may fire one of the small-bore courses outlined below:

(1) *Course E.*—(*a*) *Instruction practice.*

1. *Short range.*

TABLE I.—*Slow fire (to zero rifle)*

Range (feet)	Time	Shots	Targets	Position	Sling
50	No limit	5	SB-A-2	Prone or prone with sand-bag.	Loop.
50	do	5	SB-A-2	Sitting	Do.
50	do	5	SB-A-2	Kneeling	Do.
50	do	5	SB-A-2	Standing	Hasty.

TABLE II.—*Slow fire*

Range (feet)	Time	Shots	Targets	Position	Sling
50	No limit	10	SB-A-2	Standing	Hasty.
50	do	10	SB-A-3	5 kneeling; 5 sitting	Loop.
50	do	10	SB-B-5	Prone	Do.

TABLE III.—*Rapid fire*

Range (feet)	Time (seconds)	Shots	Targets	Position	Sling
50	60	10	SB-D-2	Standing to kneeling	Loop.
50	70	10	SB-D-3	Standing to prone	Do.

NOTE.—When desired, tables I, II, and III may be fired at 1,000 inches by substituting target A, 1,000-inch, for targets SB-A-2 and A-3; and target B, 1,000-inch, for target SB-B-5; and target D, 1,000-inch, for targets SB-D-2 and D-3.

2. *Intermediate range.*TABLE IV.—*Slow fire*

Range (yards)	Time	Shots	Targets	Position	Sling
50	No limit..	10	SB-50 yards, A target.	Prone.....	Loop.
50	do.....	10	do.....	5 kneeling; 5 sitting.....	Do.
50	do.....	10	SB-50 yards, D target.	Standing.....	Do.

TABLE V.—*Rapid fire*

Range (yards)	Time (seconds)	Shots	Targets	Position	Sling
50	65.....	10	SB-50 yards, D target.	Standing to prone.....	Loop.
50	70.....	10	do.....	Standing to sitting.....	Do.
50	70.....	10	do.....	Standing to kneeling.....	Do.

NOTE.—The firing included in tables IV and V is optional. If no 50-yard range is available, tables IV and V will be fired at 100 yards on the SB-100 yards D target. This note applies only to the E course.

3. *Long range.*TABLE VI.—*Slow fire*

Range (yards)	Time	Shots	Targets	Position	Sling
100	No limit..	10	SB-100 yards, A target.	Prone.....	Loop.
100	do.....	10	do.....	5 kneeling; 5 sitting.....	Do.
100	do.....	10	SB-100 yards, D target.	Prone.....	Do.

TABLE VII.—*Rapid fire*

Range (yards)	Time (seconds)	Shots	Targets	Position	Sling
100	80.....	10	Sb-100 yards, D target.	Standing to prone.....	Loop.
100	80.....	10	do.....	Standing to sitting.....	Do.

*(b) Record practice.*TABLE VIII.—*Slow fire*

Range (yards)	Time	Shots	Targets	Position	Sling
100	No limit..	10	SB-100 yards, A target.	Prone.....	Loop.
100	do.....	10	SB-200 yards, A target.	5 sitting, 5 kneeling.....	Do.

TABLE IX.—*Rapid fire*

Range (yards)	Time (seconds)	Shots	Targets	Position	Sling
100	80.....	10	SB-100 yards, D target.	Standing to prone.....	Loop.
100	80.....	10	do.....	Standing to sitting.....	Do.

(2) *Course F.—(a) Instruction practice—short range.—*Fire tables I, II, and III of course E.

TABLE X.—*Rapid fire*

Range (feet)	Time (seconds)	Shots	Targets	Position	Sling
50	65.....	10	SB-D-3.....	Standing to prone.....	Loop.
50	70.....	10	do.....	Standing to sitting.....	Do.

*(b) Record practice.*TABLE XI.—*Slow fire*

Range (feet)	Time	Shots	Targets	Position	Sling
50	No limit...	10	SB-A-3.....	Kneeling.....	Loop.
50	...do.....	10	SB-B-5.....	Prone.....	Do.

TABLE XII.—*Rapid fire*

Range (feet)	Time (seconds)	Shots	Targets	Position	Sling
50	65.....	10	SB-D-3.....	Standing to prone.....	Loop.
50	70.....	10	...do.....	Standing to sitting.....	Do.

b. Qualification scores for these courses, which are indicative of the proficiency attained, are as follows:

Course	Possible score	Expert	Sharp-shooter	Marks-man	Unqualified
E.....	200	180	160	130	Less than 130.
F.....	200	180	160	130	Less than 130.

CHAPTER 3

MARKSMANSHIP; MOVING GROUND TARGETS

	Paragraphs
SECTION I. General.....	81-82
II. Moving vehicles.....	83-85
III. Moving personnel.....	86-87
IV. Moving targets and ranges, and range precautions.....	88-89

SECTION I

GENERAL

■ 81. **EMPLOYMENT.**—Rifle units will be trained to fire at moving targets such as tanks, armored vehicles, trucks, and personnel at appropriate ranges. Rifle fire may be employed to repulse or harass unarmored vehicles and motorized troops. To this end rifle units must be trained in the technique of such fire.

■ 82. **FUNDAMENTALS.**—The fundamentals of shooting as presented in this chapter apply to firing at moving targets. In applying these fundamentals the firer must adjust his aim and trigger squeeze to conform to the movement of the target.

a. Effective range.—While under ideal conditions moving targets may be engaged at ranges above 600 yards, effective results beyond that range are considered to be exceptional. For this reason training in the technique of fire is normally limited to ranges of 600 yards or less.

b. Sights to be used.—Moving targets are seldom exposed for long periods and can be expected to move at maximum speed during periods of exposure. Accurate correction of sight setting is often impracticable, therefore instruction in technique should favor the use of the battle sight setting of 300 yards. Corrections for range are made by adjustment of the aiming point on the target.

c. Leads.—Targets which cross the line of sight at any angle are classified as crossing targets. In firing at such targets the firer must aim ahead of the target so that the paths of the target and bullet will meet. The distance ahead

of the target is called the "lead." Targets which approach directly towards the firer or recede directly from the firer will for all practical purposes require no lead.

SECTION II

MOVING VEHICLES

■ 83. DETERMINATION AND APPLICATION OF LEADS.—*a.* The lead necessary to hit a moving vehicle is dependent upon the speed of the target, the range to the target, and the direction of movement with respect to the line of sight. Moving at 10 miles an hour, a vehicle moves approximately its own length of 5 yards in 1 second. A rifle bullet moves 400 yards in about $\frac{1}{2}$ second and 600 yards in about 1 second. Therefore to hit a vehicle moving at 10 miles an hour at ranges of 400 yards and 600 yards, the leads should be $2\frac{1}{2}$ yards and 5 yards, respectively. At a speed of 20 miles an hour the leads should be 5 yards and 10 yards, respectively.

b. Leads are applied by using the length of the target as it appears to the firer as the unit of measure. This eliminates the necessity for corrections due to the angle at which the target crosses the line of sight, because the more acute the angle the smaller the target appears and the less lateral speed it attains.

c. The following lead table is furnished as a guide:

TARGET LENGTHS

Miles per hour	400 yards or less	400-600 yards
10	$\frac{1}{2}$	1
20	1	2

■ 84. TECHNIQUE OF FIRE.—The following technique is suggested for firing at rapidly moving targets, using battle sight setting of 300 yards.

a. Approaching or receding targets.—The firer holds his aim on the center of such target and squeezes off his shot.

b. Crossing targets.—(1) At ranges less than 500 yards, the firer alines his sights on the bottom of the target at

its rearmost point and swings straight across it to the estimated lead. The rifle is kept swinging and the shot squeezed off as the proper lead is reached.

(2) At ranges of 500 yards or more, the firer proceeds as in (1) above except that he swings his point of aim across the top of the target.

c. Fire is executed as rapidly as proper aiming will permit.

■ 85. PLACE IN TRAINING.—The technique of firing at moving vehicles with service ammunition properly follows individual training in known-distance firing. When time and ammunition allowances permit, 1,000-inch and caliber .22 firing may be added as preliminary instruction.

SECTION III

MOVING PERSONNEL

■ 86. TECHNIQUE.—*a. Sight to be used.*—Under field conditions, moving personnel presents a fleeting target and one more difficult to hit than a moving vehicle. This fact makes the use of an accurate sight setting desirable for greater accuracy. However, the use of battle sight setting of 300 yards may be necessary when targets appear suddenly, allowing no time for sight adjustment. It is therefore desirable that the individual rifleman be trained in the employment of both sights in this type of firing.

b. Method of aiming.—An elaborate system of calculating leads is neither necessary nor desirable. The following general rule forms the basis for estimating the proper leads. When firing at a man walking across or at right angles to the line of fire, the points of aiming at the various ranges are as follows:

- (1) At 100 yards, aim at forward half of body.
- (2) At 200 yards, aim at forward edge of body.
- (3) At 300 yards, lead him one-half the width of his body.
- (4) At 400 yards, lead him the width of his body.

Proficiency in this type of firing depends largely upon the amount of time devoted to it by the individual in the practice of aiming, squeezing the trigger, and leading with appropriate speed.

■ 87. PLACE IN TRAINING.—As in the case of practice in firing at moving vehicles, instruction in this type of firing should follow instruction in known-distance firing and should immediately precede the training of the squad in technique of fire when practicable.

SECTION IV

MOVING TARGETS AND RANGES AND RANGE PRECAUTIONS

■ 88. MOVING TARGETS AND RANGES.—*a. Firing at moving vehicles.*—(1) *Target.*—A sled of the type shown in figure 35 has proved to be the most satisfactory kind of target. It has the advantage of a low center of gravity which prevents upsetting on rough ground and in making changes of direction. The sled shown in the figure is 5½ by 3½ by 4½ feet high and weighs only 45 pounds. Figure 36 shows a similar sled covered with target cloth.

(2) *Towing.*—For towing the target a ½-inch rope has been found satisfactory, the power being furnished by a 1½-ton truck. The pulley shown in figure 36 is simply a channel wheel bolted to a short length of 2-inch board. This board is staked to the ground at a point where a change of direction of the target is desired. The knot shown in the figure should be 10 or 12 feet from the sled, depending on the speed at which the target is to be run. At faster speeds the knot must be at a greater distance from the sled to prevent the increased momentum of the sled from over-running the pulley.

(3) *Set-up.*—With 500 yards of rope, a set-up as shown in figure 37 can be made. This set-up is only one of many possible to make with 500 yards of rope. Accidents incident to wrong laying may be prevented by keeping just in rear of the gun a safety officer whose duty is to see that the barrel is kept pointed in a direction not too near the truck. The essential elements in training a gun squad to fire at moving targets are much practice for the observer in estimating angular speeds and for the gunner in laying on a target in motion, and for everybody, *speed*.

b. Firing at moving personnel.—Any class A range is suitable for this purpose. E targets on sticks carried by men walking in the pits are sufficient.

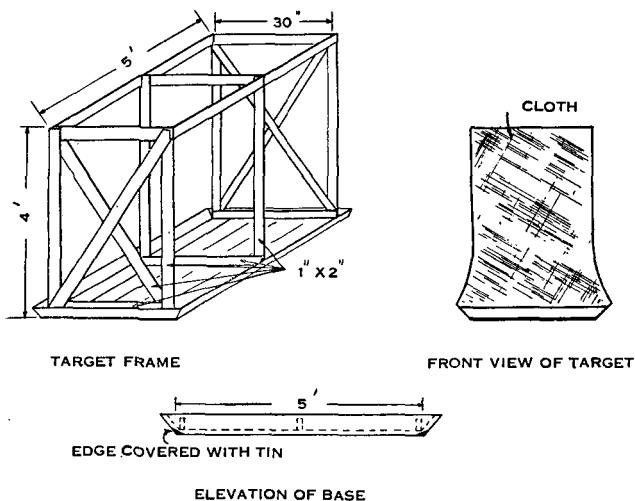

FIGURE 35.—Target frame for moving target range.

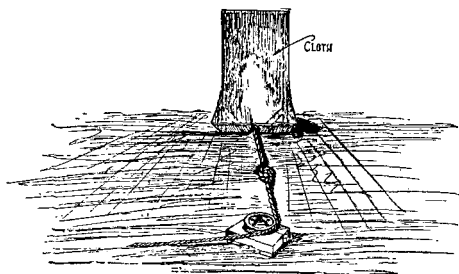
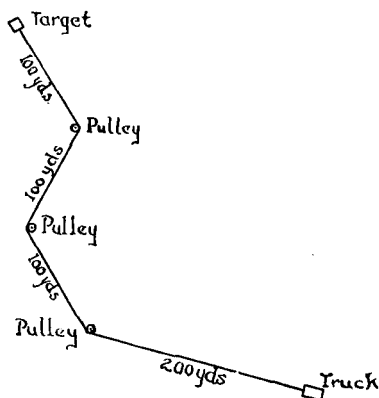

FIGURE 36.—Sled target covered with target cloth; pulley and trip knot for effecting changes of direction.

■ 89. RANGE PRECAUTIONS.—For general range precautions including danger areas, see AR 750-10. In addition to the individual safety precautions prescribed in chapter 2, the following precautions will be observed:

a. Firing at moving targets will not be permitted on any range until the safety angles have been carefully checked



• GUN

FIGURE 37.—Set-up for towing a target.

and markers have been placed so as to define clearly the right and left limits of fire.

b. Personnel of trucks towing moving targets will operate at such distance from the line of fire as to be protected not only from direct hits but from ricochets.

c. Trucks replacing targets on the course or personnel effecting repairs will be equipped with red flags.

CHAPTER 4

MARKSMANSHIP; AIR TARGETS

	Paragraphs
SECTION I. Nature of air targets for rifle.....	90- 91
II. Technique of fire.....	92- 96
III. Marksmanship training.....	97-101
IV. Miniature range practice.....	102-105
V. Towed-target firing.....	106-110
VI. Ranges, targets, and equipment.....	111-116

SECTION I

NATURE OF AIR TARGETS FOR RIFLE

■ 90. AIR TARGETS SUITABLE FOR RIFLE FIRE.—Combat arms take the necessary measures for their own immediate protection against low-flying hostile aircraft. Therefore all troops must be fully trained and imbued with the determination to protect themselves against hostile aerial attacks without reliance upon other arms. All low-flying hostile airplanes are suitable targets for rifle fire. These targets consist of aircraft on reconnoitering missions, maneuvering to take photographs, spotting for artillery, diving or hedgehopping to attack ground troops and installations.

■ 91. CLASSIFICATION OF AIR TARGETS.—From the point of view of the rifleman, air targets may be classified as—

a. Overhead—those which pass over or nearly over the rifleman; or *nonoverhead*—those which do not pass over or nearly over the rifleman. Either of these types may be flying at a constant altitude or may be decreasing or gaining in altitude.

b. Direct diving—those which dive directly toward a rifleman; or *direct climbing*—those which climb directly away from a rifleman.

SECTION II

TECHNIQUE OF FIRE

■ 92. GENERAL.—Airplanes which are suitable targets for rifle fire present very fleeting targets. They must be engaged

promptly by all available weapons. Riflemen must be taught a simple method of firing on hostile low-flying airplanes. This section on the technique of fire deals entirely with actual fire on hostile planes. Details of antiaircraft marksmanship training are contained in sections III, IV, and V.

■ 93. LEADS.—*a. General.*—In order to hit a target, such as an airplane in flight, it is necessary to aim an appropriate distance ahead of it and on its projected path of flight so that the target and the bullet will meet. This distance ahead of the airplane is called "lead." A lead must be applied in all firing except when the target is at extremely close range (100 feet), when it is diving directly at the firer, or flying directly from him.

b. Determination of leads.—(1) The lead necessary to engage any target depends upon—

(a) The speed of the target.

(b) The range of the target.

(c) The time of flight of the bullet.

(d) The direction of flight of the target with respect to the line of fire.

(2) When a target appears, it is impossible for riflemen or leaders of rifle units to consider all of the factors contained in (1) above and compute accurately the lead required for firing. Therefore leads are computed and placed in lead tables for use of leaders in training their units. (See par. 183 c.)

c. Application of leads.—Although leads are originally computed in feet or yards, they are given in lead tables as target lengths. It is very difficult for a rifleman to estimate with any degree of accuracy, a lead such as 40 or 50 yards at ranges from 600 to 100 yards. Therefore, the length of the target as it appears to the firer is used as the unit of measure for applying leads. The rifleman is trained to apply the length of the target, as it appears to him, along the projected path of the target to determine the aiming point for each shot. The number of times he applies this unit of measure will be announced in a fire order or as explained in paragraph 95.

■ 94. TARGET DESIGNATION.—*a. Aerial target designation* may be given as routine training in training areas long before the

area of probable hostile air attack is reached. Aerial targets for a single unit will be clearly visible and few in number.

b. Attacking aviation will usually fly in a V-shaped formation of three airplanes each or will operate individually. When all the fire of a rifle unit is directed at one airplane of a V-shaped formation, the normal dispersion will result in effective interdiction of the remaining airplanes of the formation. Therefore the normal method of target designation is to assign each of the three airplanes to an element of the rifle platoon during the training period. For example, the first squad is assigned the leading airplane; the second squad the right airplane; and the third squad the left airplane. In case less than three planes attack, the units not having a target assigned fire on the leading airplane. The assignment is not changed except under unusual circumstances.

c. The normal assignment of a target extends from its initial appearance until it passes beyond range. The unit leader seeing a succession of groups of hostile airplanes will cause his unit to cease fire at one group in time to bring fire on the following groups as they approach within effective range.

■ 95. FIRE DISTRIBUTION.—a. The fire of rifle units must be distributed along the path of flight of the target as long as the target is within effective range. This is done as follows:

(1) For all targets except direct diving or direct climbing, aim and fire each shot with four target-length leads.

(2) For all direct diving or direct climbing targets, aim and fire each shot at the target.

b. This method of fire distribution is based upon the fact that as the target is approaching or receding the range and the leads are constantly changing. The lead used is the average of all leads necessary to engage a target between the extreme effective range of 600 yards and a minimum range of 0 yards.

c. The target considered in determining the lead of four target lengths is a 30-foot airplane. In using this method for towed-target firing, the lead will have to be changed in accordance with the length of the sleeve target. (See par. 183 c.)

d. It is impracticable for men to estimate airplane speeds with any degree of accuracy; therefore the speed of present day attack ships which is approximately 200 miles per hour is used. For speeds considerably greater or less than 200 miles per hour the lead should be changed proportionately. The speed of the target may be slightly more or less than 200 miles an hour; however, the lead is computed on approximate data, and the lead estimates of all riflemen are approximations at best. Experience has shown that this method of distribution gives results equal to or better than more accurate and more complicated methods.

e. Other methods of fire distribution may be used by unit commanders in training their units. Examples are given in section IV, chapter 6.

■ 96. DELIVERY OF FIRE.—*a. Range.*—(1) The maximum effective range of rifle fire at air targets is approximately 600 yards. However, riflemen should take the firing position as soon as possible after receiving the warning of the approach of hostile airplanes and track the target until it comes within range.

(2) Training in estimating ranges of air targets is conducted by having individuals observe airplanes flying at known ranges. The individual bases his estimate on the appearance of the airplane at key ranges. The following data showing ranges and parts of airplane visible at those ranges are based on an 0-46 airplane:

	<i>Range (yards)</i>
General outline.....	1,000
Wheels, rudder, wing struts, tail skid.....	700
Antenna and small projections from fuselage---	500
Symbols, numbers, and letters.....	200

b. Rate of fire.—The rate of fire at aerial targets is about the same as the rapid-fire rate at ground targets. Everything must be done to increase the rate of fire without affecting its accuracy. Repeated tests have proved that rifle fire delivered faster than is consistent with proper aim and trigger squeeze results in waste of ammunition. Each shot must be aimed and squeezed. A well-trained rifleman can fire one shot in about 2 seconds. A faster rate is possible if

the rifleman does not aim and squeeze the trigger. This should not be permitted.

c. Sight used.—No attempt should be made to use the peep sight. Fire by sighting over the top of the rear sight and front sight. It is impossible to use the peep sight and see the target while aiming at the estimated lead.

d. Accuracy of fire.—Firing in time of peace indicates that the antiaircraft fire of trained riflemen is effective and should cause substantial losses to hostile air units.

e. Effect of caliber .30 fire on the airplane.—(1) There are various degrees of possible damage to an airplane from rifle fire. Hits upon the cylinder walls and other important working parts are likely to stop an engine immediately. A hit through the metal propeller is also serious since it throws the engine out of balance. Unless the bombs carried by the airplane are bulletproof, hits by armor-piercing small-arms bullets will detonate them. Of course the pilot is especially vulnerable.

(2) There are also many lesser ways in which fire can damage an airplane. Holes through the crankcase may cause the oil to drain out and the engine to "freeze" before the airplane returns to friendly territory. Hits of any kind, in fact, require varying degrees of repair, if they do not cause the destruction of the airplane.

SECTION III

MARKSMANSHIP TRAINING

■ 97. INSTRUCTION.—*a. Object.*—The object of antiaircraft marksmanship instruction is to train the rifleman in the technique of firing at rapidly moving aerial targets.

b. Basis.—(1) Prior to instruction in antiaircraft marksmanship, the soldier should have completed a course of training in rifle marksmanship and thereby acquired the fundamentals of good shooting. To become a good antiaircraft marksman, he must be able to apply the fundamentals of target practice to firing at rapidly moving targets and to perform the following operations with accuracy and precision:

(a) Apply the length of the target as a unit of measure in measuring the required lead.

(b) Aline the sights of the rifle on the required lead rapidly.

(c) Swing the rifle with a smooth, uniform motion so as to maintain the aim on the required lead while getting off the shot.

(d) Properly apply the trigger squeeze so as to fire in a minimum of time and without disturbing the aim.

(2) The correct performance of the foregoing operations combined into one continuous, smooth motion when firing in any direction at rapidly moving aerial targets is the basis for the course of training outlined herein.

c. Sequence of training.—Antiaircraft rifle marksmanship is divided into preparatory exercises, miniature range practice, and towed-target firing.

d. Personnel to receive training.—All personnel of units whose primary weapon is the rifle should receive antiaircraft marksmanship training consistent with the time available and ammunition allowances.

■ 98. PREPARATORY EXERCISES.—*a. General.*—(1) *Description.*—The preparatory exercises are designed to teach the soldier the correct method of doing each of the fundamentals of antiaircraft rifle marksmanship and to drill him therein until the correct procedure becomes a fixed habit. In addition to a brief explanation of the technique of antiaircraft rifle fire, the preparatory exercises consist of the following three distinct steps which should be completed on each of the targets described hereafter prior to firing on those targets:

(a) Position exercise.

(b) Aiming and leading exercise.

(c) Trigger-squeeze exercise.

(2) *Methods.*—A conference by the instructor should precede each exercise. This conference should include an explanation of the necessity of the exercise and demonstrations by the instructor and a qualified squad. In order to awaken interest and to stimulate the soldier's enthusiasm, the preliminary instruction should be individual and thorough. Each man should understand and be able to explain each point.

(3) *Coaching.*—During all preparatory exercises and miniature range firing when a man is in a firing position he should

have a coach whose duty it is to watch him and to point out his errors. For this purpose the soldiers should be grouped in pairs and take turns in acting as coach and pupil. Unit leaders are the instructors and should supervise and prompt the coaches.



① Nonoverhead target.

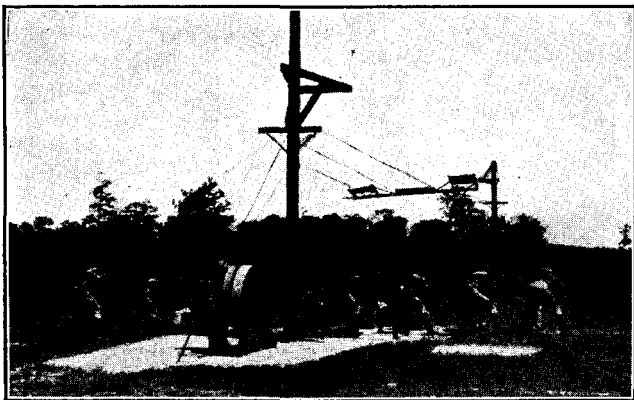

② Overhead target.

FIGURE 38.—Organization for training.

b. Organization.—With the targets and target range described hereinafter (see pars. 111 to 116, incl.), a group of 32 men per target is the most economical training unit. For the preparatory exercises this will permit 16 men to perform

the exercises on each type of target while the remaining 16 men act as coaches. (See fig. 38.) Each group should complete all preparatory training and instruction firing on its assigned target. Groups should then change places. The preparatory training and instruction firing should then be undertaken on the new type of target. This procedure should be followed until each man of each group has completed his instruction on each of the four types of targets.

■ 99. FIRST STEP: POSITION EXERCISES.—*a. General.*—The positions used in antiaircraft firing are those which can be assumed rapidly, afford the maximum flexibility to the body for manipulation of the rifle, and do not require undue exposure of the firer. These positions will usually be either kneeling or standing. The kneeling position best meets the requirements listed above as it is less vulnerable than the standing position.

b. Firing positions.—(1) Antiaircraft firing positions differ from those used in ground target firing in that—

(a) The sling is not used.

(b) The arms are not supported but move freely in any direction with the body.

(c) The hands grasp the piece firmly, the left hand near the lower band.

(d) The butt of the rifle is pressed firmly against the shoulder with the right hand, and the cheek is pressed against the stock.

(e) In the kneeling position the buttock does not rest on the heel, and the left foot is well advanced to the left front. The weight is slightly forward. (See fig. 39.)

(2) The positions must be such that the rifle, the body from the waist up, the arms, and the head are as one fixed unit.

(3) When leading a target the rifle must be swung with a smooth, uniform motion. This is accomplished by pivoting the body at the waist. There should be no independent movement of the arms, shoulders, head, or the rifle.

(4) The instructor explains and demonstrates the position, and points out that if the rifle is pulled or pushed in the desired direction by means of the left hand and arm the rifle will move with a jerky motion, thereby increasing



①



②

FIGURE 39.—Rifleman in anti-aircraft kneeling position.

the possibility of jerking the trigger, or the front sight may be pulled or pushed out of alinement with the rear sight and the eye.

(5) Position exercises should be conducted so that the soldier will become proficient in assuming positions rapidly for firing at hostile aircraft moving in any direction.

■ 100. SECOND STEP: AIMING AND LEADING EXERCISES.—*a. Purpose.*—The purpose of the aiming and leading exercise is to teach the correct method of aiming and to develop skill in swinging the rifle with a smooth, uniform motion so as to maintain the aim on aerial targets.

b. Method.—(1) In the case of the groups assigned to the nonoverhead targets, the pupils in the standing ready position are placed in one line at about 1½-yards' interval, 500 inches from and facing the assigned target. The coaches take positions that enable them to observe the pupil. The commands for the exercise are: 1. AIMING AND LEADING EXERCISE, 2. ONE (TWO OR THREE) TARGET-LENGTH LEADS, 3. TARGETS. At the command TARGETS, the targets are operated at a speed of from 15 to 20 feet per second; the pupils assume the kneeling firing position rapidly, aline the sights on the spotter indicating the proper lead, and take up the slack in the trigger; then swing the rifle with a smooth, uniform motion by pivoting the body at the waist, and maintain the aim on the proper lead during the travel of the target. The operation is repeated as the target is moved in the opposite direction. The exercise is continued until the target has been moved four times in each direction. The coach and pupil then change places, and the exercise is continued until all men have acquired some skill in aiming and leading with one, two, and three target-length leads, both from right to left and left to right.

(2) In the case of the group assigned to the overhead target, the line is formed perpendicular to and facing the line of flight of the target. The procedure is the same except that one or two target-length leads only are used. (See fig. 40 for targets used.)

c. Importance of correct position.—The importance of correct position and of swinging the rifle with a smooth, uniform motion by pivoting the body at the waist should be constantly emphasized.

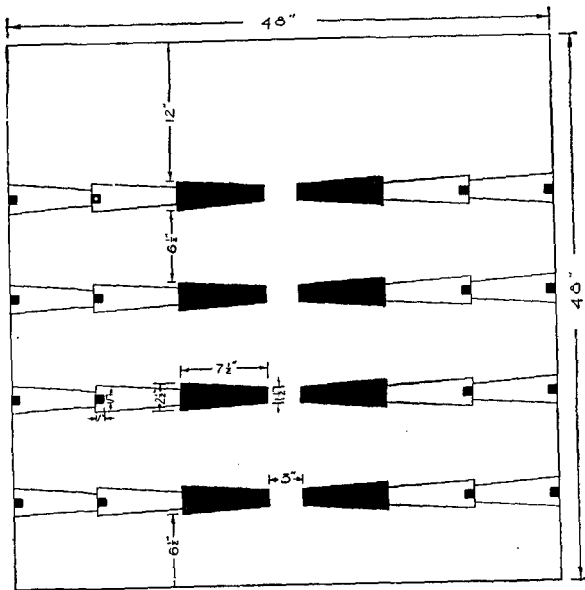

① Nonoverhead.

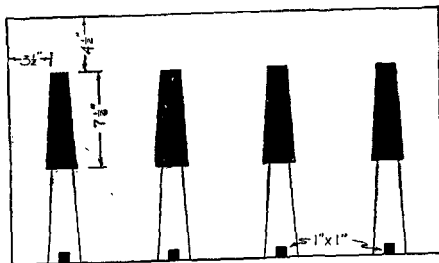

② Overhead.

FIGURE 40.—Aiming and leading targets.

d. Duties of the coach.—In the aiming and leading exercise the coach insures that the—

- (1) Proper position is taken.
- (2) Slack is taken up promptly and firmly.
- (3) Rifle is swung with a smooth motion.
- (4) Rifle is swung by pivoting the body at the waist.
- (5) Arms, shoulders, rifle, and head move as a unit with the rifle.

■ 101. **THIRD STEP: TRIGGER-SQUEEZE EXERCISES.**—*a. Importance.*—(1) Correct trigger squeeze is the most important operation to be performed in firing the rifle. The rifleman should be trained to squeeze the trigger exactly as when firing rapid fire at stationary targets except that the rifle is kept in motion during the trigger squeeze, the firing of the shot, and momentarily after the firing of the shot.

(2) In firing at a rapidly moving target, the untrained man has a tendency to permit the rifle to come to rest momentarily while applying the final squeeze. This results in the shot passing behind the target. Another fault of the untrained man is that of pulling the trigger quickly the instant the aim is on the required lead. This causes the firer to flinch because he knows when the cartridge will be discharged.

(3) Unless men are trained to apply pressure on the trigger so that they cannot know the exact instant the cartridge will be discharged, all other training will have been a waste of time.

(4) Due to the short period of time during which the usual aerial target will be within effective range, fire should be opened as soon as possible and delivered at as rapid a rate as possible consistent with accuracy. The trigger should therefore be squeezed aggressively and decisively. Once started, the squeeze should be continued until the cartridge is fired.

(5) Skill in squeezing the trigger properly when firing at rapidly moving targets is difficult to acquire. Although men will have had training in trigger squeeze during their course in stationary target marksmanship, firing at rapidly moving targets introduces certain additional elements which must be overcome before skill is acquired. The greater part

of the time allotted to preparatory exercises should therefore be devoted to trigger-squeeze exercises.

b. Object.—The object of the trigger-squeeze exercises is to train the rifleman to apply pressure on the trigger while keeping the rifle in motion, to develop a decisive trigger squeeze so that fire can be opened in a minimum of time without loss of accuracy, and to train him to follow through with the shot.

c. Method.—(1) Trigger-squeeze exercises are conducted in a manner similar to the aiming and leading exercises. The targets used are also the same except that the spotters indicating the lead are removed. (See fig. 41.) If the spotters indicating the lead are left on the target they will cause an increased tendency of the pupil to pull the trigger quickly the instant the aim is on the spotter, thereby defeating the purpose of the exercises.

(2) The pupils in the standing ready position are placed in one line at about $1\frac{1}{2}$ yards' interval, 500 inches from and facing the assigned nonoverhead target. The coaches take position so they can observe the pupil. The commands for the exercise are: 1. SIMULATE LOAD, 2. TRIGGER-SQUEEZE EXERCISE, 3. ONE (TWO OR THREE) TARGET-LENGTH LEADS, 4. TARGETS. At the command TARGETS, the targets are operated at the proper speed; the pupils rapidly assume the kneeling firing position, take up the slack in the trigger, mentally apply the target length as a unit of measure in measuring the lead announced in the order; direct the aim on that point; and, by swinging the rifle in the manner taught and practiced in the aiming and leading exercise, maintain the aim at the proper lead, at the same time applying a constantly increasing pressure on the trigger until the hammer is released. The aim and pressure on the trigger are maintained during the entire length of travel of the target regardless of the time of release of the hammer. The importance of following through with the shot cannot be too strongly emphasized. It is only by this means that men will develop the habit of keeping their rifle in motion during the entire process of firing. All of these steps are performed as one continuous operation. The exercise consists of squeezing the trigger each time the target moves across the front.

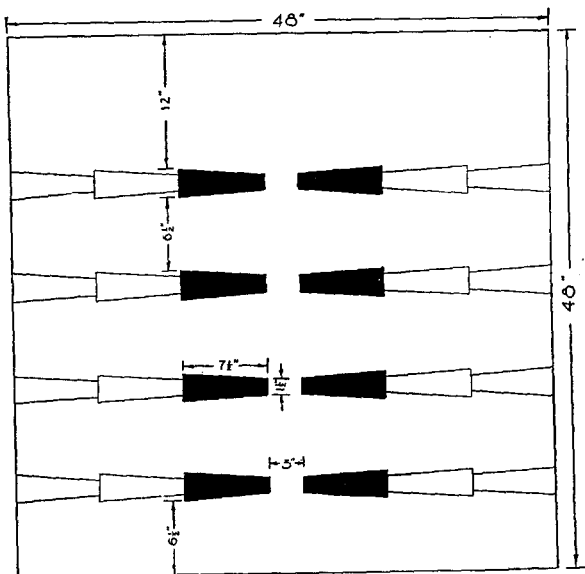

Nonoverhead.

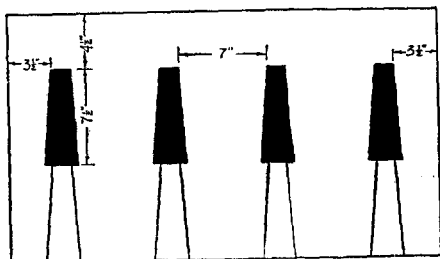

Overhead.

FIGURE 41.—Instruction targets.

The exercise consists of four passages of the target in each direction. The coach and pupil then change places, and the work is continued until all men have become proficient in squeezing the trigger correctly, using various target-length leads.

(3) The procedure for overhead trigger-squeeze exercise is the same except that the line is formed perpendicular to and facing the flight of the target and one or two target-length leads only are used.

d. Duties of the coach.—In the trigger-squeeze exercise the coach sees that the—

(1) Proper position is taken.

(2) Slack is taken up promptly and firmly.

(3) Rifle is swung with a smooth, uniform motion.

(4) Rifle is swung by pivoting the body at the waist.

(5) Arms, shoulders, rifle, and head move as a unit as the rifle is swung.

(6) Pressure on the trigger is applied promptly, decisively, and continuously.

(7) Eye is kept open and does not blink at the instant the hammer falls.

(8) Muzzle does not jerk coincident with the release of the hammer.

(9) Pupil continues the aim and trigger pressure during the entire length of travel of the target.

SECTION IV

MINIATURE RANGE PRACTICE

■ 102. GENERAL.—*a.* Miniature range practice is divided into two parts, instruction firing and group firing. There is no record firing.

b. All firing is on moving targets on the 500-inch range. A suggested arrangement of the range is given in paragraph 112. Provision is made for simultaneous firing by separate groups on the horizontal, the diving, the climbing, and the overhead targets.

c. The course should first be fired with the caliber .22 rifle after which, if ammunition and danger area will permit, the United States rifle, caliber .30, M1, may be used.

d. All rifles should be targeted before range practice starts.

■ 103. SAFETY PRECAUTIONS.—*a.* The safety precautions given in paragraph 69 are applicable to this firing and will be observed.

b. If firers are permitted to go forward to inspect their targets, rifles will be left on the firing line.

c. Target operators will remain behind the protective wall except when ordered to leave by the officer in charge of the target which they are operating.

d. If the caliber .22 rifle is used, the bolt will not be forced home if difficulty in feeding is experienced. Attempting to force the bolt home may result in igniting a rim fired cartridge before the cartridge is chambered.

■ 104. INSTRUCTION FIRING.—*a. General.*—(1) The purpose of instruction firing is to provide a means of applying the principles taught in the preparatory exercises to actual firing.

(2) During instruction firing, the soldier works under the supervision of a coach.

(3) As a group completes the preparatory training on a target, instruction firing should be taken up on that target and completed before the group moves to another target.

(4) Instruction firing consists of that indicated in table I.

b. Procedure.—(1) As the instruction firing on each type of target follows immediately after the preparatory exercises on that target, the organization of the training unit for firing should be the same as that given in paragraph 98*b*.

(2) The front rank of each group is formed on the firing line in the kneeling firing position. The rear rank acts as coaches.

(3) One-half of the front rank of the group fires while the remaining front rank men simulate firing.

(4) Silhouettes are assigned to each individual firer. For example, the four silhouettes on the right of the targets are assigned the first four men on the right of the line; the four silhouettes on the left of the targets are assigned the next four men. Silhouettes for the men simulating firing are assigned in the same manner, i. e., the right four are assigned silhouettes on the right of the target and the left four are assigned silhouettes on the left of the target.

(5) The officer in charge of the target commands: 1. LOAD, 2. ONE (TWO OR THREE) TARGET-LENGTH LEADS, 3. TARGETS.

At the command **TARGETS**, the targets are operated at the proper speed. Men assigned silhouettes on the right half of the nonoverhead targets mentally apply the target length as a unit of measure in measuring the lead announced. They direct their aim on that point and while maintaining the aim squeeze the trigger until the shot is fired. They continue to maintain the aim during the entire length of travel of the target regardless of the time the shot was fired. They fire one shot each time the target crosses from their left to right. The men assigned silhouettes on the left half of the same targets aim and fire one shot in the same manner as explained above each time the target crosses from their right to left.

(6) Men assigned silhouettes on the overhead target fire one round each time the target is run in the approaching direction in exactly the same manner as explained above.

(7) Four rounds constitute a score. After each string of four rounds, targets are scored and shot holes penciled.

(8) One point is awarded for each hit in the silhouette when using one target-length lead or in the proper scoring space when using more than one target-length lead.

(9) Half groups alternate firing and simulating firing.

(10) When front rank men have fired two scores, one score as the target moved in each direction, they change places with the men in the rear rank. They coach the rear rank men who become the firers.

(11) This procedure is followed until all men of the group have performed the required firing at that target.

(12) Upon completion of the firing prescribed in table I for any one type of target, the group moves to another type target and continues until all have completed the instruction firing.

(13) Modifications of the above method of firing to meet local conditions are authorized.

■ **105. GROUP FIRING.**—*a. General.*—(1) Group firing is the final phase of antiaircraft marksmanship training on the miniature range.

(2) It provides for competitions and illustrates the effectiveness of the combined fire of a number of riflemen.

TABLE I.—*Instruction firing*
(Range 500 inches)

Target	1 lead, 8 rounds	2 leads, 8 rounds	3 leads, 8 rounds	Total
Horizontal.	4 rds. R to L.....	4 rds. R to L.....	4 rds. R to L.....	} 24
	4 rds. L to R.....	4 rds. L to R.....	4 rds. L to R.....	
Climbing..	4 rds. R to L.....	4 rds. R to L.....	4 rds. R to L.....	} 24
	4 rds. L to R.....	4 rds. L to R.....	4 rds. L to R.....	
Diving.....	4 rds. R to L.....	4 rds. R to L.....	4 rds. R to L.....	} 24
	4 rds. L to R.....	4 rds. L to R.....	4 rds. L to R.....	
Overhead..	4 rds. approaching.....	4 rds. approaching.....	}	} 16
	4 rds. receding.....	4 rds. receding.....		

Speed of all targets, 15 to 20 feet per second. Total rounds, 88.

(3) Group firing should not be undertaken until the preparatory training and instruction firing have been completed.

b. Procedure.—(1) Two silhouettes, one to be fired upon as the target moves from left to right and one to be fired upon as the target moves in the opposite direction, are assigned to each squad or similar group.

(2) Each man of the front rank, then each man in the rear rank, fires four rounds at each silhouette as the target moves in the appropriate direction.

(3) Targets are not scored until completion of the firing of the entire squad or group.

c. Scoring.—A value of 1 is given each hit on the silhouette.

SECTION V

TOWED-TARGET FIRING

■ 106. *GENERAL.*—*a.* Towed-target firing is the final phase of rifle antiaircraft marksmanship. It is conducted on the towed-target range described in paragraph 113.

b. It consists of firing with caliber .30 ball or tracer ammunition at a sleeve target at various ranges and on varied courses.

c. Towed-target courses prescribed herein are guides which may be modified. Safety measures and ammunition requirements restrict the length of the course. Safety measures also prevent the adoption of courses such as those on which the

target, moving at a low altitude, is receding from or diving at the firing line.

d. Towed-target firing will follow miniature range instruction firing. If, due to lack of facilities, a unit is unable to conduct miniature range firing, it may be permitted to conduct towed-target firing providing antiaircraft marksmanship preparatory training has been completed.

■ 107. COURSES TO BE FIRED.—Units authorized to fire will fire one or more of the courses enumerated in table II.

TABLE II.—*Courses to be fired*

Course No.	Type of flight	Altitude of target	Horizontal range of course (yards) ¹	Speed	Remarks
1	Nonoverhead—horizontal (parallel to firing line from left to right).	Minimum consistent with safety.	Minimum, 100; maximum depends on width of danger area of range.	Maximum possible.	See fig. 53.
2	Nonoverhead—horizontal (parallel to firing line from right to left).	do	do	do	Do.
3	Overhead (perpendicular to firing line).	do	Minimum Maximum	do	See fig. 54.
4	Combined courses 1, 2, and 3.	do	Same as for courses 1, 2, and 3.	do	See fig. 55.

¹The horizontal distance from the firing point directly under the target.

The maximum slant range for all courses should not exceed 600 yards.

■ 108. SAFETY PRECAUTIONS.—*a.* Towed-target firing will be conducted with due regard for the safety of the pilot of the

towing airplane, the personnel engaged in the firing, and all spectators.

b. All firing must be controlled by suitable signals or commands. COMMENCE FIRING and CEASE FIRING must be given in such a manner as to be understood clearly and promptly by everyone engaged in firing.

c. The signals and commands for COMMENCE FIRING and CEASE FIRING will be given at such time as to prevent any bullets from falling outside the danger area.

d. For all overhead flights, the signal or command for COMMENCE FIRING will not be given until the towing plane has reached a point 50 yards or less (measured horizontally on the ground) from the firing line, and there is no danger of bullets striking the plane. The signal or command for CEASE FIRING will be given before the sleeve target is 100 yards (measured horizontally on the ground) in advance of the firing line, so there is no danger of bullets dropping outside the firing area.

e. Whenever a towing cable breaks and the towing airplane is on a course which passes near the firing point, all personnel in that vicinity will be warned to lie flat on the ground until danger from the loose cable and the release is passed.

f. No rifle will be pointed at or near the towing airplane. All tracking will be on the towed target. Muzzles will be depressed during loading.

g. At least two safety officers will be designated to assist the officer in charge of firing in carrying out safety precautions.

h. Firing will be permitted only when the smaller angle in space between the gun-target line and the tow line is greater than 45°.

i. An Air Corps officer should be at the firing point during an organization's initial practice for the season for the purpose of giving supplemental instruction and checking the safety measures taken.

j. Additional safety precautions are covered in AR 750-10.

■ 109. PROCEDURE OF FIRING.—a. The men to fire take the antiaircraft kneeling firing position on the firing line with at least 1½ yards between men.

b. The officer in charge of firing takes position in rear of the center of the firing line.

c. Safety officers take position at either flank of the firing line.

d. As the towing airplane approaches the left (right) side of the danger area, the officer in charge of firing gives the command: 1. (SO MANY) ROUNDS, LOAD, 2. SLEEVE TARGET APPROACHING FROM THE LEFT (RIGHT). Each rifleman locks and loads his piece.

e. As the towed target approaches the danger area, the officer in charge of firing commands: 3. FOUR TARGET-LENGTH LEADS. (See par. 183 c.) At this preparatory command, each rifleman unlocks his piece, aims by swinging through the sleeve to the announced lead, pivoting at the waist, and maintains his estimated lead.

f. In firing at crossing targets, the safety officer stationed at the end of the firing line, opposite to the target's approach, signals or commands COMMENCE FIRING when the sleeve target has completely crossed the line marking the firing area. The officer in charge of firing and such assistants as he desires repeat the command or signal to insure that all firers hear it. Each rifleman squeezes the trigger until the first shot is fired. He then continues rapidly to reload, re-aim, and fire until the command or signal CEASE FIRING is given. The safety officer at the end of the firing point opposite to the target's departure observes the flight of the sleeve target during the firing. When he observes that the sleeve is about to leave the danger area he signals or commands CEASE FIRING. The officer in charge of firing and his assistants repeat the command or signal to insure that all firers hear it.

g. In firing at overhead targets, the same procedure is followed except that the officer in charge of firing, from his position behind the center of the firing line, determines when firing commences and ceases. He gives the command or signal to COMMENCE FIRING when the towing plane is 50 yards or less in advance of the firing line and gives CEASE FIRING before the sleeve is 100 yards in advance of the firing line. (See par. 108.)

■ 110. SCORING.—*a.* The number of hits is found by dividing the number of holes in the target by two. An odd hole is counted as a hit.

b. The hit percentage is obtained by dividing the number of hits as obtained in *a* above by the total number of rounds fired at the target.

SECTION VI

RANGES, TARGETS, AND EQUIPMENT

■ 111. RANGE OFFICER.—A range officer is appointed well in advance of range practice. His chief duties are—

a. To make timely estimates for material and labor to place the range in proper condition for firing.

b. To supervise and direct the repairs and alterations to installations.

c. Where safety demands, to instruct and supervise range guards.

■ 112. MINIATURE RANGE.—*a.* The miniature range consists of—

(1) One horizontal target (fig. 42 ⊕).

(2) One double climbing and diving target (fig. 42 ⊕).

(3) One overhead target (fig. 42 ⊕).

b. A suggested arrangement of the targets is shown in figure 43.

c. For details of range apparatus, see figures 45 to 50, inclusive.

d. (1) The danger area required is dependent upon the type of ammunition. (See AR 750-10 for size and shape.)

(2) The miniature range may be laid out in the same manner as described in paragraph 113 *c.* Care must be taken to insure that the firing line and targets are placed so that no fire will fall outside of the danger area.

e. If the organization for training is as suggested in paragraph 98 *b.*, the following equipment is necessary:

64 caliber .22 rifles (if available).

4 aiming and leading targets (fig. 40). (Each of these targets consists of a piece of beaverboard on which the silhouettes are pasted.)

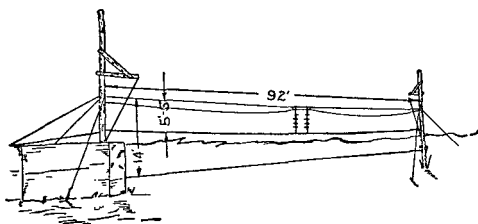

① Horizontal.

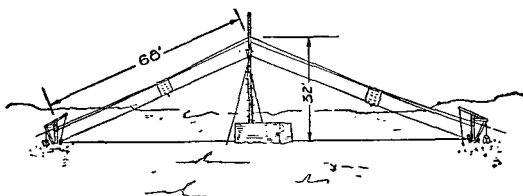

② Double climbing and diving.

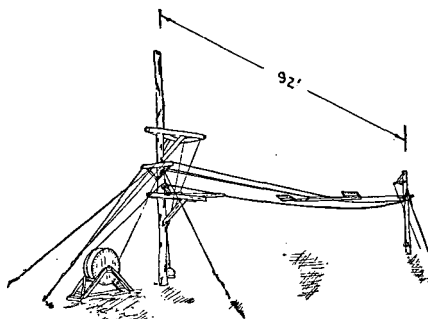

③ Overhead.

FIGURE 42.—Targets.

U. S. RIFLE, CALIBER .30, M1

112-113

6 instruction firing targets per range (fig. 41).

(These targets are the same as the aiming and leading targets except that the spotters are eliminated.)

1 score card per man.

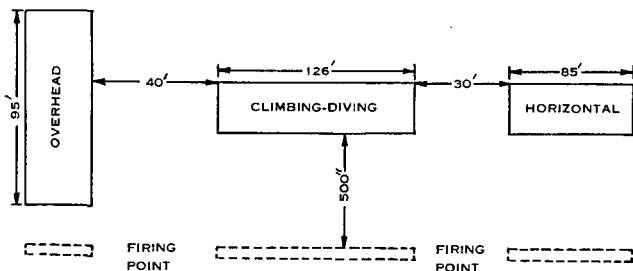

FIGURE 43.—Arrangement of targets.

INDIVIDUAL SCORE CARD

ANTI-AIRCRAFT RIFLE MARKSMANSHIP

Date....., 19.....

Name.....

Target	1 TL lead			2 TL lead			3 TL lead		
	Rounds fired	Hits	Per-cent	Rounds fired	Hits	Per-cent	Rounds fired	Hits	Per-cent
Horizontal.....									
Climbing.....									
Diving.....									
Overhead.....									
Total.....									

■ 113. TOWED-TARGET RANGE.—*a.* In selecting the location of a towed-target range the danger area is the chief consideration. (See AR 750-10.)

b. The firing point should accommodate at least 50 men in line with a $1\frac{1}{2}$ -yard interval between men. A level strip of ground, preferably on a hill, 75 yards long and 2 yards wide is suitable. A firing point similar to the firing point of a class A rifle range may be built.

c. (1) After the towed-target range has been selected, the firing point, limits of fire, and danger area should be plotted on a map or sketch of the area.

(2) From this map or sketch, the range is then laid out on the ground. First, each end of the firing point is marked by a large stake. The right and left limits of fire are then each marked by a post. Each post is placed at the maximum distance at which it will be plainly visible from the firing point. When these distances have been determined, the posts are located in azimuth by the following method: To locate the post marking the left limit of fire, an aiming circle or other angle-measuring instrument is set up at the right end stake of the firing point. It is then oriented and laid on an azimuth which, by reference to the map or sketch, is known to be the farthest to the left that the rifle at the right end of the firing point can safely be fired. The post marking the right limit of fire is similarly located with the instrument set up at the left end stake of the firing point. (See fig. 44.)

(3) Direction guides for the towing airplane to follow should, within the limits of fire, be distinctly marked on the ground for each course. White targets or strips of cloth placed flat on the ground about 30 feet apart are suitable.

■ 114. TOWED TARGETS.—*a. Type and source.*—The targets used in towed-target firing are sleeve targets furnished by the Air Corps unit assigned the towing mission. They are returned to the Air Corps unit after they have been scored.

b. Towline.—The towing line will be not less than 600 yards long.

■ 115. INSTRUCTIONS TO PILOTS FOR TOWING MISSIONS.—*a.* Towed-target firing requires the closest cooperation between the pilot of the towing airplane and the officer in charge of firing. Decisions affecting the safety of the plane rest with Air Corps personnel.

b. The air mission for towed-target firing should be specifically stated. The commanding officer requesting airplanes for towed-target firing should furnish, in writing, to the Air Corps unit commander concerned the following information:

- (1) Place of firing.
- (2) Date and hour of firing.
- (3) Number of missions to be flown; altitude, course, speed, and number of runs for each.
- (4) Ground signals to be used.

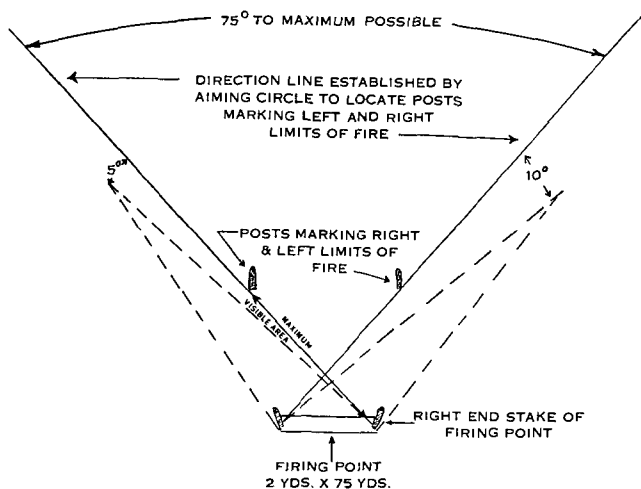

FIGURE 44.—Towed-target range showing firing point and limits of fire. Dotted lines show danger area.

(5) Map of the area with the firing line, angle of fire, danger area, course of each mission, and location of the grounds for dropping targets and messages plotted thereon. An alternate dropping ground should be designated when practicable, and either or both dropping grounds are subject to approval by the pilot.

(6) Length of the towline, within limits established by the Air Corps, and subject to approval of the pilot.

(7) Number of sleeve targets required.

c. Whenever practicable to do so, the officer in charge of the firing will discuss with the pilot the detailed arrangements mentioned in *b* above. This discussion should take place on the towed-target range where the various range features can be pointed out to the pilot. The courses over which the airplane is to be flown should be distinguished on the ground (within the angle of fire). Machine-gun targets placed flat on the ground about 30 feet apart or strips of target cloth are practicable for this purpose on some courses. On others a terrain feature such as a beach line may be used.

■ 116. SIGNALS.—*a.* Direct radio communication is the most effective means by which the officer in charge of towed-target firing and the pilot of the towing plane maintain contact with each other. Even though radio is being used, panels should be available in case radio communication fails.

b. For signaling from the ground to the pilot, any method agreed upon by the officer in charge of firing and the pilot of the towing airplane may be used. The panel signals generally used are as follows:

Stand by-----	0	0	2.
Ready fire-----	0	0	0.
Repeat run No. 1-----	0	9	1.
Repeat run No. 2-----	0	9	2.
Repeat run No. 3-----	0	9	3.
Repeat course-----	0	9	4.
Mission complete-----			Pick up panels.

c. The pilot may also communicate with the officer in charge of firing by dropped messages or by rocking his wings.

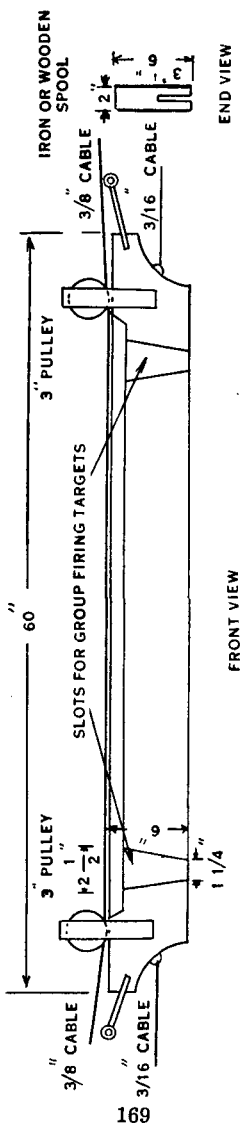

FRONT VIEW
 END VIEW
 FIGURE 45.—Nonoverhead target carrier.

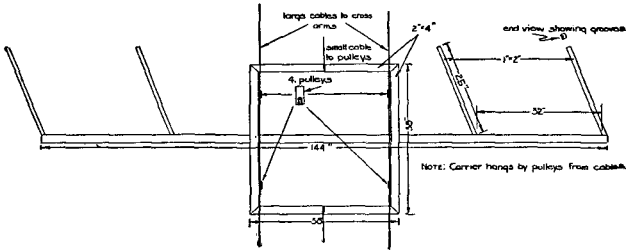

FIGURE 46.—Overhead target carrier.

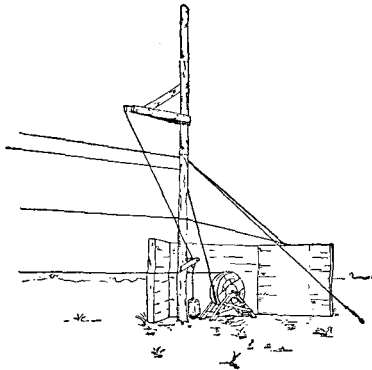

FIGURE 47.—Rear view of nonoverhead range butts, showing drum, guide wires, and bumper.

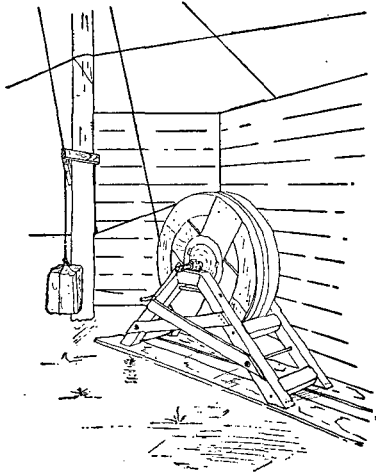

FIGURE 48.—Moving target drum. One complete turn moves target 15 feet.

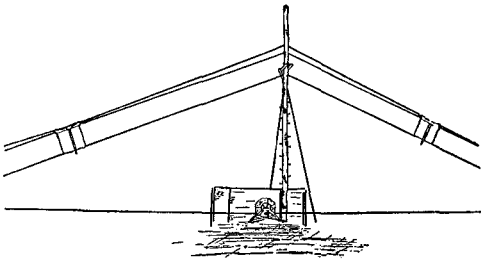

FIGURE 49.—Rear view of climbing and diving target.

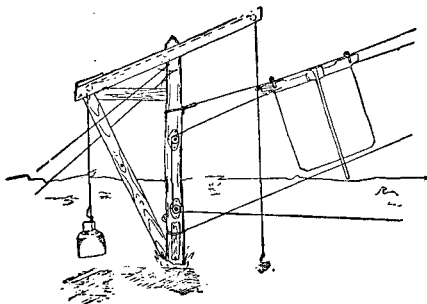

FIGURE 50.—Rear view of climbing and diving target and method of securing target to frame.

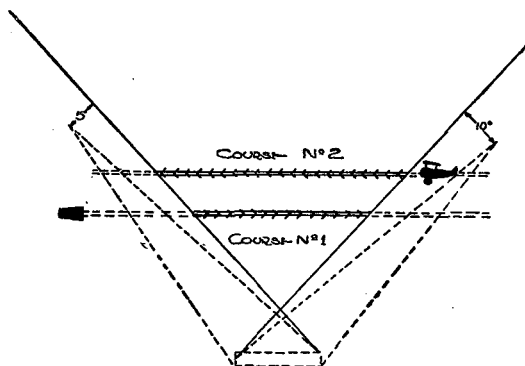

FIGURE 51.—Courses Nos. 1 and 2. Firing takes place when target is on shaded portion of course.

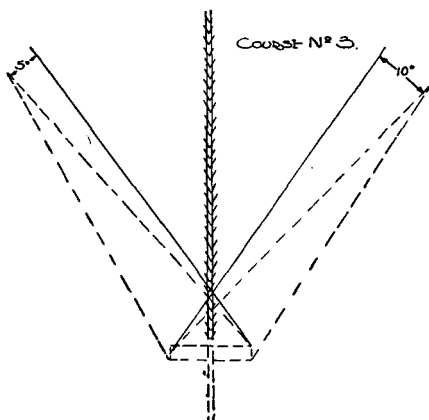

FIGURE 52.—Course No. 3. Firing takes place when target is on shaded portion. Fire is opened when towing airplane is 50 yards or less from firing point.

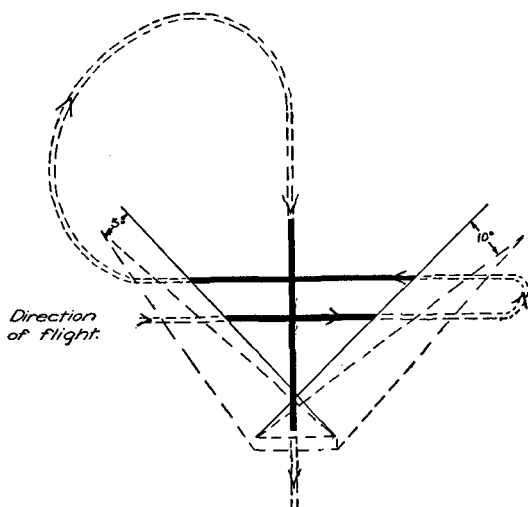

FIGURE 53.—Course No. 4. Heavy lines indicate when towed-target is fired upon.

CHAPTER 5

TECHNIQUE OF RIFLE FIRE

	Paragraphs
SECTION I. General	117-119
II. Range estimation	120-124
III. Target designation	125-131
IV. Rifle fire and its effect	132-138
V. Application of fire	139-146
VI. Landscape-target firing	147-154
VII. Field-target firing	155-157
VIII. Fire exercises	158-160

SECTION I

GENERAL

■ 117. **DEFINITIONS.**—*a.* The training of riflemen for combat is progressive in nature and includes three phases. The *first phase* is individual training and comprises such allied subjects as rifle marksmanship, extended order, drill and combat signals, and certain elements of scouting and patrolling. The *second phase* is called “technique of fire” and is team training consisting of instruction in the application and control of the collective fire of rifle fire units. In the *third phase* the individual and team training learned in the first and second phases are combined with tactical training. This chapter deals with the second phase of training.

b. *Collective fire* is the combined fire of a group of individuals.

c. A *fire unit* is one whose fire in battle is under the immediate and effective control of its leader. The usual rifle fire unit is the squad.

■ 118. **IMPORTANCE OF RIFLE FIRE.**—Effective rifle fire is an element which may determine the issue of battle. Collective fire is most effective when it is the product of teamwork. Training in the technique of fire as set forth in this chapter is designed to train rifle squads to act as efficient and dependable teams in the application and control of collective fire.

■ 119. **SCOPE.**—*a.* This training is conducted without regard to tactical considerations. However the application of this

training to tactical situations should be kept in mind. Instruction is progressive and is divided into six consecutive steps. Each step includes some or all of the technique learned in previous steps. The steps are as follows:

- (1) Range estimation.
- (2) Target designation.
- (3) Rifle fire and its effect.
- (4) Application of fire.
- (5) Landscape-target firing.
- (6) Field-target firing.

b. A 13-week training schedule for mobilization should include about 30 hours for this instruction.

c. It is not essential that perfection be reached in each step before proceeding to the next step; it is better that such a standard be attained by repetition, applying in the steps that follow everything that has been learned. However, each step should be understood before proceeding to the next. The instructor explains each step in detail. He then makes plain its relation to the subject as a whole. This is followed by a demonstration which in turn is explained by the instructor. The troops then practice the principles and methods previously explained and demonstrated. Exercises pertaining to each step are hereinafter described in detail. They can be used for demonstrations and instructional practice. Some of them can be used to test fire units, thus introducing the desirable element of competition. These exercises may be changed to conform to local conditions.

SECTION II

RANGE ESTIMATION

■ 120. IMPORTANCE.—In battle, ranges are seldom known in advance, so that the effectiveness of fire depends in large measure upon the accuracy of range estimation.

■ 121. METHODS.—Of the various methods of estimating ranges, only the following are considered in instruction in the technique of rifle fire:

- a. Use of tracer bullets.
- b. Observation of fire.
- c. Estimation by eye.

■ 122. USE OF TRACER BULLETS.—When the range to a target is being estimated by the use of tracer bullets, the scout or leader first estimates the range by eye, fires a tracer bullet, corrects the sight setting according to the strike of the bullet, and continues to fire and correct the sight setting until a tracer appears to strike the target. The estimator then announces the correct range after due consideration of the zero of his rifle.

■ 123. OBSERVATION OF FIRE.—This method can be used when the ground is dry and the strike of the bullets is indicated. The same procedure is followed as in determining the range by tracer bullets. The following points must be taken into consideration:

a. Dust will appear slightly above the striking point of the bullet.

b. If observing from the firing point, dust will appear on the side toward which the wind is blowing.

c. If observing from a point on the flank, shots which pass over the objective will appear to strike on the side toward which the observer is posted; those which fall short, toward the opposite side.

■ 124. ESTIMATION BY EYE.—a. *Necessity for training.*—The usual method of estimating ranges in combat is estimation by eye. Untrained men make an average error of 15 percent of the range when estimating by eye. Hence a definite system of range estimation, coupled with frequent practice on varied terrain, is essential to success with this method.

b. *Unit of measure method.*—(1) Ranges less than 500 yards are measured by applying a mental unit of measure 100 yards long. Thorough familiarity with the 100-yard unit and with its appearance on varied terrain and at different distances is necessary if the soldier is to apply it accurately.

(2) Ranges greater than 500 yards are estimated by selecting a point halfway to the target and applying the unit of measure to this halfway point, and doubling the result.

(3) The average of a number of estimates by different men will generally be more accurate than a single estimate. This variation of the suggested method is used when time

permits by taking the average of the estimates of members of the squad or specially qualified men.

c. Appearance of objects.—In some cases much of the ground between the observer and the target will be hidden from view, and the application of the unit of measure will be impossible. In such cases the range is estimated by the appearance of objects. Whenever the appearance of objects is used as a basis for range estimation, the observer must make allowance for the following effects:

(1) Objects seem nearer—

(a) When the object is in a bright light.

(b) When the color of the object contrasts sharply with the color of the background.

(c) When looking over water, snow, or a uniform surface like a wheat field.

(d) When looking downward from a height.

(e) In the clear atmosphere of high altitudes.

(f) When looking over a depression most of which is hidden.

(2) Objects seem more distant—

(a) When looking over a depression most of which is visible.

(b) When there is a poor light, or fog.

(c) When only a small part of the object can be seen.

(d) When looking from low ground upward toward higher ground.

d. Exercises.—(1) *No. 1.*—(a) *Purpose.*—To familiarize the soldier with the unit of measure—100 yards.

(b) *Method.*—The unit of measure, 100 yards, is previously staked out over varied ground, using markers that will be visible up to 500 yards. The men are required to become thoroughly familiar with the appearance of the unit of measure from the prone, kneeling, and standing positions at various ranges. They do this by moving away from and in prolongation of the lines staked out and studying the appearance of the unit from distances of 100, 200, 300, and 400 yards.

(2) *No. 2.*—(a) *Purpose.*—To illustrate the application of the unit of measure.

(b) *Method.*

1. Ranges up to 900 yards are measured accurately and marked at every 100 yards by large markers or target frames, each bearing a number to indicate its range. Men undergoing instruction are then placed about 25 yards to one side of the prolonged line of markers and directed to place a hat or other object before their eyes so as to exclude from view all of the markers. They are then directed to apply the unit of measure five times along a straight line parallel to the line of markers. When they have selected the final point, the eye cover is removed and the estimations of the successive 100-yard points and the final point are checked against the markers. Accuracy is gained by repeating the exercise.
2. Ranges greater than 500 yards are then considered. With the markers concealed from view, men estimate the ranges to points which are obviously over 500 yards distant and a little to one side of the line of markers. As soon as they have announced each range, they remove their eye covers and check the range to the target and to the halfway point by means of the markers. Prone, sitting or kneeling, and standing positions are used during this exercise.

(3) *No. 3.—(a) Purpose.*—To give practice in range estimation.

(b) *Method.*—From a suitable point, ranges are previously measured to objects within 1,000 yards. The men are required to estimate the ranges to the various objects as they are pointed out by the instructor, writing their estimates upon paper previously issued. At least one-half of the estimates are made from the prone or sitting positions. Thirty seconds are allowed for each estimate. When all ranges have been estimated, the papers are collected and the true ranges announced to the class. To create interest, individual estimates and squad averages may be posted on bulletin boards.

SECTION III

TARGET DESIGNATION

■ 125. IMPORTANCE.—Target designation is a vital element in technique of fire. Battlefield targets are generally so indistinct that leaders and troops must be able to designate their location and extent. Enemy troops will usually be so well-concealed that the location of most individuals of the hostile unit will not be visible. To cover such a target, squad leaders must be able to designate the area in which hostile troops are located, and members of the squad must be trained to place a heavy fire on the designated area even though no specific targets are visible.

■ 126. TOPOGRAPHICAL TERMS.—Prior to instruction in target designation, riflemen should understand the topographical terms normally employed in designating targets; for example, crest, military crest, hill, cut, ridge, bluff, fill, ravine, cross-roads, road junction, road center, road fork, skyline, etc.

■ 127. METHODS.—*a.* The following methods are used to designate targets:

- (1) Tracer bullets.
- (2) Pointing.
- (3) Oral description.
- (4) A combination of any or all of the methods in (1), (2), and (3) above.

b. Troops should be trained in *all* the methods. The method used should be the one best suited to the conditions existing at time of the appearance of the target. The simplest form of target designation is the most effective.

■ 128. TRACER BULLETS.—*a.* The use of tracer bullets is a quick and sure method of designating an obscure battlefield target. Their use is invariable when scouts or other members of the squad are already under fire, when the squad is deployed and separated and out of voice range of the leader, or when cover is scarce and pointing or other movement will expose personnel to hostile fire. Their use, however, has limitations for they may disclose the position of the firer to the enemy; further, the effect of a sudden burst of fire is

lessened by preceding it with tracers. Tracer bullets are also the most accurate method of indicating the flanks of an obscure target.

b. To designate a point target by this method, the scout or leader announces, "Range 500, watch my tracer," and fires a tracer at the target. The flanks are indicated by firing tracer bullets at each flank, announcing each such shot as "Left flank, right flank." Any range correction obtained by tracer firing should be announced.

■ 129. POINTING.—Targets may be pointed out either with the arm or the rifle. Pointing may be supplemented by oral description. To use the rifle for this purpose, it is canted to the right and aimed at the target. The head is then straightened up without moving the rifle. A soldier standing behind looks through the sights and locates the target. If time permits, a bayonet can be stuck in the ground as a rest for a rifle aimed at the target. In pointing, the range is always announced. Usually some supplementary description will be necessary.

■ 130. ORAL DESCRIPTION.—a. *Use.*—Oral description is often used by leaders to designate targets to their units. Battlefield conditions will rarely permit the leader to designate a target direct to all members of his unit by this method. For this reason either pointing or tracers are frequently used in combination with oral description.

b. *Elements of oral target designation.*—The elements of oral target designation are—

- (1) Range.
- (2) Direction.
- (3) Description of target.

These elements are always given in the above sequence with a slight pause between each element. An exception to this rule occurs when the target is expected to be visible for a short time only. In this case the target is pointed out as quickly as possible; for example, such an oral target designation might be, "Those men" (Fig. 54). When the range is announced, men immediately set their sights before looking for the target.

c. *Direction.*—The terms "front" (left, right) and "flank" (left, right) may be used to indicate the general direction of

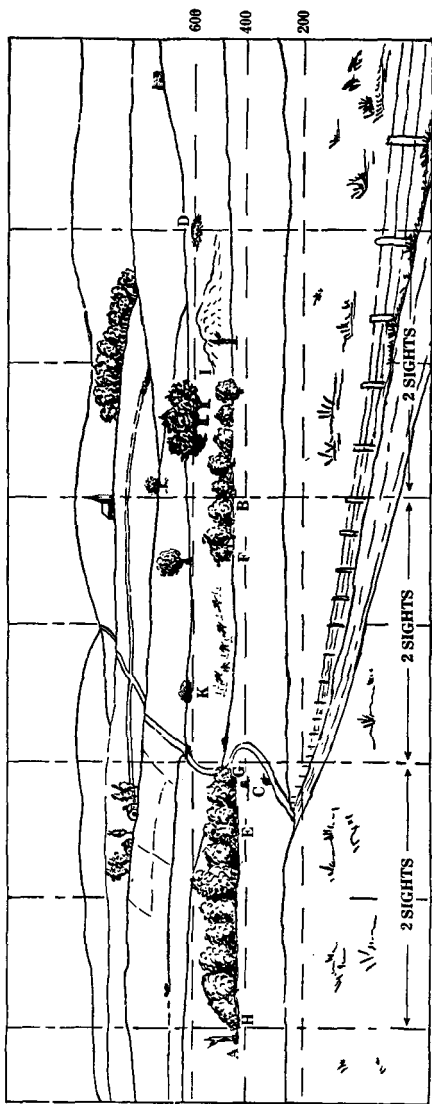

FIGURE 54.

the target. When necessary, the direction is fixed more accurately by methods described hereafter.

d. Simple description.—When the target is plainly visible or at an easily recognized point as illustrated in figure 54, a simple description is used; for example (target at A):

Range: 425.

Left front.

Sniper at base of dead tree.

e. Reference point.—When the target is indistinct or invisible and is not located at some prominent point, the direction of the target is indicated by the use of a reference point. This is an object, preferably a prominent one, by reference to which the location of other points may be determined. In selecting a reference point, care must be taken that another similar object is not mistaken for the one intended. A reference point on a line with the target and beyond it will give greater accuracy than one between the observer and the target. For brevity a reference point is called "Reference."

(1) *When reference point is on line with target.*—The description takes the following form (target at B):

Range: 450.

Reference: church spire.

Target: machine gun in edge of woods.

It will be noted that the range announced is that to the target and not to the reference point. When the word "reference" is used the word "target" is also used to differentiate between the two objects. Another example follows (target at C):

Range: 350.

Left front.

Reference: black stump.

Target: sniper on far side of road.

(2) *When reference point is not on line with target.*—(a) In this, it is necessary to indicate the distance to the right or left of the reference point at which the target is located. This distance is measured in units called "fingers." (See par. 131b.) Suppose the hand is held so that left edge of a finger is on line with the reference point and it is found that the right edge of that same finger is in line with the target, the target is then one finger width to the right of the reference

point and it is announced as "Right, one finger." If two fingers can be applied to the lateral interval between the reference point and target, the target is "Right, two fingers." The following examples illustrate this method:

(Target at D)—

Range: 600.

Reference: church spire; right, two fingers.

Target: group of enemy in shell hole near crest.

(Target at E)—

Range: 425.

Left front.

Reference: dead tree; right, one and one-half fingers.

Target: sniper in edge of woods.

(Target at F)—

Range: 450.

Reference: church spire; left, one-half finger.

Target: machine gun in corner of woods.

(b) The width or extent of targets is also measured in fingers (target G to H):

Range: 425.

Reference: church spire; left, two fingers.

Target: enemy groups in edge of woods extending left, two fingers.

(3) *Successive reference points.*—These may be used instead of finger measurements from one reference point (target at I):

Range: 500.

Reference: church spire; to the right and at a shorter range, group of three trees; to the right and at the same range.

Target: machine gun at left end of mound of earth.

(4) *Combination of successive reference points and sights.*—Example (target at K):

Range: 600.

Reference: church spire; to the left and at a shorter range, lone tree; left one sight and at the same range.

Target: machine gun in clump of brush.

f. Variations.—If one end of a target is considerably nearer than the other, the average range is announced since

dispersion will cover the target. Battlefield conditions will impose many practical substitutions and combinations of methods in target designation. Frequently the squad leader will be able to designate the target to only one or two members of his squad. Therefore, each member of the squad must be taught to assist in designating the targets to other members of the squad team. At times the entire target designation will be furnished by the scouts to other members of the squad as they arrive in the vicinity. Formal, long-winded oral target designation will often confuse more than help.

■ 131. EXERCISES.—*a. No. 1.*—(1) *Purpose.*—To afford practice in target designation by means of tracer bullets.

(2) *Method.*—(a) On a class A or class B range a concealed target representing a machine gun is placed near a pit or other bullet-proof shelter. About 500 yards in front of the target a firing position suitable for a squad is selected. The location of the target will be visible from the firing position, but the target itself may be invisible due to its concealment. This concealment should have a natural appearance in order not to attract attention.

(b) The squad is deployed along the firing position, and all except the scouts are then faced to the rear.

(c) The scouts take the prone position and are told that the waving of a red flag to their front will represent the firing and smoke from the machine gun.

(d) A man stationed in the pit waves a flag in front of the target for about 30 seconds and retires to the protection of the pit.

(e) The squad is faced to the front and men take the prone position. Rifles are loaded while locked, the scouts using tracer ammunition and the remainder of the squad ball cartridges.

(f) The scouts point out the target by firing tracers and announce the range, which is passed orally from man to man.

(g) As soon as each man understands the location of the target he opens fire with the proper sight setting.

(h) The instructor causes firing to cease shortly after all the men are firing.

(i) Noncommissioned officers do not participate in the fire. Squad leaders move about freely behind their men and observe the firing. The second in command assists the squad leader.

(j) After firing ceases, sight settings are checked by the squad leader and the target is examined or the hits are signaled to the squad.

b. No. 2.—(1) Purpose.—To teach the use of fingers for lateral measurement.

(2) *Method.*—(a) A number of short vertical lines 1 foot apart are plainly marked on a wall or other vertical surface. At a distance of 20 feet from the wall a testing line is drawn or marked out by stakes. The instructor explains that the vertical lines are one finger (50 mils) apart when measured from the testing line and are used for the purpose of determining the correct distance from the eye to the fingers, so that each finger covers the space between one of the vertical lines and the next line to the right or left.

(b) The instructor then explains and demonstrates the use of fingers in lateral measurement. First he holds his hand, with palm to rear and fingers pointing upward, at such distance from his eye that each finger will cover the space between one vertical line and the next line to the right or left. Then he lowers his hand to his side without changing the angle of the wrist or elbow and notes the exact point at which the hand strikes the body. Thereafter when measuring with the fingers he first places his hand at this point and raises his arm to the front without changing the angle of the wrist or elbow. His hand will then be in the correct position for measuring fingers. The men then determine the proper distance of fingers from the eye as explained by the instructor.

(c) Practice in lateral measurement using fingers is given, using convenient objects within view.

c. No. 3.—(1) Purpose.—To afford practice in target designation by pointing with the rifle.

(2) *Method.*—(a) The squad is formed faced to the rear. The instructor then points out the target to the squad leader, who takes the kneeling or prone position, estimates the range, adjusts his sight, alines his sights on the target, and then calls "*Ready.*"

(b) The members of the squad then move in turn to a position directly behind the squad leader and look through the sights until they have located the target. The range is given orally by the squad leader to each individual.

(c) As soon as each man has located the target he moves to the right or left of the squad leader, sets his sight, places his rifle on a bayonet rest or sandbag, and alines his sights on the target.

(d) The instructor, assisted by the squad leader, verifies the sight setting and the alinement of the sights of each rifle.

d. No. 4.—(1) Purpose.—To afford practice in target designation by oral description.

(2) *Method.*—(a) The squad is deployed faced to the rear. The squad leader is at the firing point, where sandbags or bayonet rests have been provided for each rifle.

(b) At a prearranged signal the target is indicated by the display of a flag. When the squad leader states that he understands the position of the target, the flag is withdrawn.

(c) The squad is then brought to the firing point, placed in the prone position, and each man is required to set his sight, use the sandbag or bayonet rest, and sight his rifle on the target according to the oral description of the squad leader. The squad leader gives his target designation from the prone position.

(d) The squad leader's designation is checked from the ground. The men are required to leave their rifles on the rests, properly pointed, until checked by the instructor or squad leader.

SECTION IV

RIFLE FIRE AND ITS EFFECT

■ 132. *TRAJECTORY.*—*a. Nature.*—The trajectory is the path followed by a bullet in its flight through the air. The bullet leaves the rifle at a speed of 2,700 feet per second. Because of this great speed the trajectory at short ranges is almost straight or flat.

b. Danger space.—The space between the rifle and the target in which the trajectory does not rise above a man of average height is called the "danger space." The trajectory

for a range of 700 yards does not rise above 68 inches. Therefore, it is said that the danger space for that range is continuous between the muzzle of the gun and the target. For ranges greater than 700 yards, the bullet rises above the height of a man standing, so that only parts of the space between the gun and the target are danger spaces. (Fig. 55.)

■ 133. **DISPERSION.**—Because of differences in ammunition, aiming, holding, and wind effects, a number of bullets fired from a rifle at a target are subject to slight dispersion. The trajectories of those bullets form an imaginary cone-shaped figure called the “cone of dispersion.”

■ 134. **SHOT GROUPS.**—When the cone of dispersion strikes a vertical target it forms a pattern called a “vertical shot group.” A shot group formed on a horizontal target is called a “horizontal shot group.” Due to the flatness of the trajectory, horizontal shot groups on level ground vary in length from 100 to 400 yards, depending upon the range.

■ 135. **BEATEN ZONE.**—The beaten zone is the area on the ground struck by the bullets forming a cone of dispersion. When the ground is level, the beaten zone is also a horizontal shot group. The slope of the ground has great effect on the shape and size of the beaten zone. Rising ground shortens the beaten zone. Ground that slopes downward and in the approximate curve of the trajectories will greatly lengthen the beaten zone. Falling ground with greater slope than the trajectory will escape fire and is said to be in defilade.

■ 136. **CLASSES OF FIRE.**—*a.* Fire as regards direction is classified as follows:

(1) *Frontal.*—Fire delivered on the enemy from his front.

(2) *Flanking.*—Fire delivered on the enemy from his flank.

b. Fire as regards trajectory is classified as follows:

(1) *Grazing.*—Fire approximately parallel to the ground and close enough thereto to strike an object of a given height. The average height of a man is usually taken as the determining factor.

(2) *Plunging.*—Plunging fire is fire in which the angle of fall of the bullets with reference to the slope of the ground is such that the danger space is practically confined to the beaten zone and the length of the beaten zone is

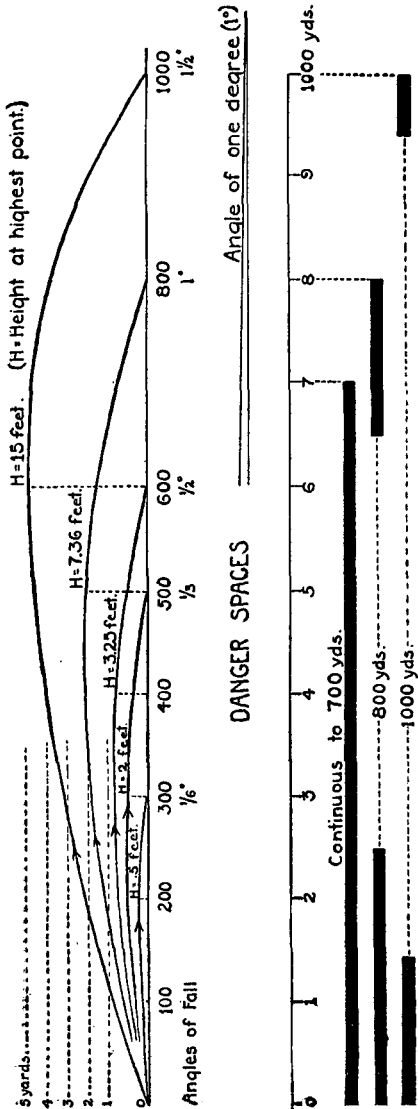

FIGURE 55.—Trajectory diagram (vertical scale is 20 times horizontal scale).

materially lessened. Fires delivered from high ground on ground lying approximately at right angles to the cone of fire, or against ground rising abruptly to the front with respect to the position of the rifle, are examples of plunging fire. As the range increases, fire becomes increasingly plunging because the angle of fall of the bullets becomes greater.

(3) *Overhead*.—Fire delivered over the heads of friendly troops.

c. Comparison.—Flanking fire is more effective than frontal fire. Grazing fire is more effective than plunging fire, because the beaten zone is much longer. Overhead fire with the rifle is unusual and may be employed only when the ground affords protection to the friendly troops.

■ 137. **EFFECT OF FIRE**.—By making use of cover and of the supporting fires of the artillery, mortars, and machine guns, rifle units will get as near the enemy as possible without opening fire. Normally this should be at ranges less than 600 yards. A ricochet is effective if it strikes a man soon after it leaves the ground. Rifle fire is effective and should be used against low-flying planes. The effect of fire on moving targets is covered in chapters 3 and 4. Even though hits can no longer be made, fire may be continued when the moral effect is sufficient to keep the enemy under cover and render his fire ineffective. When opposing forces are entrenched and neither side is trying to advance, fire for moral effect alone is of no value.

■ 138. **EXERCISE**.—*a. Purpose*.—To show trajectories.

b. Method.—The unit under instruction watches the firing of a few tracer bullets at targets whose ranges are announced. Ranges of 300, 600, and 800 yards are suitable selections. The flatness of the trajectories is called to the attention of the men.

SECTION V

APPLICATION OF FIRE

■ 139. **GENERAL**.—*a. Means of action*.—Rifle units have two general means of action, fire and movement. They fight by combining these two means of action. Fire and movement are combined in the combat action of the squad and larger

units. The application of fire by such units is essential to their success.

b. Application of fire.—(1) *In attack.*—The squad and smaller groups must be trained to place a large volume of accurate fire upon probable enemy locations and indistinct or concealed targets such as enemy machine guns or small groups. The squad and smaller groups must be trained to apply such fire quickly upon the order or signal of its leader and in appropriate circumstances to apply it without such order.

(2) *In defense.*—In defense, the fire of a small rifle unit such as a squad is delivered by small groups and individuals from positions which they must hold. They are placed to secure good fields of fire and to take advantage of cover and concealment.

c. Requirements of position.—In the occupation of a firing position, the location of squads in the platoon area should be made with due regard to the following requirements. When these requirements conflict, it is the duty of leaders to weigh the importance of each and make the best dispositions possible under the conditions.

- (1) Good field of fire to the front.
- (2) Use of cover and concealment.
- (3) An indefinite and inconspicuous formation which will suit the terrain and be hard to see.
- (4) Control of fire by unit leader.

■ 140. **CONCENTRATED AND DISTRIBUTED FIRE.**—The size and nature of the target presented may call for the firepower of the entire group or only certain parts. The fire of a group must necessarily be either concentrated or distributed fire.

a. Concentrated fire.—Concentrated fire is fire directed at a single point. This fire has great effect but only at a single point. Machine guns and other automatic weapons are examples of suitable targets for concentrated fire.

b. Distributed fire.—(1) Distributed fire is fire distributed in width for the purpose of keeping all parts of the target under effective fire. It is habitually used on targets having any considerable width.

(2) The method of fire distribution employed by a squad is as follows: Each rifleman fires his first shot on that portion

of the target corresponding generally to his position in the squad. He then distributes his remaining shots to the right and left of his first shot, covering that part of the target on which he can deliver accurate fire without having to change position. The amount of target each rifleman can cover will depend upon the range and the position of the firer. In some cases each rifleman will be able to cover the entire target with accurate fire. Fire is not limited to points known to contain an enemy; on the contrary, riflemen space their shots so that no portion of the target remains unmolested. This method of fire distribution is employed without command. It enables squad leaders to distribute the fire of their units so as to cause the entire target to be kept under fire. (See fig. 56.)

(3) If a squad is employing this method of fire distribution and other targets appear, the squad leader announces such changes in the fire distribution as are necessary.

(4) If engaging the same target, all squads of the platoon distribute fire in the same manner.

■ 141. ASSAULT FIRE.—Assault fire is fire delivered by the unit while advancing at a walk. Riflemen halt individually and aim and fire standing. They go forward a few steps, halt, and fire again. They load while advancing. Men equipped with bayonets fix them before taking up the assault fire.

■ 142. RATE OF FIRE.—The soldier fires at the rate of fire most effective under existing conditions. To exceed this rate is a waste of ammunition.

■ 143. FIRE DISCIPLINE.—*a.* Fire discipline implies the careful observance of the instructions relative to the use of the rifle in combat and exact execution of the orders of the leader. When fire discipline is good, men fight as they have been trained to fight and obey orders promptly and carefully; they resist and overcome the influence of danger, excitement, and confusion. Fire discipline is necessary for proper control by leaders, and upon this control depend teamwork and effectiveness of the collective fire of the unit. The training necessary to insure good fire discipline cannot be completed during the brief period devoted to technique of fire. Training in fire discipline starts with the soldier's first

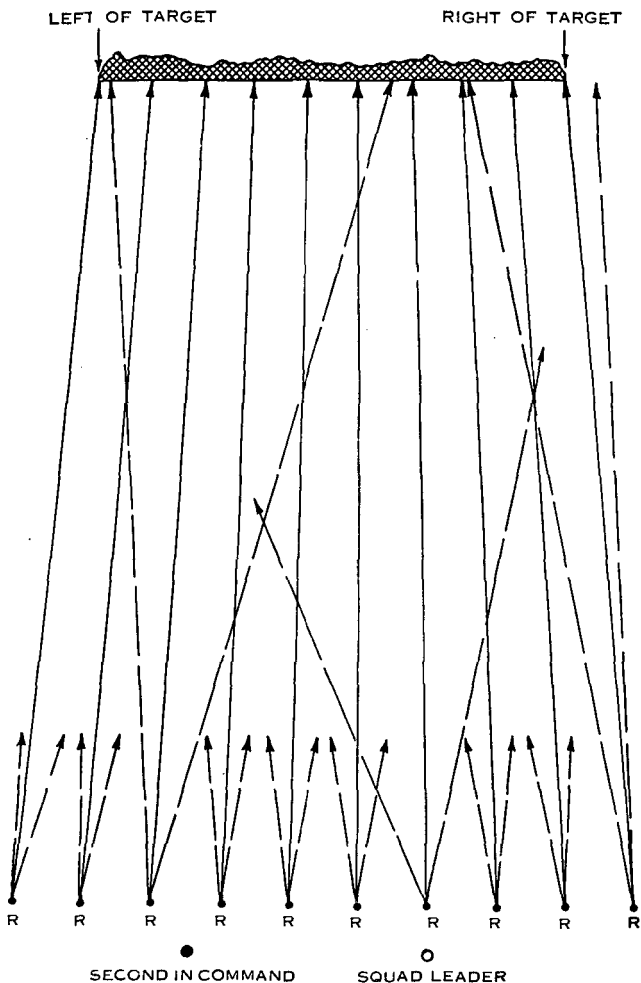

FIGURE 56.—Fire distribution of squad.

NOTE.—Solid lines indicate direction of fire for first shot; broken lines illustrate sectors of fire.

drill and continues throughout his military training. Any drill or exercise which develops alertness and the habit of obedience or other soldierly qualities will aid in developing the character essential to fire discipline.

b. Fire discipline is maintained by leaders chiefly by their example of coolness and courage. Replacement of casualties is an element of fire discipline which keeps the unit working as a team in spite of losses. If any group of individuals find themselves without a leader, it is essential that one of them assume leadership of the group and carry out its mission or attach it to the nearest organized unit. An individual separated from his squad fights on his own initiative only when he has reason to believe that his single effort will accomplish some important result. Otherwise he reports to the nearest leader at once.

c. Fire discipline in the squad is the responsibility of the squad leader; he is assisted by the second-in-command. The position of the squad leader during the fire fight will be where he can best control his squad. The second-in-command will be where he can best assist the squad leader.

■ 144. FIRE CONTROL.—*a. General.*—Fire control pertains to the squad or smaller group. Its application to the platoon as a whole will be exceptional. Fire control consists of the initiation and supervision of the fire of the squad or smaller group by its leader. By initiating such fire on order or signal the full effect of surprise can be secured. On the other hand the irregular formations adopted for an advance will often render such action impracticable. In such case fire must be opened and maintained on the initiative of individuals as circumstances require. In any case the leader of the squad or smaller group must supervise and seek to control the fire of his men so that it is directed and maintained at suitable targets. All must understand that controlled fire is always the most effective.

b. How exercised.—Squad leaders, assisted by their seconds-in-command, exercise fire control by means of orders, commands, and signals. The signals most frequently used are—

Signals for range.

Commence firing.

Fire faster.

Fire slower.

Fire at will.

Cease firing.

Are you ready?

I am ready.

Fix bayonets (if appropriate).

■ 145. FIRE ORDERS.—*a. Purpose.*—The leader of a rifle fire unit or group of riflemen having made a decision to fire on a target must give certain instructions as to how the target is to be engaged. The instructions by which the fire of a squad is directed and controlled form the fire order.

b. Basic elements.—A fire order contains three basic elements, which are announced or implied in every case. Only such elements or parts thereof will be included as are essential. The sequence is always as follows:

Target-designation element.

Fire-distribution element.

Fire-control element.

(1) *Target-designation element.*—The target may be designated by any one or a combination of the prescribed methods. (See pars. 125 to 131, incl.)

(2) *Fire-distribution element.*—The fire-distribution element is normally omitted from the fire order to fire units. The method of fire distribution described in paragraph 140*b* is employed habitually in the absence of instructions to the contrary. When necessary, the fire-distribution element includes the subdivision of the target. For example—

(a) A squad leader desires to engage two machine-gun nests; the distribution element of his order might be as indicated by the italic words below:

Range: 500.

Front.

Machine gun at base of lone pine.

Cooper, Emerson, Crane, Hines, Jones, your target.

Range: 500.

Left flank.

Machine gun at base of haystack.

Brown, Smith, Turner, Howard, Stone, your target.

(b) The squad leader may engage two targets by placing half of the squad under the command of the assistant squad

leader and directing him to engage one target, while he engages the other target with the other half of the squad.

(3) *Fire-control element*.—The fire-control element normally consists initially of merely the command or signal COMMENCE FIRING OR FIRE AT WILL. It may include the number of rounds. Other fire-control elements are—

AT MY SIGNAL (followed by hand signal).

EIGHT ROUNDS, COMMENCE FIRING, OR FIRE AT WILL.

c. Example.—An example of a complete fire order follows:

(1) *Target-designation element*.

(Range) Range: 600.

(Direction) Reference: right edge of lone building; right, one finger.

(Description of target) Target: group of enemy.

(2) *Fire-distribution element*.—(Implied.)

(3) *Fire-control element*.—COMMENCE FIRING OR FIRE AT WILL.

■ 146. DUTIES OF LEADERS.—The following summary of duties of leaders relates only to their duties in the technique of fire:

a. Squad leader.—(1) Carries out orders of platoon leader.

(2) Selects firing positions for squad.

(3) Designates targets and issues fire orders.

(4) Controls fire of squad.

(5) Maintains fire discipline.

(6) Observes targets and effect of fire.

b. Second-in-command.—(1) Carries out orders of squad leader.

(2) Assists squad leader to maintain fire discipline.

(3) Assumes command of squad in absence of squad leader.

(4) Participates in firing when the fire of his rifle is considered more important than other assistance to the squad leader.

SECTION VI

LANDSCAPE-TARGET FIRING

■ 147. SCOPE AND IMPORTANCE.—*a.* After satisfactory progress has been made in the preceding steps, the soldier may be given practice in the application of those lessons by firing at landscape targets.

b. The advantages of this training are as follows:

(1) The immediate supervision over all members of the firing unit made possible by their close proximity. The instruction is therefore more individual than would be otherwise possible.

(2) The accessibility and nature of the targets permit the application and effect of the fire to be shown in a minimum of time.

(3) This form of instruction lends itself to indoor training when lack of facilities or weather conditions make it desirable.

c. In circumstances where there is a choice between landscape-target firing as covered in this section and field-target firing as covered in section VII, the latter is to be preferred. Firing at landscape targets is therefore not required as a part of training.

■ 148. DESCRIPTION OF TARGET.—A landscape target is a panoramic picture of a landscape and is of such size that all or nearly all of the salient features will be recognizable at a distance of 1,000 inches. The standard target is the series A target of five sheets in black and white.

■ 149. WEAPONS TO BE USED.—Firing at landscape targets should be with caliber .22 rifles, preferably, the M1922M2 equipped with the Lyman receiver sight. When a sufficient number of those rifles are not available, the caliber .30 M1 rifles may be used.

■ 150. PREPARATION OF TARGETS.—*a. Mounting.*—(1) The target sheets are mounted on frames made of 1- by 2-inch dressed lumber, with knee braces at the corners. The frames for the target sheets are 24 by 60 inches. These frames are covered with target cloth which is tacked to the edges.

(2) The target sheets are mounted as follows: Dampen the cloth with a thin coat of flour paste and let it dry for about an hour; apply a coat of paste similarly to the back of the paper sheet and let it dry about an hour; apply a second coat of paste to the back of the paper and mount it on the cloth; smooth out wrinkles, using a wet brush or sponge, and work from the center to the edges. The frame

must be placed on some surface which will prevent the cloth from sagging when the paper is pressed on it. A form for this purpose can easily be constructed. It must be of the same thickness as the lumber from which the frames are built, and must have approximately the same dimensions as the aperture of the target frame.

b. Target frames.—Panels mounted as described above are set in a vertical frame consisting of posts (about 4 by 4 inches) of sufficient height, placed upright in the ground, 5 feet from center to center, with horizontal pieces of 2 by 4 inches to support the panels, braced to insure stability. The panels are supported by cleats and dowels in order to allow for easy removal.

c. Range indicators.—In order to make all elements of target designation complete, assumed ranges must be used on landscape targets. Small cards on which are painted appropriate numbers representing yards of range are tacked along one or both edges of a series of panels. The firers must be cautioned that the range announced in any target designation is for the sole purpose of designating the target, and that the sight setting necessary to zero their rifles must not be changed.

d. Direction cards.—In order to provide the direction element in oral target designation, small cards on which are painted Front, Right front, Left front, Right flank, Left flank are tacked above the appropriate panels of the landscape series.

e. Scoring devices.—(1) A squad may be brought up to the target and there view the results of its firing. Scoring the exercises will tend to create competition between squads and will enable the instructor to grade their relative proficiency. A scoring device conforming in size to the 50- and 75-percent shot groups to be expected of average shots firing at 1,000 inches and at reduced ranges can easily be made from wire, or a better one may be prepared by imprinting a scoring diagram on a sheet of transparent celluloid. The scoring space is outlined on the target in pencil before the target is shown to squad leaders. This procedure prevents any misunderstanding of squad leaders as to the limits of the desig-

nated target. Upon completion of firing, the entire squad is shown the target and the results of the firing.

(2) While shot groups are in the form of a vertical ellipse, the 50- and 75-percent zones should be shown by the devices as rectangles. This is for convenience in their preparation. For a distance of 1,000 inches, the 50-percent zone is a rectangle $2\frac{1}{2}$ inches high by 2 inches wide; the 75-percent rectangle is 5 inches high by 4 inches wide. For a distance of 50 feet, the 50-percent zone is a rectangle $1\frac{1}{2}$ inches high by 1.2 inches wide; the 75-percent rectangle is 3 inches high by 2.4 inches wide. The target is at the center of the inner rectangle or 50-percent zone.

(3) For a linear target, such as a small area over which the riflemen will distribute their fire, the 50-percent zone is formed by two lines drawn parallel to the longer axis of the target (area) and with the target midway between those lines. For a distance of 1,000 inches the lines should be $2\frac{1}{2}$ inches apart; for a distance of 50 feet the lines should be $1\frac{1}{2}$ inches apart. Two additional lines, similarly drawn, form the 75-percent zone. For a distance of 1,000 inches the lines should be 5 inches apart; for a distance of 50 feet the lines should be 3 inches apart. The width of the zones will vary according to the size of the target selected. For a distance of 1,000 inches the zones extend 1 inch beyond each end of the target; for a distance of 50 feet the zones extend 0.6 inch beyond each end of the target. The zones are then divided into a convenient number of equal parts, the number depending on the length (width) of the target and the number of men firing. This is done in order to give a score for distribution of shots fired on a linear target (see par. 153b).

■ 151. ZEROING-IN OF RIFLES.—*a.* It will be necessary to zero-in the rifles used before firing exercises on the landscape target. A blank target with a row of ten 1-inch-square black pasters about 6 inches from and parallel with the bottom edge of the target should be prepared and used for this purpose. In all firing for zeroing-in, sandbag rests are used.

b. The procedure in detail is as follows:

(1) The sights of the rifles are blackened.

(2) The squad is deployed on the firing points; the squad leader takes the proper position in rear of the squad.

(3) The instructor causes each firer to set his sights at zero elevation and zero windage, or 200 yards and zero windage for the caliber .30 M1 rifle, and checks each sight.

(4) Each man is assigned the particular small black paster which corresponds to his position in the squad as his aiming point.

(5) Three rounds are issued to each man on the firing point to be loaded and fired singly at the command of the instructor.

(6) Each man fires three shots at his spotter at the command **THREE ROUNDS, COMMENCE FIRING.**

(7) The instructor commands: **CLEAR RIFLES.** The squad leader checks to see that this is done.

(8) The instructor and squad leader inspect the target and, based upon the location of the center of impact of the resultant shot group, give each man the necessary correction for his next shot; as for the caliber .22 rifle, "Up 1 minute, right $\frac{1}{2}$ point;" or for the caliber .30 M1 rifle, "Up 3 clicks, left 1 click."

(9) The firing continues as outlined above until all rifles are zeroed-in, that is, until each man has hit his aiming point.

c. For a caliber .22 rifle with the Lyman receiver sight, at a distance of 1,000 inches, a change of 5 minutes in elevation will move the strike of the bullet about $1\frac{1}{2}$ inches. A change of one point of windage moves the strike about $1\frac{1}{4}$ inches. At a distance of 50 feet, a change of 6 minutes in elevation will move the strike of the bullet about 1 inch, and a change of one point of windage, about $\frac{3}{4}$ inch. For the caliber .30 M1 rifle, at a distance of 1,000 inches, changes of 1 click in elevation and 1 click of windage move the strike of the bullet about $\frac{1}{4}$ inch in each direction. At a distance of 50 feet, a change of 1 click in elevation and 1 click of windage will move the strike of the bullet about $\frac{1}{6}$ inch in each direction.

■ **152. FIRING PROCEDURE.**—The sequence of events in conducting firing exercises is as follows:

a. All members of the squad except the squad leader face to the rear.

b. The instructor takes the squad leader to the panels and points out the target to him.

c. They return to the firing point; the squad leader takes charge of the squad and causes the men to resume their firing positions.

d. The squad leader gives the command **LOAD**, cautioning, "— rounds per rifleman only." If less than eight rounds are to be fired with the caliber .30 M1 rifle, cartridges will be loaded singly.

e. The squad leader designates the target orally. Reference to panels to indicate direction should not be allowed in the designation. To complete the fire order, the squad leader adds: **COMMENCE FIRING**.

f. When the squad has completed firing, the squad leader commands: **CEASE FIRING, CLEAR RIFLES**. The squad then examines the target. The target panel is scored and marked with the squad number.

g. The instructor holds a short critique after each exercise.

■ 153. **SCORING**.—*a. Concentrated fire*.—In concentrated fire, the sum of the value of the hits within the two zones is the score for the exercise. For convenience of scoring and comparison, 100 is fixed as the maximum score. Any method of scoring and of distribution of ammunition among members of the squad may be used. The following examples based on firing 50 rounds are given as suggested methods:

(1) Value of each hit in 50-percent zone, 2.

(2) Value of each hit in 75-percent zone, 1.

b. Distributed fire.—A method of scoring for distributed fire of the squad on a target of width is as follows:

(1) Value of each hit in 50-percent zone, 2.

(2) Value of each hit in 75-percent zone, 1.

(3) Value of each distribution space (if target is divided into 10 equal spaces), 10.

(4) The score for distribution plus the value of all hits, divided by two is the score for the exercise.

■ 154. **EXERCISES**.—*a. (1) No. 1*.—*(a) Purpose*.—To teach target designation and to show the effect of concentrated fire.

(b) Method.—The squad leader employs the fire of his squad at one point target indicated to him by the instructor.

(2) *No. 2.*—(a) *Purpose.*—To teach target designation and the division of the squad fire on two points of concentration.

(b) *Method.*—The instructor indicates two point targets to the squad leader giving the nature of each. The squad leader applies the fire of his squad on the two targets in the proportions directed by the instructor. The scoring will be as for concentrated fire on each target, the several scores being combined in totals for the score of the exercise.

(3) *No. 3.*—(a) *Purpose.*—To teach target designation and fire control in diverting part of the fire of the squad to a suddenly appearing target.

(b) *Method.*—The instructor indicates a point target to the squad leader. After firing has commenced, the instructor indicates and gives the nature of a new target to a flank. The squad leader applies the fire of his squad to the first target. When the second target is indicated, he shifts the fire of the number of riflemen, as directed by the instructor, from the first to the second target.

(4) *No. 4.*—(a) *Purpose.*—To teach the application of fire on an enemy group marching in formation, the fire control necessary to obtain fire for surprise effect, and to show the effect of fire on troops in formation.

(b) *Method.*—The instructor indicates to the squad leader a target that represents a small group of the enemy marching in approach march formation, formation for patrol, or the like; the enemy not being aware of the presence of the squad. The squad leader applies the fire of his squad; his instructions must result in the simultaneous opening of fire of all weapons and the distribution of fire over the entire target. The assignment of half the number of riflemen to fire at the rear half of the target, and the remaining riflemen at the forward half, is a satisfactory method of distributing fire over such target.

b. The second-in-command of the squad will be given instruction and practice in the same type of exercises as outlined in *a* above.

SECTION VII

FIELD-TARGET FIRING

■ 155. SCOPE OF TRAINING.—The training in this phase is similar to that given the soldier in landscape-target firing, but with the added features of the use of cover, range estimation, firing the caliber M1 rifle with ball ammunition at field targets at unknown ranges, and fire control under more difficult conditions. Training must be progressive, the soldier first being given an opportunity to fire at more or less exposed targets, followed by fire at targets which are concealed from view but exposed to fire. Individuals should preferably receive this training in the squad or in smaller groups.

■ 156. TERRAIN, TARGETS, AND RANGES.—*a. Terrain.*—(1) The availability of ground and considerations for safety determine the selection of terrain for field firing ranges. Where possible, varied ground suitable for the employment of all weapons of the rifle company will be selected. It is a great advantage from the instructional standpoint to use ground that is unfamiliar to the unit to be trained.

(2) In the absence of other facilities, the known-distance ranges can be used by arranging the exercises so that they will begin off the range and require the delivery of fire on the range and in a safe direction.

b. Targets.—(1) Targets may be improvised from available material or they may be obtained from the Ordnance Department.

(2) With the field targets furnished by the Ordnance Department a stationary target may be represented by E or F targets placed on staves and driven in the ground.

(3) A surprise target that can appear and disappear may be made by using either E or F targets fastened to an I-beam and operated by a man in a pit.

(4) A movable field target may be made by fastening E or F targets to a sled.

(5) In the field, targets should be placed in locations that would be used by an intelligent enemy. They should not be prominently exposed nor in a regular line. The exposure of targets kept out of sight at the beginning of an exercise

may be indicated by the firing of blank ammunition or the operation of other noise or smoke-producing equipment in the vicinity of the target when it does appear. In platoon problems, targets may be placed so as to be visible with field glasses, but entirely invisible to the naked eye so that skill is necessary in designating the target and adjusting the fire.

(6) The appearance of the targets from the firing line will depend a great deal upon the direction of the sun, the background of the targets, and the angle at which the targets are placed. These factors should be taken into consideration when placing the targets for any particular exercise.

c. Ranges.—(1) *Shelter.*—(a) Ranges for field firing exercises can be efficiently operated without an elaborate system of shelters and dugouts. Simple pits to accommodate the target operators are sufficient.

(b) Every effort should be made to avoid altering the natural appearance of the terrain when locating and constructing pits.

(c) When targets are placed in the rear or to one side of the pits, the likelihood of ricochets falling into the pit is minimized.

(2) *Safety.*—(a) In general the safety precautions used at known-distance ranges apply with equal force to instruction in firing at any field target (see AR 750-10). Safety of personnel is of primary importance in conducting exercises which require the firing of ball ammunition. To this end, exercises should be drawn to conform to the state of training of the units concerned.

(b) The officer in charge of an exercise is responsible for the safety of the firing; it is his duty to initiate and enforce such precautions as he deems necessary under existing conditions. No other officer can modify his instructions without assuming the responsibility for the safety of the firing.

(c) Firing will not start until it has been ascertained that the range is clear, pit details are not exposed, and *all safety precautions complied with*. Upon completion of firing, the officer in charge will cause all rifles to be unloaded, inspected, and ammunition collected.

(d) During the firing of exercises, rifles will be pointed in the direction of the target at all times. Special vigilance

is required to enforce this rule while men are using a cleaning rod to remove any obstruction from the chamber.

(e) Special precautions should be taken to insure that the range is clear before ammunition is issued.

(f) Upon completion of the day's firing, rifles and belts should be inspected by an officer to insure that no ammunition remains in the possession of the men returning to camp or barracks.

■ 157. GENERAL CONSIDERATIONS.—*a. Progressive training.*—

The inclusion of the training in moving from an approach march formation or place of concealment to firing positions is, primarily, to teach the soldier the proper use of cover and selection of firing positions, and to combine the technique of applying and controlling collective fire with scouting and patrolling and other prerequisite allied subjects.

b. Firing positions and representation of enemy.—In battle a unit is not deployed with individuals abreast and at regular intervals apart. The selection of individual and group positions is governed by the field of fire, cover or concealment while firing, cover of approach to those positions, fire control, and nature of target. The representation of the enemy will conform to irregular battle formations.

c. Use of cover.—(1) The use of available cover is important for two reasons. The man who neglects the use of cover will be seen and hit. His squad not only loses the fire effect of one rifle, but its position is unnecessarily disclosed and other casualties may follow.

(2) The individual use of cover and concealment is taught in FM 21-45 (now published as ch. 9, BFM, vol. I). In training in firing at field targets the principles are the same.

(3) In seeking cover in a firing position, men may move a few yards in any direction, but they must not be allowed to bunch together behind concealment which does not afford protection from fire. They avoid positions which will mask the fire of others or cause their own fire to be dangerous to other men of their unit.

d. Marksmanship applied.—(1) The principles of rifle marksmanship are followed in this training insofar as they fit the conditions.

(2) These principles should be applied to the technique of fire and to combat in a common-sense way. It should be appreciated that the conditions encountered in combat situations will differ from those found on the target range. On the target range the soldier is expressly prohibited from resting his rifle against an unauthorized rest while firing. In this phase of training and in battle the soldier takes advantage of trees, rocks, or any other rest which will make his fire more accurate. The positions prescribed in rifle marksmanship are used whenever the ground will permit, but on rough ground it is often necessary to modify them in order to get a comfortable and steady position. The loop sling is preferable except—

(a) In the standing position.

(b) When the situation requires readiness for immediate use of the bayonet.

(c) In emergencies demanding immediate fire without time for adjustment of the loop sling.

e. Use of the battle sight.—The battle sight is a sight setting of 300 yards. It is used on targets from 0 to 600 yards when time is lacking for setting the sight or in firing at moving targets. By keeping the sight habitually set at 300 yards when not in use, the soldier has the sight set for emergencies.

SECTION VIII

FIRE EXERCISES

■ 158. GENERAL.—*a.* Exercises for firing at field targets should be suitable to the actual terrain upon which they are conducted. One or more exercises will be fired with the gas mask adjusted.

b. Each exercise should be initiated by a unit either—

(1) Already deployed in a firing position;

(2) Halted in approach march formation or in a place of concealment with scouts present in formation, the unit either acting alone or as part of a larger force; or

(3) Advancing in approach march formation with scouts out.

c. (1) In the first case each man should be in a selected firing position, special attention being paid to individual cover and concealment.

(2) In the second case squad leaders conduct their squads forward by covered routes and send the riflemen to their firing positions by individual directions. Occupation of the initial firing position of a unit is done with the minimum of exposure.

(3) In the third case the advance of the scouts must be checked by assumed enemy fire when they are in the vicinity of a suitable location for a firing position for the squad; otherwise, to insure the safety of the personnel taking part in the exercise, they may have to be withdrawn from the exercise before firing is begun by the squad.

■ 159. **CRITIQUE.**—At the completion of the firing of any exercise the instructor should conduct a critique of that exercise with the firing unit. A suggested form for such a critique is as follows:

- a. Purpose of the exercise.
- b. Orders of squad leaders.
- c. Approach and occupation of the firing position (individual concealment and cover).
- d. Action of individuals.
- e. Rate of fire.
- f. Fire control.
- g. Effect of the fire (upon completion of firing, the range being clear, the targets are scored).

■ 160. **EXERCISES.**—*a. No. 1.*—(1) *Purpose.*—Practice in fire orders, application of the fire of a squad in position, fire control, proper individual concealment in the occupation of the firing position.

(2) *Method.*—Enemy represented by one group of targets exposed to fire but partially concealed from view; requiring a simple fire order. Squad leader is shown the targets (personnel with flag) and safety limits for firing position of the squad. When the squad leader fully understands the location and nature of the target and the instructor informs him that the range is clear, he will load ball ammunition, give the fire order, and fire the problem. The range should be estimated by eye and the target designated by oral description.

b. No. 2.—(1) *Purpose.*—Practice in fire orders, application of the fire of a rifle squad on a linear target, fire control,

proper deployment and individual concealment in the occupation of the firing position, engagement of a surprise target.

(2) *Method*.—Silhouette targets, representing an enemy squad deployed in a firing position, are partially concealed from view but exposed to fire. A screen behind the targets is marked with distribution spaces to give squad credit for the shots that did not hit the targets but which would have had an effect on an enemy. Squad is in rear of the firing position; squad leader (scouts) is shown the linear target (by flag) and then conducts squad forward and disposes it in a concealed firing position. When squad leader is told the range is clear he will engage the target with fire. A surprise target, well to the flank of the first target, representing an enemy machine gun, appears shortly after the squad has engaged the linear target. The squad leader is told the amount of fire to shift to the surprise target. In addition to the suggested form of critique in paragraph 159, proper distribution of the fire of a rifle squad on a linear target and the engagement of the surprise target should be discussed.

c. No. 3.—(1) *Purpose*.—Practice in target designation by scouts with tracer ammunition and in teaching how to approach and assume a firing position for a squad.

(2) *Method*.—The squad is marching in approach march formation with both scouts well in advance. When the scouts reach the firing position they observe the targets representing an enemy group about 400 yards to their front. They determine the range by firing on the target with tracer bullets. The squad leader conducts his squad forward, establishes the men in firing positions, and engages the targets with the proper class of fire after the targets have been designated by the scouts by the use of tracers. Special attention is paid to the use of cover and concealment by all men while moving up and during the selection and occupation of positions.

d. No. 4.—(1) *Purpose*.—Practice in firing at moving targets.

(2) *Method*.—Riflemen fire individually at targets carried on long sticks by men in the pits of a class A range. The men in the pits are each assigned a space, the width of about five regular range-target spaces, in which they walk continu-

ously back and forth. By whistle signal, targets are exposed to the firing line for 5 seconds and then concealed for 5 seconds. Targets are exposed once for each shot to be fired. On the firing line one man is assigned to each target. Ranges of 200 or 300 yards are best suited for this class of firing.

e. No. 5.—(1) Purpose.—Practice in the application of rifle fire over a small area in which an enemy is concealed.

(2) Method.—Targets are placed within a small area exposed to fire but concealed from view. The squad is directed to search that area with fire. Fire is distributed throughout the length and breadth of the area using a rapid rate of fire.

CHAPTER 6

ADVICE TO INSTRUCTORS

	Paragraphs
SECTION I. General	161
II. Mechanical training.....	162
III. Marksmanship; known-distance targets.....	163-178
IV. Marksmanship; air targets.....	179-183
V. Technique of fire.....	184-190

SECTION I

GENERAL

■ 161. PURPOSE.—The provisions of this chapter are to be accepted as a guide and will not be considered as having the force of regulations. They are particularly applicable to emergency conditions when large bodies of troops are being trained under officers and noncommissioned officers who are not thoroughly familiar with approved training methods.

SECTION II

MECHANICAL TRAINING

■ 162. CONDUCT OF TRAINING.—*a.* As a general rule instruction is so conducted as to insure the uniform progress of the unit.

b. The instructor briefly explains the subject to be taken up and demonstrates it himself or with a trained assistant.

c. The instructor then causes one man in each squad or subgroup to perform the step while he again explains it.

d. The instructor next causes all members of the squads or subgroups to perform the step, checked by their non-commissioned officers. This is continued until all men are proficient in the particular operation, or until those whose progress is slow have been placed under special instructors.

e. Subsequent steps are taken up in like manner during the instruction period.

SECTION III

MARKSMANSHIP; KNOWN-DISTANCE TARGETS

■ 163. GENERAL.—*a.* Training is preferably organized and conducted as outlined in paragraphs 54 and 55. Officers should generally be considered as the instructors of their units. As only one step is taken up at a time, and as each step begins with a lecture and a demonstration showing exactly what to do, the trainees, although not previously instructed, can carry on the work under the supervision of the instructor.

b. It is advisable that battalions or smaller units be relieved from routine garrison duty during the period of preparatory marksmanship training and range practice.

■ 164. PLACE OF ASSEMBLY FOR LECTURES.—Any small ravine or cup-shaped area makes a good amphitheater for giving the lecture in case no suitable building is available.

■ 165. ASSISTANT INSTRUCTORS.—*a.* It is advantageous to have all officers and as many noncommissioned officers as possible trained in advance in the prescribed methods of instruction. When units are undergoing marksmanship training for the first time, this is not always practicable nor is it absolutely necessary. A good instructor can give a clear idea of how to carry on the work in his lecture and demonstration preceding each step. In the supervision of the work following the demonstration, he can correct any mistaken ideas or misinterpretations.

b. When an officer in charge of rifle instruction (see par. 55 *d*) is conducting successive organizations through target practice, it is advisable to attach to the first organization taking the course officers and noncommissioned officers of the companies that are to follow for the period of preparatory work and for a few days of range firing. These act as assistant instructors when their own companies take up the work. Such assistants are particularly useful when one group is firing on the range and another is going through the preparatory exercises, both under the supervision of one instructor.

■ 166. EQUIPMENT.—The instructor should personally inspect the equipment for the preparatory exercises before the training begins. A set of model equipment should be prepared in advance by the instructor for the information and guidance of the organization about to take up the preparatory work. The sighting bars must be made as described, and the hole representing the peep sight must be absolutely circular. If the sights are made of tin the holes should be bored by a drill. Good rear sights can be made for the sighting bars by using cardboard and cutting the holes with a punch for cutting wads for 10-gage shotgun shells. Bull's-eyes painted on a white disk are not satisfactory. Bull's-eyes cut out of black paper with a shotgun-wad cutter and pasted on white paper make satisfactory aiming points either to paste on the face of the disk or to use in position and trigger-squeeze exercises, when small gallery targets are not available for this purpose.

■ 167. INSPECTION OF RIFLES.—No man is required to fire with an unserviceable or inaccurate rifle. All rifles should be carefully inspected far enough in advance of the period of training to permit organization commanders to replace all inaccurate or defective rifles. Rifles having badly pitted barrels are not accurate and should not be used.

■ 168. AMMUNITION.—The best ammunition available should be reserved for record firing, and the men should have a chance to learn their sight settings with that ammunition before record practice begins. Ammunition of different makes and of different lots should not be used indiscriminately.

■ 169. ORGANIZATION OF WORK.—*a. In preparatory training.*—(1) The field upon which the preparatory work is to be given should be selected in advance and a section of it assigned to each organization. The equipment and apparatus for the work should be on the ground and in place before the morning lecture is given, so that each organization can move to its place and begin work immediately and without confusion.

(2) Each company should be organized in two lines facing away from each other. In this way the officers and other

instructors, whose position is normally between the lines, have all of their squads under close supervision. In figure 57 the groups represented consist of 8 men each.

(3) The arrangement of the equipment is as follows:

(a) On each line are placed the sighting bars and rifle rests at sufficient intervals to permit efficient work.

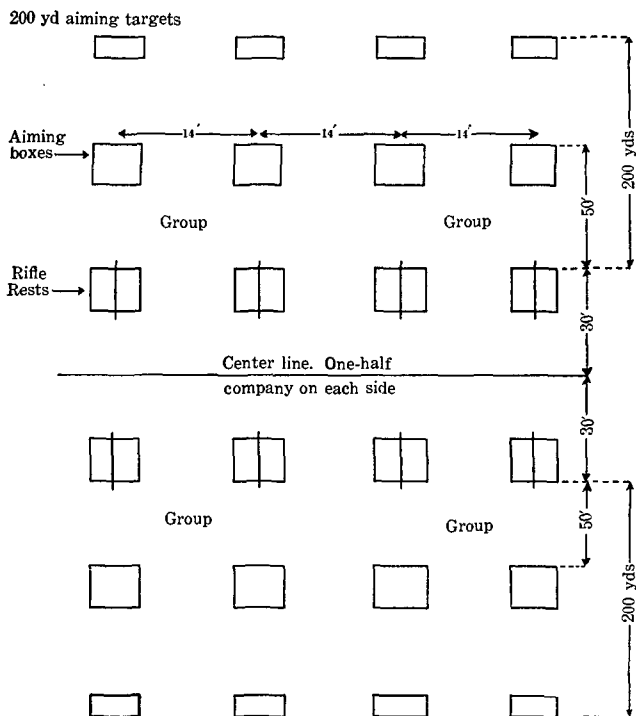

FIGURE 57.—Portion of field laid out for sighting and aiming exercises.

(b) Fifty feet from each line is placed a line of small boxes with blank paper tacked on one side, one box and one small sighting disk to each rifle rest.

(c) Two hundred yards from each line is placed a line of frames suitable for 200-yard shot group exercises, one

frame to each squad. These frames have blank paper tacked or pasted on the front. A 10-inch sighting disk is placed with each frame. Machine-gun targets make acceptable frames for this work.

(4) In position, trigger-squeeze, and rapid-fire exercises targets should be placed at 1,000 inches and 200 yards. The groups represented in figure 58 consist of 8 men each.

(5) When sufficient level ground is not available for the above arrangement, the organizations will have to vary from

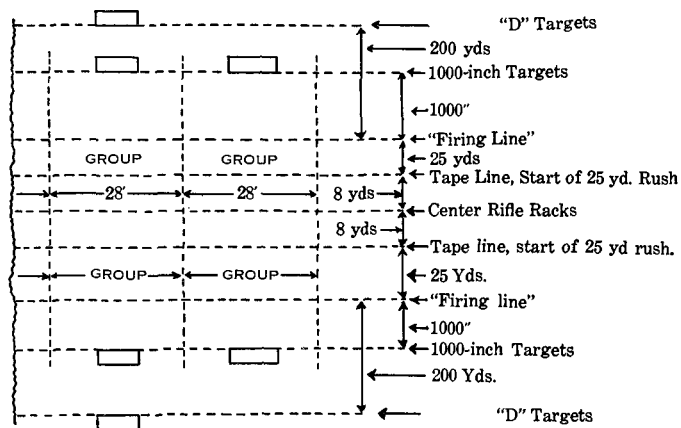

FIGURE 58.—Portion of field laid out for position, trigger squeeze, and rapid fire exercises.

it in some particulars. It will usually be found, however, that all of the work except the long-range shot group work can be carried on in two lines.

b. In range practice.—(1) The range work should be so organized that there is a minimum of lost time on the part of each man. Long periods of inactivity while awaiting a turn on the firing line should be avoided. For this reason the number of men on the range should be accommodated to the number of targets available.

(2) As a general rule six men per target are about the maximum and four men per target the minimum for efficient handling.

(3) Subject to ammunition allowances the following method of carrying on range practice has been found to produce uniformly excellent results when the full allowance of time is devoted to the training:

(a) Firing is begun by a group consisting of approximately half of each organization. This group is made up of those proved to be the best by the examination on preparatory work and those known to be good shots. The men who are not included in this first group make up all fatigue details and undergo additional preparatory training.

(b) At the completion of instruction practice, all of the first group, except those few who have not been shooting well, fire for record.

(c) When the first group has completed firing, the second group, made up of those who have not fired and those who were rejected from the first group, begin their firing. The men who have completed record firing perform all fatigue.

(d) At the completion of instruction practice, all of this second group who have been shooting well and have a very good chance to qualify fire for record.

(e) During the remainder of the allotted time the efforts of the officers and noncommissioned officers are concentrated on the men who were not ready to fire for record with the second group. This last group complete firing for record by the end of the allotted time for range practice.

(4) When range facilities are such that the entire organization can fire at one time without having more than four or, at the most, six men per target, the same general scheme as that outlined above may be applied. The details of such plan are as follows:

(a) Firing is begun with all of the men of the organization taking part.

(b) At the completion of instruction practice, all except those who have not been shooting well fire for record.

(c) The efforts of the instructors are concentrated on the remainder of the organization for the rest of the allotted time.

■ 170. STOPPAGE DUE TO FAULTY POSITION.—Occasionally, stoppages have been experienced because the firer grasps the rifle with his left hand in such a manner as to cause pressure

on the operating rod with the fingers of the left hand. This prevents the bolt from moving far enough to the rear to permit proper feeding. Correction of the firer's position and loosening the grasp on the rifle with the fingers of the left hand will prevent recurrence. Instructors should explain the possibility of such a manually caused stoppage during instruction in the position exercises. This type of stoppage is rarely experienced in firing and is easily and positively prevented by correct position.

■ 171. MODEL SCHEDULES.—The following schedules are suggested as guides for a course in preparatory marksmanship:

a. Preparatory training—lecture and demonstration.

	Hours	
	AM	PM
FIRST DAY		
FIRST STEP: SIGHTING AND AIMING EXERCISE-----	1	--
First sighting and aiming exercise-----	1	--
Sight blackening and second sighting and aiming exercise-----	1	--
Third sighting and aiming exercise-----	1	--
Continuation of first three exercises to include long range shot group exercises-----		2
Safety precautions-----		1
SECOND DAY		
SECOND STEP: POSITION EXERCISES-----	1	--
Gun sling adjustment; trigger slack; holding the breath; general rules for positions-----	1/2	--
Position exercise:		
Prone, including sandbag rest-----	1	--
Sitting-----	1/2	--
Kneeling-----	1/2	--
Standing-----	1/2	--
THIRD STEP: TRIGGER-SQUEEZE EXERCISES-----		1/2
Prone with and without sandbag-----		1
Sitting-----		1/2
Kneeling-----		1/2
Standing-----		1/2
THIRD DAY		
Assuming positions rapidly-----	1/2	--
Practical work assuming positions rapidly-----	1 1/4	--
FOURTH STEP: RAPID FIRE EXERCISES-----	3/4	--
Timing:		
Prone-----	1/2	--
Sitting-----	1/2	--
Kneeling-----	1/2	--
Standing to prone-----		1
Standing to sitting-----		1/2
Standing to kneeling-----		1/2
General review-----		1

171-172

U. S. RIFLE, CALIBER .30, M1

FOURTH DAY

FIFTH STEP-----	$\frac{3}{4}$	--
Score-book exercise-----	$\frac{3}{4}$	
Review trigger-squeeze exercises in all positions--	1	
Review timing exercises in all positions-----	$1\frac{1}{2}$	
Review rapid-fire exercises-----		$1\frac{1}{2}$
Examination of all men by platoon leaders in all preparatory subjects and exercises ¹ -----		$1\frac{1}{2}$

¹ Lack of proficiency disclosed by examination will be corrected at once by additional instruction.

NOTE.—The preparatory exercises are the same for all courses.

b. Range practice.—The schedule of firing should be based upon a maximum of six men per target. The instruction practice firing outlined in paragraph 64 for each course is meant to serve as a guide. The amount of practice firing to be given and the number of shots to be fired at each range will be such as to secure the maximum training in conformity with conditions and the ammunition allowance.

■ 172. LECTURES AND DEMONSTRATIONS.—*a.* The lectures at the beginning of each step are an important part of the instructional methods. The lectures may be given to the assembled command or group undergoing preparatory rifle training up to and including a regiment or body of recruits of similar size. However, when a battalion takes up rifle training the talks and demonstrations as a rule are made by the captain or a lieutenant of each company. It is not necessary that they be expert shots.

b. The notes on lectures which follow are to be used merely as a guide. The points which experience has shown to be the ones which usually require elucidation and demonstration are placed in side headings in italics. The notes which follow each heading are merely to assist the instructor in preparing his lecture. The lecturer should know in advance what he is going to say on the subject. Under no circumstances will he read over to a class the outlines for lectures contained herein, nor will he read a lecture prepared by himself. During the lecture the headlines in italics made out by himself serve as a guide as to the order in which the subjects are to be discussed. If he cannot talk interestingly and instructively on each subject without further reference to notes, he should not give the lectures at all.

c. It is important to show the men undergoing instruction, by explanation and demonstration, just how to go through the exercises and to tell them why they are given these exercises.

■ 173. FIRST LECTURE: SIGHTING AND AIMING.—*a.* The class is assembled in a building or natural amphitheater in the open where all can hear the instructor and see the demonstrations.

b. The following equipment is necessary:

- 1 sighting bar.
- 1 rifle rest.
- 1 rifle.
- 1 small sighting disk.
- 1 long range sighting disk.
- 1 small box.

Material for blackening sights.

c. The following subjects are the ones usually discussed in the first lecture:

(1) *Value of knowing how to shoot.*—(*a.*) The rifle is the principal weapon of the Infantry in war. Expertness in its use gives the individual confidence and a higher morale.

(*b.*) Individual proficiency increases the efficiency of Infantry as a whole.

(*c.*) Rifle firing is good sport.

(2) *Object of target practice.*—(*a.*) To teach men how to shoot.

(*b.*) To show them how to teach others.

(*c.*) To train future instructors.

(3) *Training to shoot well.*—(*a.*) Any man can be taught to shoot well. Shooting is a purely mechanical operation which can be taught to anyone physically fit to be a soldier.

(*b.*) It requires no inborn talent such as to play a violin or paint a picture.

(*c.*) There are only a few simple things to do to shoot well, but these things must be done in a manner exactly right. If they are done in a manner only approximately right, the results will be poor.

(4) *Method of instruction.*—(*a.*) The method of instruction is the same as in teaching any mechanical operation.

(*b.*) The instruction is divided into steps. The man is taught each step and practices it before going to the next

step. When he has been taught all of the steps he is taken to the rifle range to apply what he has learned.

(c) If he has been properly taught the various preparatory steps, he will do good shooting from the very beginning of range practice.

(d) Explain coach-and-pupil method; why used.

(5) *Reflecting attitude of instructor.*—If the instructor is interested, enthusiastic, and energetic, the men will be the same. If the instructor (squad or platoon leader) is inattentive, careless, and bored, the men will be the same and the scores will be low.

(6) *Examination of men on preparatory work.*—Each man is examined in the preparatory work before going to the range. An outline of this examination is given in paragraph 62.

(7) *Method of marking blank form.*—Explain blank form (par. 55f). Explain marking system by the use of a blackboard if available.

(8) *Five essentials to good shooting.*—(a) Correct sighting and aiming.

(b) Correct position.

(c) Correct trigger squeeze.

(d) Correct application of rapid-fire principles.

(e) Knowledge of proper sight adjustments.

(9) *Today's work.*—First step, sighting and aiming.

(10) *Demonstration of first sighting-and-aiming exercise.*—Have a squad on stage or platform and show just how this exercise is carried on.

(11) *Blackening the sights.*—Explain why and demonstrate how this is done.

(12) *Demonstration of second sighting-and-aiming exercise.*—Assume that some of the squad have qualified in the first exercise. Put these men through the second sighting-and-aiming exercise and show just how it is done.

(13) *Demonstration of third sighting-and-aiming exercise.*—(a) Assume that some of the squad have qualified in the second sighting-and-aiming exercise. Put these men through the third sighting-and-aiming exercise and show just how it is done.

(b) Show how the squad is organized by the coach-and-pupil method so as to keep each man busy all the time.

(14) *Long-range shot group work.*—Show the class the disk for 200-yard shot group work. Explain how this work is carried on and why. Show some simple system of signals that may be used.

(15) *Final word.*—(a) Start keeping your blank form today.

(b) Organize your work so that all men are busy at all times.

(16) *Are there any questions?*

(17) *Next lecture will be* ----- (State hour and place.)

■ 174. SECOND LECTURE: POSITION.—a. The following equipment is necessary for the demonstrations in this lecture:

1 rifle with sling.

1 sandbag.

1 box with small aiming target.

1 aiming device.

b. The following subjects are the ones usually discussed in the second lecture:

(1) *Importance of each step.*—(a) Each step includes all that has preceded.

(b) Each step must be thoroughly learned and practiced or the instruction will not be a success.

(2) *Necessity for correct positions.*—No excellent shot varies from the normal positions. Few men with poor positions are even fair shots. Few men with good positions are poor shots. Instruction in positions involve correct aiming.

(3) *Gun sling.*—Demonstrate both of the gun-sling adjustments and explain why they are used and when each is used.

(4) *Taking up slack.*—Show the class the slack on the trigger. Explain why it is taken up in the position exercises. (Cannot begin to squeeze the trigger until the slack has been taken up.)

(5) *Holding breath.*—Explain the correct manner of holding the breath and have the class practice it a few times. Explain how the coach observes the pupils' breathing by watching their backs.

(6) *Aiming device.*—Show how it is placed on the rifle and how it is used.

(7) *Position of thumb.*—May be either over the stock or on top of the stock but never along the side of the stock. Explain why.

(8) *Joints of finger.*—Trigger may be pressed with first or second joint; second joint preferable when it can be done conveniently.

(9) *Prone position.*—(a) Demonstrate correct prone position, calling attention to the elements which go to make up a correct prone position; gun sling properly adjusted, body at the correct angle, legs spread well apart, position of the butt on the shoulder, position of the hands on the rifle, position of cheek against the stock, position of elbows.

(b) Mention the usual faults which occur in prone position.

(c) Demonstrate the correct position again.

(10) *Sandbag rest position.*—(a) Demonstrate in the same manner as described above for prone position.

(b) Demonstrate coach adjusting sandbag to the pupil.

(11) *Sitting position.*—Demonstrate in the same manner as described above for the prone position.

(12) *Kneeling position.*—Demonstrate in the same manner as described above for the prone position.

(13) *Standing position.*—Demonstrate in the same manner as described above for the prone position.

(14) *Today's work; position exercises.*—(a) Demonstrate the duties of a coach in a position exercise, calling attention to each item.

(b) Demonstrate the position of the coach. Always placed so that he can watch the pupil's finger and eye.

(c) Place a squad on an elevated platform and show how the squad leader organizes it by employing the coach-and-pupil method so as to keep every man occupied.

(d) Continue the long-range triangle work today.

(15) *Do not squeeze trigger today.*—Take up the slack in these exercises but do not squeeze the trigger.

(16) *Keep blank forms up-to-date.*—Examine each man in the squad at the end of the day's work and assign him a mark.

(17) *Are there any questions?*

(18) *Next lecture will be* ----- (State hour and place.)

■ 175. THIRD LECTURE: TRIGGER SQUEEZE.—*a.* The following equipment is necessary for the demonstration:

- 1 rifle with sling.
- 1 aiming device.
- 1 sandbag.
- 1 box with small aiming target.

b. The following subjects are the ones usually discussed in the third lecture:

(1) *Trigger squeeze most important.*—Read paragraph 59. Explain that there is only one correct method of squeezing the trigger—a steady increase of pressure so that the firer does not know when the explosion will take place. Emphasize the fact that this method of squeezing the trigger secures good results and must be applied in rapid fire. Explain that in slow fire at stationary targets the expert shot learns to increase the pressure on his trigger only when the sights are in correct alinement on the target. When the sights become slightly out of alinement, he holds what he has with the finger and only continues the increase of pressure when the sights again become properly alined.

(2) *Sandbag rest.*—Explain why it is used in trigger-squeeze exercise.

(3) *Machine rest example.*—Lay the rifle on a table pointing down the room and toward an imaginary target; assume that it is in a machine rest which runs on a track parallel to the line of targets; assume that you fire a shot which hits the left edge of a 36-inch bull's-eye, 1,000 yards away; then move the rifle 36 inches to the right on the table as if it were sliding along the parallel track and assume that another shot is fired. Where does it hit? Answer: The right edge of the bull's-eye. Move the rifle backward and forward between these two positions and assume a shot is fired anytime while it is moving. Where will it hit? Answer: In the bull's-eye. Now assume that you hold the butt of the rifle still and move the muzzle a fraction of an inch. Where will it hit? Answer: It will miss the whole target. It hits the target when the whole rifle moves but misses it when only one end moves.

(4) *Pulsations of body.*—The natural movements of the body and its pulsations produce more or less parallel move-

ment of the rifle. Very often men who are apparently very unsteady make good scores. You thus see that if you squeeze the trigger so as not to know when the rifle will go off, the shot is displaced only by the amount of the parallel movement and will be a good one. But if you give the trigger a sudden jerk you deflect one end of the rifle, and the shot will be a poor one.

(5) *Aim and hold.*—Any man can easily learn to hold a good aim for 15 to 20 seconds, which is a much longer period than is necessary to fire a well-aimed shot. Poor shots are usually the men who spoil their aim when they fire the rifles.

(6) *Coach squeezing trigger.*—(a) The fact that when the coach squeezes the trigger for the firer the shot is almost invariably a good one proves that poor shooting is principally due to errors in the trigger squeeze.

(b) It is not necessary for the coach to watch the sights through the aiming device. By watching the firer's back he knows when the firer is aiming and then presses steadily on the trigger. Demonstrate how it is done.

(7) *When rifle goes off before man is ready.*—Often a man who has been doing poor shooting will state upon firing a shot, "I cannot call that shot. It went off before I was ready." Almost invariably these shots are well-placed. His poor shooting has been caused by "getting ready" for them.

(8) *Calling shot.*—Explain calling the shot and why it is done.

(9) *Today's work; trigger-squeeze exercise.*—(a) Demonstrate the duties of a coach in a trigger-squeeze exercise by calling attention to each item.

(b) The work is carried on as in position exercises with the squeezing of the trigger added.

(c) Practice only in the prone position this morning, first with then without the sandbag.

(d) Finish up the making of long-range shot group work today.

(10) *Keep blank form up to date.*—Examine each man in the squad at the end of the day's work and assign him a mark.

(11) *Final word.*—Do not let yourselves become bored with this work. It is easy to learn, but it takes a lot of practice to train the muscles and to get in the habit of doing the right thing without thinking.

(12) *Are there any questions?*

(13) *Next lecture will be* ----- (State hour and place.)

■ 176. FOURTH LECTURE: RAPID FIRE.—*a.* The following equipment is necessary for the demonstrations:

1 rifle with gun sling.

2 clips of corrugated-type dummy cartridges.

b. The following subjects are the ones usually discussed in the fourth lecture:

(1) *Rapid fire true test of good shot.*—Superiority of fire in battle depends on the ability to deliver rapid and accurate fire. Both are required and are obtained by careful training.

(2) *Trigger squeeze same as in slow fire.*

(3) *Meaning of rapid fire.*—Rapid fire is merely continuous fire. The rapidity comes from the development of timing in firing, reloading the clips into the receiver smoothly, and keeping the eye on the target.

(4) *Keeping eye on target.*—Explain the advantages of this and how it gains time.

(5) *Application in war.*—Explain the advantage of keeping the eye on the target in combat.

(6) *Timing exercise.*—(a) Explain timing in rapid fire.

(b) Demonstrate timing.

(7) *Operation of bolt in rapid-fire exercise.*—Show how the coach presses the operating handle with a sharp motion, and then releases the pressure to permit the operating handle to go forward each time the pupil squeezes the trigger in the prone, sitting, and in the kneeling positions. Call attention to the details in each case.

(8) *Necessity for rapid-fire practice.*—(a) A natural rhythm in firing on the part of a soldier materially increases his rapid-fire scores and his efficiency in battle.

(b) Practice in loading clips of cartridges into the receiver also is necessary.

(9) *Assuming positions rapidly.*—(a) The prone position can be assumed and an aimed shot fired more rapidly than from any other position.

(b) Application in combat.

(c) Demonstrate rapid-fire exercise, standing to prone, standing to kneeling, and standing to sitting, first by the numbers and then as one smooth movement.

(d) Even if it takes a few seconds longer get into the correct position before starting to shoot.

(10) *Today's work; rapid-fire exercise.*—(a) Explain how exercises are to be carried on.

(b) Demonstrate the duties of a coach in a rapid-fire exercise, calling attention to each item.

(c) First period today will be given to rapid fire timing exercise and it will be repeated in short periods from time to time until each man is proficient.

(11) *Keep blank forms up to date.*—Examine each man in the squad at the end of the day's work and assign him a mark.

(12) *Are there any questions?*

(13) *Next lecture will be* ----- (State hour and place.)

■ 177. FIFTH LECTURE: EFFECT OF WIND AND LIGHT; SIGHT CHANGES; SCORE BOOK.—a. This part of the preparatory instruction can be given on any day in which the weather forces the work to be done indoors. If no bad weather occurs, this work should follow rapid-fire instruction.

b. The following equipment is necessary for the demonstrations:

(1) One A, B, and D target for each range at which each of these targets is to be used in range practice. These targets to be mounted on a frame and marked with the proper wind-age and elevation lines.

(2) Eight spotters that can readily be stuck into the target.

(3) Each man to have his rifle and a score book.

c. The following subjects are the ones usually discussed in the fifth lecture:

(1) *Targets.*—(a) Explain the divisions on the target and give the dimensions of each.

(b) Call attention to windage and elevation lines. Have class compare them with diagram in the score book. Explain why lines are farther apart as the range increases.

(2) *Weather conditions*.—All weather conditions disregarded except wind.

(3) *Wind*.—(a) Explain how the direction of the wind is described.

(b) Explain how the velocity of the wind is estimated.

(c) Explain the effect of wind. Effect increases with distance from target.

(4) *Windage for first shot*.—Show windage diagram in W. D., A. G. O. Form No. 82 (Individual Score Book), and explain its use.

(5) *Wind-gage rule*.—State rule and explain it.

(6) *Elevation rule*.—State rule and explain it.

(7) *Light*.—Explain effect.

(8) *Mirage*.—Tell what it is and how it assists riflemen.

(9) *Shooting up or down hill*.—(a) Explain the effect on elevation.

(b) Remember this rule when shooting at hostile airplane.

(10) *Scorebook*.—(a) Explain the uses of scorebook on range.

(b) Have class open scorebooks and explain items of keeping a score point by point.

(11) *Exercises*.—Give the class a number of small problems as a demonstration as to how the day's work is to be carried on.

(12) *Today's work*.—(a) Study and practice in sight setting, sight changing, and the use of scorebook. Squad leaders and other instructors will work up problems for their groups. Coach-and-pupil method is also used in which the coach states the conditions for the pupil.

(b) Additional practice in the exercises of the preceding days and rapid-fire exercises.

(13) *Are there any questions?*

(14) *Next lecture will be* ----- (State hour and place.)

■ 178. SIXTH LECTURE: RANGE PRACTICE.—This lecture and demonstration should immediately precede range firing. If

the class is not too large, it should be given on a firing point of the rifle range.

a. The following equipment is necessary for the demonstrations:

1 rifle with gun sling.

1 sandbag.

1 aiming device.

Material for blackening sight.

Corrugated-type dummy cartridges (par. 18).

b. The following subjects are the ones usually discussed in the sixth lecture:

(1) *Preparatory work applied.*—Range practice is carried on practically the same as a trigger-squeeze exercise except that ball cartridges are used.

(2) *Coaching.*—Coach watches the man not the target. Coach does not keep the score for the pupil. Pupil must make his own entries in his scorebook. Coach sees that he does this.

(3) *Officers and noncommissioned officers.*—(a) Supervise and prompt the men acting as coaches.

(b) Personally coach pupils who are having difficulty in making good scores.

(4) *Spotters.*—(a) Use in both slow and rapid fire.

(b) If a spotter near the edge of the bull's-eye bothers the pupil in aiming, it may be removed before he fires again.

(5) *Sandbag rest.*—(a) Explain why it may be used in special cases.

(b) Demonstrate a coach adjusting the sandbag to a pupil who requires special instruction.

(6) *Watching the eye.*—Explain how this indicates whether or not the pupil is squeezing the trigger properly.

(7) *Position of coach.*—Demonstrate in each one of the positions.

(8) *Demonstration of coaching in slow fire.*—(a) Place a man on the firing point and show just what a coach does by calling attention to each item. See paragraph 70 d (6).

(b) Demonstrate the use of the aiming device.

(c) Demonstrate the use of dummy cartridges in slow fire.

(d) Demonstrate coach squeezing the trigger for pupil.

(9) *Demonstration of coaching in rapid fire.*—Same procedure as in paragraph 70 e.

(10) *Use of corrugated type dummy cartridges in rapid fire.*—Show how dummy cartridges are mixed with service cartridges for rapid-fire training and explain why this is done.

(11) *Read final precautions for slow fire.*—See paragraphs 69 and 70.

SECTION IV

MARKSMANSHIP; AIR TARGETS

■ 179. PRELIMINARY PREPARATION.—*a.* The officer in charge of rifle antiaircraft training should be thoroughly familiar with the subject; should have detailed sufficient officers as assistant instructors; and should train the assistant instructors and a demonstration group before the first training period.

b. He should inspect the range and equipment in sufficient time prior to the first training period to permit correction of deficiencies.

■ 180. DESCRIPTION OF MINIATURE RANGE.—*a. Targets.*—(1) *Horizontal.*—This target is designed to represent a sleeve target towed by an airplane flying parallel to the firing point.

(2) *Double diving and climbing.*—This target is in two sections. The right section is designed to represent a sleeve target towed so as to pass obliquely across the front of the firing line in the manner of an airplane diving, if run from left to right, or climbing, if run from right to left. The left section is the same but represents an airplane diving from right to left and climbing from left to right.

(3) *Overhead.*—This target is designed to represent a sleeve target towed by an airplane which is approaching the firing line and will pass overhead, or when run in the opposite direction represents an airplane that has passed over the firing line.

b. Size and speed of silhouette.—The black silhouette is a representation at 500 inches of a 15-foot sleeve at a range of 330 yards. It is 7.5 inches long. The speed of the silhouette should be between 15 and 20 feet per second. This speed represents that of an airplane flying between 150 and 200 miles per hour at a range of 200 yards. The size and speed of the silhouette are based upon the time of flight of the caliber .22 bullet for 500 inches. This time of flight is approximately 0.04 second. When the target is moving at a speed

of 15 feet or 180 inches per second, it will move $180 \times .04$ or 7.2 inches. Therefore in order to hit the silhouette, the aim must be directed approximately one silhouette length in front of it. If two or three target-length (silhouette lengths) leads are used, the shot will hit in the appropriate scoring spaces. This does not hold equally true on the overhead target. If the shot is fired when the range is less than 500 inches from the firer, the lead necessary will be less than one target length.

■ 181. PREPARATORY EXERCISES.—*a.* A method of conducting the preparatory exercises is given in paragraph 98.

b. Each assistant instructor is assigned a target and conducts the preparatory training and firing of all groups on his target.

c. In preparatory training coach and pupil should change places frequently.

d. Forty-five minutes at each type of target should be sufficient to train each soldier in the preparatory exercises.

e. A detail of one noncommissioned officer and four or six men should be provided to operate each type of target.

■ 182. MINIATURE RANGE FIRING.—*a.* (1) *Caliber .22 rifle.*—*(a)* The rifle should have the open sight.

(b) Two magazines for each caliber .22 rifle should be provided.

(c) Ammunition should be available immediately in rear of the firing line at each type of target.

(d) Coaches should load magazines as they become empty.

(e) Scorers should be detailed for each type of target. After each score is fired, they score the target. They call off the number of hits made on each silhouette and pencil the shot holes. The coaches enter the scores on the firer's score card.

(f) A platform permitting the scorer to score the target should be provided for each type of target.

(g) To stimulate interest, the instruction can be concluded with a competition between individuals, squads, or training groups.

(h) If available, targets as shown in figure 59 may be used on nonoverhead targets for group firing or competitions. Only one target-length lead may be used in firing on this target.

(i) Considerable supervision is required in order to maintain target operation at the proper speed. This speed is necessary because the lead is based upon a speed of from 15 to 20 feet per second.

(j) Safety precautions must be constantly observed.

(2) *Caliber .30 M1 rifle.*—If the size of the danger area permits, the caliber .30 rifle may be fired on the miniature



FIGURE 59.

range. Such firing may be conducted in the same manner as with the caliber .22 rifle with the following exceptions:

(a) Sight over the top of the rear sight and front sight.

(b) The lead necessary to hit the black silhouette is approximately 2.5 inches. This is due to the difference in the time of flight of the caliber .30 and caliber .22 bullets for 500 inches. The time of flight of the caliber .30 bullet for

500 inches is 0.015 second. When the target is operated at the speed of 15 or 20 feet per second, the silhouette will move approximately 2.5 inches during the time of flight of the bullet.

b. In sighting over the top of the rear sight and front sight, the line of aim is lower than the trajectory of the bullet. Therefore it will be necessary to aim low in order to hit the silhouette.

c. Men must be constantly cautioned to keep the weight of the body forward.

d. Preparatory exercises using the caliber .30 rifle should precede firing that weapon. These exercises are conducted as explained for the caliber .22 rifle.

e. The interval between individuals on the firing line should be increased. This may be accomplished by placing only one-half the group on the firing line at one time.

■ 183. TOWED-TARGET FIRING.—*a. Range organization.*—(1) Individual firing at a towed target being impracticable, all firing is done by a unit of such size that its fire can be readily controlled and directed. The platoon is the most convenient unit for such firing.

(2) An *ammunition line* should be established 10 yards in rear of the firing line. Small tables at the rate of one per ten men in a firing group are desirable.

(3) Immediately in rear of the ammunition line the ready line should be established.

(4) The first platoon or similar group to fire is deployed along the ready line with each individual in rear of his place on the firing line. Other platoons or similar groups are similarly deployed in a series of lines in rear of the first unit to fire.

(5) Upon command of the officer in charge, the group on the ready line moves forward to the firing line securing ammunition en route; other groups close up.

(6) Upon completion of firing by one group it moves off the firing line, passing around the flanks of the ready line so as not to interfere with the group moving forward.

(7) An ammunition detail sufficient to issue ammunition to groups as they move forward to the firing line and collect unfired ammunition from the group which just completed

firing should be provided. These two operations should be performed simultaneously. Unfired ammunition is delivered to the statistical officer.

(8) The officer in charge should have at least three assistants—two safety officers and one statistical officer.

b. Ammunition.—(1) Ball or tracer ammunition may be used. Tracer ammunition is useful to show the groups waiting to fire the size and density of the cone of fire delivered by the firing group.

(2) Tracer ammunition will assist the officer in charge in verifying the lead announced in the fire order. It also provides a means of checking the firer's estimate of the lead ordered.

c. Technique of fire.—(1) *Leads.*—(a) The lead used in the technique of fire described in paragraph 95a (1) is the average of two theoretical extremes. For example: If the maximum slant range to a passing airplane is 600 yards and the minimum slant range is 300 yards, the lead used would be that required for a slant range of 450 yards. Fire is delivered with one fixed lead in order to simplify the procedure. Experience indicates such a technique is readily taught and that it is effective.

(b) The lead table given below may be helpful. It is based upon a 15-foot sleeve towed at 200 miles per hour and caliber .30 M2 ammunition.

Slant range:	Lead required
100-----	2
200-----	5
300-----	8
400-----	11
500-----	14
600-----	18

(2) *Methods.*—(a) *Normal.*—The normal method of fire distribution is given in chapter 4. This method will be taught in towed-target range practice. If time and ammunition allowances permit, other methods may also be taught.

(b) *Variable lead.*

1. Using this method the individual rifleman fires each shot with a different lead. The maximum lead is

used as the target enters and leaves the firing area. The minimum lead is used when the target is directly opposite the firing line. Example: Three rounds are to be fired as the sleeve target passes across the front of the firing line. The first round is fired shortly after the target enters the firing area; the second round is fired when the target is near the center of the firing area; the third shot is fired shortly before the sleeve leaves the firing area. The fire order given by the officer in charge is: 1. SLEEVE TARGET APPROACHING FROM THE LEFT (RIGHT), 2. 3 ROUNDS LOAD, 3. 14-8-14 TARGET-LENGTH LEADS, 4. COMMENCE FIRING. In this example it is expected that the three shots will be fired at slant ranges of approximately 500 yards, 300 yards, and 500 yards, respectively.

2. This method has given good results but is more difficult to apply than the normal method.

(3) *Precautions*.—Safety precautions as given in paragraph 108 must be rigidly enforced. This requires constant supervision by the officer in charge.

(4) *Record*.—The results of all towed-target firing should be recorded and analyzed. The statistical officer should record the total number of rounds fired and the hits obtained on each target. If the number of hits falls below the number expected, the reason should be sought and explained to the men. On the other hand when results are satisfactory the men should be impressed with the value of rifle anti-aircraft fire.

SECTION V

TECHNIQUE OF FIRE

■ 184. **GENERAL**.—The instructor should secure necessary equipment, inspect ranges, and detail and train necessary assistants, including demonstration units, prior to the first period of instruction. Instructors should use their initiative in arranging additional exercises in the application of the principles herein contained. It should be explained to trainees how the exercises used illustrate the principles in the technique of fire. Good work in the conduct of the exercises

as well as errors should be called to the attention of all trainees.

■ 185. RANGE ESTIMATION.—*a.* A number of ranges to prominent points on the terrain should be measured so that a few minutes of each period can be devoted to range estimation.

b. Range cards as shown below will be of assistance in figuring percentage of errors.

RANGE ESTIMATION

Name -----

Company -----

Squad -----

Number	Estimate	Correct	%	Remarks	Number	Estimate	Correct	%	Remarks
1					21				
2					22				
3					23				
4					24				
5					25				
6					26				
7					27				
8					28				
9					29				
10					30				
11					31				
12					32				
13					33				
14					34				
15					35				
16					36				
17					37				
18					38				
19					39				
20					40				

TABLE FOR COMPUTING ERRORS IN RANGE ESTIMATION

Range in yards	Error in yards										
	5	10	15	20	25	30	35	40	45	50	100
250	2	4	6	8	10	12	14	16	18	20	40
275	2	4	5	8	9	11	13	15	16	18	36
300	2	3	5	7	8	10	12	13	15	17	33
330	2	3	5	6	8	9	11	12	14	15	30
350	1	3	4	6	7	9	10	11	13	14	29
380	1	3	4	5	7	8	9	11	12	13	26
400	1	3	4	5	6	8	9	10	11	13	25
420	1	2	4	5	6	7	8	10	11	12	24
440	1	2	3	4	6	7	8	9	10	11	23
460	1	2	3	4	5	7	8	9	10	11	22
480	1	2	3	4	5	6	7	8	9	10	21
500	1	2	3	4	5	6	7	8	9	10	20
520	1	2	3	4	5	6	7	8	9	10	19
540	1	2	3	4	5	6	7	8	9	10	19
560	1	2	3	4	4	5	6	7	8	9	18
580	1	2	3	3	4	5	6	7	8	9	17
600	1	2	3	3	4	5	6	7	8	8	17
620	1	2	2	3	4	5	5	6	7	8	16
640	1	2	2	3	4	5	5	6	7	8	16
660	1	2	2	3	4	5	5	6	7	8	15
680	1	1	2	3	4	4	5	6	7	8	15
700	1	1	2	3	3	4	5	6	6	7	14
720	1	1	2	3	3	4	5	6	6	7	14
740	1	1	2	3	3	4	5	6	6	7	14
760	0	1	2	3	3	4	5	5	6	7	13
780	0	1	2	3	3	4	4	5	6	6	13
800	0	1	2	3	3	4	4	5	6	6	13
850	0	1	2	2	3	3	4	5	5	6	12
900	0	1	2	2	3	3	4	4	5	6	11
950	0	1	2	2	3	3	4	4	5	5	11
1,000	0	1	2	2	3	3	4	4	5	5	10

NOTE.—Example of the use of this table: Suppose the correct range to be 695 yards and the estimated range to be 635. The “error in estimate” is consequently 60 yards. Select two “errors in estimate” in the 700-yard space (the nearest to the correct range given in the table) whose sum is 60 yards, as 50 and 10. Add the percentages shown thereunder, and the result will be approximately your error. In this case:

$$7 \text{ plus } 1 = 8\%$$

■ 186. TARGET DESIGNATION.—*a.* The major portion of the time devoted to target designation should be spent on oral description. Simple designations should be required at first. This instruction should not be confined to the landscape panels.

b. An explanation should be made to the trainees as to why an angle of 50 mils will be subtended by 1 foot at 20 feet.

■ 187. RIFLE FIRE AND ITS EFFECT.—This step of instruction can best be covered by the use of a blackboard and several riflemen firing tracer bullets to demonstrate the trajectory, danger space, dispersion, classes of fire, etc.

■ 188. APPLICATION OF FIRE.—*a.* Sufficient time and explanation should be devoted to the method of fire distribution to insure that all men fully understand it and can explain it in their own words.

b. A demonstration squad simulating firing should suffice to show the technique employed in assault fire.

■ 189. LANDSCAPE-TARGET FIRING.—*a.* An explanation and demonstration will be necessary to show the technique and procedure of zeroing rifles and the firing of exercises on the landscape targets.

b. Units should be given practical work in writing fire orders for targets on the landscape panels prior to their firing of any exercises.

■ 190. FIELD-TARGET FIRING.—*a.* The most difficult factor in the preparation of problems for field firing is the selection of the terrain which complies with the safety regulations contained in AR 750-10. A drawing should be made on a map showing all safety angles, target positions, etc.

b. The appearance of the ordinary prone or kneeling silhouette depends a great deal upon the direction of the sun, the background of the targets, and the angle at which the targets are placed. The effect of solidity can be obtained by using two figures placed at right angles to one another. The effect of fire distribution on a linear target can be determined by using a screen of E targets nailed end to end; the screen should be located so as not to disclose the position of concealed targets.

c. Maximum use should be made of the available terrain to permit the firing of as many squads from one firing position at one time as is possible. This firing should be controlled from a central position. Telephone communication between the firing point and the pits will facilitate this instruction. During this type of training, individuals and units should approach and occupy their firing positions with due regard to cover and concealment, after which men are rearranged on the firing position according to the requirements of safety.

d. When sufficient time and ammunition are available platoon exercises should be conducted.

INDEX

	Paragraph	Page
Accessories -----	38	40
Adjust rear sight-----	29	34
Advice to instructors-----	161	209
Aiming:		
First lecture-----	173	217
First step-----	57	55
Aiming and leading exercises (second step)-----	100	151
Air target marksmanship, preliminary training-----	179	227
Air targets:		
Classification -----	91	142
Suitable for rifle fire-----	90	142
Ammunition -----	40, 168	45, 211
Care, handling, and preservation-----	44	46
Cartridge, ball, caliber .30-----	45	47
Classification -----	41	45
Grade -----	43	46
Lot number-----	42	45
Precautions in firing blank-----	46	47
Appendages -----	37	39
Application:		
Fire -----	139, 188	189, 235
Leads -----	83	137
Assault fire-----	141	191
Assembling -----	9	14
Assistant instructors -----	165	210
Basic principles, fire at moving targets-----	82	136
Beaten zone -----	135	187
Blackening sights-----	56	55
Bullets, tracer-----	128	179
Use -----	122	176
Care and cleaning of rifle:		
After firing-----	12	21
In garrison and camp-----	10	19
On range or in field-----	13	23
Preparatory to:		
Firing -----	11	20
Storage -----	14	23
When received from storage-----	15	24
Care in assembling and disassembling-----	6	3
Care of ammunition-----	44	46
Cartridge, ball, caliber .30-----	45	47
Cartridge clip, to load-----	23	31
Cartridges, dummy-----	18	25
Classes of fire-----	136	187
Classification:		
Air targets-----	91	142
Ammunition -----	41	45
Clear rifle-----	31	34
Commanders, duties and equipment-----	54	51

INDEX

	Paragraph	Page
Concentrated fire.....	140	190
Conduct of mechanical training.....	162	209
Continuous rifle practice.....	52	51
Continuous small-bore practice.....	79	131
Control of fire.....	144	193
Courses:		
A, B, C, and D.....	64-67	93-100
For small-bore practice.....	80	132
To be fired.....	107	160
Critique.....	159	206
Cycle, description.....	19	25
Definitions.....	117	174
Delivery of fire.....	96	145
Demonstrations.....	172	216
Description:		
Cycle.....	19	25
Landscape target.....	148	196
Miniature range.....	180	227
Rifle.....	2	1
Targets, oral.....	130	180
Designation, target.....	94, 186	143, 235
Determination of leads.....	83	137
Disassembling.....	8	3
Discipline, fire.....	143	191
Dispersion.....	133	187
Distributed fire.....	140	190
Distribution of fire.....	95	144
Dummy cartridges, use.....	18	25
Duties:		
Commanders.....	54	51
Leaders.....	54, 146	51, 195
Effect of:		
Fire.....	137	189
Rifle fire.....	187	235
Wind (fifth step).....	61	80
Wind and light (fifth lecture).....	177	224
Employment of rifle units.....	81	136
Equipment.....	166	211
Marksmanship training.....	73	121
Of leaders and commanders.....	54	51
Estimation by eye.....	124	176
Examination of men before starting range practice (sixth step).....	62	88
Exercises.....	131, 138, 154, 160	184, 189, 200, 206
Aiming and leading (second step).....	100	151
Fire.....	158, 160	205, 206
Position (first step).....	99	149
Preparatory.....	98, 181	147, 228
Trigger squeeze (third step).....	101	153
Field glass, type EE.....	39	41
Field target firing.....	190	235
General considerations.....	157	204
Scope of training.....	155	202
Terrain, targets, and ranges.....	156	202

INDEX

	Paragraph	Page
Fifth lecture; effect of wind and light, sight changes, score book.....	177	224
Fifth step; effect of wind, sight changes, score book.....	61	80
Fire:		
Application	139, 188	189, 235
Assault	141	191
Classes	136	187
Concentrated and distributed.....	140	190
Control	144	193
Delivery	96	145
Discipline	143	191
Distribution	95	144
Effect	137	189
Exercises	158, 160	205, 206
Observation	123	176
Orders	145	194
Rate	142	191
Rifle	27	34
Importance	118	174
Technique	84, 92, 184	137, 142, 232
At moving personnel.....	86	138
Place in training.....	85	138
Firepower	3	1
Firing:		
Care and cleaning of rifle—		
After	12	21
Preparatory to.....	11	20
Field target.....	190	235
Group	105	158
Instruction	104	157
Landscape target.....	189	235
Miniature range.....	182	228
Procedure	109, 152	161, 199
Towed-target	106, 183	159, 230
First lecture; sighting and aiming.....	173	217
First step:		
Position exercises.....	99	149
Sighting and aiming.....	57	55
Fourth lecture; rapid fire.....	176	223
Fourth step; rapid fire.....	60	73
Functioning of rifle, instruction in.....	16, 17	25, 25
Fundamentals of markmanship training.....	49	50
Grade of ammunition.....	43	46
Group firing.....	105	158
Handling of ammunition.....	44	46
Immediate action.....	34	35
Instruction in.....	32, 33	35, 35
Importance of:		
Landscape target firing.....	147	195
Range estimation.....	120	175
Rifle fire.....	118	174
Target designation.....	125	179

INDEX

	Paragraph	Page
Inspection of rifles.....	167	211
Instruction:		
Firing	104	157
Marksmanship training.....	97	146
Practice	70	104
Recruit	53	51
Functioning of rifle.....	16, 17	25, 25
Immediate action.....	32, 33	35, 35
Operation of rifle.....	20, 21	31, 31
Instructions to pilots for towing missions.....	115	166
Instructors:		
Advice to.....	161	209
Assistant	165	210
Known-distance target.....	163	210
Ranges	75	127
Training	163	210
Landscape target firing.....	189	235
Scope and importance.....	147	195
Weapons to be used.....	149	196
Landscape targets, preparation.....	150	196
Leaders:		
Duties	54, 146	51, 195
Equipment	54	51
Leads	93	143
Determination and application.....	83	137
Lectures	172-178	216
Place of assembly for.....	164	210
Load:		
Cartridge clip.....	23	31
Rifle	24	32
Lot number of ammunition.....	42	45
Marksmanship training:		
Fundamentals	49	50
Instruction in.....	97	146
Necessity for.....	48	49
Phases	50	50
Practice seasons.....	51	50
Preparatory	55	52
Purpose	47	49
Mechanical training, conduct.....	162	209
Methods:		
Range estimation.....	121	175
Target designation.....	127	179
Miniature range	112	163
Description	180	227
Firing	182	228
Practice	102	156
Model schedules.....	171	215
Moving personnel, fire at.....	86, 87	138, 139
Moving targets and ranges.....	88	139
Necessity for marksmanship training.....	48	49
Nomenclature	7	3

INDEX

	Paragraph	Page
Object of small-bore practice.....	77	131
Observation of fire.....	123	176
Operate rifle as single loader.....	26	33
Operation of rifle, instruction in.....	20, 21	31, 31
Oral description of targets.....	130	180
Orders, fire.....	145	194
Organization:		
Enlisted men.....	5	3
Work.....	169	211
Phases of marksmanship training.....	50	50
Pointing, targets.....	129	180
Position (second lecture).....	174	219
Position exercises (first step).....	99	149
Positions (second step).....	58	61
Practice seasons.....	51	50
Precautions:		
In firing blank ammunition.....	46	47
Range.....	89	141
Safety.....	30, 69, 103, 108	34, 102, 157, 160
Preliminary preparation, air target marksmanship.....	179	227
Preparation of landscape, targets.....	150	196
Preparatory exercises.....	98, 181	147, 228
Preparatory marksmanship training.....	55	52
Preservation of ammunition.....	44	46
Procedure of firing.....	109, 152	161, 199
Qualification courses A, B, C, and D.....	64-67	93
Range:		
Estimation.....	185	233
Importance.....	120	175
Methods.....	121	175
Officer.....	111	163
Miniature.....	112	163
Practice.....	68	68
Examination of men before starting (sixth step).....	62	88
Miniature.....	102	156
Sixth lecture.....	178	225
Precautions.....	89	141
Towed-target.....	113	165
Ranges.....	156	202
Moving.....	88	139
Rapid fire:		
Fourth lecture.....	176	222
Fourth step.....	60	73
Rate of fire.....	142	191
Rear sight, to adjust.....	29	34
Record practice.....	71	109
Rules governing.....	72	117
Recruit instruction.....	53	51

INDEX

	Paragraph	Page
Care and cleaning.....	10-15	19
Description	2	1
Functioning, instruction in.....	16, 17	25, 25
Operation, instruction in.....	20, 21	31, 31
To clear.....	31	34
To fire.....	27	34
To load.....	24	32
To operate as single loader.....	26	33
To set at safe.....	28	34
To unload.....	25	32
Rifle fire:		
Air targets suitable for.....	90	142
Effect	187	235
Importance	118	174
Scope of training.....	119	174
Rifle practice, continuous.....	52	51
Rifles:		
Inspection	167	211
Zeroing-in	151	198
Safety precautions.....	30, 69, 103, 108	34, 102, 157, 160
Schedules, model.....	171	215
Scope of training:		
Field target firing.....	155	202
Landscape target firing.....	147	195
Rifle fire.....	119	174
Score book:		
Fifth lecture.....	177	224
Use of (fifth step)	61	80
Scoring	110, 153	163, 200
Second lecture; position.....	174	219
Second step:		
Aiming and leading exercises.....	100	151
Positions	58	61
Set rifle at safe.....	28	34
Shot groups.....	134	187
Sight changes:		
Fifth lecture.....	177	224
Fifth step.....	61	80
Sighting and aiming (first step).....	57	55
Sighting and aiming (first lecture).....	173	217
Sights, blackening.....	56	55
Signals	116	168
Sixth lecture; range practice.....	178	226
Sixth step; examination of men before starting range practice.....	62	88
Small-bore practice:		
Continuous	79	131
Courses	80	132
Object	77	131
Value	78	131
Spare parts.....	36	39
Stoppage due to faulty position.....	170	214

INDEX

	Paragraph	Page
Stoppages	35	35
Instruction in	32, 33	35, 35
Storage, cleaning of rifle before and after	14, 15	23, 24
Target:		
Designation	94, 186	143, 235
Importance	125	179
Methods	127	179
Landscape:		
Description	148	196
Preparation	150	196
Ranges, known-distance	75	127
Targets	74, 156	126, 202
Moving	88	139
Towed	114	166
Technique of fire	84, 92, 184	137, 142, 232
At moving personnel	86	138
Place in training	85, 87	138, 139
Terrain	156	202
Third lecture; trigger squeeze	175	221
Third step; trigger squeeze	59	70
Exercises	101	153
Topographical terms	126	179
Towed-target:		
Firing	106, 183	159, 230
Range	113	165
Towed targets	114	166
Towing missions, instructions to pilots for	115	166
Tracer bullets	128	179
Use	122	176
Training:		
Marksmanship	47-50	49-50
Mechanical, conduct	162	209
Object	1	1
Preparatory	55	52
When taken up	4	1
Trajectory	132	186
Trigger squeeze:		
Third lecture	175	221
Third step	59	70
Exercises	101	153
Unload rifle	25	32
Use:		
Dummy cartridges	18	25
Tracer bullets	122	176
Value of small-bore practice	78	131
Weapons to be used, fire at landscape target	149	196
Wind, effect of (fifth step)	61	80
Wind and light, effect of (fifth lecture)	177	224
Work, organization of	169	211
Zeroing-in of rifles	151	198
Zone, beaten	135	187