

★
RESTRICTED
FOR OFFICIAL USE ONLY

AN 01-60JE-1

*PILOT'S FLIGHT OPERATING
INSTRUCTIONS*

ARMY MODEL
P-51-D-5

BRITISH MODEL
MUSTANG IV

AIRPLANES

This Technical Order contains specific instructions for pilots and should be available for Transition Flying Training as contemplated in AAF Reg. 50-16.

This publication shall not be carried in aircraft on combat missions or when there is a reasonable chance of its falling into the hands of the enemy.

NOTICE: This document contains information affecting the national defense of the United States within the meaning of the Espionage Act, 50 U. S. C., 31 and 32, as amended. Its transmission or the revelation of its contents in any manner to an unauthorized person is prohibited by law.

★
APRIL 5, 1944

**RESTRICTED
AN 01-60JE-1**

Published under joint authority of the Commanding General, Army Air Forces, the Chief of the Bureau of Aeronautics, and the Air Council of the United Kingdom.

THIS PUBLICATION MAY BE USED BY PERSONNEL RENDERING SERVICE TO THE UNITED STATES OR ITS ALLIES

Instructions Applicable to AAF Personnel.

Paragraph 5.d. of Army Regulation 380-5 relative to the handling of restricted printed matter is quoted below:

"d. Dissemination of restricted matter.—The information contained in restricted documents and the essential characteristics of restricted material may be given to any person known to be in the service of the United States and to persons of undoubted loyalty and discretion who are cooperating in Government work, but will not be communicated to the public or to the press except by authorized military public relations agencies."

Instructions Applicable to Navy Personnel.

Navy Regulations, Article 75½, contains the following paragraphs relating to the handling of restricted matter:

"(b) Restricted matter may be disclosed to persons of discretion in the Government service when it appears to be in the public interest.

"(c) Restricted matter may be disclosed, under special circumstances, to persons not in the Government service when it appears to be in the public interest."

The Bureau of Aeronautics Circular Letter No. 12-43 further states:

"Therefore, it is requested that all naval activities check their own local regulations and procedures to make sure that handbooks, service instructions and other restricted technical publications are actually being made available to both civilian and enlisted personnel who have use for them."

General.

These instructions permit the issue of restricted publications to civilian contract and other accredited schools engaged in training personnel for Government work, to civilian concerns contracting for overhaul and repair of aircraft or aircraft accessories, and to similar commercial organizations.

LIST OF REVISED PAGES ISSUED

NOTE: A heavy black vertical line, to the left of the text on revised pages, indicates the extent of the revision. This line is omitted where more than 50 percent of the page is revised.

ADDITIONAL COPIES OF THIS PUBLICATION MAY BE OBTAINED AS FOLLOWS:

AAF ACTIVITIES.—Submit requisitions to the Commanding General, Fairfield Air Service Command, Patterson Distribution Branch, in accordance with AAF Regulation No. 5-9. Also, for details of Technical Order distribution.

NAVY ACTIVITIES.—Submit requests to the Chief, Bureau of Aeronautics, Navy Department, Washington, for distribution of technical publications.

BRITISH ACTIVITIES.—Submit requirements on Form 294A, in duplicate, to the Air Publications Office, 100, Victoria Gate, Yorkshire, England.

RESTRICTED

RESTRICTED
AN 01-50JE-1

TABLE OF CONTENTS

	PAGE		PAGE
SECTION I Description			
1. General.....	1	21. Diving.....	24
2. Flight Controls.....	1	22. Gliding.....	27
3. Landing Gear.....	1	23. Night Flying.....	27
4. Brakes.....	1	24. Approach and Landing.....	27
5. Hydraulic System.....	5	25. Stopping Engine.....	27
6. Power Plant.....	5	26. Before Leaving Cockpit.....	28
7. Fuel System.....	8	27. Tying Down.....	28
8. Oil System.....	8		
9. Cooling System.....	8	SECTION III Flight Operating Data	
10. Electrical System.....	8	1. Specific Engine Flight Chart.....	29
11. Miscellaneous Equipment.....	12	2. Airspeed Correction Chart.....	29
SECTION II Pilot's Operating Instructions		SECTION IV Emergency Operating Instructions	
1. Flight Restrictions.....	13	1. General.....	33
2. Before Entering Cockpit.....	13	2. Engine Failure During Flight.....	33
3. On Entering Cockpit.....	14	3. Emergency Exit During Flight.....	35
4. Fuel System Management.....	15	4. Ditching.....	35
5. Starting Engine.....	16	5. Landing Gear Emergency Lowering.....	35
6. Engine Warm-up.....	18	6. Emergency Bomb or Droppable Fuel Tank Release.....	35
7. Emergency Take-off.....	18	7. Emergency Use of Oxygen.....	35
8. Engine and Accessories Ground Test.....	19	8. Use of Miscellaneous Emergency Equipment.....	35
9. Taxiing.....	20	SECTION V Operational Equipment	
10. Before Take-off.....	21	1. Gunnery Equipment.....	37
11. Take-off.....	21	2. Bombing Equipment.....	38
12. Engine Failure During Take-off.....	21	3. Communication Equipment.....	40
13. Climb.....	22	4. Oxygen System.....	45
14. During Flight.....	22	5. Heating, Ventilating, and Defrosting System.....	48
15. Engine Failure During Flight.....	23		
16. Flying Characteristics.....	23	APPENDIX I Glossary.....	
17. Maneuvers Prohibited.....	24	49	
18. Stalls.....	24	APPENDIX II Flight Operating Charts.....	
19. Spins.....	24	51	
20. Acrobatics.....	24	1. Flight Planning.....	51

FRONTISPIECE

RESTRICTED
AN

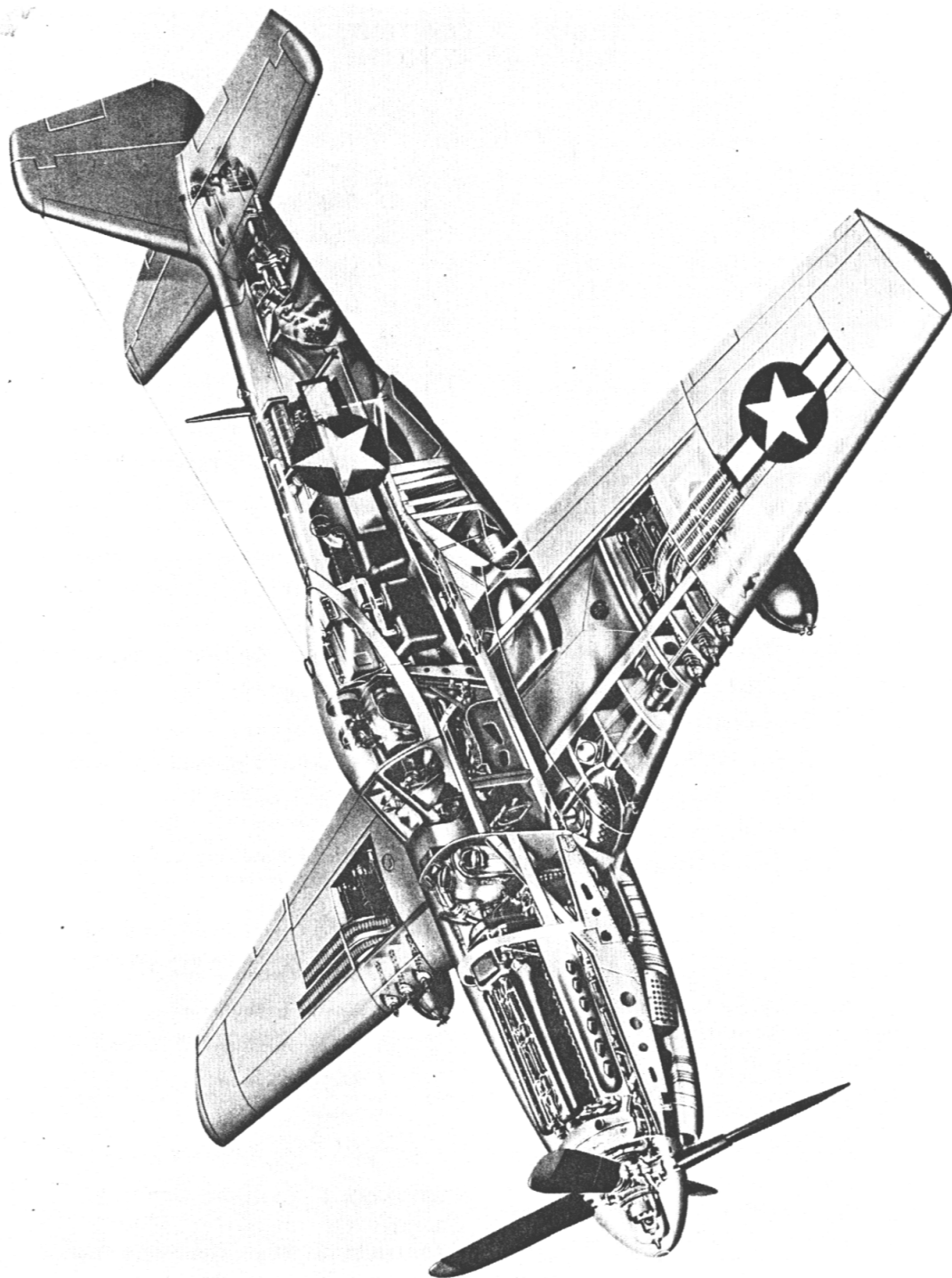

RESTRICTED

RESTRICTED
AN 01-60JE-1



1. GENERAL.

The North American P-51D Fighter Airplane is a single-place, low-wing monoplane powered by a V-1650-7 liquid-cooled engine. It has a wing span of 37 feet, a length of 32 feet 3 inches, and a height (tail down) of 12 feet, 2 inches. The airplane is armed with six .50-caliber machine guns and may be equipped with wing racks to carry bombs, depth charges, chemical tanks, or fuel tanks. The armor plate protection is shown in figure 8.

2. FLIGHT CONTROLS.

The ailerons, elevators, and rudder are conventionally operated by a control stick and rudder pedals. Trim tab controls (a wheel for the elevator tabs and knobs for the rudder and aileron tabs) and the flap control lever are on the control pedestal at the left side of the cockpit. A surface control locking gear is forward of the base of the control stick.

3. LANDING GEAR.

a. GENERAL.—The control lever for the hydraulically operated landing gear is on the left side of the cockpit.

When the surface control stick is pulled back, the tail wheel is linked to the rudder cables and is steerable 6 degrees right or left. With the control stick forward, the tail wheel is unlocked and full swiveling.

WARNING

Do not move the landing gear control when airplane is on the ground, as there is no safety mechanism to prevent the gear from retracting.

b. LANDING GEAR WARNING LIGHT.—A red-jeweled light on the left side of the instrument panel will illuminate when the throttle is retarded with the landing gear not locked in the down position. A push-button switch for testing the lamp is adjacent to the warning light.

4. BRAKES.

The multiple-disc brakes are hydraulically operated. Fluid for the brake system is obtained from the hydraulic reservoir. A standpipe in the reservoir reserves a supply of fluid for brake operation in case fluid for the hydraulic system is lost. The parking brake control is just below the center of the instrument panel. See figure 5 for brake system diagram.

RESTRICTED

DESCRIPTION
Sec I, Par 4

RESTRICTED
AN 01-60JE-1

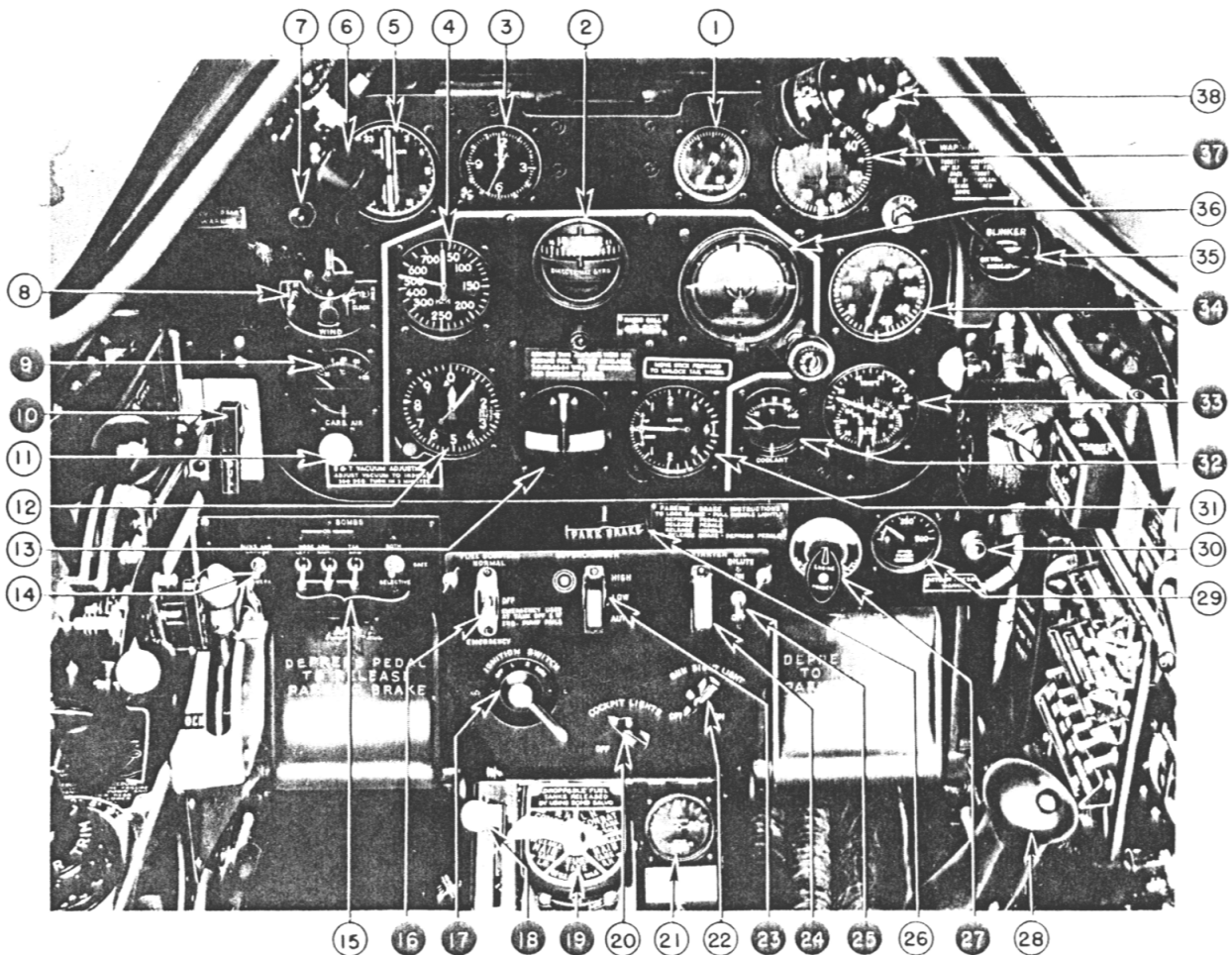

- | | | |
|---|-------------------------------------|---|
| 1. Suction Gage | 13. Bank-and-Turn Indicator | 26. Parking Brake Handle |
| 2. Directional Gyro | 14. Gun and Camera
Safety Switch | 27. Engine Primer |
| 3. Clock | 15. Bomb Control Switches | 28. Control Stick |
| 4. Airspeed Indicator | 16. Booster Pump Switch | 29. Oxygen Pressure Gage |
| 5. Remote Reading Compass Indicator | 17. Ignition Switch | 30. Oxygen System Warning Light |
| 6. Fluorescent Light | 18. Fuel Shut-off Control | 31. Rate-of-Climb Indicator |
| 7. Landing Gear Warning Light | 19. Fuel Selector Control | 32. Coolant Temperature Indicator |
| 8. Remote Contactor | 20. Cockpit Light Switch | 33. Oil Temperature and Fuel
and Oil Pressure Gage |
| 9. Carburetor Air
Temperature Indicator | 21. Hydraulic Pressure Gage | 34. Tachometer |
| 10. Boost Control | 22. Gun Sight Rheostat | 35. Oxygen Flow Blinker |
| 11. Bank-and-Turn Vacuum
Adjustment Knob | 23. Supercharger Control Switch | 36. Flight Indicator |
| 12. Altimeter | 24. Starter Switch | 37. Manifold Pressure Gage |
| | 25. Oil Dilution Switch | 38. Fluorescent Light |

Figure 2—Cockpit—Forward View

RESTRICTED
AN 01-60JE-1

DESCRIPTION
Sec I, Par 4

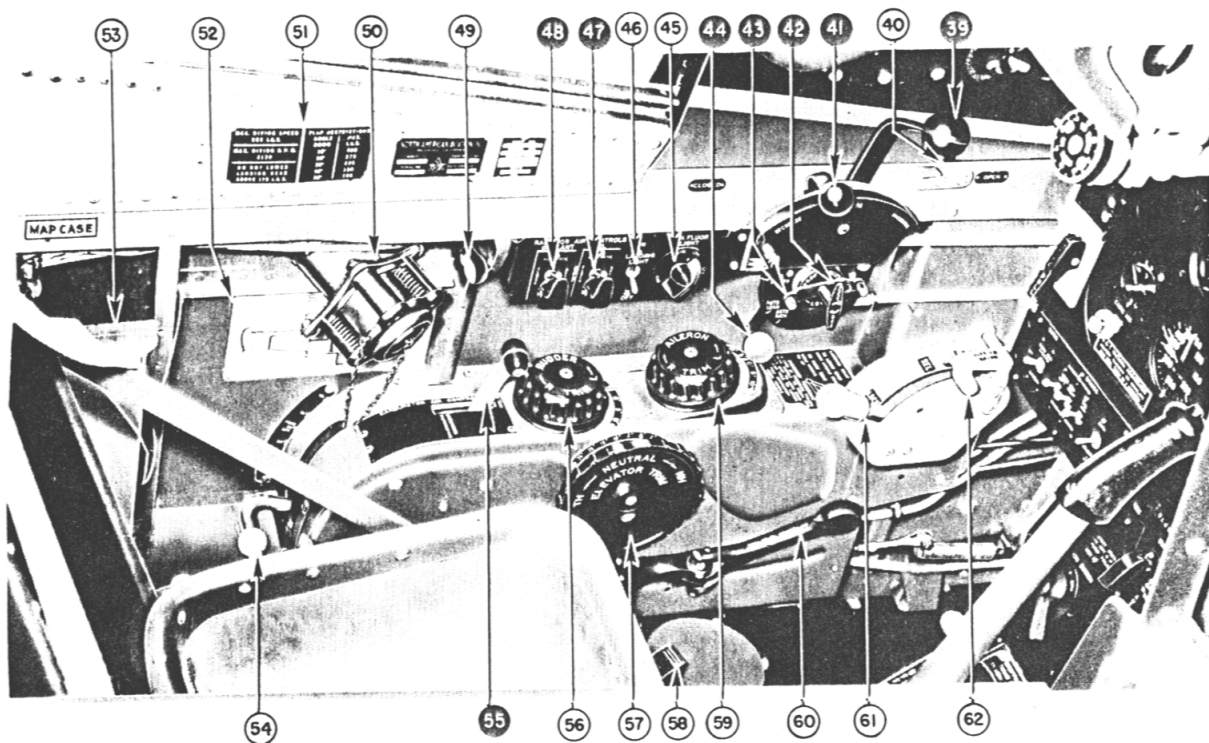

- | | |
|---|---------------------------------|
| 39. Throttle | 51. Airplane Restriction Plate |
| 40. Throat Microphone Switch | 52. Fuel System Diagram |
| 41. Propeller Control | 53. Map Case |
| 42. Throttle Friction Lock | 54. Wing Flap Control |
| 43. Propeller and Mixture Control Friction Lock | 55. Carburetor Air Control |
| 44. Mixture Control | 56. Rudder Trim Tab Control |
| 45. Left-hand Fluorescent Light Switch | 57. Elevator Trim Tab Control |
| 46. Landing Light Switch | 58. Signal Lamp Stowage Bracket |
| 47. Oil Cooler Exit Flap Control Switch | 59. Aileron Trim Tab Control |
| 48. Coolant Radiator Exit Flap Control Switch | 60. Landing Gear Control |
| 49. Cockpit Light | 61. Bomb Control Handle |
| 50. Pyrotechnic Pistol Mount | 62. Bomb Antisalvo Guard |

Figure 3—Cockpit—Left Side

RESTRICTED

DESCRIPTION
Sec I, Par 4

RESTRICTED
AN 01-60JE-1

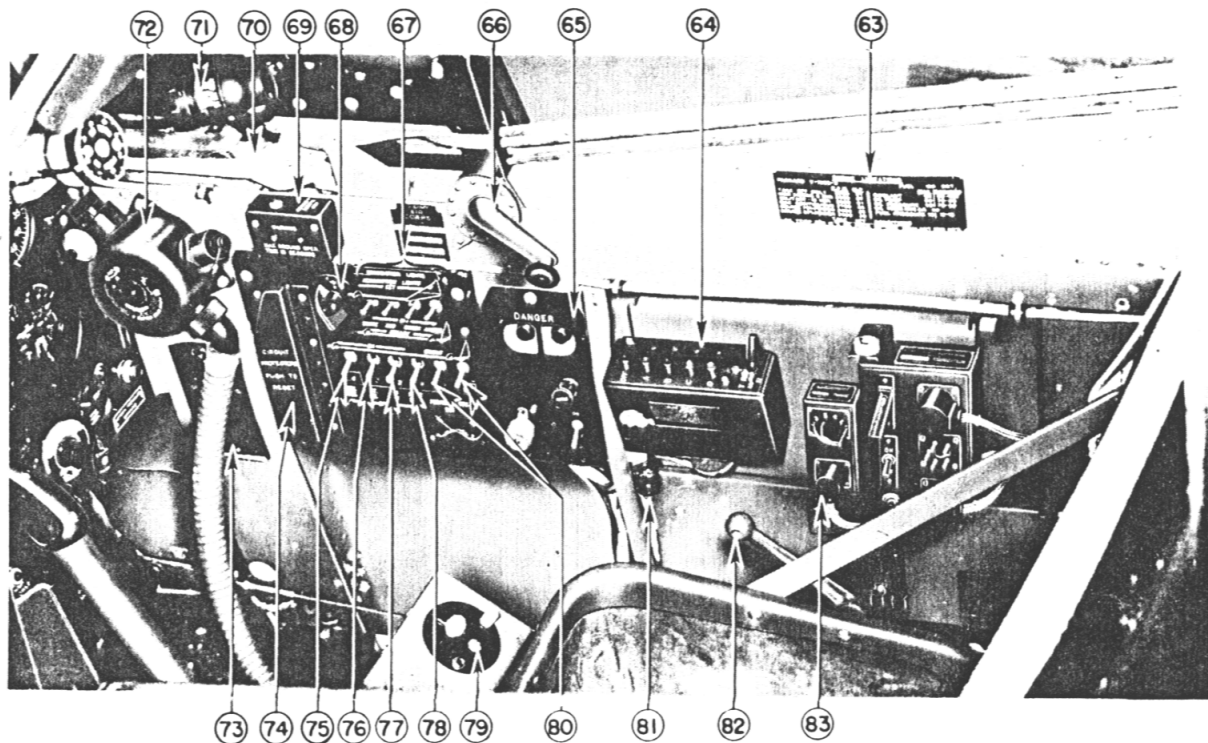

- | | |
|---|---------------------------------|
| 63. Engine Limitations Plate | 73. Spare Lamp Stowage |
| 64. SCR-522 Radio Control Box | 74. Circuit Breaker Reset Guard |
| 65. Detonator Switches | 75. Generator-disconnect Switch |
| 66. Canopy Handcrank | 76. Battery-disconnect Switch |
| 67. Recognition Light Switches | 77. Gun Heater Switch |
| 68. Right-hand Fluorescent Light Switch | 78. Pitot Heater Switch |
| 69. Recognition Lights Keying Switch | 79. Detrola Receiver |
| 70. Canopy Emergency Release Handle | 80. Position Light Switches |
| 71. Fluorescent Light | 81. Cockpit Light |
| 72. Oxygen Regulator | 82. Seat Adjustment Handle |
| | 83. SCR-695 Radio Control Box |

Figure 4—Cockpit—Right Side

RESTRICTED
AN 01-60JE-1DESCRIPTION
Sec I, Pars 5-6

Figure 5—Brake System

5. HYDRAULIC SYSTEM.

The hydraulic system (see figures 6 and 7) operates the landing gear and wing flaps. The wing flaps are preselectively set by moving the control lever, on the aft end of the control pedestal, to the desired flap setting. The flaps are automatically held in that position until another flap setting is selected. No emergency hydraulic hand-pump is provided.

6. POWER PLANT.

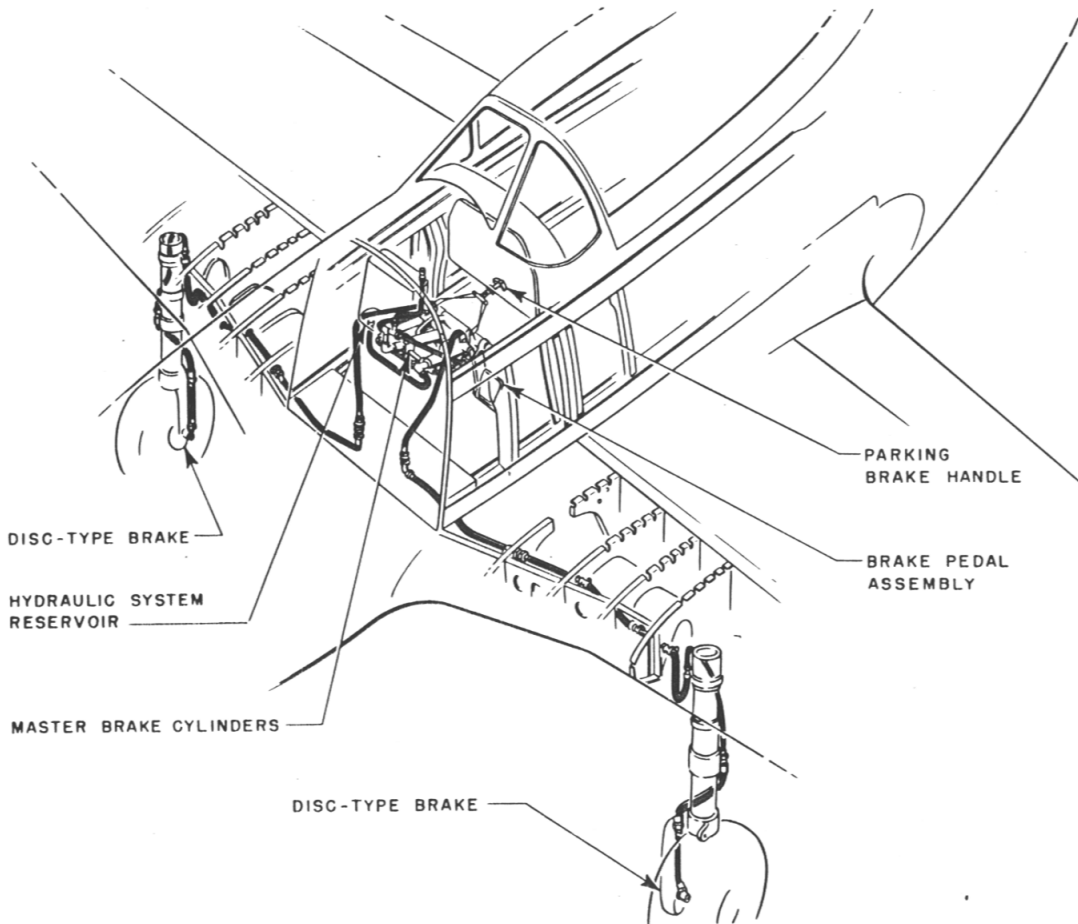
a. ENGINE.—The Packard built Rolls Royce, V-1650-7, twelve-cylinder engine incorporates a two-speed, two-stage supercharger and is equipped with an injection-type carburetor and an automatic manifold pressure regulator. An aneroid switch automatically controls the supercharger shift. Low blower ratio is 5.8:1 and high blower ratio is 7.3 to 1. Field modification kits are available to change supercharger gear ratios, converting V-1650-7 to V-1650-3.

b. FUEL, OIL, AND COOLANT.

Fuel	Spec. AN-F-28, Grade 100/130
Oil	Spec. AN-O-5, Grade 1100
Coolant	70% water and 30% ethylene glycol (Spec. AN-E-2) treated with NaMBT







c. ENGINE CONTROLS.—The engine control quadrant has two friction locks, one for the throttle and one for the propeller and mixture controls. The three mixture control positions are: "IDLE CUT OFF," "AUTO LEAN," and "AUTO RICH."

d. CARBURETOR AIR.—The air induction system supplies either ram air or unrammed, filtered air to the carburetor. The control handle for the system is at the pilot's left. Whenever the air duct becomes obstructed, emergency

RESTRICTED

DESCRIPTION
 Sec I, Par 6

RESTRICTED
 AN 01-60JE-1

-  SYSTEM PRESSURE
-  SYSTEM RETURN
-  PUMP SUCTION
-  WING FLAP DOWN PRESSURE
-  WING FLAP UP PRESSURE
-  VENT & DRAIN

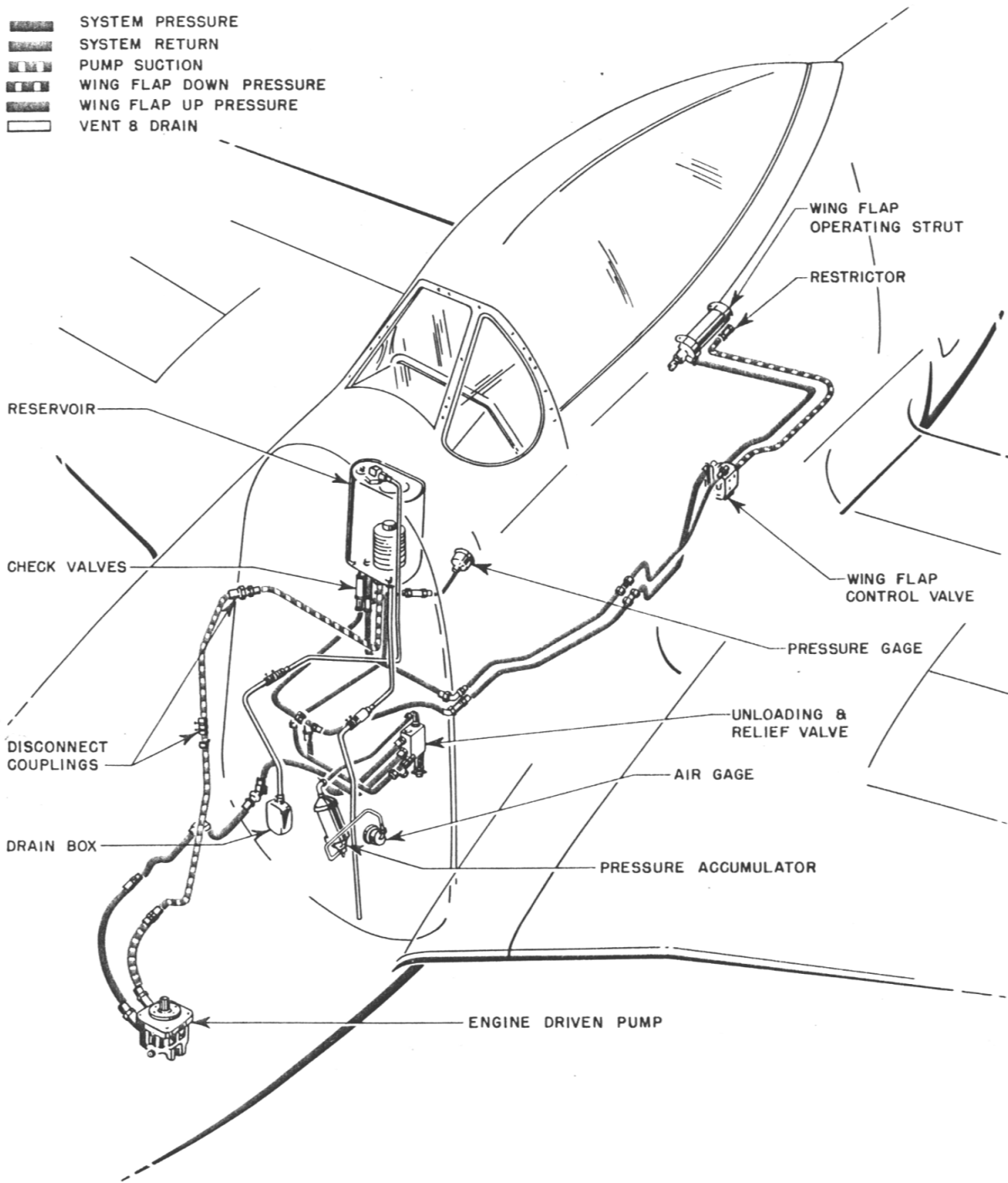

Figure 6—Hydraulic Power and Wing Flap Systems

RESTRICTED
AN 01-60JE-1

DESCRIPTION
Sec I, Par 6

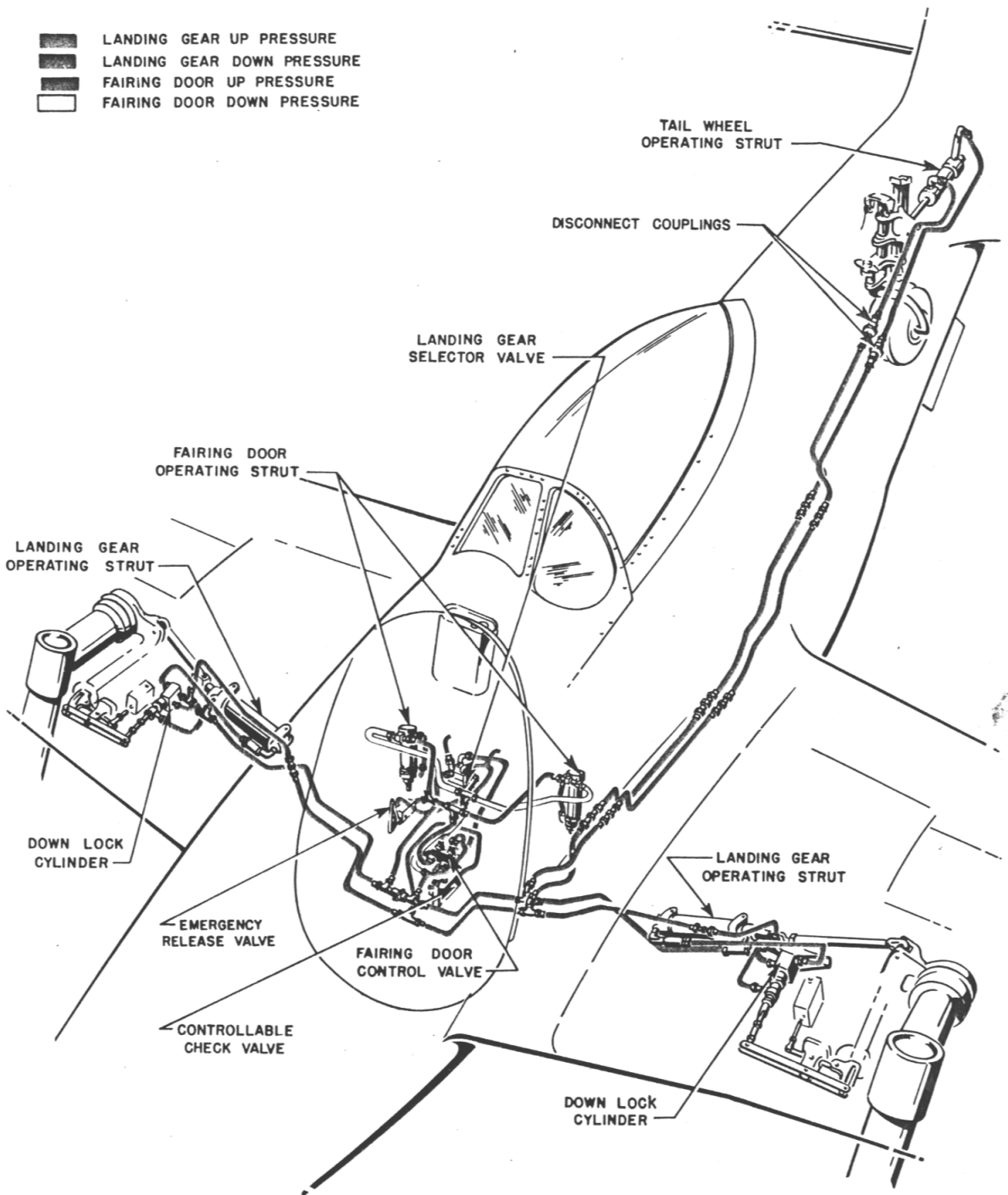

Figure 7—Hydraulic Landing Gear System

RESTRICTED

DESCRIPTION
Sec I, Pars 6-10

RESTRICTED
AN 01-60JE-1

NOTE

All airplanes equipped with 85-gallon fuselage fuel tanks may be identified by a white plus (+) sign printed below the serial number on the left-hand side of the fuselage.

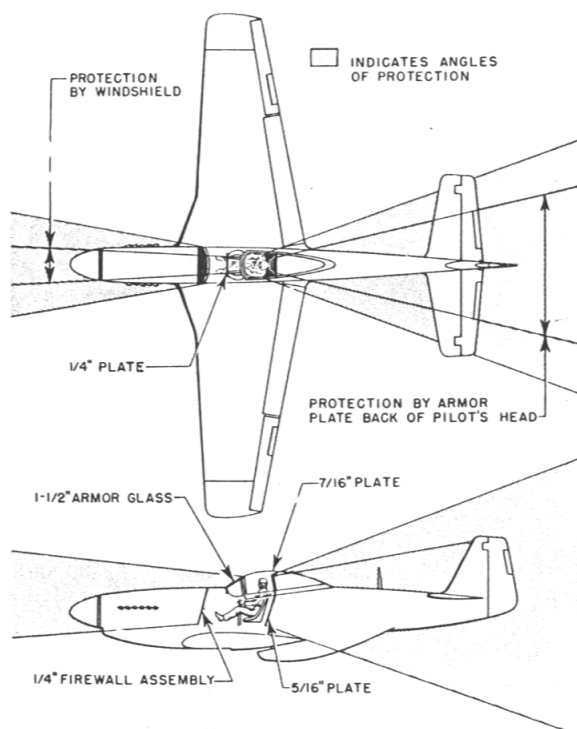

Figure 8—Armor Protection

doors will automatically open to allow engine compartment air to enter the carburetor.

e. PROPELLER.—The airplane is equipped with a Hamilton Standard, four-blade, hydraulically operated constant-speed propeller, 11 feet 2 inches in diameter. The pitch settings are 23° low, 65° high.

7. FUEL SYSTEM.

Two self-sealing fuel tanks are carried in the wing, and an auxiliary 85-gallon, self-sealing tank is installed in the fuselage. The fuselage tank is located aft of the cockpit and is equipped with a goose-necked gage visible to the pilot. Two 75-gallon, pressurized combat tanks may be installed on the wing racks. Fuel flows as follows: from either of the wing tanks or the fuselage tank through a booster pump to the fuel selector valve; through the selector valve, shut-off valve, and fuel strainer to the engine-driven fuel pump; then to the carburetor. Fuel from the combat tanks flows through the selector valve into the main fuel line. All main fuel lines are self-sealing. See figure 9 for fuel system diagram.

8. OIL SYSTEM.

The oil tank is mounted on the forward face of the firewall. Scavenged oil flows from the engine to an oil cooler located in the lower section of the fuselage, beneath the cockpit. A thermostatically controlled air duct exit flap regulates the flow of air through the oil cooler. The oil dilution system is controlled by a switch on the upper right side of the pilot's switch panel. The oil system is shown in figure 10.

9. COOLING SYSTEMS.

The engine incorporates two cooling systems (*see figure 11*): one cools the engine and the other cools the supercharger fuel-air mixture. Each system has a separate pump, expansion tank, and radiator. The two coolant radiators, constructed as a unit, are located in the air duct above and aft of the oil cooler. An air duct exit flap, thermostatically controlled by the temperature of the main cooling system, regulates the flow of air through the radiators.

10. ELECTRICAL SYSTEM.

The electrical system is a 24-volt direct-current type, receiving power from a 100-ampere engine-driven generator system supplemented with a 24-volt storage battery which supplies current when the generator system is inoperative. A single-wire direct current distribution system is used, the metallic structure of the airplane serving as a ground. An external power socket is located on the right side of the fuselage just behind the cockpit. External power should be used instead of the airplane battery to start the engine and operate the electrical system while the airplane is on the ground. An adapter for connecting the British type of external power supply is stowed adjacent to the external power socket. All of the electrical circuits are protected by either circuit breakers or circuit-breaker switches located on the right switch panel. See figures 2 and 4 for location of main electrical switches.

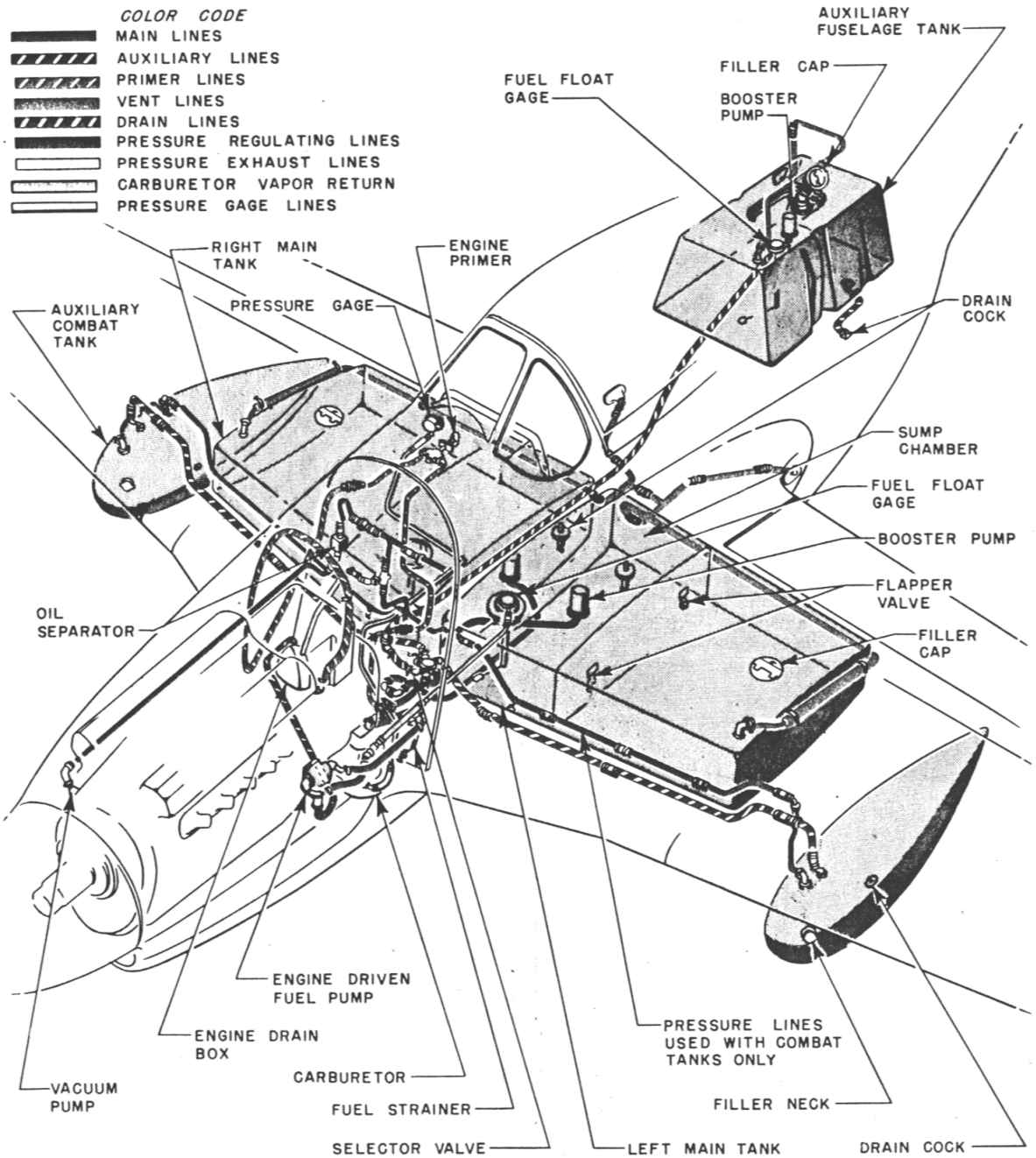

Figure 9—Fuel System

DESCRIPTION
 Sec I, Par 10

RESTRICTED
 AN 01-60JE-1

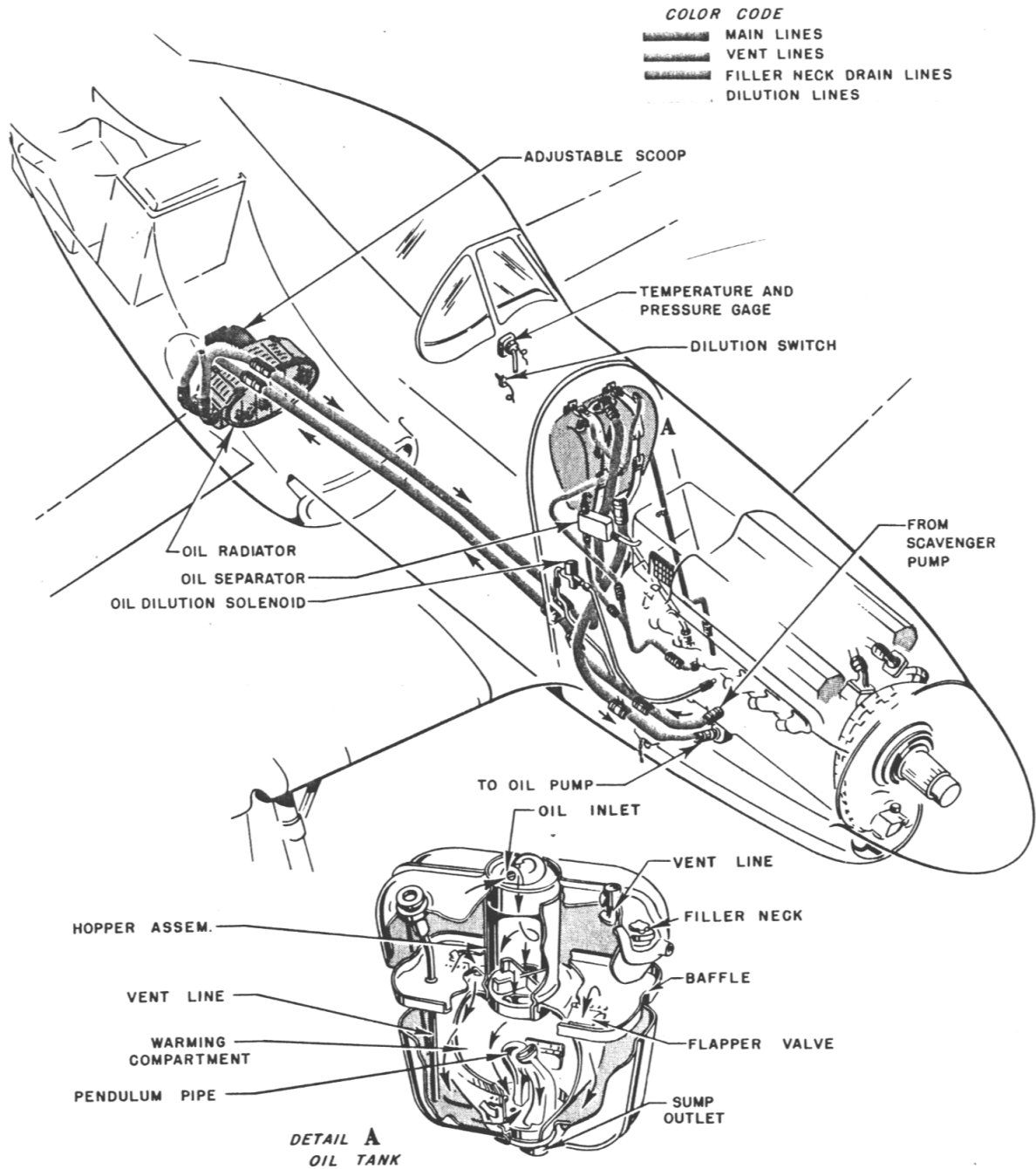

Figure 10—Oil System

RESTRICTED
AN 01-60JE-1

DESCRIPTION
Sec 1, Par 10

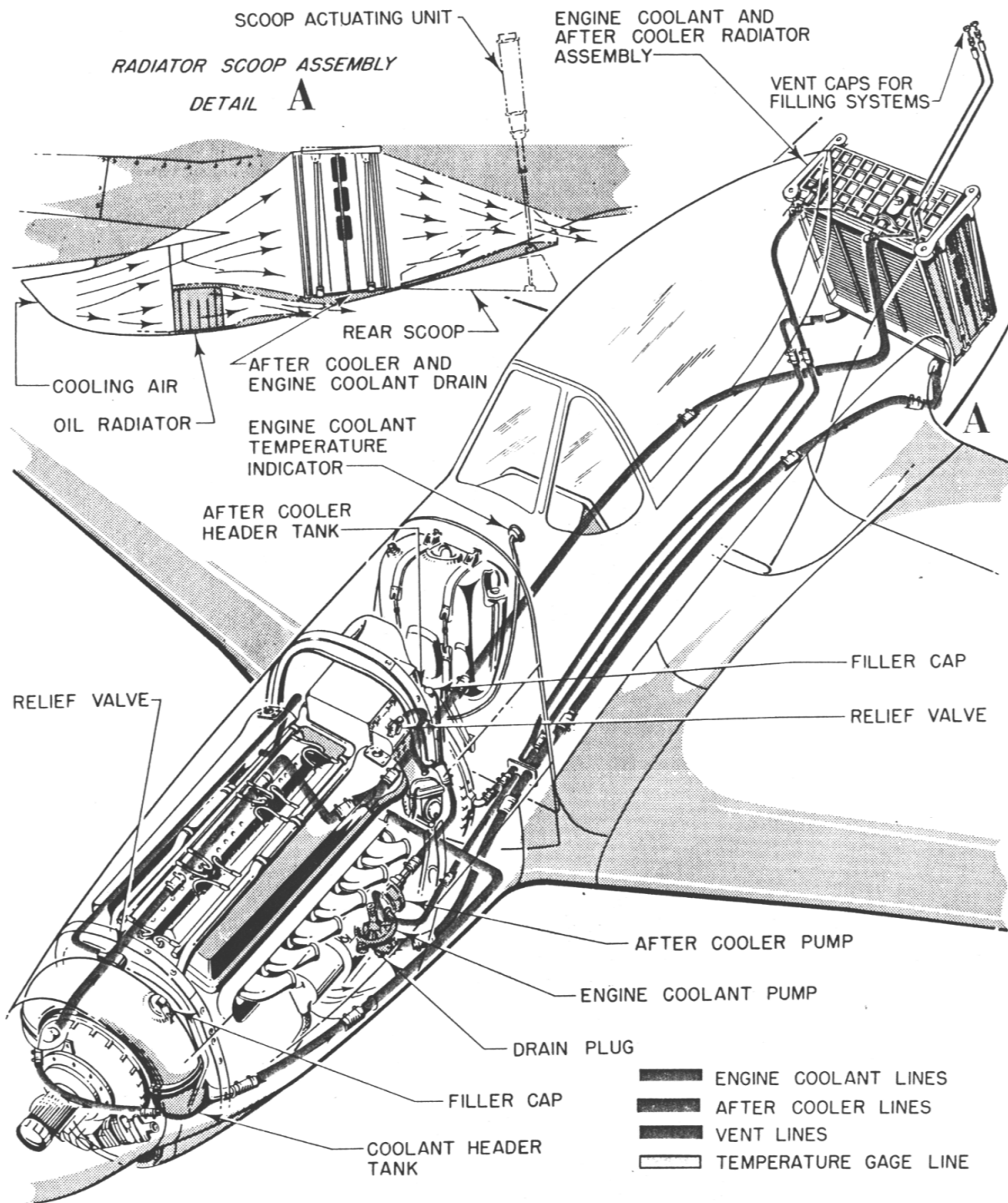

Figure 11—Cooling Systems

RESTRICTED

DESCRIPTION
Sec I, Par 11

RESTRICTED
AN 01-60JE-1

11. MISCELLANEOUS EQUIPMENT.

a. **MEDICAL FIRST-AID KIT.**—A medical first-aid kit is fastened to a holder on the fuselage at the right of the pilot's seat.

b. **PILOT'S RELIEF TUBE.**—The relief tube horn is stowed on a bracket on the floor to the left of the pilot's seat.

c. **DROP MESSAGE BAG.**—A drop message bag is contained in a holder on the map case cover.

d. **FLASHLIGHT.**—A small flashlight is located on the left underside of the instrument cowl.

e. **ENGINE CRANK.**—An engine crank and extension tube are stowed on brackets at the back of the right main landing gear well.

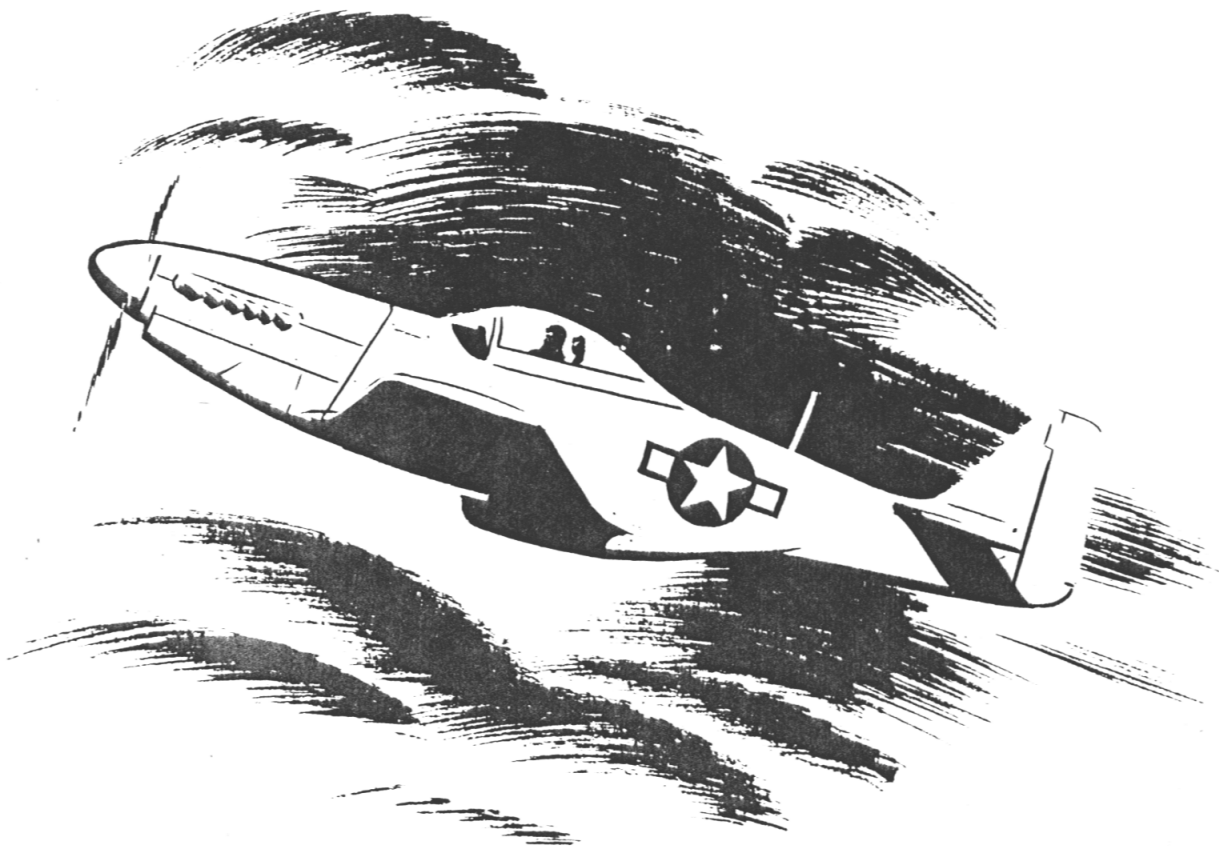

RESTRICTED
AN 01-60JE-1

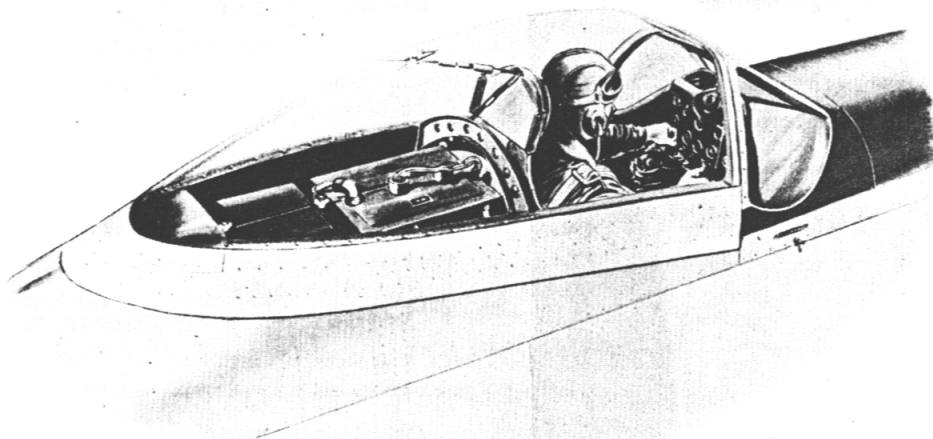

SECTION II

Pilot's Operating Instructions

NOTE

A pilot's check list and an engine limitations plate are provided in the cockpit for a quick check of airplane operations.

1.. FLIGHT RESTRICTIONS.

a. MANEUVERS PROHIBITED.

(1) When external fuel tanks are installed, only normal flying attitudes are permitted.

(2) Inverted flying must be limited to 10 seconds because of loss of oil pressure and failure of the scavenger pumps to operate in an inverted position.

(3) Intentional "power-off" spins are permitted, provided such spins are started above 12,000 feet.

(4) Intentional "power-on" spins and snap rolls are prohibited.

b. AIRSPEED LIMITATIONS.

(1) The maximum permissible diving speed is 505 IAS.

(2) Observe the following wing flap setting airspeed restrictions:

(a) With wing flap setting at 10 degrees, do not exceed 400 IAS.

(b) With wing flap setting at 20 degrees, do not exceed 275 IAS.

(c) With wing flap setting at 30 degrees, do not exceed 225 IAS.

(d) With wing flap setting at 40 degrees, do not exceed 180 IAS.

(e) With wing flap setting at 50 degrees, do not exceed 165 IAS.

(3) In a sideslip, stay above 110 IAS.

(4) Do not extend landing gear above 170 IAS.

(5) With droppable 75-gallon combat fuel tanks installed, speed is limited to about 400 IAS due to incipient buffeting.

2. BEFORE ENTERING COCKPIT.

a. Make sure the airplane has been serviced and is ready for flight, particularly in regard to proper quantities of fuel, oil, coolant, hydraulic fluid, and oxygen.

RESTRICTED

PILOT'S OPERATING INSTRUCTIONS
Sec II, Pars 2-3

RESTRICTED
AN 01-60JE-1

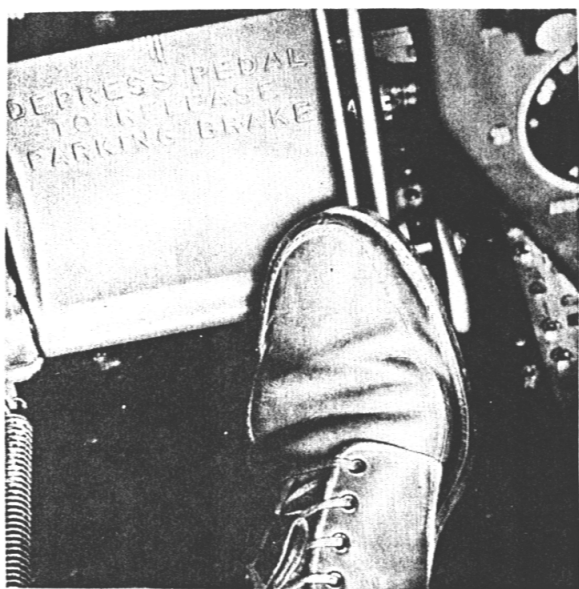

Figure 12—Rudder Pedal Adjustment

b. Ascertain that the total weight of fuel, oil, ammunition and special equipment carried is suited to the mission to be performed. This is most important in the case of combat missions, as the rate of climb of the airplane may vary as much as 500 feet per minute, depending on the load carried.

c. Prior to any ground run-up exceeding 40 in. Hg manifold pressure, see that the tail of the airplane is anchored securely to a fixed object. If wheel chocks are available, use them also.

d. To gain access to cockpit, push in on spring-loaded door on left forward side of sliding canopy, and slide canopy aft.

3. ON ENTERING COCKPIT.

a. The following procedures should be carried out prior to all flights:

(1) Adjust rudder pedals for proper leg length so as to obtain full brake control while taxiing. Adjustment may be made with the foot by pressing the lever located on the inner side of each rudder pedal.

(2) Adjust the seat level to obtain full travel of the rudder pedals in the extreme positions. The adjustment lever for raising or lowering the seat is located on the right side of the seat.

(3) See that ignition switch is "OFF."

(4) Set parking brakes by pulling out the handle below the center of the instrument panel, depressing the brake pedals, releasing the pedals, and then releasing the handle.

(5) On early airplanes only, make sure the bomb release handle is in the "LOCK" position and the antiservo guard is in place.

(6) See that the bomb and gun safety switches are "OFF."

(7) See that landing gear control handle is in the "DOWN" position.

(8) Unlock surface control lock at the base and just forward of the control stick by pulling the plunger on the left side of the lock. Check the controls for free and proper movement, watching control surfaces for correct response.

(9) Set altimeter to correct barometric pressure.

(10) Test gun sight illumination by operating rheostat control on pilot's switch panel. (Gun safety switch must be moved to "GUNS" or "GUNS AND CAMERA" for test.)

(11) Check remote reading compass for correct reading.

(12) Check landing gear warning light on instrument panel by pushing test switch adjacent to light.

(13) Close sliding canopy as follows:

(a) Push in on axle of crank on right side of cockpit to engage clutch.

1. SHOULDER HARNESS
2. KAPOK-FILLED CUSHION
3. SAFETY BELT
4. SEAT ADJUSTING LEVER
5. HARNESS TENSION RELEASE

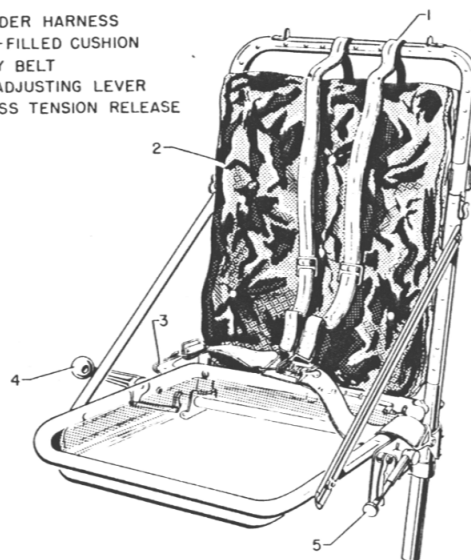

Figure 13—Pilot's Seat

RESTRICTED
AN 01-60JE-1

PILOT'S OPERATING INSTRUCTIONS
Sec II, Pars 3-4

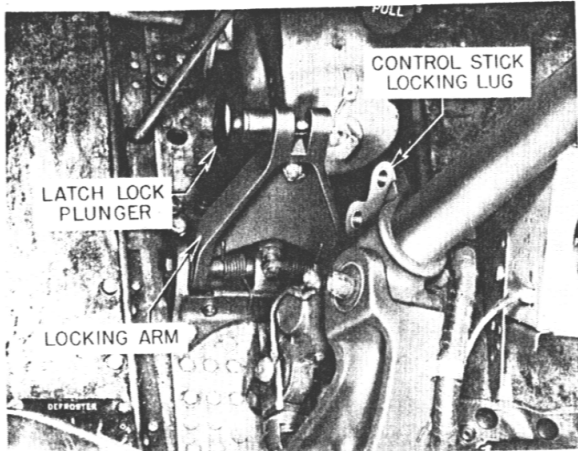

Figure 14—Surface Control Lock

(b) Disengage pin on crank handle from the holes on the face of the clutch housing by pulling crank knob inboard gently.

(c) Turn crank counterclockwise, holding knob inboard, to close canopy.

WARNING

If red indicators show through openings on each side of the forward end of the enclosure, the emergency release is unlocked and unsafe for flight.

b. When night flying is anticipated, the following additional checks should be made:

(1) Test fluorescent instrument lights by operating rheostat controls. The control for the left light is on the radiator air control panel; the control for the right light is on the right-hand switch panel.

(2) Test position lights by moving switches on right-hand switch panel to "BRIGHT" and "DIM."

(3) Test landing light by operating switch on radiator air control panel.

(4) Test cockpit swivel lights on each side of cockpit by turning on switch located on lamp housing. The cockpit light master switch on the pilot's switch panel must be "ON" before turning on the lights.

(5) Test operation of recognition lights; the switches are on the right-hand switch panel. The keying switch is on the right longeron.

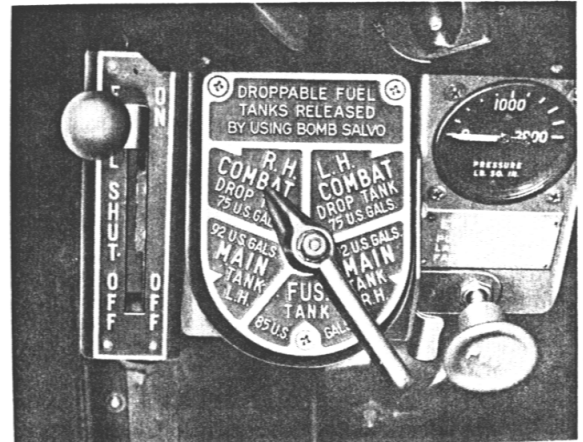

Figure 15—Fuel Selector Control

NOTE

Do not operate recognition lights longer than 10 seconds on the ground.

4. FUEL SYSTEM MANAGEMENT.

a. Take off and climb to a safe altitude with the fuel selector valve on "FUS. TANK," and the booster pump switch in "EMERGENCY." If fuselage tank is not serviced, take off and climb with fuel selector valve on "MAIN TANK L.H."

NOTE

The fuselage tank should be used for take-off and climb to a safe altitude as it is the most direct system to the engine and is on a higher plane in relation to the engine. Use of the fuselage tank fuel will also move the C.G. of the airplane forward to a more desirable position for flight.

b. When a safe altitude has been reached, when droppable tanks are installed, switch fuel selector valve to either of the droppable tank positions and use the fuel from them alternately until they are empty; then drop them.

NOTE

The combat tanks have no booster pump; a controlled pressure of 5 lbs./sq. in. is maintained within the tanks by pressure obtained from the vacuum pump.

c. Switch selector valve back to "FUS. TANK," with booster pump switch in "NORMAL," and use all but 25 gallons of the fuel to relieve tail heaviness.

RESTRICTED

15

PILOT'S OPERATING INSTRUCTIONS

Sec II, Pars 4-5

RESTRICTED
AN 01-60JE-1

Figure 16—Fuel System Line Diagram

IMPORTANT

It is desirable to retain approximately 25 gallons of fuel in the fuselage tank in order to have the C.G. of the airplane in the optimum position for landing.

d. Switch selector valve to "MAIN TANK L.H."; alternately use fuel from the left and right main tanks to avoid wing heaviness until the wing tanks are empty.

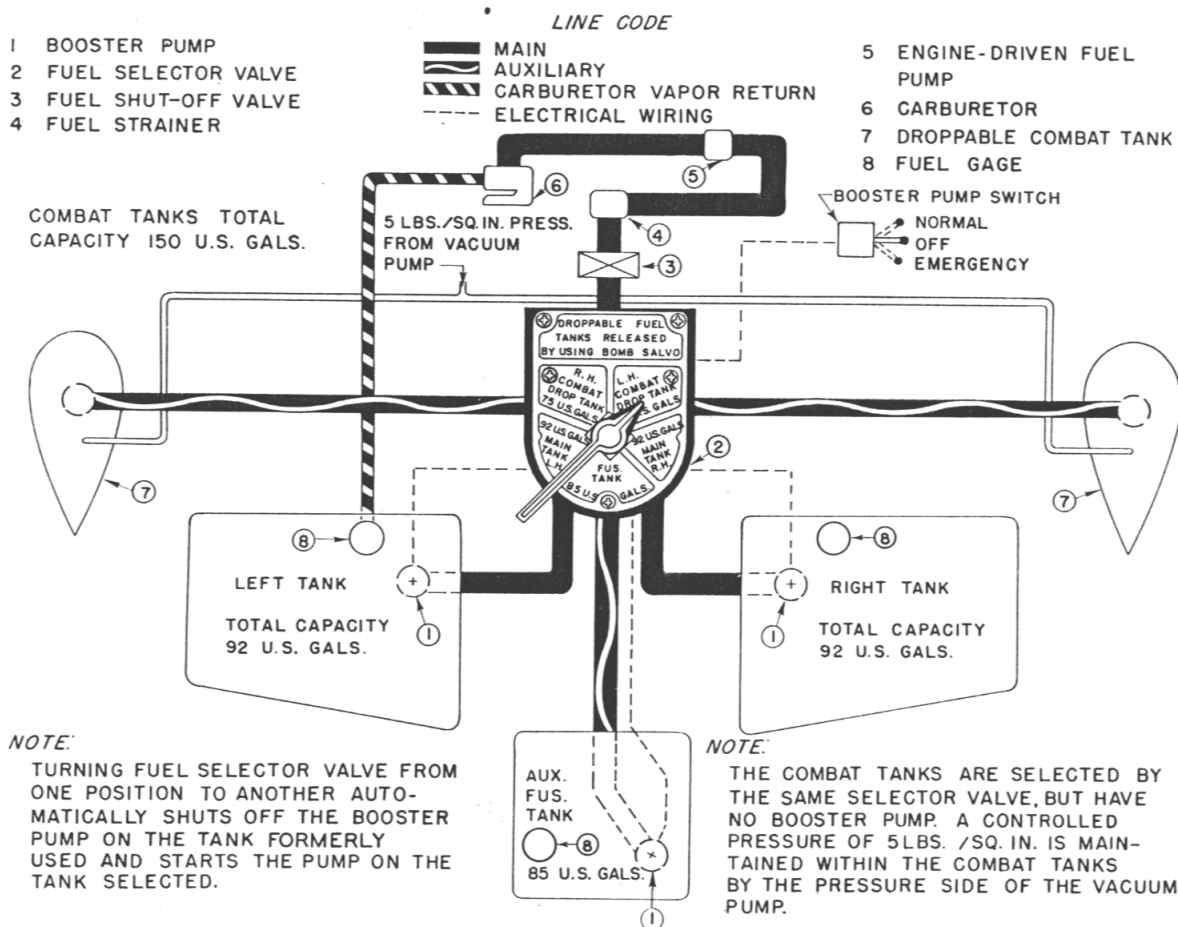
NOTE

Turning the selector valve from one position to another automatically shuts off the booster pump on the tank formerly used and starts the pump on the tank selected.

e. When wing tanks are empty, switch selector valve back to "FUS. TANK."

5. STARTING ENGINE.

a. The sequence of operations listed below should be followed in starting the engine.

- (1) See that ignition switch is "OFF."
- (2) Turn generator-disconnect and battery-disconnect switches "ON." These switches are located on the right-hand switch panel.
- (3) Have ground personnel turn the propeller several revolutions by hand.
- (4) Open throttle one inch.
- (5) Move mixture control to "IDLE CUT OFF."
- (6) Move propeller control to full "INCREASE."

RESTRICTED
AN 01-60JE-1

PILOT'S OPERATING INSTRUCTIONS
Sec II, Par 5

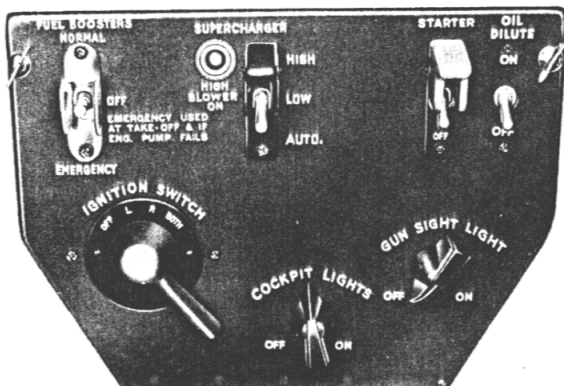

Figure 17—Pilot's Switch Panel

(7) Make certain boost control on lower left side of instrument panel is in "AUTOMATIC."

(8) See that supercharger blower switch on pilot's switch panel is in "AUTO."

(9) Turn oil and coolant radiator air control switches at left side of cockpit to "AUTOMATIC."

(10) Move carburetor air control at aft end of control pedestal to "RAM AIR" ("UNRAMMED FILTERED AIR," if required).

(11) Turn ignition switch on pilot's switch panel to "BOTH."

(12) Turn "ON" fuel shut-off control, which is adjacent to the fuel selector valve at base of pilot's switch panel, place booster pump switch in "NORMAL," and turn fuel

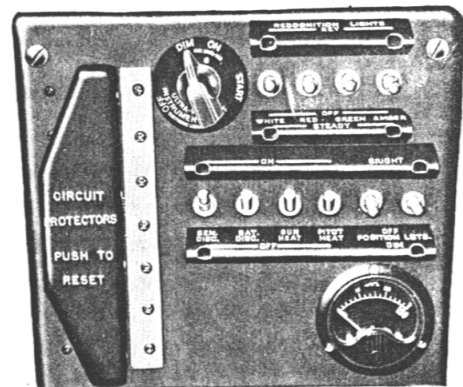

Figure 18—Right-hand Switch Panel

selector valve to "FUS. TANK," or "MAIN TANK L.H." if fuselage tank is not serviced.

(13) Check fuel pressure gage for 8 to 12 pounds pressure.

(14) Prime engine 3-4 strokes when cold, one when hot.

(15) Check to see that propeller is clear.

(16) Lift guard on starter switch on pilot's switch panel and press switch to "START."

NOTE

Whenever possible, an external power supply should be used to start the engine. If external power is not available, use handcrank. Use airplane's battery in an emergency only.



Figure 19—Radiator Air Control Panel

RESTRICTED

PILOT'S OPERATING INSTRUCTIONS
 Sec II, Pars 5-7

RESTRICTED
 AN 01-60JE-1

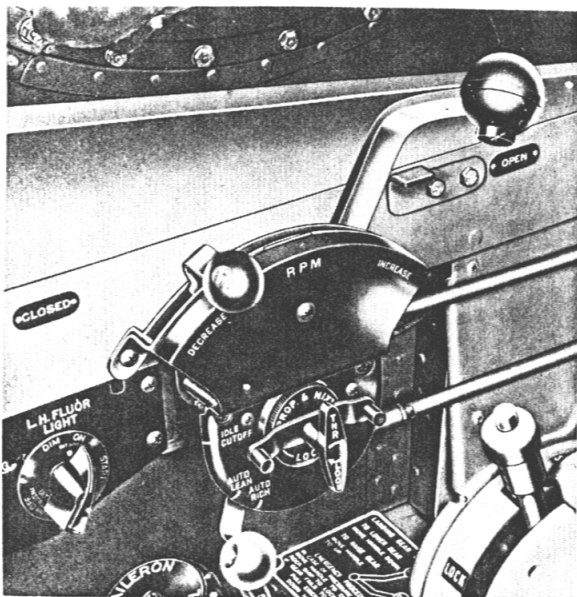

Figure 20—Engine and Propeller Controls

(17) As engine starts, move mixture control to "AUTO RICH." If engine does not start after several turns, continue priming.

WARNING

When engine is not firing, mixture control should be in "IDLE CUT OFF."

(18) Check oil pressure. If pressure is not up to 50 pounds within 30 seconds, stop engine and investigate.

6. ENGINE WARM-UP.

Warm up the engine at 1300 rpm until the oil temperature shows a definite increase and the oil pressure remains steady when the throttle is opened. The desired oil and coolant temperatures will be maintained by having the radiator air controls in "AUTOMATIC."

	DESIRED	MAXIMUM
Oil temp.	70- 80°C (158-176°F)	90°C (194°F)
Coolant temp.	100-110°C (212-230°F)	121°C (250°F)

If coolant and oil temperatures exceed limits with controls in "AUTOMATIC," shut engine off and investigate.

7. EMERGENCY TAKE-OFF.

Use oil dilution (2 minutes maximum) to obtain proper oil pressure at moderate power, and as soon as the engine will take the throttle, taxi out, and take off.

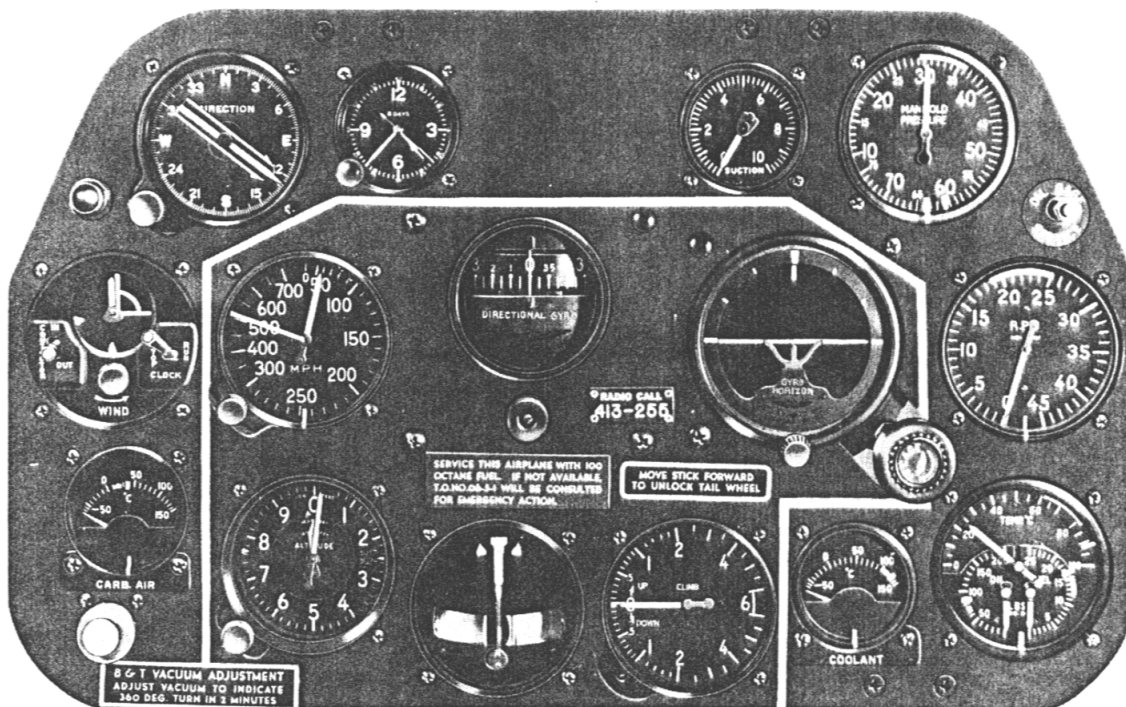

Figure 21—Instrument Panel

RESTRICTED
AN 01-60JE-1

PILOT'S OPERATING INSTRUCTIONS
Sec II, Pars 7-8

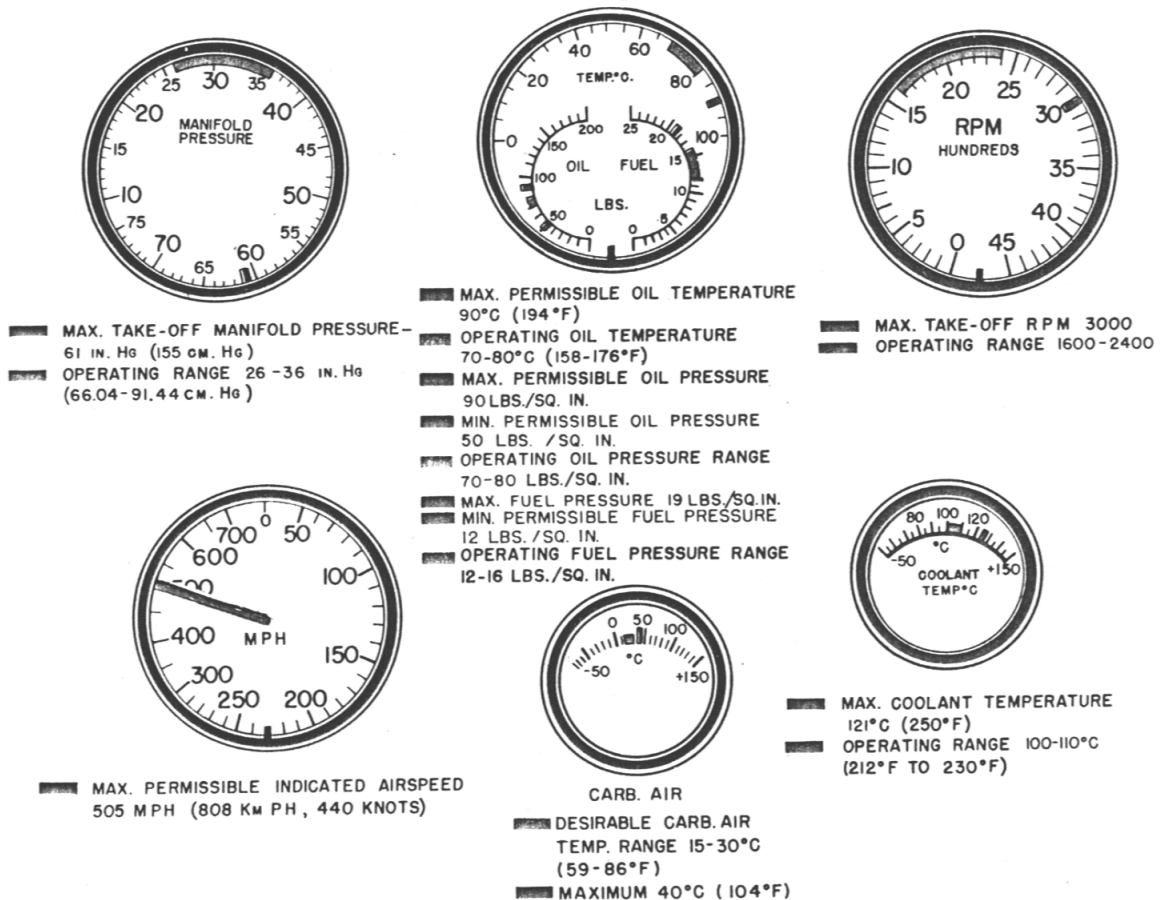

Figure 22—Instrument Limitations

NOTE

Overdilution is likely to result under these conditions because of low oil flow and a cold engine which holds back evaporation. If dilution is used, close observation of the oil pressure will be necessary during the time of dilution and take-off to determine whether or not the oil has been over-diluted, resulting in low oil pressure, and loss of oil through the engine breathers.

8. ENGINE AND ACCESSORIES OPERATION GROUND TEST.

a. After the engine has been warmed up sufficiently, proceed with these tests:

(1) Check both left and right main and fuselage fuel systems by rotating fuel selector with booster pump switch

in "EMERGENCY." Check for 14-19 lbs./sq. in. pressure. If droppable tanks are installed, check fuel flow by rotating fuel selector control.

(2) Check operation of wing flaps.

(3) Check operation of radiator air exit flaps (with assistance of outside observer) using override positions of radiator air control switches. Return switches to "AUTOMATIC."

(4) Check communication equipment for proper operation.

(5) At 2000 rpm, check the following:

Suction	3.75-4.25 in. Hg
Hydraulic pressure	800-1100 lbs./sq. in.
Ammeter	100 amperes maximum

RESTRICTED

19

ENGINE LIMITATIONS			
PACKARD V-1650-7		FUEL: 100 OCT.	
	R.P.M.	M.P.	MAX. DESIRED
TAKE OFF ONLY	3000	61	COOLANT 121 100-110
WAR EMERG. 5 MIN.	3000	67	OIL TEMP. 90 70-80
MILITARY-15 MIN.	3000	61	OIL PRESSURE 90 70-80
MAX. CONTINUOUS	2700	46	OIL PRES. MIN. CR. 50
CRUISE-MAX.	2400	36	FUEL PRESSURE 19 12-16
TAKE OFF CONDITIONS			
OIL TEMP. 15°C MIN. OIL PRES. 90" MAX. COOLANT 60° MIN.			

MAX. DIVING SPEED	FLAP RESTRICTIONS
505 I.A.S.	ANGLE MAX.
MAX. DIVING R. P. M.	DOWN I. A. S.
3240	10° 400
DO NOT LOWER	20° 275
LANDING GEAR	30° 225
ABOVE 170 I.A.S.	40° 180
	50° 165

Figure 23—Engine and Airplane Limitations

(6) Check the instruments for the following limitations:

	DESIRED	MAXIMUM
Oil pressure	70-80 lbs./sq. in.	90 lbs./sq. in.
Oil temp.	70-80°C (158-176°F)	90°C (194°F)
Coolant temp.	100-110°C (212-230°F)	121°C (250°F)
Fuel pressure	12-16 lbs./sq. in.	19 lbs./sq. in.

(7) With propeller control in full "INCREASE," move throttle forward to obtain 2300 rpm. Check each magneto. A maximum loss of 100 rpm is allowable.

(8) At 2300 rpm, move propeller control back to note maximum drop of 300 rpm. Then move forward to full "INCREASE."

(9) Check supercharger operation: Set propeller control at full "INCREASE," engine speed 2300 rpm, and hold

supercharger switch in "HIGH." Note rpm drop (at least 50 rpm).

(10) Notify ground personnel to release tail and remove wheel chocks.

9. TAXIING.

a. Observe the following generalities when taxiing:

- (1) Raise the wing flaps.

WARNING

To prevent damage to the wing flaps, they must be up when taxiing. In addition, always taxi cautiously so as to avoid damage from objects which the tires might pick up and throw against the radiator exit flaps.

RESTRICTED
AN 01-60JE-1

PILOT'S OPERATING INSTRUCTIONS
Sec II, Pars 9-12

(2) Steer a zigzag course to obtain an unobstructed view.

(3) Taxi with the stick slightly aft of neutral to lock the tail wheel. In the locked position, the tail wheel may be turned 6 degrees to the right or left by the rudder pedals. For sharp turns, push the stick forward of the neutral position to allow the tail wheel full swiveling action.

(4) Use the brakes as little as possible and always taxi cautiously.

(5) Upon reaching the take-off position, stop the airplane cross-wind so that approaching airplanes may be plainly seen.

10. BEFORE TAKE-OFF.

a. Follow this sequence of operations before take-off:

(1) Set rudder trim 5° to the right, elevator trim 6° back for flaps down take-off; 3° back for flaps up take-off; aileron trim 0 degrees. With full combat and fuselage tanks and a full load of ammunition, set elevator trim 1/2 degree back for flaps down take-off.

(2) Check flying controls for free movement (look at control surfaces).

(3) Check fuel levels.

(4) See that fuel selector valve is set on "FUS. TANK" or "MAIN TANK L.H.," if fuselage tank is not serviced, and that booster pump switch is in "EMERGENCY" (pressure 14-19 pounds).

(5) Generator-disconnect switch "ON."

(6) Mixture control "AUTO RICH."

(7) Propeller control full "INCREASE."

(8) Supercharger blower switch "AUTO."

(9) Oil and coolant radiator air controls "AUTOMATIC."

(10) Boost control "AUTOMATIC."

(11) Carburetor air control "RAM AIR" ("UNRAMMED FILTERED AIR," if required).

(12) Sliding canopy closed and emergency release handle safetied.

11. TAKE-OFF.

a. When take-off area is clear, quickly check the following:

(1) Wing flaps 20° down ("TAKE-OFF" position).

(2) Gyro instruments "UNCAGED."

NOTE

The gyro instruments should be left "UNCAGED" at all times except during acrobatics.

(3) Oil pressure 70-90 pounds.

(4) Oil temperature 15°C (59°F) minimum, 90°C (194°F) maximum.

(5) Coolant temperature 60°C (140°F) minimum, 121°C (250°F) maximum.

(6) Open throttle to 61 in. Hg manifold pressure, and take off at 3000 rpm (5 minutes maximum).

(7) Do not attempt to lift the tail too soon, as this increases the torque action. Pushing the stick forward unlocks the tail wheel, thereby making steering difficult. The best take-off procedure is to hold the tail down until sufficient speed is attained, and then raise the tail slowly.

12. ENGINE FAILURE DURING TAKE-OFF.

a. The chances of the engine failing during take-off can be greatly reduced and prepared for by observing the following practices:

(1) Run up engine carefully and check thoroughly before take-off.

(2) Retract the landing gear as soon as the airplane is definitely airborne.

(3) Raise the flaps as soon as the airplane reaches a safe altitude.

b. If the engine fails immediately after the take-off, act quickly as follows:

(1) Depress the nose at once so that the airspeed does not drop below stalling speed.

(2) If external fuel tanks or bombs are installed, release them immediately.

(3) Release the sliding canopy by pulling the emergency release handle on top of the longeron just to the right of the instrument panel.

PILOT'S OPERATING INSTRUCTIONS
Sec II, Pars 12-14

RESTRICTED
AN 01-60JE-1

IMPORTANT

When releasing the canopy, bend forward and lower head slightly so as to avoid a head injury from the loose enclosure.

(4) Make sure landing gear has started to come up. There is no time to take further action, and even if it is only unlocked and on the way up, the gear will collapse on landing. Do not try to lower gear. There is less chance of personal injury if the airplane is landed with the gear up.

(5) Lower the flaps fully, if possible.

(6) Move mixture control to "IDLE CUT OFF" and turn "OFF" ignition switch.

(7) Turn fuel shut-off valve "OFF."

(8) Turn battery-disconnect switch "OFF."

(9) Land straight ahead, only changing direction sufficiently to miss obstructions.

(10) After landing, get out of the airplane as quickly as possible and remain outside.

13. CLIMB.

a. As soon as the airplane is sufficiently clear of the ground, proceed as follows:

(1) Retract the landing gear by pulling the landing gear control handle inboard and up. The handle is located on the control pedestal to the left and just forward of the seat.

(2) Raise the flaps by pulling flap control to the full up position when sufficient airspeed is attained and all obstacles are cleared. No sink is noticeable when the flaps are raised.

(3) Check the coolant and oil temperatures, and the oil pressure.

(4) As the rate-of-climb can vary widely, depending on weight being carried, external loading, and altitude, refer to Take-off, Climb, and Landing Chart in Appendix II for the rate-of-climb applicable to the particular mission to be conducted.

14. DURING FLIGHT.

a. GENERAL.

(1) As soon as desired altitude is attained, turn booster pump switch to "NORMAL."

(2) Set propeller and throttle controls to desired rpm and manifold pressure.

(3) Periodically check for these desired instrument readings:

Oil pressure 70-80 lbs. (50 lbs. min., 90 lbs. max.)

Oil temp. 70-80°C (158-176°F)

(15°C (59°F) min., 90°C (194°F) max.)

Coolant temp. 100-110°C

(60°C (140°F) min., 121°C (250°F) max.)

Fuel pressure 12-16 lbs.

Suction 3.75-4.25 in. Hg

NOTE

With the radiator air controls set in the "AUTOMATIC" position, the coolant temperatures will be approximately 100-110°C (212-230°F) and the oil temperatures will be approximately 70-80°C (158-176°F). It should be noted that with very high powers on hot days, even though the radiator air controls are in the "AUTOMATIC" position, these temperature limits may be exceeded because the exit flaps are in the full-open position, making it impossible for the automatic control to maintain the above desired temperature limits.

(4) For engine operation, see Specific Engine Flight Chart, Section III, and Flight Operation Instruction Charts, Appendix II.

b. WAR EMERGENCY RATING.

(1) GENERAL.

(*a*) The basis for establishing the War Emergency Rating, given on the Specific Engine Flight Chart in Section III, is to make available to the pilot in combat the absolute maximum manifold pressure at which the engine may be operated, within reasonable safety limits, for a 5-minute period under emergency conditions.

(*b*) The War Emergency Rating is considerably in excess of the ratings given in the engine specification under which the engine was delivered. Use of the War Emergency Rating will decrease the engine's normal service life and time between overhauls, and therefore should be held for use only when emergency conditions exist. The War Emergency Rating is not a guaranteed power rating; it is a maximum manifold pressure rating, available for emergency operation only, as established by the correct setting of the automatic manifold pressure regulator, and the correct setting of the propeller governor to allow the propeller to turn at 3000 rpm.

RESTRICTED
AN 01-60JE-1

PILOT'S OPERATING INSTRUCTIONS
Sec II, Pars 14-16

(c) The War Emergency Rating is to be used only when each of the following requirements is strictly complied with:

1. In combat or precombat areas as designated by the Army Air Forces, and then only when emergency conditions exist.
2. When Spec. No. AN-F-28 fuel is used.
3. The mixture control must be set in the "AUTO RICH" position.
4. The propeller control must be set in the full "INCREASE RPM" position to maintain 3000 rpm.
5. When KLG RC 5/5 or Lodge RS 5/3 spark plugs are installed.
6. The break-through seal must be installed on the emergency boost control lever to inform the crew chief that the engine has been operated at War Emergency Ratings, so that he will then make special inspections and checks. Close co-ordination between the pilot, crew chief, and engineering officer will be required to maintain an accurate record of the time the engine has been operated at War Emergency Rating conditions. When five hours of War Emergency time have been accumulated, the engine should be pulled for tear-down inspection and reconditioning.
7. During the use of War Emergency Ratings, with Spec. AN-O-5, Grade 1100p lubricating oil in the system, the following oil inlet temperature must not be exceeded: 95°C (203°F) for 5 minutes.

CAUTION

If oil dilution has been used, it is desirable that the engine be given 10 to 15 minutes operation at from 80 percent normal to military power prior to the use of War Emergency Ratings.

8. During the use of War Emergency Ratings, the cooling system should be filled with 70 percent water and 30 percent ethylene glycol to AN-E-2 specification, and the coolant outlet temperature should not be permitted to exceed 121°C (250°F).

9. The airplane must be placarded with a decal stating that War Emergency Ratings are permissible.

(2) OPERATION.—If the airplane is so placarded and it is deemed necessary to use the War Emergency Rating, proceed as follows:

- (a) Place mixture control in "AUTO RICH."
- (b) Move propeller control to full "INCREASE."

(c) Pull out on boost control lever from "AUTO-MATIC" to "EMERGENCY."

(d) Advance throttle to full open position.

(e) Use War Emergency Rating for 5 minutes maximum.

(f) Push boost control lever in.

15. ENGINE FAILURE DURING FLIGHT.

Follow instructions in Section IV, paragraph 2.

16. FLYING CHARACTERISTICS.

a. GENERAL.—The airplane is stable at all normal loadings, but the directional trim changes at low speeds as speed and horsepower output is varied. The trim tab controls are sensitive and must be used carefully. The effect of flap and landing gear operation on the trim of the airplane in flight is as follows:

- Landing gear retracted—airplane becomes tail heavy.
- Landing gear extended—airplane becomes nose heavy.
- Flaps lowered—airplane becomes nose heavy.
- Flaps raised—airplane becomes tail heavy.

A sustained sideslip cannot be performed in this airplane; recovery should be effected above 200 feet.

b. FLIGHT CHARACTERISTICS FOR AIRPLANES WITH FUSELAGE TANK INSTALLATION.

IMPORTANT

The pilot should become accustomed to the handling qualities of the airplane with full fuselage tanks before engaging in any maneuvers. One or two hours of flying should acquaint the pilot with the airplane characteristics.

(1) FUSELAGE TANK FULL.—The stability of the airplane improves rapidly as fuel is expended from the fuselage tank. The stick forces will reverse when entering a tight turn or attempting a pull-out with the fuselage tank full. Considerable forward pressure on the stick is necessary to prevent the airplane from tightening up in a turn or pull out to a marked degree. The tendency is more severe in left turns than in turns to the right. In this condition, it is practically impossible to turn the aircraft for hands-off level flight.

(2) FUSELAGE TANK HALF FULL.—When this condition is reached, the stability is much improved. A slight tendency to tighten up is noticeable in left turns only

RESTRICTED

PILOT'S OPERATING INSTRUCTIONS
Sec II, Pars 16-21

RESTRICTED
AN 01-60JE-1

and it is impossible to trim for hands-off level flight. The airplane stability improves rapidly and the flying characteristics are normal as more fuel short of the half-full position is used.

17. MANEUVERS PROHIBITED.

a. Only normal flying attitudes are permitted when the airplane is carrying external fuel tanks.

b. The airplane should not be intentionally spun except under the following conditions:

(1) Intentional "power-off" spins will be permitted, provided such spins are started above 12,000 feet.

c. Intentional "power-on" spins and snap rolls are prohibited.

(1) It is impossible to do a good snap roll with the airplane and most attempts usually end up in a power spin.

(2) In the event a power spin is entered inadvertently, the throttle should be closed immediately and normal recovery methods used. The controls must be held in the recovery position until full recovery is completed. Recovery from a two to five-turn power spin may require up to six turns with a loss in altitude of as much as 9,000 feet.

18. STALLS.

The stall in this airplane is comparatively mild in that it does not whip at the stall but rolls rather slowly, and has very little tendency to drop into a spin. If the stick and rudder are released at the stall, the nose drops sharply and the airplane recovers from the stall almost instantly. When the stalling speed is reached, a wing will drop. If the backward movement on the stick continues when the wing drops, the airplane will fall into a steep spiral. In a straight "power-off" stall, some warning is given about 3 to 4 mph above the stall by slight elevator buffet. A high-speed stall is preceded by sharp buffeting at the elevators and wing root, but recovery is almost immediate when pressure on the stick is released. Recovery from any stall in this airplane is entirely normal, that is, by the release of back pressure on the stick and the application of rudder opposite the dropping wing. As the speed at which a stall occurs can vary widely, depending on the gross weight and external loads of the airplane, the stalling speed charts, figures 24 and 25 should be carefully studied before flight.

19. SPINS.

a. DIFFERENCES.—There are marked differences between a sustained left and right spin in this airplane.

(1) The left spin oscillates from 80 degrees below the horizon back to the horizon during the first turn, dampens out 50 percent during the second turn, and then becomes stable, smooth, and quiet with the nose approximately 30 to 40 degrees below the horizon.

(2) The right spin starts exactly the same as the left spin, but the oscillations continue without increasing or decreasing in magnitude.

b. RECOVERY.—Recovery procedure is the same in both a left and right spin. Upon application of opposite rudder, the nose drops slightly and the spin speeds up rapidly for 1¼ turns, after which the spin stops. Rudder force is light at first, becomes very heavy for a period of about one second at the first half turn after starting recovery, then drops to zero as the spin stops. Recovery is effected in the normal manner, that is, by applying full opposite rudder followed by movement of the stick to neutral.

NOTE

Slight rudder buffet occurs during the spin. If recovery from the dive is attempted too soon after the spin is stopped, a rather heavy elevator and rudder buffet will occur.

20. ACROBATICS.

The acrobatic qualities of this airplane are exceptional, and the lateral control is excellent at all speeds. All acrobatics except snap rolls are permitted. However, inverted flying must be limited to 10 seconds because of loss of oil pressure and failure of the scavenger pump to operate in inverted position.

21. DIVING.

The maximum permissible diving speed is 505 IAS, during which the engine speed must not exceed 3240 rpm. The use of elevator tabs is not required for dive recovery because of the low elevator control forces. As the airplane gains speed very rapidly in a dive, it is of utmost importance to make allowance of ample altitude for a safe recovery before starting the dive. The Estimated Diving Limitations Chart, figure 26, indicates the estimated minimum safe altitudes required for a pull-out from dives of

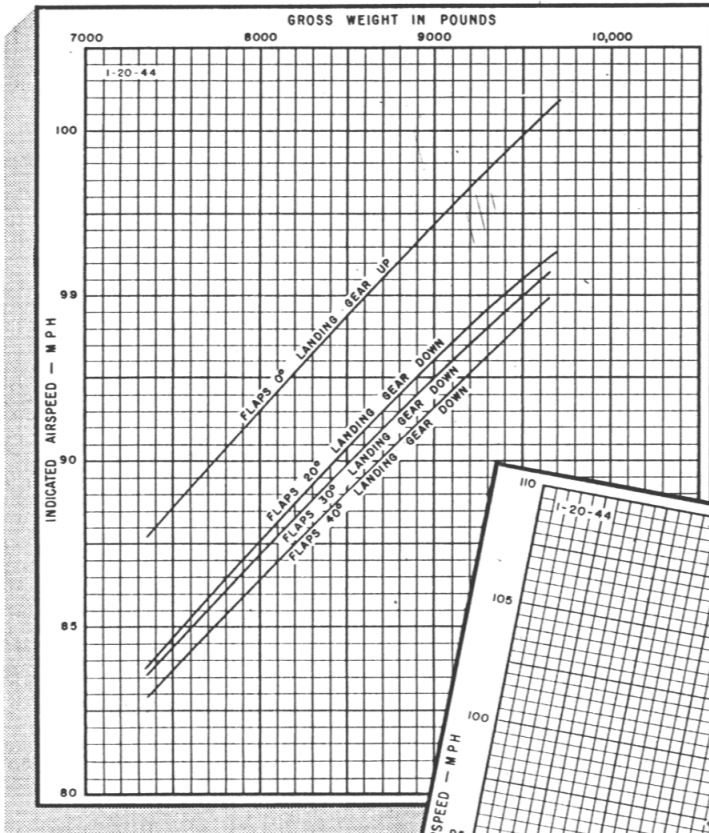
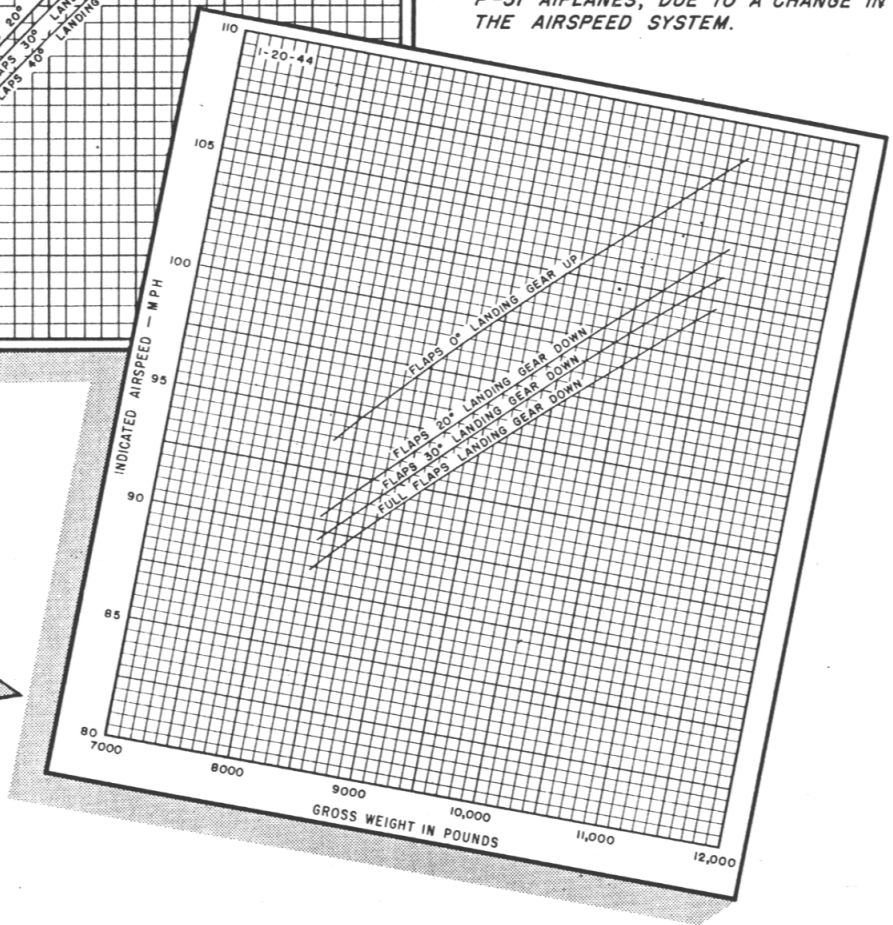

FIG. 24
STALLING SPEEDS
NO EXTERNAL LOAD

WARNING:
AIRPLANE STALLS AT APPROXIMATELY
10 MPH HIGHER IAS THAN PREVIOUS
P-51 AIRPLANES, DUE TO A CHANGE IN
THE AIRSPEED SYSTEM.

FIG. 25
STALLING SPEEDS
COMBAT TANKS



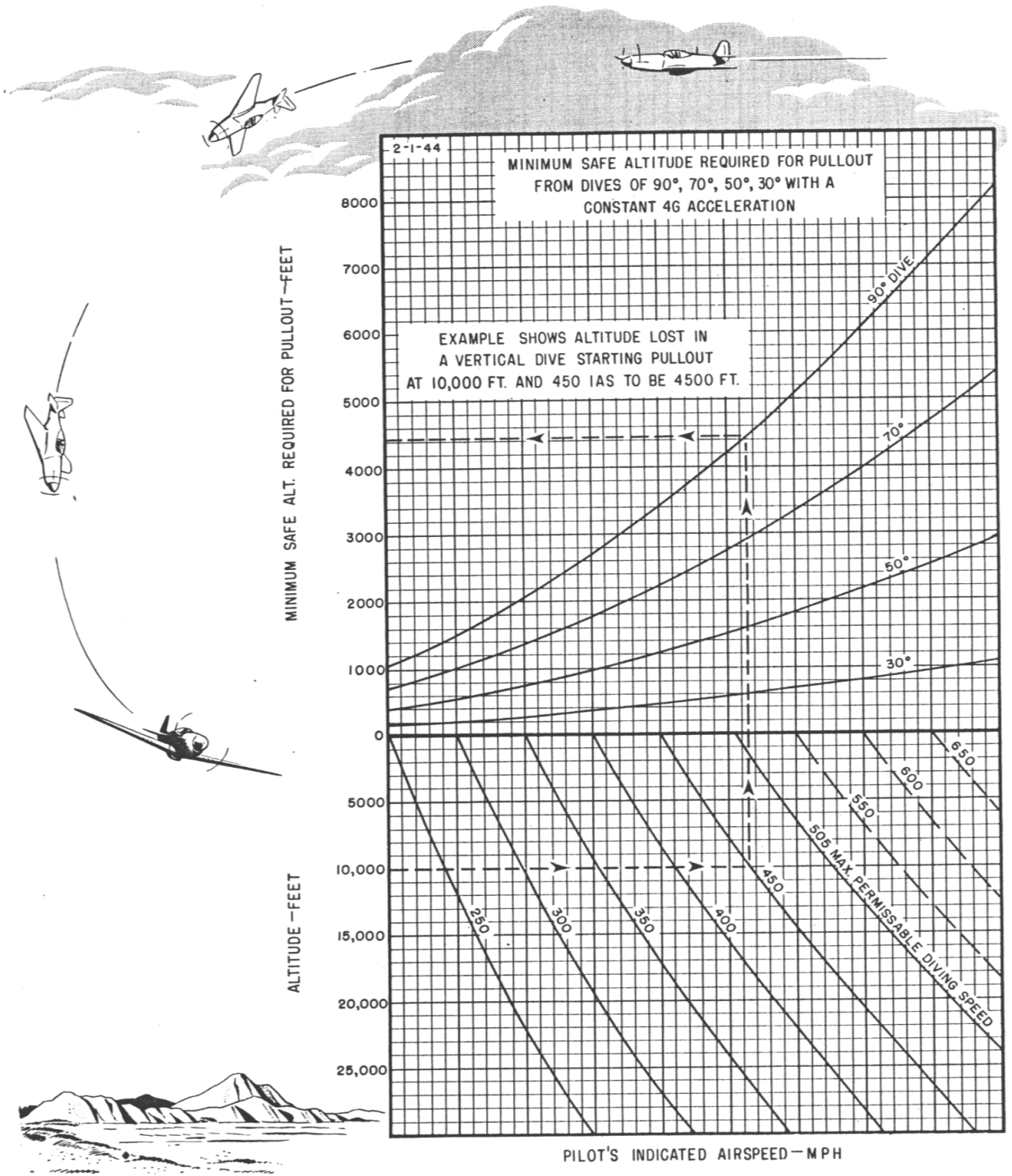

Figure 26—Estimated Diving Limitations

RESTRICTED
AN 01-60JE-1

PILOT'S OPERATING INSTRUCTIONS
Sec II, Pars 21-25

90°, 70°, 50°, and 30°, with a constant 4G acceleration. Pull-outs should not be attempted at greater than 4G's unless the pilot has special equipment to enable him to withstand greater accelerations without blacking out.

22. GLIDING.

Gliding may be carried out at any safe speed down to the recommended margin of about 25 percent above stalling speed. With the landing gear and flaps up, the glide is fairly flat with the nose very high. Forward visibility in this condition is poor. Lowering either the flaps or landing gear, or both, greatly steepens the gliding angle, and the rate of descent is greatly increased.

23. NIGHT FLYING.

IMPORTANT

Become accustomed to the position of the various light switches by feel, especially the switch for the landing light.

NOTE

Spare bulbs are contained in the small compartment on the right forward side of the cockpit.

a. In flying this airplane at night, the sequence outlined for daylight operation should be even more strictly observed. In addition, the pilot should familiarize himself with the location of the different lights and their control switches.

(1) **INSTRUMENT LIGHTING.**—Turn on the fluorescent lamps by turning the rheostat knobs (on radiator air control panel and right-hand switch panel) to "START" until the lights come on; then switch to either "ON" or "DIM" positions. Rotating the lens housing selects the visible or invisible illumination.

(2) **POSITION LIGHTS.**—The position light switches are on the right-hand switch panel. Two intensities of light are available: "BRIGHT" and "DIM."

(3) **LANDING LIGHT.**—The switch for the landing light is located on the radiator air control panel.

(4) **COCKPIT LIGHTS.**—A cockpit swivel light is on each side of the cockpit. Turn on light by turning switch on lamp housing. The cockpit light switch on the pilot's switch panel must be "ON" before operating the lights.

(5) **RECOGNITION LIGHTS.**—Set the switches, located on the right-hand switch panel, for the light or combination of lights desired. Place the switches in "STEADY"

position for continuous operation and in "KEY" position for intermittent operation, by means of the keying switch on the right longeron.

24. APPROACH AND LANDING.

a. **APPROACH.**—When the airplane approaches the field, this sequence of operations should be followed:

- (1) Mixture control "AUTO RICH."
- (2) Oil and coolant radiator air controls "AUTOMATIC."
- (3) Fuel selector valve to either "MAIN L.H.," "MAIN R.H.," or "FUS. TANK." Booster pump switch "NORMAL."
- (4) Propeller control set for 2700 rpm.
- (5) Lower the landing gear below 170 IAS. Check position of gear by the warning light on the instrument panel.
- (6) If desired, the flaps may be lowered 15 degrees to give a steeper approach angle. When the airplane has been brought into the wind for landing, the flaps should be lowered fully at an altitude of at least 400 feet, provided the indicated airspeed is below 165 IAS and above 100 IAS.

b. LANDING.

(1) **GENERAL.**—Having turned into the field and lowered the flaps, maintain a correct gliding speed. Adjust the elevator trim tab to assist in landing. Having stopped after landing, raise the flaps before taxiing.

(2) **CROSS-WIND LANDING.**—As this airplane has a landing gear of wide tread and a locked tail wheel, cross-wind landings may be negotiated safely. Keep one wing down, into the wind, to counteract drift.

(3) **TAKE-OFF IF LANDING IS NOT COMPLETED.**—In the event of an unsuccessful attempt to land, open the throttle and then push the propeller control forward to full "INCREASE." Raise the landing gear immediately; then, when the airspeed has reached 100 IAS, raise the flaps.

25. STOPPING ENGINE.

a. To stop engine, proceed as follows:

- (1) Turn booster pump switch "OFF."
- (2) If a cold weather start is anticipated, hold oil dilution switch, on pilot's switch panel, "ON" (2 minutes maximum).

PILOT'S OPERATING INSTRUCTIONS
Sec II, Pars 25-27

RESTRICTED
AN 01-60JE-1

(3) Run engine to 1500 rpm, set mixture control to "IDLE CUT OFF" and move throttle fully open. Leave mixture control in "IDLE CUT OFF" as a precaution against accidental starting.

(4) Turn ignition switch to "OFF" after the engine ceases firing.

(5) Turn "OFF" fuel shut-off valve.

26. BEFORE LEAVING COCKPIT.

a. After engine stops, proceed as follows:

(1) Turn "OFF" all switches.

(2) Set parking brakes.

WARNING

If brakes are hot as a result of frequent applications, wait until they have cooled before applying parking brakes. Otherwise, the brake discs will fuse to each other.

(3) Lock the control surfaces.

(4) Place the carburetor air control in "UNRAMMED FILTERED AIR" position.

(5) Pull out on sliding canopy crank handle, place pin between holes on face of clutch housing, and push on knob of handle. This will disengage crank axle from clutch and allow canopy to be moved manually.

(6) Close canopy after leaving cockpit.

**MOOR WITH 3/4" ROPE
 OR 1/4" CABLE.**

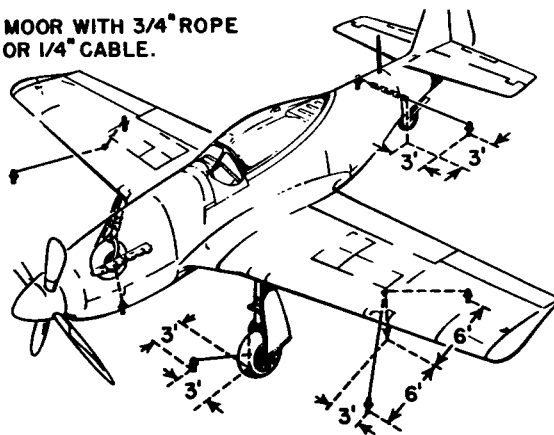

Figure 27—Mooring Airplane

27. TYING DOWN.

a. Head the airplane into the wind.

b. Set the parking brakes.

c. Lock the surface control lock, using the lower locking notch on the control stick in order to lock the tail wheel.

d. Moor the airplane with 3/4-inch rope or 1/4-inch cable. Secure the wing with two ropes at each of the mooring rings in the wing, one tied 6 feet forward and 3 feet outboard, and one tied 6 feet aft and 3 feet outboard of each mooring ring. Secure each main landing gear towing lug to the ground with a rope tied 3 feet forward and 3 feet inboard of the respective towing lug. Moor the tail section of the fuselage to the ground with one rope strung through the lift tube and tied on each side of the airplane, 2 feet aft and 3 feet outboard of the lift tube.

e. Install engine and cockpit covers.



RESTRICTED
AN 01-60JE-1

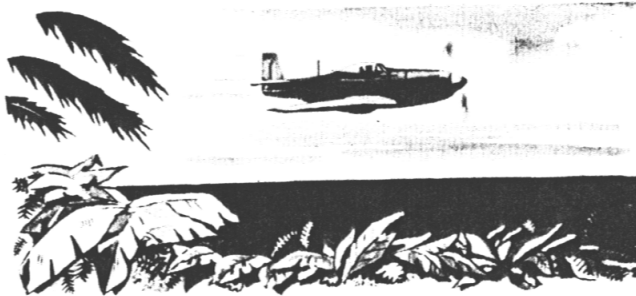

SECTION III

Flight Operating Data

1. SPECIFIC ENGINE FLIGHT CHART.

a. Operating limitations and characteristics of the V-1650-7 engine are summarized for ready reference on the Specific Engine Flight Chart (figure 28). A similar chart (figure 29), applicable to the V-1650-3 engine, is provided for use on airplanes which have had V-1650-3 engines installed in service. The pilot should be thoroughly familiar with this information.

b. Engine power ratings shown on the chart are defined as follows:

(1) TAKE-OFF.—Maximum recommended for take-off under the specified time limit of five minutes.

(2) WAR EMERGENCY.—Maximum allowed for emergency operation during combat for a period not exceeding 5 minutes.

(3) MILITARY.—Maximum recommended for operation for periods not exceeding 15 minutes.

(4) MAXIMUM CONTINUOUS.—Maximum rec-

ommended for operation with rich mixture in climb and level flight.

(5) MAXIMUM CRUISE.—Maximum recommended for operation with lean mixture.

(6) MINIMUM SPECIFIC CONSUMPTION.—The power at which greatest range can be obtained under average loading conditions.

2. AIRSPEED CORRECTION CHART.

INDICATED AIRSPEED—MPH	CALIBRATED INDICATED AIRSPEED—MPH	ALTIMETER ERROR (FEET) ADD TO INSTRUMENT READING		
		S.L.	10,000	20,000
180	181.5	20	25	35
210	212	25	35	45
240	242	30	45	60
270	272	35	50	70
300	302	45	60	85
330	332	50	70	100
360	362.5	60	85	115
390	393	70	100	140



RESTRICTED

AIRPLANE MODELS		SPECIFIC ENGINE				ENGINE MODELS					
P-51D		PACKARD V-1650-7									
SPEC. AN-H-8 DEC 18, 1942		FORM ASC-512									
CONDITION	FUEL PRESSURE (LB./SQ. IN.)	OIL PRESSURE (LB./SQ. IN.)	OIL TEMP.		COOLANT TEMP.		MAX. PERMISSIBLE DIVING RPM: 3240				
			°C	°F	°C	°F	ALLOWABLE OIL CONSUMPTION				
DESIRED	12-16	70-80	70-80	158-176	100-110	212-230	MAX. CONT. 1.1	U.S.QT./HR. 1	IMP.PT./HR
MAXIMUM	19	90	90	194	121	250	MAX. CRUISE 4	U.S.QT./HR. 4	IMP.PT./HR
MINIMUM	12	50	15	59	60	140	MIN. SPECIFIC 3	U.S.QT./HR. 3	IMP.PT./HR
IDLING	9	15					OIL GRADE: (S) 1100	(W) 1100	
SUPERCHARGER TYPE: TWO SPEED, TWO STAGE											
FUEL GRADE: SPEC. AN-F-28 GRADE 130 OCTANE 100											
OPERATING CONDITION	RPM	MANIFOLD PRESSURE (BOOST)	HORSE-POWER	CRITICAL ALTITUDE		USE LOW BLOWER BELOW:	MIXTURE CONTROL POSITION	FUEL FLOW (GAL./HR./ENG.)	MAXIMUM CYL. TEMP.		MAXIMUM DURATION (MINUTES)
				WITH RAM	NO RAM				°C	°F	
TAKE-OFF	3000	61	1490		S.L.		A.R.	161			5
WAR EMERGENCY	3000	67	1720		6,200		A.R.	184			5
			1505		19,300		A.R.	187			
MILITARY	3000	61	1580		8,500		A.R.	178			15
			1370		21,400		A.R.	170			
MAXIMUM CONTINUOUS	2700	46	1180		11,300		A.R.	109			CONT.
			1065		23,400		A.R.	106			
MAXIMUM CRUISE	2400	36	820		14,000		A.L.	86			CONT.
			760		23,700		A.L.	84			
MINIMUM SPECIFIC CONSUMPTION											

REMARKS: ADDITIONAL INFORMATION WILL BE INCORPORATED IN THIS CHART WHEN AVAILABLE.

Figure 28—Specific Engine Flight Chart—V-1650-7

RESTRICTED
AN 01-60JE-1

FLIGHT OPERATING DATA
Sec III, Par 2

AIRPLANE MODELS		SPECIFIC ENGINE				ENGINE MODELS						
P-51D		P-51D				PACKARD V-1650-3						
FORM ASC-512		FORM ASC-512				FORM ASC-512						
DEC 18, 1942		DEC 18, 1942				DEC 18, 1942						
SPEC. AN-H-8		SPEC. AN-H-8				SPEC. AN-H-8						
CONDITION	FUEL PRESSURE (LB./SQ. IN.)	OIL PRESSURE (LB./SQ. IN.)	OIL TEMP. °C	OIL TEMP. °F	COOLANT TEMP. °C	COOLANT TEMP. °F	MAX. PERMISSIBLE DIVING RPM: 3240	ALLOWABLE OIL CONSUMPTION				
DESIRED	12-16	70-80	70-80	158-176	100-110	212-230	MAX. CONT. .11	U.S. QT./HR.	IMP. PT./HR.			
MAXIMUM	19	90	90	194	121	250	MAX. CRUISE .4	U.S. QT./HR.	IMP. PT./HR.			
MINIMUM	12	50	15	59	60	140	MIN. SPECIFIC .3	U.S. QT./HR.	IMP. PT./HR.			
IDLING	9	15					OIL GRADE (S): .1100	(W): .1100				
SUPERCHARGER TYPE: TWO SPEED, TWO STAGE												
FUEL GRADE: SPEC. AN-F-28 GRADE 130												
OPERATING CONDITION	RPM	MANIFOLD PRESSURE (BOOST)	HORSE-POWER	CRITICAL ALTITUDE		BLOWER	USE LOW BLOWER BELOW:	MIXTURE CONTROL POSITION	FUEL FLOW (GAL./HR./ENG.)	MAXIMUM CYL. TEMP. °C	MAXIMUM CYL. TEMP. °F	MAXIMUM DURATION (MINUTES)
TAKE-OFF	3000	61	1400	WITH RAM	NO RAM				U.S.			5
WAR EMERGENCY	3000	67	1595	S.L.	S.L.	LOW		AR	150			5
MILITARY	3000	61	1450	17,000	11,700	LOW		AR	166			5
MAXIMUM CONTINUOUS	2700	46	1120	28,800	23,200	HIGH		AR	160			15
MAXIMUM CRUISE	2400	36	940	19,800	13,700	HIGH		AR	158			CONT.
MINIMUM SPECIFIC CONSUMPTION	1600	27	370	31,200	25,600	LOW		AR	144			CONT.
	1800	30	440	20,500	17,500	HIGH		AR	111			CONT.
	2000	31	510	34,400	29,500	LOW		AR	106			CONT.
		F.T.	560	21,500	18,500	HIGH		AL	74			CONT.
		F.T.		32,300	30,500	LOW		AL	70			CONT.
				S.L.	S.L.	LOW		AL	35			CONT.
				5,000		LOW		AL	39			CONT.
				10,000		LOW		AL	42			CONT.
				15,000		LOW		AL	45			CONT.
				20,000		LOW		AL	50			CONT.

REMARKS: DATA FOR MINIMUM SPECIFIC CONSUMPTION ARE FOR AVERAGE MAXIMUM RANGE CONDITIONS

Figure 29—Specific Engine Flight Chart—V-1650-3

RESTRICTED

RESTRICTED
AN 01-60JE-1

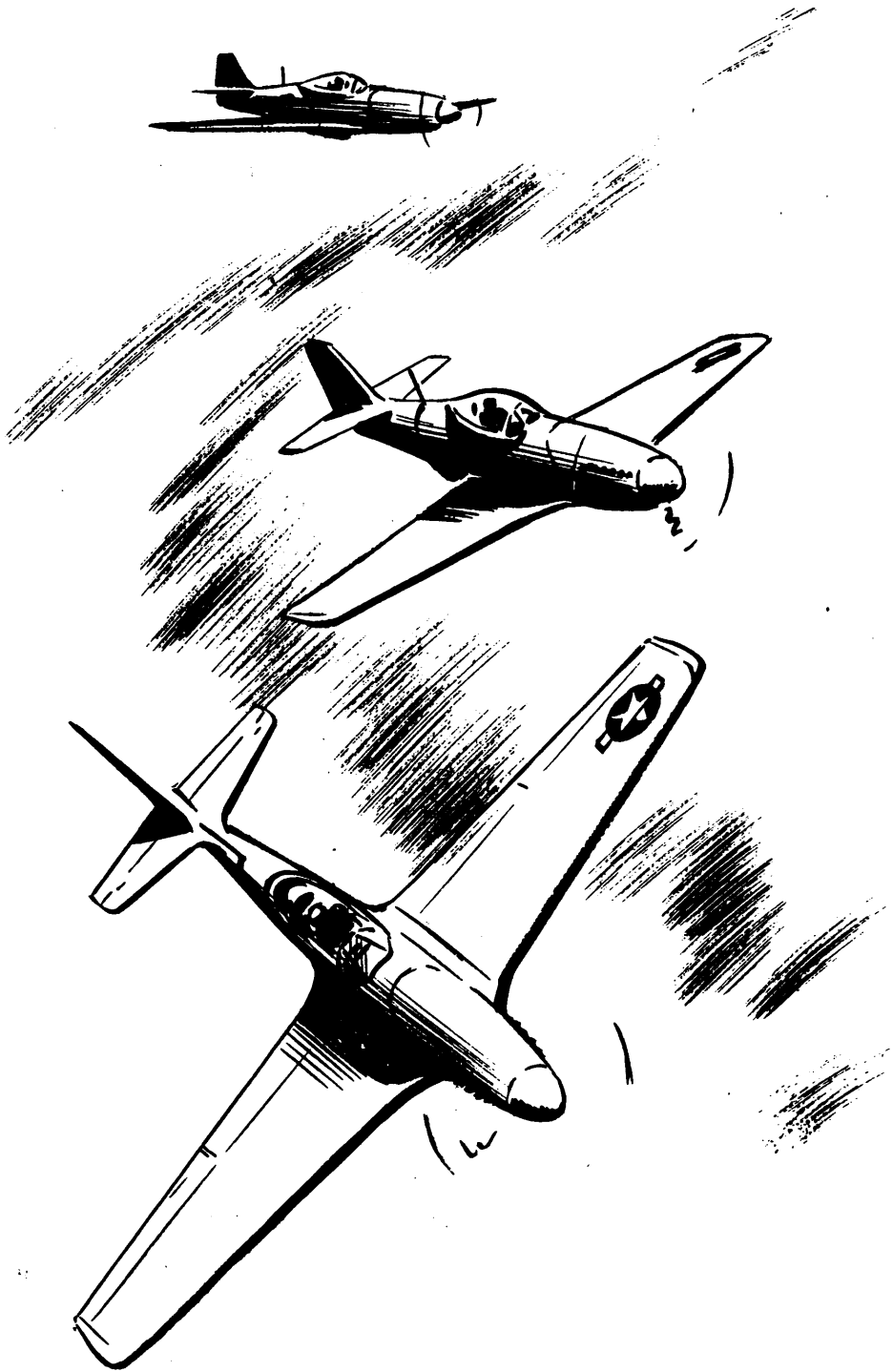

RESTRICTED
AN 01-60JE-1



SECTION IV

Emergency Operating Instructions

1. GENERAL.

All emergency instructions, except those included in Section II, have been assembled in this Section to facilitate quick reference. The pilot should thoroughly acquaint himself with these instructions before his first flight in this airplane.

2. ENGINE FAILURE DURING FLIGHT.

a. If the engine fails during flight, the airplane may be abandoned, ditched, or brought in for a dead-stick landing, as the case requires. For a landing with the engine dead, follow these instructions:

- (1) Depress the nose at once so that airspeed does not drop below stalling speed.
- (2) If external fuel tanks or bombs are installed, release them immediately (*see paragraph 6*).
- (3) Release the sliding canopy by pulling emergency release handle on right longeron.

WARNING

Bend forward and lower head slightly when pulling release handle so as to avoid injury from the loosened canopy. If the canopy does not fly off, move it back with handcrank.

- (4) Do not lower the landing gear. There is less chance of personal injury if the airplane is landed with the gear up.
- (5) Lower the flaps fully, if possible.
- (6) Move mixture control to "IDLE CUT OFF" and turn ignition switch "OFF."
- (7) Turn "OFF" fuel shut-off valve and battery-disconnect switch.
- (8) Land into the wind, only changing direction sufficiently to miss obstructions.
- (9) After landing, get out of the airplane as quickly as possible and remain outside.

RESTRICTED

33

EMERGENCY OPERATING INSTRUCTIONS
Sec IV, Par 2

RESTRICTED
AN 01-60JE-1

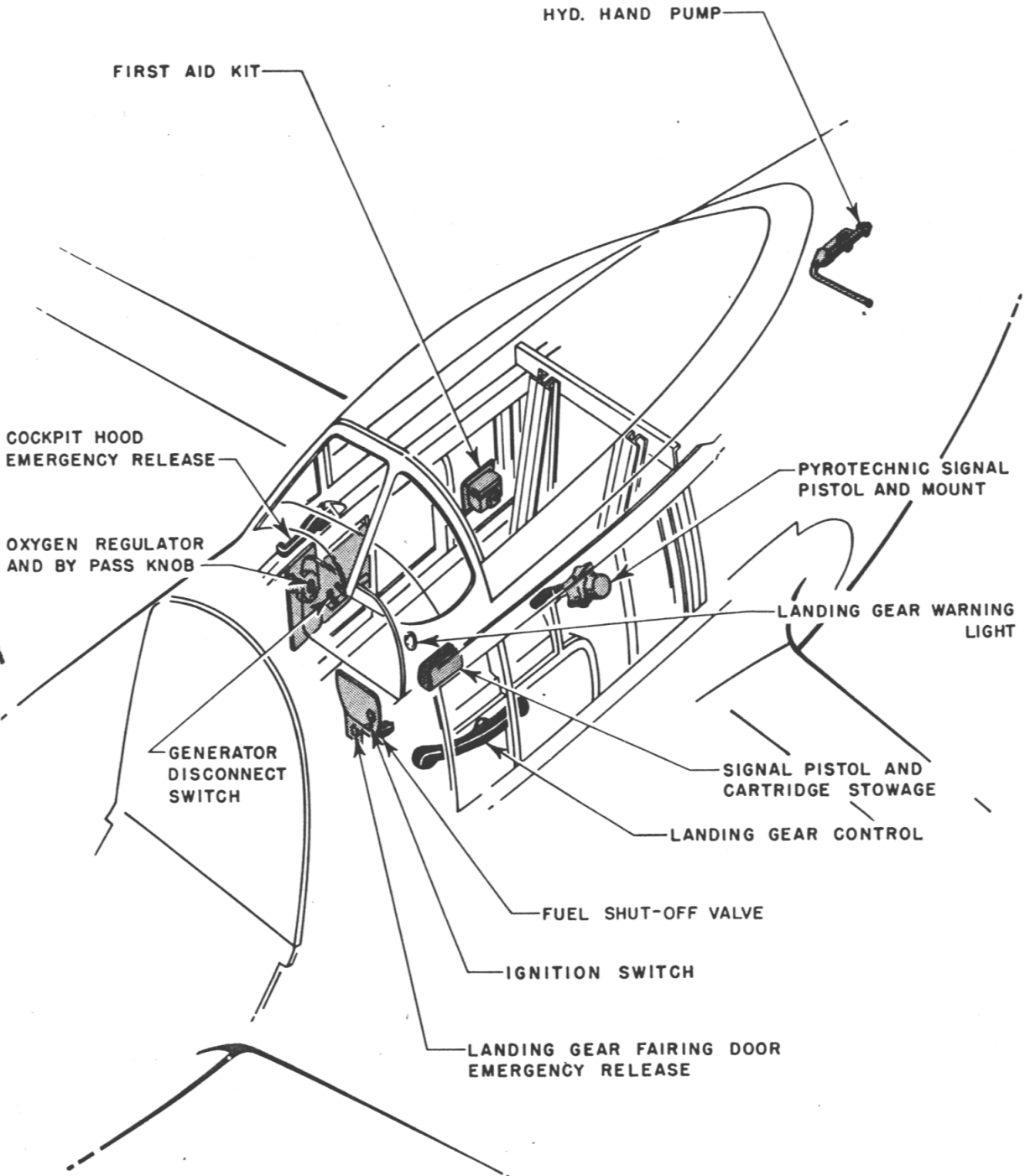

Figure 30—Emergency Equipment

RESTRICTED
AN 01-60JE-1

EMERGENCY OPERATING INSTRUCTIONS
Sec IV, Pars 3-8

3. EMERGENCY EXIT DURING FLIGHT.

a. In the event that an emergency exit must be made during flight, the following procedures are recommended:

(1) Release sliding canopy and unfasten safety belt and shoulder harness. Roll airplane over on its back and drop out.

(2) Release sliding canopy and unfasten safety belt and shoulder harness. Climb out of cockpit, lower self onto wing, and roll off.

IMPORTANT

When pulling emergency release handle, bend forward and lower head slightly to avoid head injury when canopy releases.

4. DITCHING.

a. The airplane should be ditched only as a last resort. If, on an overwater flight, trouble arises and the pilot is quite certain that he will not be able to reach land, he should leave the airplane while in flight. However, if it is not possible to maintain sufficient altitude for a successful parachute drop, ditching is the only remaining procedure. The instructions for ditching are as follows:

(1) If bombs or droppable tanks are installed, release them immediately.

(2) Release sliding canopy. (*See IMPORTANT note in paragraph 3.*)

(3) Be sure the shoulder harness and safety belt are fastened securely, as there is a violent deceleration of the airplane upon final impact.

(4) Land into the wind with landing gear up. As soon as the airplane comes to rest, get out *immediately*.

DANGER

The pilot must get out quickly upon landing. After the final impact, the airplane will sink very rapidly, only remaining above the surface of the water for a period of 1½ to 2 seconds.

5. LANDING GEAR EMERGENCY LOWERING.

In the event of hydraulic system failure, the landing gear may be lowered by placing the landing gear control handle in the down position and yawing the airplane sideways. If the landing gear warning light does not go out when the throttle is retarded, pull the fairing door emergency knob, located just forward of the control stick, and then yaw the airplane sideways to force the gear into the locked position. If the tail wheel does not lock, increase the airplane's speed to increase the air load on the partially extended wheel, or dive the airplane a short distance and pull out with enough acceleration to down the tail wheel.

6. EMERGENCY BOMB OR DROPPABLE FUEL TANK RELEASE.

The bombs or droppable fuel tanks are released as follows:

a. EARLY AIRPLANES.—Hinge antisalvo guard upward and move bomb release handle to "SALVO."

b. LATE AIRPLANES.—Pull out on both emergency bomb release handles at left side of instrument panel.

7. EMERGENCY USE OF OXYGEN.

If for any reason there is a lack of oxygen or if no oxygen flow is indicated by the flow indicator, immediately turn "ON" the red emergency knob on the regulator.

8. USE OF MISCELLANEOUS EMERGENCY EQUIPMENT.

a. RADIO DEMOLITION SWITCH.—This switch, on the right side of the cockpit, controls a charge for demolishing the identification radio in an emergency. Press both buttons simultaneously to set off the charge.

b. FIRST-AID KIT.—The contents of the first-aid kit are to be used only in an emergency when medical aid is not available. Use contents of kit in accordance with the directions contained therein.

c. LIFE PRESERVER.—The back cushion on the pilot's seat is filled with kapok and may be used as a life preserver.

RESTRICTED

35

RESTRICTED
AN 01-60JE-1



RESTRICTED
AN 01-60JE-1

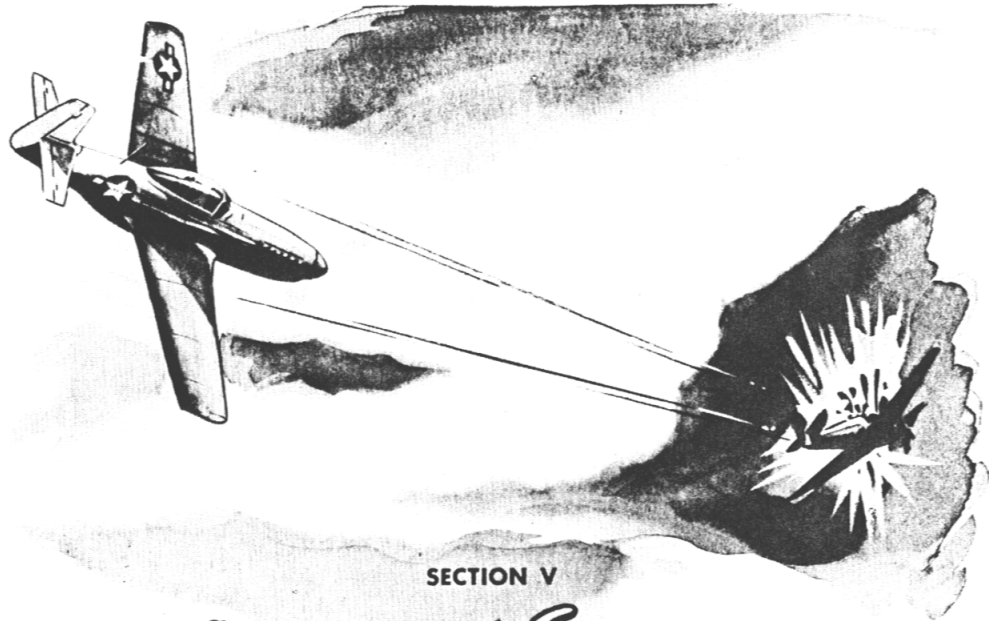

SECTION V

Operational Equipment

NOTE

The following instructions apply only to operational equipment not used in the actual flying of the airplane. For flight operating instructions, see Section II.

1. GUNNERY EQUIPMENT.

a. DESCRIPTION.—Either of two gun installations may be used: a maximum load of three fixed .50-caliber guns in each wing or an alternate installation of two guns in each wing. The maximum load includes 500 rounds of ammunition for each inboard gun and 270 rounds for each center and outboard gun. When the alternate installation is used, the center guns are removed, and 500 rounds of ammunition are provided for each outboard gun. An optical gun sight and an auxiliary ring sight are mounted on the instrument cowl; a bead sight is forward of the windshield. A Type N-4 gun sight aiming point camera equipped with an overrun control is mounted in the leading edge of the left wing.

b. OPERATION.

(1) On missions requiring gun heat, turn "ON" gun heater switch immediately after starting engine. Turn switch "OFF" when firing guns.

(2) On combat missions, turn gun and camera safety switch to "GUNS AND CAMERA" as soon as the airplane is safely off the ground. Doing this eliminates the possibility of the pilot forgetting to turn the switch on during the excitement of combat.

(3) To sight guns, turn gun sight rheostat, on right side of pilot's switch panel, toward "ON." Turning the rheostat in a clockwise direction increases the light intensity of the image. The gun sight will not operate until the gun and camera safety switch has been turned on.

NOTE

If the optical gun sight fails to function, install the ring sight by slipping the ring sight stem over the stud provided and rotating the ring sight to the left into the stem clip.

(4) Fire guns by squeezing trigger switch on control stick grip. To operate camera only, turn gun safety switch to "CAMERA" and squeeze trigger switch.

NOTE

When the gun and camera safety switch is on, the heaters in the camera will function automatically at low temperatures. Therefore, make certain the safety switch is "OFF" whenever the guns and camera will not be required.

RESTRICTED

OPERATIONAL EQUIPMENT
 Sec V, Pars 1-2

RESTRICTED
 AN 01-60JE-1

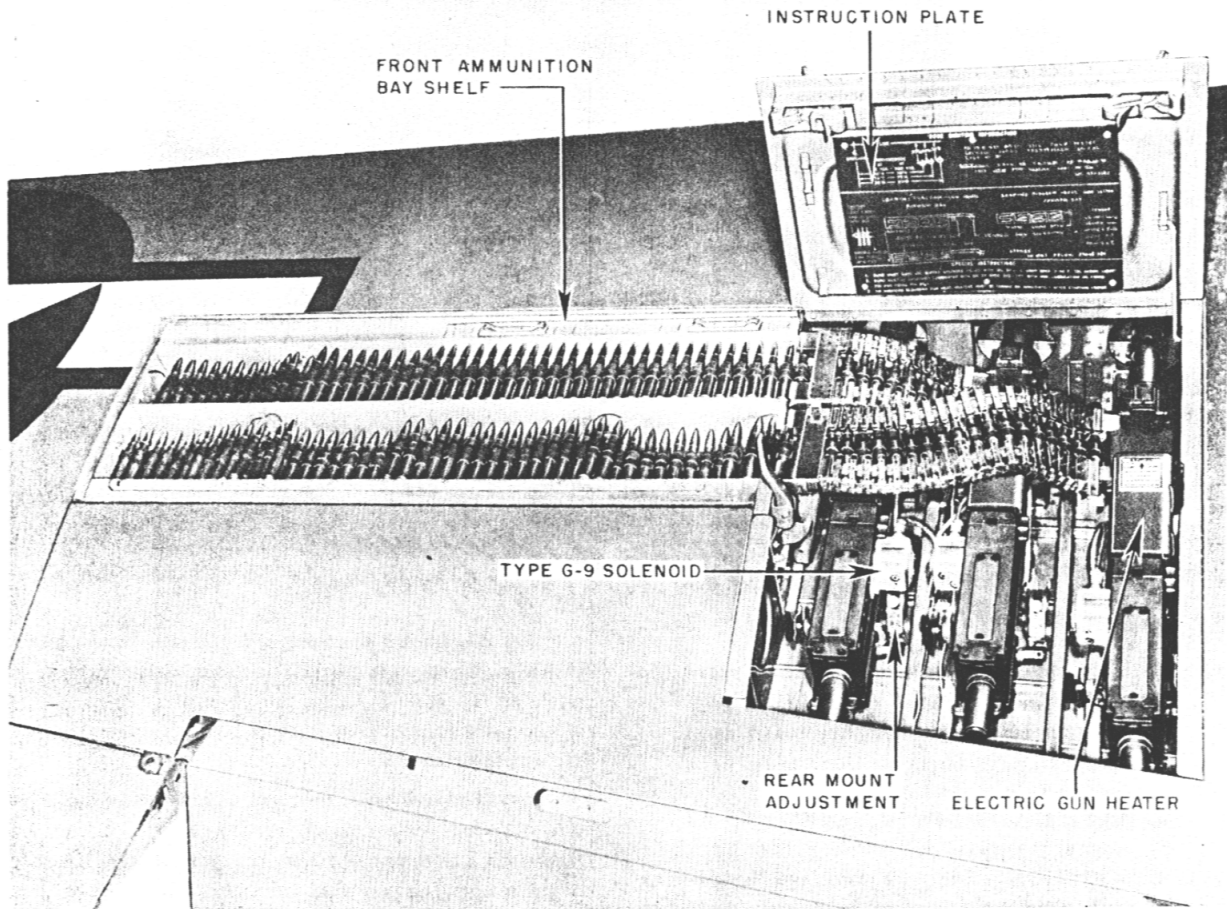

Figure 31—Wing Gun Installation

(5) Before landing, make sure that the gun and camera safety switch and gun heater switch are "OFF."

2. BOMBING EQUIPMENT.

a. DESCRIPTION.—An external, removable bomb rack may be installed under each wing. Each rack will hold one 100, 250, or 500-pound bomb. Chemical tanks or combat fuel tanks may be carried on the bomb racks when bombs are not installed. The tanks are released either by normal or salvo operation of the bomb control system. On early airplanes, a bomb salvo handle, on the left side of the cockpit, salvoes the bombs simultaneously. On late airplanes, two bomb salvo handles provide a selective mechanical

release of bombs or fuel tanks. The bomb system electrical controls consist of a bomb release switch on top of the control stick, and three bomb arming switches and a bomb release selector switch on the armament control panel. The gun sight is adjustable for use in low altitude bombing.

b. OPERATION.

(1) GENERAL.—The electrical release of bombs is the normal release. The "SALVO" release is used only if the electrical release fails. The two "NOSE ARM" switches arm the nose fuse of the bombs on the left and right racks. The "TAIL ARM" switch arms the bomb tail fuse on both racks. The bomb release selector switch has the following positions: "BOTH," "SAFE," and "SELECTIVE." With the

RESTRICTED
AN 01-60JE-1OPERATIONAL EQUIPMENT
Sec V, Par 2

Figure 32—Bomb Rack Control System

selector switch on "BOTH," the bombs will be released simultaneously when the release switch is pressed. When the selector switch is on "SELECTIVE" and the bomb release switch is pressed, the left bomb will be released; when the bomb release switch is pressed again, the right bomb will be released. The bomb release circuit is inoperative when the selector switch is in the "SAFE" position.

NOTE

Bombs may be released when the airplane is in any attitude of flight from a 30-degree climb to a vertical dive.

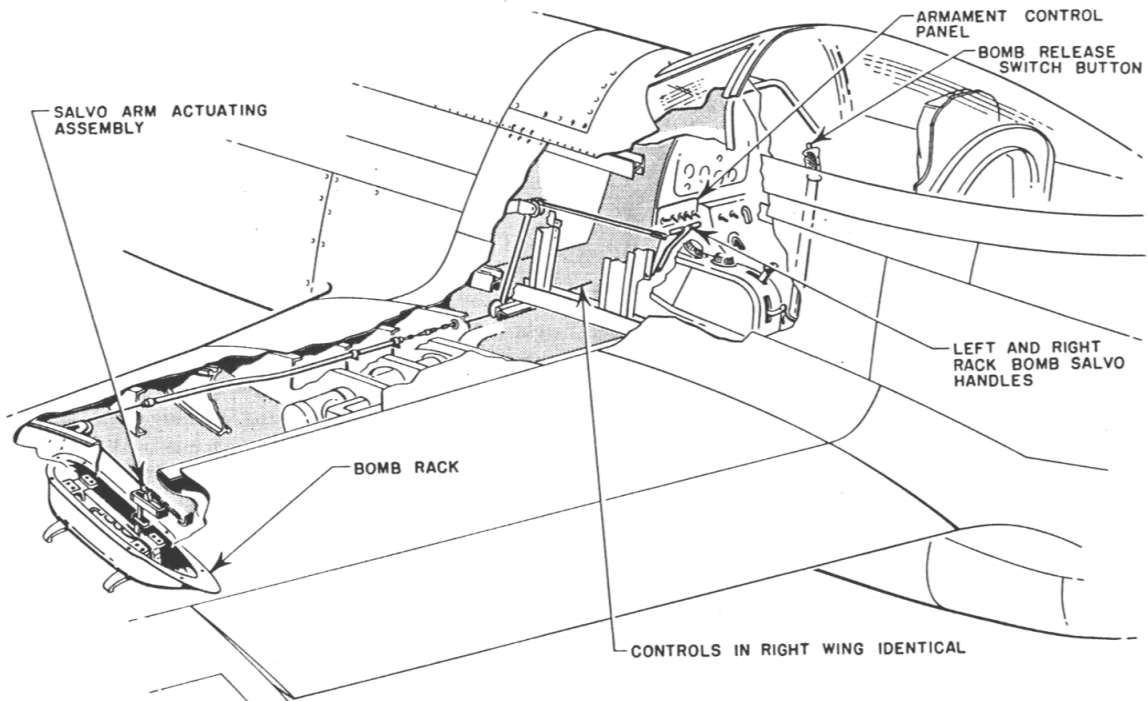
CAUTION

To prevent bombs from falling into the propeller, do not release bombs when sideslipping more than 5 degrees in a vertical dive.

(2) INOPERATIVE POSITION OF CONTROLS.

—When not in use, the controls shall be positioned as follows:

- (a) Bomb release selector switch on "SAFE."
- (b) Nose and tail arming switches "OFF."

(c) On early airplanes, bomb salvo handle with antisalvo guard down.

(3) SELECTIVE RELEASE (ELECTRICAL).—To release bombs selectively, proceed as follows:

- (a) Place arming switches in desired position.

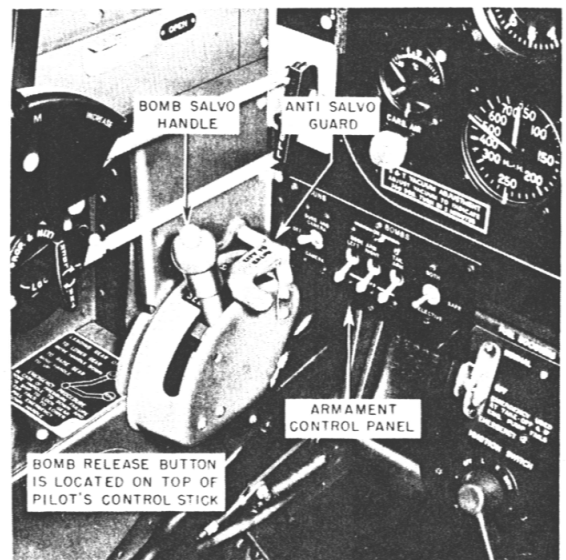

Figure 33—Bomb Controls—Early Airplanes

RESTRICTED

39

OPERATIONAL EQUIPMENT
Sec V, Pars 2-3

RESTRICTED
AN 01-60JE-1

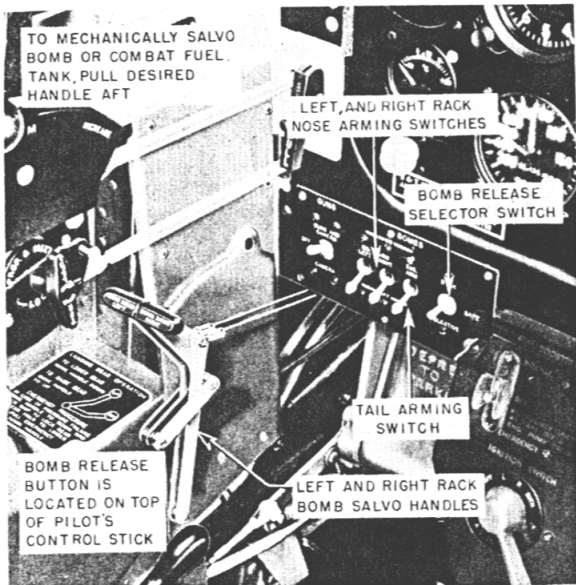

Figure 34—Bomb Controls—Late Airplanes

(b) Place bomb release selector switch on "SELECTIVE."

(c) Press bomb release switch button *momentarily* to release bomb on left rack.

(d) Press bomb release switch button again to release bomb on right bomb rack.

(e) Bomb arming switches "OFF," bomb release selector switch to "SAFE."

(4) SALVO RELEASE (ELECTRICAL).—To release both bombs simultaneously, proceed as follows:

(a) Place bomb arming switches in desired position.

(b) Place bomb release selector switch on "BOTH."

(c) Press bomb release switch; both bombs will release.

(d) Bomb arming switches "OFF," bomb release selector switch to "SAFE."

NOTE

For emergency bomb release instructions, see Section IV, paragraph 6.

3. COMMUNICATION EQUIPMENT.

a. GENERAL.—Radio equipment consists of a command set and an identification set. The command radio may be either SCR-522 or SCR-274-N. Identification equip-

ment may be either SCR-695 or SCR-515. Additional communication equipment includes a signal pistol, a signal lamp, and recognition lights.

b. COMMAND SET SCR-522.

(1) DESCRIPTION.—This set is a push-button type of transmitter-receiver, operating on the 100 to 156 mc band (see figures 36 and 37). The control box is just aft of the right-hand switch panel in the cockpit. A transmit-receive, remote control button is on the throttle lever. Lamps adjacent to the control buttons indicate which band is being used. A remote contactor, on the left side of the instrument panel, switches the transmitter from any of the four voice-modulated bands to the tone-modulated "D" band for 14 seconds of every minute. The pointer on the face of the contactor indicates when the switch's action will take place. The clock switch on the contactor should never be touched in flight; it is set on the ground by the service crew. A separate receiver, located on the floor at the pilot's right, is installed with this equipment for use in the reception of beacon signals, weather broadcasts, and airport communication.

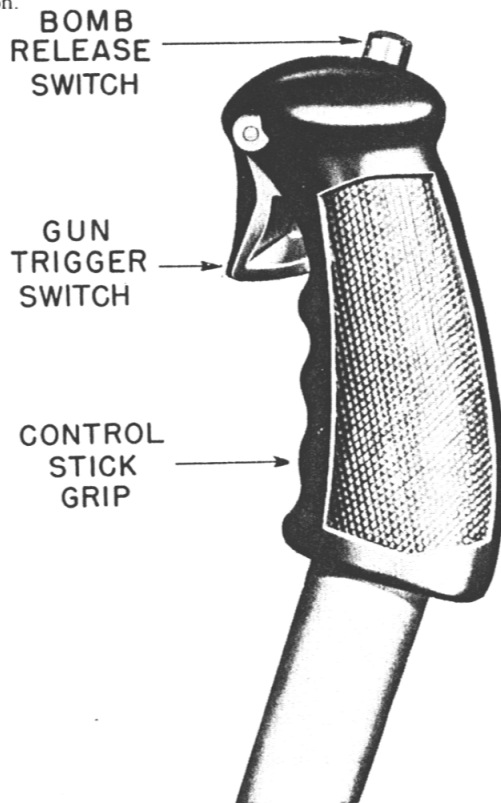
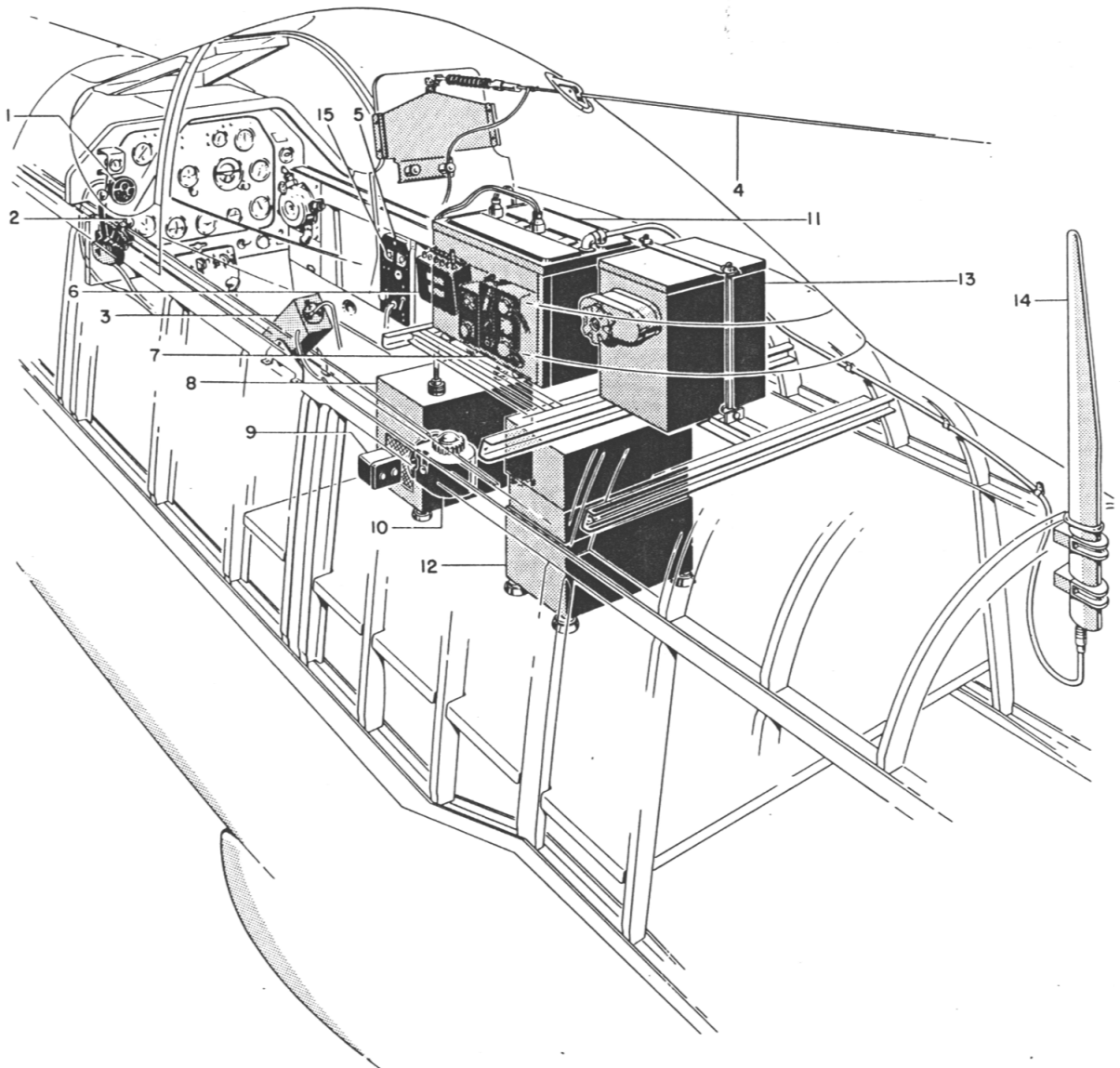

Figure 35—Gun and Bomb Control Switches

RESTRICTED
AN 01-60JE-1

OPERATIONAL EQUIPMENT
Sec V, Par 3



1. REMOTE CONTACTOR
2. THROTTLE SWITCH
3. DETROLA RECEIVER SCR-438
4. DETROLA & SCR-274-N ANTENNA
5. IO6-71154 PANEL ASSEMBLY

6. CONTROL BOX SCR-522
7. CONTROL BOX SCR-695
8. POWER SUPPLY SCR-522
9. INDICATOR LAMPS SCR-695
10. INERTIA SWITCH SCR-695

11. TRANSMITTER RECEIVER SCR-522
12. RADIO SCR-695
13. BATTERY
14. ANTENNA SCR-522
15. SCR-695 DETONATOR BUTTONS

Figure 36—SCR-522 and SCR-695 Radio Equipment

RESTRICTED

OPERATIONAL EQUIPMENT
Sec V, Par 3

RESTRICTED
AN 01-60JE-1

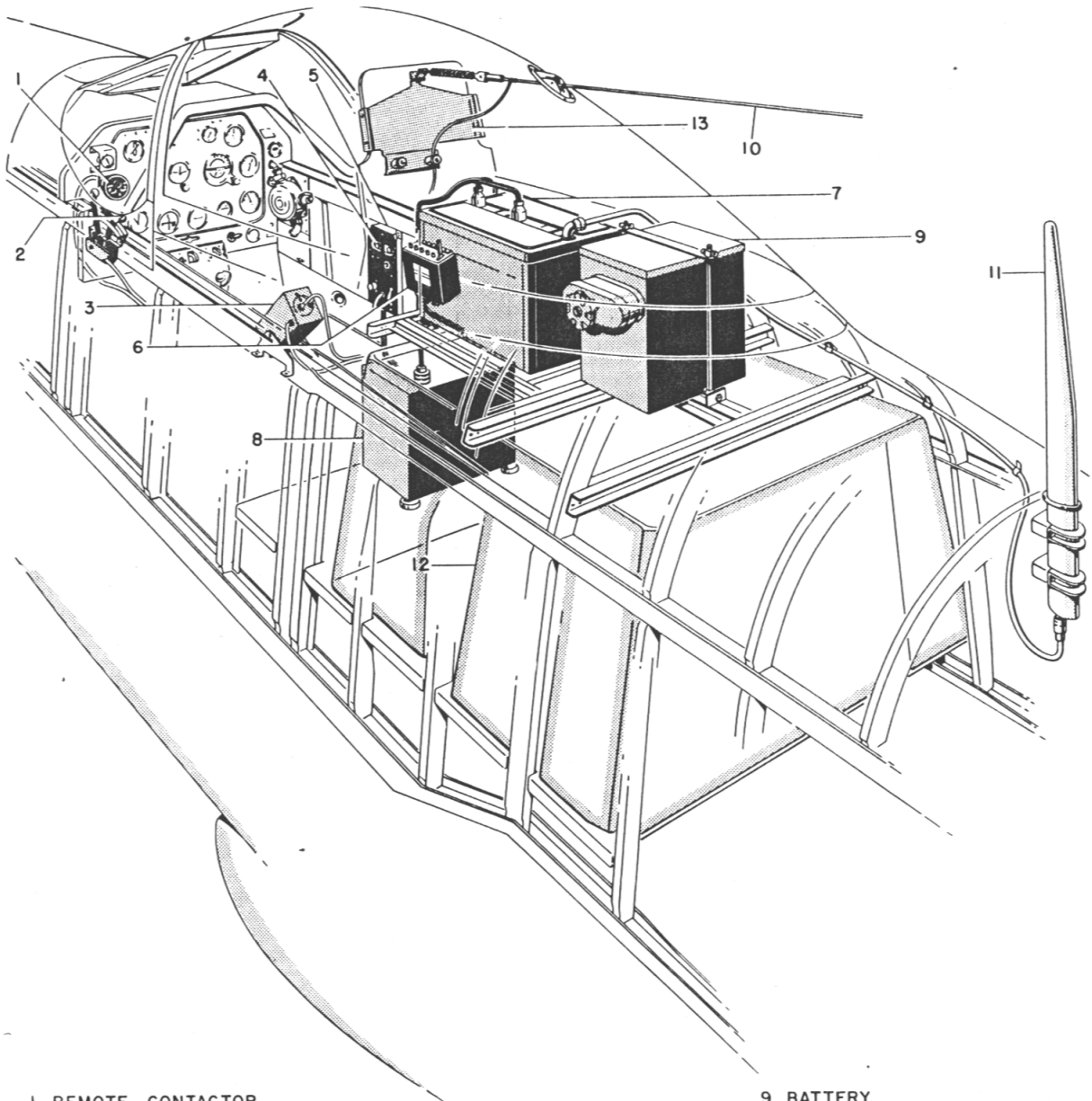

1. REMOTE CONTACTOR

2. THROTTLE SWITCH

3. DETROLA RECEIVER

4. SCR-695 DETONATOR BUTTONS

5. IO6-71154 PANEL ASSEMBLY

6. CONTROL BOX SCR-522

7. TRANSMITTER RECEIVER SCR-522

8. POWER SUPPLY SCR-522

9. BATTERY

10. DETROLA ANTENNA

11. ANTENNA SCR-522

12. FUSELAGE FUEL TANK

13. ANTENNA SUPPORT ASSEMBLY

Figure 37—SCR-522 Radio Equipment
(On Airplanes With 85 Gallon Fuselage Tank)

RESTRICTED

RESTRICTED
AN 01-60JE-1

OPERATIONAL EQUIPMENT
Sec V, Par 3

(2) OPERATION.

(a) TRANSMISSION.

1. Push button "A," "B," "C," or "D," depending upon the band to be used.

2. Allow set approximately one minute to warm up and, during this time, check contactor operation with switch in "OUT" and "IN" positions.

3. Transmit by pushing toggle switch at aft end of control box to "T" (transmit) position. To send an uninterrupted message, place contactor switch in "OUT" position.

NOTE

The lever just forward of the transmit-receive toggle switch controls the momentary or permanent action of the switch. A similar lever at the forward end of the control box regulates the brightness of the indicator lamps.

4. Move transmit-receive toggle switch to "REM" (remote control) if the remote control button on the throttle lever is to be used. Push button to transmit.

5. To turn set off, press button marked "OFF."

(b) RECEPTION.

1. Turn toggle switch at aft end of box to "R" (receive), or to "REM" if remote control is desired.

2. Press button "A," "B," "C," or "D," depending on which band is desired. Allow set approximately one minute to warm up. Reception of a signal will indicate whether the receiver is operating properly.

3. To turn set off, press button marked "OFF."

NOTE

The auxiliary receiver used with this set is turned on and off by the hexagonal control knob. The round knob is the frequency control.

c. COMMAND SET SCR-274-N.

(1) DESCRIPTION.

(a) GENERAL.—This set consists of two transmitters and three receivers with independent controls for each group, an antenna switching relay, and the necessary accessory items for interconnection of the units (*see figure 38*). The control boxes are mounted at the pilot's right. With the fuselage tank installed, one transmitter and two receivers are installed on the upper radio support, providing a transmitting range from 4000 to 5300 kcs and a receiving range from 190 to 550 kcs and 3000 to 6000 kcs. When

the fuselage tank is not installed, an additional transmitter and receiver may be mounted on the fixed radio shelf, extending the transmitting range from 5300 to 7000 kcs and the receiving range from 6000 to 9100 kcs.

(b) TRANSMITTER.—The transmitter control box contains three switches, marked "TRANS. POWER," "TRANSMITTER SELECTOR," and "TONE-CW-VOICE." The switch marked "TRANSMITTER SELECTOR" has four divisions, two of which are used. Markings on the "TONE-CW-VOICE" switch indicate the type of signal being transmitted. With the switch turned to the "TONE" position, a signal is transmitted which is practically 100% modulated at 1000 cycles. With the switch turned to the "CW" position, a "continuous wave" or unmodulated signal will be transmitted. With the switch turned to the "VOICE" position, the microphone will be operative and voice will be transmitted when the push-to-talk button on the throttle lever is pressed. For long-range communication, "CW" is most effective, "TONE" next, and "VOICE" least effective. The microphone is inoperative on both the "CW" and "TONE" positions, and code signals may be transmitted by a key on top the transmitter control box. If desired, a separate key may be plugged into the jack marked "KEY."

(c) RECEIVER.—The receiver control box is divided into three sections. A signal of specific frequency is received by using the section of the receiver control box which controls the particular receiver involved.

(2) OPERATION.

(a) TRANSMISSION.—Switch "ON" transmitter power switch, select one of the two transmitters, and turn "TONE-CW-VOICE" switch to the desired position.

(b) RECEPTION.—Turn on switch in upper right-hand corner of the control box section used. This switch, in addition to having an off position, has two selective positions marked "CW" and "MCW," each of which is an on position and indicates the type of signal to be received. To increase the volume of the signal, turn the knob in the lower left corner of the control section in a clockwise direction.

d. IDENTIFICATION EQUIPMENT.—The identification equipment is controlled from a box aft of the right-hand switch panel. For operating instructions, see the communications officer in charge. Detonator buttons and an inertia crash switch are provided with this equipment.

WARNING

Insert destructor plug only when the airplane is ready to take off. Remove plug immediately after landing.

RESTRICTED

43

OPERATIONAL EQUIPMENT
Sec V, Par 3

RESTRICTED
AN 01-60JE-1

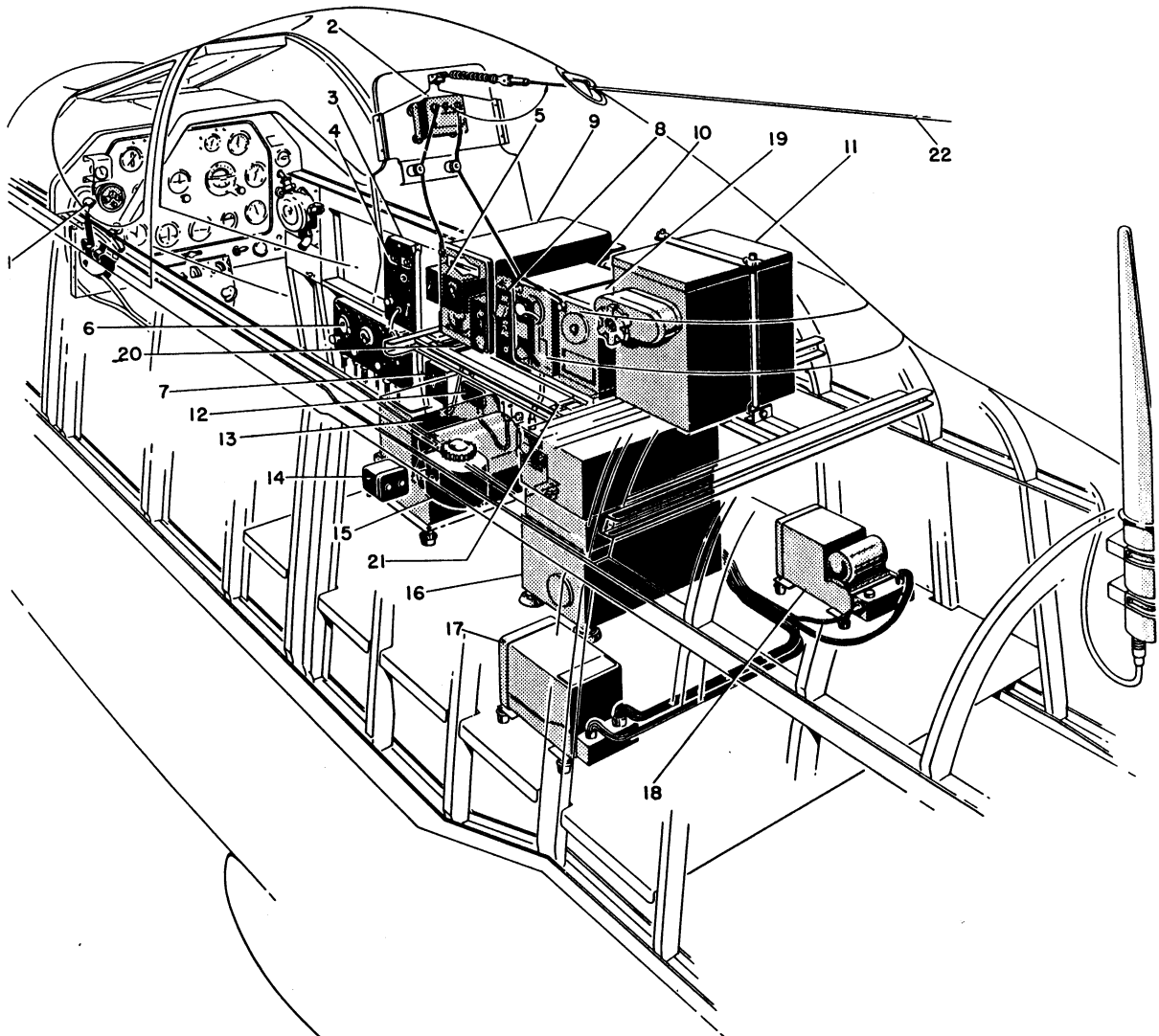

- | | | |
|-------------------------------------|-------------------------------|-------------------------------|
| 1. THROTTLE SWITCH | 7 FL-8 FILTER BOX | 15. INERTIA SWITCH SCR-515 |
| 2. BC-442 ANTENNA RELAY | 8. SCR-515 CONTROL BOX | 16. SCR-515 RADIO SET |
| 3. IO6-71154 PANEL ASSEMBLY | 9. BC-457 TRANSMITTER | 17. BC-458 TRANSMITTER |
| 4. SCR-515 DETONATOR BUTTONS | 10. BC-453 RECEIVER | 18. BC-455 RECEIVER |
| 5. BC-451-A TRANSMITTER CONTROL BOX | 11. BATTERY | 19. BC-454 RECEIVER |
| 6. BC-450-A RECEIVER CONTROL BOX | 12. MC-385 MICROPHONE ADAPTOR | 20. IO6-71131 CHANNEL SUPPORT |
| | 13. BC-456 MODULATOR UNIT | 21. IO9-71132 CHANNEL SUPPORT |
| | 14. INDICATOR LIGHTS SCR-515 | 22. SCR-274-N ANTENNA |

Figure 38—SCR-274-N and SCR-515 Radio Equipment

RESTRICTED
AN 01-60JE-1

OPERATIONAL EQUIPMENT
Sec V, Pars 3-4

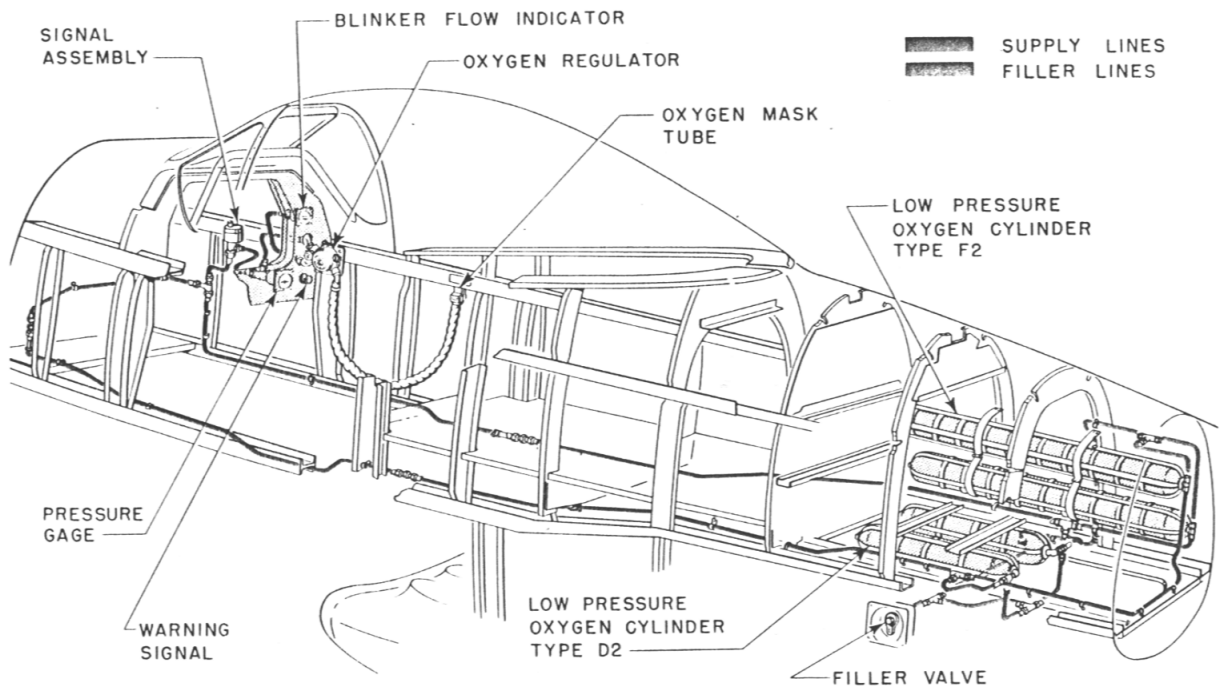

Figure 39—Oxygen System

e. PYROTECHNIC RECOGNITION SIGNAL PISTOL.

(1) DESCRIPTION.—AN-M-8 pyrotechnic pistol is stowed in a canvas holster strapped to the pistol cartridge stowage bag on the upper left longeron, forward of the pilot's seat. A pistol mount is at the pilot's left. A cap, chained to the mount, covers the port when the pistol is not installed.

(2) OPERATION.

(a) Remove cover cap from mount.

(b) Insert muzzle of pistol in the mount so that the lugs on the pistol barrel slip into the slots; then, while depressing the mount release trigger, turn the pistol to right or left as far as it will go.

(c) To load pistol, press breech lock lever, behind the mount release trigger, and apply force on the butt until the breech opens. Then insert signal into the chamber and close breech. Pistol is cocked automatically when breech is closed.

WARNING

Do not load pistol except when it is in the mount, since no safety is provided.

f. SIGNAL LAMP.—A Type AN-3089 signal lamp may be stowed on a bracket on the left side of the cockpit floor. An electrical receptacle for the lamp is located on the extreme upper right side of the cockpit behind the pilot's seat. Colored filters may be used with the lamp.

g. RECOGNITION LIGHTS.—For operation of recognition lights, see Section II, paragraph 23, a. (5).

4. OXYGEN SYSTEM.

a. DESCRIPTION.—Oxygen is supplied from two Type D-2 and two Type F-2 low pressure oxygen cylinders. A Type A-12 demand regulator, cylinder pressure gage, low-pressure warning signal, and flow indicator are in the cockpit (see figure 39). A Type A-9, A-9A, A-10, or B-14 mask may be used with this equipment. The blinker flow indicator operates with the breathing of the wearer, indicating proper functioning of the system. When the pressure of the cylinders drops to the danger point (100 lbs./sq. in.), a signal lamp on the instrument panel illuminates. The oxygen cylinders may be refilled without removal from the airplane by means of a filler valve on the left rear side of the fuselage. Normal full pressure of the system is 365 lbs./sq. in. See figure 40 for oxygen consumption chart.

RESTRICTED

OPERATIONAL EQUIPMENT
Sec V, Par 4

RESTRICTED
AN 01-60JE-1

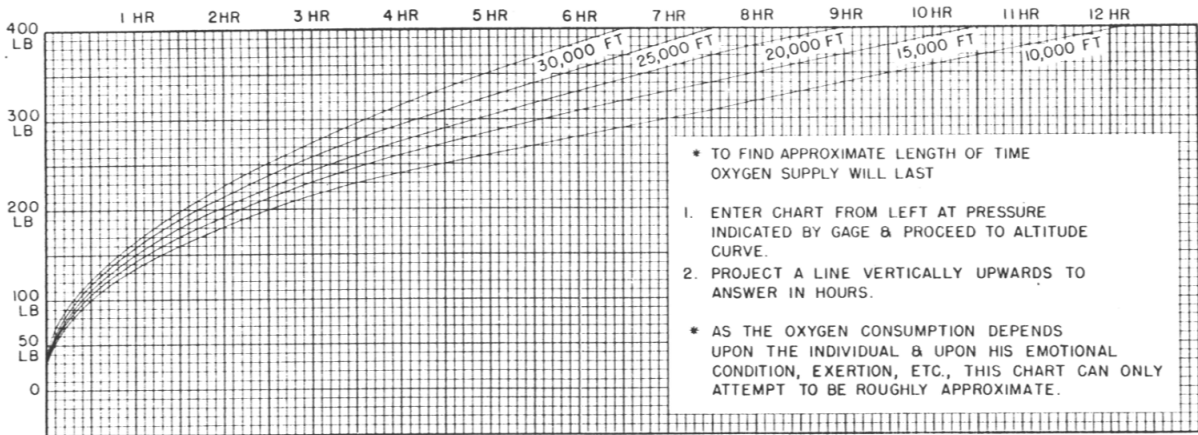

Figure 40—Oxygen Consumption Chart

b. OPERATION.

(1) PREFLIGHT CHECK.

(a) See that mask is properly fitted and check for leakage by holding the thumb over the corrugated hose fitting and inhaling normally. See that mask is clean.

(b) Check mask fitting to see that gasket is in place; then insert fitting into the end of the tubing from the regulator. Be sure the fit is snug and that a pull of at least 10 pounds is required to separate the two.

(c) Inspect mask regulator tubing for damage. Make sure all clamps are firmly in place.

(d) Attach the spring clip on the tubing to the clothing or parachute harness high up on the chest. It may be desirable to sew a tab of fabric or webbing to the cloth-

ing to accommodate the clip. Be sure that the attachment is high enough to permit free movement of the head without kinking the mask hose.

(e) Make certain the knurled collar at the outlet end of the regulator is tight. Examine top diaphragm to see that it is not ruptured or distorted.

(f) Turn emergency knob "ON" to check the flow. Check the pressure gage to see that there is no perceptible pressure drop. Turn emergency knob "OFF" and ascertain that it does not leak. Leave it in this position.

(g) Turn the auto-mix to "OFF." Note on flow indicator that on inhalation the top diaphragm goes down and that nearly 100 percent oxygen is received. Turn the auto-mix to "ON" and note that there is little or no indication of oxygen flow on the indicator. Leave in this position.

(b) Check that pressure of the system is not less than 365 lbs./sq. in. Before take-off, make certain that the pressure gage shows sufficient oxygen supply for the mission.

(2) DURING FLIGHT.

(a) If ice forms on mask, manipulate the mask at regular intervals to free it from ice.

(b) Be sure hose does not become kinked or twisted.

(c) If a lack of oxygen is experienced, turn "ON" red emergency knob on regulator.

(d) Check pressure gage and flow indicator frequently.

(e) In any flight over 30,000 feet, pay particular attention to oxygen equipment. Be sure all units and instruments are functioning perfectly before attempting flight

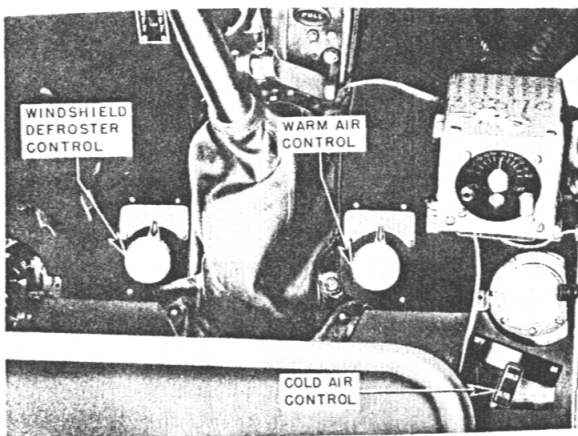

Figure 41—Heating, Ventilating, and Defrosting Controls

RESTRICTED
AN 01-60JE-1OPERATIONAL EQUIPMENT
Sec V, Par 4

Figure 42—Heating, Ventilating, and Defrosting Systems

to extremely high altitudes. Any failure of the equipment may be fatal.

(3) AFTER FLIGHT.

(a) Be sure all oxygen equipment is in proper condition before leaving airplane. If any difficulties have developed during flight, take necessary steps to have them corrected.

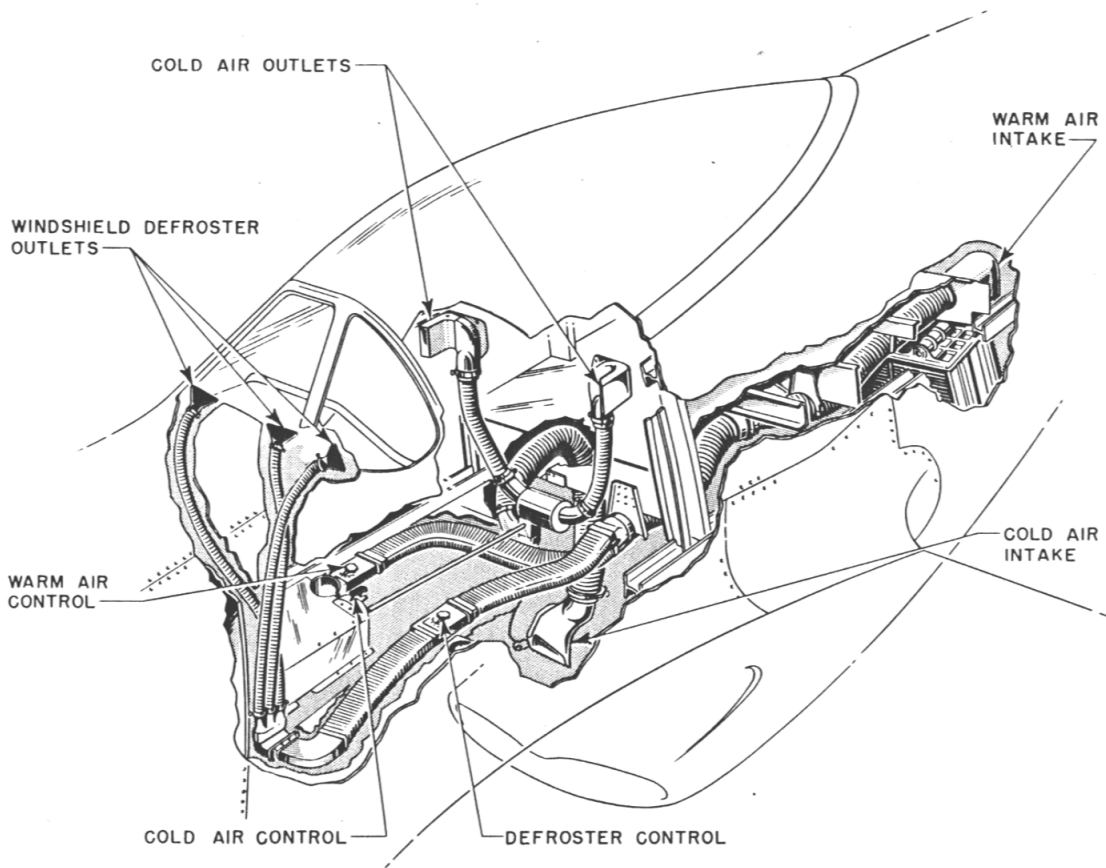
(b) If oxygen pressure is below 100 lbs./sq. in., see that the supply warning light is on. If the pressure is slightly above 100 lbs./sq. in., bleed oxygen out of sys-

tem by turning red emergency knob to "ON" and see that the supply warning light goes on at about 100 lbs./sq. in. Turn emergency knob to "OFF."

(c) Wash mask with mild soap and water, dry thoroughly, and leave in a clean airy place out of the sunlight.

NOTE

The oxygen mask will not stand abuse. See that the mask is properly stored or hung up in the airplane when not in use. Exposure of the mask to sunlight causes rapid deterioration.

RESTRICTED

47

OPERATIONAL EQUIPMENT

Sec V, Par 5

RESTRICTED
AN 01-60JE-1

5. HEATING, VENTILATING, AND DEFROSTING SYSTEM.

a. **COCKPIT HEATING AND DEFROSTING.**—Warm air from aft of the coolant radiator is utilized to heat the cockpit and to defrost the windshield and left side window (*see figure 42*). The cockpit hot air control is on the floor at the right of the control column; the defroster control is on the floor at the left of the control column.

To admit warm air turn desired control to the right, toward "ON."

b. **COCKPIT VENTILATION.**—Air from the forward section of the radiator air scoop is used to cool the cockpit. The cold air control is on the floor at the right side of the pilot's seat. Cold air outlets are located behind the pilot's seat.

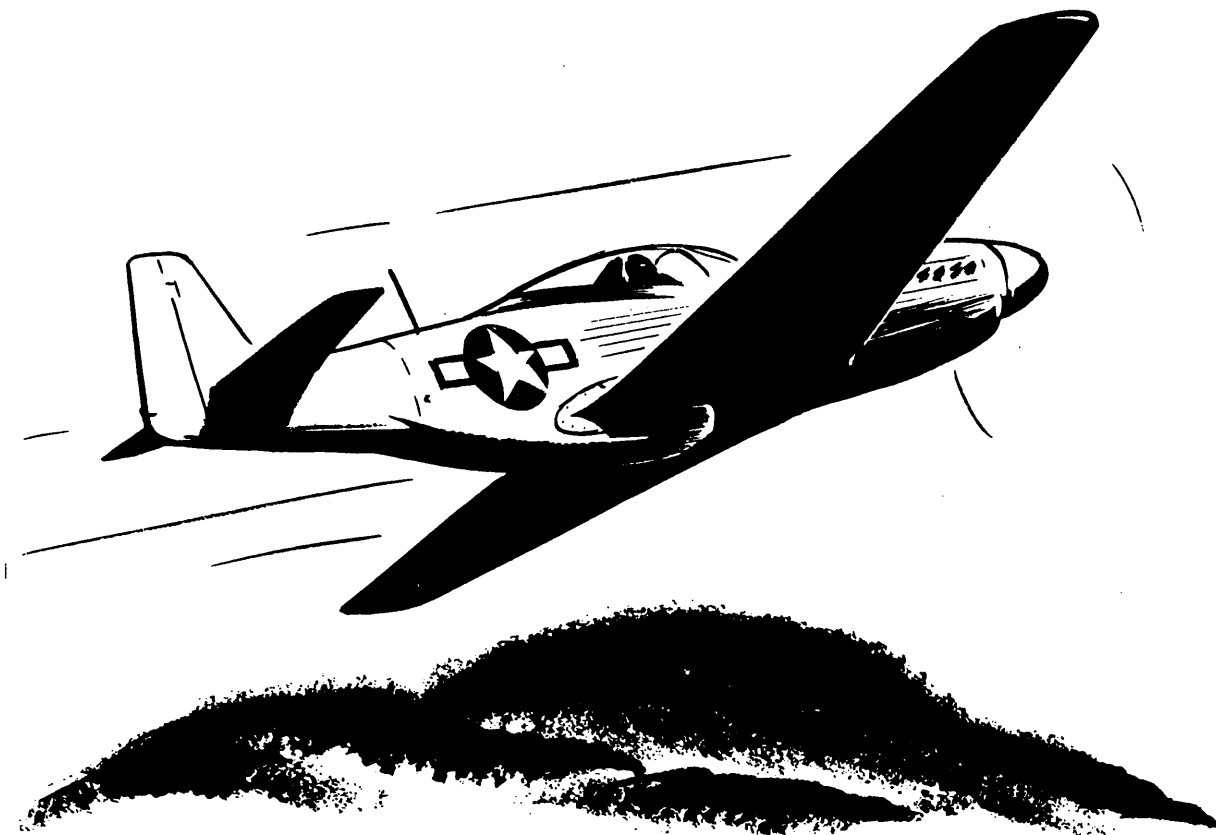

RESTRICTED
AN 01-60JE-1

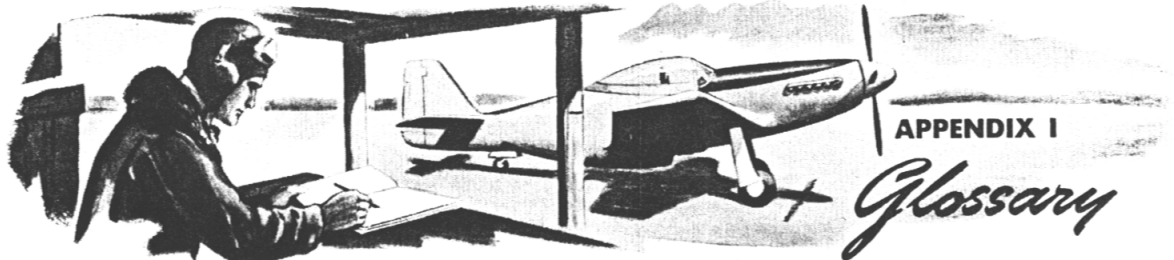

AMERICAN
TERMINOLOGY

BRITISH
TERMINOLOGY

Accumulator.....	Pressure Reservoir
Battery.....	Accumulator
Carburetor.....	Carburettor
Cockpit Enclosure.....	Cockpit Hood
Control Stick.....	Control Column
Empennage.....	Tail Unit
Engine (Power Plant).....	Aero-Engine
Firewall.....	Fireproof Bulkhead
Indicated Airspeed.....	Air-Speed-Indicator Reading
Land.....	Alight
Landing Gear.....	Undercarriage
Left.....	Port
Lines.....	Pipes
Manifold Pressure.....	Boost
Mooring Rings.....	Picketing Rings
Radio.....	Wireless
Right.....	Starboard
Shock Strut.....	Oleo Leg
Surface Control Lock.....	Locking Gear
Surface Controls.....	Flying Controls
Windshield.....	Windscreen
Wing.....	Main Plane

RESTRICTED
AN 01-60JE-1



RESTRICTED
AN 01-60JE-1



1. FLIGHT PLANNING.

a. GENERAL.

(1) A series of charts on the following pages is provided to aid in selecting the proper power and altitude to be used for obtaining optimum range of the airplane. Charts are provided for each airplane configuration with the probable ranges of gross weights.

NOTE

Two sets of Flight Operation Instruction Charts are provided. The first set of charts (*figures 44 through 50*) is applicable to airplanes with V-1650-7 engines; the second set (*figures 51 through 57*) applies to airplanes which have had V-1650-3 engines installed in service.

(2) If the flight plan calls for a continuous flight where the desired cruising power and airspeed are reasonably constant after take-off and climb and the external load items are the same throughout the flight, the fuel required and flight time may be computed as a single section flight. If this is not the case, the flight should be broken up into sections, and each leg of the flight planned separately, since dropping of external bombs or tanks causes considerable changes in range and airspeed for given power. (Within the limits of the airplane, the fuel required and flying time for a given mission depend largely upon the speed desired. With all other factors remaining equal in an airplane, speed is obtained at a sacrifice of range, and range is obtained at a sacrifice of speed.)

b. USE OF CHARTS.

(1) Although instructions for their use are shown on the Flight Operation Instruction Charts, the following expanded information on proper use of the charts may be helpful.

(2) Select the Flight Operation Instruction Chart for the model airplane, gross weight, and external loading to be used at take-off. The amount of gasoline available for flight planning purposes depends upon the reserve required and the amount required for starting and warm-up. The fuel required for warm-up and initial climb is set forth on

the chart. Reserve should be based on the type of mission, terrain over which the flight is to be made, and weather conditions. The fuel required for climb and time to climb to various altitudes is shown on the Take-off, Climb, and Landing Chart. Fuel remaining after subtracting reserve, warm-up, and climb fuel from total amount available is the amount to be used for flight planning.

(3) Select a figure in the fuel column in the upper section of the chart equal to, or the next entry less than, the amount of fuel available for flight planning. Move horizontally to the right or left and select a figure equal to, or the next entry greater than, the distance (with no wind) to be flown. Operating values contained in the lower section of the column number in which this figure appears represent the highest cruising speeds possible at the range desired. It will be noted that the ranges listed in column I are correct only at sea level and are conservative for higher altitudes. The ranges shown in column II and other columns to the right of column II can be obtained at any of the altitudes listed in the Altitude column. All of the power settings listed in a column will give approximately the same number of miles per gallon if each is used at the altitude shown on the same horizontal line with it. Note that the time required for the flight may be shortened by selection of the higher altitudes. In long-range cruising it is important that altitude, airspeed, and rpm be held constant. The manifold pressure should be changed as required to hold the above values reasonably constant. The flight duration may be obtained by dividing the true airspeed of the flight altitude into the air miles to be flown.

(4) The flight plan may be readily changed at any time en route, and the chart will show the balance of range available at various cruising powers by following the Instructions for Using Chart printed on each chart.

IMPORTANT

The above instructions and following charts do not take into account the effect of wind. Adjustments to range values and flight duration to allow for wind may be made by any method familiar to the pilot, such as by the use of a flight calculator or a navigator's triangle of velocities.

RESTRICTED

▪

FLIGHT OPERATING CHARTS
Appendix II

RESTRICTED
AN 01-60JE-1

MODEL(S) P-51D		EXTERNAL LOAD ITEMS 2 - 300-LB. WING BOMBS (OR SMALLER SIZE)				FLIGHT OPERATION INSTRUCTION CHART													
ENGINE(S): V-1650-7		CHART WEIGHT LIMITS: 9500 TO 8000 POUNDS				INSTRUCTIONS FOR USING CHART: Select figure in FUEL column equal to or less than amount of fuel to be used for cruising. Move horizontally to left or right and select RANGE value equal to or greater than the statute or nautical air miles to be flown. Vertically below and opposite desired cruising altitude (ALT.) read optimum R. P. M., I. A. S. and MIXTURE setting required.													
LIMITS	R. P. M.	M. P. (CR. ED.)	FLOWER POSITION	MIXTURE POSITION	TIME LIMIT	TOTAL C.P.S.	I		II		III		IV		V				
							STATUTE	NAUTICAL	STATUTE	NAUTICAL	STATUTE	NAUTICAL	STATUTE	NAUTICAL	STATUTE	NAUTICAL			
W.A. Z.	3000	67	MIN	AR	5	194	I. 24 GAL. ALLOWANCE NOT AVAILABLE IN FLIGHT										FUEL U.S. GALL.		
MUSKAT	3000	61	LOW	AR	15	176	430	430	600	520	720	720	184	184	850	740			
WALL-SWAYED	2700	96	LOW	AR	CMT.	109	380	330	450	390	540	540	120	120	640	550			
						106	100	270	380	330	450	450	100	100	530	460			
							250	220	300	260	360	360	80	80	430	370			
							190	160	220	190	270	270	60	60	320	280			
							120	110	150	130	180	180	40	40	220	190			
							60	50	70	60	90	90	20	20	110	100			
MAXIMUM CONTINUOUS		R. P. M.	I. A. S.	MIX. TURE	G. T. A.	ALT. Feet	OPERATING DATA		OPERATING DATA		OPERATING DATA		OPERATING DATA		MAXIMUM RANGE				
2700	270	AR	46	115	395	25000	R. P. M.	I. A. S. <td>MIX. TURE <td>G. T. A. <td>ALT. Feet</td> <td>R. P. M.</td> <td>I. A. S. <td>MIX. TURE <td>G. T. A. <td>ALT. Feet</td> </td></td></td></td></td>	MIX. TURE <td>G. T. A. <td>ALT. Feet</td> <td>R. P. M.</td> <td>I. A. S. <td>MIX. TURE <td>G. T. A. <td>ALT. Feet</td> </td></td></td></td>	G. T. A. <td>ALT. Feet</td> <td>R. P. M.</td> <td>I. A. S. <td>MIX. TURE <td>G. T. A. <td>ALT. Feet</td> </td></td></td>	ALT. Feet	R. P. M.	I. A. S. <td>MIX. TURE <td>G. T. A. <td>ALT. Feet</td> </td></td>	MIX. TURE <td>G. T. A. <td>ALT. Feet</td> </td>	G. T. A. <td>ALT. Feet</td>	ALT. Feet			
2700	275	AR	FT	100	375	20000	2450	255	AR	41	89	375	2400	240	AR	37	71	355	
2700	290	AR	46	113	365	15000	2550	260	AR	FT	84	355	2400	240	AL	FT	66	330	20000
2700	290	AR	46	108	340	10000	2550	280	AR	43	93	325	2400	260	AR	38	73	305	2250
2700	290	AR	46	103	315	5000	2550	280	AR	43	86	300	2400	260	AR	38	67	280	2250
2700	290	AR	46	98	295	S. L.	2550	280	AR	43	80	280	2400	260	AR	38	62	260	2250

Figure 46—Flight Operation Instruction Chart—V-1650-7 Engine (Two 300-lb. Wing Bombs—9500 to 8000 lbs.)

RESTRICTED

RESTRICTED
AN 01-60JE-1

FLIGHT OPERATING CHARTS
Appendix II

MODEL(S) P-51D		EXTERNAL LOAD ITEMS 2 - 500-LB. WING BOMBS			
ENGINE(S): V-1650-7		CHART WEIGHT LIMITS: 10,500 TO 10,000 POUNDS			
LIMITS	R.P.M.	M.P. (DE. EL.) POSITION	MIXTURE POSITION	TOTAL G.P.H.	
				TIME LIMIT	ALT.
WAR	3000	67	LOW	194	187
MILITARY	3000	61	LOW	178	170
USUAL	2700	46	HIGH	103	103

I		II		III		IV		V	
RANGE IN AIR MILES		RANGE IN AIR MILES		RANGE IN AIR MILES		RANGE IN AIR MILES		RANGE IN AIR MILES	
STATUTE	NAUTICAL	STATUTE	NAUTICAL	STATUTE	NAUTICAL	STATUTE	NAUTICAL	STATUTE	NAUTICAL
630	540	780	660	870	760	1020	890	1180	1020
570	500	700	610	800	690	940	810	1080	940
520	450	640	550	730	630	860	740	980	850
470	410	570	500	650	570	770	660	880	770
420	360	510	440	580	500	680	590	780	680
370	320	440	390	510	440	600	520	690	600

MAXIMUM CONTINUOUS		OPERATING DATA		OPERATING DATA		OPERATING DATA		MAXIMUM RANGE	
R.P.M.	L.A.S. M.P.H.	M.P. In. P. A. El. S.	M.T. In. P. A. El. S.	R.P.M.	L.A.S. M.P.H.	M.P. In. P. A. El. S.	M.T. In. P. A. El. S.	R.P.M.	L.A.S. M.P.H.
		40000							
		35000							
		30000							
2700	260	AR	46 115 385	2500	245	AR	41 91 365	2400	235
2700	265	AR	46 110 360	2600	255	AR	41 87 350	2450	240
2700	280	AR	46 113 355	2400	255	AR	40 82 325	2250	240
2700	280	AR	46 108 330	2400	255	AR	39 73 300	2300	245
2700	280	AR	46 103 305	2400	255	AR	38 67 275	2350	245
2700	280	AR	46 98 285	2400	255	AR	38 63 255	2350	245

FUEL		OPERATING DATA		OPERATING DATA		OPERATING DATA		MAXIMUM RANGE	
U.S. GALL.	ALT. Feet	R.P.M.	L.A.S. M.P.H.	M.P. In. P. A. El. S.	R.P.M.	L.A.S. M.P.H.	M.P. In. P. A. El. S.	R.P.M.	L.A.S. M.P.H.
269	40000								
240	35000								
220	30000								
200	25000								
180	20000								
160	15000								
140	10000								

NOTES:

- ALLOW 20 GAL. FOR WING TAKE-OFF & INITIAL CLIMB PLUS ALLOWANCE FOR WIND, RESERVE & COMBAT AS REQD.
- IF 85-GALLON FUSELAGE TANK IS INSTALLED AND SERVICED, WARM-UP, TAKE-OFF, CLIMB, AND CRUISE ON FUSELAGE TANK UNTIL AT LEAST 50 GALLONS ARE USED BEFORE SWITCHING TO WING TANKS.

EXAMPLE: AT 10,300 LB. GROSS WT. WITH 240 GAL. OF FUEL (AFTER DEDUCTING TOTAL ALLOWANCES OF 29 GAL.) TO FLY 950 STAT. AIRMILES AT 10,000 FT. ALT. MAINTAIN 2300 RPM AND 245 MPH IND. AIRSPEED WITH MIXTURE SET AUTO LEAN.

LEGEND:

- L.A.S.: INDICATED AIRSPEED
- M.P.: MAXIMUM POWER
- G.P.H.: U.S. GALL. PER HOUR
- T.A.E.: TRUE AIRSPEED
- S.L.: SEA LEVEL
- F.T.: FULL THROTTLE
- A.L.: AUTO-LEAN
- A.L.I.: AUTO-LEAN
- C.L.I.: CRUISE LEAN

RED FIGURES ARE PRELIMINARY SUBJECT TO REVISION AFTER FLIGHT CHECK

Figure 47—Flight Operation Instruction Chart—V-1650-7 Engine
(Two 500-lb. Wing Bombs—10,500 to 10,000 lbs.)

RESTRICTED

FLIGHT OPERATING CHARTS
Appendix II

RESTRICTED
AN 01-60JE-1

MODEL(S) P-51D		FLIGHT OPERATION INSTRUCTION CHART										EXTERNAL LOAD ITEMS	
ENGINE(S): V-1650-7		CHART WEIGHT LIMITS: 10,000 TO 8500 POUNDS.										2 - 500-LB. WING BOMBS	
LIMITS		M.P. (IN. EG.)		MIXTURE POSITION		TIME LIMIT		TOTAL C.P.H.		INSTRUCTIONS FOR USING CHART:		NOTES:	
WAR MAX.	MILITARY POWER	R.P.M.	LOW	HIGH	AR	5	184	184	184	184	Column I is for emergency high speed cruising only. Columns II, III, IV and V give progressive increase in range at a sacrifice in speed. Manifold pressure (M. P.), gallons per hour (G. P. H.) and true airspeed (T. A. S.) are approximate values for reference. For efficiency maintain indicated airspeed (I. A. S.) hourly. Adjust RPM slightly if necessary to avoid exceeding manifold pressure more than 3 in. Hg.	Column I is for emergency high speed cruising only. Columns II, III, IV and V give progressive increase in range at a sacrifice in speed. Manifold pressure (M. P.), gallons per hour (G. P. H.) and true airspeed (T. A. S.) are approximate values for reference. For efficiency maintain indicated airspeed (I. A. S.) hourly. Adjust RPM slightly if necessary to avoid exceeding manifold pressure more than 3 in. Hg.	Column I is for emergency high speed cruising only. Columns II, III, IV and V give progressive increase in range at a sacrifice in speed. Manifold pressure (M. P.), gallons per hour (G. P. H.) and true airspeed (T. A. S.) are approximate values for reference. For efficiency maintain indicated airspeed (I. A. S.) hourly. Adjust RPM slightly if necessary to avoid exceeding manifold pressure more than 3 in. Hg.
2700	3000	3000	67	81	96	15	171	171	171	171	optimum R. P. M., I. A. S. and MIXTURE setting required.	optimum R. P. M., I. A. S. and MIXTURE setting required.	optimum R. P. M., I. A. S. and MIXTURE setting required.
2700	2700	2700	67	81	96	15	171	171	171	171	optimum R. P. M., I. A. S. and MIXTURE setting required.	optimum R. P. M., I. A. S. and MIXTURE setting required.	optimum R. P. M., I. A. S. and MIXTURE setting required.
I		II		III		IV		V		FUEL		RANGE IN AIR MILES	
RANGE IN AIR MILES		RANGE IN AIR MILES		RANGE IN AIR MILES		RANGE IN AIR MILES		RANGE IN AIR MILES		U. S.		STATUTE	
STATUTE	NAUTICAL	STATUTE	NAUTICAL	STATUTE	NAUTICAL	STATUTE	NAUTICAL	STATUTE	NAUTICAL	GALL.	STATUTE	NAUTICAL	STATUTE
420	360	500	430	580	500	680	590	184	800	184	800	740	740
370	320	440	380	510	440	600	520	160	700	160	700	610	610
310	270	370	320	430	360	510	440	120	600	120	600	520	520
260	230	310	270	360	310	420	370	100	500	100	500	440	440
210	180	250	210	280	250	340	290	80	400	80	400	350	350
150	130	180	160	210	190	250	220	60	300	60	300	270	270
100	90	120	110	140	120	170	140	40	200	40	200	180	180
50	40	60	50	70	60	80	70	20	100	20	100	90	90
MAXIMUM CONTINUOUS		OPERATING DATA		OPERATING DATA		OPERATING DATA		OPERATING DATA		ALT.		MAXIMUM RANGE	
R.P.M.	I.A.S.	M.P.	T. A. S.	R.P.M.	I.A.S.	M.P.	T. A. S.	R.P.M.	I.A.S.	M.P.	T. A. S.	R.P.M.	I.A.S.
2700	260	AR	46	115	365	25000		2700	270	AR	100	365	20000
2700	270	AR	46	113	355	15000		2700	280	AR	46	113	355
2700	280	AR	46	108	330	10000		2700	280	AR	46	103	305
2700	280	AR	46	103	305	5000		2700	280	AR	46	98	285
2700	280	AR	46	98	285	S. L.		2700	280	AR	46	98	285

Figure 48—Flight Operation Instruction Chart—V-1650-7 Engine
(Two 500-lb. Wing Bombs—10,000 to 8500 lbs.)

RESTRICTED
AN 01-60JE-1

FLIGHT OPERATING CHARTS
Appendix II

MODEL(S) P-51D										EXTERNAL LOAD ITEMS 2 - 75-GALLON COMBAT TANKS									
ENGINE(S): V-1650-7										CHART WEIGHT LIMITS: 10,700 TO 9600 POUNDS									
INSTRUCTIONS FOR USING CHART: Select figure in FUEL column equal to or less than amount of fuel to be used for cruising. Move horizontally to left or right and select RANGE value equal to or greater than the statute or nautical air miles to be flown. Vertically below and opposite desired cruising altitude (ALT), read optimum R. P. M., I. A. S. and MIXTURE setting required.										NOTES: Column I is for emergency high speed cruising only. Columns II, III, IV and V give progressive increase in range at sacrifice in speed. Manifold pressure (M. P.), gallons per hour (G. P. H.) and true airspeed (T. A. S.) are approximate values for reference. For efficiency maintain indicated airspeed (I. A. S.) hourly. Adjust RPM slightly if necessary to avoid exceeding manifold pressure more than 3 in. Hg.									
LIMITS		R. P. M.		M. P. (IN. HG.)		MIXTURE POSITION		TOTAL G. P. H.		TIME LIMIT		STATUTE		NAUTICAL		RANGE IN AIR MILES		FUEL	
WAR MAX	MILITARY	2700	3000	67	61	LOW	LOW	194	178	5	15	1210	1050	1410	1230	1610	1400	419	390
NORMAL RATED						LOW	HIGH	103	103	COMT.									
1000		870		870		870		870		870		870		870		870		870	
920		800		800		800		800		800		800		800		800		800	
850		730		730		730		730		730		730		730		730		730	
770		670		670		670		670		670		670		670		670		670	
690		600		600		600		600		600		600		600		600		600	
610		530		530		530		530		530		530		530		530		530	
2700		245		245		245		245		245		245		245		245		245	
2700		255		255		255		255		255		255		255		255		255	
2700		260		260		260		260		260		260		260		260		260	
2700		275		275		275		275		275		275		275		275		275	
2700		275		275		275		275		275		275		275		275		275	
2700		275		275		275		275		275		275		275		275		275	
2700		275		275		275		275		275		275		275		275		275	
2700		275		275		275		275		275		275		275		275		275	
2700		275		275		275		275		275		275		275		275		275	
2700		275		275		275		275		275		275		275		275		275	
2700		275		275		275		275		275		275		275		275		275	
2700		275		275		275		275		275		275		275		275		275	
2700		275		275		275		275		275		275		275		275		275	
2700		275		275		275		275		275		275		275		275		275	
2700		275		275		275		275		275		275		275		275		275	
2700		275		275		275		275		275		275		275		275		275	
2700		275		275		275		275		275		275		275		275		275	
2700		275		275		275		275		275		275		275		275		275	
2700		275		275		275		275		275		275		275		275		275	
2700		275		275		275		275		275		275		275		275		275	
2700		275		275		275		275		275		275		275		275		275	
2700		275		275		275		275		275		275		275		275		275	
2700		275		275		275		275		275		275		275		275		275	
2700		275		275		275		275		275		275		275		275		275	
2700		275		275		275		275		275		275		275		275		275	
2700		275		275		275		275		275		275		275		275		275	
2700		275		275		275		275		275		275		275		275		275	
2700		275		275		275		275		275		275		275		275		275	
2700		275		275		275		275		275		275		275		275		275	
2700		275		275		275		275		275		275		275		275		275	
2700		275		275		275		275		275		275		275		275		275	
2700		275		275		275		275		275		275		275		275		275	
2700		275		275		275		275		275		275		275		275		275	
2700		275		275		275		275		275		275		275		275		275	
2700		275		275		275		275		275		275		275		275		275	
2700		275		275		275		275		275		275		275		275		275	
2700		275		275		275		275		275		275		275		275		275	
2700		275		275		275		275		275		275		275		275		275	
2700		275		275		275		275		275		275		275		275		275	
2700		275		275		275		275		275		275		275		275		275	
2700		275		275		275		275		275		275		275		275		275	
2700		275		275		275		275		275		275		275		275		275	
2700		275		275		275		275		275		275		275		275		275	
2700		275		275		275		275		275		275		275		275		275	
2700		275		275		275		275		275		275		275		275		275	
2700		275		275		275		275		275		275		275		275		275	
2700		275		275		275		275		275		275		275		275		275	
2700		275		275		275		275		275		275		275		275		275	
2700		275		275		275		275		275		275		275		275		275	
2700		275		275		275		275		275		275		275		275		275	
2700		275		275		275		275		275		275		275		275		275	
2700		275		275		275		275		275		275		275		275		275	
2700		275		275		275		275		275		275		275		275		275	
2700		275		275		275		275		275		275		275		275		275	
2700		275		275		275		275		275		275		275		275		275	
2700		275		275		275		275		275		275		275		275		275	
2700		275		275		275		275		275		275		275		275		275	
2700		275		275		275		275		275		275		275		275		275	
2700		275		275		275		275		275		275		275		275		275	
2700		275		275		275		275		275		275		275		275		275	
2700		275		275		275		275		275		275		275		275		275	
2700		275		275		275		275		275		275		275		275		275	
2700		275		275		275		275		275		275		275		275		275	
2700		275		275		275		275		275		275		275		275		275	
2700		275		275		275		275		275		275		275		275		275	
2700		275		275		275		275		275		275		275		275		275	
2700		275		275		275		275		275		275		275		275		275	
2700		275		275		275		275		275		275		275		275		275	
2700		275		275		275		275		275		275		275		275		275	
2700		275		275		275		275		275		275		275		275		275	
2700		275		275		275		275		275		275		275		275		275	
2700		275		275		275		275		275		275		275		275		275	
2700		275		275		275		275		275		275		275		275		275	
2700		275		275		275		275		275		275		275		275		275	
2700		275		275		275		275		275		275		275		275		275	
2700		275		275		275		275		275		275		275		275		275	
2700		275		275		275		275		275		275		275		275		275	
2700		275		275		275		275		275		275		275		275		275	
2700		275		275		275		275		275		275		275		275		275	
2700		275		275		275		275		275		275		275		275		275	
2700		275		275		275		275		275		275		275		275		275	
2700		275		275		275		275		275		275		275		275		275	
2700		275		275		275		275		275		275		275		275		275	
2700		275		27															

FLIGHT OPERATING CHARTS
Appendix II

RESTRICTED
AN 01-60JE-1

MODEL(S) P-51D		FLIGHT OPERATION INSTRUCTION CHART										EXTERNAL LOAD ITEMS																							
ENGINE(S): V-1650-7		CHART WEIGHT LIMITS: 9600 TO 8000 POUNDS										2 - 75-GALLON COMBAT TANKS																							
LIMITS		M.P.M. (UN. EQ.)		MIXTURE POSITION		TIME LIMIT		TOTAL G.P.H.		INSTRUCTIONS FOR USING CHART: Select figure in FUEL column equal to or less than amount of fuel to be used for cruising. Move horizontally to left or right and select RANGE value equal to or greater than the statute or nautical air miles to be down. Vertically below and opposite desired cruising altitude (ALT.) read optimum R. P. M., I. A. S. and MIXTURE setting required.		NOTES: Column I is for emergency high speed cruising only. Columns II, III, IV and V give progressive increase in range at a sacrifice in speed. Manifold pressure (M. P.), gallons per hour (G. P. H.) and true airspeed (T. A. S.) are approximate values for reference. For efficiency maintain indicated airspeed (I. A. S.) hourly. Adjust RPM slightly if necessary to avoid exceeding manifold pressure more than 3 in. Hg.																							
W.A. MAX.	MILITARY POWER	3000	3000	2700	67	61	46	5	187	170	109	108																							
NORMAL RATED					LOW HIGH	LOW HIGH	LOW HIGH	CONT.	AR	AR	AR	AR																							
I													FUEL																						
RANGE IN AIR MILES													U. S. GAL.																						
STATUTE													NAUTICAL																						
610	530	470	400	330	270	200	130	60	740	640	560	480	400	320	240	160	90	269	240	210	180	150	120	90	60	30	269	240	210	180	150	120	90	60	30
840	470	400	330	270	200	130	60	740	640	560	480	400	320	240	160	90	269	240	210	180	150	120	90	60	30	269	240	210	180	150	120	90	60	30	
460	400	330	270	200	130	60	740	640	560	480	400	320	240	160	90	269	240	210	180	150	120	90	60	30	269	240	210	180	150	120	90	60	30		
380	330	270	200	130	60	740	640	560	480	400	320	240	160	90	269	240	210	180	150	120	90	60	30	269	240	210	180	150	120	90	60	30			
310	270	200	130	60	740	640	560	480	400	320	240	160	90	269	240	210	180	150	120	90	60	30	269	240	210	180	150	120	90	60	30				
230	200	130	60	740	640	560	480	400	320	240	160	90	269	240	210	180	150	120	90	60	30	269	240	210	180	150	120	90	60	30					
150	130	60	740	640	560	480	400	320	240	160	90	269	240	210	180	150	120	90	60	30	269	240	210	180	150	120	90	60	30						
70	60	740	640	560	480	400	320	240	160	90	269	240	210	180	150	120	90	60	30	269	240	210	180	150	120	90	60	30							
II													RANGE IN AIR MILES		STATUTE		NAUTICAL		R.P.M.		I. A. S.		M.P.		T. A. S.		M.P.		T. A. S.						
III													RANGE IN AIR MILES		STATUTE		NAUTICAL		R.P.M.		I. A. S.		M.P.		T. A. S.		M.P.		T. A. S.						
IV													RANGE IN AIR MILES		STATUTE		NAUTICAL		R.P.M.		I. A. S.		M.P.		T. A. S.		M.P.		T. A. S.						
V													RANGE IN AIR MILES		STATUTE		NAUTICAL		R.P.M.		I. A. S.		M.P.		T. A. S.		M.P.		T. A. S.						
VI													RANGE IN AIR MILES		STATUTE		NAUTICAL		R.P.M.		I. A. S.		M.P.		T. A. S.		M.P.		T. A. S.						
VII													RANGE IN AIR MILES		STATUTE		NAUTICAL		R.P.M.		I. A. S.		M.P.		T. A. S.		M.P.		T. A. S.						
VIII													RANGE IN AIR MILES		STATUTE		NAUTICAL		R.P.M.		I. A. S.		M.P.		T. A. S.		M.P.		T. A. S.						
IX													RANGE IN AIR MILES		STATUTE		NAUTICAL		R.P.M.		I. A. S.		M.P.		T. A. S.		M.P.		T. A. S.						
X													RANGE IN AIR MILES		STATUTE		NAUTICAL		R.P.M.		I. A. S.		M.P.		T. A. S.		M.P.		T. A. S.						
XI													RANGE IN AIR MILES		STATUTE		NAUTICAL		R.P.M.		I. A. S.		M.P.		T. A. S.		M.P.		T. A. S.						
XII													RANGE IN AIR MILES		STATUTE		NAUTICAL		R.P.M.		I. A. S.		M.P.		T. A. S.		M.P.		T. A. S.						
XIII													RANGE IN AIR MILES		STATUTE		NAUTICAL		R.P.M.		I. A. S.		M.P.		T. A. S.		M.P.		T. A. S.						
XIV													RANGE IN AIR MILES		STATUTE		NAUTICAL		R.P.M.		I. A. S.		M.P.		T. A. S.		M.P.		T. A. S.						
XV													RANGE IN AIR MILES		STATUTE		NAUTICAL		R.P.M.		I. A. S.		M.P.		T. A. S.		M.P.		T. A. S.						
XVI													RANGE IN AIR MILES		STATUTE		NAUTICAL		R.P.M.		I. A. S.		M.P.		T. A. S.		M.P.		T. A. S.						
XVII													RANGE IN AIR MILES		STATUTE		NAUTICAL		R.P.M.		I. A. S.		M.P.		T. A. S.		M.P.		T. A. S.						
XVIII													RANGE IN AIR MILES		STATUTE		NAUTICAL		R.P.M.		I. A. S.		M.P.		T. A. S.		M.P.		T. A. S.						
XIX													RANGE IN AIR MILES		STATUTE		NAUTICAL		R.P.M.		I. A. S.		M.P.		T. A. S.		M.P.		T. A. S.						
XX													RANGE IN AIR MILES		STATUTE		NAUTICAL		R.P.M.		I. A. S.		M.P.		T. A. S.		M.P.		T. A. S.						
XXI													RANGE IN AIR MILES		STATUTE		NAUTICAL		R.P.M.		I. A. S.		M.P.		T. A. S.		M.P.		T. A. S.						
XXII													RANGE IN AIR MILES		STATUTE		NAUTICAL		R.P.M.		I. A. S.		M.P.		T. A. S.		M.P.		T. A. S.						
XXIII													RANGE IN AIR MILES		STATUTE		NAUTICAL		R.P.M.		I. A. S.		M.P.		T. A. S.		M.P.		T. A. S.						
XXIV													RANGE IN AIR MILES		STATUTE		NAUTICAL		R.P.M.		I. A. S.		M.P.		T. A. S.		M.P.		T. A. S.						
XXV													RANGE IN AIR MILES		STATUTE		NAUTICAL		R.P.M.		I. A. S.		M.P.		T. A. S.		M.P.		T. A. S.						
XXVI													RANGE IN AIR MILES		STATUTE		NAUTICAL		R.P.M.		I. A. S.		M.P.		T. A. S.		M.P.		T. A. S.						
XXVII													RANGE IN AIR MILES		STATUTE		NAUTICAL		R.P.M.		I. A. S.		M.P.		T. A. S.		M.P.		T. A. S.						
XXVIII													RANGE IN AIR MILES		STATUTE		NAUTICAL		R.P.M.		I. A. S.		M.P.		T. A. S.		M.P.		T. A. S.						
XXIX													RANGE IN AIR MILES		STATUTE		NAUTICAL		R.P.M.		I. A. S.		M.P.		T. A. S.		M.P.		T. A. S.						
XXX													RANGE IN AIR MILES		STATUTE		NAUTICAL		R.P.M.		I. A. S.		M.P.		T. A. S.		M.P.		T. A. S.						
XXXI													RANGE IN AIR MILES		STATUTE		NAUTICAL		R.P.M.		I. A. S.		M.P.		T. A. S.		M.P.		T. A. S.						
XXXII													RANGE IN AIR MILES		STATUTE		NAUTICAL		R.P.M.		I. A. S.		M.P.		T. A. S.		M.P.		T. A. S.						
XXXIII													RANGE IN AIR MILES		STATUTE		NAUTICAL		R.P.M.		I. A. S.		M.P.		T. A. S.		M.P.		T. A. S.						
XXXIV													RANGE IN AIR MILES		STATUTE		NAUTICAL		R.P.M.		I. A. S.		M.P.		T. A. S.		M.P.		T. A. S.						
XXXV													RANGE IN AIR MILES		STATUTE		NAUTICAL		R.P.M.		I. A. S.		M.P.		T. A. S.		M.P.		T. A. S.						
XXXVI													RANGE IN AIR MILES		STATUTE		NAUTICAL		R.P.M.		I. A. S.		M.P.		T. A. S.		M.P.		T. A. S.						
XXXVII													RANGE IN AIR MILES		STATUTE		NAUTICAL		R.P.M.		I. A. S.		M.P.		T. A. S.		M.P.		T. A. S.						
XXXVIII													RANGE IN AIR MILES		STATUTE		NAUTICAL		R.P.M.		I. A. S.		M.P.		T. A. S.		M.P.		T. A. S.						
XXXIX													RANGE IN AIR MILES		STATUTE		NAUTICAL		R.P.M.		I. A. S.		M.P.		T. A. S.		M.P.		T. A. S.						
XL													RANGE IN AIR MILES		STATUTE		NAUTICAL		R.P.M.		I. A. S.		M.P.		T. A. S.		M.P.		T. A. S.						
XLI													RANGE IN AIR MILES		STATUTE		NAUTICAL		R.P.M.		I. A. S.		M.P.		T. A. S.		M.P.		T. A. S.						
XLII													RANGE IN AIR MILES		STATUTE		NAUTICAL		R.P.M.		I. A. S.		M.P.		T. A. S.		M.P.		T. A. S.						
XLIII													RANGE IN AIR MILES		STATUTE		NAUTICAL		R.P.M.		I. A. S.		M.P.		T. A. S.		M.P.		T. A. S.						
XLIV													RANGE IN AIR MILES		STATUTE		NAUTICAL		R.P.M.		I. A. S.		M.P.		T. A. S.		M.P.		T. A. S.						
XLV													RANGE IN AIR MILES		STATUTE		NAUTICAL		R.P.M.		I. A. S.		M.P.		T. A. S.		M.P.		T. A. S.						
XLVI													RANGE IN AIR MILES		STATUTE		NAUTICAL		R.P.M.		I. A. S.		M.P.		T. A. S.		M.P.		T. A. S.						
XLVII													RANGE IN AIR MILES		STATUTE		NAUTICAL		R.P.M.		I. A. S.		M.P.		T. A. S.		M.P.		T. A. S.						
XLVIII													RANGE IN AIR MILES		STATUTE		NAUTICAL		R.P.M.		I. A. S.		M.P.		T. A. S.		M.P.		T. A. S.						
XLIX													RANGE IN AIR MILES		STATUTE		NAUTICAL		R.P.M.		I. A. S.		M.P.		T. A. S.		M.P.		T. A. S.						
L													RANGE IN AIR MILES		STATUTE		NAUTICAL		R.P.M.		I. A. S.		M.P.		T. A. S.		M.P.		T. A. S.						
LI													RANGE IN AIR MILES		STATUTE		NAUTICAL		R.P.M.		I. A. S.		M.P.		T. A. S.		M.P.		T. A. S.						
LII													RANGE IN AIR MILES		STATUTE		NAUTICAL		R.P.M.		I. A. S.		M.P.		T. A. S.		M.P.		T. A. S.						
LIII													RANGE IN AIR MILES		STATUTE		NAUTICAL		R.P.M.		I. A. S.		M.P.		T. A. S.		M.P.		T. A. S.						
LIV													RANGE IN AIR MILES		STATUTE		NAUTICAL		R.P.M.		I. A. S.		M.P.		T. A. S.		M.P.		T. A. S.						
LV													RANGE IN AIR MILES		STATUTE		NAUTICAL		R.P.M.		I. A. S.		M.P.		T. A. S.		M.P.		T. A. S.						
LVI													RANGE IN AIR MILES		STATUTE		NAUTICAL		R.P.M.		I. A. S.		M.P.		T. A. S.		M.P.		T. A. S.						
LVII													RANGE IN AIR MILES		STATUTE		NAUTICAL		R.P.M.		I. A. S.		M.P.		T. A. S.		M.P.		T. A. S.						
LVIII													RANGE IN AIR MILES		STATUTE		NAUTICAL		R.P.M.		I. A. S.		M.P.		T. A. S.		M.P.		T. A. S.						
LVIX													RANGE IN AIR MILES		STATUTE		NAUTICAL		R.P.M.		I. A. S.		M.P.		T. A. S.		M.P.		T. A. S.						
LX													RANGE IN AIR MILES		STATUTE		NAUTICAL		R.P.M.		I. A. S.		M.P.		T. A. S.		M.P.		T. A. S.						
LXI													RANGE IN AIR MILES		STATUTE		NAUTICAL		R.P.M.		I. A. S.		M.P.		T. A. S.		M.P.		T. A. S.						
LXII													RANGE IN AIR MILES		STATUTE		NAUTICAL		R.P.M.		I. A. S.		M.P.		T. A. S.		M.P.		T. A. S.						
LXIII													RANGE IN AIR MILES		STATUTE		NAUTICAL		R.P.M.		I. A. S.		M.P.		T. A. S.		M.P.		T. A. S.						
LXIV													RANGE IN AIR MILES		STATUTE		NAUTICAL		R.P.M.		I. A. S.		M.P.		T. A. S.		M.P.		T. A. S.						
LXV													RANGE IN AIR MILES		STATUTE		NAUTICAL		R.P.M.		I. A. S.		M.P.		T. A. S.		M.P.		T. A. S.						
LXVI													RANGE IN AIR MILES		STATUTE		NAUTICAL		R.P.M.		I. A. S.		M.P.		T. A. S.		M.P.		T. A. S.						
LXVII													RANGE IN AIR MILES		STATUTE		NAUTICAL		R.P.M.		I. A. S.		M.P.		T. A. S.		M.P.		T. A. S.						
LXVIII													RANGE IN AIR MILES		STATUTE		NAUTICAL		R.P.M.		I. A. S.		M.P.		T. A. S.		M.P.		T. A. S.						
LXIX													RANGE IN AIR MILES		STATUTE		NAUTICAL		R.P.M.		I. A. S.		M.P.		T. A. S.		M.P.		T. A. S.						
LXX													RANGE IN AIR MILES		STATUTE		NAUTICAL		R.P.M.		I. A. S.		M.P.</												

Figures 56-64, pages 61-75, deleted in revision, dated 7 May 1947

Appendix I

AN 01-60JE-1

For use with V-1650-3 engine only regardless of airplane model.

AIRCRAFT MODEL(S) P-51D AND P-51K		TAKE-OFF, CLIMB & LANDING CHART												ENGINE MODEL(S) V-1650-3			
GROSS WEIGHT LB.		HARD SURFACE RUNWAY				SOD-TURF RUNWAY				SOFT SURFACE RUNWAY				AT 6000 FEET GROUND RUN TO CLEAR 50' OBJ. TO CLEAR 50' OBJ.			
		AT 3000 FEET		AT 6000 FEET		AT 3000 FEET		AT 6000 FEET		AT SEA LEVEL		AT 3000 FEET				AT 6000 FEET	
		GROUND RUN	TO CLEAR 50' OBJ.	GROUND RUN	TO CLEAR 50' OBJ.	GROUND RUN	TO CLEAR 50' OBJ.	GROUND RUN	TO CLEAR 50' OBJ.	GROUND RUN	TO CLEAR 50' OBJ.	GROUND RUN	TO CLEAR 50' OBJ.			GROUND RUN	TO CLEAR 50' OBJ.
9000	0 17 34 51	1350 1150 800 550	2000 1700 1300 950	2200 1700 1300 950	1500 1150 800 550	2100 1600 1200 850	2250 1600 1200 850	1600 1200 850 600	2100 1600 1200 850	2100 1600 1200 850	2100 1600 1200 850	2100 1600 1200 850	2100 1600 1200 850	2100 1600 1200 850	2100 1600 1200 850	2100 1600 1200 850	
11,000	0 17 34 51	1850 1550 1100 750	2700 2300 1800 1300	2950 2500 2000 1500	1950 1550 1100 750	2800 2400 1900 1400	3000 2600 2100 1600	2100 1700 1300 900	2800 2400 1900 1400	2800 2400 1900 1400	2800 2400 1900 1400	2800 2400 1900 1400	2800 2400 1900 1400	2800 2400 1900 1400	2800 2400 1900 1400	2800 2400 1900 1400	
13,000	0 17 34 51	2300 1900 1400 950	3600 3200 2700 2200	3800 3400 2900 2400	2400 2000 1500 1000	3700 3300 2800 2300	3950 3500 3000 2500	2400 2000 1500 1000	3700 3300 2800 2300	3700 3300 2800 2300	3700 3300 2800 2300	3700 3300 2800 2300	3700 3300 2800 2300	3700 3300 2800 2300	3700 3300 2800 2300	3700 3300 2800 2300	

NOTE: INCREASE CHART DISTANCES AS FOLLOWS: 75% + 10% 100°F + 20%; 125°F + 30%; 150°F + 40%

DATA AS OF: 5-8-45

BASED ON: FLIGHT TESTS

OPTIMUM TAKE-OFF WITH 3000 RPM, 6 IN. INC. & 20 DEG. FLAP IS BOX OF CHART VALUES

For use with V-1650-3 engine only regardless of airplane model.

Figure 64—Take-off, Climb and Landing Chart

CLIMB DATA

GROSS WEIGHT LB.	AT 5000 FEET		AT 10,000 FEET		AT 15,000 FEET		AT 20,000 FEET		AT 25,000 FEET															
	BEST I.A.S.	RATE OF CLIMB	BEST I.A.S.	RATE OF CLIMB	BEST I.A.S.	RATE OF CLIMB	BEST I.A.S.	RATE OF CLIMB	BEST I.A.S.	RATE OF CLIMB														
	M.P.H.	F.P.M.	M.P.H.	F.P.M.	M.P.H.	F.P.M.	M.P.H.	F.P.M.	M.P.H.	F.P.M.														
9000	170	145	2200	15	170	145	2250	5.0	23	170	145	2250	7.5	27	165	145	1900	10.0	31	160	140	1650	13.0	35
11,000	170	145	1500	15	170	145	1500	7.0	26	170	145	1500	10.5	32	165	145	1150	14.0	39	160	140	900	19.0	47
13,000	175	150	1000	15	175	150	950	5.5	23	175	150	850	17.0	42	170	145	550	22.0	55	165	145	300	37.0	75

POWER PLANT SETTINGS: DETAILS ON FIG. SECTION III
DATA AS OF: 5-8-45

BASED ON: FLIGHT TESTS

FUEL USED (U.S. GAL.) INCLUDES WARM-UP & TAKE-OFF ALLOWANCE

LANDING DISTANCE FEET

GROSS WEIGHT LB.	HARD DRY SURFACE				FIRM DRY SOD				WET OR SLIPPERY													
	AT SEA LEVEL		AT 3000 FEET		AT SEA LEVEL		AT 3000 FEET		AT SEA LEVEL		AT 3000 FEET		AT 6000 FEET									
	POWER OFF	POWER ON	POWER OFF	POWER ON	POWER OFF	POWER ON	POWER OFF	POWER ON	POWER OFF	POWER ON	POWER OFF	POWER ON	POWER OFF	POWER ON								
9000	190	115	130	115	1200	2300	1400	2400	1500	2600	1400	2400	1600	2600	1700	2800	3200	4300	3500	4600	3900	5000
8000	190	115	120	115	1100	2100	1300	2200	1400	2400	1300	2200	1400	2400	1500	2600	2900	3800	3100	4100	3400	4500

NOTE: TO DETERMINE FUEL CONSUMPTION IN BRITISH IMPERIAL GALLONS, MULTIPLY BY 10, THEN DIVIDE BY 12

DATA AS OF: 5-8-45

BASED ON: FLIGHT TESTS

LEGEND
I.A.S. : INDICATED AIRSPEED
M.P.H. : MILES PER HOUR
KTS. : KNOTS
F.P.M. : FEET PER MINUTE
OPTIMUM LANDING IS BOX OF CHART VALUES

MIXTURE: USE "RUN" OR "AUTO RICH - AUTO LEAN"

For use with V-1650-3 engine only regardless of airplane model.

FRONTISPIECE

RESTRICTED
AN

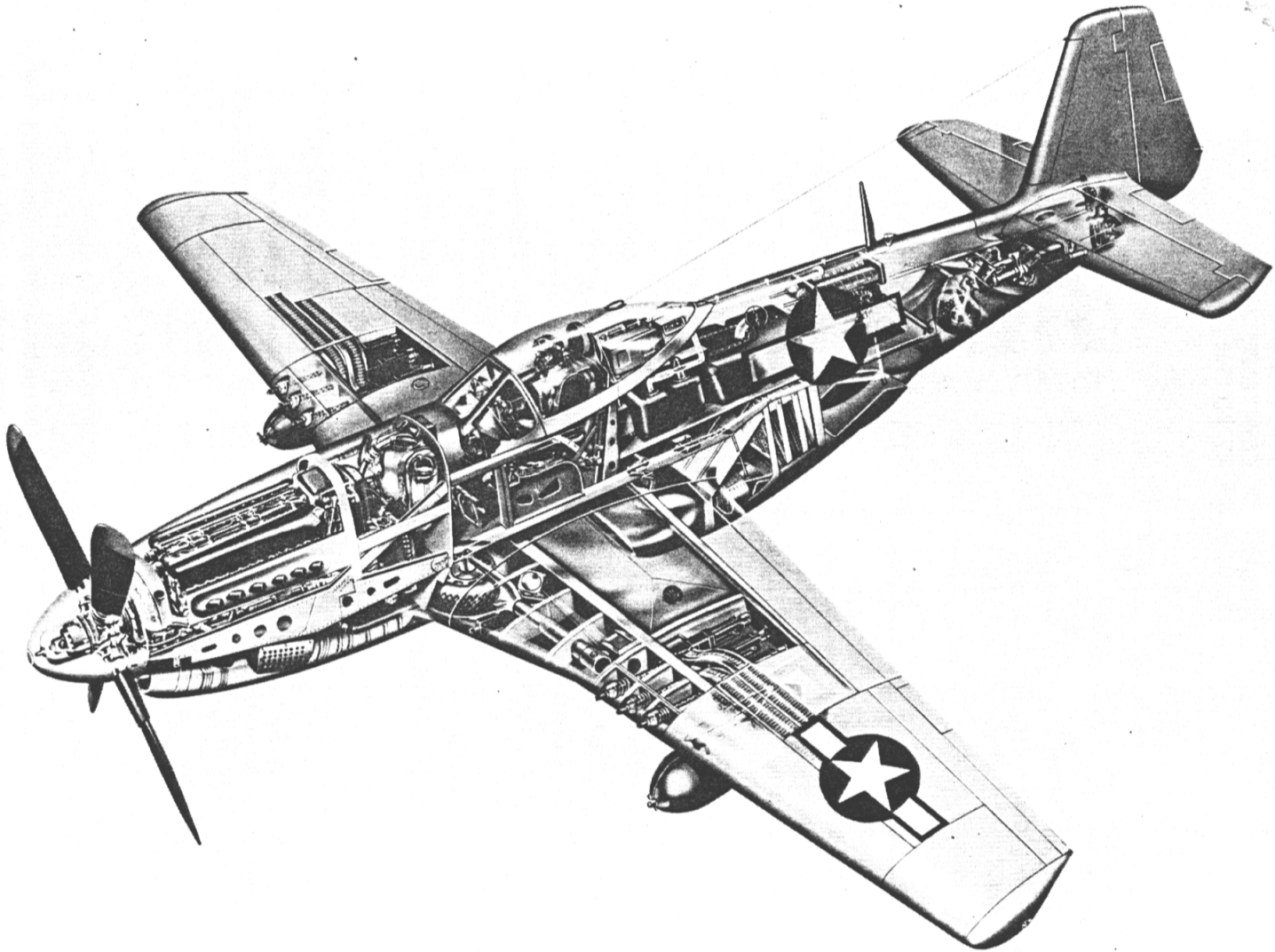

RESTRICTED

SPEC. AN-H-8 DEC. 18, 1942 FORM ASC-512		AIRPLANE MODELS P-51D		SPECIFIC ENGINE FLIGHT CHART				ENGINE MODELS PACKARD V-1650-7					
CONDITION	FUEL PRESSURE (LB/SQ. IN.)	OIL PRESSURE (LB/SQ. IN.)	OIL TEMP.		COOLANT TEMP.		MAX. PERMISSIBLE DIVING RPM: ... 3240						
			°C	°F	°C	°F	CONDITION		ALLOWABLE OIL CONSUMPTION				
DESIRED	12-16	70-80	70-80	158-176	100-110	212-230	MAX. CONT.	... 11 ...	U.S.QT/HR.	IMP.PT/HR		
MAXIMUM	19	90	90	194	121	250	MAX. CRUISE	... 4 ...	U.S.QT/HR.	IMP.PT/HR		
MINIMUM	12	50	15	59	60	140	MIN. SPECIFIC	... 3 ...	U.S.QT/HR.	IMP.PT/HR		
IDLING	9	15					OIL GRADE: (S) ... 1100 ... (W) ... 1100						
SUPERCHARGER TYPE: TWO SPEED, TWO STAGE				FUEL GRADE: SPEC. AN-F-28 GRADE 130				OCTANE 100					
OPERATING CONDITION	RPM	MANIFOLD PRESSURE (BOOST)	HORSE-POWER	CRITICAL ALTITUDE		BLOWER	USE LOW BLOWER BELOW:	MIXTURE CONTROL POSITION	FUEL FLOW (GAL/HR/ENG.)		MAXIMUM CYL. TEMP.		MAXIMUM DURATION (MINUTES)
				WITH RAM	NO RAM				U.S.		°C	°F	
TAKE-OFF	3000	61	1490		S.L.	LOW		A.R.	161				5
WAR EMERGENCY	3000	67	1720 1505		6,200 19,300	LOW HIGH		A.R.	194				5
								A.R.	187				
MILITARY	3000	61	1590 1370		8,500 21,400	LOW HIGH		A.R.	178				15
								A.R.	170				
MAXIMUM CONTINUOUS	2700	46	1180 1065		11,300 23,400	LOW HIGH		A.R.	109				CONT.
								A.R.	106				
MAXIMUM CRUISE	2400	36	820 780		14,000 23,700	LOW HIGH		A.L.	86				CONT.
								A.L.	64				
MINIMUM SPECIFIC CONSUMPTION													
REMARKS: ADDITIONAL INFORMATION WILL BE INCORPORATED IN THIS CHART WHEN AVAILABLE.													

Figure 28—Specific Engine Flight Chart—V-1650-7

SPEC. AN-H-8 DEC. 18, 1942 FORM ASC-512	AIRPLANE MODELS P-51D	SPECIFIC ENGINE FLIGHT CHART	ENGINE MODELS PACKARD V-1650-3									
CONDITION	FUEL PRESSURE (LB./SQ. IN.)	OIL PRESSURE (LB./SQ. IN.)	OIL TEMP.	COOLANT TEMP.	MAX. PERMISSIBLE DIVING RPM: 3240							
			°C °F	°C °F	CONDITION	ALLOWABLE OIL CONSUMPTION						
DESIRED	12-16	70-80	70-80	158-176	100-110	212-230	MAX. CONT.	... 1.1 ... U.S.QT/HR IMP.PT/HR				
MAXIMUM	19	90	90	194	121	250	MAX. CRUISE	... 4. ... U.S.QT/HR IMP.PT/HR				
MINIMUM	12	50	15	59	60	140	MIN. SPECIFIC	... 3 ... U.S.QT/HR IMP.PT/HR				
IDLING	9	15					OIL GRADE: (S) 1100 (W) 1100					
SUPERCHARGER TYPE: TWO SPEED, TWO STAGE				FUEL GRADE: SPEC. AN-F-28 GRADE 130			OCTANE 100					
OPERATING CONDITION	RPM	MANIFOLD PRESSURE (BOOST)	HORSE-POWER	CRITICAL ALTITUDE		BLOWER	USE LOW BLOWER BELOW:	MIXTURE CONTROL POSITION	FUEL FLOW (GAL/HR/ENG.)	MAXIMUM CYL. TEMP.		MAXIMUM DURATION (MINUTES)
				WITH RAM	NO RAM				U.S.	°C	°F	
TAKE-OFF	3000	61	1400	S.L.	S.L.	LOW		AR	150			5
WAR EMERGENCY	3000	67	1595 1295	17,000 28,800	11,700 23,200	LOW HIGH		AR AR	166 160			5
MILITARY	3000	61	1450 1190	19,800 31,200	13,700 25,600	LOW HIGH		AR AR	158 144			15
MAXIMUM CONTINUOUS	2700	46	1120 940	20,500 34,400	17,500 29,500	LOW HIGH		AR AR	111 106			CONT.
MAXIMUM CRUISE	2400 2400	36 36	800 700	21,500 32,300	18,500 30,500	LOW HIGH		AL AL	74 70			CONT.
MINIMUM SPECIFIC CONSUMPTION	1600 1600 1600 1800 2000	27 30 31 F.T. F.T.	370 440 480 510 560	S.L. 5,000 10,000 15,000 20,000		LOW LOW LOW LOW LOW		AL AL AL AL AL	35 39 42 45 50			CONT.
REMARKS: DATA FOR MINIMUM SPECIFIC CONSUMPTION ARE FOR AVERAGE MAXIMUM RANGE CONDITIONS												

Figure 29—Specific Engine Flight Chart—V-1650-3

RESTRICTED

RESTRICTED
AN 01-60JE-1

FLIGHT OPERATING DATA
Sec III, Part 2

AIRPLANE MODELS		TAKE-OFF, CLIMB & LANDING CHART												ENGINE MODELS					
P-51D		TAKE-OFF DISTANCE (IN FEET)												V-1650-7					
GROSS WEIGHT (IN LBS.)	HEAD WIND (MPH)	HARD SURFACE RUNWAY						SOD-TURF RUNWAY						SOFT SURFACE RUNWAY					
		AT SEA LEVEL		AT 3,000 FT.		AT 6,000 FT.		AT SEA LEVEL		AT 3,000 FT.		AT 6,000 FT.		AT SEA LEVEL		AT 3,000 FT.		AT 6,000 FT.	
		GROUND RUN	TO CLEAR 50' OBJ.	GROUND RUN	TO CLEAR 50' OBJ.	GROUND RUN	TO CLEAR 50' OBJ.	GROUND RUN	TO CLEAR 50' OBJ.	GROUND RUN	TO CLEAR 50' OBJ.	GROUND RUN	TO CLEAR 50' OBJ.	GROUND RUN	TO CLEAR 50' OBJ.	GROUND RUN	TO CLEAR 50' OBJ.	GROUND RUN	TO CLEAR 50' OBJ.
9000	0	1400	2000	1500	2200	1700	2500	1400	2100	1600	2300	1800	2500	1600	2300	1800	2500	2000	2800
	17	1000	1600	1200	1700	1300	2000	1100	1600	1200	1800	1400	2000	1200	1800	1300	1900	1500	2200
	34	700	1200	800	1300	1000	1500	800	1200	900	1400	1000	1500	900	1300	900	1400	1100	1700
	51	500	800	600	1000	700	1100	500	900	600	1000	700	1100	600	900	600	1000	800	1200
10,000	0	1800	2400	1800	2500	2000	2800	1700	2400	1800	2500	2100	3000	1900	2700	2100	2900	2400	3200
	17	1200	1800	1300	2000	1500	2300	1300	1900	1400	2100	1600	2400	1400	2100	1600	2300	1800	2500
	34	900	1400	1000	1500	1100	1800	900	1400	1000	1600	1200	1800	1000	1600	1200	1700	1300	2000
	51	600	1000	700	1100	800	1300	600	1000	700	1200	800	1300	700	1100	800	1200	900	1500
11,000	0	1800	2700	2000	3000	2300	3300	2000	2800	2100	3100	2400	3400	2300	3200	2500	3400	2800	3900
	17	1400	2100	1500	2300	1800	2600	1500	2200	1600	2400	1900	2700	1700	2500	1900	2700	2200	3100
	34	1000	1600	1100	1800	1300	2100	1100	1700	1200	1900	1400	2100	1200	1900	1400	2100	1600	2400
	51	700	1200	800	1300	900	1500	700	1200	800	1400	1000	1800	800	1300	1000	1500	1200	1700

NOTE: INCREASE DISTANCE 5 % FOR EACH 10°C ABOVE 0°C (5 % FOR EACH 20°F ABOVE 32°F) ENGINE LIMITS FOR TAKE-OFF 3000 RPM & 61 IN. HG

COMBAT MISSIONS USE				CLIMB DATA				FERRY MISSIONS USE			
2700				15,000				2400			
RPM & 46 IN. HG				FT. ALT.				RPM & 36 IN. HG			
TYPE OF CLIMB	S.L. TO 5000		10,000		15,000		20,000		25,000		SLOWER CHANGE
	BEST I.A.S. MPH	TIME FROM S.L. FT./MIN	BEST I.A.S. MPH	TIME FROM S.L. FT./MIN	BEST I.A.S. MPH	TIME FROM S.L. FT./MIN	BEST I.A.S. MPH	TIME FROM S.L. FT./MIN	BEST I.A.S. MPH	TIME FROM S.L. FT./MIN	
11,000 COMBAT	165	1600 3.3	165	1630 6.5	165	1270 9.5	160	1150 13.5	155	950 18.5	AUTO.
	165	730 8.8	165	780 13.6	165	730 20.5	165	450 28.0	160	200 43.0	AUTO.
10,000 COMBAT	165	1980 2.8	165	2030 5.2	165	1650 7.8	160	1580 10.6	155	1350 14.0	AUTO.
	165	1080 4.8	165	1090 9.5	165	1050 14.5	165	750 20.0	160	530 28.0	AUTO.
9000 COMBAT	165	2350 2.1	165	2480 4.2	165	2000 6.4	160	1950 8.8	155	1750 11.5	AUTO.
	165	1300 3.0	165	1400 7.5	165	1350 11.0	165	1050 14.0	160	850 21.0	AUTO.

NOTE: INCREASED ELAPSED CLIMBING TIME 5 % FOR EACH 10°C ABOVE 0°C FREE AIR TEMPERATURE (5 % FOR EACH 20°F ABOVE 32°F) FUEL INCLUDES WARM-UP AND TAKE-OFF ALLOWANCE

GROSS WEIGHT IN LBS.		LANDING DISTANCE (IN FEET)																	
BEST I.A.S. APPROACH MPH	S.L. APPROACH	HARD DRY SURFACE				FIRM DRY SOD				WET OR SLIPPERY									
		AT SEA LEVEL		AT 3,000 FT.		AT SEA LEVEL		AT 3,000 FT.		AT SEA LEVEL		AT 3,000 FT.							
		TO CLEAR 50' OBJ.	GROUND ROLL	TO CLEAR 50' OBJ.	GROUND ROLL	TO CLEAR 50' OBJ.	GROUND ROLL	TO CLEAR 50' OBJ.	GROUND ROLL	TO CLEAR 50' OBJ.	GROUND ROLL	TO CLEAR 50' OBJ.	GROUND ROLL						
8000	110	2100	1100	2200	1200	2400	1400	2200	1300	2400	1400	2800	1500	3800	2900	4100	3100	4500	3400
9000	115	2300	1200	2400	1400	2600	1500	2400	1400	2600	1600	2800	1700	3800	3200	4800	3500	5000	3900

NOTE: FOR GROUND TEMPERATURES ABOVE 35°C (95°F) INCREASE APPROACH I.A.S. 10% AND ALLOW 20% INCREASE IN GROUND ROLL.

REMARKS 9000 POUNDS IS WITH NO EXTERNAL LOAD
10,000 AND 11,000 POUNDS ARE WITH BOMBS OR EXTERNAL TANKS.

I.A.S.: Indicated Air Speed
L: Miles Per Hour
M.P.H.: Miles Per Hour
S.L.: Sea Level
U.S.: U. S. Gallons
IMP.: Imperial Gallons
NOTE: All Distances are Average
RED FIGURES HAVE NOT BEEN FLIGHT CHECKED

Figure 43—Take-off, Climb, and Landing Chart

RESTRICTED

RESTRICTED
AN 01-60JF-1

FLIGHT OPERATING CHARTS
Appendix II

MODEL(S) P-51D		FLIGHT OPERATION INSTRUCTION CHART										EXTERNAL LOAD ITEMS																				
ENGINE(S): V-1650-7		CHART WEIGHT LIMITS: 9600 TO 8000 POUNDS										WING BOMB RACKS																				
LIMITS		R. P. M.	M. P. (IN. HG.)	BLOWER POSITION	MIXTURE POSITION	TIME LIMIT	TOTAL G. P. H.	INSTRUCTIONS FOR USING CHART: Select figure in FUEL column equal to or less than amount of fuel to be used for cruising. Move horizontally to left or right and select RANGE value equal to or greater than the statute or nautical air miles to be flown. Vertically below and opposite desired cruising altitude (ALT.) read optimum R. P. M., I. A. S. and MIXTURE setting required.										NOTES: Column I is for emergency high speed cruising only. Columns II, III, IV and V give progressive increase in range at a sacrifice in speed. Manifold pressure (M. P.), gallons per hour (G. P. H.) and true airspeed (T. A. S.) are approximate values for reference. For efficiency maintain indicated airspeed (I. A. S.) hourly. Adjust RPM slightly if necessary to avoid exceeding manifold pressure more than 3 in. Hg.														
WAR MAX.	3000	67	LOW	AR	5	194																										
MILITARY POWER	3000	61	HIGH	AR	15	178																										
NORMAL RATED	2700	46	LOW	AR	CONT.	109																										
			HIGH			106																										
I		FUEL		II				III				IV				FUEL		V														
RANGE IN AIR MILES		U. S. GAL.		RANGE IN AIR MILES				RANGE IN AIR MILES				RANGE IN AIR MILES				U. S. GAL.		RANGE IN AIR MILES														
STATUTE NAUTICAL				STATUTE NAUTICAL		STATUTE NAUTICAL		STATUTE NAUTICAL		STATUTE NAUTICAL		STATUTE NAUTICAL				STATUTE NAUTICAL		STATUTE NAUTICAL														
680		590		289		29		GAL. ALLOWANCE NOT AVAILABLE IN FLIGHT				1120		269		1270		1100														
590		510		240		720		620		830		720		240		1110		960														
510		440		210		720		620		830		720		210		1110		960														
420		370		180		610		530		710		610		180		950		830														
340		290		150		510		440		590		510		150		790		680														
250		220		120		410		350		470		410		120		640		550														
170		140		90		300		260		350		310		90		480		420														
80		70		60		200		170		230		200		60		320		280														
				30		100		90		110		100		30		160		140														
MAXIMUM CONTINUOUS						OPERATING DATA						OPERATING DATA						MAXIMUM RANGE														
R. P. M.	I. A. S. M.P.H.	MIX-TURE	M. P. In. Hg.	G. P. H.	T. A. S.	ALT. Feet	R. P. M.	I. A. S. M.P.H.	MIX-TURE	M. P. In. Hg.	G. P. H.	T. A. S.	ALT. Feet	R. P. M.	I. A. S. M.P.H.	MIX-TURE	M. P. In. Hg.	G. P. H.	T. A. S.	ALT. Feet	R. P. M.	I. A. S. M.P.H.	MIX-TURE	M. P. In. Hg.	G. P. H.	T. A. S.	ALT. Feet					
2700	230	AR	FT	80	400	40000																										
2700	265	AR	FT	105	420	35000								2600	255	AR	FT	90	410	2500	245	AR	FT	75	390	30000	2550	205	AR	FT	62	360
2700	280	AR	46	115	410	25000								2400	260	AR	FT	87	380	2400	245	AL	36	70	360	25000	2100	205	AL	FT	52	305
2700	290	AR	FT	100	390	20000								2600	270	AR	FT	84	370	2350	245	AL	FT	64	335	20000	2050	205	AL	FT	48	280
2700	305	AR	46	113	385	15000	2550	290	AR	FT	97	365	2400	270	AR	39	78	340	2150	250	AL	FT	61	315	15000	1800	205	AL	FT	44	260	
2700	305	AR	46	108	355	10000	2500	285	AR	43	88	335	2400	270	AR	38	73	315	2150	250	AL	36	57	295	10000	1650	210	AL	FT	42	245	
2700	305	AR	46	103	330	5000	2500	285	AR	43	82	310	2400	270	AR	38	66	290	2150	250	AL	36	54	275	5000	1600	210	AL	33	39	230	
2700	305	AR	46	98	310	S. L.	2550	285	AR	43	77	290	2400	270	AR	38	63	270	2150	250	AL	36	48	250	S. L.	1600	200	AL	31	34	200	

NOTES
 1. ALLOW 29 GAL. FOR WARM-UP, TAKE-OFF & INITIAL CLIMB PLUS ALLOWANCE FOR WIND, RESERVE & COMBAT AS REQ'D.
 2. IF 85 GALLON FUSELAGE TANK IS INSTALLED AND SERVICED, WARM-UP, TAKE-OFF, CLIMB, AND CRUISE ON FUSELAGE TANK UNTIL AT LEAST 50 GALLONS ARE USED BEFORE SWITCHING TO WING TANKS.
 HIGH BLOWER ABOVE HEAVY LINE ONLY.

EXAMPLE
 AT 9400 LBS. GROSS WT. WITH 240 GAL. OF FUEL (AFTER DEDUCTING TOTAL ALLOWANCES OF 29 GAL.) TO FLY 1000 STAT. AIRMILES AT 20,000 FT. ALT. MAINTAIN 2350 RPM AND 245 MPH IND. AIRSPEED WITH MIXTURE SET AUTO LEAN

LEGEND
 I. A. S.: INDICATED AIRSPEED
 M. P.: MANIFOLD PRESSURE
 G. P. H.: U. S. GAL. PER HOUR
 T. A. S.: TRUE AIRSPEED
 S. L.: SEA LEVEL
 F. T.: FULL THROTTLE
 F. R.: FULL RICH
 A. L.: AUTO-LEAN
 A. L.: AUTO-LEAN
 C. L.: CRUISING LEAN

RED FIGURES ARE PRELIMINARY.
 SUBJECT TO REVISION AFTER FLIGHT CHECK

Figure 44—Flight Operation Instruction Chart—V-1650-7 Engine
 (Wing Bomb Racks—9600 to 8000 lbs.)

MODEL(S) P-51D		FLIGHT OPERATION INSTRUCTION CHART										EXTERNAL LOAD ITEMS 2 - 300-LB. WING BOMBS (OR SMALLER SIZE)																				
ENGINE(S): V-1650-7		CHART WEIGHT LIMITS: 10,000 TO 9500 POUNDS																														
LIMITS		R. P. M.	M. P. (IN. HG.)	BLOWER POSITION	MIXTURE POSITION	TIME LIMIT	TOTAL G. P. H.	INSTRUCTIONS FOR USING CHART: Select figure in FUEL column equal to or less than amount of fuel to be used for cruising. Move horizontally to the left or right and select RANGE value equal to or greater than the statute or nautical air miles to be flown. Vertically below and opposite desired cruising altitude (ALT.) read optimum R. P. M., I. A. S. and MIXTURE setting required.					NOTES: Column I is for emergency high speed cruising only. Columns II, III, IV and V give progressive increase in range at a sacrifice in speed. Manifold pressure (M. P.), gallons per hour (G. P. H.) and true airspeed (T. A. S.) are approximate values for reference. For efficiency maintain indicated airspeed (I. A. S.) hourly. Adjust RPM slightly if necessary to avoid exceeding manifold pressure more than 3 in. Hg.																			
WAR MAX.	3000	67	LOW	AR	5	194																										
MILITARY POWER	3000	61	LOW HIGH	AR	15	178																										
NORMAL RATED	2700	46	LOW HIGH	AR	CONT.	109 106																										
I		FUEL		II		III		IV		FUEL		V																				
RANGE IN AIR MILES		U. S. GAL.		RANGE IN AIR MILES		RANGE IN AIR MILES		RANGE IN AIR MILES		U. S. GAL.		RANGE IN AIR MILES																				
STATUTE	NAUTICAL			STATUTE	NAUTICAL	STATUTE	NAUTICAL	STATUTE	NAUTICAL			STATUTE	NAUTICAL																			
I 29 GAL. ALLOWANCE NOT AVAILABLE IN FLIGHT																																
650	560	269		790	680	910	790	1070	930	269		1240	1080																			
		240								240																						
590	510	220		720	620	840	730	990	850	220		1140	990																			
540	470	200		650	570	760	660	890	770	200		1030	900																			
480	420	180		590	510	680	590	800	690	180		930	810																			
430	370	160		520	450	610	530	710	620	160		830	720																			
380	330	140		460	400	530	460	620	540	140		730	630																			
MAXIMUM CONTINUOUS						OPERATING DATA						OPERATING DATA																				
R. P. M.	I. A. S. M.P.H.	MIX-TURE	M. P. In. Hg.	G. P. H.	T. A. S.	ALT. Feet	R. P. M.	I. A. S. M.P.H.	MIX-TURE	M. P. In. Hg.	G. P. H.	T. A. S.	ALT. Feet	R. P. M.	I. A. S. M.P.H.	MIX-TURE	M. P. In. Hg.	G. P. H.	T. A. S.	ALT. Feet	R. P. M.	I. A. S. M.P.H.	MIX-TURE	M. P. In. Hg.	G. P. H.	T. A. S.						
						40000															40000											
						35000															35000											
						30000															30000											
2700	270	AR	46	115	395	25000								2450	255	AR	41	86	375	2400	235	AR	37	71	350	25000	2100	200	AL	FT	53	295
2700	275	AR	FT	100	375	20000								2550	260	AR	FT	83	355	2400	240	AL	FT	67	330	20000	2050	200	AL	FT	48	275
2700	290	AR	46	113	365	15000	2550	280	AR	FT	96	350	2400	260	AR	39	78	330	2200	245	AL	FT	63	310	15000	1800	200	AL	FT	45	255	
2700	290	AR	46	108	340	10000	2550	280	AR	43	89	325	2400	260	AR	38	72	305	2200	250	AL	FT	36	59	290	10000	1650	205	AL	FT	42	240
2700	290	AR	46	103	315	5000	2550	275	AR	43	82	300	2400	260	AR	38	67	280	2250	250	AL	FT	36	55	270	5000	1600	205	AL	FT	33	225
2700	290	AR	46	98	295	S. L.	2500	275	AR	42	75	275	2400	260	AR	38	63	260	2300	250	AL	FT	36	51	250	S. L.	1600	210	AL	FT	33	210

- NOTES
- ① ALLOW 29 GAL. FOR WARM-UP, TAKE-OFF & INITIAL CLIMB PLUS ALLOWANCE FOR WIND, RESERVE & COMBAT AS REQ'D.
2. IF 85-GALLON FUSELAGE TANK IS INSTALLED, WARM-UP, TAKE-OFF, CLIMB, AND CRUISE ON FUSELAGE TANK UNTIL AT LEAST 50 GALLONS ARE USED BEFORE SWITCHING TO WING TANKS.
- HIGH BLOWER ABOVE HEAVY LINE ONLY.

EXAMPLE

AT 9800 LB. GROSS WT. WITH 240 GAL. OF FUEL (AFTER DEDUCTING TOTAL ALLOWANCES OF 29 GAL.) TO FLY 1000 STAT. AIRMILES AT 10,000 FT. ALT. MAINTAIN 2200 RPM AND 250 MPH IND. AIRSPEED WITH MIXTURE SET AUTO LEAN.

LEGEND

I. A. S.: INDICATED AIRSPEED
M. P.: MANIFOLD PRESSURE
G. P. H.: U. S. GAL. PER HOUR
T. A. S.: TRUE AIRSPEED
S. L.: SEA LEVEL

F. T.: FULL THROTTLE
F. R.: FULL RICH
A. R.: AUTO-RICH
A. L.: AUTO-LEAN
C. L.: CRUISING LEAN

RED FIGURES ARE PRELIMINARY,
SUBJECT TO REVISION AFTER FLIGHT CHECK

Figure 45—Flight Operation Instruction Chart—V-1650-7, Engine
(Two 300-lb. Wing Bombs—10,000 to 9500 lbs.)

RESTRICTED

RESTRICTED
AN 01-60JE-1

FLIGHT OPERATING CHARTS
Appendix II

MODEL(S) P-51D		FLIGHT OPERATION INSTRUCTION CHART										EXTERNAL LOAD ITEMS							
ENGINE(S): V-1650-7		CHART WEIGHT LIMITS: 9500 TO 8000 POUNDS										2 - 300-LB. WING BOMBS (OR SMALLER SIZE)							
LIMITS	R. P. M.	M. P. (IN. HG.)	BLOWER POSITION	MIXTURE POSITION	TIME LIMIT	TOTAL G. P. H.	INSTRUCTIONS FOR USING CHART: Select figure in FUEL column equal to or less than amount of fuel to be used for cruising. Move horizontally to left or right and select RANGE value equal to or greater than the statute or nautical air miles to be flown. Vertically below and opposite desired cruising altitude (ALT.) read optimum R. P. M., I. A. S. and MIXTURE setting required.					NOTES: Column I is for emergency high speed cruising only. Columns II, III, IV and V give progressive increase in range at a sacrifice in speed. Manifold pressure (M. P.), gallons per hour (G. P. H.) and true airspeed (T. A. S.) are approximate values for reference. For efficiency maintain indicated airspeed (I. A. S.) hourly. Adjust RPM slightly if necessary to avoid exceeding manifold pressure more than 3 in. Hg.							
WAR MAX.	3000	67	LOW HIGH	AR	5	194 187													
MILITARY POWER	3000	61	LOW HIGH	AR	15	178 170													
NORMAL RATED	2700	46	LOW HIGH	AR	CONT.	109 106													
I		FUEL	II		III		IV		FUEL	V									
RANGE IN AIR MILES		U. S. GAL.	RANGE IN AIR MILES		RANGE IN AIR MILES		RANGE IN AIR MILES		U. S. GAL.	RANGE IN AIR MILES									
STATUTE	NAUTICAL		STATUTE	NAUTICAL	STATUTE	NAUTICAL	STATUTE	NAUTICAL		STATUTE	NAUTICAL								
430	370	184	GAL. ALLOWANCE NOT AVAILABLE IN FLIGHT				720	620	184	850	740								
380	330	160	500	430	600	520	630	160	740	650									
		140	440	380	530	460		140											
320	280	120	380	330	450	390	540	120	640	550									
270	230	100	310	270	380	330	450	100	530	460									
210	180	80	250	220	300	260	360	80	430	370									
160	140	60	190	160	220	190	270	60	320	280									
110	90	40	120	110	150	130	180	40	220	190									
50	40	20	60	50	70	60	90	20	110	100									
MAXIMUM CONTINUOUS			OPERATING DATA			OPERATING DATA			OPERATING DATA			MAXIMUM RANGE							
R. P. M.	I. A. S. M.P.H.	MIX- TURE	M. P. In. Hg.	G. P. H.	T. A. S. K.	R. P. M.	I. A. S. M.P.H.	MIX- TURE	M. P. In. Hg.	G. P. H.	T. A. S. K.	ALT. Feet	R. P. M.	I. A. S. M.P.H.	MIX- TURE	M. P. In. Hg.	G. P. H.	T. A. S. K.	
												40000							
												35000							
												30000							
2700	270	AR	46	115	395	25000							2450	255	AR	41	89	375	
													2400	240	AR	37	71	355	
													25000						
													2100	205	AL	FT	52	305	
2700	275	AR	46	100	375	20000							2550	260	AR	41	84	355	
2700	290	AR	46	113	365	15000	2550	280	AR	43	93	325	2400	260	AR	39	79	330	
													2400	240	AL	FT	66	330	
													2400	245	AL	FT	62	310	
													2400	260	AR	38	73	305	
2700	290	AR	46	108	340	10000	2550	280	AR	43	86	300	2400	260	AR	38	67	280	
2700	290	AR	46	103	315	5000	2550	280	AR	43	80	280	2400	260	AR	38	62	260	
2700	290	AR	46	98	295	S. L.	2550	280	AR	43	80	280	2400	260	AR	38	62	260	
													2250	250	AL	FT	66	330	
													2200	245	AL	FT	62	310	
													2250	250	AL	FT	58	290	
													2250	250	AL	FT	54	270	
													2250	250	AL	FT	50	250	
													S. L.	1600	210	AL	FT	52	305
													S. L.	1600	210	AL	FT	49	285
													S. L.	1600	210	AL	FT	45	260
													S. L.	1600	210	AL	FT	42	245
													S. L.	1600	210	AL	FT	33	40
													S. L.	1600	210	AL	FT	32	37

Figure 46—Flight Operation Instruction Chart—V-1650-7 Engine
(Two 300-lb. Wing Bombs—9500 to 8000 lbs.)

RESTRICTED

NOTES
 1 ALLOW 24 GAL. FOR W. R.M.I.P. TAKE-OFF & INITIAL CLIMB PLUS ALLOWANCE FOR WIND, RESERVE & COMBAT AS REQ'D.
 HIGH BLOWER ABOVE HEAVY LINE ONLY.

EXAMPLE
 AT 9300 LB GROSS WT. WITH 160 GAL OF FUEL (AFTER DEDUCTING TOTAL ALLOWANCES OF 24 GAL.) TO FLY 550 STAT. AIRMILES AT 10,000 FT. ALT MAINTAIN 2250 RPM AND 250 MPH IND AIRSPEED WITH MIXTURE SET AUTO LEAN

LEGEND
 I. A. S.: INDICATED AIRSPEED
 M. P.: MANIFOLD PRESSURE
 G. P. H.: U. S. GAL. PER HOUR
 T. A. S.: TRUE AIRSPEED
 S. L.: SEA LEVEL
 F. T.: FULL THROTTLE
 F. R.: FULL RICH
 A. R.: AUTO-RICH
 A. L.: AUTO-LEAN
 C. L.: CRUISING LEAN
 RED FIGURES ARE PRELIMINARY.
 SUBJECT TO REVISION AFTER FLIGHT CHECK

MODEL(S) P-51D		FLIGHT OPERATION INSTRUCTION CHART										EXTERNAL LOAD ITEMS 2 - 500-LB. WING BOMBS																				
ENGINE(S): V-1650-7		CHART WEIGHT LIMITS: 10,500 TO 10,000 POUNDS																														
LIMITS	R. P. M.	M. P. (IN. HG.)	BLOWER POSITION	MIXTURE POSITION	TIME LIMIT	TOTAL G. P. H.	INSTRUCTIONS FOR USING CHART: Select figure in FUEL column equal to or less than amount of fuel to be used for cruising. Move horizontally to left or right and select RANGE value equal to or greater than the statute or nautical air miles to be flown. Vertically below and opposite desired cruising altitude (ALT.) read optimum R. P. M., I. A. S. and MIXTURE setting required.					NOTES: Column I is for emergency high speed cruising only. Columns II, III, IV and V give progressive increase in range at a sacrifice in speed. Manifold pressure (M. P.), gallons per hour (G. P. H.) and true airspeed (T. A. S.) are approximate values for reference. For efficiency maintain indicated airspeed (I. A. S.) hourly. Adjust RPM slightly if necessary to avoid exceeding manifold pressure more than 3 in. Hg.																				
WAR. MAX.	3000	67	LOW HIGH	AR	5	194 187																										
MILITARY POWER	3000	61	LOW HIGH	AR	15	178 170																										
NORMAL RATED	2700	46	LOW HIGH	AR	CONT.	109 106																										
I		FUEL	II		III		IV		FUEL	V																						
RANGE IN AIR MILES		U. S. GAL.	RANGE IN AIR MILES		RANGE IN AIR MILES		RANGE IN AIR MILES		U. S. GAL.	RANGE IN AIR MILES																						
STATUTE	NAUTICAL		STATUTE	NAUTICAL	STATUTE	NAUTICAL	STATUTE	NAUTICAL		STATUTE	NAUTICAL																					
630	540	269 240	29 GAL. ALLOWANCE NOT AVAILABLE IN FLIGHT				870	760	1020	890	269 240	1180	1020																			
570	500	220	700	610	800	690	940	810	220	1080	940																					
520	450	200	640	550	730	630	850	740	200	980	850																					
470	410	180	570	500	650	570	770	680	180	880	770																					
420	360	160	510	440	580	500	680	590	160	790	680																					
370	320	140	440	390	510	440	600	520	140	690	600																					
MAXIMUM CONTINUOUS						OPERATING DATA						OPERATING DATA						OPERATING DATA						MAXIMUM RANGE								
R. P. M.	I. A. S. M.P.H.	MIXTURE	M. P. In. Hg.	G. P. H.	T. A. S.	ALT. Feet	R. P. M.	I. A. S. M.P.H.	MIXTURE	M. P. In. Hg.	G. P. H.	T. A. S.	ALT. Feet	R. P. M.	I. A. S. M.P.H.	MIXTURE	M. P. In. Hg.	G. P. H.	T. A. S.	ALT. Feet	R. P. M.	I. A. S. M.P.H.	MIXTURE	M. P. In. Hg.	G. P. H.	T. A. S.						
						40000 35000 30000																										
2700	260	AR	46	115	385	25000								2500	245	AR	41	91	365	2400	235	AR	38	73	345	25000	2150	200	AL	FT	55	295
2700	265	AR	FT	100	360	20000								2600	255	AR	FT	87	350	2450	240	AR	FT	69	325	20000	2100	200	AL	FT	51	275
2700	280	AR	46	113	355	15000	2550	270	AR	FT	95	340	2400	255	AR	FT	80	325	2250	240	AL	36	65	305	15000	1900	205	AL	FT	48	260	
2700	280	AR	46	108	330	10000	2500	270	AR	42	89	315	2400	255	AR	39	73	300	2300	245	AL	36	61	285	10000	1650	210	AL	FT	46	245	
2700	280	AR	46	103	305	5000	2500	270	AR	42	82	290	2400	255	AR	38	67	275	2350	245	AL	36	56	265	5000	1600	210	AL	36	43	230	
2700	280	AR	46	98	285	S. L.	2500	270	AR	42	76	270	2400	255	AR	38	63	255	2350	245	AL	36	52	245	S. L.	1600	210	AL	34	41	210	

NOTES
 ① ALLOW 29 GAL. FOR WARM-UP, TAKE-OFF & INITIAL CLIMB PLUS ALLOWANCE FOR WIND, RESERVE & COMBAT AS REQ'D.
 2. IF 85-GALLON FUSELAGE TANK IS INSTALLED AND SERVICED, WARM-UP, TAKE-OFF, CLIMB, AND CRUISE ON FUSELAGE TANK UNTIL AT LEAST 50 GALLONS ARE USED BEFORE SWITCHING TO WING TANKS.
 HIGH BLOWER ABOVE HEAVY LINE ONLY.

EXAMPLE
 AT 10,300 LB. GROSS WT. WITH 240 GAL. OF FUEL (AFTER DEDUCTING TOTAL ALLOWANCES OF 29 GAL.) TO FLY 950 STAT. AIRMILES AT 10,000 FT. ALT. MAINTAIN 2300 RPM AND 245 MPH IND. AIRSPEED WITH MIXTURE SET AUTO LEAN.

LEGEND
 I. A. S.: INDICATED AIRSPEED
 M. P.: MANIFOLD PRESSURE
 G. P. H.: U. S. GAL. PER HOUR
 T. A. S.: TRUE AIRSPEED
 S. L.: SEA LEVEL
 F. T.: FULL THROTTLE
 P. R.: FULL RICH
 A. R.: AUTO-RICH
 A. L.: AUTO-LEAN
 C. L.: CRUISING LEAN
 RED FIGURES ARE PRELIMINARY. SUBJECT TO REVISION AFTER FLIGHT CHECK

Figure 47—Flight Operation Instruction Chart—V-1650-7 Engine (Two 500-lb. Wing Bombs—10,500 to 10,000 lbs.)

RESTRICTED

RESTRICTED
AN 01-601E-1

FLIGHT OPERATING CHARTS
Appendix II

MODEL(S) P-51D		FLIGHT OPERATION INSTRUCTION CHART										EXTERNAL LOAD ITEMS 2 - 500-LB. WING BOMBS																						
ENGINE(S): V-1650-7		CHART WEIGHT LIMITS: 10,000 TO 8500 POUNDS																																
LIMITS	R. P. M.	M. P. (IN. HG.)	BLOWER POSITION	MIXTURE POSITION	TIME LIMIT	TOTAL C. P. H.	INSTRUCTIONS FOR USING CHART: Select figure in FUEL column equal to or less than amount of fuel to be used for cruising. Move horizontally to left or right and select RANGE value equal to or greater than the statute or nautical air miles to be flown. Vertically below and opposite desired cruising altitude (ALT.) read optimum R. P. M., I. A. S. and MIXTURE setting required.					NOTES: Column I is for emergency high speed cruising only. Columns II, III, IV and V give progressive increase in range at a sacrifice in speed. Manifold pressure (M. P.), gallons per hour (G. P. H.) and true airspeed (T. A. S.) are approximate values for reference. For efficiency maintain indicated airspeed (I. A. S.) hourly. Adjust RPM slightly if necessary to avoid exceeding manifold pressure more than 8 in. Hg.																						
WAR MAX.	3000	67	LOW HIGH	AR	5	194 187																												
MILITARY POWER	3000	61	LOW HIGH	AR	15	178 170																												
NORMAL RATED	2700	46	LOW HIGH	AR	CONT.	109 106																												
I		FUEL	II				III				IV				FUEL	V																		
RANGE IN AIR MILES		U. S. GAL.	RANGE IN AIR MILES				RANGE IN AIR MILES				RANGE IN AIR MILES				U. S. GAL.	RANGE IN AIR MILES																		
STATUTE NAUTICAL			STATUTE NAUTICAL		STATUTE NAUTICAL		STATUTE NAUTICAL		STATUTE NAUTICAL		STATUTE NAUTICAL			STATUTE NAUTICAL		STATUTE NAUTICAL																		
420		184	24		GAL. ALLOWANCE NOT AVAILABLE IN FLIGHT		24		24		24		184	800		740																		
370		160	430		580		500		680		590		160	700		610																		
310		120	370		430		380		510		440		120	600		520																		
260		100	310		360		310		420		370		100	500		440																		
210		80	250		290		250		340		290		80	400		350																		
150		60	180		210		190		250		220		60	300		270																		
100		40	120		140		120		170		140		40	200		180																		
50		20	60		70		60		80		70		20	100		90																		
MAXIMUM CONTINUOUS							OPERATING DATA							OPERATING DATA							OPERATING DATA							MAXIMUM RANGE						
R. P. M.	I. A. S. M.P.H.	MIX-TURE	M. P. In. Hg.	G. P. H.	T. A. S.	ALT. Feet	R. P. M.	I. A. S. M.P.H.	MIX-TURE	M. P. In. Hg.	G. P. H.	T. A. S.	R. P. M.	I. A. S. M.P.H.	MIX-TURE	M. P. In. Hg.	G. P. H.	T. A. S.	R. P. M.	I. A. S. M.P.H.	MIX-TURE	M. P. In. Hg.	G. P. H.	T. A. S.	R. P. M.	I. A. S. M.P.H.	MIX-TURE	M. P. In. Hg.	G. P. H.	T. A. S.				
						40000 35000 30000																												
2700	260	AR	46	115	385	25000							2450	245	AR	41	90	365	2400	235	AR	37	73	345	25000	2150	200	AL	FT	54	300			
2700	270	AR	FT	100	365	20000							2550	255	AR	FT	85	385	2400	240	AL	FT	68	325	20000	2100	205	AL	FT	50	280			
2700	280	AR	46	113	355	15000	2500	265	AR	FT	97	335	2400	255	AR	38	79	320	2250	240	AL	36	64	305	15000	1850	205	AL	FT	47	260			
2700	280	AR	46	108	330	10000	2500	265	AR	42	89	310	2400	255	AR	38	73	295	2300	245	AL	36	60	285	10000	1700	210	AL	FT	44	245			
2700	280	AR	46	103	305	5000	2500	270	AR	42	83	290	2400	255	AR	39	68	275	2350	245	AL	36	56	265	5000	1600	210	AL	35	42	230			
2700	280	AR	46	98	285	S. L.	2550	270	AR	43	78	270	2400	255	AR	39	63	255	2350	245	AL	36	52	245	S. L.	1600	210	AL	34	39	210			
NOTES							EXAMPLE							LEGEND																				
Ⓢ ALLOW 24 GAL. FOR WARM-UP, TAKE-OFF & INITIAL CLIMB PLUS ALLOWANCE FOR WIND, RESERVE & COMBAT AS REQ'D.							AT 9800 LB. GROSS WT. WITH 160 GAL. OF FUEL (AFTER DEDUCTING TOTAL ALLOWANCES OF 24 GAL.) TO FLY 600 STAT. AIRMILES AT 10,000 FT. ALT. MAINTAIN 2300 RPM AND 245 MPH IND. AIRSPEED WITH MIXTURE SET AUTO LEAN							I. A. S.: INDICATED AIRSPEED M. P.: MANIFOLD PRESSURE G. P. H.: U. S. GAL. PER HOUR T. A. S.: TRUE AIRSPEED S. L.: SEA LEVEL F. T.: FULL THROTTLE F. R.: FULL RICH A. R.: AUTO-RICH A. L.: AUTO-LEAN C. L.: CRUISING LEAN																				
HIGH BLOWER ABOVE HEAVY LINE ONLY.							RED FIGURES ARE PRELIMINARY. SUBJECT TO REVISION AFTER FLIGHT CHECK																											

Figure 48—Flight Operation Instruction Chart—V-1650-7 Engine
(Two 500-lb. Wing Bombs—10,000 to 8500 lbs.)

RESTRICTED

MODEL(S) P-51D		FLIGHT OPERATION INSTRUCTION CHART						EXTERNAL LOAD ITEMS 2 - 75-GALLON COMBAT TANKS																							
ENGINE(S): V-1650-7							CHART WEIGHT LIMITS: 10,700 TO 9600 POUNDS																								
LIMITS R. P. M. M. P. (IN. HG.) BLOWER POSITION MIXTURE POSITION TIME LIMIT TOTAL G. P. H. WAR MAX 3000 67 LOW HIGH AR 5 194 187 MILITARY POWER 3000 61 LOW HIGH AR 15 178 170 NORMAL RATED 2700 46 LOW HIGH AR CONT. 109 106							INSTRUCTIONS FOR USING CHART: Select figure in FUEL column equal to or less than amount of fuel to be used for cruising. Move horizontally to left or right and select RANGE value equal to or greater than the statute or nautical air miles to be flown. Vertically below and opposite desired cruising altitude (ALT.) read optimum R. P. M., I. A. S. and MIXTURE setting required.						NOTES: Column I is for emergency high speed cruising only. Columns II, III, IV and V give progressive increase in range at a sacrifice in speed. Manifold pressure (M. P.), gallons per hour (G. P. H.) and true airspeed (T. A. S.) are approximate values for reference. For efficiency maintain indicated airspeed (I. A. S.) hourly. Adjust RPM slightly if necessary to avoid exceeding manifold pressure more than 3 in. Hg.																		
I		FUEL		II		III		IV		FUEL		V																			
RANGE IN AIR MILES		U. S. GAL.		RANGE IN AIR MILES		RANGE IN AIR MILES		RANGE IN AIR MILES		U. S. GAL.		RANGE IN AIR MILES																			
STATUTE	NAUTICAL	U. S. GAL.	STATUTE	NAUTICAL	STATUTE	NAUTICAL	STATUTE	NAUTICAL	STATUTE	NAUTICAL	U. S. GAL.	STATUTE	NAUTICAL																		
I 29 GAL. ALLOWANCE NOT AVAILABLE IN FLIGHT																															
1000	870	419 390	1210	1050	1410	1230	1610	1400	419 390			1820	1580																		
920	800	360	1120	970	1310	1130	1490	1290	360			1680	1460																		
850	730	330	1020	890	1200	1040	1360	1180	330			1540	1330																		
770	670	300	930	800	1090	940	1240	1070	300			1400	1210																		
690	600	270	830	720	980	850	1110	980	270			1280	1090																		
610	530	240	740	640	870	750	990	880	240			1120	970																		
MAXIMUM CONTINUOUS							OPERATING DATA						OPERATING DATA						OPERATING DATA						MAXIMUM RANGE						
R. P. M.	I. A. S. M.P.H.	MIX-TURE	M. P. In. Hg.	G. P. H.	T. A. S.	ALT. Feet	R. P. M.	I. A. S. M.P.H.	MIX-TURE	M. P. In. Hg.	G. P. H.	T. A. S.	R. P. M.	I. A. S. M.P.H.	MIX-TURE	M. P. In. Hg.	G. P. H.	T. A. S.	R. P. M.	I. A. S. M.P.H.	MIX-TURE	M. P. In. Hg.	G. P. H.	T. A. S.	R. P. M.	I. A. S. M.P.H.	MIX-TURE	M. P. In. Hg.	G. P. H.	T. A. S.	
						40000																									
						35000																									
2700	245	AR	FT	105	390	30000							2600	235	AR	FT	93	375	2500	225	AR	FT	78	360	30000	2400	195	AL	FT	61	315
2700	255	AR	46	115	375	25000							2400	235	AR	FT	87	350	2400	230	AR	37	74	340	25000	2200	200	AL	FT	57	295
2700	260	AR	FT	100	355	20000							2550	250	AR	FT	84	340	2400	230	AL	FT	69	315	20000	2150	200	AL	FT	54	275
2700	275	AR	46	113	345	15000	2500	260	AR	FT	96	330	2400	250	AR	39	78	315	2250	240	AL	36	65	300	15000	2000	210	AL	FT	52	265
2700	275	AR	46	108	320	10000	2500	260	AR	42	89	305	2400	250	AR	38	72	290	2300	240	AL	36	61	280	10000	1750	210	AL	FT	48	245
2700	275	AR	46	103	300	5000	2500	265	AR	42	83	285	2400	250	AR	38	67	270	2300	240	AL	36	57	260	5000	1600	205	AL	36	44	225
2700	275	AR	46	98	280	S. L.	2550	265	AR	43	75	265	2400	250	AR	38	62	250	2300	240	AL	36	52	240	S. L.	1600	200	AL	34	39	200

Figure 49—Flight Operation Instruction Chart—V-1650-7 Engine (Combat Tanks—10,700 to 9600 lbs.)

RESTRICTED

RESTRICTED
AN 01-60JF-1

FLIGHT OPERATING CHARTS
Appendix II

MODEL(S) P-51D		FLIGHT OPERATION INSTRUCTION CHART										EXTERNAL LOAD ITEMS 2 - 75-GALLON COMBAT TANKS													
ENGINE(S): V-1650-7		CHART WEIGHT LIMITS: 9600 TO 8000 POUNDS																							
LIMITS		R. P. M.	M. P. (IN. HG.)	BLOWER POSITION	MIXTURE POSITION	TIME LIMIT	TOTAL G. P. H.				NOTES: Column I is for emergency high speed cruising only. Columns II, III, IV and V give progressive increase in range at a sacrifice in speed. Manifold pressure (M. P.), gallons per hour (G. P. H.) and true airspeed (T. A. S.) are approximate values for reference. For efficiency maintain indicated airspeed (I. A. S.) hourly. Adjust RPM slightly if necessary to avoid exceeding manifold pressure more than 3 in. Hg.														
WAR WAZ	3000	67	LOW HIGH	AR	5	195 187																			
MILITARY POWER	3000	61	LOW HIGH	AR	15	178 170																			
NORMAL RATED	2700	46	LOW HIGH	AR	CONT.	109 108																			
INSTRUCTIONS FOR USING CHART: Select figure in FUEL column equal to or less than amount of fuel to be used for cruising. Move horizontally to left or right and select RANGE value equal to or greater than the statute or nautical air miles to be flown. Vertically below and opposite desired cruising altitude (ALT.) read optimum R. P. M., I. A. S. and MIXTURE setting required.																									
I		FUEL		II				III				IV		FUEL		V									
RANGE IN AIR MILES		U. S. GAL.		RANGE IN AIR MILES				RANGE IN AIR MILES				RANGE IN AIR MILES		U. S. GAL.		RANGE IN AIR MILES									
STATUTE NAUTICAL		GAL.		STATUTE NAUTICAL		STATUTE NAUTICAL		STATUTE NAUTICAL		STATUTE NAUTICAL		GAL.		STATUTE NAUTICAL		STATUTE NAUTICAL		STATUTE NAUTICAL							
610 530		269 240 210		29 GAL. ALLOWANCE NOT AVAILABLE IN FLIGHT				900 860 750				1040 910		269 240 210		1180 1030 890									
460 380		180 150		480 400				640 540				780 650		180 150		880 740 640									
310 230		120 90		320 240				430 320				520 390		120 90		590 450 390									
150 70		60 30		160 80				210 100				260 130		60 30		300 150 260 130									
MAXIMUM CONTINUOUS		ALT. Feet		OPERATING DATA				OPERATING DATA				OPERATING DATA		ALT. Feet		MAXIMUM RANGE									
R. P. M.	I. A. S. M.P.H.	MIX. TURE	M. P. In. Hg.	G. P. H.	T. A. S.	R. P. M.	I. A. S. M.P.H.	MIX. TURE	M. P. In. Hg.	G. P. H.	T. A. S.	R. P. M.	I. A. S. M.P.H.	MIX. TURE	M. P. In. Hg.	G. P. H.	T. A. S.	R. P. M.	I. A. S. M.P.H.	MIX. TURE	M. P. In. Hg.	G. P. H.	T. A. S.		
2700	245	AR	FT	105	390	2700	245	AR	FT	94	375	2500	225	AR	FT	75	360	2700	245	AR	FT	105	390		
2700	255	AR	46	115	375	2500	240	AR	41	89	355	2400	225	AR	37	70	335	2500	215	190	AL	FT	57	310	
2700	260	AR	FT	100	355	20000	250	AR	FT	85	340	2350	225	AL	FT	65	310	20000	2050	195	AL	FT	49	265	
2700	275	AR	46	113	345	15000	250	AR	39	79	315	2200	235	AL	FT	62	295	15000	1850	200	AL	FT	46	250	
2700	275	AR	46	108	320	10000	255	AR	43	89	305	2400	250	AR	38	73	290	10000	1650	200	AL	FT	44	235	
2700	275	AR	46	103	300	5000	255	AR	43	83	285	2400	250	AR	38	68	270	5000	1600	200	AL	34	41	220	
2700	275	AR	46	98	280	S. L.	2550	265	AR	43	77	265	2400	250	AR	38	63	250	2150	1600	205	AL	34	38	205

Figure 50—Flight Operation Instruction Chart—V-1650-7 Engine
(Combat Tanks—9600 to 8000 lbs.)

RESTRICTED

- NOTES
- ALLOW 29 GAL. FOR WARM-UP, TAKE-OFF & INITIAL CLIMB PLUS ALLOWANCE FOR WIND, RESERVE & COMBAT AS REQ'D.
 - IF 95-GALLON FUSELAGE TANK IS INSTALLED AND SERVICED, WARM-UP, TAKE-OFF, CLIMB, AND CRUISE ON FUSELAGE TANK UNTIL AT LEAST 90 GALLONS ARE USED BEFORE SWITCHING TO COMBAT TANKS. HIGH BLOWER ABOVE HEAVY LINE ONLY.

EXAMPLE
AT 9500 LB. GROSS WT. WITH 240 GAL. OF FUEL (AFTER DEDUCTING TOTAL ALLOWANCES OF 29 GAL.) TO FLY 950 STAT. AIRMILES AT MAINTAIN 2350 RPM AND 225 MPH IND. AIRSPEED WITH MIXTURE SET AUTO LEAN.

LEGEND
I. A. S.: INDICATED AIRSPEED
M. P.: MANIFOLD PRESSURE
G. P. H.: U. S. GAL. PER HOUR
T. A. S.: TRUE AIRSPEED
S. L.: SEA LEVEL
F. T.: FULL THROTTLE
F. R.: FULL RICH
A. R.: AUTO-RICH
A. L.: AUTO-LEAN
C. L.: CRUISING LEAN
RED FIGURES ARE PRELIMINARY. SUBJECT TO REVISION AFTER FLIGHT CHECK

AIRCRAFT MODEL(S) P-51D AND P-51K		TAKE-OFF, CLIMB & LANDING CHART																		ENGINE MODEL(S) V-1650-3									
TAKE-OFF DISTANCE FEET																													
GROSS WEIGHT LB.	HEAD WIND		HARD SURFACE RUNWAY						SOD-TURF RUNWAY						SOFT SURFACE RUNWAY														
			AT SEA LEVEL		AT 3000 FEET		AT 6000 FEET		AT SEA LEVEL		AT 3000 FEET		AT 6000 FEET		AT SEA LEVEL		AT 3000 FEET		AT 6000 FEET										
	M.P.H.	KTS.	GROUND RUN	TO CLEAR 50' OBJ.	GROUND RUN	TO CLEAR 50' OBJ.	GROUND RUN	TO CLEAR 50' OBJ.	GROUND RUN	TO CLEAR 50' OBJ.	GROUND RUN	TO CLEAR 50' OBJ.	GROUND RUN	TO CLEAR 50' OBJ.	GROUND RUN	TO CLEAR 50' OBJ.	GROUND RUN	TO CLEAR 50' OBJ.	GROUND RUN	TO CLEAR 50' OBJ.									
9000	0	0	1350	2000	1500	2200	1700	2450	1450	2100	1600	2250	1800	2500	1600	2250	1750	2450	2000	2750									
	17	15	1000	1550	1150	1700	1300	1950	1050	1600	1200	1800	1350	2000	1200	1750	1350	1900	1500	2200									
	34	30	750	1150	800	1300	950	1500	750	1200	850	1350	1000	1550	850	1300	950	1400	1100	1650									
11,000	0	0	1850	2700	2000	2950	2250	3300	1950	2800	2100	3050	2400	2900	2250	3150	2400	3400	2800	3800									
	17	15	1350	2150	1500	2300	1750	2650	1450	2200	1600	2400	1850	2700	1700	2450	1900	2700	2150	3100									
	34	30	950	1600	1100	1750	1300	2050	1050	1650	1200	1850	1400	2100	1200	1850	1400	2050	1600	2300									
13,000	0	0	2300	3600	2500	3800	2800	4300	2450	3700	2650	3950	3000	4550	2900	4300	3200	4800	3600	5300									
	17	15	1700	2800	1900	3050	2300	3400	1850	2900	2050	3200	2350	3600	2200	3300	2400	3700	2800	4200									
	34	30	1200	2050	1400	2300	1650	2700	1350	2150	1500	2400	1750	2850	1600	2450	1800	2850	2100	3200									
NOTE: INCREASE CHART DISTANCES AS FOLLOWS: 75°F + 10%; 100°F + 20%; 125°F + 30%; 150°F + 40% DATA AS OF 5-8-45 BASED ON: FLIGHT TESTS OPTIMUM TAKE-OFF WITH 3000 RPM, 6" IN. HG. & 20 DEG. FLAP IS 80% OF CHART VALUES																													
CLIMB DATA																													
GROSS WEIGHT LB.	AT SEA LEVEL			AT 5000 FEET			AT 10,000 FEET			AT 15,000 FEET			AT 20,000 FEET			AT 25,000 FEET													
	BEST I. A. S.		RATE OF CLIMB F.P.M.	BEST I. A. S.		RATE OF CLIMB F.P.M.	BEST I. A. S.		RATE OF CLIMB F.P.M.	BEST I. A. S.		RATE OF CLIMB F.P.M.	BEST I. A. S.		RATE OF CLIMB F.P.M.	BEST I. A. S.		RATE OF CLIMB F.P.M.											
	MPH	KTS		MPH	KTS		MPH	KTS		MPH	KTS		MPH	KTS		MPH	KTS		MPH	KTS									
9000	170	145	2200	15	170	145	2200	2.5	19	170	145	2250	5.0	23	170	145	2250	7.5	27	165	145	1900	10.0	31	160	140	1650	13.0	35
11,000	170	145	1500	15	170	145	1500	3.5	20	170	145	1500	7.0	26	170	145	1500	10.5	32	165	145	1150	14.0	39	160	140	900	19.0	47
13,000	175	150	1000	15	175	150	950	5.5	23	175	150	900	11.0	32	175	150	850	17.0	42	170	145	550	23.0	55	165	145	300	37.0	75
POWER PLANT SETTINGS: (DETAILS ON FIG. SECTION 11): DATA AS OF 5-8-45 BASED ON: FLIGHT TESTS FUEL USED (U.S. GAL.) INCLUDES WARM-UP & TAKE-OFF ALLOWANCE																													
LANDING DISTANCE FEET																													
GROSS WEIGHT LB.	BEST IAS APPROACH				HARD DRY SURFACE						FIRM DRY SOD						WET OR SLIPPERY												
	POWER OFF		POWER ON		AT SEA LEVEL		AT 3000 FEET		AT 6000 FEET		AT SEA LEVEL		AT 3000 FEET		AT 6000 FEET		AT SEA LEVEL		AT 3000 FEET		AT 6000 FEET								
	MPH	KTS	MPH	KTS	GROUND ROLL	TO CLEAR 50' OBJ.	GROUND ROLL	TO CLEAR 50' OBJ.	GROUND ROLL	TO CLEAR 50' OBJ.	GROUND ROLL	TO CLEAR 50' OBJ.	GROUND ROLL	TO CLEAR 50' OBJ.	GROUND ROLL	TO CLEAR 50' OBJ.	GROUND ROLL	TO CLEAR 50' OBJ.	GROUND ROLL	TO CLEAR 50' OBJ.	GROUND ROLL	TO CLEAR 50' OBJ.							
9000	130	115	130	115	1200	2300	1400	2400	1500	2600	1400	2400	1600	2600	1700	2800	3200	4300	3500	4600	3900	5000							
8000	130	115	130	115	1100	2100	1200	2200	1400	2400	1300	2200	1400	2400	1500	2600	2900	3800	3100	4100	3400	4500							
DATA AS OF 5-8-45 BASED ON: FLIGHT TESTS OPTIMUM LANDING IS 80% OF CHART VALUES																													
REMARKS:															LEGEND														
NOTE: TO DETERMINE FUEL CONSUMPTION IN BRITISH IMPERIAL GALLONS, MULTIPLY BY 10. THEN DIVIDE BY 12															I. A. S. : INDICATED AIRSPEED M.P.H. : MILES PER HOUR KTS. : KNOTS F.P.M. : FEET PER MINUTE														
MIXTURE: USE "RUM" OR "AUTO RICH - AUTO LEAN"																													

For use with V-1650-3 engine only regardless of airplane model.

Figure 64—Take-off, Climb and Landing Chart

For use with V-1650-3 engine only regardless of airplane model.

For use with V-1650-3 engine only regardless of airplane model.